



**The Audi A3 Sportback e-tron**

Pricing and Specification Guide

Valid from January 2016



# The Audi A3 Sportback e-tron

This guide has been designed to help you tailor and price your Audi A3 Sportback e-tron quickly and logically. At the back, you will find information on CO2 emissions-based taxation and services offered with your Audi, including Finance and Insurance. You can also configure your Audi A3 Sportback e-tron online at [audi.co.uk](http://audi.co.uk)



**Get more from this brochure with the free Audi Vision app.**

Audi Vision brings our brochures to life through Augmented Reality. It works by recognising images on a page through your device's camera. Suitable for compatible phones or tablets, download it for free from the App Store or Google Play. Once downloaded, simply open the app and scan the cover of your guide. Then look out for any page with the Audi Vision logo, you can then hold your device over the page and watch as you get exclusive access to extra images, information and video content.



The images featured in this guide are for illustrative purposes only. They may feature left-hand drive vehicles and include equipment that is not UK specification.

## The Audi A3 Sportback e-tron

A3 Sportback e-tron	6
Charging	8
Electric power	12
e-tron connect app	18
Technology	20
Audi Connect	22

### Model details and prices

A3 Sportback e-tron model equipment	24
Model pricing	28

### Colour and upholstery

Paint	30
Upholstery and seats	34
Colour and trim guide	38

<b>Inlays</b>	40
---------------	----

### Options

Wheels, tyres and suspension	44
Audio and communication	48
Interior equipment	50
Exterior equipment	52
Safety and security	54

### Looking after your Audi

Audi Complete and Warranty	56
Accessories	60
Merchandise	61
Audi Difference	62

### Technical details

Technical data	64
Dimensions	65
Pricing and Additional information	66





## Vorsprung durch Technik

Three words that express the very essence of Audi – Vorsprung durch Technik. It's not just a slogan, it's our way of seeing the world and the driving force behind our history of innovation that continues into the 21st century. Indeed, many technologies that have become synonymous with Audi remain in our cars today. Some are milestones in the history of the motorcar. From our beginnings in 1899, to the Auto Union team's Grand Prix successes in the 1930s and our more recent wins at Le Mans, we have always been at the forefront of the motor industry.

Vorsprung durch Technik makes us who we are. To see more of its influence, just read on.

# e-tron

## Plug in to the Audi A3 Sportback e-tron

The looks of an A3 Sportback combined with the benefits of an electric motor. The Audi A3 Sportback e-tron.

The e-tron is a plug-in hybrid that offers the option of economic everyday driving with the flexibility offered by its petrol engine to undertake longer journeys. In auto mode, the car switches intelligently between the electric motor and petrol engine, so that you use electric energy wherever possible.

In test environments, it delivers a combined fuel consumption figure of 176.6mpg.\*

The A3 Sportback e-tron can even operate as a fully electric car on shorter journeys, thanks to its high-storage lithium-ion battery. And with an 8-year/100,000-mile battery warranty as standard,\*\* you can be confident it will continue to perform as you'd expect.



\*Value from standard EU test figures for comparative purposes and may not reflect real driving results. Optional wheels may also affect emissions and fuel consumption figures. \*\*Exclusions and restrictions apply. See page 67 for further information.



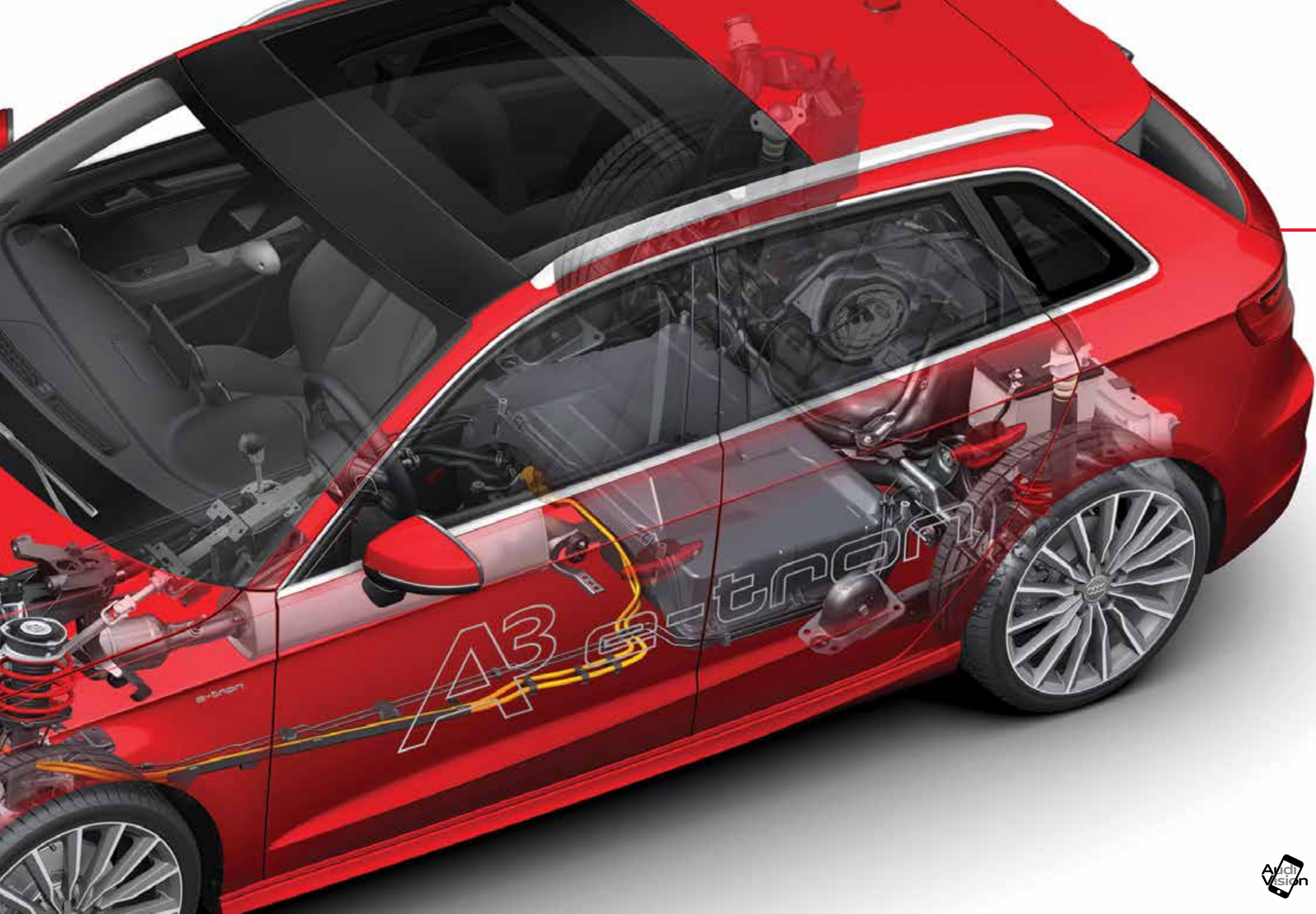





# Charged.

## when you need it

Charging the A3 Sportback e-tron is simple. You just need to slide the Audi rings on the front grille to one side and plug in your charging cable, either at home or at one of a growing number of public charging points around the country.

It's possible to charge the car using a domestic socket, which takes around 4 hours. However, it's quicker if you have a specialised wall box

installed in your home or use a public charging point; after around 2 hours 15 minutes of charging, you'll be ready to set off again.

Your A3 Sportback e-tron will be supplied with the necessary cables for all three types of charging, which are easily stored in the supplied bag, so however you want to charge your car, you'll always have the right equipment available.







# Electric

## power meets performance

With the combination of a 1.4 TFSI engine, an electric motor and the smooth-shifting S tronic transmission, the A3 Sportback e-tron can accelerate from 0-62mph in 7.6 seconds. The combination of electric motor and petrol engine could offer a range of up to 580 miles\* – so you can make some longer trips without needing to stop and recharge.

In everyday driving, with a push of the EV button, you can change how e-tron works. Switching to hybrid mode combines the petrol and electric motors, or you can choose to use just the petrol engine – to conserve battery power for city driving, for example. Or, if you wish, you can select the all-electric mode. It pulls away silently and has a potential range of up to 31 miles\* on a single charge.



\*Range is illustrative figure only, calculated on the basis of standard EU test figures (which are for comparative purposes). May not reflect real driving results.









## Inside the Audi A3 Sportback e-tron

Within the A3 Sportback e-tron's spacious interior, you'll find all the luxury you'd expect - from inlays in micrometallic silver to a leather-trimmed multi-function Sport steering wheel. And there's a range of optional materials and finishes to choose from, so you can create a car that suits you perfectly.

A Colour Driver's Information System comes as standard, so you're kept up to date on your A3 Sportback e-tron's range, performance and economy. And Audi Drive Select lets you control characteristics like steering, damping and suspension. So as well as monitoring how efficient the car is on the road, you can change the way it feels to drive.













## Connect to your e-tron, wherever you are

With the Audi A3 Sportback e-tron, we haven't just redefined the way your car works – we've adapted the way you can control it. By downloading the e-tron connect app\*, you'll have immediate access to important information about your vehicle.

So no matter where you are, you'll be able to keep an eye on the current charge level, remaining electric range and even the location of your car. There's also an option to look at your last journey, which gives you key details including average fuel consumption.

Perhaps most useful of all, the Audi e-tron app enables you to use your smartphone as

a remote control. It means, whether you're at home or in the office, you can start your car charging with the push of a button – or set a timer to do it automatically.

If it's plugged in, you can even choose to activate the climate control remotely a few minutes before you start your journey using power from the mains. So you know the cabin will be at your ideal temperature when you get behind the wheel and you can draw on the battery's full power on the road. Before you can use the Audi Connect e-tron services, you first need to register on the myAudi portal and your mobile device must be compatible.\*



\*Compatible with iOS6 and Android 2.3.3 or higher. For further information please see page 73 or visit the myAudi portal – [my.audi.com](http://my.audi.com)

# Technology

## that adapts to the road

Our LED headlights don't just light your way, their turning lights provide a better view on the curves of the road ahead. They provide near-daylight illumination, casting a more natural light to put less strain on your eyes than conventional headlights. They also work with the standard MMI Navigation system, using the navigation route data to control the light distribution with motorway light and country light modes.

There are more bright ideas, too. Like our Advanced Key, which unlocks the doors for

you automatically as long as you have the key on you. Once inside, you just need to press the Start/Stop button to start the engine.

The MMI Navigation comes with MMI Touch, enabling you to operate the navigation system simply by 'writing' on the touchpad with your finger. Our most advanced system on the A3, it's specially adapted to the A3 Sportback e-tron – providing information about how far you can travel using electric power, as well as navigating you to your nearest electric charging point.





e-tron



# Audi Connect

## Stay networked on the move

Being inside your car shouldn't mean losing touch with the outside world. That's why, with Audi Connect, the new Audi A3 Sportback e-tron creates a link between you and the internet.\*



### Wi-Fi hotspot

Connects your mobile devices to the internet



### Email

Your emails can be transmitted to your Audi MMI and read out conveniently†



### Text messages

Messages are displayed or read out to you; you can also reply using the dictation function†



### Twitter

Enables you to tweet and receive updates on the move, with text-to-speech and other convenient text functions



### Weather information

Gives you forecasts and maps for your chosen destination



### Map updates

The map version can be updated a total of five times at intervals of six months



### News online (individual)

Text and images from your favourite news sources with text-to-speech function



### City events

Up-to-date information about events happening at your destination



### Points-of-interest

Search Google™ using voice control



### Traffic information online

Complements the dynamic route guidance with real-time traffic flow information for individual stretches of road



### myAudi – special destinations

Import individual point-of-interest (POI) lists to your Satellite Navigation System via the myAudi portal



### Train information

Find departure and arrival times and platform information while you're on the road (also available for other types of public transport such as underground systems)



### Picturebook navigation

Uses GPS data from your photos to get you to your destination



### Country-specific information

The legal regulations for a specific country, such as speed limits or whether it is compulsory to carry a high-visibility vest or display a motorway toll sticker, are displayed when crossing a border



### Fuel prices

Information on filling stations with the cheapest prices in your selected search area



### Parking information

Helps you find car parks nearby and, where available, information on prices and currently vacant spaces



### Flight information

Get information about departure and arrival times as well as the corresponding gates and search directly for flight numbers



### Audi music stream

Access to global radio stations via smartphone app and Wi-Fi, plus access to smartphone's media library



### Navigate with Google Earth™ and Google Street View™

Uses high-resolution aerial and satellite images as well as photos to guide you to your destination with ease



find the cheapest fuel prices. And, with a wireless hotspot within the car, passengers can connect their mobile devices – to browse the internet, download emails, or access social media.

\*Please note that an external data source is required to enable Audi Connect online services. Terms and conditions apply to certain Audi Connect functions. Please see page 67 for additional information. †Only available if your mobile phone has the Bluetooth profile MAP (Message Access Profile).

# A3 Sportback e-tron model equipment

All new A3 Sportback e-tron models have the following items of standard equipment

## Engine and transmission

**Brake Recuperation** – recovers braking energy and converts it into usable electrical energy. The energy captured is stored in the lithium-ion battery and used for operating the electric motor, for the air conditioning and for the vehicle power supply

**Charging Cables** – stored in a soft carry bag

- Domestic charging cable
- Public charging cable

**EV button** – located in the centre console, allows selection of 4 driving modes:

- EV – purely electric driving
- Hybrid auto mode – which will utilise both battery and combustion engine
- Hybrid hold mode – will reserve battery charge
- Hybrid charge mode – utilises combustion engine to charge the battery

## Wheels, tyres and suspension

17" x 7.5J '15-spoke Turbine' design e-tron alloy wheels with 225/45 R17 tyres

**Anti-theft wheel bolts**

**Audi Drive Select** – changes vehicle characteristics by adapting power steering assistance, accelerator and gear-shift characteristics in 4 modes: auto, comfort, dynamic and individual

## Dynamic suspension

**Electromechanical parking brake**

**Electromechanical power steering**

**Tyre Repair Kit**

## Audio and communication

**7" high resolution colour display screen** – electrically extending, slimline design, with 800 x 480 pixel resolution

**8 passive speakers** with a total output of 80 Watts

**MMI Navigation plus (HDD based) with MMI Touch** highlights include:

- 3D navigation map
- Voice control using whole words
- Dynamic route guidance
- Flash memory for music (10GB)
- MMI Touch – a touch sensitive panel on the rotary/push button control for intuitive operation of the MMI without taking your eyes off the road
- e-tron content including charging stations as a point of interest
- In-car programming of charging timer
- Will showcase on a map how far you can drive based on your current electrical range

**Audi Connect** – provides access to a number of innovative online services via an internal UMTS (4G) module. Audi Connect online services highlights include:

- Navigation using Google Earth™ images and Google Street View™
- Information services such as weather forecasts and the latest world news
- Audi Connect can also create a Wi-Fi hotspot in the car or enable convenient internet access using a mobile device (e.g. laptop or tablet) system

Online services require either a mobile telephone with Bluetooth SIM access profile or a separate SIM card which include data options. For more information, see page 22-23 and 67

**Audi e-tron connected services** – connect to your e-tron via a web portal or smartphone app. Allows you to check charging status, remaining electrical range and set charging timers. For more information see page 18-19

**Audi Music Interface (AMI)** – provides connection to Apple iPod from 4th generation and Apple iPhone, as well as USB storage media and MP3 players. Located in the centre console and operated using the MMI control panel, multi-function steering wheel or voice control

**Bluetooth interface** – for hands-free mobile phone connectivity (dependant on compatibility and software version of mobile phone, please visit [audi.co.uk/phonecompatibility](http://audi.co.uk/phonecompatibility))

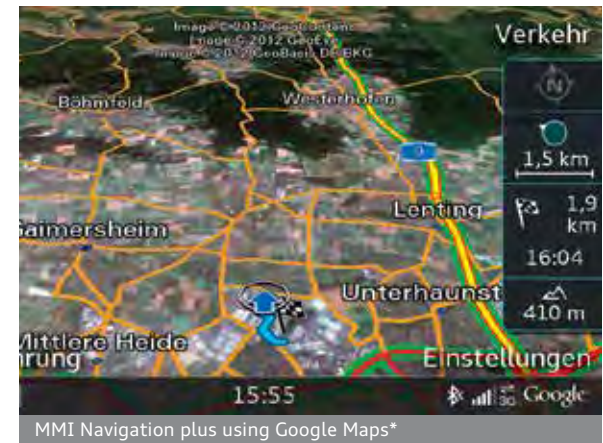



**Colour Driver's Information System (DIS)** – 3.5" high-resolution colour display in the dashboard binnacle

#### DAB digital radio reception

**MMI radio** which includes:

- Single CD player and two SDXC memory card readers (up to 2TB) which are both MP3, WMA and AAC compatible
- FM and AM (MW) reception
- TP memo, which automatically saves traffic news when driving

**Voice control system** – for key telephone and radio functions

#### Seats

**ISOFIX child seat mounting** for front passenger (with airbag deactivation) and outer rear seats. Includes Top Tether attachment point for the outer rear seats

#### Front Sport seats

**Rallye cloth upholstery** – seat centre sections in Rallye cloth design. The seat side bolsters, head restraints as well as door and rear side panel inserts are in single-colour cloth

**Split-folding rear seats** – 60/40 or all

#### Interior

**3-spoke leather-trimmed Sport multi-function steering wheel**

**Air vents in aluminium look**

**Aluminium door sill trims with e-tron logo**

**Aluminium interior elements** – on the vents, glove compartment, mirror adjustment switches, window control switches, frame around the inside door handle, coin box, control buttons for the parking brake and the hold assist button (if fitted)

**Cloth headlining**

**Coat hooks** on the B-pillar on the left and right side

**Cup holders** – 2 in the front located in the centre console in front of the gear knob

**Dual-zone electronic climate control with sunlight-dependent control**, separate pre-selectable control for driver and front passenger. Electronically regulates the air temperature, air flow rate and air distribution. Automatic recirculation mode by means of air quality sensor, combined filter, rear vents and humidity regulation for more efficient climate control

**Electric front and rear windows**

**Front and rear floor mats** – in velour to match interior colour

**Front centre armrest** with angle and lengthways adjustment

**Inlays** in Aluminium mistral silver

**Interior lighting** – front and rear with delayed switch-off and contact switches on all doors. Also includes glove box and luggage compartment light and illuminated vanity mirrors

**Lashing points** – 4 in luggage compartment, to prevent movement of luggage and other objects, with attachment points for the optional luggage securing net

**Smoking package** with cigarette lighter, 12V socket in the centre console and an ashtray with the Audi rings

**Storage compartments** in the door side trims, in the centre console and under the driver's seat

#### Exterior equipment

**Audi parking system, rear.** Makes reverse parking easier by indicating acoustically how far away the vehicle is from an object detected behind it

**Door mirrors** – electrically adjustable and heated

**All-weather LED headlights** – LEDs for all front lighting functions. LED technology provides lower energy consumption and enhanced contrast compared to conventional headlights, with a colour similar to daylight for increased safety and good recognition by other road users. Includes all-weather light function to reduce the risk of the driver being dazzled when visibility is poor (in fog, rain or snow)

**High-beam assist** – working within system limits, automatically detects the headlights of oncoming traffic, the rear lights of other road users and built-up areas and depending on the traffic situation, the high beam is automatically switched on or off

#### LED Rear lights

**Light and Rain sensors** – automatically switches the dipped beam headlights and windscreen wipers on/off depending on the light and rain conditions. Also includes a windscreen with sunband

#### Model and e-tron badges at the rear

**Vehicle charging socket** – located behind Audi rings on bonnet



MMI Touch (part of MMI navigation plus)



Colour Driver's Information System (DIS)



Aluminium door sill trims with e-tron logo

# A3 Sportback e-tron model equipment

continued

## Safety and Security

**Advanced Key** – access and authorisation system which automatically exchanges data between key and vehicle, allowing the driver to keep the key in their pocket or bag at all times. To unlock and open, simply lift the exterior door handle. To lock, press the button on the handle. Also includes an ignition start/stop button integrated in the centre console

**Audi Pre-sense front\*** – Enhanced brake assist warns of any imminent threat of collision with the vehicle in front. Can initiate partial braking action or boost the driver's braking action if necessary. In addition, full braking action is initiated at speeds below 18mph if there is danger of collision with a stationary or moving vehicle in order to reduce the speed of the collision or to avoid the collision if possible

**Audi active lane assist\*** – Lane markings are registered by an optical sensor in the windscreen above speeds of approximately 40mph. The lane departure warning system warns the driver if a detected lane marking is approached without indicating, and helps the driver to steer back towards the middle of the lane by making gentle steering movements. System is activated manually by a switch on the indicator lever

**Airbags** – driver, front passenger and front side airbags with head-level airbag system for front and rear, and knee airbag for the driver. Includes a front passenger airbag deactivation switch

**Electronic Differential Lock (EDL)**. On surfaces with varying levels of grip, this start-off assistant automatically brakes the driven wheels on any surface that is too slippery, thereby ensuring smooth, powerful progress

**Electronic stabilisation control (ESC)**

**First-aid kit**

**Manual child locks** on rear doors

**Seat belt reminder** for all seats

**Secondary collision brake assist** – in the event of an accident, this function automatically brakes the car to prevent secondary collisions

**Thatcham Category 1 alarm and immobiliser**, with tow-away protection and interior monitoring (both of which can be switched off)

**Tool kit and car jack**

**Tyre Pressure loss indicator** – visual and acoustic warning if the pressure drops in one or more tyres

**Warning triangle**

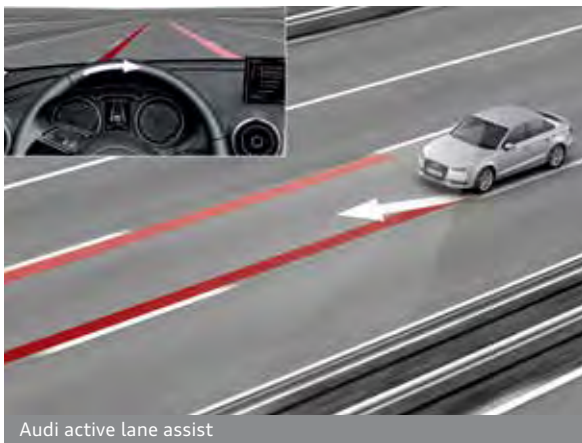

Audi active lane assist



LED headlight



Vehicle charging socket



Image shows the A3 Sportback e-tron model with optional Misano red, pearl effect paint (N9) and Aluminium roof rails (3S1)

## A3 Sportback e-tron

Engines	Power	Transmissions	CO <sub>2</sub> g/km**	Total RRP inc VAT <sup>^</sup>	Recommended OTR excl PICG <sup>+</sup>
1.4 TFSI e-tron	150PS	6-speed S tronic	37	£35,005.00	£35,690.00*

\*The A3 Sportback e-tron is a hybrid vehicle (PHEV) which makes it eligible for the Government 'PICG' (Plug-in Car Grant) towards the cost of the car. The amount of your grant will be automatically deducted from the price of your A3 Sportback e-tron when the vehicle is registered. The PICG will be applied to the recommended On-The-Road retail price. The receipt of this grant is subject to the eligibility of the vehicle at the point of registration and is subject to change. Please refer to the gov.uk OLEV Grant website for more details. Your Audi Centre will complete the paperwork, but you may be asked to complete a customer survey. For more information, please contact your Audi Centre or visit [gov.uk/plug-in-car-van-grants/overview](http://gov.uk/plug-in-car-van-grants/overview)

\*\*Please note: CO<sub>2</sub> emissions can change if a different size alloy is ordered onto the vehicle. This may also lead to a change to the VED amount payable. Please refer to pages 46-47, 64 and 67 for more details. Values based on standard EU test figures for comparative purposes and may not reflect real driving results.

Please note: The maximum power output figures are quoted in PS (or Pferdestärke, which is the metric equivalent of brake horsepower). To convert to brake horsepower, divide the PS figure by 1.0139.

<sup>^</sup>Total RRP inc VAT – Recommended Retail Price including VAT which is calculated at 20%. This may alter to reflect any change in the applicable VAT rate.

<sup>+</sup>Recommended On-The-Road (OTR) retail prices include: delivery charge, half a tank of fuel, number plates at £630.00 (inc. VAT), Road Fund Licence (which may vary depending on model/transmission – see page 67 for details) and first registration fee at £55.00. Vehicle Excise Duty correct at time of going to print, but this may alter to reflect any change in the applicable VED rate.





# Paint

We believe that every part of your car should have a personal touch. Which is why you can choose from a wide range of paint colours and finishes, from standard shades to metallic and pearl effects. We can even mix a customised colour for you to create the perfect fit.



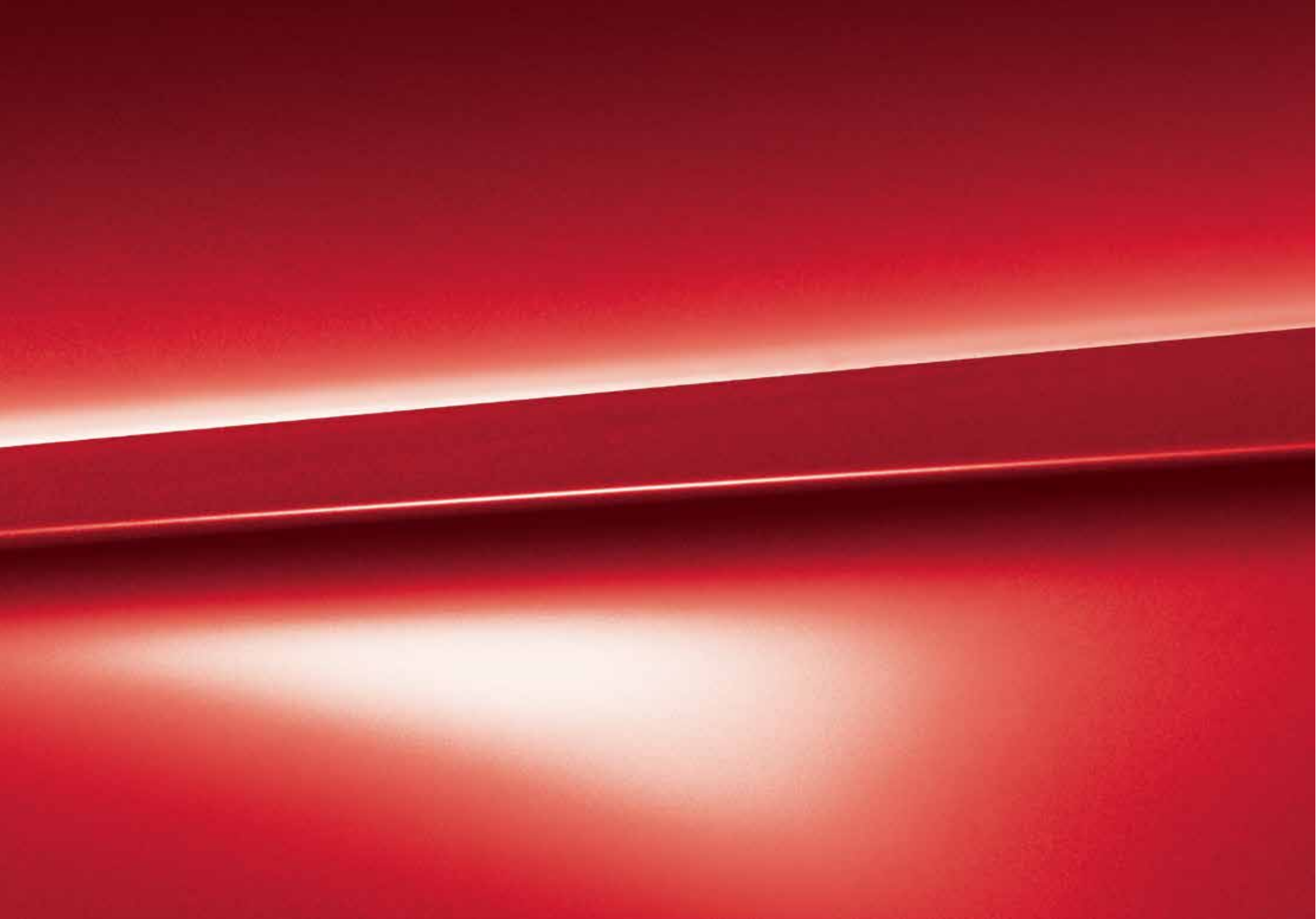

# Paint

You can select one of the standard colours shown opposite or, for a different look, choose from the range of metallic or pearl-effect finishes.

## Standard colours



Ibis white - T9

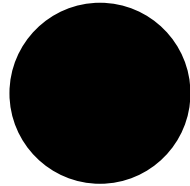

Brilliant black - A2

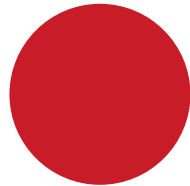

Brilliant red - C8

## Optional colours

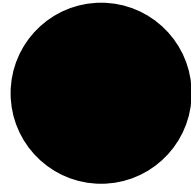

Mythos black, metallic - 0E

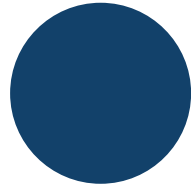

Scuba blue, metallic - S9



Glacier white, metallic - 2Y

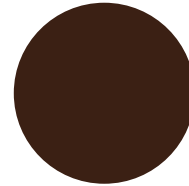

Beluga brown, metallic - M5

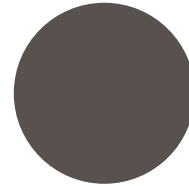

Dakota grey, metallic - Y7

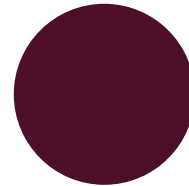

Shiraz red, metallic - 3A

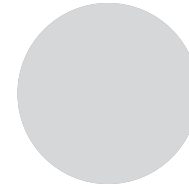

Floret silver, metallic - L5

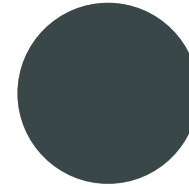

Monsoon grey, metallic - 0C

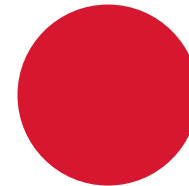

Misano red, pearl effect - N9

Options are subject to availability and may extend time taken for delivery.

All the colour swatches on this page are matched as accurately as possible to the actual paint colours used. However, due to print processes, Audi UK cannot guarantee that colours shown are 100% accurate.

Visit your local Audi Centre for a more accurate colour swatch.

\*Total RRP inc VAT - Recommended Retail Price including VAT which is calculated at 20%. This may alter to reflect any change in the applicable VAT rate.

### Optional colours

**Total RRP inc VAT\***  
£550.00



# Paint

## Audi exclusive

Everyone has a favourite colour. No matter what yours is, Audi exclusive provides a range of unique colours that have been designed to set your car apart. Choose from the swatches here, or specify any other paint colour in the Audi range.\*

## Customised

If you have a particular colour in mind, we'll mix the exact metallic or pearl-effect shade you want.\*\*

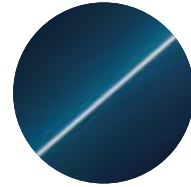

Palace blue, pearl effect

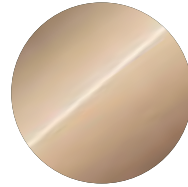

Sand beige, pearl effect

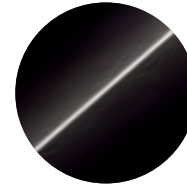

Saddle brown, pearl effect

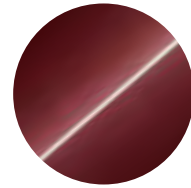

Classic red, pearl effect

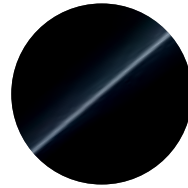

Mamba black, metallic

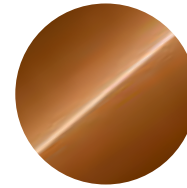

Ipanema brown, metallic



Any colour in the Audi range or 100 exclusive colours to choose from\*

### Audi exclusive\*

Total RRP inc VAT+  
£2,025.00



Customised paint\*\*

### Customised\*\*

Total RRP inc VAT+  
£2,525.00

Options are subject to availability and may extend time taken for delivery.

\*Audi exclusive paint is subject to factory approval. Visit your local Audi Centre for colour samples.

\*\*Customised paint is subject to factory approval, and is available for metallic and pearl-effect water-based paints only. Three-colour process colours and two-tone schemes are not available.

All the colour swatches on this page are matched as accurately as possible to the actual paint colours used. However, due to print processes, Audi UK cannot guarantee that colours shown are 100% accurate.

Visit your local Audi Centre for a more accurate colour swatch.

+Total RRP inc VAT – Recommended Retail Price including VAT which is calculated at 20%. This may alter to reflect any change in the applicable VAT rate.

## Upholstery

It's important to feel comfortable on the road. Just choose from our range of luxury upholstery materials and textures, including additional support and colour options, for complete relaxation while you drive.





# Upholstery

## A3 Sportback e-tron









Choose your favourite upholstery from the swatches shown opposite to give your car's interior the look and feel you want.

Options are subject to availability and may extend time taken for delivery.

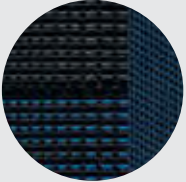
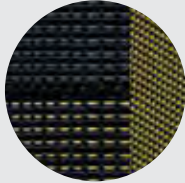
All colour swatches on this page are matched as accurately as possible to the actual upholstery colours used. However, due to print processes, Audi UK cannot guarantee that the colours shown are 100% accurate.

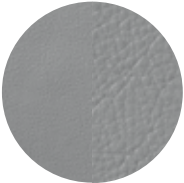
- = Not available  
• = Available  
S = Standard

\*Total RRP inc VAT - Recommended Retail Price including VAT which is calculated at 20%. This may alter to reflect any change in the applicable VAT rate.

		e-tron	Total RRP inc VAT*	
Rallye cloth	 Black - FZ	<p><b>Sport seats in Rallye cloth.</b> Seat centre panel in Rallye cloth, colour-coordinated cloth in shoulder area and seat side bolsters, head restraints, door/side panel trim inserts and front centre armrest in single-colour cloth</p>	S	£0.00
	 Black/silver - KY			
	 Black/blue - LQ			
	 Black/yellow - RR			
Alcantara/leather	 Black - FZ	<p><b>Sport seats in Alcantara/leather.</b> Seat centre panel and door/side panel trim inserts in Alcantara; seat side bolsters and head restraint centre panel in leather and the front centre armrest in synthetic leather. Only in combination with Storage and luggage package (QE1)</p>	•	£795.00
	 Titanium grey - VL			
Milano leather	 Black - FZ	<p><b>Sport seats in Milano leather.</b> Seat centre panel, seat side bolsters and head restraint centre panel in Milano leather, shoulder area in velvet leather and front centre armrest and door/side panel trim inserts in synthetic leather. Only in combination with Storage and luggage package (QE1)</p>	•	£1,115.00
 Titanium grey - VL				
 Chestnut brown - VR				

# Upholstery

## A3 Sportback e-tron

Options are subject to availability  
and may extend time taken for delivery.

- = Not available  
• = Available  
S = Standard

\*Image shown also includes optional  
electric lumbar support and under-seat  
storage which is part of the storage  
package, both of which are available  
at additional cost.



Sport seat\* in Rallye cloth with black/silver upholstery

# Colour and trim guide

## Interior trim colours

### A3 Sportback e-tron

To help you choose the right interior for your new Audi A3 Sportback e-tron, please use this guide, showing the carpet, dashboard and headlining colours that have been matched to your chosen upholstery.

Order Code	Upholstery	Carpet	Dashboard (upper/lower)	Headlining	Rallye cloth (N5B)	Alcantara/leather (N7U)	Milano leather (N5W)
FZ	Black	Black	Black/Black	Lunar silver	●	●	●
KY	Black/Silver	Black	Black/Black	Lunar silver	●	—	—
LQ	Black/Blue	Black	Black/Black	Lunar silver	●	—	—
RR	Black/Yellow	Black	Black/Black	Lunar silver	●	—	—
VL	Titanium grey	Black	Black/Titanium grey	Lunar silver	—	●	●
VR	Chestnut brown	Black	Black/Black	Lunar silver	—	—	●

Options are subject to availability and may extend time taken for delivery.

— = Not available  
 ● = Available  
 S = Standard

# Seats

Choose from a variety of different seat options so you can maintain the correct driving posture at all times.

Order Code		e-tron	Total RRP inc VAT*
<b>7P1</b>	<b>Electric lumbar support.</b> For front seats with horizontal and vertical adjustment	●	£195.00
<b>4A3</b>	<b>Heated front seats.</b> Individually-controlled variable temperature adjustment for driver and front passenger seats	●	£295.00
<b>3L5</b>	<b>Electric front seats.</b> Includes adjustment for height, forwards and backwards position and backrest angle. Only in combination with electric lumbar support (7P1)	●	£550.00

Options are subject to availability and may extend time taken for delivery.

- = Not available
- = Available
- S = Standard

\*Total RRP inc VAT – Recommended Retail Price including VAT which is calculated at 20%. This may alter to reflect any change in the applicable VAT rate.

## Inlays

Attention to detail can make a big impact. From contemporary Aluminium mistral silver to 3D design 'optic', our selection of inlays offers the perfect finishing touch to your car's interior.







# Inlays

Inlays are the all-important finishing touch that add flair and interest to your car's interior.

Order Code		e-tron	Total RRP inc VAT*
<b>5TD</b>	<b>Aluminium mistral silver</b>	S	£0.00
<b>7TM</b>	<b>3D design 'optic'</b>	●	£150.00

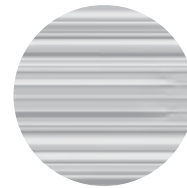

Aluminium mistral silver - **5TD**

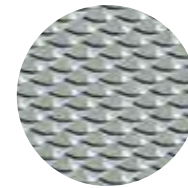

3D design 'optic' - **7TM**

Options are subject to availability and may extend time taken for delivery.

All the inlay swatches on this page are matched as accurately as possible to the actual inlay colours used. However, due to print processes, Audi UK cannot guarantee that colours shown are 100% accurate.

- = Not available  
 ● = Available  
 S = Standard

\*Total RRP inc VAT - Recommended Retail Price including VAT which is calculated at 20%. This may alter to reflect any change in the applicable VAT rate.



## Options

Every driver has different needs, which is why we have created some useful options to further enhance your car. For extra comfort, support, style or function, you can choose from a variety of additional features, tailoring everything from your infotainment and audio equipment to your wheels and lighting.





## Wheels, tyres and suspension

Choose a set of specially selected alloy wheels to subtly enhance the way your car looks.



17" x 7.5J '15-spoke Turbine'  
design alloy wheels - C17



17" x 7.5J '15-spoke' design  
alloy wheels - CH2



17" x 7.5J '5-arm Kinetic' design  
alloy wheels - CJ1



18" x 7.5J '5-arm Dynamic' design  
part-polished alloy wheels - C0T\*



18" x 7.5J '15-spoke Turbine'  
design alloy wheels - CV4\*

Options are subject to availability  
and may extend time taken for delivery.

\*Please note: choosing this optional wheel will affect the fuel consumption figures and CO<sub>2</sub> emissions of your A3 Sportback e-tron. This may result in an increase in subsequent Vehicle Excise Duty payable. Please see pages 64 and 67 for details.

All alloy wheel images are matched as accurately as possible to the actual colour. However, due to print processes, Audi UK cannot guarantee that colours shown are 100% accurate.

## Wheels, tyres and suspension

Order Code		e-tron	Total RRP inc VAT*
CI7	17" x 7.5J '15-spoke Turbine' design alloy wheels with 225/45 R17 tyres	S	£0.00
CH2	17" x 7.5J '15-spoke' design alloy wheels with 225/45 R17 tyres	●	£250.00
CJ1	17" x 7.5J '5-arm Kinetic' design alloy wheels with 225/45 R17 tyres	●	£250.00
C0T	18" x 7.5J '5-arm Dynamic' design part-polished alloy wheels with 225/40 R18 tyres*	●	£595.00
CV4	18" x 7.5J '15-spoke Turbine' design alloy wheels with 225/40 R18 tyres*	●	£995.00

Options are subject to availability and may extend time taken for delivery.

- = Not available
- = Available
- S = Standard

\*Please note: choosing this optional wheel will affect the fuel consumption figures and CO<sub>2</sub> emissions of your A3 Sportback e-tron. This may result in an increase in subsequent Vehicle Excise Duty payable. Please see pages 64 and 67 for details.

\*Total RRP inc VAT - Recommended Retail Price including VAT which is calculated at 20%. This may alter to reflect any change in the applicable VAT rate.



# Audio and communication

Stay in touch using our range of communication functions, and give each journey its own soundtrack with our advanced audio equipment.

Order Code		e-tron	Total RRP inc VAT*
9VD	<b>Audi sound system.</b> 10 speakers in total including centre speaker in the dashboard and subwoofer under the luggage compartment floor. 6-channel amplifier with a total output of 180 Watts	●	£255.00
9VS	<b>Bang &amp; Olufsen sound system.</b> Surround sound reproduction via 15-channel amplifier with a total output of 705 watts as well as 14 high-performance loudspeakers, including a centre speaker in the dashboard and a subwoofer under the luggage compartment floor. Perfect design experience thanks to the exclusive loudspeaker covers with aluminium applications and the LED lighting accentuating the front woofers. Continuous adaptation of the sound to driving and background noises determined by microphone and 5.1 surround sound reproduction	●	£750.00
9ZE	<b>Audi Phone Box.</b> Allows phone calls to be made with improved reception quality by placing the mobile phone in the storage compartment provided in the centre console to create a 'wireless' connection to the vehicle aerial. Operated via the MMI control panel or multi-function steering wheel. Mobile phone can be charged via a USB port. Please see <a href="http://audi.co.uk/phonecompatibility">audi.co.uk/phonecompatibility</a> to check compatibility and software version of your mobile phone	●	£325.00

Options are subject to availability and may extend time taken for delivery.

- = Not available
- = Available
- S = Standard

\*Total RRP inc VAT – Recommended Retail Price including VAT which is calculated at 20%. This may alter to reflect any change in the applicable VAT rate.



Bang & Olufsen sound system



Audi Phone Box





# Interior equipment

Specify every detail of your car's interior with this range of exclusive options.

Options are subject to availability and may extend time taken for delivery.

- = Not available  
● = Available  
S = Standard

\*Total RRP inc VAT – Recommended Retail Price including VAT which is calculated at 20%. This may alter to reflect any change in the applicable VAT rate.

Order Code		e-tron	Total RRP inc VAT*
QQ4	<b>Interior lighting package.</b> Anti-glare lighting for the passenger compartment comprising door sill and footwell lighting at the front as well as illuminated inside door openers and illuminated cup holders, 2 reading lights each at the front and rear, LED interior ambient lighting and active door reflectors	●	£170.00
PU7	<b>Auto-dimming rear-view mirror.</b> Includes a light sensor which detects when the headlights behind are too bright and dims the rear-view mirror automatically	●	£245.00
3NU	<b>Through-load facility.</b> For safely transporting long objects. Includes rear centre armrest with cup holders and a storage compartment	●	£150.00
QE1	<b>Storage and luggage package.</b> Includes storage nets on the backs of the front seat back rests, storage net in the front passenger footwell, 12V socket in the rear centre console and storage compartment under the rear seat. In the luggage compartment there is an additional multi-fastening point, a net in the side compartment, a luggage securing net and additional LED lighting	●	£145.00
7HE	<b>Extended mono.pur interior finish.</b> Front knee pads and armrests finished in mono.pur leather-effect material. Also includes stitching in the colour of the seat upholstery	●	£295.00
6NQ	<b>Cloth headlining in black</b>	●	£150.00
6SJ	<b>Reversible mat.</b> For the luggage compartment, velour on one side and rubberised on the other, to cover the entire luggage compartment, even with folded rear seat backrest	●	£65.00
9JA	<b>Non-smoking package.</b> Removes the ashtray and replaces the cigarette lighter with a standard 12V socket	●	£0.00



Storage and luggage package



# Exterior equipment

Make sure your car looks exactly as you want it to by selecting some of our striking options.

Order Code		e-tron	Total RRP inc VAT*
3FB	<b>Panoramic glass sunroof.</b> Activation to raise and open the glass section, opens and closes automatically. Tinted glass insert with manual, infinitely adjustable sun shield. Convenience closing from outside via the central locking remote control. The extra-large glass area floods the interior with light to create a pleasant ambience. Integrated wind deflector reduces wind noise when the roof is open. Only in combination with Interior light package (QQ4). Not available in combination with Towing equipment (1D2)	●	£950.00
3S1	<b>Aluminium roof rails</b>	●	£250.00
3S2	<b>Black roof rails</b>	●	£250.00
VW1	<b>Privacy glass.</b> Dark tinted rear and rear-side windows from B-pillar backwards	●	£290.00
6XE	<b>Door mirrors</b> – electrically adjustable, folding and heated. Also includes an automatic kerb view dipping function on the passenger side when reverse gear is selected	●	£150.00
6XK	<b>Door mirrors</b> – auto-dimming on the driver's side, electrically adjustable, folding and heated. Also includes an automatic kerb view dipping function on the passenger side when reverse gear is selected. Only in combination with Auto-dimming rear-view mirror (PU7)	●	£250.00
1D2	<b>Towing equipment.</b> Removable and lockable. Sphere bar and ball head made of forged steel. The 13-pin socket can be swivelled out of sight behind the bumper skirt. When removed, the trailer towing hitch can be stored in the spare wheel well. Not available in combination with Panoramic glass sunroof (3FB)	●	£625.00

Options are subject to availability and may extend time taken for delivery.

– = Not available  
● = Available  
S = Standard

\*Total RRP inc VAT – Recommended Retail Price including VAT which is calculated at 20%. This may alter to reflect any change in the applicable VAT rate.



# Safety and security

Intelligent technology designed to give you better all-round awareness and safety on the road.

Vehicle driver assistance and safety systems are not a substitute for attentive driving. Drivers retain full responsibility for providing the necessary inputs for safe control of the vehicle. System descriptions within this brochure are provided for information purposes only. System limitations and operational requirements apply. See manual for details.

Options are subject to availability and may extend time taken for delivery.

- = Not available
- = Available
- S = Standard

\*Total RRP inc VAT – Recommended Retail Price including VAT which is calculated at 20%. This may alter to reflect any change in the applicable VAT rate.

Order Code		e-tron	Total RRP inc VAT*
UH2	<b>Hold assist.</b> Holds the vehicle stationary for unlimited periods after stopping and prevents the vehicle rolling on hills and on gradients. The system is activated by push-button and allows the driver to drive away easily and comfortably without having to operate the electromechanical parking brake	•	£90.00
7X2	<b>Audi parking system plus, front and rear with selective display.</b> Acoustic and visual parking aid for the front and rear which displays white distance markers for obstacles that would not be touched and red symbols for obstacles that may be touched. This provides the driver with a selective optical view in the MMI display of all the objects recognised, depending on the current curve radius and direction of travel. Measurement is by ultrasonic sensors discreetly integrated in the bumpers	•	£250.00
7X5	<b>Audi parking system plus, with park assist.</b> In addition to parking system plus front and rear, ultrasonic sensors are used to search for parking spaces by the roadside and the system calculates the ideal parking path for reverse and parallel parking spaces. The steering action is performed almost automatically. Assisted parking is now even possible in smaller parking spaces and bend areas, and the system will park the car in several moves if required. Steering is done by the vehicle, while the driver only needs to accelerate and apply the brakes. 4 additional sensors indicate obstacles detected all around and at the side of the vehicle, and warn the driver, making parking easier and safer by setting the correct steering angle	•	£490.00
	In combination with Driver assistance package	•	£240.00
KA2	<b>Reversing camera.</b> Shows camera image of area behind the vehicle shown on the MMI display, with dynamic display modes highlighting the calculated path (steer-angle dependent). Includes auxiliary lines and guidelines, and identification of the point at which to apply opposite lock when parallel parking. The rear-view camera is integrated discreetly in the handle strip of the luggage compartment lid. Only in combination with Audi parking system plus, front and rear with selective display (7X2), Audi parking system plus, with park assist (7X5) or Driver assistance package (PCE)	•	£275.00



# Safety and security

Vehicle driver assistance and safety systems are not a substitute for attentive driving. Drivers retain full responsibility for providing the necessary inputs for safe control of the vehicle. System descriptions within this brochure are provided for information purposes only. System limitations and operational requirements apply. See manual for details.

Options are subject to availability and may extend time taken for delivery.

- = Not available
- = Available
- S = Standard

\*Where the law permits.

\*Total RRP inc VAT – Recommended Retail Price including VAT which is calculated at 20%. This may alter to reflect any change in the applicable VAT rate.

Order Code		e-tron	Total RRP inc VAT*
8T2	<b>Cruise control.</b> Maintains any speed above 18mph, provided that the engine power output and engine braking effect permit it. Operated via separate steering column stalk, with set speed displayed in the Driver's Information System (DIS)	•	£225.00
PCG	<b>Adaptive cruise control.</b> Automatic distance control (control range is between 0-100mph*) including Stop/Go function. Working within system limits it uses a radar sensor to detect vehicles ahead and maintain this distance by automatically braking and accelerating. 4 distance levels and different driving modes can be selected individually	•	£375.00
7W1	<b>Audi Pre-sense basic.</b> Networks the different vehicle systems to enable driving situations to be categorised and, where necessary, actions to be taken to protect the driver and passengers. These include: tensioning the front seat belts as well as closing the windows and – if fitted – the panoramic glass sunroof	•	£200.00
4X4	<b>Rear side airbags.</b> Situated in the side of the rear seats	•	£300.00
7Y5	<b>Audi side assist.</b> Aids the driver when changing lane. Audi side assist monitors the area behind your car using radar sensors located discreetly in the rear bumper. It then informs the driver with a visual warning signal in the door mirror if there is a vehicle in their blind spot or approaching quickly from behind. The system is activated using the MMI car settings	•	£450.00
PCB	<b>Driver assistance package.</b> Contains the following assistance functions: Adaptive cruise control and Audi parking system plus front and rear (7X2)	•	£455.00



## Looking after your Audi

When you've chosen your ideal model, it's reassuring to know that it will remain in safe hands. That's why we've created products to protect your Audi, such as extended warranties. And there's also a range of Audi accessories and merchandise to choose from, enabling you to further enhance and safeguard your car.







# Audi Complete

All A3 Sportback e-tron models operate on a Fixed Inspection Service Schedule.

## Warranty

All new Audi models come with a three-year warranty as standard, and you can choose to extend this to a four or five-year warranty\* for a one-off cost. What's more, if you decide to sell your Audi before the warranty expires, it will be fully transferred to the new owner.

The 8-year battery warranty is separate to the standard vehicle warranty, please see page 67 for further information.

- = Not available  
 ● = Available  
 S = Standard

\*Three-year warranty consists of a two-year unlimited mileage warranty and a third year warranty with a 60,000-mile limitation. Four-year warranty consists of a two-year unlimited mileage warranty and two further years' coverage with a 75,000-mile limitation. Five-year warranty consists of a two-year unlimited mileage warranty and three further years' coverage with a 90,000-mile limitation.

\*\*Only available prior to registration of your Audi A3 Sportback e-tron. Please speak to your Audi Centre for full details.

\*Total RRP inc VAT - Recommended Retail Price including VAT which is calculated at 20%. This may alter to reflect any change in the applicable VAT rate.

Audi Complete is our fixed-cost maintenance plan, which helps you keep your Audi in top condition and stay in control of your finances. For a simple monthly payment, you could cover your car's servicing, maintenance and, if you want, its tyres too.

So not only will you ensure your car runs smoothly, regular servicing can also protect its future resale value. And because everything's covered by one competitive price, there's no need to go anywhere else.

Pricing is completely tailored to your vehicle and takes into consideration the options you have on your vehicle and your likely annual mileage and resultant service schedule. Please speak to your Audi Centre for a personalised quote for Audi Complete.

Order Code		e-tron	Total RRP inc VAT†
-	<b>Audi Warranty</b> , covering you for unlimited mileage in the first two years of ownership, and up to 60,000 miles in the third year. Transferable between owners**	S	£0.00
EA6	<b>Audi Warranty</b> , covering you for up to 4 years or 75,000 miles, whichever comes sooner. Cover includes a two-year unlimited mileage warranty, and up to 75,000 miles in the third and fourth years. Transferable between owners**	●	£245.00
EA9	<b>Audi Warranty</b> , covering you for up to 5 years or 90,000 miles, whichever comes sooner. Cover includes a two-year unlimited mileage warranty, and up to 90,000 miles in the third, fourth and fifth years. Transferable between owners**	●	£545.00





## Accessories

Choosing an Audi isn't just a matter of deciding on the model you want; it's about creating a car that suits your needs perfectly. And that's why we've developed a whole range of optional accessories to enhance your A3 Sportback e-tron, enabling you to customise it down to the last detail. Like your Audi, all these accessories are developed to the highest possible standards. They're all available exclusively from Audi. To find out more, just visit [audi.co.uk/accessories](http://audi.co.uk/accessories) or contact your local Audi Centre.

### Warranty

All of the accessories available on the A3 Sportback e-tron are covered by a three-year warranty\* if they are ordered and included in the purchase price of the car at date of delivery. Any accessories ordered and installed after delivery include a two-year warranty.\*

\*Excluding Road Angel products. Audi Accessories warranty terms and conditions can be found at [audi.co.uk/warrantyterms](http://audi.co.uk/warrantyterms)



## Merchandise

From the enthusiasts' motorsport collection to the sophisticated Audi collection, there's a wide variety of adults' and children's clothing, lifestyle accessories and collectables, all of which bear the Audi name.

Please speak to a member of our team at your local Audi Centre to see the full Audi collection and to place an order. A selection of Audi merchandise is also available to buy from [audi.co.uk/merchandise](http://audi.co.uk/merchandise)



Image shown is the Audi kids' car legends, item number 320.13.004.00

# The Audi **Difference**

## The experts in Vorsprung durch Technik

Our Audi Approved Master Technicians have undergone an impressive 100,000 hours of training over a 10-year programme to ensure they have the latest technical expertise for maintaining and servicing your Audi. All our Service Advisors undergo a specialist induction and training to ensure they are Audi professionals and able to talk to you about any issues you may have with your Audi vehicle.

## Servicing suited to your needs

Regular servicing is key to safeguarding your Audi's performance and a full service history could help you enhance the future re-sale value. Using an Audi Centre for your servicing means your car will receive the highest level of care and expertise using Audi Genuine parts fitted by trained Audi technicians.

To make servicing your A3 Sportback e-tron easy, our Fixed Inspection Service uses conventional, fixed intervals. Oil-change Services are fixed to every 9,000 miles/1 year. Inspection services are fixed to every 19,000 miles/2 years.

When either Service is required, you'll be informed via the on-board service interval display. Booking a service is easy; simply contact your local Audi Centre or book online.

## Your convenience comes first

At Audi you can choose from a range of convenient services that suit your needs. Why not book a 'service while you wait' appointment\* and enjoy our complimentary refreshments while your car is with us? Or, if you need to be mobile, take advantage of one of our courtesy cars which we can even deliver to you.\* We guarantee we can service your Audi within 5 days without a courtesy car or within 10 days if you need transport. We will also ensure your car is returned to you with a full valet.

## Fixed Inspection Service Schedule

	<b>Vehicle usage:</b>
<b>Mileage</b>	Less than 10,000 miles per annum Mainly city/town centre driving. Short journeys.
	<b>Service intervals:</b>
<b>Oil-change Service</b>	Fixed to every 9,000* miles/1 year
<b>Inspection Service</b>	Fixed to every 19,000* miles/2 years

\*As indicated by the service interval display. Mileages are approximate as the Service Indicator system uses kilometres as its distance measurement.

## Audi Genuine Parts

You can rest assured that only Audi Genuine Parts will be used on your vehicle. What's more, Audi parts and labour come with a 2-year guarantee.\*\*

## No hidden costs

We believe strongly in transparency when it comes to our prices. For added peace of mind, we will give you a quotation over the phone for the work you have requested and email you the price confirmation. We'll consult you if any additional work on your car is needed when it is with us. We won't carry out any extra work without asking your permission first.

## All part of the service

Whenever we see an Audi for a service, we connect it directly to our headquarters in Ingolstadt which enables us to check your car's software and make sure it's as up-to-date as possible. If the factory has released a software upgrade for your model, it can be applied immediately – improving anything from your car's efficiency to the precision of its parking system.

## Audi Roadside Assistance

Your new car comes complete with 3 years' complimentary roadside assistance and recovery across the UK, provided by Automobile Association Insurance Services Limited. Also included is roadside assistance throughout Europe, managed by Automobile Association Insurance Services Limited.

For further information and terms and conditions please visit [audi.co.uk](http://audi.co.uk)

\*Subject to availability.

\*\*Excludes wear and tear.





# A3 Sportback e-tron technical data

\*Combined combustion engine with electric motor.

\*\*Optional 18" wheels affect the fuel consumption figures, BIK and the CO<sub>2</sub> emissions. This may result in an increase in subsequent Vehicle Excise Duty payable. See page 67 for more details on VED rates.

<sup>†</sup>Highest insurance group rating shown. Group may be lower dependent on trim level. Please visit [thatcham.org/abigrouprating](http://thatcham.org/abigrouprating) for details.

**Please note:** The maximum power output figures are quoted in PS (or Pferdestärke, which is the metric equivalent of brake horsepower). To convert to brake horsepower, divide the PS figure by 1.0139.

<sup>1</sup>The given value was obtained in accordance with the specified measurement procedure (the respective current version of the Directive 80/1269/EEC).

<sup>2</sup>Top speed is achieved in top gear.

<sup>3</sup>The 'combined/weighted' fuel consumption/CO<sub>2</sub> figures are calculated from two test results: one when the battery is fully charged and another when the battery is discharged. The two results are a weighted average, taking into account mileage range on battery power only, providing a figure in a variety of charge conditions. Battery charged using mains sourced electricity via plug-in. Extended range achieved by 1.4 TFSI petrol engine generating electricity. Fuel consumption and CO<sub>2</sub> figures are obtained under standardised EU test conditions (Directive 93/116/EEC). This allows a direct comparison between different manufacturer models but may not represent the actual fuel consumption achieved in 'real world' driving conditions. Range figures are calculated on the basis of the standardised EU test figures for fuel consumption. As a result, they are illustrative only and may not represent the actual range achieved in 'real world' driving conditions. Achieved range can vary depending on many factors, including driving style, speed, the use of convenience features/secondary consumers, outside temperature, the number of passengers/size of load, selection of driving profile and topography. Emissions are while driving.

<sup>4</sup>Vehicle's unladen weight without driver (calculated in accordance with the current version of Directive 80/1268/EEC). The fitting of additional equipment may increase the vehicle's unladen weight and drag coefficient, whereupon the potential carrying capacity and top speed will be correspondingly reduced.

<sup>5</sup>The engine's power output always goes down with increasing altitude. At 1,000m above sea level, and for every additional 1,000m, deduct 10% from the weight of the outfit (trailer load limit + gross weight of the towing vehicle).

<sup>6</sup>Measured by the VDA standard test method using 200 x 100 x 50mm blocks.

Engine	1.4 TFSI
Transmission	6-speed S tronic
Cylinder	4-cylinder
Displacement, cubic cm (valves per cylinder)	1395
Max. power, <sup>1</sup> PS at rpm	150/5000-6000
Max. torque, Nm at rpm	250/1600-3500
Top Speed <sup>2</sup> in hybrid mode, mph	138*
Top Speed <sup>2</sup> in electric only mode, mph	81
0-62mph acceleration in hybrid mode, seconds	7.6
ABI insurance group 1-50 <sup>†</sup>	29E
Unladen weight, <sup>4</sup> kg	1540
Gross weight limit, kg	2050
Roof load limit/nose weight, <sup>5</sup> kg	75/75
Max trailer load unbraked, <sup>5</sup> kg	750
Max trailer load with 12% gradient, <sup>5</sup> kg	1400
Max trailer load with 8% gradient, <sup>5</sup> kg	1600
Luggage compartment capacity, rear seats upright, litres <sup>6</sup>	280
Luggage compartment capacity, rear seats folded, litres <sup>6</sup>	1120
Fuel tank capacity approx, litres	40
Charging time, using home wall box or public charging point	Approx. 2 hours 15 minutes
Charging time, using normal domestic socket	Approx. 4 hours
Emission standard	EU6

Engine	1.4 TFSI	
Transmission	6-speed S tronic	
Max. power, <sup>1</sup> PS at rpm	150/5000-6000	
CO <sub>2</sub> emissions, <sup>2</sup> g/km	17" Wheel	37
	18" Wheel**	39
Benefit in kind (BIK)%	17" Wheel	5%
	18" Wheel**	5%
Fuel consumption, <sup>2</sup> mpg (l/100km) Combined	17" Wheel	176.6 (1.6)
	18" Wheel**	166.2 (1.7)
Range, <sup>3</sup> electric, in miles	up to 31	
Range, <sup>3</sup> overall, in miles	up to 584*	



# A3 Sportback e-tron dimensions

The technical drawings opposite show the exact dimensions of the new Audi A3 e-tron, so you can check everything – from whether the car will fit in your garage to whether your luggage will fit in the boot.

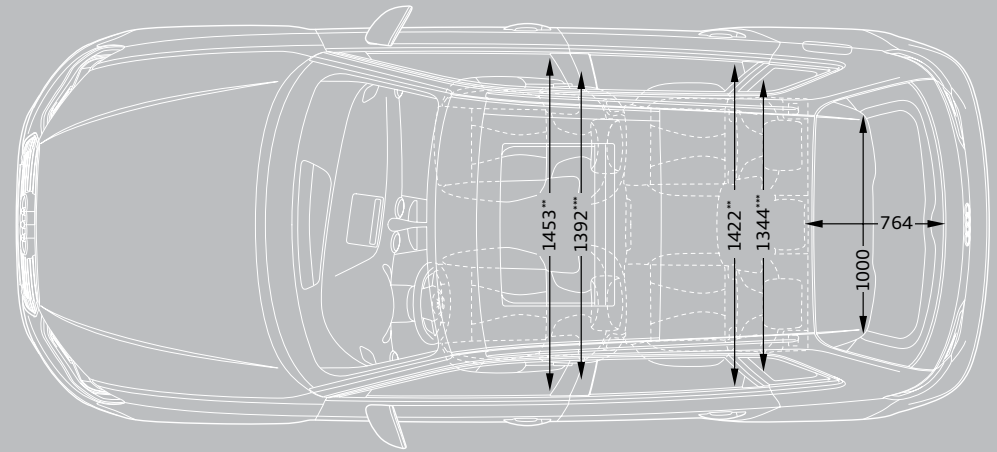
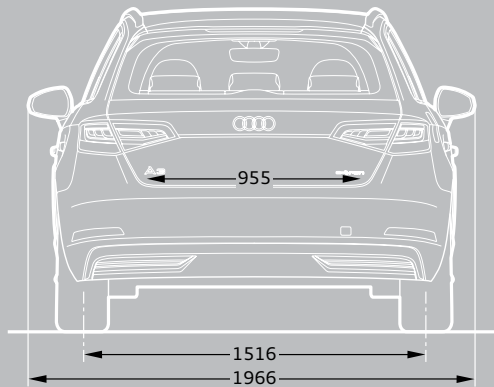
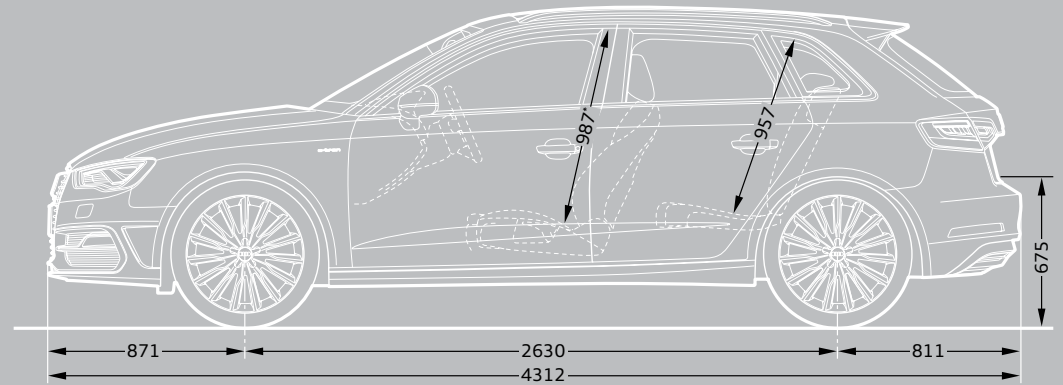
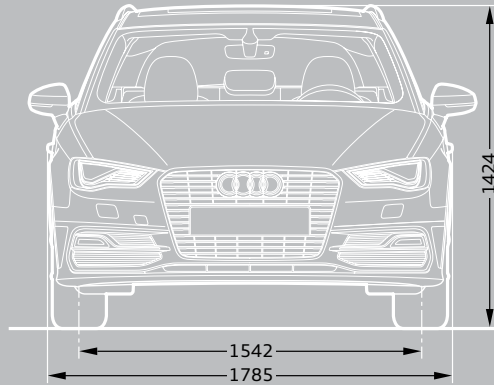

\*Maximum headroom.

\*\*Elbow room width.

\*\*\*Shoulder room width.

Dimensions in millimetres.

Turning circle approx 10.9m.

Dimensions measured with vehicle at unladen weight.

# Pricing and Additional information

## Welcome to Audi

By placing an order for your Audi, you're choosing to drive a car created in the spirit of Vorsprung durch Technik. And because we believe the service we offer should reflect the quality of our cars, we want to let you know exactly what you can expect from us, now and in the future.

## Audi Promise

### Audi Centres

We guarantee that all our Centres will be open as follows:

Sales: Monday to Friday 9am–6pm  
Saturday 9am–5pm

Service: Monday to Friday 8am–6pm  
Saturday 8.30am–1pm

Sunday opening is at local discretion.

### Audi e-tron network

The A3 Sportback e-tron will be available from 34 specialist e-tron centres in the Audi network. These centres will have the facilities and expertise to look after you and your A3 Sportback e-tron. From these centres you can purchase and service your car. The details for these centres can be found on [audi.co.uk](http://audi.co.uk). However, you can also make enquiries about e-tron at any Audi Centre.

### New car delivery

Once we've confirmed a delivery date for your car, we'll keep you informed of progress. Subject to reasonable notice, we'll then deliver it to a place of your choice, whether that's your home or work. In the unlikely event of a delay, we'll provide a courtesy car to minimise inconvenience and keep you mobile.

### Information in this guide

We've done all we can to make the prices, specifications, technical details and all other information you see in this guide accurate at the time of publication. However, as our products are constantly being updated, we recommend checking the details with your Audi Centre. We reserve the right to change prices or specifications at any time.

All prices are subject to VAT, currently charged at 20%, but this may alter to reflect any change in the applicable VAT rate.

Delivery charges and number plates are not included in the Total RRP inc VAT vehicle price.

Delivery charge	£504.99
Number plate	£20.00
VAT	£105.01
Total	£630.00

Recommended On-The-Road (OTR) prices include the delivery and number plate charges above, Road Fund Licence (which may vary depending on model/transmission – see table for details) and first registration fee at £55.00.

The images featured in this guide are for illustrative purposes only. They may feature left-hand drive vehicles and include equipment that is not UK specification.

### Audi Customer Care

Every new Audi benefits from the comprehensive Audi Customer Care Package, which comprises:

- ▶ A 3-year Audi warranty, which covers you for unlimited mileage in the first 2 years of ownership, with a full mechanical and electrical warranty which covers you for up to 60,000 miles in the 3rd year
- ▶ A 3-year paint warranty
- ▶ A 12-year anti-corrosion warranty
- ▶ 3 years' UK roadside assistance and recovery

You also have the option when ordering your new car of choosing a 4-year or 5-year Audi warranty. Speak to a member of the sales team for more information.

Warranty terms and conditions apply. Please see [audi.co.uk/warrantyterms](http://audi.co.uk/warrantyterms) for further details.

### Audi tax-free sales

If you are entitled to purchase a vehicle free of VAT, normally through military or diplomatic privilege, please contact your local Audi Centre for full details.

Should you have any difficulty obtaining the information you require, please call 0870 241 5663.

## Audi Financial Services

Audi Financial Services specialises in providing funding solutions for Audi drivers. Whether your Audi is for private or business use, there is a range of funding options to choose from.

Below is the full range of finance products, which comprises:

- ▶ Solutions – a Personal Contract Plan
- ▶ Hire purchase
- ▶ Lease purchase
- ▶ Finance lease
- ▶ Contract hire

With all products, you can choose a fixed-cost maintenance plan designed to help you budget accurately.

No matter which Audi model you choose, your local Audi Centre can provide you with a personalised quote designed to fit your budget and motoring needs.

Audi Financial Services is a trading name of Volkswagen Financial Services (UK) Limited. An offer of finance depends on certain conditions. Available to people over 18 in the UK only.

### Audi Insurance

To ensure you can start enjoying your new car from day one, the first five days' insurance is included as standard with all new Audi models. To activate simply call 0330 303 6900, provide us with a few details, and we'll send a cover note to your Audi Centre. They will then tax your car and you can drive it away. Telephone lines are open Monday to Friday 8am–8pm and Saturday 9am–4pm. For details of our full range of Insurance products visit [insurewithaudi.co.uk](http://insurewithaudi.co.uk)

### Audi e-tron connect services

Use of Audi e-tron connect services is only possible with the A3 e-tron model. The services are only available within the range of the supported mobile phone networks. To use Audi e-tron connect services, visit the myAudi platform at [my.audi.com](http://my.audi.com) to complete the required one-off registration. During this registration you must accept the conditions of use for the services. Registration must be carried out within 90 days of delivery of your A3 e-tron to avoid forfeiting free use of the Audi e-tron connect services. Audi e-tron connect services are made available on the A3 myAudi platform for 2 years following registration. Beyond this period, the services are automatically extended free of charge for one year, provided you have not yet terminated the services and Audi AG is still offering Audi e-tron connect services as of the final day on which the original 2-year period expires. You can terminate the Audi e-tron connect services at any time by deleting your user account on the myAudi platform. Audi e-tron connect services can be used via the myAudi platform or via an app, which is available on compatible iOS and Android devices. App use may require mobile data usage, which may incur a cost subject to the contract with the service provider.

### Audi Connect

The following external data source is required to enable Audi Connect online services:

A separate SIM card with data option (which can be inserted into the included SIM card reader). If LTE usage is required the SIM card will also need an LTE option. When a separate SIM card is used, hands-free phone calls are possible by connecting a different mobile telephone via Bluetooth Hands Free Profile. For mobile phone and software compatibility please visit [audi.co.uk/phonecompatibility](http://audi.co.uk/phonecompatibility) or your Audi Centre.

Online services will only be available within the coverage of the mobile phone network; there may be additional costs for the use of these services (charges and billing correspond to the personal mobile phone contract or SIM card contract). Due to high data volumes, a mobile phone contract including an unlimited or high usage data plan is strongly recommended. The content and scope of the online based services offered may vary.

A 36-month Audi Connect subscription is provided with your vehicle. The subscription runs from the point of vehicle delivery. Should you wish to continue to use Audi Connect after 36 months, please consult your Audi Centre for details (including the latest subscription fees).

Audi Connect services listed are correct at time of publication. We may add, change, replace or remove individual Audi Connect services or features at any time during your subscription.

Audi Connect enables access to the services of Google and Twitter. Permanent availability cannot be guaranteed as this is the responsibility of Google and Twitter. Google and the Google logo are registered trademarks of Google Inc.

The availability of services supported by Audi Connect varies from country to country and is dependent on the capability of your mobile phone. For mobile phone and software compatibility please visit [audi.co.uk/phonecompatibility](http://audi.co.uk/phonecompatibility) or your Audi Centre.

### Map updates

The map version delivered can be updated with the first 5 updates which are issued at intervals of 6 months. The current navigation data can be downloaded from the myAudi Platform at [audi.com/myaudi](http://audi.com/myaudi) and installed in the vehicle via SD card. In addition it is possible to have the new navigation data installed by an Audi partner at extra cost.

### 8-year Battery Warranty

1. The selling Audi dealership warrants that the high-voltage battery for vehicles sold by that dealership is free from all defects in material and workmanship for a period of 8 years or 100,000 miles, whichever comes first.
2. A reduction in battery power capacity of 10 to 30 per cent within the 8-year warranty period is normal for this type of component and does not constitute a defect under the terms of this warranty.
3. The warranty for the high-voltage battery shall be void if the defect has resulted from improper use, handling or maintenance of the battery. In particular, this applies to charging of the battery.
4. Notwithstanding the duration of the warranty, all warranty conditions of the selling Audi dealership shall apply additionally to the high-voltage battery (including but not limited to warranty requirements, benchmarks for determining freedom from defects, reasons for exclusion, handling of claims, entry into force and commencement of warranty period, scope of validity, etc).

### CO2 data and information

#### CO2 emissions-based Vehicle Excise Duty

Vehicle Excise Duty (Road Fund Licence) is based upon the amount of Carbon Dioxide (CO2) a vehicle emits, measured in grams per kilometre (g/km). First year VED rates apply to the first year of ownership. Annual VED rates apply thereafter. The DVLA has created thirteen categories:

Petrol and Diesel engines	First year	Annual rate (second year onwards)
A – up to 100g/km	£0.00	£0.00
B – 101 to 110g/km	£0.00	£20.00
C – 111 to 120g/km	£0.00	£30.00
D – 121 to 130g/km	£0.00	£110.00
E – 131 to 140g/km	£130.00	£130.00
F – 141 to 150g/km	£145.00	£145.00
G – 151 to 165g/km	£180.00	£180.00
H – 166 to 175g/km	£295.00	£205.00
I – 176 to 185g/km	£350.00	£225.00
J – 186 to 200g/km	£490.00	£265.00
K – 201 to 225g/km	£640.00	£290.00
L – 226 to 255g/km	£870.00	£490.00
M – over 255g/km	£1,100.00	£505.00

Vehicle Excise Duty (VED) rates correct at time of going to print, but these may alter to reflect any change in the applicable VED rate.









**Audi UK**

Customer Services  
Selectapost 29  
Sheffield  
S97 3FG  
0800 699888  
audi.co.uk

Information in this guide is  
subject to change without notice.

© Audi (UK)

Printed in the UK  
Edition 2.7 01/16  
2016 model year

Images for illustrative purposes only.

