



The Audi A5 and S5 Coupé

Pricing and Specification Guide
Valid from March 2016

Personalising your Audi A5 Coupé

This guide has been designed to help you tailor and price your Audi A5 Coupé quickly and logically. At the back, you will find information on CO2 emissions-based taxation and services offered with your Audi, including Finance and Insurance. You can also configure your Audi A5 Coupé online at audi.co.uk



Get more from this brochure with the free Audi Vision app.

Audi Vision brings our brochures to life through Augmented Reality. It works by recognising images on a page through your device's camera. Suitable for compatible phones or tablets, download it for free from the App Store or Google Play. Once downloaded, simply open the app and scan the cover of your guide. Then look out for any page with the Audi Vision logo, you can then hold your device over the page and watch as you get exclusive access to extra images, information and video content.



The images featured in this guide are for illustrative purposes only. They may feature left-hand drive vehicles and include equipment that is not UK specification.

The Audi A5 Coupé

Engines	12
Transmissions	13
Efficiency	14
quattro	16

Model details and prices

SE model equipment	20
S line model equipment	22
Black Edition Plus model equipment	24
S5 Coupé model equipment	26
S5 Coupé Black Edition model equipment	28
Model prices	30

Audi exclusive

32

Colour and upholstery

Paint	36
Upholstery and seats	40
Colour and trim guide	52

Inlays

56

Options

Wheels, tyres and suspension	60
Packages	66
Audio and communication	68
Interior equipment	70
Exterior equipment	72
Safety and security	73
Steering wheels	75

Looking after your Audi

Audi Complete and warranty	76
Accessories	79
Merchandise	80
Audi Difference	81

Technical details

Technical data	82
Dimensions	87
Pricing and Additional information	89





Vorsprung durch Technik

Three words that express the very essence of Audi – Vorsprung durch Technik. It's not just a slogan, it's our way of seeing the world and the driving force behind our history of innovation that continues into the 21st century. Indeed, many technologies that have become synonymous with Audi remain in our cars today. Some are milestones in the

history of the motorcar. From our beginnings in 1899, to the Auto Union team's Grand Prix successes in the 1930s and our more recent wins at Le Mans, we have always been at the forefront of the motor industry.

Vorsprung durch Technik makes us who we are. To see more of its influence, just read on.





The Audi A5 Coupé – a combination of style and power

Exceptional design is something you'll find everywhere in the Audi A5 Coupé – from the beautiful lines of the exterior to the fuel-injection technology within. An aerodynamic shape, muscular wheel arches and low-profile alloy wheels give this car a very special blend of style and performance, which is only emphasised by the choice of dynamic engines and transmissions available.









A5 Coupé interior story

We've introduced a number of finishing touches to the Audi A5 Coupé interior to make your driving experience both comfortable and unique. You'll find an impressive attention to detail in everything from the Driver's Information System with rest recommendation to our optional customised leather and stitching, which means that every journey you make will be a personal one.

Engines

Petrol

TFSI direct-injection technology that includes supercharging, which combines FSI technology with forced induction – giving cars an extra injection of power and torque. It also delivers enhanced fuel efficiency as precisely the right amount of fuel and air are injected into the combustion chambers, enabling the engine to ‘breathe’ more easily. It results in reduced heat loss and increased output.

Diesel

We introduced TDI to the roads in 1989, and since then, we’ve continuously refined it, including developing common-rail technology. With this system, a series of piezo injectors uses electrical charge to precisely control the amount of fuel injected into the engine. As well as reducing noise, this allows combustion to happen at a lower temperature, with less oxygen.





Transmissions

multitronic

Translating a driver's preferences and intentions into road performance, the multitronic transmission system entertains no compromises – whether in terms of dynamism, convenience or economy. multitronic automatic transmission is available on models without quattro permanent all-wheel-drive. A continuously variable transmission, multitronic can transmit up to 400 Nm of torque and permits an exceptionally wide range of gear ratios. The result is smooth, powerful acceleration and a high level of driving comfort.

S tronic

Driving is all about thinking ahead, which is just what the S tronic dual-clutch transmission does. It works almost as two separate systems, one engaging the odd-numbered and the other the even-numbered gears. So when you're accelerating in second, it has third gear waiting for you. And once you make the switch, it's already thinking about fourth. With two clutches working together, you can change gears almost instantly while experiencing smooth, virtually uninterrupted power.

Efficiency

We've incorporated a number of technologies into the Audi A5 Coupé aimed to enhance your drive and improve efficiency.

Automatic Start-Stop function

In heavy traffic, your car still uses fuel and releases CO₂, even when it's stationary. The automatic Start-Stop function counteracts this problem by switching off the engine when your car comes to a standstill. As soon as you touch the clutch, the car restarts.

TDI and TFSI

Inside the engine of the Audi A5 Coupé you'll find the same advanced fuel-injection technology that's driven us to win after win at Le Mans. With TDI and TFSI, fuel is injected directly into the engine's chambers so that combustion is timed right down to the millisecond. As a result, waste is minimised and you get the most from every last drop of fuel.





Audi ultra

The ultra badge is used to signify the lowest CO₂ model in the A5 Coupé range.

Recuperation

When a vehicle brakes, the discs convert the kinetic energy into thermal energy, which is wasted as it cannot be used. With a recuperation system like the one in the Audi A5 Coupé, the kinetic energy is converted into useful electrical energy. The way it works is simple. While the car is coasting or braking, the alternator voltage is raised above the level of the basic electrical system, which enables the alternator to generate electrical energy and store it temporarily in the battery. When the vehicle accelerates, this energy is used to relieve the load on the alternator, resulting in a fuel saving of up to 3%.

quattro

It's the technology that has been synonymous with Audi ever since it was first introduced over 30 years ago – a technology that helps deliver greater traction on all surfaces. It's called quattro permanent all-wheel-drive.

The principle is simple: in the same way that four brakes ensure better deceleration, four permanently-driven wheels aid acceleration and road-holding by distributing power to each individual wheel as necessary. The result is a dynamic driving experience in all conditions.

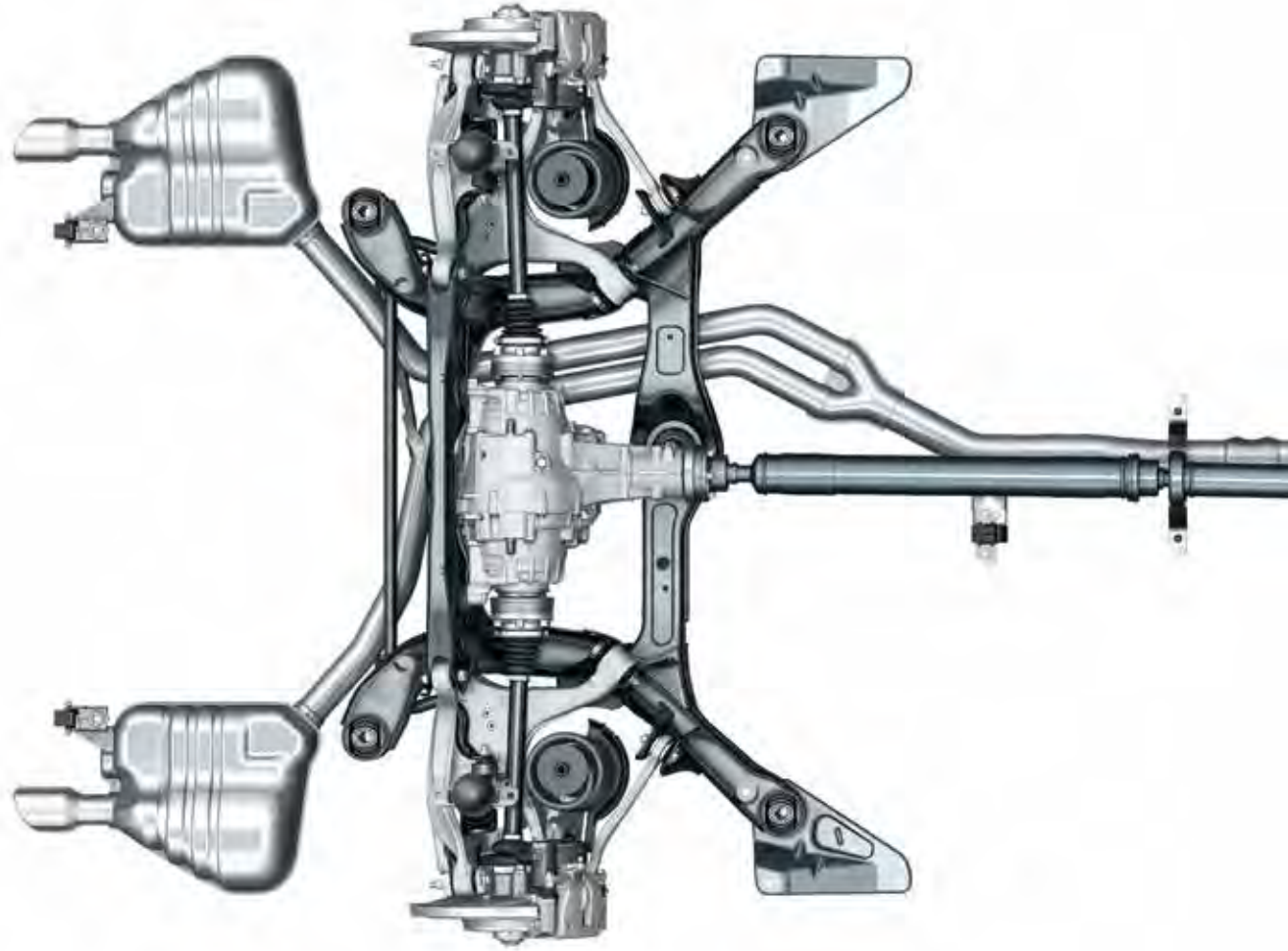

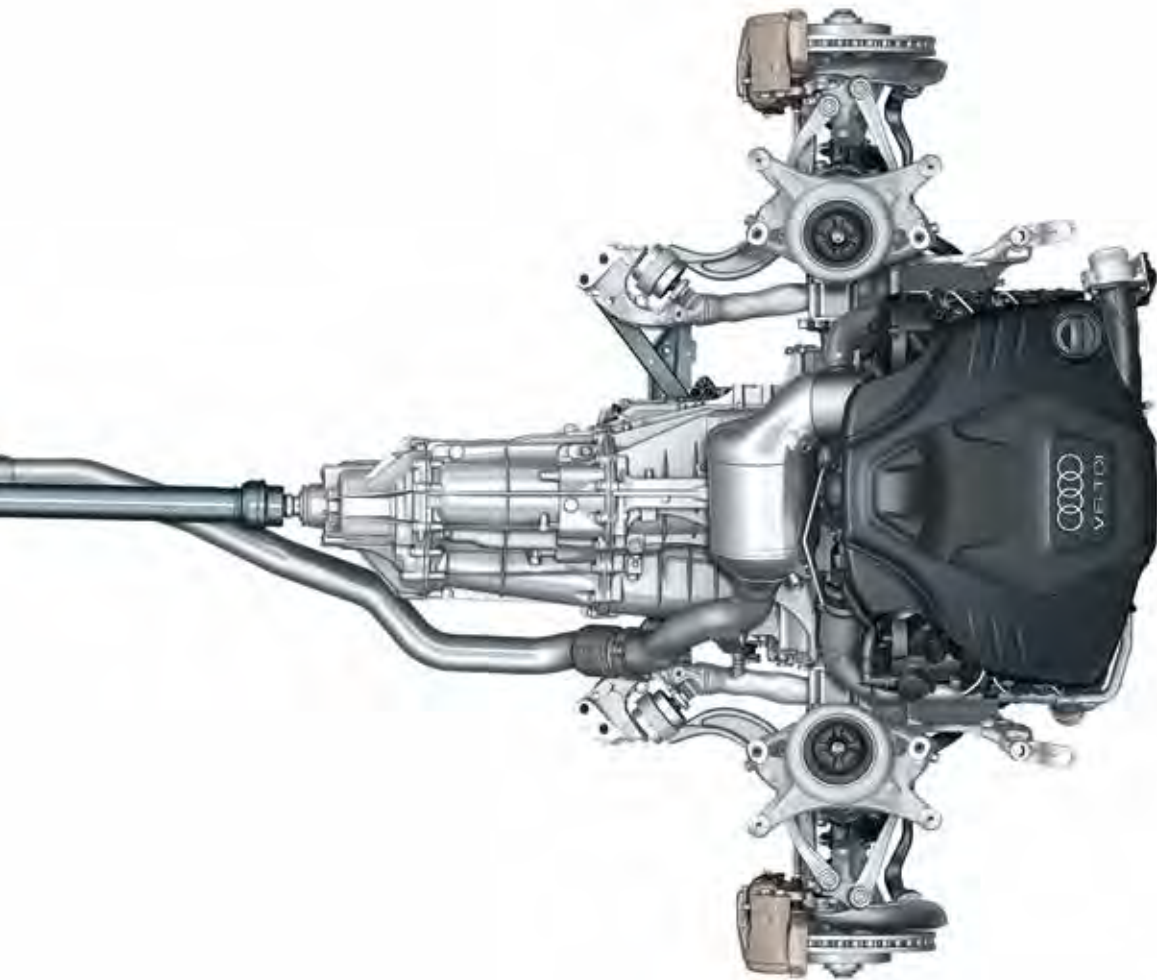

In the Audi A5 Coupé's quattro models, asymmetric dynamic torque distribution continuously distributes drive power between the front and rear axles, depending on weather conditions, road surface and gradient. This leads to greater flexibility and an enhanced, sportier drive.

quattro with Sport differential

The optional electronically regulated Sport differential takes the driving dynamics of quattro to a whole new level, improving stability and agility. By distributing torque variably to each of the rear wheels, the car steers even more spontaneously and directly. When cornering, for example, power is redirected to the outside rear wheel, literally pushing the car through the bend. It requires less steering effort – for a more agile, enhanced drive.





SE model equipment

All A5 Coupé models have the following items of standard equipment

Engine

Automatic Start-Stop function

Recuperation for optimal energy utilisation

Misfuelling inhibition for diesel engines

Diesel particulate filter (DPF) for diesel engines

Wheels, tyres and suspension

17" x 7.5J '5-arm' design alloy wheels with 225/50 R17 tyres. TDI ultra model features low rolling resistance tyres

Space-saver spare wheel

Audio and communication

Audi Concert radio which includes:

- Single CD drive and SDHC memory card reader which are both MP3, WMA and AAC compatible
- 6.5" colour centre display with MMI operating logic
- AUX-IN connection
- TP memo – automatically saves traffic news when driving

Audi sound system speaker package with 10 speakers including subwoofer (180 watts)

DAB digital radio reception – integrated into MMI, receives digitally transmitted radio stations in addition to the range of analogue stations. Displays music track, artist and radio program. Capable of 'DAB slideshow' where transmitted. Reception dependent on local digital network. Automatic switch from DAB to FM reception if the network signal is not strong enough

Bluetooth interface – for hands-free mobile phone connectivity (depending on compatibility and software version of mobile phone, please visit audi.co.uk phonecompatibility)

Safety and security

Audi parking system plus – aids parking by acoustically and graphically indicating distances to obstacles in front of and behind your A5 Coupé

Electronic Stability Control (ESC) including electronic limited-slip differential on front-wheel-drive models

First-aid kit

Front and rear fog lights

Full size airbags for driver and passenger

Front side airbags

Head-level side airbags front and rear

Halogen headlights with electric headlight

range control and daytime-running lights

ISOFIX child seat mounting – for front passenger (with airbag deactivation) and outer rear seats. Including Top Tether attachment point for the outer rear seats

Light and rain sensor – automatically switches the dipped beam headlights and windscreen wipers on/off depending on the light and rain conditions. Also includes coming-home/leaving-home function which delays the deactivation of the front and rear lights after locking and automatically activates the lights when unlocking

Rest recommendation system – analyses driving behaviour based on steering, pedals and gear lever movements. If the system detects a change in driving patterns it can, via audio and visual effects, notify the driver of the possible need to take a rest

Thatcham Category 1 alarm and immobiliser Toolkit and car jack

Tyre pressure loss indicator – visual and acoustic warning if the pressure drops in one or more tyres

Warning triangle



17" x 7.5J '5-arm' design alloy wheels



Colour Driver's Information System (DIS) with rest recommendation

Interior equipment

3-spoke leather multi-function steering wheel (paddle shift for automatic models)

Auto-dimming rear-view mirror

Cruise control

Cup holder in centre console

Driver's Information System (DIS) shows the radio station or track title, telephone control, menu and other display information from the infotainment system such as navigation (if fitted). Also includes an on-board trip computer with short and long-term trip memory, outside temperature display, digital speedometer and door or boot-open warning

Deluxe 3-zone climate control with separate air distribution and digital display for driver and front passenger. System includes air-conditioning controls in the rear centre console for rear passenger compartment

Electric front windows

Electromechanical parking brake includes parking brake function when stationary, drive off assistance with automatic release when pulling away and emergency braking assist, acting on all 4 wheels while driving

Electromechanical power steering

Front and rear floor mats

Front centre armrest includes two 12V power sockets

Intelligent key

Interior chrome package

Aluminium Trigon inlays

Steering column adjustment for rake and reach

Exterior equipment

Auto-opening boot lid

Exterior mirrors – electrically operated and heated

2 chrome rolled exhaust pipes – on the left hand side

Exterior aluminium package

Single frame radiator grille

Seats

Heated front seats – with 3-stage heating control

Milano leather upholstery

Split-folding rear seat



Image shows the A5 Coupé SE model with optional Floret silver, metallic paint (L5), Technology package (WB6) and Adaptive headlights (PX1, 8Q5)

S line model equipment

In addition to SE model equipment

Total RRP inc VAT*
£2,590.00

Wheels, tyres and suspension

18" x 8.5J '5-double-spoke' design alloy wheels with 245/40 R18 tyres

Sport suspension with stiffer spring settings and shock absorbers, 20mm lower than standard suspension (S line Sport suspension available at no additional charge)

Audio and communication

MMI Navigation system plus. Hard disk navigation with topographical map display, places of interest and town models in 3D, with high-resolution 7" colour TFT display. The system offers three alternative routes, with the ability to scroll along the selected route and manoeuvre within the map. Uses 7-digit postcode recognition. Includes split-screen mode for route information, dynamic route guidance (TMC), intersection zoom function, motorway exits and lane recommendations in Driver's Information System (DIS). Includes 2 SD card readers, single CD/DVD player, 40GB hard drive and Jukebox (20GB) for storing and managing music files in WMA and MP3 format. Includes European navigation data (where digitised).

Additional functionality is available when combined with optional Mobile telephone preparation – High with Audi Connect (9ZW). For more details please see option 9ZW, featured in the options section of the guide

Interior equipment

3-spoke S line multi-function steering wheel (paddle shift for automatic models)

Black headlining

Matt-brushed aluminium inlays

Perforated leather gear knob

S line sill plates

Seats

Front Sport seats with electric lumbar support

Fine Nappa leather upholstery with S line embossing

Exterior equipment

Rear LED lights

S line exterior styling package includes:

- S line side skirts
- S line bumper
- S line rear diffuser
- S line badges on wings

Xenon Plus headlights with LED daytime-running lights



18" x 8.5J '5-double-spoke' design alloy wheels



3-spoke S line multi-function steering wheel



Xenon Plus headlights



Satellite Navigation system – HDD-based



Image shows the A5 Coupé S line model with optional Scuba blue, metallic paint (S9)

Black Edition Plus model equipment

In addition to S line model equipment

Total RRP inc VAT*
£1,500.00

Wheels, tyres and suspension

19" x 9J '10-Y-spoke' design gloss black alloy wheels with 255/35 R19 tyres

Audio and communication

Audi Music Interface, connection for use with stereo audio sources, USB and MP3 devices including Apple iPod generation 4 onwards and Apple iPhone

Bang & Olufsen sound system. 14 high-performance speakers and two amplifiers which create 505 watts of stunning surround sound, balanced to suit the specific acoustic properties of the car's interior

Interior equipment

3-spoke flat-bottom multi-function steering wheel (paddle shift for automatic models)

Piano finish black inlays

Stainless steel pedals (only available on automatic models)

Exterior equipment

Black styling package – includes radiator grille frame and radiator grille struts in high-gloss black, fog light surrounds in the side ventilation grille in high-gloss black, radiator grille in matt black, front side grilles in matt black, number plate holder in matt black, window capping strips and side-profile roof-trim strip in high-gloss black

Privacy glass – dark tinted from B-pillar backwards

Gloss black exterior mirror housings*

Enhanced rear spoiler on the luggage compartment lid

Dynamic front bumper with large air inlets and blade in high-gloss black

Side sill trims and diffuser frame in high-gloss black



19" x 9J '10-Y-spoke' design gloss black alloy wheels



Bang & Olufsen sound system



Piano finish black inlays

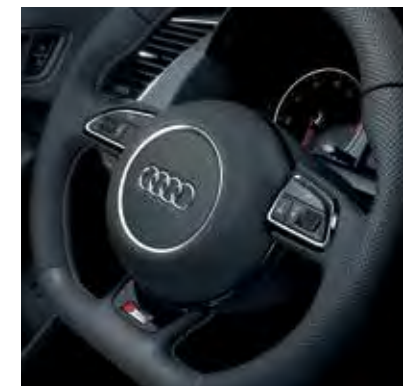

3-spoke flat-bottom multi-function steering wheel

*Please note that on Black Edition Plus models ordered in Mythos black, exterior mirror housings will also be in Mythos black.

*Total RRP inc VAT – Recommended Retail Price including VAT which is calculated at 20%. This may alter to reflect any change in the applicable VAT rate.



Image shows the A5 Coupé Black Edition Plus model with standard Ibis white paint (T9)



S5 Coupé quattro model equipment – in addition to SE model equipment

Wheels, tyres and suspension

19" x 8.5J '5-parallel-spoke' design alloy wheels with 255/35 R19 tyres
'S' Sport suspension

Safety and security

'S' model enhanced braking system

Interior equipment

3-spoke 'S' Sport multi-function leather steering wheel. With paddle shift and contrasting stitching

Aluminium scuff plates with S5 logo

Black headlining

Interior lighting package. Includes front and rear footwell lighting, active door reflectors, illuminated vanity mirrors, rear reading lights, entrance lights and illuminated glove compartment, vents and internal door controls

Inlays in matt-brushed aluminium

'S' instrument dials

Seats

Fine Nappa leather upholstery

Leather door armrests

S5 Coupé Super Sport seats. With electric adjustment and lumbar support

Exterior equipment

Aluminium-effect door mirror housings

Exhaust pipes. Twin on left and right-hand side in chrome rolled finish

'S' radiator grille with S5 logo

Painted brake calipers with S5 logo

'S' body styling

Xenon headlights. With LED daytime-running lights and LED rear lamps



19" x 8.5J '5-parallel-spoke' design alloy wheels



'S' instrument dials





Black Edition

**S5 Coupé quattro
Black Edition
model equipment –
in addition to S5
model equipment**

Total RRP inc VAT*
£1,075.00

Wheels, tyres and suspension

19" x 9J '5-arm Rotor' design titanium-finish alloy wheels with 255/35 R19 tyres

Audio and communication

Audi Music Interface. Connection for use with stereo audio sources, USB and MP3 devices including Apple iPod generation 4 onwards and Apple iPhone

Bang & Olufsen sound system. 14 high-performance speakers and two amplifiers which create 505 watts of stunning surround sound, balanced to suit the specific acoustic properties of the car's interior

Interior equipment

3-spoke flat-bottom multi-function steering wheel (paddle shift for automatic models)

Piano finish black inlays

Exterior equipment

Black styling package – includes radiator grille frame and radiator grille struts in high-gloss black, fog light surrounds in the side ventilation grille in high-gloss black, radiator grille in matt black, front side grilles in matt black, number plate holder in matt black, window capping strips and side-profile roof-trim strip in high gloss black

Privacy glass. Dark tinted from B-pillar backwards



19" x 9J '5-arm Rotor' design titanium-finish alloy wheels



Bang & Olufsen sound system



A5 Coupé SE

Engines	Power	Transmissions	CO ₂ g/km*	Total RRP inc VAT [^]	Recommended OTR ⁺
1.8 TFSI	177PS	6-speed manual	128	£28,505.00	£29,190.00
1.8 TFSI	177PS	multitronic	132	£29,985.00	£30,800.00
2.0 TFSI quattro	230PS	6-speed manual	149	£33,165.00	£33,995.00
2.0 TFSI quattro	230PS	7-speed S tronic	153	£34,645.00	£35,510.00
2.0 TDI ultra	163PS	6-speed manual	109	£30,905.00	£31,590.00
2.0 TDI	190PS	6-speed manual	117	£30,905.00	£31,590.00
2.0 TDI quattro	190PS	6-speed manual	128	£32,430.00	£33,115.00
2.0 TDI	190PS	multitronic	119	£32,385.00	£33,070.00
2.0 TDI quattro	190PS	7-speed S tronic	132	£33,910.00	£34,725.00

A5 Coupé S line

Engines	Power	Transmissions	CO ₂ g/km*	Total RRP inc VAT [^]	Recommended OTR ⁺
1.8 TFSI	177PS	6-speed manual	134	£31,095.00	£31,910.00
1.8 TFSI	177PS	multitronic	139	£32,575.00	£33,390.00
2.0 TFSI quattro	230PS	6-speed manual	157	£35,755.00	£36,620.00
2.0 TFSI quattro	230PS	7-speed S tronic	159	£37,235.00	£38,100.00
2.0 TDI	190PS	6-speed manual	124	£33,495.00	£34,180.00
2.0 TDI quattro	190PS	6-speed manual	135	£35,020.00	£35,835.00
2.0 TDI	190PS	multitronic	126	£34,975.00	£35,660.00
2.0 TDI quattro	190PS	7-speed S tronic	139	£36,500.00	£37,315.00
3.0 TDI quattro	245PS	7-speed S tronic	158	£40,475.00	£41,340.00

A5 Coupé Black Edition Plus

Engines	Power	Transmissions	CO ₂ g/km*	Total RRP inc VAT [^]	Recommended OTR ⁺
1.8 TFSI	177PS	6-speed manual	142	£32,595.00	£33,425.00
1.8 TFSI	177PS	multitronic	144	£34,075.00	£34,905.00
2.0 TFSI quattro	230PS	6-speed manual	161	£37,255.00	£38,120.00
2.0 TFSI quattro	230PS	7-speed S tronic	166	£38,735.00	£39,715.00
2.0 TDI	190PS	6-speed manual	129	£34,995.00	£35,680.00
2.0 TDI quattro	190PS	6-speed manual	140	£36,520.00	£37,335.00
2.0 TDI	190PS	multitronic	131	£36,475.00	£37,290.00
2.0 TDI quattro	190PS	7-speed S tronic	144	£38,000.00	£38,830.00
3.0 TDI quattro	245PS	7-speed S tronic	164	£41,975.00	£42,840.00

*Please note: CO₂ emissions can change if a different size alloy is ordered onto the vehicle. This may also lead to a change to the VED amount payable. Please refer to pages 62, 63, 83, 85, 86 and 90 for more details. Value based on standard EU test figures for comparative purposes and may not reflect real driving results.

Please note: The maximum power output figures are quoted in PS (or Pferdestärke, which is the metric equivalent of brake horsepower). To convert to brake horsepower, divide the PS figure by 1.0139.

[^]Total RRP inc VAT - Recommended Retail Price including VAT which is calculated at 20%. This may alter to reflect any change in the applicable VAT rate.

⁺Recommended On-The-Road (OTR) retail prices include: delivery charge, half a tank of fuel, number plates at £630.00 (inc. VAT), Road Fund Licence (which may vary depending on model/transmission – see page 90 for details) and first registration fee at £55.00. Vehicle Excise Duty correct at time of going to print, but this may alter to reflect any change in the applicable VED rate.

S5 Coupé

Engine	Power	Transmission	CO ₂ g/km*	Total RRP inc VAT [^]	Recommended OTR [†]
3.0 TFSI	333PS	7-speed S tronic	184	£42,755.00	£43,790.00

S5 Coupé Black Edition

Engine	Power	Transmission	CO ₂ g/km*	Total RRP inc VAT [^]	Recommended OTR [†]
3.0 TFSI	333PS	7-speed S tronic	184	£43,830.00	£44,865.00

***Please note:** CO₂ emissions can change if a different size alloy is ordered onto the vehicle. This may also lead to a change to the VED amount payable. Please refer to pages 62, 63, 83, 85, 86 and 90 for more details. Value based on standard EU test figures for comparative purposes and may not reflect real driving results.

Please note: The maximum power output figures are quoted in PS (or Pferdestärke, which is the metric equivalent of brake horsepower). To convert to brake horsepower, divide the PS figure by 1.0139.

[^]Total RRP inc VAT - Recommended Retail Price including VAT which is calculated at 20%. This may alter to reflect any change in the applicable VAT rate.

†Recommended On-The-Road (OTR) retail prices include: delivery charge, half a tank of fuel, number plates at £630.00 (inc. VAT), Road Fund Licence (which may vary depending on model/transmission – see page 90 for details) and first registration fee at £55.00. Vehicle Excise Duty correct at time of going to print, but this may alter to reflect any change in the applicable VED rate.





Audi exclusive

For that special touch you can specify your new A5 Coupé with options from Audi exclusive. Whether you want a unique, custom-mixed paint colour or seats in a combination of complementary shades, Audi exclusive will enable you to drive the car you've always imagined.

Both the exclusive and standard options can be found on the following pages.





Audi exclusive line

There are a number of ways to customise your car's interior with the Audi exclusive range. And if you'd like us to help you choose, we've put the most popular elements of the range together into one harmonious package – the Audi exclusive line.

With experience over more than 20 years, our expert designers understand which elements work well together. From high-quality Fine Nappa leather seats to Audi exclusive door sill trims, every detail has been chosen to truly enhance your experience.



Paint

We believe that every part of your car should have a personal touch. Which is why you can choose from a wide range of paint colours, from solid paint to metallic and pearl effect finishes.

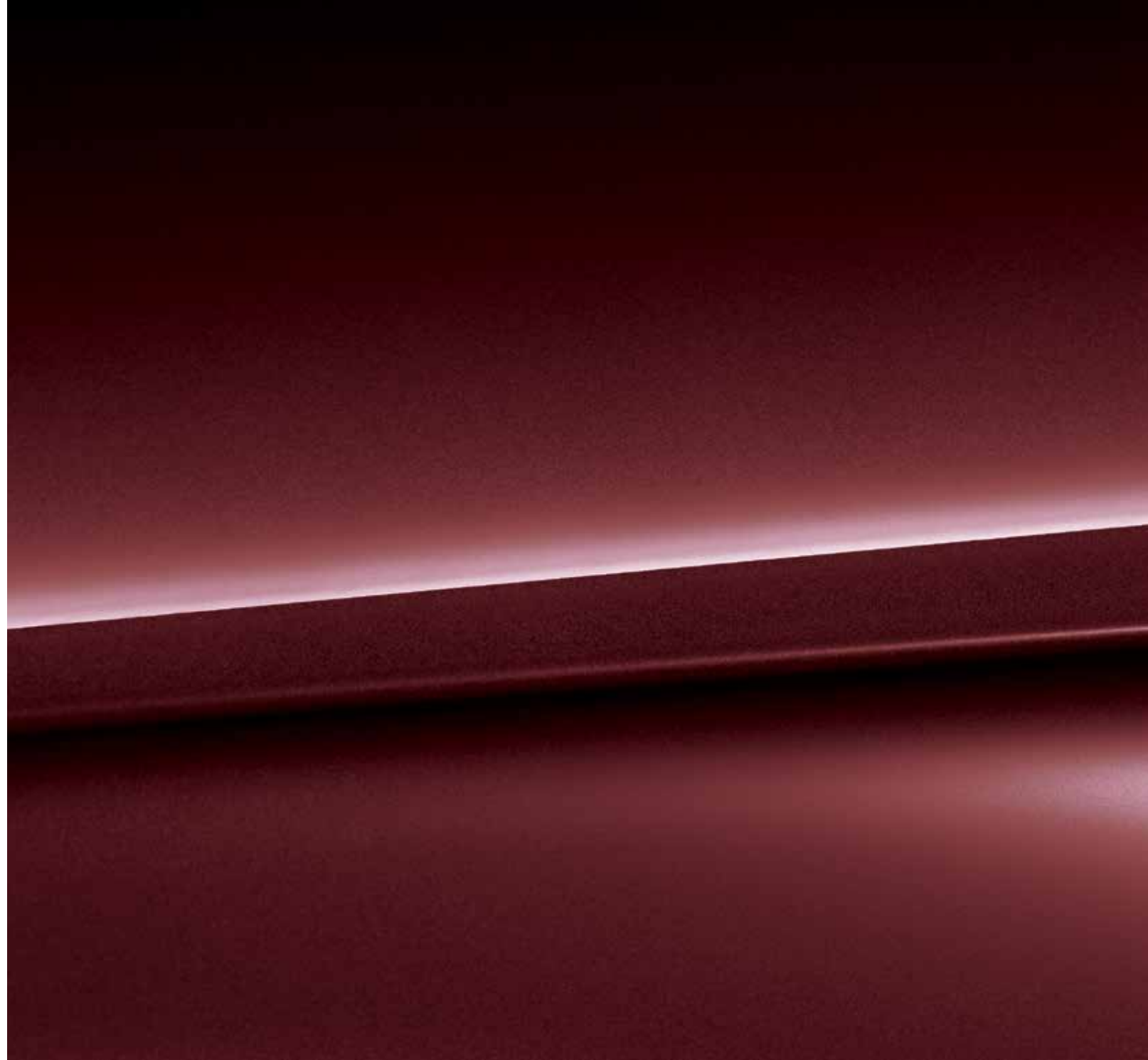

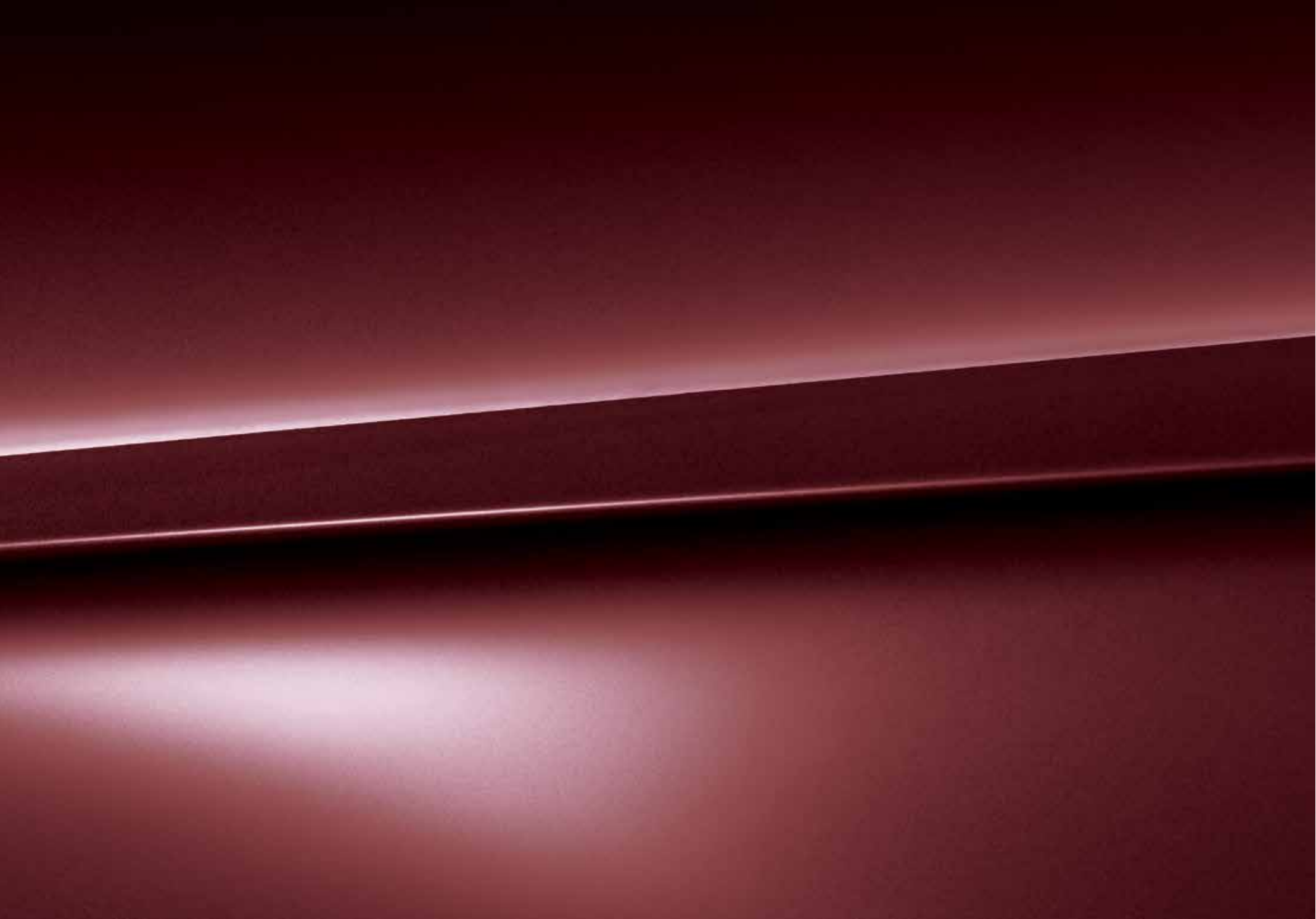

Paint

You can select one of the standard colours shown opposite or, for a different look, choose from a range of optional finishes.

Standard colours



Ibis white - T9

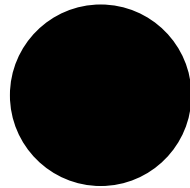

Brilliant black - A2^

Optional colours

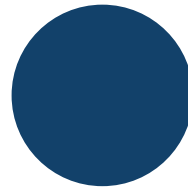

Scuba blue, metallic - 59**

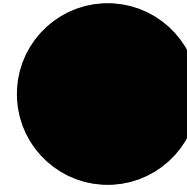

Lava grey, pearl effect - 1R**

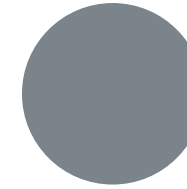

Tornado grey, metallic - Q2^

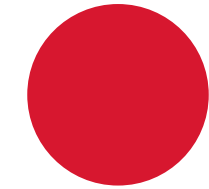

Misano red, pearl effect - N9

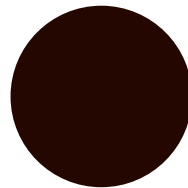

Teak brown, metallic - 4U**



Glacier white, metallic - 2Y^

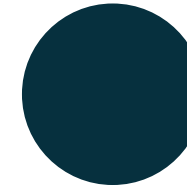

Utopia blue, metallic - D2^

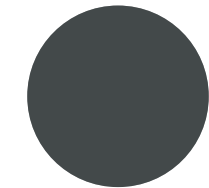

Daytona grey, pearl effect - 6Y

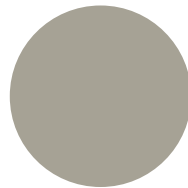

Cuvée silver, metallic - 0D**

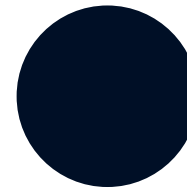

Moonlight blue, metallic - W1^

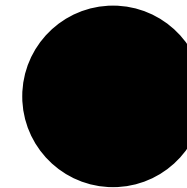

Mythos black, metallic - 0E

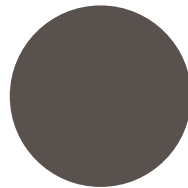

Dakota grey, metallic - Y7**

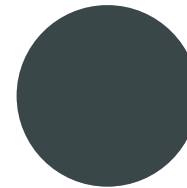

Monsoon grey, metallic - 0C^

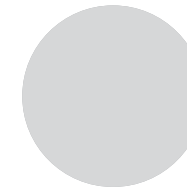

Floret silver, metallic - L5

Options are subject to availability and may extend time taken for delivery.

*Not available on S5 Coupé.

^Not available on Black Edition Plus models.

All the colour swatches on this page are matched as accurately as possible to the actual paint colours used. However, due to print processes, Audi UK cannot guarantee that colours shown are 100% accurate.

Visit your local Audi Centre for a more accurate colour swatch.

*Total RRP inc VAT - Recommended Retail Price including VAT which is calculated at 20%. This may alter to reflect any change in the applicable VAT rate.

Optional colours

Total RRP inc VAT*

£645.00

Black Edition Plus and S5 colour

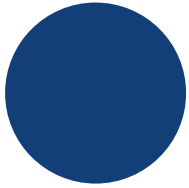

Sepang blue, pearl effect - E9

S5 colour

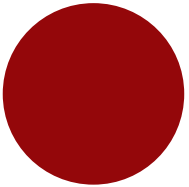

Volcano red, metallic - 1G

Paint

Audi exclusive

Everyone has a favourite colour. No matter what yours is, Audi exclusive provides a range of unique colours that have been designed to set your car apart. Choose from the swatches here, or specify any other paint colour in the Audi range.*

Customised

If you have a particular colour in mind, we'll mix the exact metallic or pearl-effect shade you want.**

Options are subject to availability and may extend time taken for delivery.

*Audi exclusive paint is subject to factory approval. Visit your local Audi Centre for colour samples.

**Customised paint is subject to factory approval, and is available for metallic and pearl-effect water-based paints only. Three-colour process colours and two-tone schemes are not available.

All the colour swatches on this page are matched as accurately as possible to the actual paint colours used. However, due to print processes, Audi UK cannot guarantee that colours shown are 100% accurate.

Visit your local Audi Centre for a more accurate colour swatch.

*Total RRP inc VAT - Recommended Retail Price including VAT which is calculated at 20%. This may alter to reflect any change in the applicable VAT rate.

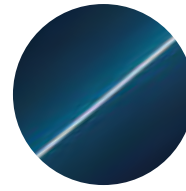

Palace blue, pearl effect

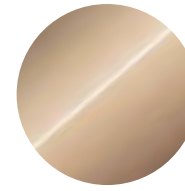

Sand beige, pearl effect

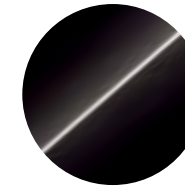

Saddle brown, pearl effect

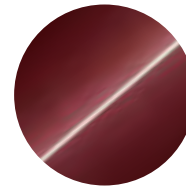

Classic red, pearl effect

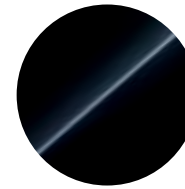

Mamba black, metallic

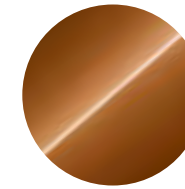

Ipanema brown, metallic



Any colour in the Audi range or 100 exclusive colours to choose from*



Customised paint**

Audi exclusive*

Total RRP inc VAT+
£2,115.00

Customised**

Total RRP inc VAT+
£2,615.00

Upholstery

It's important to feel comfortable on the road. Just choose from our range of luxury upholstery materials and textures, including additional support and colour options, for complete relaxation while you drive.









Upholstery and seats

Standard seats

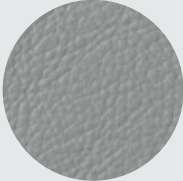
Choose your upholstery from the swatches shown opposite to give your car's interior the look and feel you want.

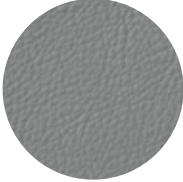
Front Standard seats come with manual adjustment of seat height, forwards and backwards position, backrest angle and head restraint.

						SE	S line	Black Edition Plus	S5	S5 Black Edition	Total RRP inc VAT*
Milano leather						S	-	-	-	-	£0.00
	Black - FZ	Titanium grey - IE	Velvet beige - IF/ID								
	Fine Nappa leather*						•	-	-	-	-
Black - FZ		Titanium grey - IE	Chestnut brown - VR								

Options are subject to availability and may extend time taken for delivery.

- = Not available
- = Available
- S = Standard

All leather upholstery choices include seats, head restraints and front centre armrest in leather.

*Includes leather door armrests (7HB).

All the colour swatches on this page are matched as accurately as possible to the actual upholstery colours used. However, due to print processes, Audi UK cannot guarantee that colours shown are 100% accurate.

*Total RRP inc VAT - Recommended Retail Price including VAT which is calculated at 20%. This may alter to reflect any change in the applicable VAT rate.

Upholstery and seats

Standard seat options

Order Code		SE	S line	Black Edition Plus	S5	S5 Black Edition	Total RRP inc VAT*
4A4	Heated front and rear seats with 3-stage heating control	●	—	—	—	—	£200.00
7P1	Electric lumbar support for front seats with horizontal and vertical adjustment	●	—	—	—	—	£235.00
PV1	Electrically adjustable front seats. Includes adjustment for height, forwards and backwards position, backrest angle and lumbar support	●	—	—	—	—	£765.00
PV3 6XL	Convenience package. Comprises electric front seats with memory function on driver's side and lumbar support. Also includes folding and auto-dimming door mirrors with memory function and automatic kerb view function, which tilts the passenger mirror downwards towards the kerb when reverse gear is engaged	●	—	—	—	—	£1,350.00



Standard seat

Options are subject to availability and may extend time taken for delivery.

- = Not available
- = Available
- S = Standard

*Total RRP inc VAT – Recommended Retail Price including VAT which is calculated at 20%. This may alter to reflect any change in the applicable VAT rate.

Upholstery and seats

Sport seats

Choose your upholstery from the swatches shown opposite to give your car's interior the look and feel you want.

Front Sport seats come with prominent side bolsters for lateral support when cornering. Also feature electric 4-way lumbar support and manual seat adjustment with extendable thigh support.

Options are subject to availability and may extend time taken for delivery.







- = Not available
- = Available
- S = Standard

*Includes leather door armrests (7HB).

All the colour swatches on this page are matched as accurately as possible to the actual upholstery colours used. However, due to print processes, Audi UK cannot guarantee that colours shown are 100% accurate.

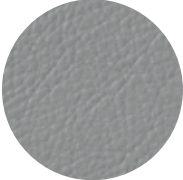
All leather upholstery choices include seats, head restraints and front centre armrest in leather. Leather/Alcantara choices include head restraints, seat side bolsters and front centre armrest in leather with the seat centres and door inserts in Alcantara.

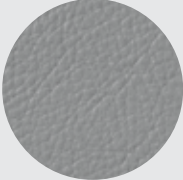
*Total RRP inc VAT - Recommended Retail Price including VAT which is calculated at 20%. This may alter to reflect any change in the applicable VAT rate.

							SE	S line	Black Edition Plus	S5	S5 Black Edition	Total RRP inc VAT*
Leather/Alcantara							•	-	-	-	-	£410.00
	Black - FZ	Titanium grey - IE										
Milano leather							•	-	-	-	-	£410.00
	Black - FZ	Titanium grey - IE	Velvet beige - IF/ID									
Fine Nappa leather*							•	-	-	-	-	£775.00
	Black - FZ	Titanium grey - IE	Velvet beige - IF/ID									
												
	Chestnut brown - VR											

Upholstery and seats

Sport seat options

Order Code		SE	S line	Black Edition Plus	S5	S5 Black Edition	Total RRP inc VAT*
4A4	Heated front and rear seats with 3-stage heating control	●	—	—	—	—	£200.00
PV1	Electrically adjustable front seats. Includes adjustment for height, forwards and backwards position, backrest angle and lumbar support	●	—	—	—	—	£765.00
PV3 6XL	Convenience package. Comprises electric front seats with memory function on driver's side and lumbar support. Also includes folding and auto-dimming door mirrors with memory function and automatic kerb view function, which tilts the passenger mirror downwards towards the kerb when reverse gear is engaged	●	—	—	—	—	£1,350.00



Sport seat (PS1) with electrical adjustment (PV1)

Options are subject to availability and may extend time taken for delivery.

- = Not available
- = Available
- S = Standard

*Total RRP inc VAT – Recommended Retail Price including VAT which is calculated at 20%. This may alter to reflect any change in the applicable VAT rate.

Upholstery and seats

Climate comfort seats

Choose your upholstery from the swatches shown opposite to give your car's interior the look and feel you want.

Front Climate comfort seats come with perforated leather on the actively ventilated and heated areas of the front seats, and on the non-ventilated areas of the rear seats.

Also includes:

- electrical adjustment for height, forwards and backwards position, backrest angle and lumbar support
- memory function for driver's seat
- folding and auto-dimming door mirrors with memory function
- rear bench with integral storage tray

Unavailable on 2.0 TDI ultra models.

Options are subject to availability and may extend time taken for delivery.

- = Not available
- = Available
- S = Standard

All leather upholstery choices include seats, head restraints and front centre armrest (if fitted) in leather.

All the colour swatches on this page are matched as accurately as possible to the actual upholstery colours used. However, due to print processes, Audi UK cannot guarantee that colours shown are 100% accurate.

*Total RRP inc VAT - Recommended Retail Price including VAT which is calculated at 20%. This may alter to reflect any change in the applicable VAT rate.

					SE	S line	Black Edition Plus	S5	S5 Black Edition	Total RRP inc VAT*
Milano leather					•	-	-	-	-	£2,480.00
	Black - FZ	Titanium grey - IE	Velvet beige - IF/ID	Chestnut brown - VR						

Upholstery and seats

Climate comfort seat options

Order Code		SE	S line	Black Edition Plus	S5	S5 Black Edition	Total RRP inc VAT*
4A4	Heated front and rear seats with 3-stage heating control	●					£200.00



Climate comfort seat (PSB)

Options are subject to availability and may extend time taken for delivery.

- = Not available
- = Available
- S = Standard

*Total RRP inc VAT - Recommended Retail Price including VAT which is calculated at 20%. This may alter to reflect any change in the applicable VAT rate.

Upholstery and seats

S line Sport seats

Choose your favourite upholstery from the swatches shown opposite to give your car's interior the look and feel you want.

Front Sport seats with S line embossing and prominent side bolsters for lateral support when cornering. Also feature electric 4-way lumbar support and manual seat-cushion angle adjustment with extendable thigh support.

Options are subject to availability and may extend time taken for delivery.

- = Not available
- = Available
- S = Standard

All leather upholstery choices include seats, head restraints and front centre armrest (if fitted) in leather.

*Includes leather door armrests (7HB).

All the colour swatches on this page are matched as accurately as possible to the actual upholstery colours used. However, due to print processes, Audi UK cannot guarantee that colours shown are 100% accurate.

*Total RRP inc VAT - Recommended Retail Price including VAT which is calculated at 20%. This may alter to reflect any change in the applicable VAT rate.

Leather/Alcantara



Black with grey stitching - QZ



Black - QE

Fine Nappa leather*

	SE	S line	Black Edition Plus	S5	S5 Black Edition	Total RRP inc VAT†
Leather/Alcantara	-	•	•	-	-	£0.00
Fine Nappa leather*	-	S	S	-	-	£0.00

Upholstery and seats

S line Sport seat options

Order Code		SE	S line	Black Edition Plus	S5	S5 Black Edition	Total RRP inc VAT*
4A4	Heated front and rear seats with 3-stage heating control	-	•	•	-	-	£200.00
PV1	Electrically adjustable front seats. Includes adjustment for height, forwards and backwards position, backrest angle and lumbar support	-	•	•	-	-	£455.00
PV3 6XL	Convenience package. Comprising electric front seats with memory function on driver's side and lumbar support. Also includes folding and auto-dimming door mirrors with memory function and automatic kerb view function, which tilts the passenger mirror downwards towards the kerb when reverse gear is engaged	-	•	•	-	-	£1,150.00



S line Sport seats

Options are subject to availability and may extend time taken for delivery.

- = Not available
- = Available
- S = Standard

*Total RRP inc VAT - Recommended Retail Price including VAT which is calculated at 20%. This may alter to reflect any change in the applicable VAT rate.

Upholstery and seats

S5 Super Sport seats

Choose your favourite upholstery from the swatches shown opposite to give your car's interior the look and feel you want.

S5 Super Sport seats come with integral head restraints, electrical adjustment of seat height, forwards and backwards position, backrest and seat angle. Also include electric 4-way lumbar support, extendable thigh supports and rear bench with integral centre storage tray.

Options are subject to availability and may extend time taken for delivery.

- = Not available
- = Available
- S = Standard

All the colour swatches on this page are matched as accurately as possible to the actual upholstery colours used. However, due to print processes, Audi UK cannot guarantee that colours shown are 100% accurate.

*Total RRP inc VAT - Recommended Retail Price including VAT which is calculated at 20%. This may alter to reflect any change in the applicable VAT rate.

Fine Nappa leather



Black/Black - ZM/SX

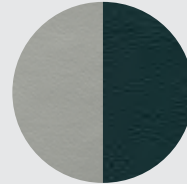

Lunar silver/Black - SU/SY



Magma red/Black - FA/SZ

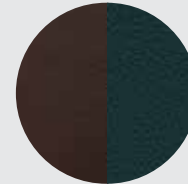

Chestnut brown/Black - SV/WY

SE	S line	Black Edition Plus	S5	S5 Black Edition	Total RRP inc VAT*
-	-	-	S	S	£0.00

Upholstery and seats

S5 Super Sport seats

Order Code		SE	S line	Black Edition Plus	S5	S5 Black Edition	Total RRP inc VAT*
4A4	Heated front and rear seats with 3-stage heating control	-	-	-	•	•	£200.00
PV3 6XL	Convenience package. Comprises electric front seats with memory function on driver's side and lumbar support. Also includes folding and auto-dimming door mirrors with memory function and automatic kerb view function, which tilts the passenger mirror downwards towards the kerb when reverse gear is engaged	-	-	-	•	•	£450.00



S5 Super Sport seat

Options are subject to availability and may extend time taken for delivery.

- = Not available
- = Available
- S = Standard

*Total RRP inc VAT - Recommended Retail Price including VAT which is calculated at 20%. This may alter to reflect any change in the applicable VAT rate.

Colour and trim guide

Interior trim colours

Standard seats

To help you choose the right interior for your new A5 Coupé, please use this guide, showing the carpet, dashboard and headlining colours that have been matched to your chosen upholstery. For pricing information please refer to pages 42-50. Please note that the inlay colour may change dependent on the interior colours you select – please see page 58 for details.

Order Code	Upholstery	Carpet	Dashboard (upper/lower)	Headlining	Milano leather (N5W)	Fine Nappa leather (N3Q)*
FZ	Black	Black	Black/Black	Silver	●	●
IE	Titanium grey	Grey	Grey/Grey	Silver	●	●
IF	Velvet beige	Brown	Brown/Brown	Beige	●	—
ID	Velvet beige	Black	Black/Black	Beige	●	—
VR	Chestnut brown	Black	Black/Black	Silver	—	●

Sport seats (PS1)

Order Code	Upholstery	Carpet	Dashboard (upper/lower)	Headlining	Leather/Alcantara (N7U)	Milano leather (N5W)	Fine Nappa leather (N3Q)*
FZ	Black	Black	Black/Black	Silver	●	●	●
IE	Titanium grey	Grey	Grey/Grey	Silver	●	●	●
IF	Velvet beige	Brown	Brown/Brown	Beige	—	●	●
ID	Velvet beige	Black	Black/Black	Beige	—	●	●
VR	Chestnut brown	Black	Black/Black	Silver	—	—	●

Options are subject to availability and may extend time taken for delivery.

— = Not available
● = Available

*Includes leather door armrests (7HB).

Colour and trim guide

Interior trim colours

Climate comfort seats (PS8)

Order Code	Upholstery	Carpet	Dashboard (upper/lower)	Headlining	Milano leather (NSW)
FZ	Black	Black	Black/Black	Black	●
IE	Titanium grey	Grey	Grey/Grey	Silver	●
IF	Velvet beige	Brown	Brown/Brown	Beige	●
ID	Velvet beige	Black	Black/Black	Beige	●
VR	Chestnut brown	Black	Black/Black	Silver	●

S line Sport seats

Order Code	Upholstery	Carpet	Dashboard (upper/lower)	Headlining	Leather/Alcantara (N7K)	Fine Nappa leather (N2R)*
QE	Black (with black stitching)	Black	Black/Black	Black	—	●
QZ	Black (with grey stitching)	Black	Black/Black	Black	●	—

S5 Super Sport seats

Order Code	Upholstery	Carpet	Dashboard	Headlining	Fine Nappa leather (N3M)*
ZM or SX	Black/Black	Black	Black	Black or Silver	●
FA or SZ	Magma red/Black	Black	Black	Black or Silver	●
SU or SY	Lunar silver/Black	Black	Black	Black or Silver	●
SV or WY	Chestnut brown/Black	Black	Black	Black or Silver	●

Options are subject to availability and may extend time taken for delivery.

— = Not available
● = Available

*Includes leather door armrests (7HB).

Upholstery

Audi exclusive

With Audi exclusive, you can specify your seats in Valcona leather or a leather/Alcantara combination, from an array of different colours shown to the right.

Select just an all-over shade for each seat or customise each panel in two or more complementary colours from the distinctive Audi exclusive palette. You can even choose the colour of the decorative stitching – to match or contrast with your chosen upholstery – from this varied collection. Whatever combination you decide upon, we think you'll be extremely satisfied with the result.

Options are subject to availability and may extend time taken for delivery.

- = Not available
- = Available

*Leather and stitching (where applicable) can be specified in a variety of colours from the Audi exclusive range.

All the colour swatches on this page are matched as accurately as possible to the actual upholstery colours used. However, due to print processes, Audi UK cannot guarantee that colours shown are 100% accurate.

*Total RRP inc VAT – Recommended Retail Price including VAT which is calculated at 20%. This may alter to reflect any change in the applicable VAT rate.

Order Code		SE	S line	Black Edition Plus	S5	S5 Black Edition	Total RRP inc VAT*
PYB S3G	Audi exclusive leather package 1 in Valcona leather. Includes leather-covered seat upholstery, door trim inserts and front centre armrest. Backrest covers and seat add-on parts come in the interior trim colour.* Only in combination with Sport seats (PS1)	•	•	•	•	•	£2,950.00
PYC S3G	Audi exclusive leather package 1 in Valcona leather/Alcantara. Includes leather-covered seat-side trims, head restraints, front centre armrest and Alcantara door trim inserts and seat-centre sections. Backrest covers and seat add-on parts come in the interior trim colour.* Only in combination with Sport seats (PS1)	•	•	•	•	•	£2,950.00
PYE S3G	Audi exclusive leather package 2 in Valcona leather. Includes all the contents of leather package 1 (PYB/S3G) plus: leather-covered seat backrest covers, door armrests and handles. Seat-side trims and add-on parts are colour-coordinated.* Only in combination with electric seats (PV1) or Convenience package (PV3)	•	•	•	•	•	£3,950.00



Chestnut brown



Jet grey



Alabaster white

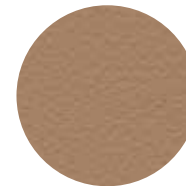

Sand beige

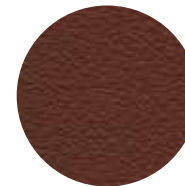

Saddle brown



Crimson red



Magnolia white



Havanna brown

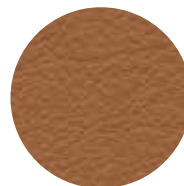

Cognac brown



Night blue



Cloudy grey

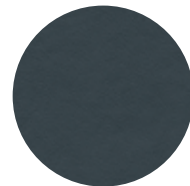

Smoky blue

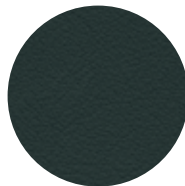

Iceland green



Powder beige

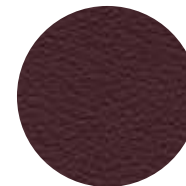

Classic red

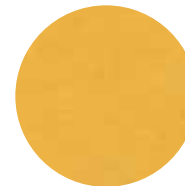

Calendula yellow

Also available:

Alcantara colours: available in all the Audi exclusive colours shown, except for Crimson red, Jet grey and Sand beige. Alcantara equivalents are Chilli red, Amethyst grey, and Sesame beige respectively.

Please consult your Audi Centre for examples of Alcantara and carpet colours.

Upholstery

Audi exclusive line

Audi exclusive is ultimately about choice – but if you'd rather leave some of the decisions in the capable hands of our designers, the expert team at quattro GmbH have compiled the Audi exclusive line, combining some of the most popular elements of the exclusive range in one, beautifully coordinated package.

Options are subject to availability and may extend time taken for delivery.

- = Not available
• = Available
S = Standard

*When ordered in combination with S line or Black Edition, Audi exclusive removes all S line interior badging.

**When ordered in combination with S line, the S line embossing on the seats is removed.

^Please note that when Audi exclusive line (PQL) is ordered in combination with Black Edition, the standard 3-spoke flat-bottomed leather steering wheel is replaced with a 3-spoke leather steering wheel (1XW/1XX).

*Total RRP inc VAT – Recommended Retail Price including VAT which is calculated at 20%. This may alter to reflect any change in the applicable VAT rate.

Order Code		SE	S line	Black Edition Plus	S5	S5 Black Edition	Total RRP inc VAT*
WQK	Audi exclusive line	•					£2,700.00
PQL	Audi exclusive line*		•	•			£850.00



Cloudy grey – UH



Cognac brown – QX



Alabaster white – UA

This package includes:

- ▶ Sport seats in two-tone Fine Nappa leather upholstery; black seat-side sections with coloured stitching and seat-centre sections in Cloudy grey, Cognac brown or Alabaster white**
- ▶ Door panels colour matched to seat-centre section
- ▶ Black dashboard and carpets
- ▶ Black cloth headlining
- ▶ Audi exclusive door sill trims on SE models
- ▶ For SE and S line, Matt-brushed aluminium inlays. For Black Edition, Piano finish black inlays
- ▶ Floor mats in black with coloured piping (to match seat-centre section)
- ▶ 3-spoke leather steering wheel (S tronic with gear-shift paddles)^
- ▶ Steering wheel rim and gear-lever gaiter with coloured stitching in matching colour to seat-centre section

Inlays

Attention to detail can make a big impact. From contemporary black Piano finish to a brown walnut, our selection of inlays offers the perfect finishing touch to your car's interior.





Inlays

Inlays are the all-important finishing touch that add flair and interest to your car's interior.

Order Code		SE	S line	Black Edition Plus	S5	S5 Black Edition	Total RRP inc VAT*
5MU	Aluminium trigon	S	-	-	-	-	£0.00
5TG	Matt-brushed aluminium	-	S	-	S	-	£0.00
5TL	Piano finish, black	-	●	S	●	S	£0.00
5MK	Carbon atlas	-	-	-	●	●	£255.00
5MG	Walnut, brown	●	-	-	-	-	£330.00
7TL	Fine grain ash, natural brown	●	-	-	-	-	£330.00
5TZ	Fine grain birch wood, grey	-	●	●	●	●	£330.00
5MZ	Stainless steel mesh (centre console comes in Piano finish, black)	-	-	-	●	●	£365.00
5MT	Beaufort oak, light brown	●	-	-	-	-	£450.00
5TB	Aluminium, beaufort	-	●	●	●	●	£950.00

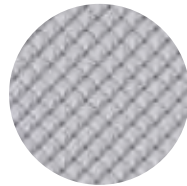

Aluminium trigon – **5MU**

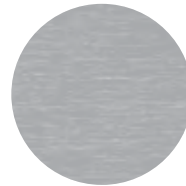

Matt-brushed aluminium – **5TG**

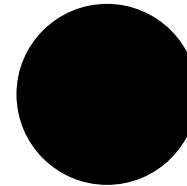

Piano finish, black – **5TL**

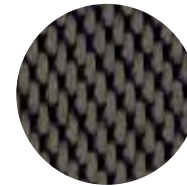

Carbon atlas – **5MK**



Walnut, brown – **5MG**



Fine grain ash, natural brown – **7TL**



Fine grain birch wood, grey – **5TZ**

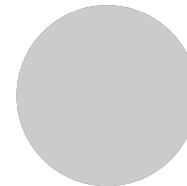

Stainless steel mesh (centre console comes in Piano finish, black) – **5MZ**

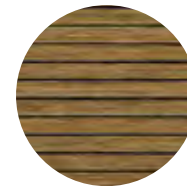

Beaufort oak, light brown – **5MT**



Aluminium, beaufort – **5TB**

Options are subject to availability and may extend time taken for delivery.

- = Not available
- = Available
- S = Standard

All the inlay swatches on this page are matched as accurately as possible to the actual inlay colours used. However, due to print processes, Audi UK cannot guarantee that colours shown are 100% accurate.

*Total RRP inc VAT – Recommended Retail Price including VAT which is calculated at 20%. This may alter to reflect any change in the applicable VAT rate.

Inlays

Audi exclusive

Audi exclusive offers an alternative range of materials from which you can select for your inlays, from Sepia oak to Fine grain myrtle.

Options are subject to availability and may extend time taken for delivery.

- = Not available
- = Available
- S = Standard

All the inlay swatches on this page are matched as accurately as possible to the actual inlay colours used. However, due to print processes, Audi UK cannot guarantee that colours shown are 100% accurate.

*Total RRP inc VAT - Recommended Retail Price including VAT which is calculated at 20%. This may alter to reflect any change in the applicable VAT rate.

Order Code		SE	S line	Black Edition Plus	S5	S5 Black Edition	Total RRP inc VAT*
YTA S3G	Audi exclusive inlays (cannot be combined with the inlays shown on page 58)	•	•		•	•	£950.00



Fine grain ash, nougat



Fine grain myrtle, nutmeg



Oak, sepia

Options

Every driver has different needs, which is why we have developed some useful options to further enhance your car. For extra comfort, support, style or function, you can choose from a variety of additional features, tailoring everything from your infotainment and audio equipment to your wheels and lighting.





Wheels, tyres and suspension

Choose a set of specially selected alloy wheels to subtly enhance the way your car looks. And you can also specify Audi Drive Select, which allows you to change suspension and steering settings according to your driving style.

Please note that choosing an optional wheel may affect fuel consumption figures and the CO₂ emissions of your A5 Coupe. This may result in a change in the subsequent Vehicle Excise Duty payable. Please see pages 83, 85, 86 and 90 for more details.

Options are subject to availability and may extend time taken for delivery.

- = Not available
• = Available
S = Standard

All alloy wheel images are matched as accurately as possible to the actual colour. However, due to print processes, Audi UK cannot guarantee that the colours shown are 100% accurate

*Not available on the 2.0 TDI ultra 163PS.



18" x 8.5J '15-spoke Star' design alloy wheels - PRR



18" x 8.5J '5 V-spoke' design alloy wheels - PRM



19" x 8.5J '10-spoke' design alloy wheels - PRK



19" x 8.5J '5-spoke Y' design alloy wheels - PRV



19" x 9J '7-twin-spoke' design alloy wheels - PQ7



19" x 9J '5-arm Rotor' design titanium-finish alloy wheels - PQT



20" x 9J '5-double-spoke' aluminium design alloy wheels - PQQ

Wheels, tyres and suspension

Order Code		SE	S line	Black Edition Plus	S5	S5 Black Edition	Total RRP inc VAT*
PRR	18" x 8.5J '15-spoke Star' design alloy wheels with 245/40 R18 Y tyres*	●	-	-	-	-	£665.00
PRM	18" x 8.5J '5 V-spoke' design alloy wheels with 245/40 R18 tyres*	●	-	-	-	-	£665.00
PRK	19" x 8.5J '10-spoke' design alloy wheels with 255/35 R19 tyres*	●	-	-	-	-	£1,350.00
PRV	19" x 8.5J '5-spoke Y' design alloy wheels with 255/35 R19 Y tyres*	●	-	-	-	-	£1,330.00
		-	●	-	-	-	£600.00
PQ7	19" x 9J '7-twin-spoke' design alloy wheels with 255/35 R19 tyres*	-	-	●	-	●	£0.00
		-	-	-	●	-	£1,000.00
PQT	19" x 9J '5-arm Rotor' design alloy wheels with 255/35 R19 tyres	-	-	●	-	S	£0.00
		-	-	-	-	●	£550.00
PQQ	20" x 9J '5-double-spoke' design alloy wheels with 265/30 R20 tyres	-	-	-	●	-	£1,500.00

Please note that choosing an optional wheel may affect fuel consumption figures and the CO2 emissions of your A5 Coupe. This may result in a change in the subsequent Vehicle Excise Duty payable. Please see pages 83, 85, 86 and 90 for more details.

Options are subject to availability and may extend time taken for delivery.

- = Not available
● = Available
S = Standard

*Not available on the 2.0 TDI ultra 163PS.

*Total RRP inc VAT - Recommended Retail Price including VAT which is calculated at 20%. This may alter to reflect any change in the applicable VAT rate.

Wheels, tyres and suspension

Order Code		SE	S line	Black Edition Plus	S5	S5 Black Edition	Total RRP inc VAT*
1BE	Sport suspension. With stiffer spring settings and shock absorbers	●	S	S	—	—	£315.00
1BV	S line Sport suspension. Lowered by 30mm with more firmly tuned springs and dampers for more direct contact with the road	—	●	●	—	—	£0.00
2H1	Audi Drive Select. Changes your car's handling and responses at the touch of a button to suit the way you want to drive. There are five modes: comfort, dynamic, auto, individual and efficient. Please note that you can only choose the 'individual' mode and customise your settings if you also have Satellite Navigation installed. When operating in efficiency mode, the engine and gear shift programmes are altered to optimise fuel consumption. The air-conditioning system is also configured to allow for optimum energy use	●	●	●	●	●	£220.00
1N8	Dynamic steering. With this technology, driving is significantly more agile under everyday conditions, while directional stability is increased at high speeds and in demanding driving situations. Must be combined with Audi Drive Select (2H1)	●	●	●	●	●	£375.00
1BL	Damper control. Formed on the basis of lowered Sport suspension, the optional damper control system fine-tunes suspension settings according to road conditions and driver needs. Must be combined with Audi Drive Select (2H1)	●	—	—	—	—	£680.00
GH2	Audi quattro Sport differential. Must be combined with Audi Drive Select (2H1). Only available on 3.0 TDI 245PS and S5 models	—	●	●	●	●	£300.00
							£620.00

Options are subject to availability and may extend time taken for delivery.

— = Not available
● = Available
S = Standard

*Total RRP inc VAT – Recommended Retail Price including VAT which is calculated at 20%. This may alter to reflect any change in the applicable VAT rate.



Packages

Some items work well together, which is why we've created these special packages.

Vehicle driver assistance and safety systems are not a substitute for attentive driving. Drivers retain full responsibility for providing the necessary inputs for safe control of the vehicle. System descriptions within this brochure are provided for information purposes only. System limitations and operational requirements apply. See manual for details.

Order Code	SE	S line	Black Edition Plus	S5	S5 Black Edition	Total RRP inc VAT*
WB6	●	—	—	●	—	£1,695.00
	—	—	—	—	●	£1,440.00

Technology package

Featuring MMI Navigation system – HDD-based with Audi Music Interface and Audi parking system advanced
MMI Navigation system plus. Hard disk navigation with topographical map display, places of interest and town models in 3D, with high-resolution 7" colour TFT display. The system offers three alternative routes, with the ability to scroll along the selected route and manoeuvre within the map. Uses 7-digit postcode recognition. Includes split-screen mode for route information, dynamic route guidance (TMC), intersection zoom function, motorway exits and lane recommendations in Driver's Information System (DIS). Includes 2 SD card readers, single CD/DVD player, 40GB hard drive and Jukebox (20GB) for storing and managing music files in WMA and MP3 format. Includes European navigation data (where digitised)

Additional functionality is available when combined with optional Mobile telephone preparation – High with Audi Connect (9ZW). For more details please see option 9ZW, featured in the options section of the guide

Audi Music Interface. Connection for use with stereo audio sources, USB and MP3 devices including Apple iPod generation 4 onwards and Apple iPhone

Audi parking system advanced – aids parking by acoustically and visually indicating distances to obstacles in front of and behind your A5 with guiding lines. Measured by ultrasonic sensors and camera integrated discreetly in the boot handle

Options are subject to availability and may extend time taken for delivery.

- = Not available
- = Available
- S = Standard

*Total RRP inc VAT – Recommended Retail Price including VAT which is calculated at 20%. This may alter to reflect any change in the applicable VAT rate.



MMI 3G – High, part of Satellite Navigation system – HDD-based

Packages

Vehicle driver assistance and safety systems are not a substitute for attentive driving. Drivers retain full responsibility for providing the necessary inputs for safe control of the vehicle. System descriptions within this brochure are provided for information purposes only. System limitations and operational requirements apply. See manual for details.

Order Code	SE	S line	Black Edition Plus	S5	S5 Black Edition	Total RRP inc VAT*
<p>Assistance package Contains Adaptive cruise control with braking guard and Audi side assist</p> <p>PCF Adaptive cruise control with braking guard. Intelligent automatic speed and distance control system. Works at speeds from 19-155mph,* using radar sensors to measure and maintain required distance to vehicle ahead by braking and accelerating. Four programs (distance 1 to distance 4) set via steering column controls of the cruise control system. Includes Audi braking guard – a system which triggers a visual and acoustic alarm when it detects the risk of a rear end collision with the vehicle in front. At speeds below 19mph the system can initiate partial braking or full deceleration if a potential impact is detected, or if it is not possible to completely prevent a collision, the system will focus on reducing the speed at which the vehicles collide</p> <p>Audi side assist. Aids the driver when changing lane. Audi side assist monitors the area behind the car using radar sensors located discreetly in the rear bumper, informing the driver with a visual warning signal in the door mirror if there is a vehicle in their blind spot or approaching quickly from behind. Only available in combination with the Technology package (WB6) or Satellite Navigation</p>	•	•	•	•	•	£625.00

Options are subject to availability and may extend time taken for delivery.

- = Not available
- = Available
- S = Standard

*Where the law permits.

*Total RRP inc VAT – Recommended Retail Price including VAT which is calculated at 20%. This may alter to reflect any change in the applicable VAT rate.

Audio and communication

Stay in touch using our range of communication functions, and give each journey its own soundtrack with our advanced audio equipment.

Order Code		SE	S line	Black Edition Plus	S5	S5 Black Edition	Total RRP inc VAT*
8UM	Symphony radio. AM/FM twin tuner with TP memo function. Front-loading 6-CD changer with MP3 compatibility and active front and rear speakers. Includes colour centre console screen, SD memory-card reader and AUX-IN socket. Cannot be combined with the Technology package (WB6)	●	—	—	●	●	£280.00
9VK	Bang & Olufsen sound system. Designed specifically for the Audi A5 Coupé, featuring 14 high-performance speakers and two amplifiers which create 505 watts of stunning sound, balanced to suit the specific acoustic properties of the car's interior. The system constantly and automatically adapts the sound characteristics to the vehicle's speed and background noise providing the highest level quality. The reproduction of 5.1 surround sound is possible in combination with Technology package (WB6) or Satellite Navigation	●	●	S	●	S	£535.00

Options are subject to availability and may extend time taken for delivery.

- = Not available
- = Available
- S = Standard

*Total RRP inc VAT – Recommended Retail Price including VAT which is calculated at 20%. This may alter to reflect any change in the applicable VAT rate.



Audio and communication

Order Code		SE	S line	Black Edition Plus	S5	S5 Black Edition	Total RRP inc VAT*
PT5	Mobile telephone preparation – Low with Bluetooth and voice control. Provides hands-free connection via Bluetooth using mobile phone aerial. Alternatively, it can use a cradle with charging facility for optimal reception via external aerial. Located in front centre armrest. Cradle available at extra cost – please contact your Audi Centre for mobile phone and software version compatibility or audi.co.uk/phonecompatibility	●	●	●	–	–	£175.00
9ZW	Mobile telephone preparation – High with Audi Connect. Audi Connect provides access to a number of innovative online services via an internal UMTS (3G) module. Audi Connect online services include: navigation using Google Earth™ images and Google Street View™, destination entry via Google Maps™ or myAudi, online point of interest search and information services such as weather forecasts and the latest world news. Audi Connect also includes Audi traffic information online, which gives accurate real-time forecasts of the traffic situation along the chosen route. The traffic situation can be displayed on the navigation map or Google Earth™ image. Audi Connect can also create a Wi-Fi hotspot in the car for convenient internet access using a mobile device (e.g. laptop or tablet). Many Audi Connect features can be simply operated via MMI Navigation Plus, the multi-function steering wheel or the voice control system. Only in combination with Technology package (WB6) or Satellite Navigation Important connectivity information: An external data source is required to enable the Audi Connect online services. Please refer to the detailed information on Audi Connect compatibility and data source requirements which can be found on page 90	●	●	●	●	●	£350.00
UF7	Audi Music Interface (AMI). Universal connection for use with stereo audio sources, USB and MP3 devices including Apple iPod generation 4 onwards (iPod, iPod classic, iPod mini, iPod nano, iPod photo, iPod video, iPod Touch). Provides intuitive control through the audio system and multi-function steering wheel (where fitted). It also replicates the iPod display on the audio screen and DIS, including track titles. The interface provides charging function (dependent on device and cable). Includes 2 cables to connect your iPod or USB MP3 device	●	●	S	●	S	£255.00
7D1	CD changer and DVD player. 6-CD changer located in the glove box and single CD/DVD slot in centre console. Only in combination with Technology package (WB6) or Satellite Navigation	●	●	●	●	●	£305.00
QU6	Digital TV reception. Reception of digital (DVB-T) uncoded television stations (MPEG-2 standard), TV picture, teletext and Electronic Programme Guide (EPG). Facility to connect 2 external AV sources via adaptor cables (available from Audi Genuine Accessories). Please note: TV reception depends on local digital network availability. No AV or TV video output when driving (audio output available when driving). Only in combination with Technology package (WB6) or Satellite Navigation	●	●	●	●	●	£825.00

Options are subject to availability and may extend time taken for delivery.

- = Not available
- = Available
- S = Standard

*Total RRP inc VAT – Recommended Retail Price including VAT which is calculated at 20%. This may alter to reflect any change in the applicable VAT rate.

Interior equipment

Specify every detail of your car's interior with this range of options.

Vehicle driver assistance and safety systems are not a substitute for attentive driving. Drivers retain full responsibility for providing the necessary inputs for safe control of the vehicle. System descriptions within this brochure are provided for information purposes only. System limitations and operational requirements apply. See manual for details.

Options are subject to availability and may extend time taken for delivery.

- = Not available
- = Available
- S = Standard

*HomeLink® is a registered trademark of Johnson Controls. For information on compatibility, visit homelink.com

**Where the law permits.

*Total RRP inc VAT – Recommended Retail Price including VAT which is calculated at 20%. This may alter to reflect any change in the applicable VAT rate.

Order Code		SE	S line	Black Edition Plus	S5	S5 Black Edition	Total RRP inc VAT*
PG3	Advanced key. Access and authorisation system which automatically exchanges data between key and vehicle, allowing the driver to keep the key in their pocket or bag at all times. To unlock and open, simply lift the exterior door handle. To lock, press the button on the handle. Pressing the start/stop button integrated in the centre console starts and stops the engine	•	•	•	•	•	£470.00
BT4	Adaptive cruise control (ACC) with braking guard. Intelligent automatic speed and distance control system. Works at speeds from 19-155mph,** using radar sensors to measure and maintain required distance to vehicle ahead by braking and accelerating. Four programmes (distance 1 to distance 4) set via steering column controls of the cruise control system. Includes Audi braking guard – a system which triggers a visual and acoustic alarm when it detects the risk of a rear end collision with the vehicle in front. At speeds below 19mph the system can initiate partial braking or full deceleration if a potential impact is detected, or if it is not possible to prevent a collision, the system will focus on reducing the speed at which the vehicles collide	•	•	•	•	•	£900.00
VC1	Garage door opener (HomeLink®*). Programmable radio-operated remote control for compatible doors/gates. Control buttons integrated in the front roof module	•	•	•	•	•	£180.00
QQ1	Interior light package. Includes front and rear footwell lighting, active door reflectors, illuminated vanity mirrors, rear reading lights, entrance lights and illuminated glove compartment, vents and internal door controls	•	•	•	S	S	£150.00



Advanced key

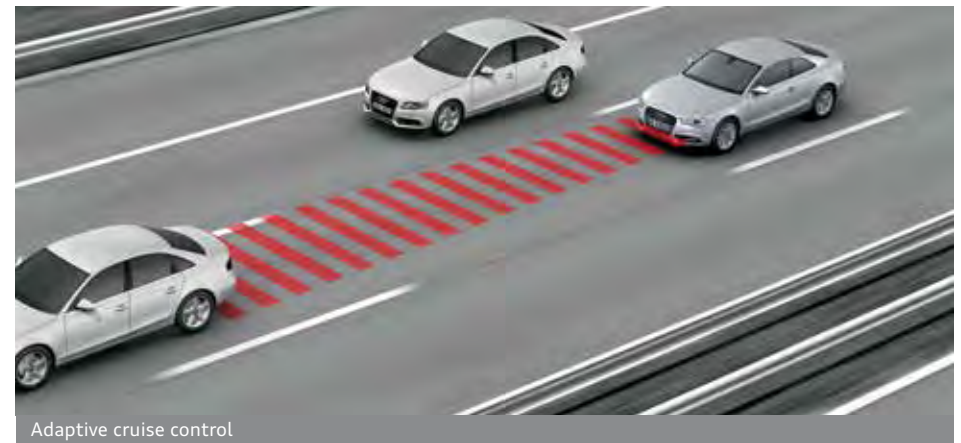

Adaptive cruise control

Interior equipment

Options are subject to availability and may extend time taken for delivery.

- = Not available
 ● = Available
 S = Standard

*The stitching and leather piping (where applicable) can be selected from any of the Audi exclusive colours shown on page 54. The carpet colour can also be selected from any of the Audi exclusive colours shown on page 54.

**Not in combination with Audi exclusive line (PQL/WQK).

*Total RRP inc VAT – Recommended Retail Price including VAT which is calculated at 20%. This may alter to reflect any change in the applicable VAT rate.

Order Code		SE	S line	Black Edition Plus	S5	S5 Black Edition	Total RRP inc VAT*
PKH QE1	Storage package. Comprises storage nets on front-seat backrests, storage compartment under the front seats (if memory function is fitted, only under the front-passenger seat), drinks holder in the rear centre armrest and a lockable glove compartment. Also includes tie-down straps and 12V socket in the boot	●	●	●	●	●	£180.00
3X2	Through-load facility. Includes removable ski bag for transporting long objects	●	●	●	S	S	£165.00
6NQ	Cloth headlining – black. Only in combination with interior colours black (FZ), Chestnut brown (VR) or Velvet beige (ID)	●	S	S	S	S	£205.00
7HB	Leather armrests	●	S	S	S	S	£205.00
3Y2	Rear window blind. Electric	●	●	●	●	●	£230.00
YSR S3G	Audi exclusive floor mats with leather piping.* Includes 4 floor mats for front and rear (cannot be combined with option YSQ/S3G – Audi exclusive carpets)	●	●	●	●	●	£450.00
YSQ S3G	Audi exclusive carpets.* Includes 4 Audi exclusive floor mats with leather piping (cannot be combined with option YSR/S3G – Audi exclusive floor mats)	●	●	●	●	●	£975.00
6Q6	Audi exclusive aluminum gear knob. Manual gearboxes only. Not available in combination with interior code IE or IF**	●	●	●	–	–	£150.00



Through-load facility with removable ski bag



Storage package

Exterior equipment

Make sure your car looks exactly as you want it to by selecting some of our striking options.

Options are subject to availability and may extend time taken for delivery.

- = Not available
 ● = Available
 S = Standard

*Additional wiring is required for auxiliary equipment.

*Total RRP inc VAT - Recommended Retail Price including VAT which is calculated at 20%. This may alter to reflect any change in the applicable VAT rate..

Order Code		SE	S line	Black Edition Plus	S5	S5 Black Edition	Total RRP inc VAT*
8N7	High-beam assist. Automatically adjusts headlights from high-beam to dipped-beam when another vehicle is approaching	●	●	●	●	●	£110.00
8Q5	Adaptive lights. Swivelling headlights for improved illumination of winding roads	-	●	●	●	●	£330.00
PX1 8Q5	Adaptive headlights. Swivelling headlights for improved illumination of a winding road. Includes Xenon Plus headlights with LED daytime-running lights, headlight washers and LED rear lamps	●	-	-	-	-	£1,130.00
4ZD	Black styling package. Includes radiator grille frame and radiator grille struts in high-gloss black, fog light surrounds in the side ventilation grille in high-gloss black, radiator grille in matt black, front side grilles in matt black, number plate holder in matt black, window capping strips and side-profile roof-trim strip in high-gloss black	●	●	S	●	S	£465.00
2Z7	Deletion of engine technology designation at rear	●	●	●	-	-	£0.00
2Z0	Deletion of model and engine technology designation at rear	●	●	●	-	-	£0.00
6XE	Door mirrors – heated and electrically folding. Includes automatic kerb view function, which tilts the passenger mirror downwards towards the kerb when reverse gear is engaged	●	●	●	●	●	£180.00
6XK	Door mirrors – electrically folding and auto-dimming. Includes automatic kerb view function, which tilts the passenger mirror downwards towards the kerb when reverse gear is engaged	●	●	●	●	●	£290.00
3FC	Electric tilt panoramic glass sun roof	●	●	●	●	●	£870.00
VW1	Privacy glass. Dark tinted glass from B-pillar backwards	●	●	S	●	S	£330.00
1D2	Towing equipment – removable. Includes single European 13-pin electrics socket and may require a 13- to 7-pin adaptor. Please consult your Audi Centre for details*	●	●	●	-	-	£665.00

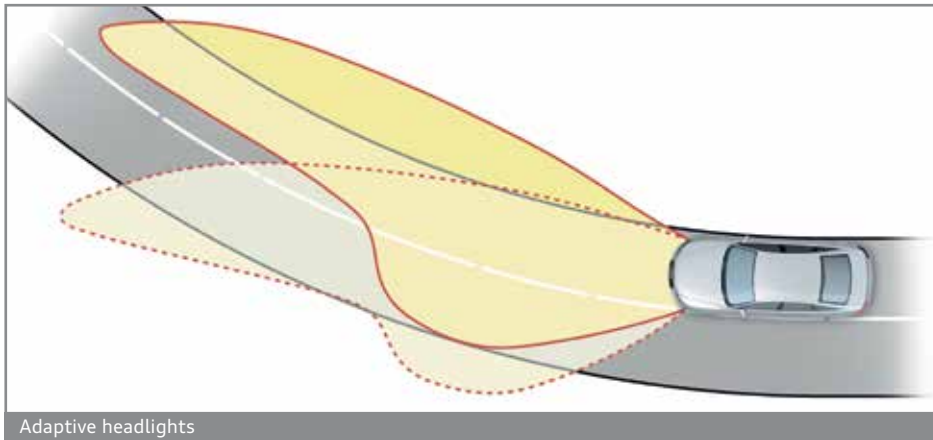

Adaptive headlights



Xenon Plus headlights

Safety and security

Technology designed to give you better all-round awareness and safety on the road.

Vehicle driver assistance and safety systems are not a substitute for attentive driving. Drivers retain full responsibility for providing the necessary inputs for safe control of the vehicle. System descriptions within this brochure are provided for information purposes only. System limitations and operational requirements apply. See manual for details.

Options are subject to availability and may extend time taken for delivery.

- = Not available
- = Available
- S = Standard

*Total RRP inc VAT - Recommended Retail Price including VAT which is calculated at 20%. This may alter to reflect any change in the applicable VAT rate..

Order Code		SE	S line	Black Edition Plus	S5	S5 Black Edition	Total RRP inc VAT*
7X8	Audi parking system advanced. Aids parking by acoustically and visually indicating distances to obstacles with guiding lines. Measured by sensors and reversing camera. Only available as part of the Technology package (WB6) on SE, S5 and S5 Black Edition models	-	•	•	-	-	£340.00
7Y1	Audi side assist. Aids the driver when changing lane. Audi side assist monitors the area behind the car using radar sensors located discreetly in the rear bumper, informing the driver with a visual warning signal in the door mirror if there is a vehicle in their blind spot or approaching quickly from behind. The system is activated using a button in the driver's door	•	•	•	•	•	£440.00



Audi parking system advanced

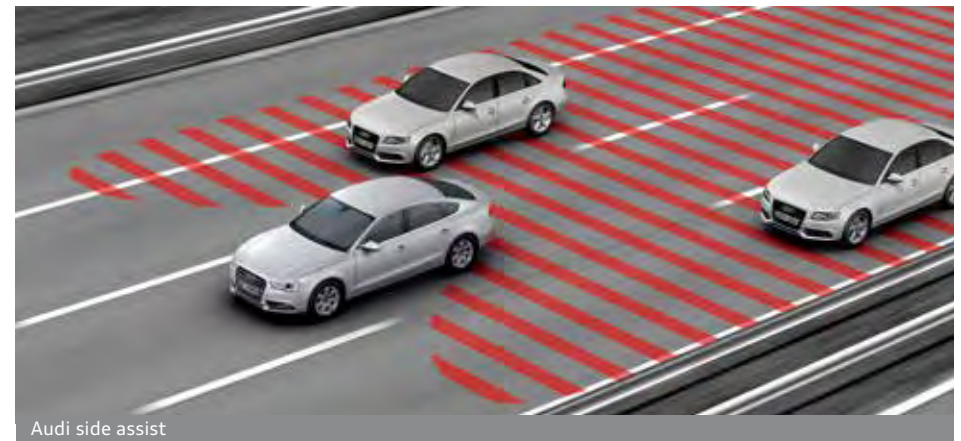

Audi side assist

Safety and security

Technology designed to give you better all-round awareness and safety on the road.

Vehicle driver assistance and safety systems are not a substitute for attentive driving. Drivers retain full responsibility for providing the necessary inputs for safe control of the vehicle. System descriptions within this brochure are provided for information purposes only. System limitations and operational requirements apply. See manual for details.

Options are subject to availability and may extend time taken for delivery.

- = Not available
- = Available
- S = Standard

*Total RRP inc VAT – Recommended Retail Price including VAT which is calculated at 20%. This may alter to reflect any change in the applicable VAT rate.

Order Code		SE	S line	Black Edition Plus	S5	S5 Black Edition	Total RRP inc VAT*
7Y4	Audi Active Lane Assist. Uses a discreet camera mounted at the top of the windscreen to monitor the road ahead. Assists the driver to stay in lane with gentle steering impulses. Informs driver if car is drifting out of lane unintentionally above 37mph. Choice of two settings: early steering intervention with continuous steering impulses to centre vehicle in lane, or late steering intervention which alerts driver that vehicle is potentially crossing lanes and applies corrective steering prompt	•	•	•	•	•	£370.00
UH2	Audi Hill-hold Assist. Uses either ESC or electromechanical parking brake to hold the vehicle stationary	•	•	•	•	•	£65.00

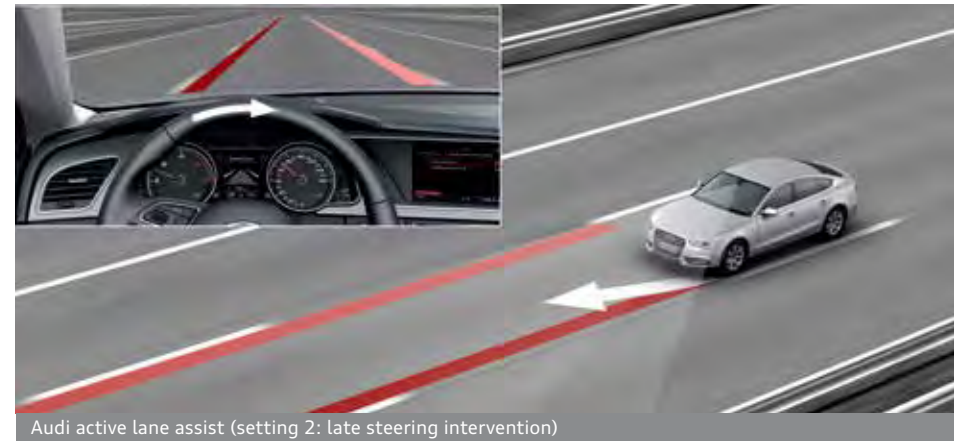
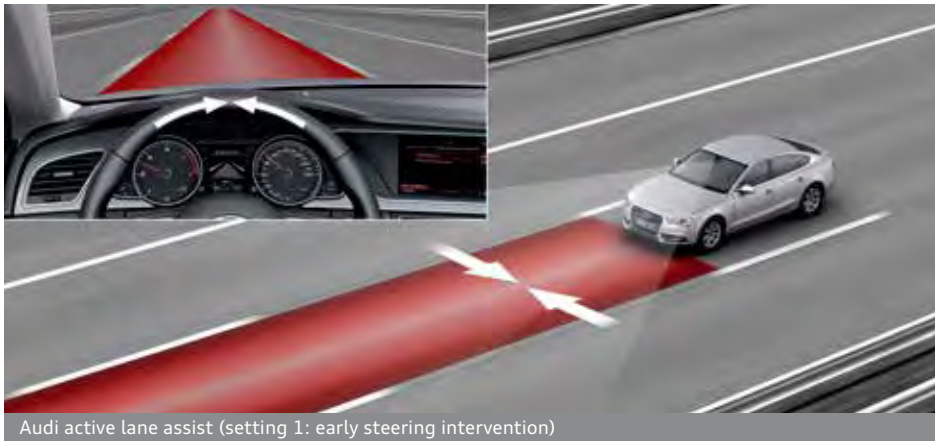

Steering wheels

You can choose from a selection of leather multi-function steering wheels, allowing you to control your audio system at the touch of a button.

Order Code		SE	S line	Black Edition Plus	S5	S5 Black Edition	Total RRP inc VAT*
2PF	3-spoke leather multi-function flat-bottomed steering wheel. Manual models only**	-	•	S	-	-	£100.00
2PK	3-spoke leather multi-function flat-bottomed steering wheel with gear-shift paddles. Automatic models only**	-	•	S	•	S	£100.00
YRB S3G	Audi exclusive controls pack. Includes leather-covered steering wheel and gear-shift gaiter*	•	•	•	•	•	£750.00

Options are subject to availability and may extend time taken for delivery.

- = Not available
- = Available
- S = Standard

*The leather and stitching (where applicable) can be selected from any of the exclusive colours shown on page 54.

**Not in combination with Audi exclusive line (PQL).

*Total RRP inc VAT - Recommended Retail Price including VAT which is calculated at 20%. This may alter to reflect any change in the applicable VAT rate.



Looking after your Audi

When you've chosen your ideal model, it's reassuring to know that it will remain in safe hands. That's why we've created products to protect your Audi, from extended warranties to Audi Complete – our comprehensive service and maintenance package. And there's also a range of Audi accessories and merchandise to choose from, enabling you to further enhance and safeguard your car.





Audi Complete

If you drive under 10,000 miles per annum your vehicle will be placed on a Fixed Inspection Service schedule. If your mileage tends to exceed 10,000 miles per annum it will be placed on the Flexible Service schedule.

Warranty

All new Audi models come with a three-year warranty as standard, and you can choose to extend this to a four or five-year warranty* for a one-off cost. What's more, if you decide to sell your Audi before the warranty expires, it will be fully transferred to the new owner. So, whichever length of warranty you choose, you can forget about unexpected repair bills and enjoy several years of carefree driving.

- = Not available
 ● = Available
 S = Standard

*Three-year warranty consists of a two-year unlimited mileage warranty and a third year warranty with a 60,000-mile limitation. Four-year warranty consists of a two-year unlimited mileage warranty and two further years' coverage with a 75,000-mile limitation. Five-year warranty consists of a two-year unlimited mileage warranty and three further years' coverage with a 90,000-mile limitation.

**Only available before registration of your Audi A5 Coupé. Please speak to your Audi Centre for full details.

*Total RRP inc VAT - Recommended Retail Price including VAT which is calculated at 20%. This may alter to reflect any change in the applicable VAT rate.

Audi Complete is our fixed-cost maintenance plan, which helps you keep your Audi in top condition and stay in control of your finances. For a simple monthly payment, you could cover your car's servicing, maintenance and, if you want, its tyres too.

So not only will you ensure your car runs smoothly, regular servicing can also protect its future resale value. And because everything's covered by one competitive price, there's no need to go anywhere else.

Pricing is completely tailored to your vehicle and takes into consideration the options you have on your vehicle and your likely annual mileage and resultant service schedule. Please speak to your Audi Centre for a personalised quote for Audi Complete.

Order Code		A5	S5	Total RRP inc VAT*
-	Audi Warranty , covering you for unlimited mileage in the first two years of ownership, and up to 60,000 miles in the third year. Transferable between owners**	S	S	£0.00
EA6	Audi Warranty , covering you for up to 4 years or 75,000 miles, whichever comes sooner. Cover includes a two-year unlimited mileage warranty, and up to 75,000 miles in the third and fourth years. Transferable between owners**	●	●	£535.00
EA9	Audi Warranty , covering you for up to 5 years or 90,000 miles, whichever comes sooner. Cover includes a two-year unlimited mileage warranty, and up to 90,000 miles in the third, fourth and fifth years. Transferable between owners**	●	●	£1,255.00



Accessories

Choosing an Audi isn't just a matter of deciding on the model you want; it's about creating a car that suits your needs perfectly. And that's why we've developed a whole range of optional accessories to enhance your A5 Coupé, enabling you to customise it down to the last detail. Like your Audi, all these accessories are developed to the highest possible standards. They're all available exclusively from Audi.

To find out more, just visit audi.co.uk/accessories or contact your local Audi Centre.

Warranty

All of the accessories available for the A5 Coupé are covered by a three-year warranty* if they are ordered and included in the purchase price of the car at date of delivery. Any accessories ordered and installed after delivery include a two-year warranty.*

*Excluding Road Angel products. Audi Accessories warranty terms and conditions can be found at audi.co.uk/warrantyterms



Merchandise

From the enthusiasts' motorsport collection to the sophisticated Audi collection, there's a wide variety of adults' and children's clothing, lifestyle accessories and collectables, all of which bear the Audi name.

Please speak to a member of our team at your local Audi Centre to see the full Audi collection and to place an order. A selection of Audi merchandise is also available to buy from audi.co.uk/merchandise



Image shown is the Audi kids' car legends, item number 320.13.004.00

The Audi Difference

The experts in Vorsprung durch Technik

Our Audi Approved Master Technicians have undergone an impressive 100,000 hours of training over a 10-year programme to ensure they have the latest technical expertise for maintaining and servicing your Audi. All our Service Advisors undergo a specialist induction and training to ensure they are Audi professionals and able to talk to you about any issues you may have with your Audi vehicle.

Servicing tailored to your needs

Regular servicing is key to safeguarding your Audi's performance and a full service history could help you enhance the future re-sale value. To make servicing easy, the Audi Service Schedules have been designed to work with your individual driving style and vehicle.

We offer two different schedules: the Fixed Inspection Service and the Flexible Service schedule. The conventional Fixed Inspection Service schedule has Fixed intervals for the Oil-change Service and Inspection Service, which are determined by time and distance.

With the Flexible Service schedule, the Inspection Service intervals are also fixed but the Oil-change Service intervals are variable. Sensors take account of driving style and conditions to determine when the Oil-change Service is required and the driver is informed via the on-board service interval display.

The choice of Service Schedule will depend on journey type and mileage as well as individual driving style and conditions. The table to the right can be used for guidance but your Audi Centre will help you to determine the most suitable Service schedule for you based on your individual circumstances and preferences.

Fixed Inspection Service Schedule

	Vehicle usage:
Mileage	Less than 10,000 miles per annum Mainly city/town centre driving. Short journeys.
	Service Intervals:
Oil-change Service	Fixed to every 9,000+ miles/1 year
Inspection Service	Fixed to every 19,000+ miles/2 years

Flexible Service Schedule

	Vehicle usage:
Mileage	More than 10,000 miles per annum Motorway and main road driving. Mainly longer distance journeys. Constant speeds.
	Service Intervals:
Oil-change Service	Variable to a maximum of every 19,000+ miles/2 years
Inspection Service	Fixed to every 19,000+ miles/2 years

When a vehicle is frequently used in the following conditions, we recommend a Fixed Inspection Service Schedule, regardless of mileage:

Uneconomical driving styles, e.g. heavy acceleration and braking, constant use of high revs

High engine-loading conditions, e.g. frequent towing and hill climbs

*As indicated by the service interval display. Mileages are approximate as the Service Indicator system uses kilometres as its distance measurement.

Your convenience comes first

At Audi you can choose from a range of convenient services that suit your needs. Why not book a 'service while you wait' appointment* and enjoy our complimentary refreshments while your car is with us? Or, if you need to be mobile, take advantage of one of our courtesy cars which we can even deliver to you.* We guarantee we can service your Audi within 5 days without a courtesy car or within 10 days if you need transport. We will also ensure your car is returned to you with a full valet.

Audi Genuine Parts

You can rest assured that only Audi Genuine Parts will be used on your vehicle. What's more, Audi parts and labour come with a 2-year guarantee.**

No hidden costs

We believe strongly in transparency when it comes to our prices. For added peace of mind, we will give you a quotation over the phone for the work you have requested and email you the price confirmation. We'll consult you if any additional work on your car is needed when it is with us. We won't carry out any extra work without asking your permission first.

All part of the service

Whenever we see an Audi for a service, we connect it directly to our headquarters in Ingolstadt which enables us to check your car's software and make sure it's as up-to-date as possible. If the factory has released a software upgrade for your model, it can be applied immediately - improving anything from your car's efficiency to the precision of its parking system.

Audi Roadside Assistance

Your new car comes complete with 3 years' complimentary roadside assistance and recovery across the UK, provided by Automobile Association Insurance Services Limited. Also included is roadside assistance throughout Europe, managed by Automobile Association Insurance Services Limited.

For further information and terms and conditions please visit audi.co.uk

*Subject to availability.

**Excludes wear and tear.



A5 Coupé

Petrol

technical data

Engine	1.8 TFSI	1.8 TFSI	2.0 TFSI quattro	2.0 TFSI quattro
Transmission	6-speed manual	multitronic	6-speed manual	7-speed S tronic
Cylinder	4-cylinder	4-cylinder	4-cylinder	4-cylinder
Displacement, cubic cm (valves per cylinder)	1798	1798	1984	1984
Max. power, ¹ PS at rpm	177/4000-6200	177/4000-6200	230/4700-6200	230/4700-6200
Max. torque, Nm at rpm	320/1400-3850	320/1400-3850	350/1500-4600	350/1500-4600
Top speed, mph	143	142	155 ⁺	155 ⁺
0-62mph acceleration, seconds	7.9	8.2	6.4	6.4
ABI insurance group* 1-50	TBC	TBC	TBC	TBC
Unladen weight, ² kg	1425	1455	1510	1540
Gross weight limit, kg	1925	1955	2010	2040
Roof load limit/nose weight, kg	75/80	75/80	75/80	75/80
Max trailer load unbraked, ³ kg	750	750	750	750
Max trailer load with 12% gradient, ³ kg	1500	1300	1700	1700
Max trailer load with 8% gradient, ³ kg	1700	1500	1900	1900
Luggage compartment capacity, rear seats upright, litres	455	455	455	455
Luggage compartment capacity, rear seats folded, litres	829	829	829	829
Fuel tank capacity approx, litres	63	63	61	61
Emission standard	EU6	EU6	EU6	EU6

⁺Electronically limited.

*Highest insurance group rating shown. Group may be lower dependent on trim level. Please visit thatcham.org/abigrouprating for details.

¹The given value was obtained in accordance with the specified measurement procedure (the respective current version of the Directive 80/1269/EEC).

²Vehicle's unladen weight without driver (calculated in accordance with the current version of Directive 80/1268/EEC). The fitting of additional equipment may increase the vehicle's unladen weight and drag coefficient, whereupon the potential carrying capacity and top speed will be correspondingly reduced.

³The engine's power output always goes down with increasing altitude. At 1,000m above sea level, and for every additional 1,000m, deduct 10% from the weight of the outfit (trailer load limit + gross weight of the towing vehicle).

Please note: The maximum power output figures are quoted in PS (or Pferdestärke, which is the metric equivalent of brake horsepower). To convert to brake horsepower, divide the PS figure by 1.0139.

A5 Coupé Petrol technical data

Depending upon your chosen A5 Coupe wheel size, different efficiency figures for CO₂ emissions and fuel consumption will apply (based on EU directive no. 715/2007 effective from 01/09/14). This table is a quick reference guide to assist you in finding the correct values based on wheels sizes and your chosen engine.

Engine		1.8 TFSI	1.8 TFSI	2.0 TFSI quattro	2.0 TFSI quattro
Transmission		6-speed manual	multitronic	6-speed manual	7-speed S tronic
Max. power, ¹ PS at rpm		177/4000-6200	177/4000-6200	230/4700-6200	230/4700-6200
CO ₂ emissions, ² g/km	17" wheels	128	132	149	153
	18" wheels	134	139	157	159
	19" wheels	142	144	161	166
Benefit in kind (BIK)%	17" wheels	20%	21%	24%	26%
	18" wheels	21%	22%	26%	26%
	19" wheels	23%	23%	27%	28%
Fuel consumption, ² mpg (l/100km) Urban	17" wheels	39.8 (7.1)	39.2 (7.2)	32.8 (8.6)	34.0 (8.3)
	18" wheels	38.7 (7.3)	38.2 (7.4)	31.7 (8.9)	32.5 (8.7)
	19" wheels	37.2 (7.6)	37.7 (7.5)	30.7 (9.2)	31.4 (9.0)
Fuel consumption, ² mpg (l/100km) Extra Urban	17" wheels	61.4 (4.6)	57.6 (4.9)	54.3 (5.2)	51.4 (5.5)
	18" wheels	57.6 (4.9)	54.3 (5.2)	50.4 (5.6)	47.9 (5.9)
	19" wheels	53.3 (5.3)	51.4 (5.5)	48.7 (5.8)	45.6 (6.2)
Fuel consumption, ² mpg (l/100km) Combined	17" wheels	51.4 (5.5)	49.6 (5.7)	44.1 (6.4)	42.8 (6.6)
	18" wheels	48.7 (5.8)	47.1 (6.0)	41.5 (6.8)	40.9 (6.9)
	19" wheels	46.3 (6.1)	45.6 (6.2)	40.4 (7.0)	39.2 (7.2)

¹The given value was obtained in accordance with the specified measurement procedure (the respective current version of the Directive 80/1269/EEC).

²Fuel consumption and CO₂ emissions figures are obtained under standardised test conditions (Directive 93/116/EEC) using a representative model. This allows direct comparison between different models from different manufacturers, but may not represent the actual fuel consumption achieved in 'real world' driving conditions. More information is available at dft.gov.uk/vca

Please note: The maximum power output figures are quoted in PS (or Pferdestärke, which is the metric equivalent of brake horsepower). To convert to brake horsepower, divide the PS figure by 1.0139.

A5 Coupé Diesel technical data

Engine	2.0 TDI ultra	2.0 TDI	2.0 TDI quattro	2.0 TDI	2.0 TDI quattro	3.0 TDI quattro
Transmission	6-speed manual	6-speed manual	6-speed manual	multitronic	7-speed S tronic	7-speed S tronic
Cylinder	4-cylinder	4-cylinder	4-cylinder	4-cylinder	4-cylinder	V6
Displacement, cubic cm (valves per cylinder)	1968	1968	1968	1968	1968	2967
Max. power, ¹ PS at rpm	163/3000-4200	190/3800-4200	190/3800-4200	190/3800-4200	190/3800-4200	245/4000-4500
Max. torque, Nm at rpm	400/1750-2750	400/1750-3000	400/1750-3000	400/1750-3000	400/1750-3000	580/1750-2500
Top speed, mph	140	149	146	143	146	155
0-62mph acceleration, seconds	8.3	7.7	7.4	7.8	7.3	5.8
ABI insurance group* 1-50	28E	TBC	TBC	TBC	TBC	TBC
Unladen weight, ² kg	1530	1525	1590	1560	1630	1695
Gross weight limit, kg	2030	2025	2090	2060	2130	2195
Roof load limit/nose weight, kg	75/80	75/80	75/80	75/80	75/80	75/80
Max trailer load unbraked, ³ kg	750	750	750	750	750	750
Max trailer load with 12% gradient, ³ kg	1300	1600	1600	1700	1700	1900
Max trailer load with 8% gradient, ³ kg	1500	1800	1800	1900	1900	2100
Luggage compartment capacity, rear seats upright, litres	455	455	455	455	455	455
Luggage compartment capacity, rear seats folded, litres	829	829	829	829	829	829
Fuel tank capacity approx, litres	63	63	61	63	61	61
AdBlue® tank ⁴ capacity approx, litres	20	20	20	20	20	20
Emission standard	EU6	EU6	EU6	EU6	EU6	EU6

⁴The addition of AdBlue® technology ensures compliance with EU6 emission standards. The use of AdBlue® will vary based on a number of conditions and the tank requires refilling when indicated on the instrument cluster.

*Electronically limited.

⁵Highest insurance group rating shown. Group may be lower dependent on trim level. Please visit thatcham.org/abigrouprating for details.

¹The given value was obtained in accordance with the specified measurement procedure (the respective current version of the Directive 80/1269/EEC).

²Vehicle's unladen weight without driver (calculated in accordance with the current version of Directive 80/1268/EEC). The fitting of additional equipment may increase the vehicle's unladen weight and drag coefficient, whereupon the potential carrying capacity and top speed will be correspondingly reduced.

³The engine's power output always goes down with increasing altitude. At 1,000m above sea level, and for every additional 1,000m, deduct 10% from the weight of the outfit (trailer load limit + gross weight of the towing vehicle).

Please note: The maximum power output figures are quoted in PS (or Pferdestärke, which is the metric equivalent of brake horsepower). To convert to brake horsepower, divide the PS figure by 1.0139.

A5 Coupé Diesel technical data

Depending upon your chosen A5 Coupé wheel size, different efficiency figures for CO₂ emissions and fuel consumption will apply (based on EU directive no. 715/2007 effective from 01/09/14). This table is a quick reference guide to assist you in finding the correct values based on wheels sizes and your chosen engine.

Engine		2.0 TDI ultra	2.0 TDI	2.0 TDI quattro	2.0 TDI	2.0 TDI quattro	3.0 TDI quattro
Transmission		6-speed manual	6-speed manual	6-speed manual	multitronic	7-speed S tronic	7-speed S tronic
Max. power, ¹ PS at rpm		163/3000-4200	190/3800-4200	190/3800-4200	190/3800-4200	190/3800-4200	245/4000-4500
CO ₂ emissions, ² g/km	17" wheels	109	117	128	119	132	-
	18" wheels	-	124	135	126	139	158
	19" wheels	-	129	140	131	144	162
Benefit in kind (BIK)%	17" wheels	19%	21%	23%	21%	24%	-
	18" wheels	-	22%	25%	23%	25%	29%
	19" wheels	-	23%	26%	24%	26%	30%
Fuel consumption, ² mpg (l/100km) Urban	17" wheels	56.5 (5.0)	52.3 (5.4)	47.9 (5.9)	53.3 (5.3)	47.9 (5.9)	-
	18" wheels	-	50.4 (5.6)	46.3 (6.1)	50.4 (5.6)	45.6 (6.2)	38.7 (7.3)
	19" wheels	-	48.7 (5.8)	45.6 (6.2)	49.6 (5.7)	44.8 (6.3)	38.2 (7.4)
Fuel consumption, ² mpg (l/100km) Extra Urban	17" wheels	74.3 (3.8)	72.4 (3.9)	64.2 (4.4)	68.9 (4.1)	62.8 (4.5)	-
	18" wheels	-	67.3 (4.2)	61.4 (4.6)	65.7 (4.3)	58.9 (4.8)	52.3 (5.4)
	19" wheels	-	64.2 (4.4)	58.9 (4.8)	62.8 (4.5)	56.5 (5.0)	50.4 (5.6)
Fuel consumption, ² mpg (l/100km) Combined	17" wheels	67.3 (4.2)	62.8 (4.5)	57.6 (4.9)	62.8 (4.5)	56.5 (5.0)	-
	18" wheels	-	60.1 (4.7)	54.3 (5.2)	58.9 (4.8)	53.3 (5.3)	46.3 (6.1)
	19" wheels	-	57.6 (4.9)	53.3 (5.3)	56.5 (5.0)	51.4 (5.5)	44.8 (6.3)

¹The given value was obtained in accordance with the specified measurement procedure (the respective current version of the Directive 80/1269/EEC).

²Fuel consumption and CO₂ emissions figures are obtained under standardised test conditions (Directive 93/116/EEC) using a representative model. This allows direct comparison between different models from different manufacturers, but may not represent the actual fuel consumption achieved in 'real world' driving conditions. More information is available at dft.gov.uk/vca

Please note: The maximum power output figures are quoted in PS (or Pferdestärke, which is the metric equivalent of brake horsepower). To convert to brake horsepower, divide the PS figure by 1.0139.

S5 Coupé quattro technical data

Depending upon your chosen S5 Coupé wheel size, different efficiency figures for CO₂ emissions and fuel consumption will apply (based on EU directive no. 715/2007 effective from 01/09/14). This table is a quick reference guide to assist you in finding the correct values based on wheels sizes and your chosen engine.

*Highest insurance group rating shown. Group may be lower dependent on trim level. Please visit thatcham.org/abigroupratings for details.

*Electronically limited.

¹The given value was obtained in accordance with the specified measurement procedure (the respective current version of the Directive 80/1269/EEC).

²Regulated.

³Fuel consumption and CO₂ emissions figures are obtained under standardised test conditions (Directive 93/116/EEC) using a representative model. This allows direct comparison between different models from different manufacturers, but may not represent the actual fuel consumption achieved in 'real world' driving conditions. More information is available at dft.gov.uk/vca

⁴Vehicle's unladen weight without driver (calculated in accordance with the current version of Directive 80/1268/EEC). The fitting of additional equipment may increase the vehicle's unladen weight and drag coefficient, whereupon the potential carrying capacity and top speed will be correspondingly reduced.

⁵The engine's power output always goes down with increasing altitude. At 1,000m above sea level, and for every additional 1,000m, deduct 10% from the weight output (trailer load unit + gross weight of the towing vehicle).

Please note: The maximum power output figures are quoted in PS (or Pferdestärke, which is the metric equivalent of brake horsepower). To convert to brake horsepower, divide the PS figure by 1.0139.

Engine	S5 Coupé quattro
Transmission	7-speed S tronic
Cylinder	V6
Displacement, cubic cm (valves per cylinder)	2995
Max. power, ¹ PS at rpm	333/5500-6500
Max. torque, Nm at rpm	440/2900-5300
Top speed, ² mph	155+
0-62mph acceleration, seconds	4.9
ABI insurance group 1-50*	42E
Unladen weight, ⁴ kg	1675
Gross weight limit, kg	2175
Roof load/nose weight, kg	75/80
Max trailer load unbraked, ⁵ kg	750
Max trailer load with 12% gradient, ⁵ kg	1900
Max trailer load with 8% gradient, ⁵ kg	2100
Luggage compartment capacity, rear seats upright, litres	455
Luggage compartment capacity, rear seats folded, litres	829
Fuel tank capacity approx, litres	61
Emission standard	EU6

Engine	S5 Coupé quattro	
Transmission	7-speed S tronic	
Max. power, ¹ PS at rpm	333/5500-6500	
CO ₂ emissions ³ , g/km	19" wheels	184
	20" wheels	184
Benefit in kind (BIK)%	19" wheels	31%
	20" wheels	31%
Fuel consumption ³ , mpg (l/100km) Urban	19" wheels	27.4 (10.3)
	20" wheels	27.4 (10.3)
Fuel consumption ³ , mpg (l/100km) Extra Urban	19" wheels	43.5 (6.5)
	20" wheels	43.5 (6.5)
Fuel consumption ³ , mpg (l/100km) Combined	19" wheels	35.8 (7.9)
	20" wheels	35.8 (7.9)

A5 Coupé dimensions

The technical drawings opposite show the exact dimensions of the Audi A5 Coupé, so you can check everything – from whether the car will fit in your garage to whether your luggage will fit in the boot.

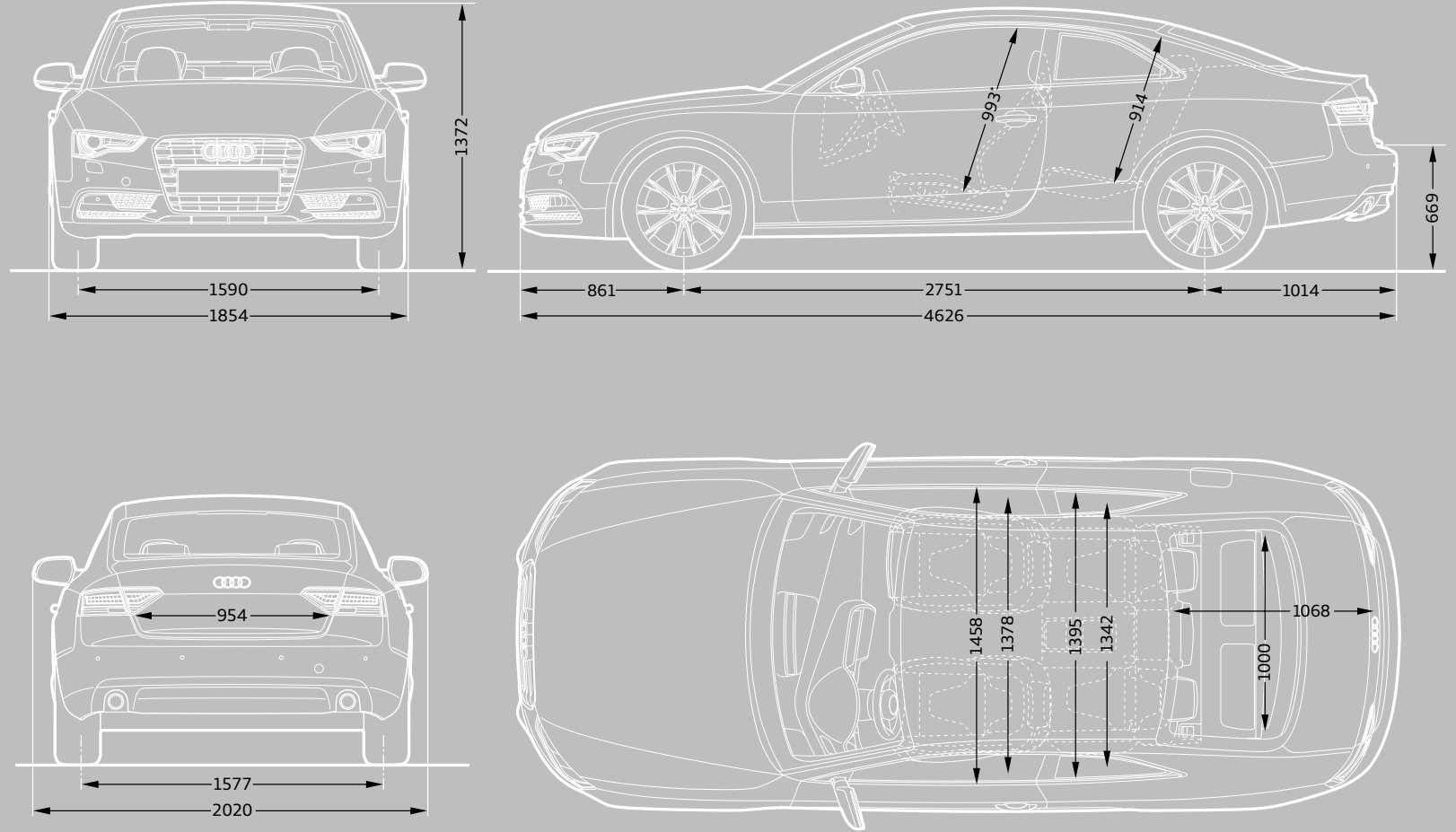

Dimensions in millimetres. Optional equipment may affect dimensions.

*Maximum headroom.

Dimensions measured with vehicle at unladen weight. Luggage compartment volume in litres: 455/829 (measured by the VDA standard test method using 200 x 100 x 50mm blocks; second value: with rear seat folded down). Turning circle approx 11.4m.

S5 Coupé quattro dimensions

The technical drawings opposite show the exact dimensions of the Audi S5 Coupé quattro, so you can check everything – from whether the car will fit in your garage to whether your luggage will fit in the boot.

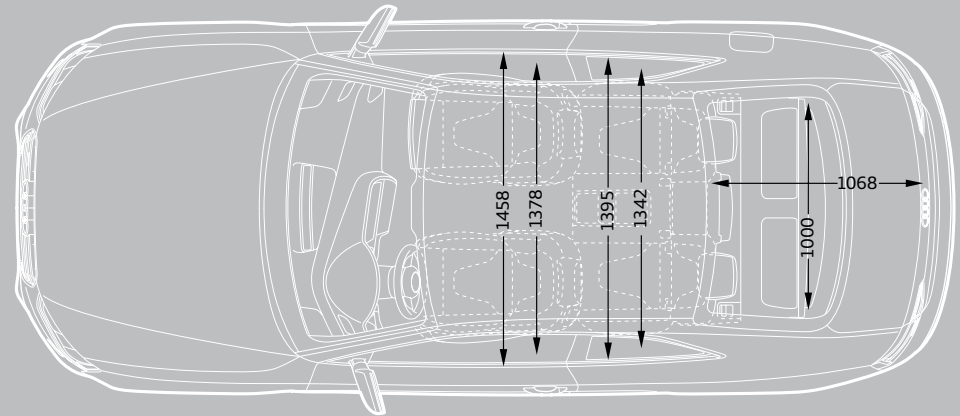
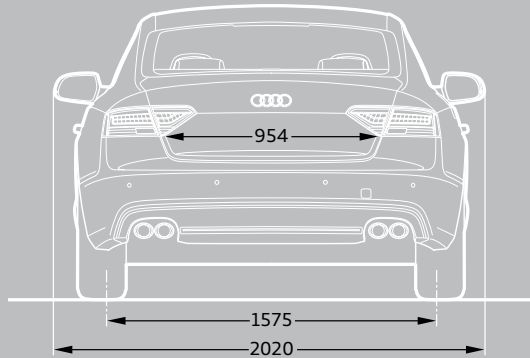
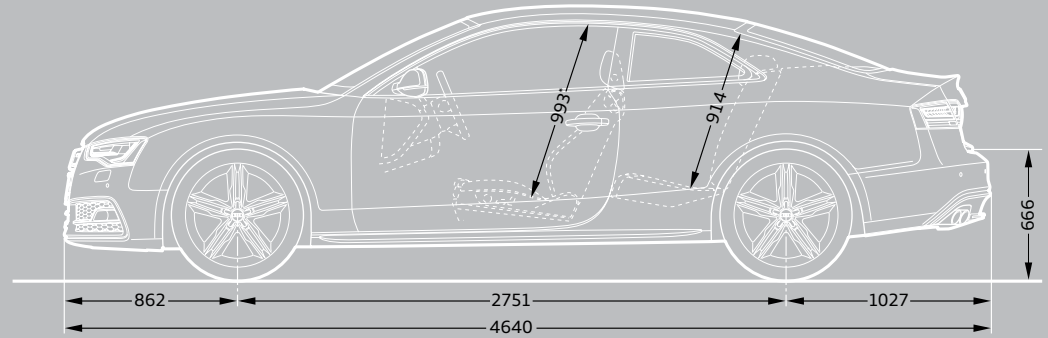
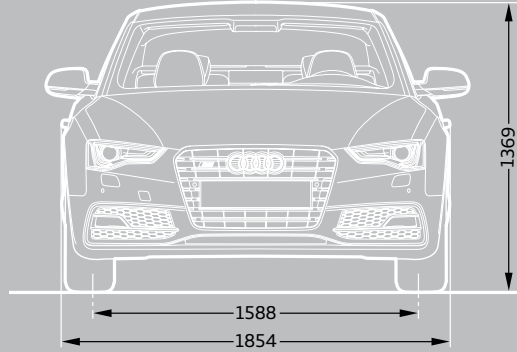

Dimensions in millimetres. Optional equipment may affect dimensions.

*Maximum headroom.

Dimensions measured with vehicle at unladen weight. Luggage compartment volume in litres: 455/829 (measured by the VDA standard test method using 200 x 100 x 50mm blocks; second value: with rear seat folded down). Turning circle approx 11.4m.

Pricing and Additional information

Welcome to Audi

By placing an order for your Audi, you're choosing to drive a car created in the spirit of Vorsprung durch Technik. And because we believe the service we offer should reflect the quality of our cars, we want to let you know exactly what you can expect from us, now and in the future.

Audi Promise

Audi Centres

We guarantee that all our Centres will be open as follows:

Sales: Monday to Friday 9am–6pm
Saturday 9am–5pm

Service: Monday to Friday 8am–6pm
Saturday 8.30am–1pm

Sunday opening is at local discretion.

New car delivery

Once we've confirmed a delivery date for your car, we'll keep you informed of progress. Subject to reasonable notice, we'll then deliver it to a place of your choice, whether that's your home or work. In the unlikely event of a delay, we'll provide a courtesy car to minimise inconvenience and keep you mobile.

Information in this guide

We've done all we can to make the prices, specifications, technical details and all other information you see in this guide accurate at the time of publication. However, as our products are constantly being updated, we recommend checking the details with your Audi Centre. We reserve the right to change prices or specifications at any time.

All prices are subject to VAT, currently charged at 20%, but this may alter to reflect any change in the applicable VAT rate.

Delivery charges and number plates are not included in the Total RRP inc VAT vehicle price.

Delivery charge	£504.99
Number plate	£20.00
VAT	£105.01
Total	£630.00

Recommended On-the-Road (OTR) prices include the delivery and number plate charges above, Road Fund Licence (which may vary depending on model/transmission - see table for details) and first registration fee at £55.00.

The images featured in this guide are for illustrative purposes only. They may feature left-hand drive vehicles and include equipment that is not UK specification.

Audi Customer Care

Every new Audi benefits from the comprehensive Audi Customer Care Package, which comprises:

- ▶ A 3-year Audi warranty, which covers you for unlimited mileage in the first 2 years of ownership, with a full mechanical and electrical warranty which covers you for up to 60,000 miles in the 3rd year
- ▶ A 3-year paint warranty
- ▶ A 12-year anti-corrosion warranty
- ▶ 3 years' UK roadside assistance and recovery

You also have the option when ordering your new car of choosing a 4-year or 5-year Audi warranty. Speak to a member of the sales team for more information.

Warranty terms and conditions apply. Please see audi.co.uk/warrantyterms for further details.

Audi tax-free sales

If you are entitled to purchase a vehicle free of VAT, normally through military or diplomatic privilege, please contact your local Audi Centre for full details.

Should you have any difficulty obtaining the information you require, please call 0870 241 5663.

Audi Financial Services

Audi Financial Services specialises in providing funding solutions for Audi drivers. Whether your Audi is for private or business use, there is a range of funding options to choose from.

Below is the full range of finance products, which comprises:

- ▶ Solutions – a Personal Contract Plan
- ▶ Hire purchase
- ▶ Lease purchase
- ▶ Finance lease
- ▶ Contract hire

With all products, you can choose a fixed-cost maintenance plan designed to help you budget accurately.

No matter which Audi model you choose, your local Audi Centre can provide you with a personalised quote designed to fit your budget and motoring needs.

Audi Financial Services is a trading name of Volkswagen Financial Services (UK) Limited. An offer of finance depends on certain conditions. Available to people over 18 in the UK only.

Audi Insurance

To ensure you can start enjoying your new car from day one, the first five days' insurance is included as standard with all new Audi models. To activate simply call 0330 303 6900, provide us with a few details, and we'll send a cover note to your Audi Centre. They will then tax your car and you can drive it away. Telephone lines are open Monday to Friday 8am – 8pm and Saturday 9am – 4pm. For details of our full range of Insurance products visit insurewithaudi.co.uk

Additional information

CO₂ data and information

CO₂ emissions-based Vehicle Excise Duty

Vehicle Excise Duty (Road Fund Licence) is based upon the amount of Carbon Dioxide (CO₂) a vehicle emits, measured in grams per kilometre (g/km). First year VED rates apply to the first year of ownership. Annual VED rates apply thereafter. The DVLA has created thirteen categories:

Petrol and Diesel engines	First year	Annual rate (second year onwards)
A – up to 100g/km	£0.00	£0.00
B – 101 to 110g/km	£0.00	£20.00
C – 111 to 120g/km	£0.00	£30.00
D – 121 to 130g/km	£0.00	£110.00
E – 131 to 140g/km	£130.00	£130.00
F – 141 to 150g/km	£145.00	£145.00
G – 151 to 165g/km	£180.00	£180.00
H – 166 to 175g/km	£295.00	£205.00
I – 176 to 185g/km	£350.00	£225.00
J – 186 to 200g/km	£490.00	£265.00
K – 201 to 225g/km	£640.00	£290.00
L – 226 to 255g/km	£870.00	£490.00
M – over 255g/km	£1,100.00	£505.00

Vehicle Excise Duty (VED) rates correct at time of going to print, but these may alter to reflect any change in the applicable VED rate.

Audi Connect

An external data source is required to enable Audi Connect online services. One of two can be used:

1. A Bluetooth compatible mobile telephone with remote SIM Access Profile (rSAP). For mobile phone and software compatibility please visit audi.co.uk/phonecompatibility or your Audi Centre.
2. A separate SIM card which can be inserted in the included SIM card reader. When a separate SIM card is used, hands-free phone calls are possible using the SIM card or by connecting a different mobile telephone via Bluetooth Hands-Free Profile. For mobile phone and software compatibility please visit audi.co.uk/phonecompatibility or your Audi Centre.

Online services will only be available within the coverage of the mobile phone network; there may be additional costs for the use of these services (charges and billing correspond to the personal mobile phone contract or SIM card contract). Due to high data volumes, a mobile phone contract including an unlimited or high usage data plan is strongly recommended. The content and scope of the online based services offered may vary.

When ordered as an option, a 36 month Audi Connect subscription is provided with your vehicle. The subscription runs from the point of vehicle delivery. Should you wish to continue to use Audi Connect after 36 months, please consult your Audi Centre for details (including the latest subscription fees).

Audi Connect services listed are correct at time of publication. We may add, change, replace or remove individual Audi Connect services or features at any time during your subscription.

Audi Connect enables access to the services of Google and Twitter. Permanent availability cannot be guaranteed as this is the responsibility of Google and Twitter. Google and the Google logo are registered trademarks of Google Inc.

The availability of services supported Audi Connect varies from country to country and is dependent on the capability of your mobile phone. For mobile phone and software compatibility please visit audi.co.uk/phonecompatibility or your Audi Centre.



Audi UK

Customer Services
Selectapost 29
Sheffield
S97 3FG
0800 699888
audi.co.uk

Information in this guide is
subject to change without notice.

© Audi UK

Printed in the UK
Edition 6.4 03/16
2016 model year

Images for illustrative purposes only.

