



The new Audi Q7

Pricing and Specification Guide
Valid from January 2016

Personalising your Audi Q7

This guide has been designed to help you tailor and price your Audi Q7 quickly and logically. At the back, you will find information on CO2 emissions-based taxation and services offered with your Audi, including Finance and Insurance. You can also configure your Audi Q7 online at audi.co.uk



Get more from this brochure with the free Audi Vision app.

Audi Vision brings our brochures to life through Augmented Reality. It works by recognising images on a page through your device's camera. Suitable for compatible phones or tablets, download it for free from the App Store or Google Play. Once downloaded, simply open the app and scan the cover of your guide. Then look out for any page with the Audi Vision logo, you can then hold your device over the page and watch as you get exclusive access to extra images, information and video content.



The images featured in this guide are for illustrative purposes only. They may feature left-hand drive vehicles and include equipment that is not UK specification.

The Audi Q7

Matrix LED headlights	10
quattro	12
Audi Virtual Cockpit	18
Audi Connect	20
Technology	22
Driver assistance	24

Model details and prices

SE model equipment	26
S line model equipment	30
Model prices	32

Colour and upholstery

Paint	34
Upholstery	38
Seat options	44
Colour and trim guide	45

Inlays

Options

Wheels and tyres suspension	50
Packages	54
Headlights	58
Audio and communication	59
Interior equipment	62
Exterior equipment	65
Safety and security	66
Steering wheels	67

Looking after your Audi

Audi Complete and Warranty	68
Accessories	71
Merchandise	72
Audi Difference	73

Technical details

Technical data	74
Dimensions	75
Pricing and Additional information	76

Vorsprung durch Technik

Three words that express the very essence of Audi – Vorsprung durch Technik. It's not just a slogan, it's our way of seeing the world and the driving force behind our history of innovation that continues into the 21st century. Indeed, many technologies that have become synonymous with Audi remain in our cars today. Some are milestones in the history of the motorcar. From our beginnings in 1899, to the Auto Union team's Grand Prix successes in the 1930s and our more recent wins at Le Mans, we have always been at the forefront of the motor industry.

Vorsprung durch Technik makes us who we are. To see more of its influence, just read on.

Please note the Audi Q7 featured in the images throughout this guide is in an Audi exclusive paint colour – Sepang blue, pearl effect.









The all-new Audi Q7. Lighter, more powerful and more agile than its predecessor

Our largest SUV has undergone some big changes. Sharper horizontal lines. Striking quattro sideblades. A redesigned 3D-hexagonal single-frame grille. Double arrow-shaped daytime-running lights. And, for the first time in a Q model, optional Audi Matrix LED headlights. Every element adding to the Q7's powerful, athletic appearance.

But while the all-new Audi Q7 has gained many new features, it's also lost weight – 240kg to be precise. It's more efficient, too, with CO₂ emissions starting from 148g/km.* And with quattro all-wheel-drive, Audi Drive Select and a choice of two enhanced 3.0 TDI engines – the 272PS variant capable of 0-62mph in just 6.5 seconds – the result is a drive that's incredibly agile and responsive.

Style, power and presence. All you could ask for in an SUV.

*Standard EU test figures for comparative purposes and may not reflect real driving results. Optional wheels may also affect emissions and fuel consumption figures.



Innovation. Intuition. Control.

As well as MMI Navigation, the all-new Audi Q7 comes with intelligent technology as standard to enhance your driving experience.

At a glance, the 8.3" retractable MMI screen displays everything you need to know, while the extra-large MMI touchpad makes it easier to 'write' your commands. Or, if you prefer, you can use the multi-function steering wheel and MMI button to control your car's systems.

While driving, Audi Drive Select lets you electronically adjust the engine, transmission and steering to adapt to road conditions, with up to seven driving modes. For extra reassurance, Hill descent control pre-defines your speed during any descent. And Pre-sense city can automatically apply braking when a collision looks imminent.

You can also choose options to add even more convenience. Like the fully customisable Audi Virtual Cockpit that brings the information you want to the fore. Or Audi Phone Box and Audi Connect, that keep you and your passengers' devices connected to the world.

Together, these technologies make any type of journey in the all-new Audi Q7 a comfortable and confident one.





A close-up, artistic photograph of a car's Matrix LED headlight assembly. The image shows the intricate details of the light housing, including the lens and internal components, with a soft, blue-tinted lighting effect. The text is overlaid on this background.

Matrix LED lights

**Illuminating
features.**

The Audi Q7's Matrix LED headlights don't just produce a light that is similar in colour to daylight. They also incorporate technology that adapts automatically to the car's surroundings.

Sensors and an inbuilt camera allow the optional Matrix LED headlights to detect the rear and oncoming lights of other road users, as well as ambient light in built-up areas. The technology then reacts by dipping individual LEDs to prevent dazzle, while still fully illuminating the remainder of the road. Using the vehicle's navigation data, Matrix LED technology can even anticipate corners, adjusting LEDs as you negotiate the bend. The result is a much wider visual range, benefitting both you and other road users. Dynamic sweeping indicators complete the striking look at the rear.

quattro

Driving confidence whatever the weather

Loose gravel. Icy patches. A tight bend in the rain. Conditions on the road are always changing, so quattro changes too. Available as standard on the Audi Q7, it analyses your grip – automatically distributing power between all four wheels to where it's needed most.

It's made for the most challenging conditions of all – the ones you encounter every day. Whatever the road holds, you can be confident that quattro will react.

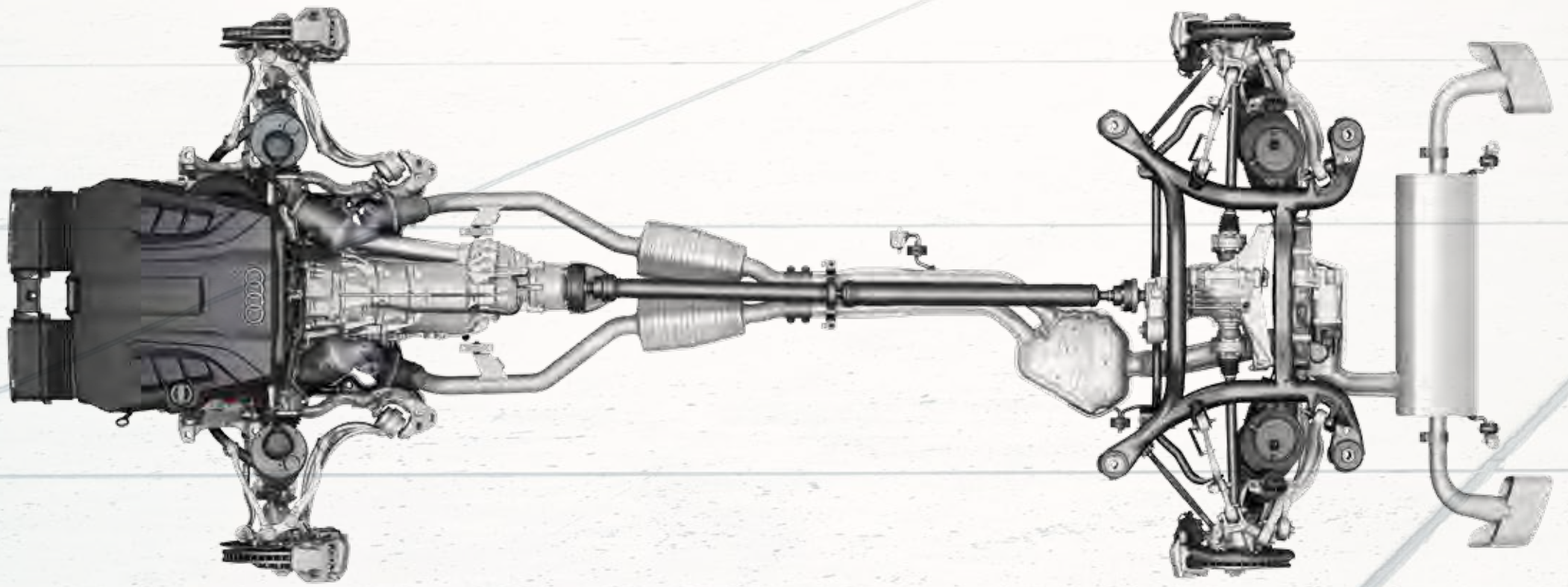



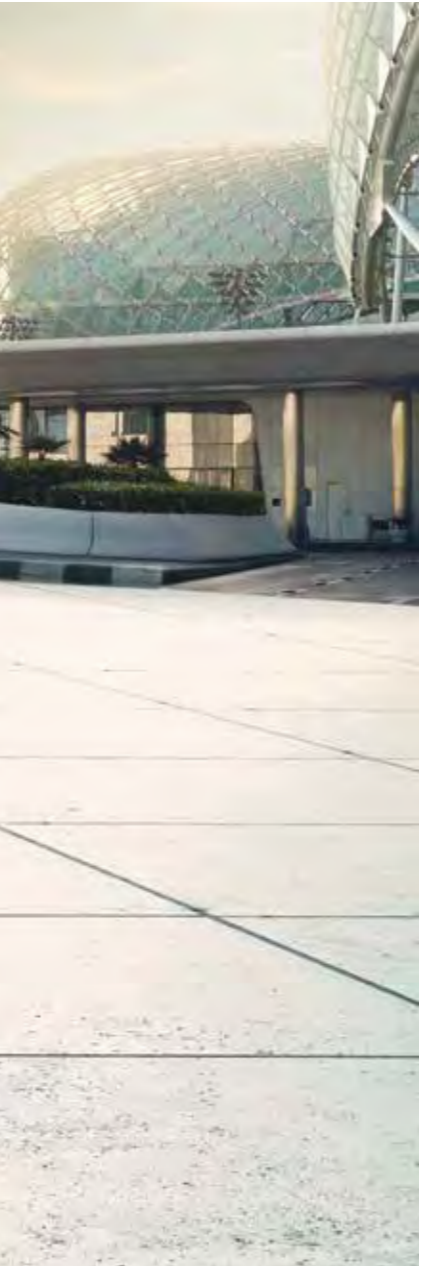





Comfortable. Spacious. Luxurious.

The all-new Audi Q7 is a very comfortable place to be. A new wraparound interior envelops the driver in luxury. Increased headroom from its predecessor makes the whole cabin more spacious. And, on S line models, 4-zone climate control and privacy glass provide additional comfort for rear passengers. For families, six of the seven seats can be fitted with child seats, while the rear two seats can be folded electrically, at the touch of a button.

Sumptuous styling details complete the all-new Audi Q7's interior, with two-piece inlays, aluminium accents and subtle ambient lighting.

Audi Virtual Cockpit

Visible innovation.

The information you need is always changing, so the Audi Virtual Cockpit changes too. Available as an option on Audi Q7 models, it replaces the traditional dashboard with a high resolution, 12.3" LCD screen, which you can customise to display just the information you want.

So during ordinary driving, you'll see virtual dials for speed and revs, along with information like the music you're playing or any calls received. With the touch of a button, you

can shrink the dials to show other functions, and even expand your navigation map to fill the display.

Our virtual dashboard puts everything you need to know right in front of you. With crisp 3D graphics and highly detailed effects, it's the embodiment of Audi technological innovation.





Switch views at the touch of a button

The display can be switched between 'classic' view, with prominent speedometer and rev counter or 'infotainment' view, which brings functions such as the navigation map or media to the fore. Drivers can change their view simply by pressing the 'view' button on the multi-function steering wheel.



Image shows Audi Virtual Cockpit in infotainment view with optional Traffic sign recognition (available as part of the Dynamic Pack)



Image shows Audi Virtual Cockpit in classic view with optional Night vision assistant

Audi



Online media streaming

Pairing a smartphone with the Audi Music stream app offers access to worldwide radio stations and music stored on the smartphone



Wi-Fi hotspot

Connects your mobile devices to the internet



Email

Your emails can be transmitted to your Audi MMI and read out conveniently*



Text messages

Messages are displayed or read out to you; you can also reply using the dictation function*



Twitter

Enables you to tweet and receive updates on the move, with text-to-speech and other convenient text functions



Weather information

Gives you forecasts and maps for your chosen destination



Map update online

The map version delivered can be updated free of charge with the first five navigation updates which are issued at intervals of six months. In conjunction with Audi Connect, the update can be carried out online in the vehicle



News online (individual)

Text and images from your favourite news sources with text-to-speech function



City events

Up-to-date information about events happening at your destination



Points-of-interest

Search Google™ using voice control



Traffic information online

Complements the dynamic route guidance with real-time traffic flow information for individual stretches of road



myAudi – special destinations

Import individual point-of-interest (POI) lists to your Satellite Navigation system via the myAudi portal



Train information

Find departure and arrival times and platform information while you're on the road (also available for other types of public transport such as underground systems)



Country-specific information

The legal regulations for a specific country, such as speed limits or whether it is compulsory to carry a high-visibility vest or display a motorway toll sticker, are displayed when crossing a border



Fuel prices

Information on filling stations with the cheapest prices in your selected search area



Parking information

Helps you find car parks nearby and, where available, information on prices and currently vacant spaces



Flight information

Get information about departure and arrival times as well as the corresponding gates and search directly for flight numbers



Access smartphone voice control

Such as Siri (iPhone 4S and higher). By pressing and holding the voice control button on the multi-function leather steering wheel, you can access the voice control function of the Bluetooth-connected smartphone directly, even while driving



Navigate with Google Earth™ and Google Street View™

Uses high-resolution aerial and satellite images as well as photos to guide you to your destination with ease



Destination entry via myAudi or Google Maps™

Navigation destinations can be conveniently planned on your PC or smartphone, then sent to your car via myAudi and Google Maps™

Connect



Stay networked on the move.

Being inside your car shouldn't mean losing touch with the outside world. That's why, with Audi Connect, the Audi Q7 creates a link between you and the internet. With high-speed, 4G internet access in your car, you can go online to access information, entertainment and Google Earth™ navigation maps by scrolling, tapping or speaking your commands. Audi Connect can even read aloud your text messages and allows you to dictate a response. And, with a wireless hotspot within the car, passengers can connect their mobile devices – to browse the internet, download emails, or access social media.

With Audi Connect, the world is at your fingertips. Experience it for yourself with our complimentary 3-month trial or purchase a 3-year subscription as an option.

Please note that an external data source is required to enable Audi Connect online services. Terms and conditions apply to certain Audi Connect functions. Please see page 77 for additional information.
*For mobile phone and software version compatibility, please visit your Audi Centre or audi.co.uk/phonecompatibility



Technology

Advanced technology designed to help you on the road.

We've developed a whole range of innovations for your Audi Q7 to enhance every aspect of your car. Here are some of the standard and optional technologies available.



MMI Navigation with MMI Touch

With its 3D map display and high-resolution graphics, MMI Navigation makes it easy to get where you're going. Controlling the system is just as simple, thanks to MMI Touch technology. You just have to 'write' commands with your finger – or speak your destination using the voice control system – and your route is displayed on the central 8.3" retractable screen or additionally in the 7" Colour Driver's Information System. MMI Navigation with MMI Touch is standard on all Audi Q7 models.

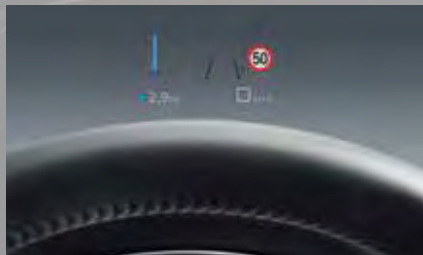

Head-up display

The optional head-up display projects important information directly into your field of vision, so you don't need to look away from the road. It shows details like the current speed limit, information from the assistance systems and instructions from the navigation system. All using a high-resolution 480 x 240 pixel display.



Bang & Olufsen 3D Advanced sound system

The optional Bang & Olufsen 3D Advanced sound system surrounds you with crystal-clear, ultra-realistic sound. All 23 speakers are arranged especially for the interior of the Audi Q7. Combined with acoustic lens technology, the music you hear in the all-new Audi Q7 is reproduced exactly as intended.



Ambient Lighting Pack

For better visibility when you're getting in and out, the optional ambient lighting system complements the Audi Q7's standard interior lighting, illuminating the door sill plates, as well as the contours of the centre console. Available with three different colour profiles, you can change the mood in the cabin with a touch of the MMI button.

Driver

Innovative features for enhanced safety,



Pre-sense city

A camera monitors the road ahead for cars suddenly stopping or pedestrians who are about to cross. If an imminent collision is detected, the system warns the driver and may initiate a deceleration action to reduce the speed or, if possible, prevent the collision. Comes as standard on the Audi Q7 range. Please see page 28 for more details.



Exit warning assist

Looks out for traffic when you or your passengers open the door of the Audi Q7, monitoring the area around the car for metal objects that could pose a danger, like bikes and cars. If any are detected, it activates an LED warning light on the wing mirrors and the inside of the front and rear doors. Exit warning assist is available as part of the optional Parking Pack Advanced or Audi Side Assist including Pre-sense rear and exit warning.

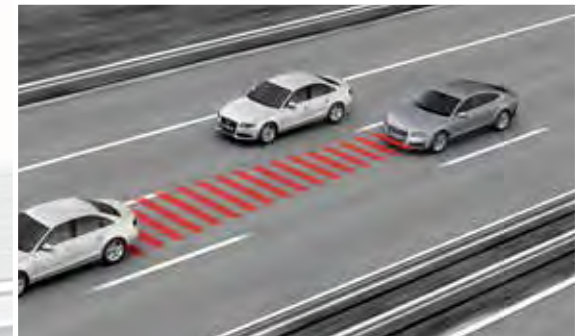

Adaptive Cruise Control with Stop&Go and Traffic jam assist

Keeps a steady distance from the car ahead and maintains any speed you choose by automatically accelerating and braking. If Traffic jam assist is also activated, the system uses the sensors and camera to detect any traffic jams ahead. When one is detected, the system won't just continue to brake and accelerate in traffic, it can apply supportive steering to make your journey more comfortable. Adaptive Cruise Control with Stop&Go and Traffic jam assist is available as part of the optional Dynamic Pack or Tour Pack.

assistance

efficiency and control



Trailer assist

Helps to manoeuvre and stabilise both the car and trailer while driving. And, when reversing, it automatically steers the trailer in the direction you choose using the MMI Touch dial. All you need to do is watch the road and operate the gears, accelerator and brake – and if at any point the trailer risks colliding with the car, the system warns you. Trailer assist is available as part of the optional Trailer Pack.



Predictive efficiency assist

Uses data from the navigation system to predict your route and suggest ways to drive more efficiently. It alerts you to speed limits, hidden bends and hills, so you can slow down in plenty of time. Predictive efficiency also works with Adaptive Cruise Control to adjust the car's cornering if a bend or roundabout is detected and can help to reduce fuel consumption. Predictive efficiency assist is available as part of the optional Dynamic Pack.



All-wheel steering

You use four wheels to drive your car, so why not use all four to steer it too? For more manoeuvrability at low speeds, the optional All-wheel steering system steers the rear wheels in the opposite direction to the front wheels. At high speeds, both axles steer in the same direction for better cornering and enhanced stability. So you get more responsive steering and a more dynamic drive.

Vehicle driver assistance and safety systems are not a substitute for attentive driving. Drivers retain full responsibility for providing the necessary inputs for safe control of the vehicle. System descriptions within this brochure are provided for information purposes only. System limitations and operational requirements apply. See manual for details.

SE model equipment

All Q7 SE models have the following items of standard equipment

Engine and efficiency

Automatic Start-Stop system with energy recovery

Recuperation – the kinetic energy produced from braking or coasting is converted into electrical energy and stored temporarily in the battery. When accelerating, this energy is used, relieving the load on the alternator and can result in a fuel saving of up to 3%

75-litre fuel tank

12-litre AdBlue® tank

Wheels, tyres and suspension

19" x 8.5J '5-spoke star' design alloy wheels with 255/55 R19 tyres

Audi Drive Select – features five modes (Auto, Comfort, Dynamic, Efficiency, and Individual). These modes allow the driver to electronically adjust the engine, transmission and steering. Additional modes are available when Adaptive air suspension option is ordered (see Dynamic Pack on page 55 for further details)

Dynamic suspension

Tyre repair kit

Anti-theft wheel bolts

Tool kit

Lighting

Xenon Plus headlights with LED daytime-running lights – with adaptive headlights

LED rear lights

Headlight washers

Audio and communication

Colour Driver's Information System (DIS) with 7" high resolution TFT screen. Shows information from the driver assistance systems, media in use, rest recommendation, telephone menu, outside temperature and MMI content

MMI Radio Plus and DAB

Audi Music Interface – universal connection for use with stereo audio sources, USB and MP3 devices including Apple iPod. The interface provides charging function (dependent on device)

Bluetooth interface – for hands-free mobile phone connectivity and Bluetooth audio streaming (depending on compatibility of mobile phone and software version, please visit audi.co.uk/phonecompatibility)

Audi Sound System:

- 6 channel amplifier
- 180 watt amplifying capacity
- 10 loudspeakers including subwoofer

MMI Navigation Plus (HDD) with MMI Touch – includes:

- 8.3" central rising colour display with high-resolution graphics
- 3D map display of places of interest and city models
- Detailed route information, map preview, choice of alternative routes, POIs, lane recommendations, motorway exits and detailed junction maps
- MMI Touch – touch-sensitive control panel for quick, intuitive operation including handwriting recognition
- MMI search – free text search with intelligent destination suggestions during entry
- Vehicle support and speed limit display
- Map update service for downloading the latest navigation data (for further information please see page 77)
- Flash memory for music (10GB)
- Single DVD drive for music and video DVDs. Supports MP3, WMA, AAC and MPEG-4
- AUX-IN
- 2 x SDXC card readers
- 2 x USB sockets

Voice control system



19" x 8.5J '5-spoke star' design alloy wheels



Colour Driver's Information System and MMI Navigation Plus

Audi Connect (3-month trial) – convenient connection of your vehicle to the internet via an integrated data module with LTE/UMTS connection. For more information on Audi Connect services please see pages 20 and 21.

See terms and conditions on page 77

Exterior equipment

Full body-colour paint finish

Exterior mirrors – electrically adjustable, folding and heated. Also includes an automatic kerb view function which tilts the passenger mirror downwards towards the kerb when reverse gear is engaged

Aluminium roof rails

Aluminium window trim

Power-operated tailgate

Interior equipment

Dual-zone electronic climate control

4-spoke leather multi-function steering wheel, with gear-shift paddles

Front centre armrest

Centre console contains two open cup holders

Door sill trims with aluminium inlay

Luggage compartment sill protection

Cloth headlining

Front and rear floor mats

Inlays. Upper inlays in Diamond finish, silver grey and lower inlays in Anodised finish, anthracite

Smoking package

Interior lighting package includes front and rear reading lights, vanity mirror lights, footwell lighting, light in glovebox, entrance lighting, lighting inside door handles, luggage compartment lights, exterior courtesy lighting on tailgate, contour door and dashboard lighting

Auto-dimming rear-view mirror

Seats

Standard seats in Twin leather upholstery

Electric 4-way lumbar support for front seats

Heated front seats

Electrically adjustable front seats – including:

- Forwards/backwards position
- Seat height and angle
- Seat cushion angle
- Backrest angle

7 seats

Second row includes:

- Three seats, split-folding 35:30:35
- Forward/backwards and backrest angle manual adjustment for additional comfort
- Outer seats tilt and fold
- Centre armrest with two cup holders

Third row includes:

- Two seats, electrically-folding, split 50:50, operated from boot or second seat row entry area



MMI Touch



8.3" central rising MMI colour display



Dual-zone electronic climate control

SE model equipment

continued

Assistance systems

Electromechanical parking brake

Light and rain sensor

Audi Parking System Plus (front and rear) – aids parking by acoustically and visually indicating distances to obstacles

Keyless Go – allows engine to be started by simply pressing the start/stop button in the centre console. The key just needs to be carried

Cruise control with speed limiter

Hill descent control supports the driver on steep descents with active brake applications. The vehicle is held at the predefined speed throughout the descent

Hill hold assist – holds the vehicle stationary for unlimited periods after stopping on uphill and downhill gradients

Audi Pre-sense city – the system uses the camera located on the front rear-view mirror to detect vehicles and pedestrians in front. If an imminent collision is detected, the system warns the driver.

Subject to certain system limits, up to speeds of approximately 19mph the system may initiate emergency braking application and if possible prevent the collision.

At speeds up to approximately 40mph the speed can be reduced up to 18mph to minimise the severity of the accident.

Vehicle driver assistance and safety systems are not a substitute for attentive driving. Drivers retain full responsibility for providing the necessary inputs for safe control of the vehicle. System descriptions within this brochure are provided for information purposes only. System limitations and operational requirements apply. See manual for details

Safety and security

ISOFIX child seat mounting – for all 6 passenger seats (with front passenger airbag deactivation). Includes Top Tether

Electronic Stabilisation Control (ESC), including ABS, ASR and EDL

First aid kit and warning triangle

Driver, front passenger, front side and curtain airbag system

Seat belt monitoring

Anti theft alarm

Tyre pressure loss indicator – visual and acoustic warning if the pressure drops in one or more tyres



Audi Pre-sense city



Audi Drive Select – image features modes that are available with optional Adaptive air suspension



Image shows the Audi Q7 SE model with optional Ink blue, metallic paint (C7)

S line model equipment

In addition to SE model equipment

Total RRP inc VAT*
£3,495.00

Wheels, tyres and suspension

20" x 9J '5-parallel-spoke' design alloy wheels with 285/45 R20 tyres

Lighting

All-weather LED headlights – LEDs for all front lighting functions. LED technology provides lower energy consumption and enhanced contrast with a colour similar to daylight, for increased safety and recognition by other road users. Includes all-weather light function to reduce the risk of the driver being dazzled when visibility is poor (in fog, rain or snow)

Dynamic rear indicators – the rear indicators dynamically sweep from inside to out. This helps to clearly identify not only that the vehicle is turning, but in which direction – increasing road safety as it is easier for other road users to determine which way cars are moving in a shorter amount of time

High-beam assist – automatically adjusts headlights from high-beam to dipped-beam when another vehicle is approaching

Exterior equipment

S line body styling comprising:

- S line bumpers, side ventilation grilles, side skirts and roof spoiler
- Platinum grey front spoiler lip and diffuser insert with honeycomb grid in black
- S line badges on front wings

Privacy glass – dark tinted rear and rear-side windows (from B-pillar backwards)

Interior equipment

Deluxe 4-zone automatic climate control

S line 3-spoke leather-trimmed multi-function steering wheel, with gear shift paddles

Luggage compartment sill protection in stainless steel

Door sill trims with S line logo

Black cloth headlining

Inlays – upper inlays in Brushed aluminium sono and lower inlays in Chrome paint, Slate grey

Adjustable front centre armrest

Pedal cluster in stainless steel

Seats

Front Sport seats

Leather/Perforated Alcantara upholstery with 'S' embossing in the front seat backrests



20" x 9J '5-parallel-spoke' design alloy wheels



All-weather LED headlights



Deluxe 4-zone electronic climate control



S line front Sport seats in leather/Perforated Alcantara



Image shows the Audi Q7 S line model with optional Daytona grey, pearl-effect paint (6Y) and 21" '5-arm turbine' design alloy wheels (F48) and Dynamic Pack (WB1)

Audi Q7 SE

Engines	Power	Transmissions	CO2 g/km*	Total RRP inc VAT*	Recommended OTR†
3.0 TDI quattro	218PS	8-speed tiptronic	150	£46,925.00	£47,755.00
3.0 TDI quattro	272PS	8-speed tiptronic	153	£49,475.00	£50,340.00

*Please note: CO2 emissions can change if a different size alloy is ordered onto the vehicle. This may also lead to a change to the VED amount payable. Please refer to pages 74 and 77. Value based on standard EU test figures for comparative purposes and may not reflect real driving results.

Please note: The maximum power output figures are quoted in PS (or Pferdestärke, which is the metric equivalent of brake horsepower). To convert to brake horsepower, divide the PS figure by 1.0139.

*RRP – Recommended Retail Price. VAT is calculated at 20% but this may alter to reflect any change in the applicable VAT rate.

*Recommended On-The-Road (OTR) retail prices include: delivery charge, half a tank of fuel, number plates at £630.00 (inc. VAT), Road Fund Licence (which may vary depending on model/transmission – see page 77 for details) and first registration fee at £55.00. Vehicle Excise Duty correct at time of going to print, but this may alter to reflect any change in the applicable VED rate.

Audi Q7 S line

Engines	Power	Transmissions	CO2 g/km*	Total RRP inc VAT*	Recommended OTR†
3.0 TDI quattro	218PS	8-speed tiptronic	150	£50,420.00	£51,250.00
3.0 TDI quattro	272PS	8-speed tiptronic	153	£52,970.00	£53,835.00



Paint

We believe that every part of your car should have a personal touch. Which is why you can choose from a wide range of paint colours, from solid paint to metallic and pearl effect finishes.

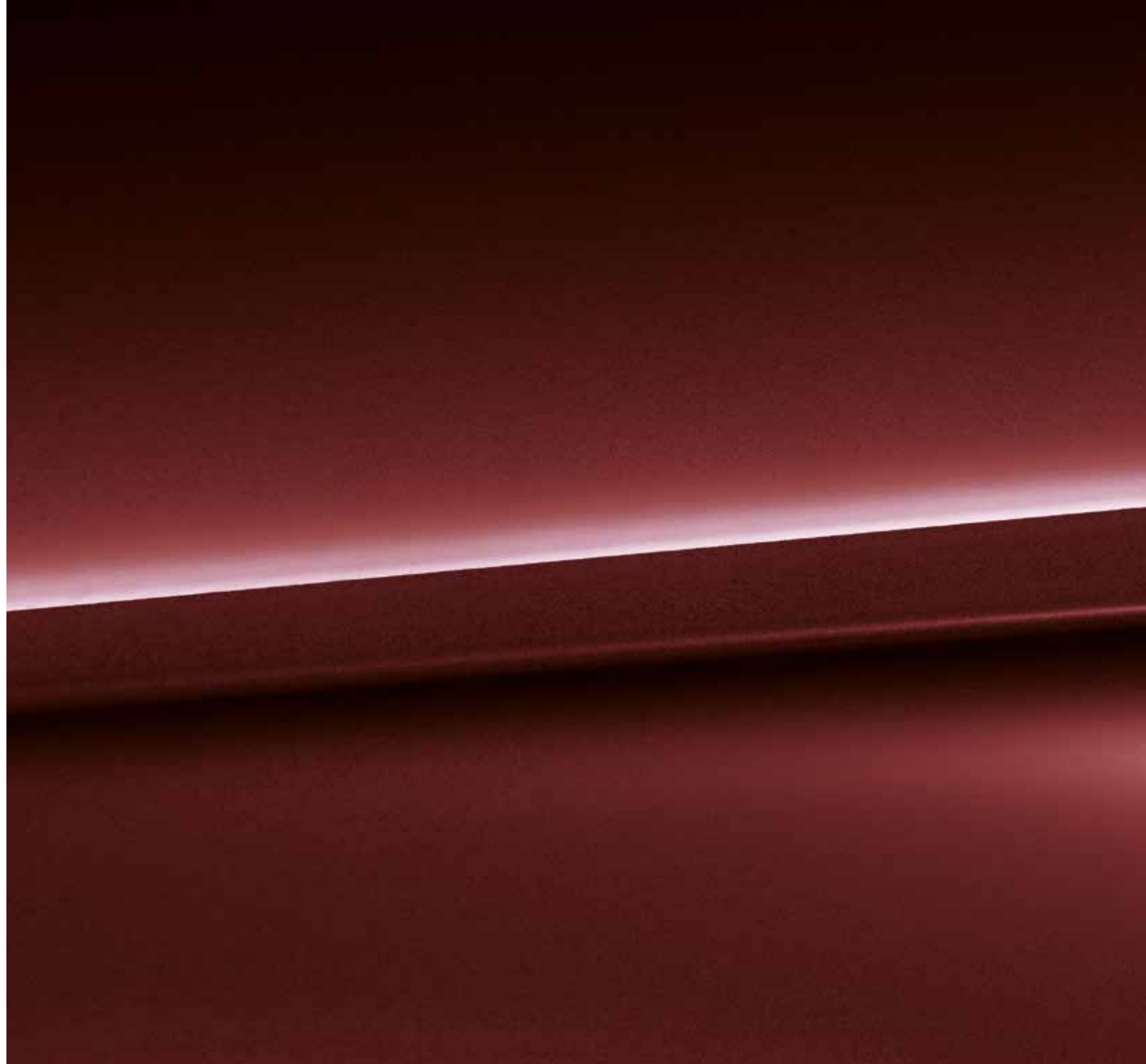

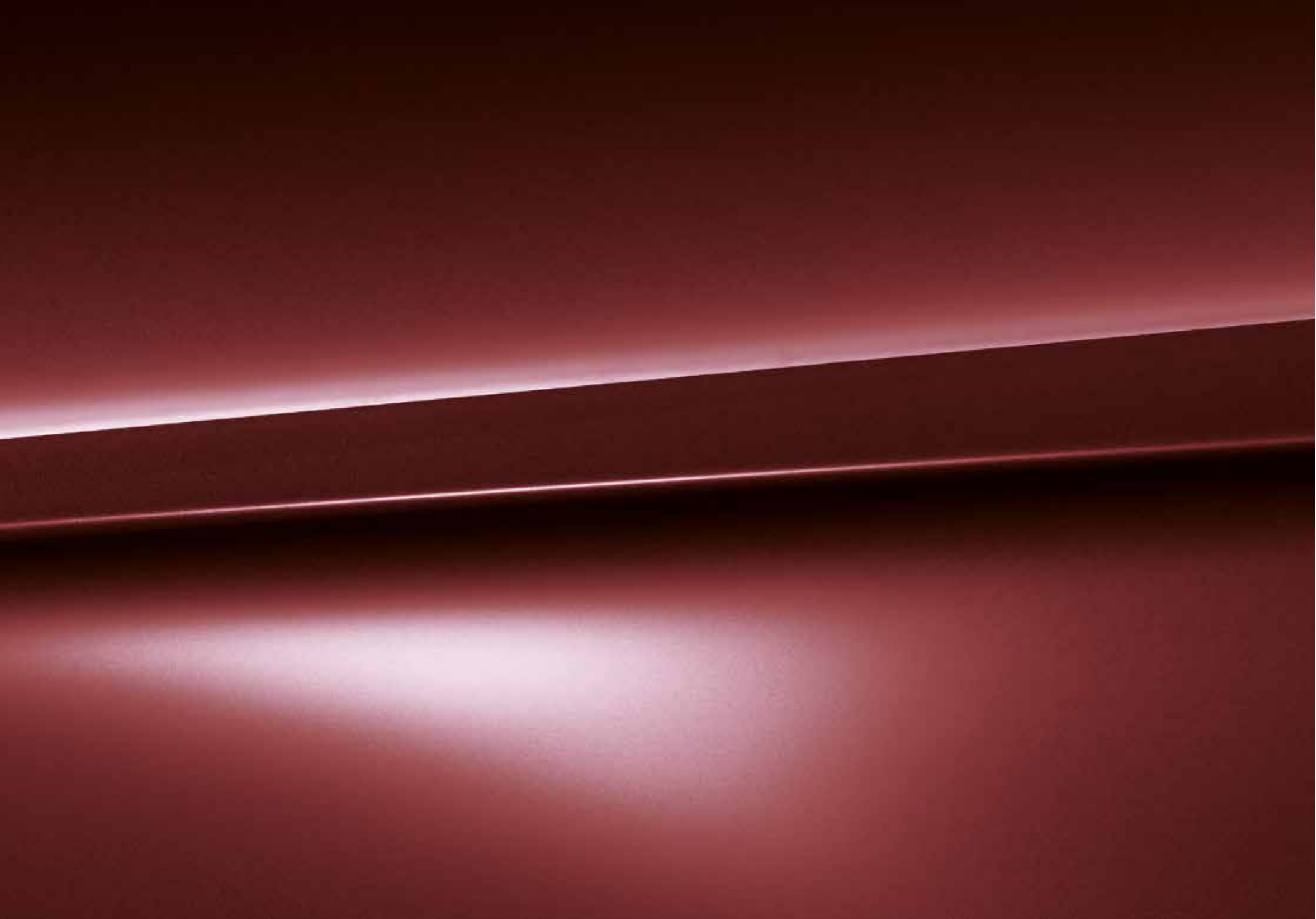

Paint

You can select one of the standard colours shown opposite or, for a different look, choose from a range of optional finishes.

Standard colours



Pure white – 0Q

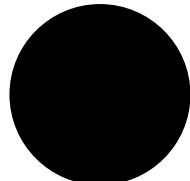

Night black – A1

Optional colours

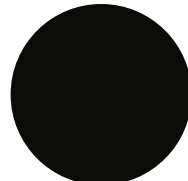

Orca black, metallic – 2T

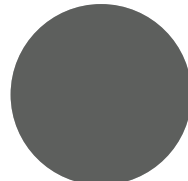

Graphite grey, metallic – 9Q

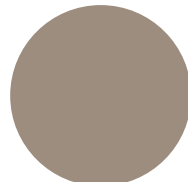

Diamond beige, metallic – N3

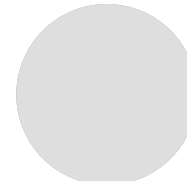

Floret silver, metallic – L5

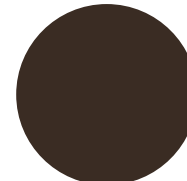

Argus brown, metallic – W3



Glacier white, metallic – 2Y

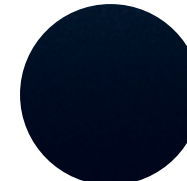

Ink blue, metallic – C7

S line colour

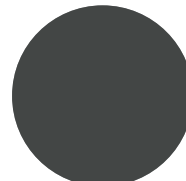

Daytona grey, pearl effect – 6Y

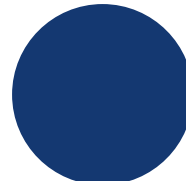

Sepang blue, pearl effect – E9

Options are subject to availability and may extend time taken for delivery.

All the colour swatches on this page are matched as accurately as possible to the actual paint colours used. However, due to print processes, Audi UK cannot guarantee that colours shown are 100% accurate.

Visit your local Audi Centre for a more accurate colour swatch.

*Total RRP inc VAT – Recommended Retail Price including VAT which is calculated at 20%. This may alter to reflect any change in the applicable VAT rate.

Optional and S line colours

Total RRP inc VAT*
£675.00

Paint

Audi exclusive

Everyone has a favourite colour. No matter what yours is, Audi exclusive provides a range of unique colours that have been designed to set your car apart. Choose from the swatches here, or specify any other paint colour in the Audi range. The choice is yours.*

Customised

If you have a particular colour in mind, we'll mix the exact metallic or pearl-effect shade you want.**

Options are subject to availability and may extend time taken for delivery.

*Audi exclusive paint is subject to factory approval. Visit your local Audi Centre for colour samples. Please note that code SY7 must be added when ordering Audi exclusive paint.

**Customised paint is subject to factory approval, and is available for metallic and pearl-effect water-based paints only. Three-colour process colours and two-tone schemes are not available.

All the colour swatches on this page are matched as accurately as possible to the actual paint colours used. However, due to print processes, Audi UK cannot guarantee that colours shown are 100% accurate.

Visit your local Audi Centre for a more accurate colour swatch.

*Total RRP inc VAT – Recommended Retail Price including VAT which is calculated at 20%. This may alter to reflect any change in the applicable VAT rate.

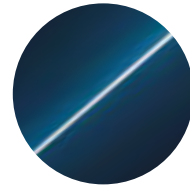

Palace blue, pearl effect



Sand beige, pearl effect

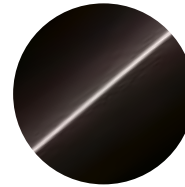

Saddle brown, pearl effect

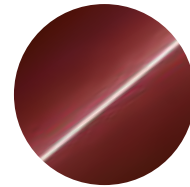

Classic red, pearl effect

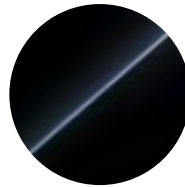

Mamba black, metallic

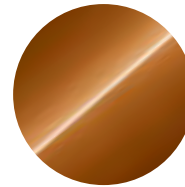

Ipanema brown, metallic



Any colour in the Audi range or 100 exclusive colours to choose from*

Audi exclusive*

Total RRP inc VAT+
£2,155.00



Customised paint**

Customised**

Total RRP inc VAT+
£2,655.00

Upholstery

It's important to feel comfortable on the road. Just choose from our range of luxury upholstery materials and textures, including additional support and colour options, for complete relaxation while you drive.





Upholstery

Standard seats

Choose your favourite upholstery from the swatches shown opposite to give your car's interior the look and feel you want.

Standard seats are electrically adjustable for forwards/backwards position, seat height and angle and backrest angle. Manual adjustment for head restraint and seat belt height.







Options are subject to availability and may extend time taken for delivery.

- = Not available
- = Available
- S = Standard

All the colour swatches on this page are matched as accurately as possible to the actual upholstery colours used. However, due to print processes, Audi UK cannot guarantee that colours shown are 100% accurate.

*Includes leather and leatherette.

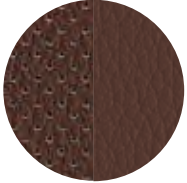
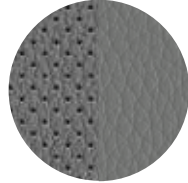
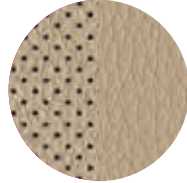
*Total RRP inc VAT - Recommended Retail Price including VAT which is calculated at 20%. This may alter to reflect any change in the applicable VAT rate.

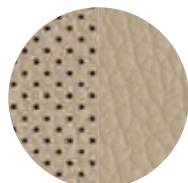
					SE	S line	Total RRP inc VAT*
Twin leather* - N1F					Seat centre sections of the front seats, the two outer rear seats of the second row, the two rear seats of the third row and the seat side bolster on the driver's side nearest the door entrance in leather. Seat side bolsters, head restraints, door trim inner sections, centre armrest and middle seat in second row in leatherette	S	£0.00
	Black - FZ	Nougat brown - VB	Rock grey - UW	Pistachio beige - UX			
Perforated Twin leather - N1F/4D3					Seat centre sections of the front seats, the two outer rear seats of the second row, the two rear seats of the third row and the seat side bolster on the driver's side nearest the door entrance in perforated leather. Seat side bolsters, head restraints, door trim inner sections, centre armrest and middle seat in second row in leatherette. Only available in combination with Seat ventilation for front seats (4D3) - see page 44 for pricing	•	£0.00
	Black - FZ	Nougat brown - VB	Rock grey - UW	Pistachio beige - UX			
Cricket leather - N5A					Seat centre sections, seat side bolsters, head restraint centre panels, front centre armrest, rear centre armrest and third row seats in Cricket leather. Door trim inserts in Alcantara	•	£900.00
	Black - FZ	Rock grey - UW	Pistachio beige - UX				
Perforated Cricket leather - N5A/4D3					Seat centre sections, seat side bolsters, head restraint centre panels, front centre armrest, rear centre armrest and third row seats in perforated cricket leather. Door trim inserts in Alcantara. Only available in combination with Seat ventilation for front seats (4D3) - see page 44 for pricing	•	£900.00
	Black - FZ	Rock grey - UW	Pistachio beige - UX				

Upholstery

Sport seats – Q1D

Front Sport seats come with side bolsters shaped for additional support. They are electrically adjustable for forwards/backwards position, seat depth, seat height and angle and backrest angle. Manual adjustment for head restraint and seat belt height.

Leather/Alcantara
– N7U



Black – FZ

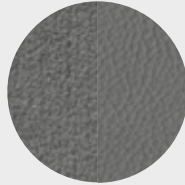

Rock grey – UV

Valcona leather
– N5D



Black – FZ

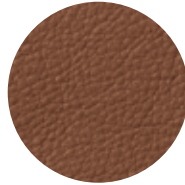

Cedar brown – UU

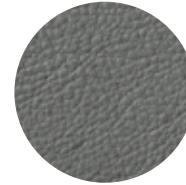

Rock grey – UV

Seat side bolsters, head restraint centre panel and centre armrests in leather. Seat centre panel and door trim inserts in Alcantara

Seat centre panel, seat side bolsters, head restraints, centre armrest and front centre armrests in Valcona leather. Door trim inserts in Alcantara

SE	S line	Total RRP inc VAT*
●	–	£1,900.00
●	–	£2,850.00

Options are subject to availability and may extend time taken for delivery.

- = Not available
- = Available
- S = Standard

All the colour swatches on this page are matched as accurately as possible to the actual upholstery colours used. However, due to print processes, Audi UK cannot guarantee that colours shown are 100% accurate.

*Total RRP inc VAT – Recommended Retail Price including VAT which is calculated at 20%. This may alter to reflect any change in the applicable VAT rate.



Sport seat

Upholstery

Comfort seats – PS8/4D3

Comfort seats offer a multitude of electrical or pneumatic adjustment and must be combined with exterior mirrors (6XF or 6XL).

Comfort front seats include:
 Seat ventilation where 3 different intensities of cool air are drawn through the seat, providing active ventilation of the front seat centre section, and thigh support.

Electric adjustment of:
 - Forwards/backwards position
 - Seat height and angle
 - Backrest angle
 - Seat depth

Pneumatic adjustment of:
 - Backrest side bolsters
 - Seat side bolsters

Manual adjustment of: head restraint height, angle and clearance and seat belt height.

Comfort seats are also available as part of the Comfort Pack (see page 54)

Options are subject to availability and may extend time taken for delivery.



-- = Not available
 • = Available
 S = Standard

All the colour swatches on this page are matched as accurately as possible to the actual upholstery colours used. However, due to print processes, Audi UK cannot guarantee that colours shown are 100% accurate.

*This image shows the seat only, without the perforated leather.

*Total RRP inc VAT – Recommended Retail Price including VAT which is calculated at 20%. This may alter to reflect any change in the applicable VAT rate.

Perforated Valcona leather – N5D

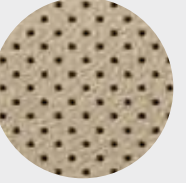
				Seat centre panel of front seats and non-ventilated seat centre panel of the 2 outer rear seats in perforated Valcona leather. Seat side bolsters, centre rear seat, 3rd row, head restraints, front centre armrest and rear centre armrest in Valcona leather. Door trim inserts in Alcantara The leather is tanned without the use of chromium, dyed through and treated with non-fading colour pigments	SE	S line	Total RRP inc VAT*
Black – FZ	Cedar brown – UU	Rock grey – UW	Pistachio beige – UX		•	–	£3,250.00



Comfort seat*

Upholstery

S line Sport seats

S line front Sport seats come with side bolsters shaped for additional support. They are electrically adjustable for forwards/backwards position, seat depth, seat height and angle and backrest angle. Manual adjustment for head restraint and seat belt height.

Also features an embossed S logo on the front seat backrests.

Leather/Perforated Alcantara – N7K

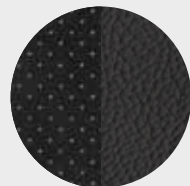

Black – XG

Valcona leather – N1V



Black – XG

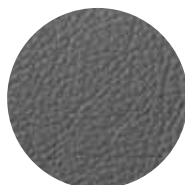

Rotor grey – SL

Seat side bolsters, head restraint centre panel and centre armrests in leather/perforated. Seat centre panel and door trim inserts in Perforated Alcantara
Includes contrasting stitching – see page 45 for details

Seat centre panel, seat side bolsters, head restraints, centre armrest and front centre armrests in Valcona leather. Door trim inserts in Alcantara
Includes contrasting stitching – see page 45 for details

SE	S line	Total RRP inc VAT*
I	S	£0.00
–	●	£1,100.00

Options are subject to availability and may extend time taken for delivery.

- = Not available
- = Available
- S = Standard

All the colour swatches on this page are matched as accurately as possible to the actual upholstery colours used. However, due to print processes, Audi UK cannot guarantee that colours shown are 100% accurate.

*Total RRP inc VAT – Recommended Retail Price including VAT which is calculated at 20%. This may alter to reflect any change in the applicable VAT rate.



S line Sport seats in Rotor grey Valcona leather

Seat options

Choose from a variety of different seat options to further enhance the comfort of your Audi Q7.

Order Code		SE	S line	Total RRP inc VAT*
PV3	Driver's side memory function for the electrically adjustable front seats. Only in combination with exterior mirrors with memory function (6XF or 6XL)	●	●	£350.00
PV6	Driver and front passenger memory function for the electrically adjustable front seats. Only available in combination with exterior mirrors with memory function (6XF or 6XL) plus either Sport seats (Q1D) or Comfort seats (PS8). Option is also available in Comfort Pack (WB6)	●	●	£550.00
4A4	Heated outer rear seats for the second row. Works in the same way as front seat heating, enabling you to regulate the outer rear seats separately	●	●	£400.00
4D8	Massage function for front seats. Massage function with five different programs (wave, pulse, stretch, lumbar, shoulders) and five levels of intensity for massaging the muscles with the help of 10 pneumatic cushions. Only available in combination with Comfort seats (WB6 or PS8)	●	—	£500.00
PE3	Deletion of third seating row	●	●	£0.00
4D3	Seat ventilation for front seats. Three different intensities of cool air are drawn through the seat (for Comfort seats), or a fan (for standard/Sport seats) provides active ventilation of the seat centre section and thigh support. To allow for the seat ventilation, the leather of the seat front is perforated. Outer seats of the second row are also perforated but not ventilated. Only available with comfort seats (PS8), standard seats with Cricket leather (N5A) or Twin leather (N7U)	●	—	£1,050.00
	In combination with Comfort seats (PS8)	●	●	£0.00

Options are subject to availability and may extend time taken for delivery.

— = Not available
● = Available

*Total RRP inc VAT – Recommended Retail Price including VAT which is calculated at 20%. This may alter to reflect any change in the applicable VAT rate.

Colour and trim guide

Interior trim colours

Standard seats

To help you choose the right interior for your new Audi Q7, please use this guide, showing the carpet, dashboard and headlining colours that have been matched to your chosen upholstery.

Front Sport seats

Comfort seats

S line Sport seats

Options are subject to availability and may extend time taken for delivery.

- = Not available
- = Available

Order Code	Upholstery (seat centre/seat bolster)	Carpet	Dashboard (upper/lower)	Headlining	Twin leather N1F	Cricket leather N5A
FZ	Black/Black	Black	Black/Black	Lunar silver	•	•
VB	Nougat brown/Nougat brown	Black	Black/Black	Lunar silver	•	—
UW	Rock grey/Rock grey	Rock grey	Granite grey/Rock grey	Lunar silver	•	•
UX	Pistachio beige/Pistachio beige	Pistachio beige	Criollo brown/Pistachio beige	Linen beige	•	•

Order Code	Upholstery (seat centre/seat bolster)	Carpet	Dashboard (upper/lower)	Headlining	Leather/Alcantara (N7U)	Valcona leather (N5D)
FZ	Black/Black	Black	Black/Black	Lunar silver	•	•
UU	Cedar brown/Cedar brown	Black	Black/Black	Lunar silver	—	•
UV	Rock grey/Rock grey	Black	Black/Black	Lunar silver	•	•

Order Code	Upholstery (seat centre/seat bolster)	Carpet	Dashboard (upper/lower)	Headlining	Valcona leather (N5D)
FZ	Black/Black	Black	Black/Black	Lunar silver	•
UU	Cedar brown/Cedar brown	Black	Black/Black	Lunar silver	•
UW	Rock grey/Rock grey	Rock grey	Granite grey/Rock grey	Lunar silver	•
UX	Pistachio beige/Pistachio beige	Pistachio beige	Criollo brown/Pistachio beige	Linen beige	•

Order Code	Upholstery (seat centre/seat bolster)	Carpet	Dashboard (upper/lower)	Headlining	Leather/Alcantara (N7K)	Valcona leather (N1V)
SL (Silver stitching)	Rotor grey/Rotor grey	Black	Black/Black	Black	—	•
XG (Dark silver stitching)	Black/Black	Black	Black/Black	Black	•	•

Inlays

Attention to detail can make a big impact. From contemporary High-gloss black to a Walnut terra brown, our selection of inlays offers the perfect finishing touch to your car's interior.





Inlays

Inlays are the all-important finishing touch that add flair and interest to your car's interior.

The luxurious Audi Q7 cabin features two complementary inlays on the dashboard, door trims and centre console.

Order Code		SE	S line	Total RRP inc VAT*
5MJ	Upper inlays in Diamond finish, Silver grey, with lower inlays in Anodised finish, anthracite	S	—	£0.00
5TG	Upper inlays in Brushed aluminium, Sono, with lower inlays in Chrome paint finish, Slate grey	—	S	£0.00
5TE	Upper inlays in Brushed aluminium, Sono, with lower inlays in Anodised finish, anthracite	●	—	£350.00
5MT	Upper inlays in Diamond finish, Silver grey, with lower inlays in Walnut, Terra brown	●	—	£550.00
5MV	Upper inlays in Diamond finish, Silver grey, with lower inlays in Oak grey	●	—	£550.00
7TN	Upper inlays in High-gloss black, with lower inlays in Walnut, Terra brown	●	—	£700.00
5MC	Upper inlays in High-gloss black, with lower inlays in Oak grey	●	—	£700.00
5MR	Upper inlays in High-gloss black, with lower inlays in Beaufort walnut	●	—	£950.00
7TC	Upper inlay in High-gloss black, with lower inlay in Aluminium, Beaufort black	—	●	£1,900.00
5TB	Upper inlays in Brushed aluminium, Sono, with lower inlays in Walnut, Terra brown	●	—	£900.00
5TT	Upper inlays in Brushed aluminium, Sono, with lower inlays in Oak grey	●	—	£900.00
		—	●	£550.00
5TV	Upper inlays in Brushed aluminium, Sono, with lower inlays in Beaufort walnut	●	—	£1,150.00
		—	●	£800.00
5MN	Upper inlays in Brushed aluminium, Sono, with lower inlays in Aluminium, Beaufort black	—	●	£1,900.00

Upper inlays

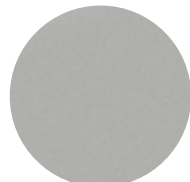

Diamond finish,
Silver grey



Brushed aluminium,
Sono

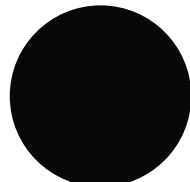

High-gloss black

Lower inlays

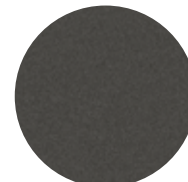

Anodised finish, anthracite

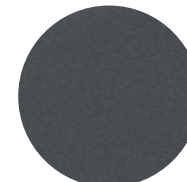

Chrome paint finish,
Slate grey



Beaufort walnut



Oak grey

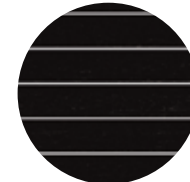

Aluminium, Beaufort black

Options are subject to availability and may extend time taken for delivery.

All the inlay swatches on this page are matched as accurately as possible to the actual inlay colours used. However, due to print processes, Audi UK cannot guarantee that colours shown are 100% accurate.

— = Not available
● = Available
S = Standard

*Total RRP inc VAT – Recommended Retail Price including VAT which is calculated at 20%. This may alter to reflect any change in the applicable VAT rate.

Inlays

Audi exclusive lower inlays

Audi exclusive has sourced a wide range of materials which you can select for your lower inlays, from Oak sepia to Fine grain myrtle nutmeg brown.

Options are subject to availability and may extend time taken for delivery.

All the inlay swatches on this page are matched as accurately as possible to the actual inlay colours used. However, due to print processes, Audi UK cannot guarantee that colours shown are 100% accurate.

- = Not available
- = Available
- S = Standard

*Available in conjunction with upper inlays in High-gloss black, Diamond paint finish, Silver grey or Brushed aluminium, Sono. See page 48.

*Total RRP inc VAT - Recommended Retail Price including VAT which is calculated at 20%. This may alter to reflect any change in the applicable VAT rate.

Order Code		SE	S line	Total RRP inc VAT*
YTA S3G	Audi exclusive inlays – your chosen Audi exclusive inlay will replace the lower inlay in your Audi Q7. All Audi exclusive inlays can be combined with all upper inlays on page 48	•	•	£1,350.00

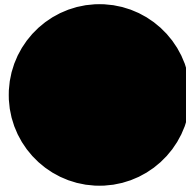

Piano finish, black*



Fine grain ash, nougat*



Oak, sepia*



Fine grain myrtle, nutmeg brown*



Modrone wood, gold*

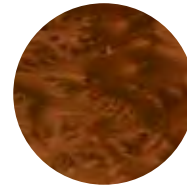

Vavona, bronze*



Tamo ash, natural dark brown*

Options

Every driver has different needs, which is why we have created some useful options to further enhance your car. For extra comfort, support, style or function, you can choose from a variety of additional features, tailoring everything from your infotainment and audio equipment to your wheels and lighting.





Wheels, tyres and suspension

Choose a set of specially selected alloy wheels to subtly enhance the way your car looks and drives.



18" x 8J '10-spoke' design alloy wheels - C8S



19" x 8.5J '5-spoke star' design alloy wheels - C5E



19" x 8.5J '5-V-spoke' design alloy wheels - CH6



19" x 8.5J '7-twin-spoke' design alloy wheels - F43



20" x 9J '5-parallel-spoke' design alloy wheels - F08



20" x 9J '10-spoke star' design alloy wheels - F06



20" x 9J '5-arm-offroad' design alloy wheels with matt titanium-look gloss turned finish - CS6



21" x 9.5J '5-arm turbine' design contrasting grey, partly polished alloy wheels - F48



21" x 9.5J '5-twin-spoke' design alloy wheels - F50



21" x 9.5J '5-twin-spoke' design alloy wheels in titanium-look finish, gloss turned finish - F51

Options are subject to availability and may extend time taken for delivery.

- = Not available
• = Available
S = Standard

Please note that the size of your chosen Audi Q7 wheel may affect the fuel consumption figures and the CO2 emissions. This may result in a change in subsequent Vehicle Excise Duty payable. Please see pages 74 and 77.

All alloy wheel images are matched as accurately as possible to the actual colour. However, due to print processes, Audi UK cannot guarantee that colours shown are 100% accurate.

Wheels, tyres and suspension

Order Code		SE	S line	Total RRP inc VAT*
C8S	18" x 8J '10-spoke' design alloy wheels with 235/65 R18 tyres	●	—	£0.00
C5E	19" x 8.5J '5-spoke star' design alloy wheels with 255/55 R19 tyres	S	—	£0.00
CH6	19" x 8.5J '5-V-spoke' design alloy wheels with 255/55 R19 tyres	●	—	£250.00
F43	19" x 8.5J '7-twin-spoke' design alloy wheels with 255/55 R19 tyres	●	—	£450.00
F08	20" x 9J '5-parallel spoke' design alloy wheels with 285/45 R20 tyres	—	S	£0.00
F06	20" x 9J '10-spoke star' design alloy wheels with 285/45 R20 tyres	●	—	£950.00
		—	●	£450.00
CS6	20" x 9J '5-arm-offroad' design alloy wheels with matt titanium-look gloss turned finish with 285/45 R20 tyres	●	—	£1,550.00
		—	●	£650.00
F48	21" x 9.5J '5-arm turbine' design contrasting grey, partly polished alloy wheels with 285/40 R21 tyres	●	—	£2,000.00
		—	●	£1,100.00
F50	21" x 9.5J '5-twin-spoke' design alloy wheels with 285/40 R21 tyres	●	—	£2,000.00
		—	●	£1,100.00
F51	21" x 9.5J '5-twin-spoke' design alloy wheels with titanium-look finish, gloss turned finish with 285/40 R21 tyres	●	—	£2,200.00
		—	●	£1,400.00
1G1 1S1	Collapsible spare wheel with Car Jack – maximum speed 50mph. Only available in combination with 5 seats	●	●	£250.00
1BK	Adaptive air suspension – electronically controlled air suspension with continuously adaptive damping system for all four wheels which regulates ride height and damping automatically. Additional allroad and lift/off-road modes can be selected via Audi Drive Select in the MMI system. In the allroad mode the ground clearance is increased by 25mm above the standard ride height and by 60mm in the lift/off-road mode. These additional modes also enable the tilt angle display feature in the MMI display which facilitates driving on uneven terrain, promotes the off-road characteristics of the vehicle, displays angle inclination and warns the driver of critical situations including roll-over risk. Adaptive air suspension increases trailer load capacity to 3,500kg and also includes loading level lowering (-55mm) via additional buttons in the luggage compartment to facilitate loading. This option is also available with the Dynamic Pack (WB1). Only available with 21" alloys if ordered with Trailer Pack (1D9) and All-wheel steering (0N5)	●	●	£2,000.00

Options are subject to availability and may extend time taken for delivery.

— = Not available
● = Available
S = Standard

Please note that the size of your chosen Q7 wheel may affect the fuel consumption figures and the CO2 emissions. This may result in a change in subsequent Vehicle Excise Duty payable. Please see pages 74 and 77.

*Total RRP inc VAT – Recommended Retail Price including VAT which is calculated at 20%. This may alter to reflect any change in the applicable VAT rate.

Packages

Some items work well together, which is why we've created these special packages.

Options are subject to availability and may extend time taken for delivery.

- = Not available
- = Available
- S = Standard

*Total RRP inc VAT – Recommended Retail Price including VAT which is calculated at 20%. This may alter to reflect any change in the applicable VAT rate.

Order Code	SE	S line	Total RRP inc VAT*
<p>Technology Pack:</p> <ul style="list-style-type: none"> - Audi Virtual Cockpit – 12.3" high resolution LCD display. The fully digital instrument cluster is customisable by the driver. All the functions and services are depicted using superb graphics with a 3D impression and detailed effects in brilliant clarity. The View button on the multi-function steering wheel enables the display of the main instruments to be altered between two different sizes. See pages 18-19 for more information - Audi Connect (3-year subscription) – convenient connection of your vehicle to the internet via an integrated data module with LTE/UMTS connection. Highlights of Audi Connect services include navigation with Google Earth™ and Google Street View™, destination input via myAudi or Google Maps™, access to Google and Twitter, Wi-Fi hotspot, weather and news online and travel information. Please note: an external data source is required to enable Audi Connect Online Services. A separate data SIM card can be inserted in the SIM card reader. Please see pages 20 and 21 for full details. For terms and conditions see page 77 	•	•	£1,950.00
<p>WB4</p> <ul style="list-style-type: none"> - Head-up display – projects warnings or driving-related information from the assistance systems and navigation onto the windscreen into the driver's direct field of vision using an optical system of mirrors. Helps to increase safety, convenience and driving pleasure. Display is adjustable in height - Audi Phone Box – allows phone calls to be made with improved reception quality by placing the mobile phone in the storage compartment provided in the centre console to create a 'wireless' connection to the vehicle aerial. Operated via the MMI control panel or the multi-function steering wheel. Can be charged via a USB port. Audi Phone Box also provides an additional Bluetooth interface for a second device meaning two mobile phones can be connected to the vehicle simultaneously. For mobile phone and software version compatibility, please visit your Audi Centre or audi.co.uk/phonecompatibility Wireless charging available (with Qi enabled compatible phones) or phone can be charged via USB port - High-beam assist – automatically detects the headlights of oncoming traffic, the rear lights of other road users and the lights of built-up areas. Depending on the traffic situation, the main beam is automatically switched on or off 	-	-	£1,200.00
<p>Comfort Pack</p> <ul style="list-style-type: none"> - Comfort front seats with front seat ventilation and headrests with multi adjustment 	•	-	£3,500.00
<p>WB6</p> <ul style="list-style-type: none"> - Perforated Valcona leather upholstery - Driver's side memory function for the electrically adjustable front seats - Electrically, adjustable, folding, heated, auto-dimming door mirrors with memory <p>See page 42 for more information on Comfort seats and Valcona leather</p>	•	-	



Audi Virtual Cockpit



Head-up display

Packages

Vehicle driver assistance and safety systems are not a substitute for attentive driving. Drivers retain full responsibility for providing the necessary inputs for safe control of the vehicle. System descriptions within this brochure are provided for information purposes only. System limitations and operational requirements apply. See manual for details.

Options are subject to availability and may extend time taken for delivery.

- = Not available
- = Available
- S = Standard

*Where the law permits.

**Image shows display on optional Audi Virtual Cockpit, which can be ordered as part of the Technology Pack or as an individual option. Display will appear in the colour Driver's Information System (DIS) without this option.

*Total RRP inc VAT - Recommended Retail Price including VAT which is calculated at 20%. This may alter to reflect any change in the applicable VAT rate.

Order Code	SE	S line	Total RRP inc VAT*
WB1	•	-	£2,800.00
	-	•	£2,655.00

Dynamic Pack:

- **Adaptive air suspension** – electronically controlled air suspension with continuously adaptive damping system for all four wheels which regulates ride height and damping automatically. Additional allroad and lift/off-road modes can be selected via Audi Drive Select in the MMI system. In the allroad mode the ground clearance is increased by 25mm above the standard ride height and by 60mm in the lift/off-road mode. These additional modes also enable the tilt angle display feature in the MMI display which facilitates driving on uneven terrain, promotes the off-road characteristics of the vehicle, displays angle inclination and warns the driver of critical situations including roll-over risk. Adaptive air suspension increases trailer load capacity to 3,500kg and also includes loading level lowering (-55mm) via additional buttons in the luggage compartment to facilitate loading
- **Audi Active Lane Assist** – the system detects lane boundary markings and helps the driver to stay in lane with gentle steering intervention for greater safety and convenience, particularly on motorways. Works at speeds above 37mph. Steering wheel vibration can also be set up when lane markings are crossed
- **Adaptive Cruise Control (ACC) with Stop&Go and distance display/warning** – automatic distance regulation, using radar sensors to maintain the required distance between vehicles ahead by braking and accelerating. Works at speeds between 0 and 155mph.* Five programs (distance 1 to distance 5) can be set
- **Traffic jam assist** – when activated and in conjunction with ACC the system uses the sensors and camera to detect vehicles ahead and on adjacent lanes. When a traffic jam is detected, the system will assist with the braking, acceleration and steering up to 37mph, making your journey a more comfortable one
- **Traffic sign recognition** – detects traffic signs and displays these to the driver on the instrument cluster (or via the optional Audi Virtual Cockpit). These include speed limit signs, even temporary ones
- **Predictive efficiency assist** – when activated, the system calculates a predictive route and uses route data including speed limits, traffic signs, road bends, junctions and roundabouts from the navigation data to give the driver efficiency advice in the instrument cluster (or via the optional Audi Virtual Cockpit) such as when to take your foot off the accelerator. Automatically activates engine coasting mode and Audi Drive Select efficiency mode. In conjunction with the Adaptive Cruise Control (ACC) the system uses the route data and speed limits to adjust the ACC desired speed and cornering accordingly
- **Audi Pre-sense front with collision avoidance assist and turn assist** – when the system detects the risk of a collision with the vehicle in front a visual and acoustic warning is given to the driver followed by partial braking, or at speeds under 19mph, the system may apply full braking. In addition, the system will calculate if an appropriate evasion lane is available and apply supportive steering to aid the driver. If a crash is sensed the airbags will be pre-conditioned and the braking system prepared to assist with the necessary braking force once the brake pedal is touched. When turning at crossroads, from the moment the turn indicators are activated the turn assist system detects approaching vehicles and applies braking to help avoid a collision



Adaptive Cruise Control with Stop&Go and distance/display/warning**



Adaptive air suspension (featuring allroad and lift/offroad modes)



Traffic sign recognition**

Packages

Vehicle driver assistance and safety systems are not a substitute for attentive driving. Drivers retain full responsibility for providing the necessary inputs for safe control of the vehicle. System descriptions within this brochure are provided for information purposes only. System limitations and operational requirements apply. See manual for details.

Options are subject to availability and may extend time taken for delivery.

- = Not available
- = Available
- S = Standard

*Total RRP inc VAT – Recommended Retail Price including VAT which is calculated at 20%. This may alter to reflect any change in the applicable VAT rate.

Order Code	SE	S line	Total RRP inc VAT*
PCF Parking Assist Pack - Park Assist – ultrasonic sensors help identify suitable parking spaces before enabling an effortless manoeuvre into them – steering is done by the vehicle, while the driver needs to accelerate and apply the brakes - Parking System Advanced with surround view camera – aids parking and manoeuvring using 4 cameras. Cameras are mounted in the front grille, the handle of the boot lid and the housing of the two exterior mirrors. Enables the driver to view the entire area around the vehicle by means of the MMI display. The driver can choose between different image representations in the MMI display, including a live 'bird's-eye view' image for parking. Only in combination with exterior mirrors with memory function (6XF or 6XL)	•	•	£1,150.00
PCZ Parking Pack Advanced Includes all the contents of the Parking Assist Pack as well as: - Audi Side Assist – when activated the system aids the driver when changing lane. Audi Side Assist monitors the area behind the vehicle, using radar sensors located discreetly in the rear bumper, informing the driver with a visual warning signal in the door mirror if there is a vehicle in their blind spot or approaching quickly from behind - Audi Pre-sense basic and Pre-sense rear – if the system detects an unusual driving manoeuvre or potential rear-end collision, the system implements various measures to help protect the driver and passengers including electrical tightening of the seat belts in the front, automatic closure of windows and sunroof (if applicable). Upper backrest and headrest are adjusted automatically (where memory seats are fitted) to provide more protection. Furthermore auto-activation of the warning light alerts traffic behind to a hazard situation - Rear traffic crossing – aids the driver when reversing out of parking spaces as the system detects any vehicles suddenly crossing from behind. The system alerts the driver both via the MMI and acoustically, applying the brakes if a potential collision is detected - Exit warning – monitors the rear and side of your stationary Audi Q7 and warns the occupants before they exit their vehicle that vehicles/cyclists are approaching from behind Only in combination with exterior mirrors with memory function (6XF or 6XL)	•	•	£1,800.00



Park Assist featured in Parking Assist Pack or Parking Pack Advance



Exit warning featured in Parking Pack Advanced or Audi Side Assist including Pre-sense rear and exit warning

Packages

Vehicle driver assistance and safety systems are not a substitute for attentive driving. Drivers retain full responsibility for providing the necessary inputs for safe control of the vehicle. System descriptions within this brochure are provided for information purposes only. System limitations and operational requirements apply. See manual for details.

Options are subject to availability and may extend time taken for delivery.

- = Not available
- = Available
- S = Standard

*Total RRP inc VAT – Recommended Retail Price including VAT which is calculated at 20%. This may alter to reflect any change in the applicable VAT rate.

Order Code	SE	S line	Total RRP inc VAT*
<p>Audi Side Assist including Pre-sense rear and exit warning</p> <ul style="list-style-type: none"> - Audi Side Assist – when activated the system aids the driver when changing lane. Audi Side Assist monitors the area behind your car, using radar sensors located discreetly in the rear bumper, informing the driver with a visual warning signal in the door mirror if there is a vehicle in their blind spot or approaching quickly from behind - Exit warning – monitors the rear and side of your stationary Audi Q7 and warns the occupants before they exit their vehicle that vehicles/cyclists are approaching from behind - Audi Pre-sense basic and Pre-sense rear – if the system detects an unusual driving manoeuvre or potential rear-end collision, the system implements various measures to help protect the driver and passengers including electrical tightening of the seat belts in the front, automatic closure of windows and sunroof (if applicable). Upper backrest and headrest are adjusted automatically (where memory seats are fitted) to provide more protection. Auto-activation of the warning light also alerts traffic behind to a hazard situation 	•	•	£750.00
<p>Trailer Pack</p> <p>Assists the driver when reversing with a trailer. Includes electrically folding tow bar and trailer assist</p> <ul style="list-style-type: none"> - Tow bar <ul style="list-style-type: none"> - Electrically folding ball hitch operated via buttons in the luggage compartment - Includes stabilisation via the Electronic Stability Programme (ESC) - Includes single 13-pin socket for use of electrical appliances in the trailer or caravan - Trailer assist <ul style="list-style-type: none"> - Supports the driver when reversing a vehicle with a trailer, making manoeuvring easier - System is activated at the press of a button when reverse gear is engaged. The system analyses the trailer angles and path which is displayed on the MMI display. The driver can adjust the desired angle or desired path of travel via the rotary push-button control of the MMI system - On activation the system automatically steers the vehicle and trailer in the direction specified. Allows control of the vehicle and trailer without the use of a steering wheel. The driver only selects the gear, accelerates, brakes and monitors the driving. The system automatically brakes if the driver exceeds a defined speed or if a critical articulation angle is reached - The active assistant can prevent collision between vehicle and trailer - Compatible with all trailers with rigid drawbars <p>Please note – if ordered with adaptive air suspension (available as part of the Dynamic Pack) trailer load increases to 3,500kg</p>	•	•	£1,300.00



Electrically folding tow bar featured in Trailer Pack

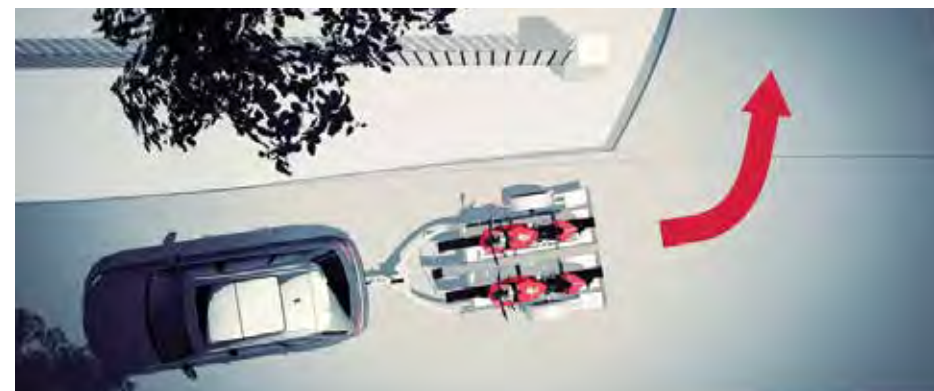

Trailer assist featured in Trailer Pack

Headlights

Order Code		SE	S line	Total RRP inc VAT*
8G1	High-beam assist. Variable headlight range control featuring a camera on the interior mirror which registers sources of light from other road users. The range and width of the headlight beam are continuously varied between dipped and main beam to suit ambient conditions, ensuring that the headlights provide good visibility without dazzling other road users. Not available in combination with Audi Matrix LED headlights (PXC). This option is also available as part of the Technology Pack (WB4) – see page 54 for details	●	S	£145.00
PX2	All-weather LED headlights – includes high-beam assist and dynamic rear indicators - All-weather LED headlights. LEDs for all front lighting functions. LED technology provides lower energy consumption and enhanced contrast with a colour similar to daylight, for increased safety and good recognition by other road users. Includes all-weather light function to reduce the risk of the driver being dazzled when visibility is poor (in fog, rain or snow) - High-beam assist – automatically adjusts headlights from high-beam to dipped-beam when another vehicle is approaching or when other ambient lighting is detected (e.g. streetlights) by a camera on the interior mirror - Dynamic rear indicators – with dynamic indicators which sweep from inside to out. This helps to clearly identify not only that the vehicle is turning but in which direction – increasing road safety as it is easier for other road users to determine which way the vehicle is moving in a shorter amount of time. Not available in combination with Audi Matrix LED headlights (PXC)	●	S	£1,550.00
PXC	Audi Matrix LED headlights – A direct evolution of Audi’s LED headlights, Audi Matrix technology provides maximum and precise illumination at all times without dazzling other road users. The vehicle uses information obtained from multiple sources including the interior mirror camera and navigation system to identify the appropriate lighting required; using GPS data the vehicle will use high-beam, but will automatically switch to dipped lighting when entering built up areas; whilst high-beam is in use, and oncoming traffic is detected, the Matrix beam dips or fully extinguishes individual LEDs. Matrix beam is capable of establishing and tracking multiple road users and illuminating the appropriate corridors of lights either side of them to maintain maximum visibility of the road and surrounding environment without causing disruption to other drivers. Matrix beam technology includes dynamic rear indicators which sweep from inside to out. This helps to clearly identify not only that the vehicle is turning but in which direction – increasing road safety as it is easier for other road users to determine which way cars are moving in a shorter amount of time	●	–	£2,450.00
		–	●	£950.00

Options are subject to availability and may extend time taken for delivery.

- = Not available
- = Available
- S = Standard

*Total RRP inc VAT – Recommended Retail Price including VAT which is calculated at 20%. This may alter to reflect any change in the applicable VAT rate.



All-weather LED headlights



Audi Matrix LED headlights

Audio and communication

Stay in touch using our range of communication functions, and give each journey its own soundtrack with our advanced audio equipment.

Options are subject to availability and may extend time taken for delivery.

- = Not available
 • = Available
 S = Standard

*Total RRP inc VAT – Recommended Retail Price including VAT which is calculated at 20%. This may alter to reflect any change in the applicable VAT rate.

Order Code		SE	S line	Total RRP inc VAT*
9VS	BOSE® 3D Sound System – BOSE® fills the cabin of the Audi Q7 with crystal clear sound. Includes: - 3D sound with BOSE® Advanced Staging Technology - 19 speakers including 3D Sound speaker, centre speaker and subwoofer - 15-channel amplifier with a total output of over 558 watts - 3D sound for front seats - Lighting in the loudspeaker trims	•	•	£1,100.00
8RF	Bang & Olufsen 3D Advanced Sound System – provides concert hall acoustics with 3D sound reproduction. Includes: - 23 speakers including 3D Sound speaker, centre speaker and subwoofer, each with their own amplifier and aluminium speaker covers - 23-channel amplifier with a total output of over 1,920 watts, fully digitised with highly efficient ICE Power amplifier - Spatial 3D sound reproduction for front seats - Two automatically extending acoustic lenses on the instrument panel and digital signal processor (DSP) for excellent sound in every seat - Sound can be customised for the seat positions of the vehicle occupants - Privacy feature shields music and phone calls from outside – useful for confidential conversations in hands-free mode - System automatically adapts to the vehicle and background noise	•	•	£6,300.00
KS1	Head-up display – projects warnings or driving-related information from assistance systems and navigation onto the windscreen into the driver's direct field of vision. Helps to increase safety, convenience and driving pleasure. Display is adjustable in height. This option is also available with the Technology Pack (WB4)	•	•	£1,350.00
IT1	Audi Connect (3-year subscription) – convenient connection of your vehicle to the internet via an integrated data module with LTE/UMTS connection. Highlights of Audi Connect services include navigation with Google Earth™ and Google Street View™, destination input via myAudi or Google Maps™, access to Google and Twitter, Wi-Fi hotspot, weather and news online and travel information. Please note an external data source is required to enable Audi Connect online services. A separate data SIM card can be inserted in the SIM card reader. See details on pages 20 and 21 and terms and conditions on page 77. This option is also available with the Technology Pack (WB4)	•	•	£350.00



BOSE® 3D Sound System



Bang & Olufsen 3D Advanced Sound System



Bang & Olufsen 3D Advanced Sound System

Audio and communication

Options are subject to availability and may extend time taken for delivery.

- = Not available
- = Available
- S = Standard

*Android systems require the download of the Android Auto app.

**Availability of applications differ by operating systems and is dependant on approval by Apple or Google. Permanent availability cannot be guaranteed as this is the responsibility of Apple or Google. Smartphone interface uses Apple CarPlay, which is available with iPhone 5 or above, or Android Auto, which is available with phones using Android 5.0 Lollipop or above. Use of certain apps with Smartphone interface will be subject to signal availability of the mobile network in your location and in-car usage may increase your mobile data usage. If using regularly, a mobile phone contract including an unlimited or high amount of data is recommended.

*Total RRP inc VAT – Recommended Retail Price including VAT which is calculated at 20%. This may alter to reflect any change in the applicable VAT rate.

Order Code		SE	S line	Total RRP inc VAT*
958	Audi Virtual Cockpit – 12.3” high resolution LCD display. The fully digital instrument cluster is customisable by the driver. All the functions and services are depicted using superb graphics with a 3D impression and detailed effects in brilliant clarity. The View button on the multi-function steering wheel enables the display of the main instruments to be altered between two different sizes. Also available in Technology Pack (WB4) (see page 54 for details). For more information on Audi Virtual Cockpit please see pages 18 and 19	•	•	£600.00
9ZE	Audi Phone Box – allows phone calls to be made with improved reception quality by placing the mobile phone in the storage compartment provided in the centre console to create a ‘wireless’ connection to the vehicle aerial. Operated via the MMI control panel or the multi-function steering wheel. Can be charged via a USB port. Audi Phone Box also provides an additional Bluetooth interface for a second device meaning two mobile phones can be connected to the vehicle simultaneously. For mobile phone and software version compatibility, please visit your Audi Centre or audi.co.uk/phonecompatibility Wireless charging available (with Qi enabled compatible phones) or phone can be charged via USB port. This option is also available with the Technology Pack (WB4)	•	•	£450.00
6G2	DVD changer. DVD/CD changer, for 6 DVDs or CDs. Supports audio CDs and video DVDs. Shock resistant. Located in the boot of the vehicle	•	•	£650.00
7A7	Audi Smartphone Interface – connects your compatible smartphone with your Audi Q7 bringing your mobile content via USB* directly into the MMI display. Utilising Android Auto or Apple CarPlay, you can access approved apps** for navigation via your Maps app, keeping in touch via messages, phone or selected 3rd party apps** like WhatsApp, listening to the music on your phone or streaming music from 3rd party apps** all of which can be easily controlled via the MMI controller and via the voice control system on your phone	•	•	£350.00



Audi Virtual Cockpit



Audi Smartphone Interface using Apple CarPlay

Audio and communication

Order Code		SE	S line	Total RRP inc VAT*
9WQ	Audi Entertainment Mobile. Includes two detachable high definition 10.1" touchscreens fitted to the back of the front seats (supplied by Audi Genuine Accessories*). The backs of the front seats are fitted with mountings and power connections. The system can be used outside the car with rechargeable battery, which is included in the package. Content is either streamed from your iOS (iPhone) or Android (Samsung, HTC, Sony etc) smartphone via an Audi App, via an integrated SD card reader, USB cable, Miracast Wi-Fi or Bluetooth. Includes two sets of headphones, USB cable and storage bag	●	●	£1,180.00
QU1	Digital TV reception. Reception of digital (DVB-T) uncoded television stations (MPEG-2 standard), TV picture, teletext and Electronic Programme Guide (EPG). Facility to connect 2 external AV sources via adaptor cables (available from Audi Genuine Accessories). Please note: TV reception depends on local digital network availability. Picture display only possible on MMI screen when your Audi Q7 is stationary, audio available at all times	●	●	£1,100.00

Options are subject to availability and may extend time taken for delivery.

- = Not available
- = Available
- S = Standard

*Screens must be ordered by your Audi Centre via Audi Genuine Accessories.

*Total RRP inc VAT – Recommended Retail Price including VAT which is calculated at 20%. This may alter to reflect any change in the applicable VAT rate.



Audi Entertainment Mobile

Interior equipment

Specify every detail of your car's interior with this range of exclusive options.

Options are subject to availability and may extend time taken for delivery.

- = Not available
- = Available
- S = Standard

*Total RRP inc VAT – Recommended Retail Price including VAT which is calculated at 20%. This may alter to reflect any change in the applicable VAT rate.

Order Code		SE	S line	Total RRP inc VAT*
PK2	Deluxe 4-zone automatic climate control – features a digital display control panel, separate temperature control for driver, front passenger and rear passengers; additional air conditioning controls with digital display for climate control in the rear with separately adjustable temperature and blower settings and air distribution for the right and left-hand sides (rear functions can also be set from the front air conditioning controls). It also comes with additional air vents in the B-pillars; also includes a button which synchronises the driver's air conditioning setting with those in the front and rear and an eco button for selection of efficiency optimised air conditioning. Includes additional chrome strip across the front air vent	•	S	£750.00
QQ2	Ambient Lighting Pack – in addition to standard interior lighting package - Contour lighting for centre console - Ambient lighting for centre console - Front and rear illuminated door sill plates - Interactive colour profiles: includes 3 pre-defined colour profiles controlled via MMI	•	•	£280.00
3Y3	Manual sun blind for rear window and rear door windows In combination with Leather packages (7HD/7HE)	•	•	£280.00 £0.00
6E6	Comfort front centre armrest – for driver and front passenger, forwards/backwards position can be adjusted. Also includes a storage compartment	•	S	£115.00
3CX	Removable net partition. Located between rear seats and rear luggage compartment. Can be used with rear seatback in upright position, one side folded down, or completely folded down	•	•	£100.00
9JA	Non-smoking pack – replaces ashtray and cigarette lighter with 12V socket and centre storage compartment. Ashtrays in rear door armrests unchanged	•	•	£0.00



Deluxe 4-zone automatic climate control at the rear



Deluxe 4-zone automatic climate control



Ambient Lighting Pack

Interior equipment

Order Code		SE	S line	Total RRP inc VAT*
3GN	Load-area fixing kit. Includes fixing set for the rail system in the luggage compartment, with telescopic bar and securing belt for dividing up luggage compartment	●	●	£275.00
6SJ	Reversible mat – Velour on one side, rubber on the other. Folds out to cover the luggage compartment, even with the rear seats folded down	●	●	£115.00
PKC	Electric luggage compartment cover – luggage compartment cover opens and closes electrically, can also be operated manually. Includes stainless steel bumper protection	●	●	£250.00
6NQ	Headlining in black cloth	●	S	£300.00
PL2	Headlining in black Alcantara – includes double sun visors	●	●	£1,425.00
		In combination with Leather packages (7HD/7HE)		● ●
PL6	Alcantara headlining – to match interior colour, includes double sun visors	●	–	£1,425.00
		In combination with Leather packages (7HD/7HE)		● –

Options are subject to availability and may extend time taken for delivery.

- = Not available
- = Available
- S = Standard

*Total RRP inc VAT – Recommended Retail Price including VAT which is calculated at 20%. This may alter to reflect any change in the applicable VAT rate.



Load-area fixing kit

Interior equipment

Order Code		SE	S line	Total RRP inc VAT*
7HC	<p>Leather package – includes leather to match chosen seat colour with decorative stitching, in the following areas:</p> <ul style="list-style-type: none"> - Door pull handles - Front centre console trim - Armrests in doors - Underside of instrument panel - Lower door trim 	●	●	£1,500.00
7HD	<p>Extended leather package – includes Fine Nappa leather to match chosen seat colour with decorative stitching, in the following areas:</p> <ul style="list-style-type: none"> - Door pull handles - Front centre console trim - Armrests in doors - Underside of instrument panel - Lower door trim - Top side of instrument panel* - Upper door trim including door rails <p>Includes the following areas in Alcantara:</p> <ul style="list-style-type: none"> - Headlining (PL2/PL6) - Double sun visor <p>Also sunblind at the rear and on the rear side windows in matching colour (3Y3) Not available with standard seats. On SE models only available with Comfort front centre armrest (6E6)</p>	●	●	£5,500.00
7HE	<p>Full leather package – includes Fine Nappa leather to match chosen seat colour with decorative stitching, in the following areas:</p> <ul style="list-style-type: none"> - Door pull handles - Front centre console trim - Armrests in doors - Top side of instrument panel* - Underside of instrument console - Lower door console - Upper door trim including door rails <p>Includes the following areas in matching colour Alcantara:</p> <ul style="list-style-type: none"> - Headlining (PL2/PL6) - Double sun visor <p>Also sunblind at the rear and on the rear side windows in matching colour (3Y3) Not available with standard seats. On SE models only available with Comfort front centre armrest (6E6)</p>	●	●	£6,000.00

Options are subject to availability and may extend time taken for delivery.

- = Not available
● = Available
S = Standard

*In combination with Head-up display (KS1) or Technology Pack (WB4), the panel of the Head-up display will not be covered in leather.

*Total RRP inc VAT – Recommended Retail Price including VAT which is calculated at 20%. This may alter to reflect any change in the applicable VAT rate.

Exterior equipment

Make sure your car looks exactly as you want it to by selecting some of our striking options.

Order Code		SE	S line	Total RRP inc VAT*
3S2	Black roof rails	●	●	£0.00
3FU	Panoramic glass sunroof – comprises two sections, whereby the front glass section can be tilted or slid open and closed again electrically. Also includes electrically operated sun blind. Sunroof can also be closed from the outside via the central locking	●	●	£1,700.00
6XF	Exterior mirrors – heated, electrically adjustable and folding, with automatic kerb view function which tilts the passenger mirror downwards towards the kerb when reverse gear is engaged. Includes memory function. Only available with Electrically adjustable front seats with memory (PV3 or PV6)	●	●	£100.00
6XL	Exterior mirrors – heated, electrically adjustable, folding and auto-dimming, with automatic kerb view function which tilts the passenger mirror downwards towards the kerb when reverse gear is engaged. Includes memory function. Only available with Electrically adjustable front seats with memory (PV3 or PV6). This option is also available in Comfort Pack (WB6)	●	●	£200.00
GZ2	Power door closure – automatically pulls doors closed that are not completely engaged into the lock	●	●	£625.00
4KF	Privacy glass – dark tinted rear and rear-side windows (from B-pillar backwards)	●	S	£450.00
PDG	Heat/sound-insulating glass – windscreen and front side windows made of heat/sound insulating glass. Rear window features standard single-layer safety glass. Also includes a clear area in the upper section of the driver's side windscreen for toll road pass tags. Please consult your Audi Centre for more details	●	–	£1,150.00
PDJ	Heat/sound-insulating glass with privacy glass – windscreen and front side windows made of heat/sound insulating glass. Rear and rear side windows feature tinted standard single-layer safety glass. Also includes a clear area in the upper section of the driver's side windscreen for toll road pass tags. Please consult your Audi Centre for more details	●	–	£950.00
		–	●	£525.00
4GR	Heated windscreen – heated windscreen in insulating/acoustic glass, facilitates rapid defrosting and provides a condensation-free windscreen. Controlled via a button on the air conditioning controls; additionally the windscreen's reflective coating reduces the windshield heating the interior. Does not include clear section for toll passes	●	●	£700.00
		●	●	£400.00 In combination with Heat/sound insulating glass (PDG or PDJ)
2Z0	Deletion of model and technology designation at rear	●	●	£0.00
2Z7	Deletion of technology designation at rear	●	●	£0.00
PTT	85-litre fuel tank and 24-litre AdBlue® tank	●	●	£115.00

Options are subject to availability and may extend time taken for delivery.

– = Not available
● = Available
S = Standard

*Total RRP inc VAT – Recommended Retail Price including VAT which is calculated at 20%. This may alter to reflect any change in the applicable VAT rate.

Safety and security

Intelligent technology designed to give you better all-round awareness and safety on the road.

Vehicle driver assistance and safety systems are not a substitute for attentive driving. Drivers retain full responsibility for providing the necessary inputs for safe control of the vehicle. System descriptions within this brochure are provided for information purposes only. System limitations and operational requirements apply. See manual for details.

Options are subject to availability and may extend time taken for delivery.

- = Not available
- = Available
- S = Standard

*Image shows display on optional Audi Virtual Cockpit, which can be ordered as part of the Technology Pack. Display will appear in the Colour Driver's Information System (DIS) without this option.

**Trailer mode only available with Trailer Pack.

*Total RRP inc VAT - Recommended Retail Price including VAT which is calculated at 20%. This may alter to reflect any change in the applicable VAT rate.

Order Code		SE	S line	Total RRP inc VAT*
PG3	Advanced key – access and authorisation system that works through automatic data exchange between key and vehicle, allowing the driver to keep their car key in their pocket or bag at all times. To unlock and open, simply lift the exterior door handle. The door is locked by pressing the button on the handle. Pressing the start/stop button integrated in the centre console starts and stops the engine. Includes electric luggage compartment cover (PKC) (and on SE also includes stainless steel bumper protection)	•	•	£950.00
9R1	Night vision assistant – assists the driver when driving at night by displaying a thermal image of the surroundings. People and large animals are highlighted in yellow in the colour display of the Driver's Information System. If the system determines from their position that there is a potential risk, the marking changes to red, a warning triangle appears and a warning tone is emitted. Warning can also be shown in the Head-up display if ordered. In conjunction with High-beam assist (8G1), LED headlights with High-beam assist (PX2) or Audi Matrix LED headlights (PXC) the highlighted person is also illuminated with three successive brief flashes of the headlights. If ordered, the system operation may be restricted in too much ambient light, high humidity and high night temperatures (over 28°C)	•	•	£2,000.00
KA2	Rear-view camera – makes it easier to manoeuvre by displaying the area behind the vehicle in the MMI display with dynamic and static help elements. Two modes (transverse parking and trailer mode**) can be selected. Depending on the selected mode, the calculated trajectory is displayed with help and guide lines. The reversing camera is discreetly integrated into the handle of the tailgate	•	•	£500.00
4X4	Rear side airbags – for the outer rear seats, incorporated into the seat backrests. Supplement the side impact protection in the doors and the standard airbag systems	•	•	£350.00
ON5	All-wheel steering – improves the driving dynamics and the driving comfort as a result of additional steerability of the rear axle. At lower speeds, the rear axle self-steers, oppositely to the steering angle of the front axle this results in higher agility, a smaller steering angle making manoeuvring easier, especially in tight bends and when parking. At higher speeds, steering in the same direction improves the responsiveness as well as the driving dynamics, cornering and vehicle stability. All-wheel steering supports the parking and manoeuvring processes of park assist and of trailer assist. All-wheel steering generally enables easier manoeuvring, sportier handling and a confident, comfortable steering response. Reduces turning circle from approx 12.4m to 11.4m	•	•	£1,100.00
PCN	Tour Pack – includes Audi Active Lane Assist, Adaptive Cruise Control (ACC) with Stop&Go and distance display warning, Traffic jam assist, Traffic Sign recognition, Predictive efficiency assist and Audi Pre-sense front with collision assist and turn assist. Please see Dynamic Pack (WB1) on page 55 for more information	•	–	£1,850.00
		–	•	£1,705.00



Night vision assistant*



All-wheel steering

Steering wheels

Our steering wheels are available in a range of textures and designs, and can give you control over everything from your Satellite Navigation system to the S tronic transmission.

Order Code		SE	S line	Total RRP inc VAT*
2PF	3-spoke flat-bottomed leather multi-function Sport steering wheel – with gear-shift paddles	–	●	£150.00
2ZM	Heated 4-spoke leather multi-function steering wheel – with gear-shift paddles	●	–	£215.00
1XP	Heated 3-spoke leather multi-function Sport steering wheel – with gear-shift paddles	–	●	£350.00
2C7	Electrically adjustable steering column – adjustable for height and reach with auto easy-entry and exit function	●	●	£400.00

Options are subject to availability and may extend time taken for delivery.

- = Not available
- = Available
- S = Standard

*Image shows display on optional Audi Virtual Cockpit, which can be ordered as part of the Technology Pack.

*Total RRP inc VAT – Recommended Retail Price including VAT which is calculated at 20%. This may alter to reflect any change in the applicable VAT rate.



3-spoke flat-bottomed leather multi-function Sport steering wheel with gear-shift paddles*



4-spoke leather multi-function steering wheel, with gear-shift paddles*

Looking after your Audi

When you've chosen your ideal model, it's reassuring to know that it will remain in safe hands. That's why we've created products to protect your Audi: from extended warranties to Audi Complete – our comprehensive service and maintenance package. And there's also a range of Audi accessories and merchandise to choose from, enabling you to further enhance and safeguard your car.





Audi Complete

If you drive under 10,000 miles per annum your vehicle will be placed on a Fixed Inspection Service schedule. If your mileage tends to exceed 10,000 miles per annum it will be placed on the Flexible Service schedule.

Warranty

All new Audi models come with a three-year warranty as standard, and you can choose to extend this to a four or five-year warranty* for a one-off cost. What's more, if you decide to sell your Audi before the warranty expires, it will be fully transferred to the new owner.

- = Not available
● = Available
S = Standard

*Three-year warranty consists of a two-year unlimited mileage warranty and a third year warranty with a 60,000-mile limitation. Four-year warranty consists of a two-year unlimited mileage warranty and two further years' coverage with a 75,000-mile limitation. Five-year warranty consists of a two-year unlimited mileage warranty and three further years' coverage with a 90,000-mile limitation.

**Only available before registration of your Audi Q7. Please speak to your Audi Centre for full details.

*Total RRP inc VAT - Recommended Retail Price including VAT which is calculated at 20%. This may alter to reflect any change in the applicable VAT rate.

Audi Complete is our fixed-cost maintenance plan, which helps you keep your Audi in top condition and stay in control of your finances. For a simple monthly payment, you could cover your car's servicing, maintenance and, if you want, its tyres too.

So not only will you ensure your car runs smoothly, regular servicing can also protect its future resale value. And because everything's covered by one competitive price, there's no need to go anywhere else.

Pricing is completely tailored to your vehicle and takes into consideration the options you have on your vehicle and your likely annual mileage and resultant service schedule. Please speak to your Audi Centre for a personalised quote for Audi Complete.

Order Code		Q7	Total RRP inc VAT*
-	Audi Warranty , covering you for unlimited mileage in the first two years of ownership, and up to 60,000 miles in the third year. Transferable between owners**	S	£0.00
EA6	Audi Warranty , covering you for up to 4 years or 75,000 miles, whichever comes sooner. Cover includes a two-year unlimited mileage warranty, and up to 75,000 miles in the third and fourth years. Transferable between owners**	●	£560.00
EA9	Audi Warranty , covering you for up to 5 years or 90,000 miles, whichever comes sooner. Cover includes a two-year unlimited mileage warranty, and up to 90,000 miles in the third, fourth and fifth years. Transferable between owners**	●	£1,335.00



Accessories

Choosing an Audi isn't just a matter of deciding on the model you want – it's about creating a car that perfectly suits your needs. And that's why we've developed a whole range of optional accessories to enhance your Audi Q7, enabling you to customise it down to the last detail. Like your Audi, all these accessories are developed to the highest possible standards. And they're all available exclusively from Audi.

So whether you are looking for mats or a loadliner, to find out more just visit audi.co.uk/accessories or contact your local Audi Centre.

Warranty

All the accessories available on the Audi Q7 are covered by a three-year warranty* if they are ordered and included in the purchase price of the car at date of delivery. Any accessories ordered and installed after delivery include a two-year warranty.*

*Excluding Road Angel products. Audi Accessories warranty terms and conditions can be found at audi.co.uk/warrantyterms



Merchandise

From the enthusiasts' motorsport collection to the sophisticated Audi collection, there's a wide variety of adults' and children's clothing, lifestyle accessories and collectables, all of which bear the Audi name.

Please speak to a member of our team at your local Audi Centre to see the full Audi collection and to place an order. A selection of Audi merchandise is also available to buy from audi.co.uk/merchandise



Image shown is the Audi kids' car legends, item number 320.13.004.00

The Audi Difference

The experts in Vorsprung durch Technik

Our Audi Approved Master Technicians have undergone an impressive 100,000 hours of training over a 10-year programme to ensure they have the latest technical expertise for maintaining and servicing your Audi. All our Service Advisors undergo a specialist induction and training to ensure they are Audi professionals and able to talk to you about any issues you may have with your Audi vehicle.

Servicing tailored to your needs

Regular servicing is key to safeguarding your Audi's performance and a full service history could help you enhance the future re-sale value. To make servicing easy, the Audi Service Schedules have been designed to work with your individual driving style and vehicle.

We offer two different schedules: the Fixed Inspection Service and the Flexible Service schedule. The conventional Fixed Inspection Service schedule has fixed intervals for the Oil-change Service and Inspection Service, which are determined by time and distance.

With the Flexible Service schedule, the Inspection Service intervals are also fixed but the Oil-change Service intervals are variable. Sensors take account of driving style and conditions to determine when the Oil-change Service is required and the driver is informed via the on-board service interval display.

The choice of Service Schedule will depend on journey type and mileage as well as individual driving style and conditions. The table to the right can be used for guidance but your Audi Centre will help you to determine the most suitable Service schedule for you based on your individual circumstances and preferences.

Fixed Inspection Service Schedule

	Vehicle usage:
Mileage	Less than 10,000 miles per annum. Mainly city/town centre driving. Short journeys.
	Service intervals:
Oil-change Service	Fixed to every 9,000+ miles/1 year
Inspection Service	Fixed to every 19,000+ miles/2 years

Flexible Service Schedule

	Vehicle usage:
Mileage	More than 10,000 miles per annum. Motorway and main road driving. Mainly longer distance journeys. Constant speeds.
	Service intervals:
Oil-change Service	Variable to a maximum of every 19,000+ miles/2 years
Inspection Service	Fixed to every 19,000+ miles/2 years

When a vehicle is frequently used in the following conditions, we recommend a Fixed Inspection Service Schedule, regardless of mileage:

Uneconomical driving styles, e.g. heavy acceleration and braking, constant use of high revs

High engine-loading conditions, e.g. frequent towing and hill climbs

*As indicated by the service interval display. Mileages are approximate as the Service Indicator system uses kilometres as its distance measurement.

Your convenience comes first

At Audi you can choose from a range of convenient services that suit your needs. Why not book a 'service while you wait' appointment* and enjoy our complimentary refreshments while your car is with us? Or, if you need to be mobile, take advantage of one of our courtesy cars which we can even deliver to you.* We guarantee we can service your Audi within 5 days without a courtesy car or within 10 days if you need transport. We will also ensure your car is returned to you with a full valet.

Audi Genuine Parts

You can rest assured that only Audi Genuine Parts will be used on your vehicle. What's more, Audi parts and labour come with a 2-year guarantee.**

No hidden costs

We believe strongly in transparency when it comes to our prices. For added peace of mind, we will give you a quotation over the phone for the work you have requested and email you the price confirmation. We'll consult you if any additional work on your car is needed when it is with us. We won't carry out any extra work without asking your permission first.

All part of the service

Whenever we see an Audi for a service, we connect it directly to our headquarters in Ingolstadt which enables us to check your car's software and make sure it's as up-to-date as possible. If the factory has released a software upgrade for your model, it can be applied immediately - improving anything from your car's efficiency to the precision of its parking system.

Audi Roadside Assistance

Your new car comes complete with 3 years' complimentary roadside assistance and recovery across the UK, provided by Automobile Association Insurance Services Limited. Also included is roadside assistance throughout Europe, managed by Automobile Association Insurance Services Limited.

For further information and terms and conditions please visit audi.co.uk

*Subject to availability.

**Excludes wear and tear.



Audi Q7

technical data

Depending upon your chosen Audi Q7 wheel size, different efficiency figures for CO₂ emissions and fuel consumption will apply (based on EU directive no. 715/2007 effective from 01/09/14). This table is a quick reference guide to assist you in finding the correct values based on the wheel sizes and chosen engine.

*Highest insurance group rating shown. Group may be lower dependent on trim level. Please visit thatcham.org/abigrouprating for details.

**Trailer load figure for vehicles with adaptive air suspension (see dynamic pack).

^The addition of AdBlue® technology ensures compliance with EU6 emission standards. The use of AdBlue® will vary based on a number of conditions and the tank requires refilling when indicated on the instrument cluster.

¹The given values were obtained in accordance with the specified measurement procedure (the respective current version of the Directive 80/1269/EEC).

²Fuel consumption and CO₂ emissions figures are obtained under standardised test conditions (Directive 93/116/EEC) using a representative model. This allows direct comparison between different models from different manufacturers, but may not represent the actual fuel consumption achieved in 'real world' driving conditions. More information is available at dft.gov.uk/vca

³Vehicle's unladen weight without driver (calculated in accordance with the current version of Directive 92/21/EEC). The fitting of additional equipment may increase the vehicle's unladen weight and drag coefficient, whereupon the potential carrying capacity and top speed will be correspondingly reduced.

⁴The engine's power output always goes down with increasing altitude. At 1,000m above sea level, and for every additional 1,000m, deduct 10% from the weight of the outfit (trailer load limit + gross weight of the towing vehicle). Value applies to trailer load for factory-fitted trailer towing hitch.

Please note: The maximum power output figures are quoted in PS (or Pferdestärke, which is the metric equivalent of brake horsepower). To convert to brake horsepower, divide the PS figure by 1.0139.

Standard EU test figures for comparative purposes and may not reflect real driving results.

Optional wheels may also affect emissions and fuel consumption figures.

Engine	3.0 TDI quattro	3.0 TDI quattro
Transmission	8-speed tiptronic	8-speed tiptronic
Cylinder	6-cylinder	6-cylinder
Displacement, cubic cm (valves per cylinder)	2967 (4)	2967 (4)
Max. power, ¹ PS at rpm	218/3250-4750	272/3250-4250
Max. torque, Nm at rpm	500/1250-3000	600/1500-3000
Top speed, ² mph	134	145
0-62mph acceleration, seconds	7.3	6.5
ABI insurance group 1-50*	TBC	41E
Unladen weight, ³ kg	2060	2060
Gross weight limit, kg	2940	2940
Roof load limit/nose weight, kg	100/115	100/115
Max. trailer load unbraked, ⁴ kg	750	750
Max. trailer load with 12% gradient, ⁴ kg	2800 (3,500**)	2800 (3,500**)
Max. trailer load with 8% gradient, ⁴ kg	2800 (3,500**)	2800 (3,500**)
Luggage compartment capacity, litres (second value is with the third row of seats folded down; third value is with folded rear seat back and loaded to the roof)	295/770/1955	295/770/1955
Fuel tank capacity approx, litres	75	75
AdBlue® tank approx capacity, litres [^]	12	12
Emission standard	EU6	EU6

Engine	3.0 TDI quattro	3.0 TDI quattro	
Transmission	8-speed tiptronic	8-speed tiptronic	
Max. power, ¹ PS at rpm	218/3250-4750	272/3250-4250	
CO ₂ emissions, ² g/km	18" wheels	148	-
	19" wheels	150	153
	20" wheels	150	153
	21" wheels	161	163
Benefit in kind (BIK)%	18" wheels	27%	-
	19" wheels	28%	28%
	20" wheels	28%	28%
	21" wheels	30%	30%
Fuel consumption, ² mpg (l/100km) Urban	18" wheels	44.8 (6.3)	-
	19" wheels	44.8 (6.3)	44.1 (6.4)
	20" wheels	44.8 (6.3)	44.1 (6.4)
	21" wheels	42.8 (6.6)	42.2 (6.7)
Fuel consumption, ² mpg (l/100km) Extra Urban	18" wheels	53.3 (5.3)	-
	19" wheels	52.3 (5.4)	50.4 (5.6)
	20" wheels	52.3 (5.4)	50.4 (5.6)
	21" wheels	47.9 (5.9)	47.1 (6.0)
Fuel consumption, ² mpg (l/100km) Combined	18" wheels	49.6 (5.7)	-
	19" wheels	48.7 (5.8)	47.9 (5.9)
	20" wheels	48.7 (5.8)	47.9 (5.9)
	21" wheels	45.6 (6.2)	45.6 (6.2)

Audi Q7 dimensions

The technical drawings opposite show the exact dimensions of the Audi Q7, so you can check everything – from whether the car will fit in your garage to whether your luggage will fit in the boot.

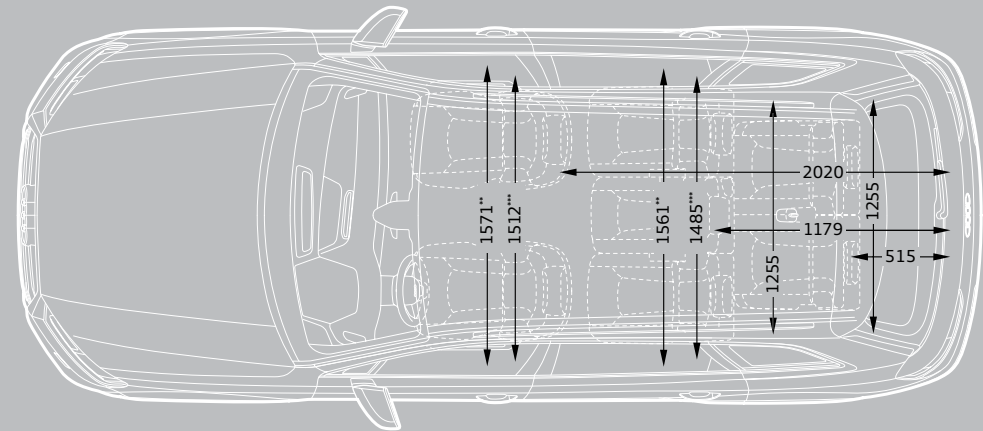
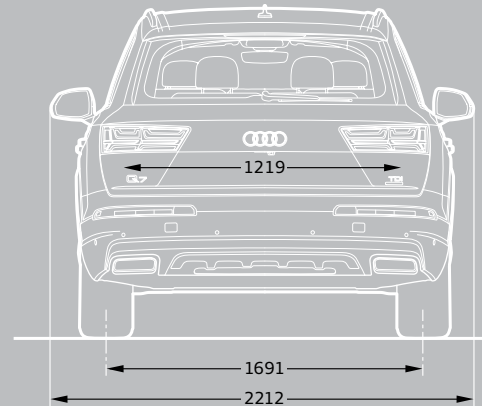
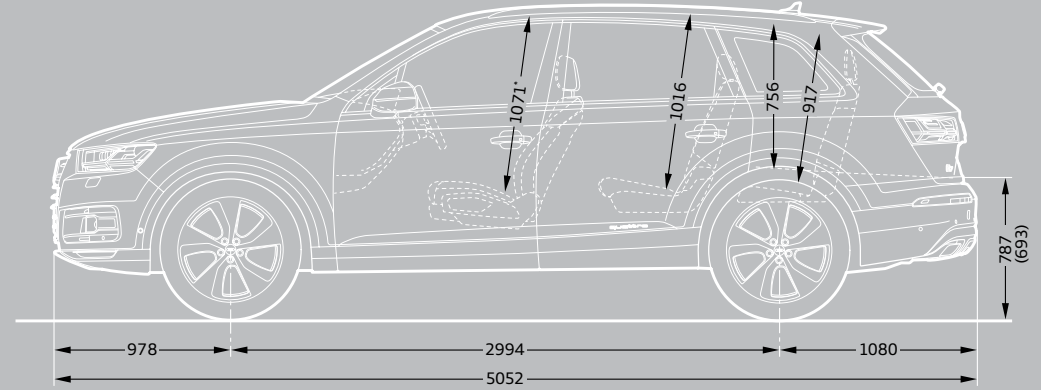
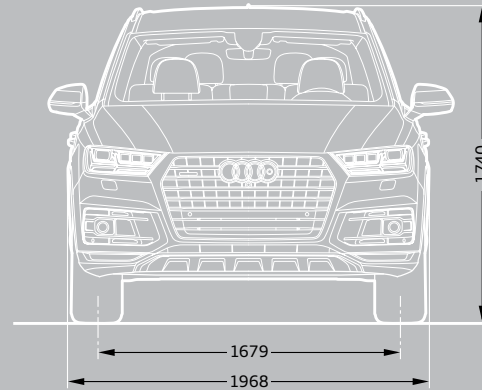

Dimensions in millimetres. Optional equipment may affect dimensions.

- *Maximum headroom.
- **Elbow room width.
- ***Shoulder room width.

Dimensions measured with vehicle at unladen weight, ground clearance measured with vehicle carrying its maximum load. Luggage load area in litres: 295/770/1955 (second value with the 3rd row of seats folded down: third value with rear seat back and loaded to the roof, measured using the VDA standard test method using 200 x 100 x 50mm blocks)

Turning circle approx 12.4m (with optional all-wheel steering the turning circle approx 11.4m).

¹With air suspension, in lift mode.

Pricing and Additional information

Welcome to Audi

By placing an order for your Audi, you're choosing to drive a car created in the spirit of Vorsprung durch Technik.

And because we believe the service we offer should reflect the quality of our cars, we want to let you know exactly what you can expect from us, now and in the future.

Audi Promise

Audi Centres

We guarantee that all our Centres will be open as follows:

Sales: Monday to Friday 9am–6pm
Saturday 9am–5pm

Service: Monday to Friday 8am–6pm
Saturday 8.30am–1pm

Sunday opening is at local discretion.

New car delivery

Once we've confirmed a delivery date for your car, we'll keep you informed of progress. Subject to reasonable notice, we'll then deliver it to a place of your choice, whether that's your home or work. In the unlikely event of a delay, we'll provide a courtesy car to minimise inconvenience and keep you mobile.

Information in this guide

We've done all we can to make the prices, specifications, technical details and all other information you see in this guide accurate at the time of publication. However, as our products are constantly being updated, we recommend checking the details with your Audi Centre. We reserve the right to change prices or specifications at any time.

All prices are subject to VAT, currently charged at 20%, but this may alter to reflect any change in the applicable VAT rate.

Delivery charges and number plates are not included in the Total RRP inc VAT vehicle price.

Delivery charge	£504.99
Number plate	£20.00
VAT	£105.01
Total	£630.00

Recommended On-The-Road (OTR) prices include the delivery and number plate charges above, Road Fund Licence (which may vary depending on model/transmission - see table for details) and first registration fee at £55.00.

The images featured in this guide are for illustrative purposes only. They may feature left-hand drive vehicles and include equipment that is not UK specification.

Audi Customer Care

Every new Audi benefits from the comprehensive Audi Customer Care Package, which comprises:

- ▶ A 3-year Audi warranty, which covers you for unlimited mileage in the first 2 years of ownership, with a full mechanical and electrical warranty which covers you for up to 60,000 miles in the 3rd year
- ▶ A 3-year paint warranty
- ▶ A 12-year anti-corrosion warranty
- ▶ 3 years' UK roadside assistance and recovery

You also have the option when ordering your new car of choosing a 4-year or 5-year Audi warranty. Speak to a member of the sales team for more information.

Warranty terms and conditions apply. Please see audi.co.uk/warrantyterms for further details.

Audi tax-free sales

If you are entitled to purchase a vehicle free of VAT, normally through military or diplomatic privilege, please contact your local Audi Centre for full details.

Should you have any difficulty obtaining the information you require, please call 0870 241 5663.

Audi Financial Services

Audi Financial Services specialises in providing funding solutions for Audi drivers. Whether your Audi is for private or business use, there is a range of funding options to choose from.

Below is the full range of finance products, which comprises:

- ▶ Solutions – a Personal Contract Plan
- ▶ Hire purchase

- ▶ Lease purchase
- ▶ Finance lease
- ▶ Contract hire

With all products, you can choose a fixed-cost maintenance plan designed to help you budget accurately.

No matter which Audi model you choose, your local Audi Centre can provide you with a personalised quote designed to fit your budget and motoring needs.

Audi Financial Services is a trading name of Volkswagen Financial Services (UK) Limited. An offer of finance depends on certain conditions. Available to people over 18 in the UK only.

Audi Insurance

To ensure you can start enjoying your new car from day one, the first five days' insurance is included as standard with all new Audi models. To activate simply call 0330 303 6900, provide us with a few details, and we'll send a cover note to your Audi Centre. They will then tax your car and you can drive it away.

Telephone lines are open Monday to Friday 8am–8pm and Saturday 9am–4pm. For details of our full range of Insurance products visit insurewithaudi.co.uk

Audi Financial Services is a trading name of Volkswagen Financial Services (UK) Limited ("VWFS UK"). Registered in England and Wales No. 2835230. Registered Office: Brunswick Court, Yeomans Drive, Blakelands, Milton Keynes MK14 5LR. Financial and consumer credit services are provided by VWFS UK. Volkswagen Financial Services (UK) Limited is authorised and regulated by the Financial Conduct Authority, registration number 311988. Audi Motor Insurance from Audi Financial Services is sold and administered by Ageas Retail Limited, registered in England and Wales No. 1324965. Registered office: Ageas House, Hampshire Corporate Park, Templars Way, Eastleigh, Hampshire SO53 3YA. Ageas Retail Limited is authorised and regulated by the Financial Conduct Authority (FCA), registration number 312468. Volkswagen Financial Services (UK) and Ageas Retail Limited are not part of the same corporate group.

Audi Connect

An external data source is required to enable Audi Connect online services. One of two can be used:

1. A separate SIM card with data option (which can be inserted into the included SIM card reader). If LTE usage is required the SIM card will also need an LTE option. When a separate SIM card is used, hands-free phone calls are possible by connecting a different mobile telephone via Bluetooth Hands-Free Profile. For mobile phone and software compatibility please visit audi.co.uk/phonecompatibility or your Audi Centre.
2. On capable mobile phones the phone's data connection can be shared with the car via personal hotspot/tethering. Using this method may result in high consumption of your mobile phone battery.

Online services will only be available within the coverage of the mobile phone network; there may be additional costs for the use of these services (charges and billing correspond to the personal mobile phone contract or SIM card contract). Due to high data volumes, a mobile phone contract including an unlimited or high usage data plan is strongly recommended. The content and scope of the online-based services offered may vary.

Audi Connect 3-month trial

The 3-month free use of Audi Connect is activated from vehicle delivery. Should you wish to continue with the services after the 3 months please consult your Audi Centre for details. Charges will apply upon renewal.

Audi Connect 36-month subscription

Audi Connect services listed are correct at time of publication. Please be aware that we cannot guarantee permanent availability to all these services throughout your 36-month subscription. Should you wish to continue to use Audi Connect after 36 months please consult your Audi Centre for details. Charges will apply upon renewal.

Audi Connect enables access to the services of Google and Twitter. Permanent availability cannot be guaranteed as this is the responsibility of Google and Twitter. Google and the Google logo are registered trademarks of Google Inc.

The availability of services supported by Audi Connect varies from country to country and is dependent on the capability of your mobile phone. For mobile phone and software compatibility please visit audi.co.uk/phonecompatibility or your Audi Centre.

Online Map updates

The map version delivered can be updated with the first 5 updates which are issued at intervals of 6 months. The current navigation data can be downloaded from the myAudi Platform at www.audi.com/myaudi and installed in the vehicle via SD card. In conjunction with Audi Connect, the update can be carried out online in the vehicle. In addition, it is possible to have the new navigation data installed by an Audi Centre at extra cost.

CO₂ data and information

CO₂ emissions-based Vehicle Excise Duty

Vehicle Excise Duty (Road Fund Licence) is based upon the amount of Carbon Dioxide (CO₂) a vehicle emits, measured in grams per kilometre (g/km). First year VED rates apply to the first year of ownership. Annual VED rates apply thereafter. The DVLA has created thirteen categories:

Petrol and Diesel engines	First year	Annual rate (second year onwards)
A – up to 100g/km	£0.00	£0.00
B – 101 to 110g/km	£0.00	£20.00
C – 111 to 120g/km	£0.00	£30.00
D – 121 to 130g/km	£0.00	£110.00
E – 131 to 140g/km	£130.00	£130.00
F – 141 to 150g/km	£145.00	£145.00
G – 151 to 165g/km	£180.00	£180.00
H – 166 to 175g/km	£295.00	£205.00
I – 176 to 185g/km	£350.00	£225.00
J – 186 to 200g/km	£490.00	£265.00
K – 201 to 225g/km	£640.00	£290.00
L – 226 to 255g/km	£870.00	£490.00
M – over 255g/km	£1,100.00	£505.00

Vehicle Excise Duty (VED) rates correct at time of going to print, but these may alter to reflect any change in the applicable VED rate.



Audi UK

Customer Services
Selectapost 29
Sheffield
S97 3FG
0800 699888
audi.co.uk

Information in this guide is
subject to change without notice.

© Audi UK

Printed in the UK
Edition 2.0 01/16
2016 model year

Images for illustrative purposes only.