



## The Audi RS 3 Sportback

Pricing and Specification Guide  
Valid from January 2016



# Personalising your Audi RS 3 Sportback

This guide has been designed to help you tailor and price your Audi RS 3 Sportback quickly and logically. At the back, you will find information on CO<sub>2</sub> emissions-based taxation and services offered with your Audi, including Finance and Insurance. You can also configure your Audi RS 3 Sportback online at [audi.co.uk](http://audi.co.uk)



Get more from this brochure with the free Audi Vision app.

Audi Vision brings our brochures to life through Augmented Reality. It works by recognising images on a page through your device's camera. Suitable for compatible phones or tablets, download it for free from the App Store or Google Play. Once downloaded, simply open the app and scan the cover of your guide. Then look out for any page with the Audi Vision logo, you can then hold your device over the page and watch as you get exclusive access to extra images, information and video content.



The images featured in this guide are for illustrative purposes only. They may feature left-hand drive vehicles and include equipment that is not UK specification.

## The Audi RS 3 Sportback

LED lights	10
quattro	12
Performance	14
Audi Connect	20
Technology	22

## Model details and prices

Standard model equipment	24
Model prices	26

## Colour and upholstery

Paint	28
Upholstery and seats	32
Colour and trim guide	36
Seats	37
Inlays	38

## Options

Wheels, tyres and suspension	40
Performance	43
Packages	44
Audio and communication	48
Interior equipment	50
Exterior equipment	52
Safety and security	53

## Looking after your Audi

Audi Complete and Warranty	54
Merchandise	58
Audi Difference	59

## Technical details

Technical data	60
Dimensions	61
Pricing and Additional information	62





## Vorsprung durch Technik

Three words that express the very essence of Audi – Vorsprung durch Technik. It's not just a slogan, it's our way of seeing the world and the driving force behind our history of innovation that continues into the 21st century. Indeed, many technologies that have become synonymous with Audi remain in our cars today. Some are milestones in the history of the motorcar. From our beginnings in 1899, to the Auto Union team's Grand Prix successes in the 1930s and our more recent wins at Le Mans, we have always been at the forefront of the motor industry.

Vorsprung durch Technik makes us who we are. To see more of its influence, just read on.



## The Audi RS 3 Sportback. Astonishing in every sense.

Performance. Style. The hallmarks of RS come to life once again in the Audi RS 3 Sportback.

The award-winning 2.5-litre TFSI, 5-cylinder engine makes that same, unmistakable sound. But with 367PS, it now packs more of a punch, with acceleration from 0-62mph in 4.3 seconds.

Its presence is unmistakably RS, too. Rotor design 19" alloy wheels housed within flared wheel arches. Twin oval tailpipes. A sporty interior to match. All combining to give the RS 3 Sportback a look that's just as powerful.









# RS

## **Innovation, technology, performance.**

Impressive performance married with advanced driving technologies: these are the characteristics that put RS models firmly at the top of the Audi range.

Audi models with the RS badge – an abbreviation of the German Rennsport, directly translated as ‘Racing Sport’ – are designed, developed and built at our special high-performance subsidiary, quattro GmbH.

It's their specialist knowledge that makes it possible to create more powerful engines. A specially-tuned suspension for enhanced control at speed. And quattro all-wheel-drive with RS 3 Sportback specific set up, which allows more torque to be directed to the rear axle when appropriate for a more dynamic drive.

The result is a car that's designed to set your driving experience apart. And your pulse racing.





# LED lights

## **Illuminating features.**

For the first time, the Audi RS 3 Sportback comes with LED headlights as standard. With a continuous beam of light ranged in the colour spectrum that's close to daylight, LED technology lights the road ahead with unprecedented clarity.

With their sleek and subtle design, the LED headlights complement the appearance of your RS 3 Sportback. And with LED rear and brake lights also as standard, the striking look is complete.

# quattro

## **Variable quattro. Continuous control.**

Our legendary all-wheel-drive system isn't just designed for tricky road surfaces. It's there to give you more traction, grip and driving enjoyment.

Depending on your driving style and the road friction it detects, quattro analyses your grip – automatically distributing power between all four wheels to where it is needed most.

You can also choose how power is distributed. For sure-footed cornering, choose Dynamic mode in Audi Drive Select and switch the Electronic Stabilisation Control (ESC) to Sport setting. Between 50% and 100% of available torque is then sent to the rear wheels faster, for more direct turn in.

Whatever the road holds, you can be confident that quattro will react. Welcome to quattro in the RS 3 Sportback.



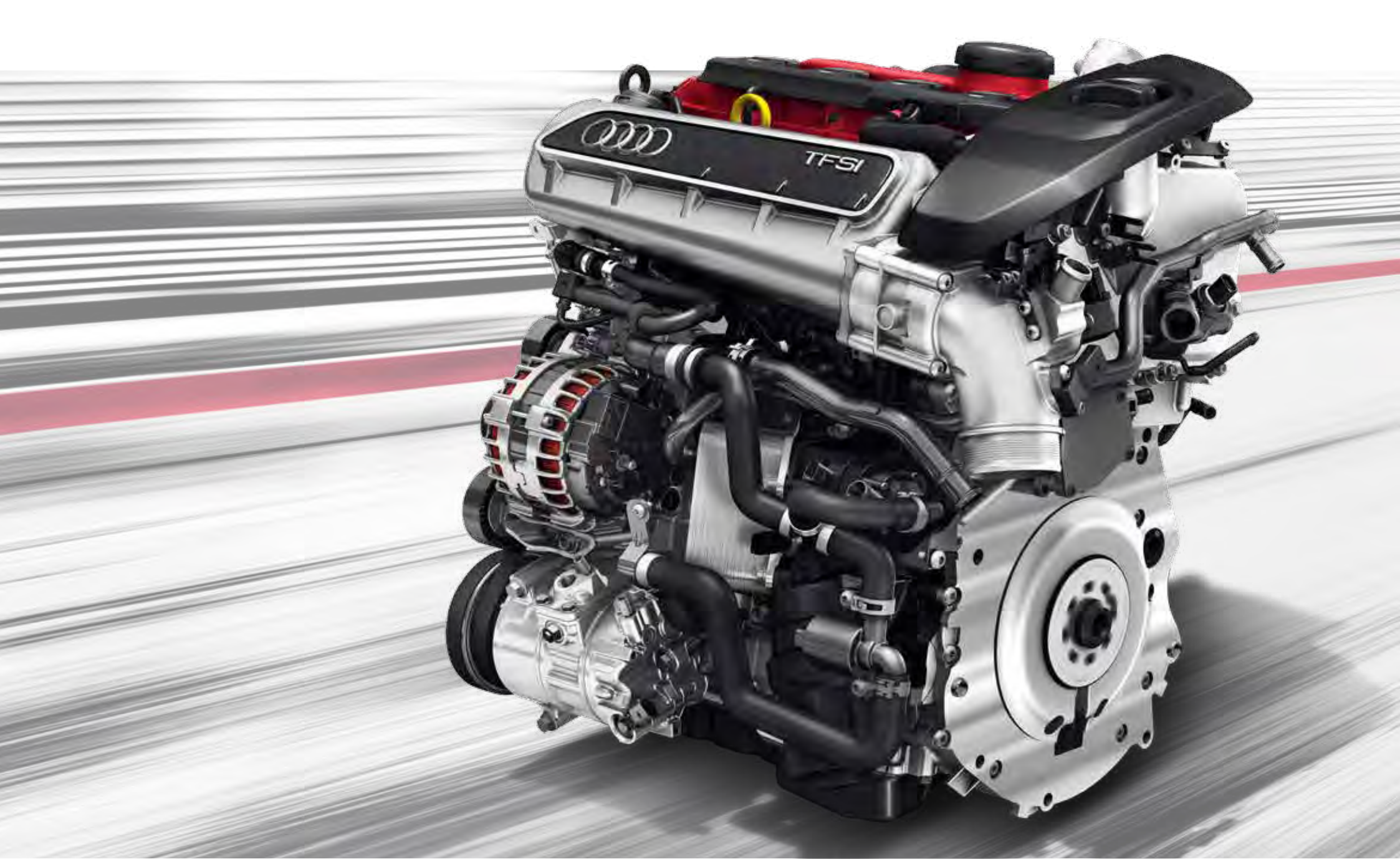



# Performance

## **Accelerate quicker.**

At the heart of the RS 3 Sportback beats Audi's most powerful production inline five-cylinder engine yet. An award winning, 2.5-litre TFSI engine at that, with the genes of the Audi quattro legends from the 1980s in its DNA. Producing 367PS with 465 Nm of torque and propelling you from 0-62mph in a breathtaking 4.3 seconds.

Characterised not just by its speed, but also its distinctive sound, the RS 3 Sportback features two flaps in its tail pipes that control the exhaust flow, adding to the trademark, bass-heavy rumble of the engine. And, as an option, the exhaust system can be upgraded to a Sport exhaust system to produce an even richer sound.

## **Slow down faster.**

A car as powerful as the RS 3 Sportback demands brakes that are just as powerful. The RS braking system, with 19" performance brakes, comes as standard. High-gloss black calipers sporting the RS logo grip each of the wave-design brake discs, perforated for maximum heat dissipation.











## Stunning throughout.

As you sit in the Fine Nappa leather RS Sport seats, you'll notice features that echo the car's Sport credentials. The flat-bottomed, leather RS multi-function steering wheel with Alcantara trim. The black, RS-badged instrument cluster. And aluminium pedals. All fitted as standard.

To complete the look, options include Aluminium Race inlays. RS Super Sport seats with diamond quilting and perforated contrast stitching are also available. As is an RS design package, with red accents on seat belts, kneepads and air vents.

# Audi



## Wi-Fi hotspot

Connects your mobile devices to the Internet



## Email

Your emails can be transmitted to your Audi MMI screen and read out conveniently.\*



## Text messages

Messages are displayed or read out to you; you can also reply using the dictation function.\*



## Twitter

Enables you to tweet and receive updates on the move, with text-to-speech and other convenient text functions



## Weather information

Gives you forecasts and maps for your chosen destination



## Map updates

The map version can be updated a total of five times at intervals of six months



## Train information

Find departure and arrival times and platform information while you're on the road (also available for other types of public transport such as underground systems)



## News online (individual)

Text and images from your favourite news sources with text-to-speech function



## City events

Up-to-date information about events happening at your destination



## Points-of-interest

Search Google™ using voice control



## Traffic information online

Complements the dynamic route guidance with real-time traffic flow information for individual stretches of road



## myAudi – special destinations

Import individual point-of-interest (POI) lists to your Satellite Navigation System via the myAudi portal



## Picturebook navigation

Uses GPS data from your photos to get you to your destination



## Country-specific information

The legal regulations for a specific country, such as speed limits or whether it is compulsory to carry a high-visibility vest or display a motorway toll sticker, are displayed when crossing a border



## Fuel prices

Information on filling stations with the cheapest prices in your selected search area



## Parking information

Helps you find car parks nearby and, where available, information on prices and currently vacant spaces



## Flight information

Get information about departure and arrival times as well as the corresponding gates and search directly for flight numbers



## Audi music stream

Access to global radio stations via smartphone app and Wi-Fi, plus access to smartphone's media library



## Navigate with Google Earth™ and Google Street View™

Uses high-resolution aerial and satellite images as well as photos to guide you to your destination with ease



# Connect



## Stay networked on the move.

Being inside your car shouldn't mean losing touch with the outside world. That's why, with optional Audi Connect, the Audi RS 3 Sportback creates a link between you and the Internet.

With 4G Internet access in your car, you can go online to access information, entertainment and Google Earth™ navigation maps by scrolling, tapping or speaking your commands. Audi Connect can even find the cheapest fuel prices. And, with a wireless hotspot within the car, passengers can connect their mobile devices – to browse the Internet, download emails, or access social media.



# Technology

We've developed a whole range of innovations for your RS 3 Sportback to enhance every aspect of your car. Here are just some of the options available.

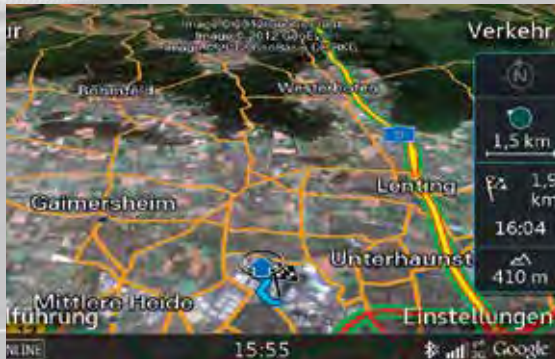

### Technology package featuring Audi Connect

Features HDD-based MMI navigation, with a 7" colour display and dynamic route guidance, it means you'll be guided to your destination with greater ease. And, because destinations can be entered with both speech and writing, your attention remains firmly on the road. And with Audi Connect services, you can navigate using Google Earth™ images.\*

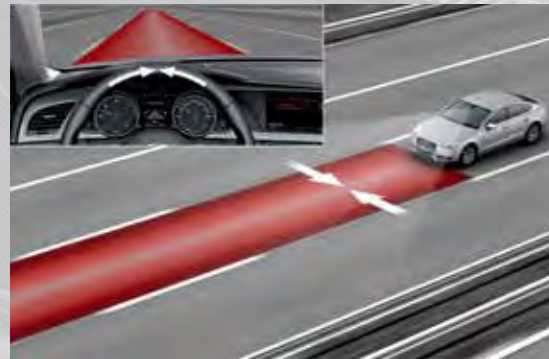

### Audi active lane assist

Using an optical sensor in the windscreen, the lane departure system warns you if a detected lane marking is approached without indicating. It will also help you steer back towards the middle of the lane by making gentle steering movements. The system works at speeds above 40mph and can be activated manually by a switch on the indicator stalk.



### Bang & Olufsen sound system

Surround sound reproduction via 14 high-performance speakers including centre speaker in the dashboard and subwoofer in the spare wheel well. 15-channel amplifier with a total output of 705 watts.

Vehicle driver assistance and safety systems are not a substitute for attentive driving. Drivers retain full responsibility for providing the necessary inputs for safe control of the vehicle.

System descriptions within this brochure are provided for information purposes only. System limitations and operational requirements apply. See manual for details.

\*External data source required, see pages 20-21 and 63 for further details.

# RS 3 Sportback model equipment

All RS 3 Sportback Navigation models have the following items of standard equipment

## Wheels, tyres and suspension

19" x 8J '5-arm Rotor' design galvanised silver alloy wheels with 235/35 R19 tyres and locking wheel bolts

**Audi Drive Select with 3 pre-configured modes** – Auto, Comfort, Dynamic and an Individual mode, allowing the driver to electronically adjust the characteristics of the engine, steering, quattro and exhaust. Modes can be selected via a button in the centre console or via the MMI system

**Progressive steering** – high steering precision combined with minimised steering effort thanks to variable steering ratio. Increases the vehicle's agility when cornering and reduces steering work when parking – can be configured via Audi Drive Select

## Tyre Repair Kit

### Electromechanical Parking Brake

**quattro permanent all-wheel-drive** with electronic multi-disc clutch at rear axle and torque vectoring distribution. Driving forces for each wheel are automatically controlled for sporty handling and based on analysis of grip. Changing setting in Audi Drive Select allows influence over torque distribution

**RS Sport Suspension** – dynamically tuned, with McPherson struts on the front axle and 4-link rear suspension

**RS brake system** – 19" high-performance brake system. Includes wave-front discs and calipers painted in High-gloss black and RS logo at the front

## Audio and communication

**Satellite Navigation system – SD card-based.** Route planning and guidance using voice, pictogram and 2D mapping shown on the 5.8" colour display screen. Can be operated via the MMI controls, multi-function steering wheel or voice control system. Includes European map data and 7-digit postcode recognition

### MMI Radio Plus

#### DAB digital radio reception

**Bluetooth interface** – for hands-free mobile phone connectivity and Bluetooth audio streaming (depending on compatibility and software version of mobile phone, please visit [audi.co.uk/phonecompatibility](http://audi.co.uk/phonecompatibility))

#### Colour Driver's Information System (DIS)

**Audi Music Interface.** Universal connection for use with stereo audio sources, USB and MP3 devices including Apple iPod generation 4 onwards (iPod, iPod classic, iPod nano, iPod photo, iPod video, iPod touch). The interface provides charging function (dependent on device)

## Exterior equipment

### RS body styling

- Front bumper with enlarged air inlets
- Front spoiler
- Honeycomb design grille
- Rear diffuser
- Roof spoiler
- Side sill extensions

### Door mirrors with aluminium look housing

**RS dual-branch exhaust system** with two oval tailpipe trims

**Exterior mirrors** – heated, electrically adjustable

**Light and rain sensors** – automatically switches the dipped beam headlights and windscreen wipers on/off depending on the light and rain conditions. Also includes a windscreen with sunband

**Audi Parking System plus** – Acoustic and visual parking aid for the front and rear with MMI display. Measurement is by the ultrasonic sensors integrated in the bumpers

**All-weather LED headlights** – LED's for all front lighting functions. LED technology provides lower energy consumption than conventional headlights and enhanced contrast with a colour similar to daylight, for increased safety and good recognition by other road users

**LED rear lights**



19" x 8J '5-arm Rotor' design galvanised silver alloy wheels



All-weather LED headlights



Roof spoiler



## Interior equipment

**RS 3-spoke flat-bottomed leather multi-function steering wheel** with Alcantara inserts, gear shift paddles in aluminium-look, contrast stitching and RS emblem

**Inlays in 3D design 'black'**

**Aluminium-look pedals**

**Dual-zone electronic climate control** – with sunlight dependent control, separate pre-selectable control for driver and front passenger. Electronically regulates the air temperature, air flow rate and air distribution. Automatic recirculation mode by means of air quality sensor, combined filter, rear vents and humidity regulation for more efficient climate control

**Aluminium door sill trims with RS 3 logo**

**Aluminium interior elements** – on the vents, glove compartment, mirror adjustment switches, window control switch, frame around the inside door handle, coin box and control buttons for the parking brake

**Front centre armrest with angle and lengthways adjustment**

**RS-instrument cluster with black dials and red needles.**

Includes:

- Boost pressure display in the rev counter
- RS logo on the MMI and Driver's Information System (DIS) display

**Storage and luggage compartment package** – includes storage nets on the backs of the front seat back rests, storage net in the front passenger footwell, 12V socket in the rear centre console and storage compartment under the rear seat (including two high-visibility vests). In the luggage compartment there is an additional multi-fastening point, net in the side compartment, luggage securing net, 12V socket and additional LED lighting

## Seats

**Fine Nappa leather upholstery with embossed RS 3 logo**

**Front Sport seats** – with shaped side bolsters for better lateral support when cornering, manual forward/backward and backrest angle adjustment, manual adjustment of the seat height (on the driver's and front passenger side), the head restraint and belt height as well as the seat-cushion angle adjustment and extendable thigh support

**Heated front seats**

**ISOFIX child seat mounting for front passenger** (with airbag deactivation) and outer rear seats. Including Top Tether attachment point for the outer rear seats

**Split-folding rear seats** – 60/40 or all

## Safety and security

**Airbags** – driver, front passenger and front side airbags with head-level airbag system for front and rear plus knee airbag for the driver. Includes a front passenger airbag deactivation switch

**Electronic Stability Control (ESC)**

**Anti-lock Brake System (ABS)**

**Anti-Slip Regulation (ASR)**

**Electronic Differential Lock (EDL)**

**First-aid kit**

**Thatcham Category 1 alarm**

**Tool kit and car jack**

**Warning triangle**

**Tyre pressure loss indicator** – visual and acoustic warning if the pressure drops in one or more tyres

**Seat belt reminder for all seats**



Instrument dials – rev counter with boost pressure display



Aluminium door sill trims with RS 3 logo



RS 3-spoke flat-bottomed leather/Alcantara multi-function steering wheel

## RS 3 Sportback Navigation

Engine	Power	Transmission	CO <sub>2</sub> g/km*	Total RRP inc VAT <sup>^</sup>	Recommended OTR <sup>†</sup>
2.5 TFSI quattro	367PS	7-speed S tronic	189	£39,620.00	£40,795.00

**\*Please note:** CO<sub>2</sub> emissions can change if a different size alloy is ordered onto the vehicle. This may also lead to a change to the VED amount payable. Please refer to pages 42, 60 and 63 for more information. Values based on standard EU test figures for comparative purposes and may not reflect real driving results.

**Please note:** The maximum power output figures are quoted in PS (or Pferdestärke, which is the metric equivalent of brake horsepower). To convert to brake horsepower, divide the PS figure by 1.0139.

<sup>^</sup>Total RRP inc VAT – Recommended Retail Price including VAT which is calculated at 20%. This may alter to reflect any change in the applicable VAT rate

**†Recommended On-The-Road (OTR) retail prices include:** delivery charge, half a tank of fuel, number plates at £630.00 (inc. VAT), Road Fund Licence (which may vary depending on model/transmission – see page 63 for details) and first registration fee at £55.00. Vehicle Excise Duty correct at time of going to print, but this may alter to reflect any change in the applicable VED rate.





# Paint

We believe that every part of your car should have a personal touch. Which is why you can choose from a wide range of paint colours, from solid paint to metallic and pearl effect finishes.

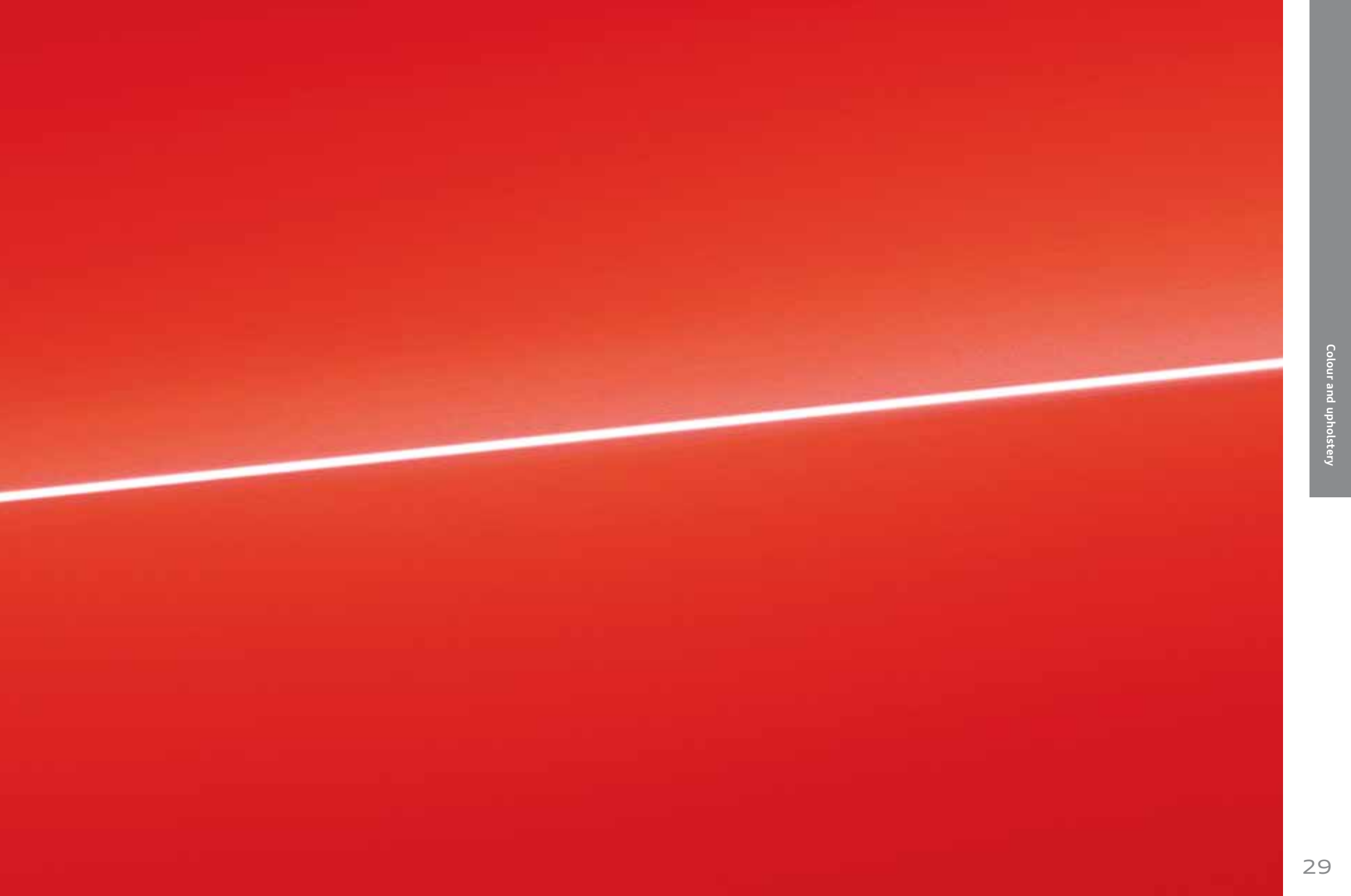

# Paint

You can select Nardo grey as the standard colour shown opposite or, for a different look, choose from the range of metallic or pearl-effect finishes.

## Standard colour

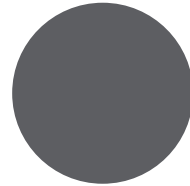

Nardo grey – T3

## Optional colours

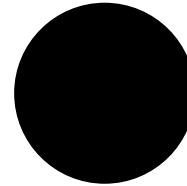

Mythos black, metallic – 0E

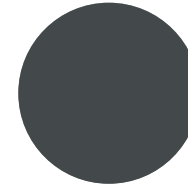

Daytona grey, pearl effect – 6Y

## Crystal effect colour

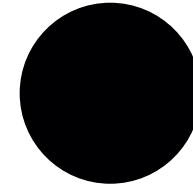

Panther black, crystal effect – H8

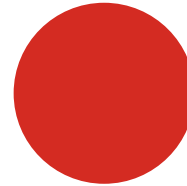

Catalunya red, metallic – Y6



Glacier white, metallic – 2Y

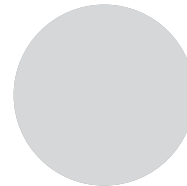

Floret silver, metallic – L5

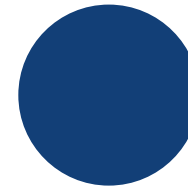

Sepang blue, pearl effect – E9

Options are subject to availability and may extend time taken for delivery.

All the colour swatches on this page are matched as accurately as possible to the actual paint colours used. However, due to print processes, Audi UK cannot guarantee that colours shown are 100% accurate.

Visit your local Audi Centre for a more accurate colour swatch.

\*Total RRP inc VAT – Recommended Retail Price including VAT which is calculated at 20%. This may alter to reflect any change in the applicable VAT rate.

**Optional colours  
Metallic and  
Pearl effect**

**Total RRP inc VAT\***  
£550.00

**Optional colour  
Crystal effect**

**Total RRP inc VAT\***  
£775.00

# Paint

## Audi exclusive

Everyone has a favourite colour. No matter what yours is, Audi exclusive provides a range of unique colours that have been designed to set your car apart. Choose from the swatches here, or specify any other paint colour in the Audi range.\*

## Customised

If you have a particular colour in mind, we'll mix the exact metallic or pearl-effect shade you want.\*\*

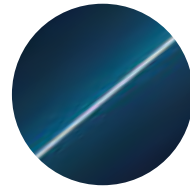

Palace blue, pearl effect

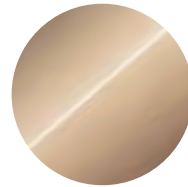

Sand beige, pearl effect

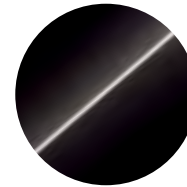

Saddle brown, pearl effect

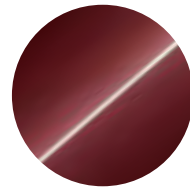

Classic red, pearl effect

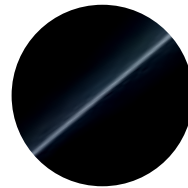

Mamba black, metallic

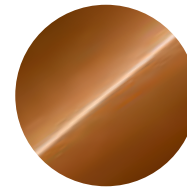

Ipanema brown, metallic



Any colour in the Audi range or 100 exclusive colours to choose from\*

### Audi exclusive\*

Total RRP inc VAT<sup>†</sup>  
£2,025.00



Customised paint\*\*

### Customised\*\*

Total RRP inc VAT<sup>†</sup>  
£2,525.00

Options are subject to availability and may extend time taken for delivery.

\*Audi exclusive paint is subject to factory approval. Visit your local Audi Centre for colour samples.

\*\*Customised paint is subject to factory approval, and is available for metallic and pearl-effect water-based paints only. Three-colour process colours and two-tone schemes are not available.

All the colour swatches on this page are matched as accurately as possible to the actual paint colours used. However, due to print processes, Audi UK cannot guarantee that colours shown are 100% accurate.

Visit your local Audi Centre for a more accurate colour swatch.

<sup>†</sup>Total RRP inc VAT – Recommended Retail Price including VAT which is calculated at 20%. This may alter to reflect any change in the applicable VAT rate.

## Upholstery

It's important to feel comfortable on the road. Just choose from our range of luxury upholstery materials and textures, including additional support and colour options, for complete relaxation while you drive.







# Upholstery

## RS 3 Sportback Sport seats

Choose your favourite upholstery from the swatches shown opposite to give your car's interior the look and feel you want.





## RS 3 Sportback Super Sport seats

Options are subject to availability and may extend time taken for delivery.

- = Not available
- = Available
- S = Standard

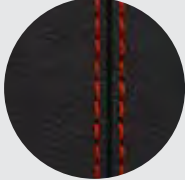
All the colour swatches on this page are matched as accurately as possible to the actual upholstery colours used. However, due to print processes, Audi UK cannot guarantee that colours shown are 100% accurate.

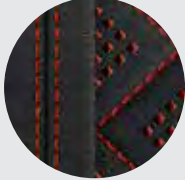
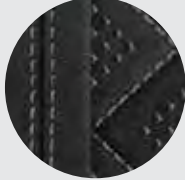
\*Total RRP inc VAT – Recommended Retail Price including VAT which is calculated at 20%. This may alter to reflect any change in the applicable VAT rate.

		RS 3 Sportback	Total RRP inc VAT*		
Fine Nappa leather	 <p>Black with contrasting stitching in Crescendo red – <b>QB</b></p>	 <p>Black with contrasting stitching in Rock grey – <b>UB/QI</b></p>	<p><b>Sport seats in Fine Nappa leather with RS 3 embossing.</b> Front seat and front centre armrest in Fine Nappa leather with contrasting stitching. Door trim inserts in Alcantara</p>	S	£0.00
Fine Nappa leather with diamond quilting	 <p>Black with contrasting stitching in Crescendo red – <b>QB</b></p>	 <p>Black with contrasting stitching in Rock grey – <b>UB/QI</b></p>	 <p>Lunar silver with contrasting stitching in Granite grey – <b>QD/QG</b></p>	•	£795.00
			<p><b>RS Super Sport seats in Fine Nappa leather with diamond-quilting and RS 3 embossing.</b> Front seat and front centre armrest in Fine Nappa leather with contrasting stitching. Shoulder area with diamond stitching and perforation in contrasting colour. Door trim inserts in Alcantara</p>		

# Upholstery

## RS 3 Sportback

Order Code

**RS 3 design package** includes the following items of equipment:

- Seat belts with contrasting stitching in Black/Crescendo red
- Door armrests in black mono.pur with contrasting stitching in Crescendo red
- Knee pads on side of centre console in black Alcantara with contrasting stitching in Crescendo red
- Air vents with red accents
- Black floor mats with RS 3 logo and contrasting stitching in Crescendo red

PEF

RS 3 Sportback

Total RRP inc VAT\*

• £895.00



Options are subject to availability and may extend time taken for delivery.

- = Not available
- = Available
- S = Standard

\*Total RRP inc VAT – Recommended Retail Price including VAT which is calculated at 20%. This may alter to reflect any change in the applicable VAT rate.

# Colour and trim guide

## Interior trim colours

### RS 3 Sportback Sport seats

Order Code	Upholstery	Carpet	Dashboard (upper/lower)	Headlining	Fine Nappa leather (N1T)
<b>QB</b>	Black with contrasting stitching in Crescendo red	Black	Black/Black	Black	●
<b>UB</b>	Black with contrasting stitching in Rock grey	Black	Black/Black	Black	●
<b>QI</b>	Black with contrasting stitching in Rock grey	Black	Black/Black	Lunar silver	●

### RS 3 Sportback Super Sport seats

Order Code	Upholstery	Carpet	Dashboard (upper/lower)	Headlining	Fine Nappa leather (N1T)
<b>QB</b>	Black with contrasting stitching in Crescendo red	Black	Black/Black	Black	●
<b>UB</b>	Black with contrasting stitching in Rock grey	Black	Black/Black	Black	●
<b>QI</b>	Black with contrasting stitching in Rock grey	Black	Black/Black	Lunar silver	●
<b>QD</b>	Lunar silver with contrasting stitching in Granite grey	Black	Black/Black	Black	●
<b>QG</b>	Lunar silver with contrasting stitching in Granite grey	Black	Black/Black	Lunar silver	●

Options are subject to availability and may extend time taken for delivery.

\*Not available in combination with Electric front seats (3L5).

# Seats

Choose from a variety of different seat options so you can maintain the correct driving posture at all times.

Order Code		RS 3 Sportback	Total RRP inc VAT*
7P1	<b>Electric lumbar support.</b> For front seats with horizontal and vertical adjustment	●	£195.00
3L5	<b>Electric front seats.</b> Includes adjustment for height, forwards and backwards position and backrest angle. Only in combination with electric lumbar support (7P1). Not available in combination with Super Sport seats (PS6)	●	£550.00

Options are subject to availability and may extend time taken for delivery.

- = Not available
- = Available
- S = Standard

\*Total RRP inc VAT – Recommended Retail Price including VAT which is calculated at 20%. This may alter to reflect any change in the applicable VAT rate.



# Inlays

Inlays are the all-important finishing touch that add flair and interest to your car's interior.

Order Code		RS 3 Sportback	Total RRP inc VAT*
5MY	3D design, black	S	£0.00
5MD	Aluminium race design	●	£100.00
5MB	Carbon inlays	●	£750.00

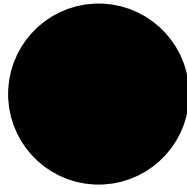

3D design, black - 5MY

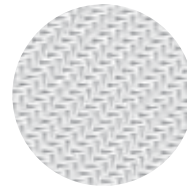

Aluminium race design - 5MD

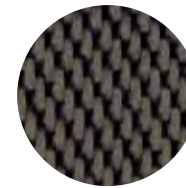

Carbon - 5MB

Options are subject to availability and may extend time taken for delivery.

- = Not available  
 ● = Available  
 S = Standard

All the inlay swatches on this page are matched as accurately as possible to the actual inlays colours used. However, due to print processes, Audi UK cannot guarantee that colours shown are 100% accurate.

\*Total RRP inc VAT - Recommended Retail Price including VAT which is calculated at 20%. This may alter to reflect any change in the applicable VAT rate.



## Options

Every driver has different needs, which is why we have created some useful options to further enhance your car. For extra comfort, support, style or function, you can choose from a variety of additional features, tailoring everything from your infotainment and audio equipment to your wheels and lighting.







# Wheels, tyres and suspension

Choose a set of specially selected alloy wheels to subtly enhance the way your car looks.

Order Code		RS 3 Sportback	Total RRP inc VAT*
<b>C8H</b>	19" x 8J '5-arm Rotor' design in galvanised silver, alloy wheels with 235/35 R19 tyres	S	£0.00
<b>C8J</b>	19" x 8J '5-arm Rotor' design in titanium matt finish, diamond cut alloy wheels with 235/35 R19 tyres	●	£495.00
<b>C4L</b>	19" x 8.5J at front and 19" x 8J at rear '5-arm Rotor' design in titanium matt finish, diamond cut alloy wheels* with 255/30 R19 tyres at the front and 235/35 R19 tyres at the rear	●	£795.00
<b>U65</b>	19" x 8.5J at front and 19" x 8J at rear '5-arm Rotor' design in anthracite black high-gloss finish, diamond cut alloy wheels* with 255/30 R19 tyres at the front and 235/35 R19 tyres at the rear	●	£895.00



19" x 8J '5-arm Rotor' design in galvanised silver alloy wheels – **C8H**



19" x 8J '5-arm Rotor' design in titanium matt finish, diamond cut alloy wheels – **C8J/C4L\***



19" x 8.5J at front and 19" x 8J at rear '5-arm Rotor' design in anthracite black high-gloss finish, diamond cut alloy wheels – **U65\***

Options are subject to availability and may extend time taken for delivery.

- = Not available  
● = Available  
S = Standard

\*This wheel will cause an increase in the CO<sub>2</sub> emissions on your RS 3 Sportback. This may result in an increase in the subsequent Vehicle Excise Duty payable. Please see pages 60 and 63 for more details.

All alloy wheel images are matched as accurately as possible to the actual colour. However, due to print processes, Audi UK cannot guarantee that colours shown are 100% accurate.

\*Total RRP inc VAT – Recommended Retail Price including VAT which is calculated at 20%. This may alter to reflect any change in the applicable VAT rate.

# Performance

Give your car a more dynamic look and feel with these specifically selected options.

Order Code		RS 3 Sportback	Total RRP inc VAT*
2H7	<b>Audi Magnetic Ride with RS Sport suspension.</b> Continuously adapts the suspension damping to the changing driving situation. It does this automatically and in just a few fractions of a second by means of an electronically controlled magnetic field. Suspension tuning can be adjusted via Audi Drive Select in 3 settings – Comfort, Auto and Dynamic	●	£995.00
PC2	<b>Brake calipers painted in red with RS 3 logo</b>	●	£325.00
NM5	<b>Engine cover in Carbon sigma</b>	●	£495.00



Options are subject to availability and may extend time taken for delivery.

- = Not available
- = Available
- S = Standard

\*Total RRP inc VAT – Recommended Retail Price including VAT which is calculated at 20%. This may alter to reflect any change in the applicable VAT rate.

# Packages

Some items work well together, which is why we've created these special packages. With our Technology package, you'll benefit from a range of driver assistant technologies and innovations to help you connect on the move.

Order Code		RS 3 Sportback	Total RRP inc VAT*
WB3	<p><b>Comfort and sound package.</b> Contains:</p> <ul style="list-style-type: none"> <li>- <b>Cruise control</b> – Maintains any speed above 18mph, provided that the engine power output and engine braking effect permit it. Operated via separate steering column stalk, with set speed displayed in the Colour Driver's Information System (DIS)</li> <li>- <b>Bang &amp; Olufsen sound system</b> – Surround sound reproduction via 14 high-performance speakers including centre speaker in the dashboard and subwoofer in the spare wheel well. 15-channel amplifier with a total output of 705 watts. Exclusive speaker covers with aluminium applications and LED lighting accentuating the front woofers. The sound is permanently adapted to compensate for driving and background noises determined by a microphone. 5.1 surround sound reproduction is possible when ordered in conjunction with any of the Technology packages below (PNQ or WB4)</li> <li>- <b>Interior lighting package</b> – Anti-glare lighting for the passenger compartment comprising door sill and footwell lighting at the front as well as illuminated inside door openers, vanity mirrors and illuminated cup holders, 2 reading lights each at the front and rear, LED interior ambient lighting and active door reflectors</li> <li>- <b>Auto-dimming rear view mirror</b> – A light sensor which detects when the headlights behind are too bright and dims the rear-view mirror automatically</li> </ul>	●	£1,150.00
PNQ	<p><b>Technology package.</b> Includes HDD-based MMI Satellite Navigation Plus and MMI Touch with electrically extending, high-resolution 7" colour display with 800 x 480 pixel resolution.</p> <p>Highlights include:</p> <ul style="list-style-type: none"> <li>- High quality 3D Navigation map</li> <li>- Choice of 3 alternative routes</li> <li>- MMI Touch – a touch sensitive panel of the rotary/push button control for intuitive operation of the MMI without taking your eyes off the road</li> <li>- Dynamic route guidance</li> <li>- Flash memory for music (10GB)</li> <li>- Voice control system – whole word entry in one sentence</li> <li>- Additional arrow display in the Colour Driver's Information System (DIS)</li> <li>- 2 SDXC card readers (for up to 2TB)</li> </ul>	●	£1,145.00
WB4	<p><b>Technology package featuring Audi Connect.</b> Includes all the features of Technology package (PNQ) with the addition of Audi Connect online services which provides access to a number of innovative online services via an internal UMTS (4G) module. Audi Connect online services highlights include:</p> <ul style="list-style-type: none"> <li>- Navigation using Google Earth™ images and Google Street™ View</li> <li>- Information services such as weather forecasts and the latest world news</li> <li>- Audi traffic information online, which gives accurate real-time forecasts of the traffic situation along the chosen route</li> <li>- Create a Wi-Fi hotspot in the car for convenient Internet access using a mobile device (e.g. laptop or tablet)</li> </ul> <p>Please also refer to the detailed information on Audi Connect compatibility and data source requirements which can be found on page 63</p>	●	£1,445.00

Options are subject to availability and may extend time taken for delivery.

- = Not available
- = Available
- S = Standard

\*Total RRP inc VAT – Recommended Retail Price including VAT which is calculated at 20%. This may alter to reflect any change in the applicable VAT rate.

# Packages

Order Code		RS 3 Sportback	Total RRP inc VAT*
WB0	<b>Dynamic package.</b> Contains: - <b>Audi Magnetic Ride with RS Sport suspension</b> – continuously adapts the suspension damping to the changing driving situation. It does this automatically and in just a few fractions of a second by means of an electronically controlled magnetic field. Suspension tuning can be adjusted via Audi Drive Select in 3 settings – Comfort, Auto and Dynamic - <b>RS Sport Exhaust System</b> – further enhances the engine sound with a 2-branch design with chrome oval tailpipes	●	£1,495.00
WB2	<b>Dynamic package plus.</b> Contains all of the items in the dynamic package with the addition of the Top Speed derestrictor which offers a top speed of 174mph*	●	£2,495.00

Options are subject to availability and may extend time taken for delivery.

- = Not available
- = Available
- S = Standard

\*Where the law permits.

\*Total RRP inc VAT – Recommended Retail Price including VAT which is calculated at 20%. This may alter to reflect any change in the applicable VAT rate.



MMI Touch (part of Technology package)



Audi Connect

# Packages

Order Code		RS 3 Sportback	Total RRP inc VAT*
<b>5L2</b>	<b>Extended matt aluminium styling package</b> – includes: - Air inlet duct frame and front blade in matt aluminium look - Side frames and horizontal bar in the rear diffuser in matt aluminium look - quattro lettering in matt Titanium grey in the front air inlet In conjunction with Driver Assistance package (PCE) the quattro lettering is removed	●	£695.00
<b>PAH</b>	<b>High-gloss black styling package</b> – includes: - Radiator grille frame, side air intake funnels, front blades and window frames in high-gloss black - quattro lettering in matt titanium grey in the front air inlet In conjunction with Driver assistance package (PCE) the quattro lettering is removed	●	£695.00

Options are subject to availability and may extend time taken for delivery.

- = Not available
- = Available
- S = Standard

\*Image also shows optional Exterior mirror housing and roof rails in high-gloss black (6F) and 3S2).

\*Total RRP inc VAT – Recommended Retail Price including VAT which is calculated at 20%. This may alter to reflect any change in the applicable VAT rate.



High-gloss black styling package\*



Front blade and quattro logo in matt aluminium look (part of the Extended matt aluminium styling package)



Extended matt aluminium styling package with optional roof bars in matt aluminium (353)

# Audio and communication

Stay in touch using our range of communication functions, and give each journey its own soundtrack with our advanced audio equipment.

Order Code		RS 3 Sportback	Total RRP inc VAT*
9VD	<b>Audi sound system.</b> 10 speakers in total including centre speaker in the dashboard and subwoofer under the luggage compartment floor. 6-channel amplifier with a total output of 180 watts	●	£255.00
9VS	<b>Bang &amp; Olufsen sound system.</b> Surround sound reproduction via 15-channel amplifier with a total output of 705 watts as well as 14 high-performance loudspeakers, including a centre speaker in the dashboard and a subwoofer under the luggage compartment floor. Perfect design experience thanks to the exclusive loudspeaker covers with aluminium applications and the LED lighting accentuating the front woofers. Continuous adaptation of the sound to driving and background noises determined by microphone and 5.1 surround sound reproduction	●	£750.00
9ZE	<b>Audi Phone Box.</b> Allows phone calls to be made with improved reception quality by placing the mobile phone in the storage compartment provided in the centre console to create a 'wireless' connection to the vehicle aerial. Operated via the MMI control panel or multi-function steering wheel. Mobile phone can be charged via a USB port. Please see <a href="http://audi.co.uk/phonecompatibility">audi.co.uk/phonecompatibility</a> to check compatibility and software version of your mobile phone	●	£325.00

Options are subject to availability and may extend time taken for delivery.

- = Not available
- = Available
- S = Standard

\*Total RRP inc VAT – Recommended Retail Price including VAT which is calculated at 20%. This may alter to reflect any change in the applicable VAT rate.

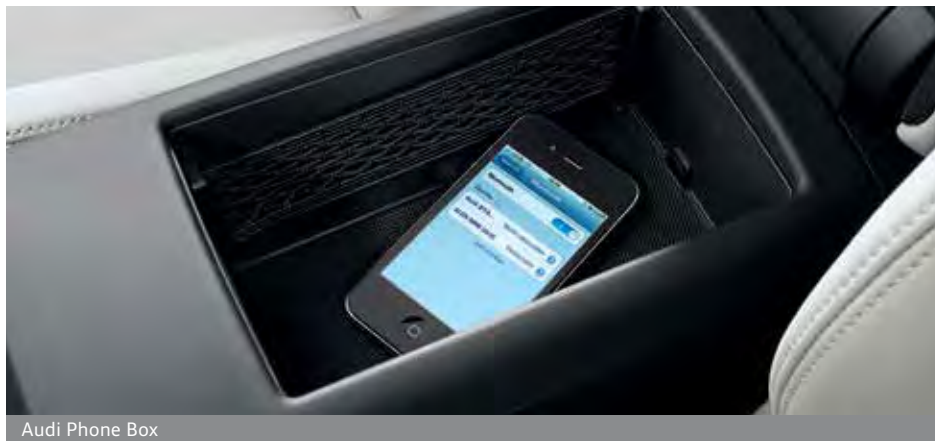

Audi Phone Box



Bang & Olufsen sound system





# Interior equipment

Specify every detail of your car's interior with this range of exclusive options.

Order Code		RS 3 Sportback	Total RRP inc VAT*
PG3	<b>Advanced key.</b> Access and authorisation system which automatically exchanges data between key and vehicle, allowing the driver to keep the key in their pocket or bag at all times. To unlock and open, simply lift the exterior door handle. To lock, press the button on the handle. Also includes an ignition start/stop button integrated in the centre console	●	£425.00
PU7	<b>Auto-dimming rear-view mirror.</b> Includes a light sensor which detects when the headlights behind are too bright and dims the rear-view mirror automatically	●	£245.00
3NU	<b>Through-load facility.</b> For safely transporting long objects. Includes rear centre armrest with cup holders and a storage compartment	●	£150.00
7HE	<b>Extended mono.pur interior finish.</b> Front knee pads and armrests finished in mono.pur leather-effect material. Also includes stitching in the colour of the seat upholstery. Not available with upholstery in Black with Crescendo red stitching (QB)	●	£295.00
6SJ	<b>Reversible mat.</b> For the luggage compartment, velour on one side and rubberised on the other, to cover the entire luggage compartment, even with folded rear seat backrest	●	£65.00
9JA	<b>Non-smoking package.</b> Removes the ashtray and replaces the cigarette lighter with a standard 12V socket	●	£0.00

Options are subject to availability and may extend time taken for delivery.

- = Not available
- = Available
- S = Standard

\*Total RRP inc VAT - Recommended Retail Price including VAT which is calculated at 20%. This may alter to reflect any change in the applicable VAT rate.



# Exterior equipment

Make sure your car looks exactly as you want it to by selecting some of our striking options.

Order Code		RS 3 Sportback	Total RRP inc VAT*
3FB	<b>Panoramic glass sunroof.</b> Activation to raise and open the glass section, opens and closes automatically. Tinted glass insert with manual, infinitely adjustable sun shield. Convenience closing from outside via the central locking remote control. The extra-large glass area floods the interior with light to create a pleasant ambience. Integrated wind deflector reduces wind noise when the roof is open	●	£950.00
3S3	<b>Aluminium roof rails</b>	●	£250.00
3S2	<b>Black roof rails</b>	●	£250.00
VW1	<b>Privacy glass.</b> Dark tinted rear and rear-side windows from B-pillar backwards	●	£290.00
8G1	<b>High-beam assist.</b> Working within system limits, automatically detects the headlights of oncoming traffic, the rear lights of other road users and built-up areas and depending on the traffic situation, the high beam is automatically switched on or off. Also available as part of Audi active lane assist (PCB) and Driver assistance package (PCE). Only in combination with Auto-dimming rear-view mirror (PU7) or Comfort and Sound package (WB3)	●	£100.00
6XE	<b>Door mirrors – electrically adjustable, folding and heated.</b> Also includes an automatic kerb view dipping function on the passenger side when reverse gear is selected	●	£150.00
6XK	<b>Door mirrors – auto-dimming on the driver’s side, electrically adjustable, folding and heated.</b> Also includes an automatic kerb view dipping function on the passenger side when reverse gear is selected. Only in combination with Auto-dimming rear-view mirror (PU7) or in combination with Comfort and Sound package (WB3)	●	£250.00
2Z0	<b>Deletion of model and technology designation at rear</b>	●	£0.00
6FJ	<b>Exterior mirror housing in high-gloss black.</b> Only in conjunction with high-gloss black styling package (PAH). Not available with Mythos black, metallic paint or Panther black, crystal effect paint	●	£125.00
6FA	<b>Exterior mirror housing in body colour</b>	●	£125.00

Options are subject to availability and may extend time taken for delivery.

- = Not available
- = Available
- S = Standard

\*Total RRP inc VAT – Recommended Retail Price including VAT which is calculated at 20%. This may alter to reflect any change in the applicable VAT rate.

# Safety and security

Vehicle driver assistance and safety systems are not a substitute for attentive driving. Drivers retain full responsibility for providing the necessary inputs for safe control of the vehicle. System descriptions within this brochure are provided for information purposes only. System limitations and operational requirements apply. See manual for details.

Order Code		RS 3 Sportback	Total RRP inc VAT <sup>†</sup>
UH2	<b>Hold assist.</b> Holds the vehicle stationary for unlimited periods after stopping and prevents the vehicle rolling on hills and on gradients. The system is activated by push-button and allows the driver to drive away easily and comfortably without having to operate the electromechanical parking brake	●	£90.00
KA2	<b>Reversing camera.</b> Shows camera image of area behind the vehicle shown on the MMI display, with dynamic display modes highlighting the calculated path (steer-angle dependent). Includes auxiliary lines and guidelines, and identification of the point at which to apply opposite lock when parallel parking. The rear-view camera is integrated discreetly in the handle strip of the luggage compartment lid	●	£275.00
8T2	<b>Cruise control.</b> Maintains any speed above 18mph, provided that the engine power output and engine braking effect permit it. Operated via separate steering column stalk, with set speed displayed in the Colour Driver's Information System (DIS)	●	£225.00
7W1	<b>Audi Pre-sense basic.</b> Networks the different vehicle systems to enable driving situations to be categorised and, where necessary, actions to be taken to protect the driver and passengers. These include: tensioning the front seat belts as well as closing the windows and – if fitted – the panoramic glass sunroof	●	£200.00
4X4	<b>Rear side airbags.</b> Situated in the side of the rear seats	●	£300.00
PCB	<b>Audi active lane assist.</b> Lane markings are registered by an optical sensor in the windscreen above speeds of approximately 40mph. Camera identifies individual or coloured lane markings, e.g. yellow lines at roadworks. The lane departure warning system warns the driver if a detected lane marking is approached without indicating, and helps the driver to steer back towards the middle of the lane by making gentle steering movements. Steering wheel vibration can be activated as an additional warning when crossing lane markings. System is activated manually by a switch on the turn signal lever. Also includes High-beam assist (8G1) and speed limit display is included as a no-cost option. Also available as part of the Driver assistance package (PCE)	●	£450.00
7Y1	<b>Audi side assist.</b> Aids the driver when changing lane. Audi side assist monitors the area behind your car using radar sensors located discreetly in the rear bumper. It then informs the driver with a visual warning signal in the door mirror if there is a vehicle in their blind spot or approaching quickly from behind. The system is activated using the MMI car settings	●	£450.00
PCB 7Y5	<b>Audi active lane assist and Audi side assist.</b> Includes Audi active lane assist (PCB) and Audi side assist (7Y1)	●	£900.00
PCE	<b>Driver assistance package.</b> Contains all of the following assistance functions: Adaptive cruise control, which uses a radar sensor to detect vehicles ahead and maintain a set distance by automatically braking and accelerating. 4 distance levels and different driving modes can be selected individually. Also includes Audi active lane assist (PCB) and High-beam assist (8G1)	●	£705.00
-	<b>Speed limit display.</b> Camera-based detection and display of speed limits, including temporary speed limits. Speed limit signs are recognised by the camera and this enables the current speed limit to be read conveniently in the Colour Driver's Information System (DIS). Should the camera not detect a sign, the speed limit from the navigation system data will be shown. Only available as a no-cost option when Audi active lane assist (PCB or PCE) is ordered	●	£0.00

Options are subject to availability and may extend time taken for delivery.

- = Not available  
● = Available  
S = Standard

<sup>†</sup>Total RRP inc VAT – Recommended Retail Price including VAT which is calculated at 20%. This may alter to reflect any change in the applicable VAT rate.

## Looking after your Audi

When you've chosen your ideal model, it's reassuring to know that it will remain in safe hands. That's why we've created products to protect your Audi, such as extended warranties. And there's also a range of Audi accessories and merchandise to choose from, enabling you to further enhance and safeguard your car.





# Audi Complete

If you drive under 10,000 miles per annum your vehicle will be placed on a Fixed Inspection Service schedule. If your mileage tends to exceed 10,000 miles per annum it will be placed on the Flexible Service schedule.

## Warranty

All new Audi models come with a three-year warranty as standard, and you can choose to extend this to a four or five-year warranty\* for a one-off cost. What's more, if you decide to sell your Audi before the warranty expires, it will be fully transferred to the new owner.

- = Not available  
• = Available  
S = Standard

\*Three-year warranty consists of a two-year unlimited mileage warranty and a third year warranty with a 60,000-mile limitation. Four-year warranty consists of a two-year unlimited mileage warranty and two further years' coverage with a 75,000-mile limitation. Five-year warranty consists of a two-year unlimited mileage warranty and three further years' coverage with a 90,000-mile limitation.

\*\*Only available prior to registration of your Audi RS 3 Sportback. Please speak to your Audi Centre for full details.

\*Total RRP inc VAT – Recommended Retail Price including VAT which is calculated at 20%. This may alter to reflect any change in the applicable VAT rate.

Audi Complete is our fixed-cost maintenance plan, which helps you keep your Audi in top condition and stay in control of your finances. For a simple monthly payment, you could cover your car's servicing, maintenance and, if you want, its tyres too.

So not only will you ensure your car runs smoothly, you'll also protect its future resale value. And because everything's covered by one competitive price, there's no need to go anywhere else.

Pricing is completely tailored to your vehicle and takes into consideration the options you have on your vehicle and your likely annual mileage and resultant service schedule. Please speak to your Audi Centre for a personalised quote for Audi Complete.

Order Code		RS 3 Sportback	Total RRP inc VAT <sup>†</sup>
-	<b>Audi Warranty</b> , covering you for unlimited mileage in the first two years of ownership, and up to 60,000 miles in the third year. Transferable between owners**	S	£0.00
EA6	<b>Audi Warranty</b> , covering you for up to 4 years or 75,000 miles, whichever comes sooner. Cover includes a two-year unlimited mileage warranty, and up to 75,000 miles in the third and fourth years. Transferable between owners**	•	£245.00
EA9	<b>Audi Warranty</b> , covering you for up to 5 years or 90,000 miles, whichever comes sooner. Cover includes a two-year unlimited mileage warranty, and up to 90,000 miles in the third, fourth and fifth years. Transferable between owners**	•	£545.00







## Merchandise

From the enthusiasts' motorsport collection to the sophisticated Audi collection, there's a wide variety of adults' and children's clothing, lifestyle accessories and collectables, all of which bear the Audi name.

Please speak to a member of our team at your local Audi Centre to see the full Audi collection and to place an order. A selection of Audi merchandise is also available to buy from [audi.co.uk/merchandise](http://audi.co.uk/merchandise)



Image shown is the Audi kids' car legends, item number 320.13.004.00

# The Audi **Difference**

## The experts in Vorsprung durch Technik

Our Audi Approved Master Technicians have undergone an impressive 100,000 hours of training over a 10-year programme to ensure they have the latest technical expertise for maintaining and servicing your Audi. All our Service Advisors undergo a specialist induction and training to ensure they are Audi professionals and able to talk to you about any issues you may have with your Audi vehicle.

## Servicing tailored to your needs

Regular servicing is key to safeguarding your Audi's performance and a full service history could help you enhance the future re-sale value. To make servicing easy, the Audi Service Schedules have been designed to work with your individual driving style and vehicle.

We offer two different schedules: the fixed Inspection Service and the Flexible Service schedule. The conventional fixed Inspection Service schedule has fixed intervals for the Oil-change Service and Inspection Service, which are determined by time and distance.

With the Flexible Service schedule, the Inspection Service intervals are also fixed but the Oil-change Service intervals are variable. Sensors take account of driving style and conditions to determine when the Oil-change Service is required and the driver is informed via the on-board service interval display.

The choice of Service Schedule will depend on journey type and mileage as well as individual driving style and conditions. The table to the right can be used for guidance but your Audi Centre will help you to determine the most suitable Service Schedule for you based on your individual circumstances and preferences.

## Fixed Inspection Service Schedule

	Vehicle usage:
Mileage	Less than 10,000 miles per annum Mainly city/town centre driving. Short journeys.
	Service intervals:
Oil-change Service	Fixed to every 9,000+ miles/1 year
Inspection Service	Fixed to every 19,000+ miles/2 years

## Flexible Service Schedule

	Vehicle usage:
Mileage	More than 10,000 miles per annum Motorway and main road driving. Mainly longer distance journeys. Constant speeds.
	Service intervals:
Oil-change Service	Variable to a maximum of every 19,000+ miles/2 years
Inspection Service	Fixed to every 19,000+ miles/2 years

When a vehicle is frequently used in the following conditions, we recommend a Fixed Inspection Service Schedule, regardless of mileage:  
Uneconomical driving styles, e.g. heavy acceleration and braking, constant use of high revs  
High engine-loading conditions, e.g. frequent towing and hill climbs

\*As indicated by the service interval display. Mileages are approximate as the Service Indicator system uses kilometres as its distance measurement.

## Your convenience comes first

At Audi you can choose from a range of convenient services that suit your needs. Why not book a 'service while you wait' appointment\* and enjoy our complimentary refreshments while your car is with us? Or, if you need to be mobile, take advantage of one of our courtesy cars which we can even deliver to you.\* We guarantee we can service your Audi within 5 days without a courtesy car or within 10 days if you need transport. We will also ensure your car is returned to you with a full valet.

## Audi Genuine Parts

You can rest assured that only Audi Genuine Parts will be used on your vehicle. What's more, Audi parts and labour come with a 2-year guarantee.\*\*

## No hidden costs

We believe strongly in transparency when it comes to our prices. For added peace of mind, we will give you a quotation over the phone for the work you have requested and email you the price confirmation. We'll consult you if any additional work on your car is needed when it is with us. We won't carry out any extra work without asking your permission first.

## All part of the service

Whenever we see an Audi for a service, we connect it directly to our headquarters in Ingolstadt which enables us to check your car's software and make sure it's as up-to-date as possible. If the factory has released a software upgrade for your model, it can be applied immediately – improving anything from your car's efficiency to the precision of its parking system.

## Audi Roadside Assistance

Your new car comes complete with 3 years' complimentary roadside assistance and recovery across the UK, provided by Automobile Association Insurance Services Limited. Also included is roadside assistance throughout Europe, managed by Automobile Association Insurance Services Limited.

For further information and terms and conditions please visit [audi.co.uk](http://audi.co.uk)

\*Subject to availability.  
\*\*Excludes wear and tear.



# RS 3 Sportback technical data

Engine	<b>2.5 TFSI quattro</b>	
Transmission	7-speed S tronic	
Cylinder	5-cylinder	
Displacement, cubic cm (valves per cylinder)	2480 (4)	
Max. power, <sup>1</sup> PS at rpm	367/5550-6800	
Max. torque, Nm at rpm	465/1625-5550	
Top speed, <sup>2</sup> mph	155*	
0-62mph acceleration, seconds	4.3	
CO <sub>2</sub> emissions, <sup>2</sup> g/km	19" x 8J wheels	189
	19" x 8.5J wheels**	194
Benefit in kind (BIK)%	19" x 8J wheels	32%
	19" x 8.5J wheels**	33%
Fuel consumption, <sup>3</sup> mpg (l/100km) Urban	19" x 8J wheels	25.2 (11.2)
	19" x 8.5J wheels**	24.8 (11.4)
Fuel consumption, <sup>3</sup> mpg (l/100km) Extra Urban	19" x 8J wheels	44.8 (6.3)
	19" x 8.5J wheels**	43.5 (6.5)
Fuel consumption, <sup>3</sup> mpg (l/100km) Combined	19" x 8J wheels	34.9 (8.1)
	19" x 8.5J wheels**	34.0 (8.3)
ABI insurance group 1-50 <sup>4</sup>	40E	
Unladen weight, <sup>4</sup> kg	1520	
Gross weight limit, kg	2020	
Roof load limit/nose weight, <sup>5</sup> kg	75	
Max trailer load unbraked, <sup>5</sup> kg	N/A	
Luggage compartment capacity/seats folded flat, litres	280/1120	
Fuel tank capacity approx, litres	55	
Emission standard	EU6	

\*Electronically limited.

\*\*Optional 19" x 8.5J wheels affect the fuel consumption figures, BIK and the CO<sub>2</sub> emissions. This may result in an increase in subsequent Vehicle Excise Duty payable. See page 63 for more details on VED rates.

<sup>1</sup>Highest insurance group rating shown. Group may be lower dependent on trim level. Please visit [thatcham.org/abigrouprating](http://thatcham.org/abigrouprating) for details.

**Please note:** The maximum power output figures are quoted in PS (or Pferdestärke, which is the metric equivalent of brake horsepower). To convert to brake horsepower, divide the PS figure by 1.0139.

<sup>2</sup>The given value was obtained in accordance with the specified measurement procedure (the respective current version of the Directive 80/1269/EEC).

<sup>2</sup>Top speed is achieved in top gear.

<sup>3</sup>Fuel consumption and CO<sub>2</sub> emissions figures are obtained under standardised test conditions (Directive 93/116/EEC) using a representative model. This allows direct comparison between different models from different manufacturers, but may not represent the actual fuel consumption achieved in 'real world' driving conditions. More information is available at [dft.gov.uk/vca](http://dft.gov.uk/vca)

<sup>4</sup>Vehicle's unladen weight without driver (calculated in accordance with the current version of Directive 80/1268/EEC). The fitting of additional equipment may increase the vehicle's unladen weight and drag coefficient, whereupon the potential carrying capacity and top speed will be correspondingly reduced.

<sup>5</sup>Vehicle not suitable for towing equipment.



# RS 3 Sportback dimensions

The technical drawings opposite show the exact dimensions of the Audi RS 3 Sportback, so you can check everything - from whether the car will fit in your garage to whether your luggage will fit in the boot.

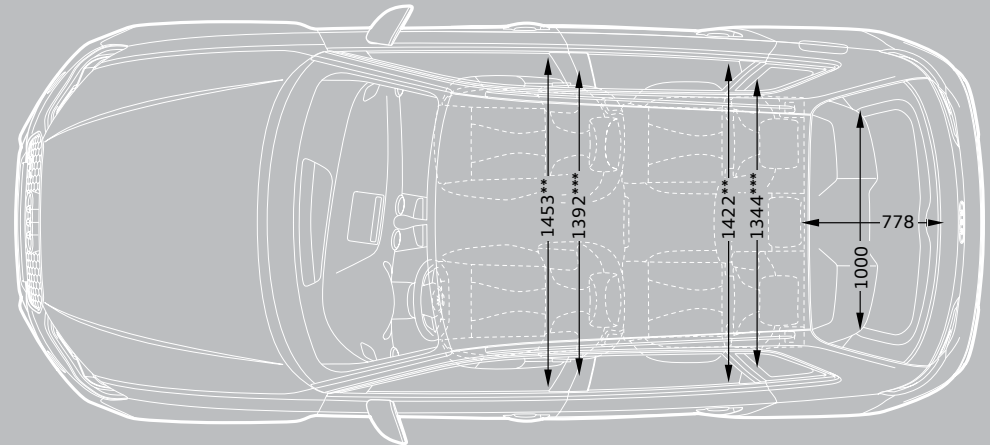
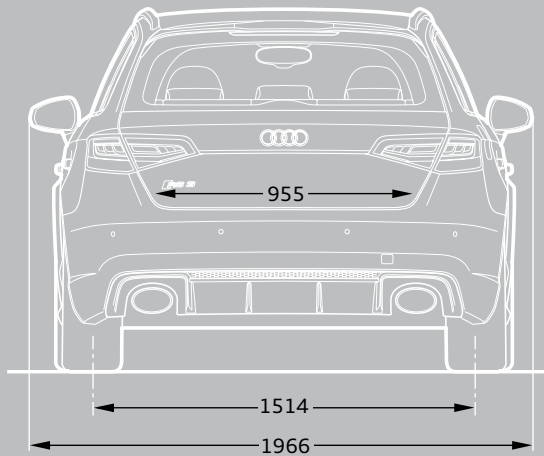
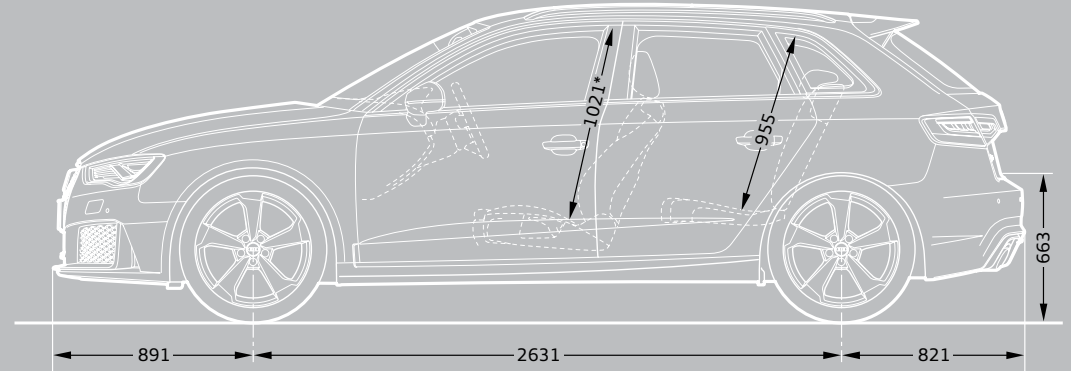
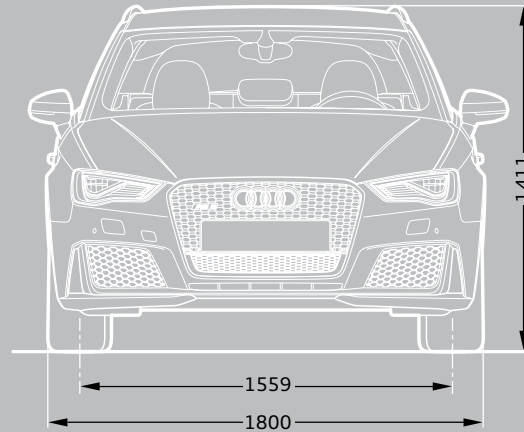

Dimensions in millimetres. Optional equipment may affect dimensions.

\*Maximum headroom.

\*\*Elbow room width.

\*\*\*Shoulder room width.

Turning circle approx 10.9m.

Dimensions were measured with vehicle at unladen weight, ground clearance measured with vehicle carrying its maximum load.

# Pricing and Additional information

## Welcome to Audi

By placing an order for your Audi, you're choosing to drive a car created in the spirit of Vorsprung durch Technik. And because we believe the service we offer should reflect the quality of our cars, we want to let you know exactly what you can expect from us, now and in the future.

## Audi Promise

### Audi Centres

We guarantee that all our Centres will be open as follows:

Sales: Monday to Friday 9am–6pm  
Saturday 9am–5pm

Service: Monday to Friday 8am–6pm  
Saturday 8.30am–1pm

Sunday opening is at local discretion.

### New car delivery

Once we've confirmed a delivery date for your car, we'll keep you informed of progress. Subject to reasonable notice, we'll then deliver it to a place of your choice, whether that's your home or work. In the unlikely event of a delay, we'll provide a courtesy car to minimise inconvenience and keep you mobile.

### Information in this guide

We've done all we can to make the prices, specifications, technical details and all other information you see in this guide accurate at the time of publication. However, as our products are constantly being updated, we recommend checking the details with your Audi Centre. We reserve the right to change prices or specifications at any time.

All prices are subject to VAT, currently charged at 20%, but this may alter to reflect any change in the applicable VAT rate.

Delivery charges and number plates are not included in the Total RRP inc VAT vehicle price.

Delivery charge	£504.99
Number plate	£20.00
VAT	£105.01
Total	£630.00

Recommended On-The-Road (OTR) prices include the delivery and number plate charges above, Road Fund Licence (which may vary depending on model/transmission – see table for details) and first registration fee at £55.00.

The images featured in this guide are for illustrative purposes only. They may feature left-hand drive vehicles and include equipment that is not UK specification.

### Audi Customer Care

Every new Audi benefits from the comprehensive Audi Customer Care Package, which comprises:

- ▶ A 3-year Audi warranty, which covers you for unlimited mileage in the first 2 years of ownership, with a full mechanical and electrical warranty which covers you for up to 60,000 miles in the 3rd year
- ▶ A 3-year paint warranty
- ▶ A 12-year anti-corrosion warranty
- ▶ 3 years' UK roadside assistance and recovery

You also have the option when ordering your new car of choosing a 4-year or 5-year Audi warranty. Speak to a member of the sales team for more information.

Warranty terms and conditions apply. Please see [audi.co.uk/warrantyterms](http://audi.co.uk/warrantyterms) for further details.

### Audi tax-free sales

If you are entitled to purchase a vehicle free of VAT, normally through military or diplomatic privilege, please contact your local Audi Centre for full details.

Should you have any difficulty obtaining the information you require, please call 0870 241 5663.

## Audi Financial Services

Audi Financial Services specialises in providing funding solutions for Audi drivers. Whether your Audi is for private or business use, there is a range of funding options to choose from.

Below is the full range of finance products, which comprises:

- ▶ Solutions – a Personal Contract Plan
- ▶ Hire purchase
- ▶ Lease purchase
- ▶ Finance lease
- ▶ Contract hire

With all products, you can choose a fixed-cost maintenance plan designed to help you budget accurately.

No matter which Audi model you choose, your local Audi Centre can provide you with a personalised quote designed to fit your budget and motoring needs.

Audi Financial Services is a trading name of Volkswagen Financial Services (UK) Limited. An offer of finance depends on certain conditions. Available to people over 18 in the UK only.

### Audi Insurance

To ensure you can start enjoying your new car from day one, the first five days' insurance is included as standard with all new Audi models. To activate simply call 0330 303 6900, provide us with a few details, and we'll send a cover note to your Audi Centre. They will then tax your car and you can drive it away. Telephone lines are open Monday to Friday 8am–8pm and Saturday 9am–4pm. For details of our full range of Insurance products visit [insurewithaudi.co.uk](http://insurewithaudi.co.uk)

## CO2 data and information

### CO2 emissions-based Vehicle Excise Duty

Vehicle Excise Duty (Road Fund Licence) is based upon the amount of Carbon Dioxide (CO2) a vehicle emits, measured in grams per kilometre (g/km).

First year VED rates apply to the first year of ownership. Annual VED rates apply thereafter. The DVLA has created thirteen categories:

Petrol and Diesel engines	First year	Annual rate (second year onwards)
A – up to 100g/km	£0.00	£0.00
B – 101 to 110g/km	£0.00	£20.00
C – 111 to 120g/km	£0.00	£30.00
D – 121 to 130g/km	£0.00	£110.00
E – 131 to 140g/km	£130.00	£130.00
F – 141 to 150g/km	£145.00	£145.00
G – 151 to 165g/km	£180.00	£180.00
H – 166 to 175g/km	£295.00	£205.00
I – 176 to 185g/km	£350.00	£225.00
J – 186 to 200g/km	£490.00	£265.00
K – 201 to 225g/km	£640.00	£290.00
L – 226 to 255g/km	£870.00	£490.00
M – over 255g/km	£1,100.00	£505.00

Vehicle Excise Duty (VED) rates correct at time of going to print, but these may alter to reflect any change in the applicable VED rate.

## Audi Connect

The following external data source is required to enable Audi Connect online services:

- ▶ A separate SIM card with data option (which can be inserted into the included SIM card reader). If LTE usage is required the SIM card will also need an LTE option. When a separate SIM card is used, hands-free phone calls are possible by connecting a different mobile telephone via Bluetooth Hands-Free Profile. For mobile phone and software compatibility please visit [audi.co.uk/phonecompatibility](http://audi.co.uk/phonecompatibility) or your Audi Centre.

Online services will only be available within the coverage of the mobile phone network; there may be additional costs for the use of these services (charges and billing correspond to the personal mobile phone contract or SIM card contract). Due to high data volumes, a mobile phone contract including an unlimited or high usage data plan is strongly recommended. The content and scope of the online-based services offered may vary.

When ordered as an option, a 36-month Audi Connect subscription is provided with your vehicle. The subscription runs from the point of vehicle delivery. Should you wish to continue to use Audi Connect after 36 months, please consult your Audi Centre for details (including the latest subscription fees).

Audi Connect services listed are correct at time of publication. We may add, change, replace or remove individual Audi Connect services or features at any time during your subscription.

Audi Connect enables access to the services of Google and Twitter. Permanent availability cannot be guaranteed as this is the responsibility of Google and Twitter. Google and the Google logo are registered trademarks of Google Inc.

The availability of services supported by Audi Connect varies from country to country and is dependent on the capability of your mobile phone. For mobile phone and software compatibility please visit [audi.co.uk/phonecompatibility](http://audi.co.uk/phonecompatibility) or your Audi Centre.

### Map updates

If the Technology package is ordered (PNQ or WB4), the map version delivered can be updated with the first 5 updates which are issued at intervals of 6 months. The current navigation data can be downloaded from the myAudi Platform at [audi.com/myaudi](http://audi.com/myaudi) and installed in the vehicle via SD card. In addition it is possible to have the new navigation data installed by an Audi partner at extra cost.













**Audi UK**

Customer Services  
Selectapost 29  
Sheffield  
S97 3FG  
0800 699888  
audi.co.uk

Information in this guide is subject  
to change without notice.

© Audi (UK)

Printed in the UK  
Edition 1.7 01/16  
2016 Model Year

Images are for illustrative purposes only. Models shown are left-hand drive.

