

XE





“THE CAR

IS THE CLOSEST THING WE WILL EVER CREATE TO SOMETHING THAT

IS ALIVE”

SIR WILLIAM LYONS

## CONTENTS

DESIGN  
Pages 4 - 17

PERFORMANCE  
Pages 18 - 21

TECHNOLOGY  
Pages 22 - 29

INFOTAINMENT  
Pages 30 - 33

YOUR XE  
Pages 34 - 74

**“The car is the closest thing we will ever create to something that is alive.”**

The words of our founder, Sir William Lyons, express his determination that every Jaguar car must possess a spirit more thrilling and exciting than a mere machine.

When Sir William was searching for a name that would reflect his cars' attributes of power, grace and agility, he knew that it had to be Jaguar.

It could only be Jaguar.

Only a Jaguar promises a distinct combination of performance and seduction to give you a unique, utterly rewarding driving experience: advanced powertrains with a roaring exhaust soundtrack; sublime agility and instinctive steering; beautiful design that sets your heart racing; the craftsmanship and theatre of an interior that will excite every one of your senses.







## XE CHANGES EVERYTHING

The most advanced, efficient and refined sports saloon car that Jaguar has ever produced. The latest in an illustrious bloodline. Instantly recognisable as a Jaguar, it feels like a Jaguar, it drives like a Jaguar – XE is a Jaguar to its core.

The first of a new generation of cars to be launched on Jaguar's state-of-the-art, all new Aluminium Intensive Architecture, the lightweight aluminium construction creates an incredibly strong body. It also informs XE's imposing profile with a sports car 'rearward cabin' look and a swept back windscreen, as well as delivering the lowest ever drag coefficient on a Jaguar car of just Cd 0.26. Aluminium Intensive Architecture is the perfect platform for a performance car – power with responsive handling. And the perfect platform for a luxury car – refinement with beautiful design.

XE is alive with the latest innovation, technology and design, connecting road to car, car to driver. It has a true sporting character and is packed with systems that empower the driver as well as enhancing the driving experience. From the outright exhilaration of a supercharged V6 to the frugality of up to 99g/km of CO<sub>2</sub>, there is a range of engines to suit every driving style – XE rewrites the rules. XE is a wake up call for every other car in its class.

XE is the smarter choice with complete peace of mind being delivered by Jaguar Care, Jaguar's class-leading unlimited mileage, three year warranty and three years' free servicing programme. You can find out further details on Jaguar Care by turning to Page 73 or at [jaguar.com/jaguarcare](http://jaguar.com/jaguarcare)

Discover more at [jaguar.com/XE](http://jaguar.com/XE)

VEHICLE SHOWN: XE S IN ITALIAN RACING RED WITH OPTIONAL 20" PROPELLER ALLOY WHEELS AND PANORAMIC SUNROOF, CENTRAL LONDON, UK





## XE IS DIFFERENT

XE immediately catches the eye, standing out from the competition because of its upscale proportions. Its form possesses energy and organic vibrancy. Like all contemporary Jaguar cars, XE has a rising waistline to add drama and dynamism even when it is stationary. This is defined by the sharp design feature that flashes from the front bumper, along the flanks, to culminate at the tail. Chrome side vents, stamped with the Jaguar name, deliberately allude to F-TYPE; and there is even the tell tale Jaguar loop that arcs around the side windows. Exterior aluminium panels have crease lines with the same tight radii, clarity and precision found on F-TYPE. It also has distinctly defined sculpting on the bonnet to ensure that it shares the athleticism of the other cars in the Jaguar range. XE is crouching, ready to pounce.

VEHICLE SHOWN: XE PURE IN GLACIER WHITE WITH OPTIONAL 18" MATRIX ALLOY WHEELS, PANORAMIC SUNROOF AND ADAPTIVE BI-FUNCTION HID XENON HEADLAMPS, DOCKLANDS, LONDON, UK



## DEFINITELY JAGUAR

One glance at the tail of XE and you know that it could only be a Jaguar. Only Jaguar has the technology and expertise to create those signature rear haunches - Jaguar is a world leader in aluminium car construction. It allows the creation of more radical designs and sharper creases from deeper, more innovatively formed pressings with the body side curvature of XE aerodynamically honed to sweep air seamlessly rearwards to the tail section. The deliberately cropped rear has a short overhang to underscore the car's performance credentials and enhance airflow. It is all crowned by high intensity LED tail lamps that are inspired by F-TYPE with a roundel intersected by a horizontal line. While the high-mounted centre brake light is a beautifully integrated, full LED blade that sits beneath the screen's top edge.

VEHICLE SHOWN: XE R-SPORT IN BLUEFIRE WITH OPTIONAL 19" STAR ALLOY WHEELS, CENTRAL LONDON, UK





XDY 446

JAGUAR

XE

20d







## HIGHLY ADVANCED ALUMINIUM

Jaguar has been at the forefront of aluminium car construction for more than a decade and continues to push the boundaries of this technology. XE is the first of a new generation of Jaguar cars to be based on the all new Aluminium Intensive Architecture, which uses expertise derived from the aerospace industry to deliver premium vehicle characteristics in performance, handling and refinement.

This immensely strong bodyshell uses a high strength 6000 series aluminium alloy. Saving weight without compromising durability, it provides very high torsional stiffness of 22kNm/deg. It is also the ideal platform for a performance car and helps achieve optimum weight distribution of approaching 50:50. The lightweight structure not only reduces fuel consumption and CO<sub>2</sub> emissions, it means that the XE range is able to encompass everything from 99g/km to a maximum speed of 250km/h.

Discover more at [jaguar.com/XEaluminium](http://jaguar.com/XEaluminium)

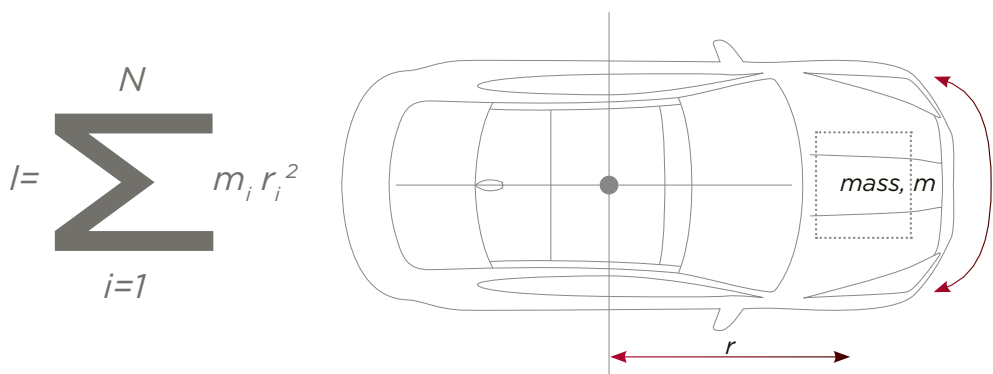

### MASS MOMENT OF INERTIA

XE's weight distribution approaches 50:50 - the closer the weight is to the car's centre, the easier it is to turn.

VEHICLE SHOWN: JAGUAR ALUMINIUM INTENSIVE ARCHITECTURE 75 PERCENT ALUMINIUM. DOORS AND BOOT LID ARE MADE FROM FULLY GALVANISED, HIGH STRENGTH STEEL. CENTRAL ST. MARTINS, LONDON, UK















## MAKE THE CONNECTION

You connect with XE the moment you slide into the form hugging seats - you sit low in a Jaguar. Directly ahead of you is the reassuring familiarity of two large, sports car analogue dials and message centre inspired by F-TYPE, all housed in a neat binnacle. You grip the chunky sports steering wheel - it too is from F-TYPE. Next to you the raised centre console adds to the cockpit feel, while the stepped fascia elegantly sweeps away - there resides the very latest in Jaguar Touch-screen technology. Throughout XE the soft natural forms of the interior architecture lend themselves to a choice of contemporary or traditional materials and finishes. Press the Start button and XE awakes. On cars with automatic transmissions, the Rotary Shifter rises to greet your hand. XE feels alive.

INTERIOR SHOWN LEFT AND PREVIOUS PAGE: XE S FEATURING RED LEATHER SPORT SEATS WITH JET SUEDECLOTH INSERTS



JAGUAR

10:30 PM

15 °C



km/h



1000

Steering wheel control buttons on the left side:

- Up arrow
- Left arrow
- MENU OK
- Right arrow
- Down arrow
- MODE
- Phone icon

Steering wheel control buttons on the right side:

- Windshield wiper icon
- LIM
- RES
- SET +
- CAN
- Minus sign







## IT LOOKS JAGUAR, IT FEELS JAGUAR

XE creates a special bond with the driver. It is focused, precise. Every control is perfectly positioned; it looks right; and it feels right. Steering wheel mounted buttons are tactile and meticulously engineered to provide the interface with key vehicle functions. While on automatic models the gearshift paddles, which give manual control without the need for the driver's hands to be taken from the wheel, are both sturdy and accurate. Even the outer air vents are unique in the way that they extend the fascia to nestle in the door casings and give the feeling of width and space. XE is an inspired place for driver and passenger to be.





# THE POWER OF XE



LOW FRICTION TECHNOLOGIES

SMART REGENERATIVE CHARGING

XE's power is delivered by a range of five highly advanced engines, including two from Jaguar's all new Ingenium engine family. Whether you choose our latest high-tech diesel engines or you prefer petrol, each one offers performance, refinement and economy to suit every driving style. There's an engine for every driver: from 99g/km and 3.8l/100km to a maximum speed of 250km/h. Advanced engine features include low CO<sub>2</sub> technologies, low friction technologies and smart regenerative charging, which prioritises battery charging during deceleration, rather than acceleration, to harvest kinetic energy and save fuel. There is a choice of transmissions available too, 8 speed automatic or 6 speed manual. Both offer superb flexibility and refinement. The sophisticated automatic is highly responsive and delivers rapid shifting for effortless acceleration and overtaking. It features JaguarDrive Control, which allows drivers to select modes for Dynamic, Winter, Eco and Normal driving. The system subtly changes steering and throttle mapping, as well as shift patterns, to suit the particular driving circumstances. Choose the 6 speed manual gearbox for even greater driver involvement - the lightweight unit is specifically designed for the performance requirements of sports cars and powerful saloons - and you'll discover slick, short changes and superb levels of comfort.

**E-Performance** Now you don't have to choose between economy and performance. Now you can have both. And in a Jaguar. E-Performance delivers the most efficient Jaguar ever and is available with a wide range of XE models - Pure, Prestige, Portfolio and R-Sport. Spot the exclusive E-Performance badge on an XE and you know it combines the thrill of driving a Jaguar with the benefits of lower ownership costs.

# DIESEL ENGINES



INGENIUM ENGINES

FROM 99g/km

FAST WARM-UP FROM COLD

XE introduces Jaguar's state-of-the-art, all new Ingenium family of engines for the first time. Ingenium offers high performance and refinement with low fuel consumption and CO<sub>2</sub> emissions. Two engines from this incredible new range are available on XE, the 2.0 i4 180PS Turbocharged Diesel and the 2.0 i4 163PS Turbocharged Diesel E-Performance, which delivers CO<sub>2</sub> from 99g/km.



## 2.0 LITRE i4

163PS TURBOCHARGED DIESEL  
E-PERFORMANCE\*

POWER 163PS

ACCELERATION 0-100 km/h

Manual 8.4 seconds Automatic 8.2 seconds

TOP SPEED 227 km/h

COMBINED Manual 3.8 l/100km Automatic 4.1 l/100km

CARBON DIOXIDE EMISSIONS

Manual 99 g/km Automatic 106 g/km

## 2.0 LITRE i4

180PS TURBOCHARGED DIESEL

POWER 180PS

ACCELERATION 0-100 km/h 7.8 seconds

TOP SPEED Manual 231 km/h Automatic 228 km/h

COMBINED 4.2 l/100km

CARBON DIOXIDE EMISSIONS

Manual 109 g/km Automatic 109-111 g/km\*\*



MANUAL  
0-100 KM/H



AUTOMATIC  
0-100 KM/H



TOP SPEED KM/H



0-100 KM/H



MANUAL  
TOP SPEED KM/H



AUTOMATIC  
TOP SPEED KM/H





# PETROL ENGINES

> ALLOY ENGINE BLOCKS | SWITCHABLE ENGINE MOUNTS

Performance and refinement. XE's petrol engines offer the sheer driving pleasure of power and responsiveness throughout the rev range, while delivering reduced emissions and CO<sub>2</sub>. The two 2.0 i4 Turbocharged engines provide 6 cylinder refinement with all the benefits of 4 cylinder motoring - reduced fuel consumption and lower cost of ownership.

The 3.0 340PS supercharged petrol engine, a mainstay of the F-TYPE range, features a Roots-type twin vortex supercharger mounted in the 'V' of the engine to maintain its compact dimensions and to complement the low aerodynamic lines of the bonnet. Supercharging provides linear power delivery and instant access to high levels of torque at all engine speeds.

2.0 LITRE i4 200PS TURBOCHARGED PETROL
POWER 200PS
ACCELERATION 0-100 km/h 7.7 seconds
TOP SPEED 237 km/h
COMBINED 7.5 l/100km
CARBON DIOXIDE EMISSIONS 179 g/km

2.0 LITRE i4 240PS TURBOCHARGED PETROL
POWER 240PS
ACCELERATION 0-100 km/h 6.8 seconds
TOP SPEED 250 km/h
COMBINED 7.5 l/100km
CARBON DIOXIDE EMISSIONS 179 g/km

3.0 LITRE V6 340PS SUPERCHARGED PETROL
POWER 340PS
ACCELERATION 0-100 km/h 5.1 seconds
TOP SPEED 250 km/h
COMBINED 8.1 l/100km
CARBON DIOXIDE EMISSIONS 194 g/km



\*Manual transmission available from mid 2015  
\*\*109 g/km figure for automatic transmission applies to 17" wheels  
Official EU test figures. For comparison purposes only. Real world figures may differ



## ADVANCED DRIVING DYNAMICS



EPAS

ADAPTIVE DYNAMICS

From its iron-grip when cornering to its immaculate poise on uneven roads, XE's precision-engineered chassis and advanced driving dynamic systems deliver outstanding sports performance in constantly changing conditions. XE possesses the lightest body in its class and has sports-car equivalent body stiffness of 22kNm/deg.

VEHICLE SHOWN: XE PURE IN GLACIER WHITE WITH OPTIONAL 18" MATRIX ALLOY WHEELS

## NEXT GENERATION EPAS

XE's next generation Electric Powered Assisted Steering (EPAS) offers outstanding feedback and control, as well as power assistance the moment you need it. The system adds to driver confidence by communicating the approach of the limits of grip during hard cornering. Only active on demand - saving power for where you really need it, as well as saving fuel - EPAS allows highly-tuned computer control to adapt the levels of steering support; whether giving you fine control at speed, or providing comprehensive assistance during slow manoeuvring.

## ADAPTIVE DYNAMICS

Adaptive Dynamics instinctively modifies XE's response to conditions and your driving style. It analyses acceleration and braking, cornering, throttle and brake pedal activity.

## NEXT GENERATION BRAKING

XE's next generation braking system is optimised for high performance and to save weight. Air deflectors fitted to the front suspension efficiently channel air to cool the brakes and reduce the risk of fade during enthusiastic driving. While new technology in the pads reduces dust to improve refinement, increase disc life and maintain the clean appearance of the wheels.

HOLD 3RD GEAR  
IN CORNER

## SOUNDS ALIVE

Jaguar doesn't just design a car's look and feel, but how it sounds, inside and out. From the gentle purr of the engine at idle, to the roar of the exhaust during enthusiastic acceleration. XE's design process realises the perfect combination of beautiful form, superior function with the ideal soundtrack. Wind noise has been minimised through state-of-the-art computational fluid dynamics while road noise is reduced through specialised alloys and innovative lightweight acoustic damping materials.







## ALL SURFACE PROGRESS CONTROL

Jaguar's unique All Surface Progress Control (ASPC) is a low speed cruise control, operating at speeds between 3.6km/h and 30km/h. It helps XE to cope with low traction situations whatever the weather and allows drivers to concentrate on steering the vehicle. The system also has a pull-away function allowing XE to move away from rest on slippery surfaces, as well as a hill descent function that controls vehicle speed on steeper inclines.

ASPC is available on all engines fitted with automatic transmissions and gives XE drivers added confidence in sub-zero weather, over rough surfaces and undulating terrain, maintaining the speed set by the driver whatever the conditions. It can be used to start from a snowy driveway, on wet grass, for descending an icy incline, or progressing smoothly along an unmade road.

With any given set of tyres, ASPC can accomplish comparable levels of traction to that achievable by an expert driver. Fitting All Season or Winter tyres to XE can improve capability on slippery surfaces.

**VEHICLE SHOWN: XE PORTFOLIO IN AMMONITE GREY**





## IN THE EXTREME



**DYNAMIC STABILITY  
CONTROL**

**ENGINE DRAG  
TORQUE CONTROL**

Whether you're driving XE enthusiastically or simply want the assurance of a car that will remain stable in challenging conditions, Jaguar's Stability Systems keep XE safely balanced through unexpected driving situations.

**Dynamic Stability Control** (DSC) monitors XE's dynamic behaviour and intervenes if the system determines that the vehicle is unresponsive to the driver's inputs. DSC reduces engine torque and/or applies braking to the appropriate wheels to correct the car's direction of travel by counteracting understeer or oversteer. XE's latest generation DSC system has enhanced understeer control to reduce speed and regain control more effectively.

**Engine Drag torque Control** (EDC) mitigates the chance of wheel lock-up caused by strong engine braking in slippery conditions by increasing torque to the affected wheels.

# TORQUE VECTORING BY BRAKING



INCREASED STEERING PERFORMANCE

IMPROVED CORNERING CAPABILITY

XE's Torque Vectoring by Braking maximises control through the tightest corners. Torque Vectoring technology provides controlled braking on the inside rear wheel delivering outstanding sports car agility and added driver confidence.

TORQUE VECTORING BY BRAKING  
APPLIES BRAKE PRESSURE TO  
SLOW INSIDE REAR WHEEL

POWER IS SUSTAINED TO  
MAINTAIN CONSTANT SPEED  
OF OUTER REAR WHEEL

ADDITIONAL ROTATIONAL  
FORCE APPLIED AROUND  
VEHICLE'S AXIS



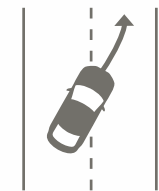

LANE DEPARTURE WARNING



BLIND SPOT MONITOR\*

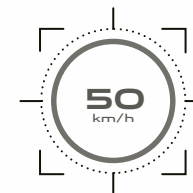

TRAFFIC SIGN RECOGNITION\*\*

## YOU TAKE CARE OF THE DRIVING, XE TAKES CARE OF YOU

Jaguar's innovative technology distinguishes XE as a leader in its class. State-of-the-art systems support safety, inform, warn, communicate and, of course, entertain. As the technology assists and empowers you XE comes alive, sensing the world and the hazards around you. XE assures a rewarding drive while helping you to stay safe.

In XE, you hardly ever need to take your eyes off the road. Using technology pioneered in military jets, XE incorporates a Head-Up Display (HUD)\* that projects key information, onto the windscreen, directly in your line of vision. Using the latest, brightest laser display technology for maximum clarity, it allows you to watch your speed, see navigation turn-by-turn guidance and gear placement.

XE even monitors road signs for you. Jaguar's Traffic Sign Recognition\*\* technology can detect current speed limit signs to display them on both the instrument cluster and Head-Up Display. This smart system is also aware of local conditional speed limits. When it's raining, any mandatory lower speed limit will be displayed until the rain stops. If you are towing, the appropriate legal speed limit will be shown. 'No Overtaking' signs also display in the instrument cluster.

\*Available as an option  
\*\*Requires Navigation System

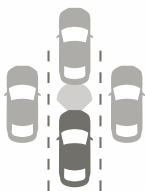

ADAPTIVE CRUISE  
CONTROL\*



ISOFIX  
CAR SEAT SAFETY  
SYSTEM



## IN COMMAND



XE's command centre is called InControl Touch. It is the hub which gives control over the car's major functions including audio, climate control and satellite navigation. It also enables telephone connectivity, to keep you in touch. The 8 inch Touch-screen in the centre console features an all new graphical interface and fast system response times, as well as familiar tablet and smartphones gestures such as 'stretch' and 'swipe'.

## IN CONTROL



XE's all new InControl suite of products are accessed via the InControl system. They offer the latest technologies to connect you and your car to the outside world.

**InControl Protect\*** includes SOS Emergency Call, which automatically brings the relevant services to your exact location in the event of a critical situation. It also provides Optimised Jaguar Assistance to transmit your location and vehicle diagnostic data to help minimise delays to your journey. The Remote Essentials App enables you to monitor your XE through your smartphone to check fuel level and whether, or not, it is locked.

**InControl Secure\*** detects any illegal movement of your XE to alert you and liaise with the authorities to pinpoint the vehicle's whereabouts.

**InControl Connect\*** includes Remote Premium. This provides additional features to the Remote Essentials App allowing you to remotely pre-heat or pre-cool the car. InControl Connect also features Jaguar InControl Apps. Simply download Jaguar InControl Apps to your smartphone. You can then connect your smartphone via the USB port to display compatible Apps on the Touch-screen in the centre console. Wi-Fi Hotspot provides XE with a powerful external aerial for reception of the strongest possible mobile and data signal allowing passengers to wirelessly connect a range of devices with XE's Infotainment system and the Internet.

\*InControl is the very latest in in-car technology for Jaguar. As we systematically roll out InControl, its availability and the availability of certain features remain market dependent. Please consult your local Jaguar dealer for further details. The InControl Remote smartphone App will work with Android devices from version 4.1 and Apple devices from iOS V6.0. Wi-Fi requires a SIM with a suitable data contract.





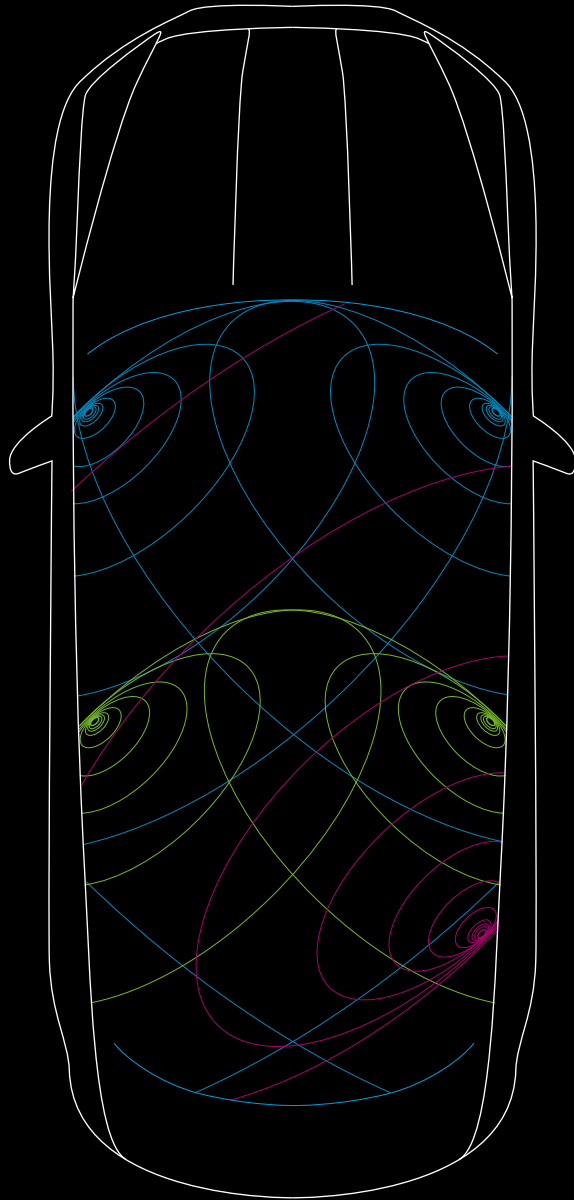

## IN CONCERT



JAGUAR  
SOUND SYSTEM

MERIDIAN 380W  
SOUND SYSTEM

Two superb audio systems bring entertainment in XE to life.

**The Jaguar Sound System** brings acoustic range and power to XE's interior with 6 speakers, 80W and 4 channels. An optional higher specification system, **the 380W Meridian Sound System**, designed in conjunction with British audio experts Meridian specifically for XE, offers superb audio reproduction through 12 channels and 11 speakers – including a subwoofer. It features advanced technology, such as Digital Signal Processing (DSP) technology, to optimise every element of the system and uses Meridian Cabin Correction's advanced algorithm to tailor the music experience to the precise acoustics of the vehicle's interior.



-  Fresh air subwoofer
-  Front door waves tweeter midrange bass
-  Rear door waves tweeter midrange

Diagram representative of Meridian 380W Sound System.



MERIDIAN



**80** WATTS  
**6** SPEAKERS  
**4** AMPLIFIER CHANNELS

**JAGUAR SOW**  
80W, 6 Speakers, 4 channel amplifier,  
Audyssey MultEQ Audio Equalisation,  
Dynamic volume control



**380** WATTS  
**11** SPEAKERS  
**12** AMPLIFIER CHANNELS

**MERIDIAN 380W**  
380W, 11 Speakers, 12 channel class D  
DSP amplifier, Audyssey MultEQ Audio  
Equalisation, Dynamic volume control



Go behind the scenes at Jaguar. Download the Jaguar Magazine app - just search "Jaguar Magazine" in the App Store™.







## YOU AND YOUR XE

This is where it becomes your XE. Your choices create the car you'll love. Select the body colour and pick the perfect wheels to complement it. You can make your XE unique inside by choosing from a collection of premium materials and textures as well as a palette of stunning colour combinations. With Jaguar's exceptional collection of accessories and options your XE is ready to fit in with your life and your lifestyle. The finest XE in the world. Yours.

Discover more at [jaguar.com/XEaccessories](http://jaguar.com/XEaccessories)

VEHICLES SHOWN: XE S IN ITALIAN RACING RED WITH OPTIONAL 20" PROPELLER ALLOY WHEELS, XE PURE IN GLACIER WHITE WITH OPTIONAL 18" MATRIX ALLOY WHEELS, XE R-SPORT IN BLUEFIRE WITH OPTIONAL 19" STAR ALLOY WHEELS, LONDON, UK



## EXTERIOR COLOURS

### SOLID

Polaris White

Ebony

### METALLIC

Glacier White

Rhodium Silver

Osmium

Quartzite

Ammonite Grey

Bluefire

Dark Sapphire





Odyssey Red

Italian Racing Red

British Racing Green

Ultimate Black

PREMIUM PALETTE  
Ingot

Tempest Grey  
(Available from June 2015)

Storm Grey  
(Available from June 2015)

Celestial Black

Black Cherry



**> 17" ALLOY WHEELS**



**17" TURBINE\***  
10 SPOKE SPARKLE SILVER  
Standard on Pure and Prestige



**17" LIGHTWEIGHT\*\***  
15 SPOKE SPARKLE SILVER  
Standard on Pure, Prestige,  
Portfolio and R-Sport



**17" AERODYNAMIC\*\***  
10 SPOKE SPARKLE SILVER  
Option on Pure, Prestige,  
Portfolio and R-Sport



**17" PROJECTOR\***  
5 SPOKE SPARKLE SILVER  
Option on Pure and Prestige



**17" CRUX\***  
7 TWIN SPOKE SPARKLE SILVER  
Option on Pure and Prestige

**> 18" ALLOY WHEELS**



**18" ARM\***  
6 SPOKE SPARKLE SILVER  
Standard on Portfolio.  
Option on Pure, Prestige,  
and R-Sport



**18" MATRIX\***  
7 TWIN SPOKE SPARKLE SILVER  
Option on Pure, Prestige,  
Portfolio and R-Sport



**18" MATRIX\***  
7 TWIN SPOKE BLACK  
Option on Pure, Prestige,  
Portfolio and R-Sport



**18" STAR\***  
5 SPOKE  
SILVER/DIAMOND TURNED  
Standard on R-Sport.  
Option on Pure, Prestige,  
Portfolio and S



**18" TEMPLAR\***  
5 TWIN SPOKE  
SILVER/DIAMOND TURNED  
Standard on S.  
Option on Pure, Prestige,  
Portfolio and R-Sport

**> 19" ALLOY WHEELS**



**19" STAR\***  
5 TWIN SPOKE SPARKLE SILVER  
Option on Pure, Prestige,  
Portfolio, R-Sport and S



**19" RADIANCE\***  
15 SPOKE SPARKLE SILVER  
Option on Pure, Prestige,  
Portfolio, R-Sport and S



**19" RADIANCE\***  
15 SPOKE  
BLACK/DIAMOND TURNED  
Option on Pure, Prestige,  
Portfolio, R-Sport and S



**19" VENOM\***  
5 TWIN SPOKE  
SILVER/DIAMOND TURNED  
Option on Pure, Prestige,  
Portfolio, R-Sport and S



**19" VENOM\***  
5 TWIN SPOKE BLACK  
Option on Pure, Prestige,  
Portfolio, R-Sport and S

**> 20" ALLOY WHEEL**



**20" PROPELLER\***  
10 SPOKE SILVER/DIAMOND  
TURNED  
Option on S

\*Not available on models with 163PS Diesel engine  
\*\*Only available on models with 163PS Diesel engine



 MATERIALS

CLOTHS AND LEATHERS





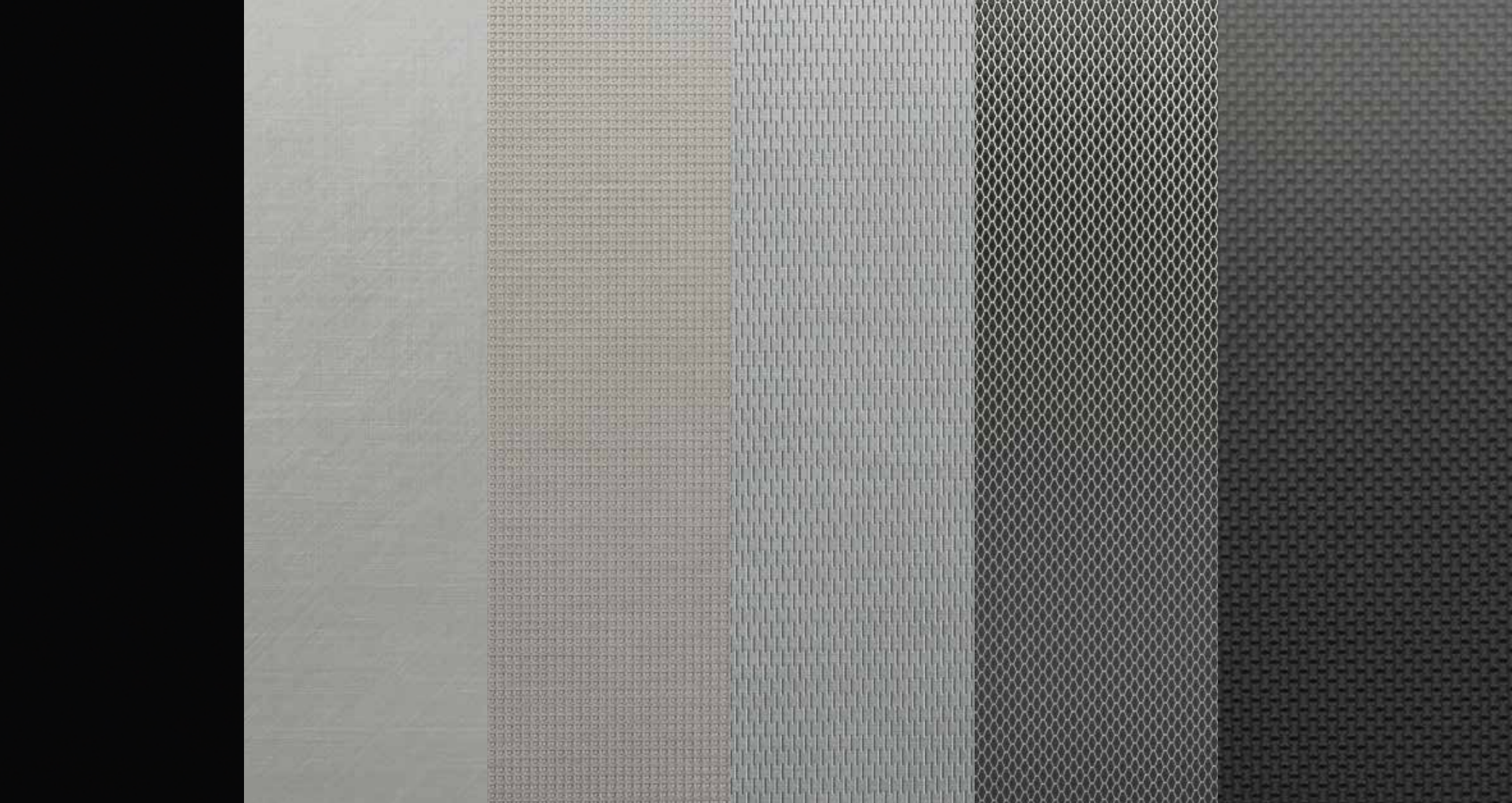

VENEERS AND FINISHERS

Gloss Black

Brushed Aluminium

Embossed Aluminium

Etched Aluminium

Meshed Aluminium

Carbon Fibre





Satin Ash Burl



Gloss Figured Ebony



Satin Grey Ash



Satin Grey Figured Ebony



Satin Fine Line Wood



# MODELS

## STANDARD FEATURES

- Intelligent Stop/Start system
- Hill Launch Assist
- JaguarDrive Control
- Electric Power Assisted Steering (EPAS)
- Torque Vectoring by Braking
- Electric Parking Brake (EPB) – drive-away release
- Variable Intermittent Wipers
- Electric windows – front and rear, with one-touch open/close and anti-trap
- Dual-zone climate control
- 8 inch colour Touch-screen display
- USB, Auxiliary socket and iPod connectivity
- Bluetooth® telephone connectivity
- Bluetooth® Streaming
- Emergency Brake Assist
- Dynamic Stability Control and Traction Control
- Jaguar Smart Key System with Keyless Start
- Airbags – Driver and front passenger, with seat occupant detector for passenger, front side and full length side window curtain
- Hazard lights under heavy braking
- Heated door mirrors
- Interior Mood lighting
- Jaguar Sound System

## DIMENSIONS

Width: (inc. mirrors) 2,075mm  
Height: 1,416mm  
Length: 4,672mm

## DESIGNER'S INSPIRATION

XE's designers are inspired by the craftsmanship and attention to detail of some of the world's most exclusive brands. They bring together the finest materials to create interior combinations that are uniquely Jaguar.



## XE R-SPORT

### ENGINES

2.0 i4 163 Diesel E-Performance with either 6-speed manual transmission\* or 8-speed electronic automatic transmission, Jaguar Sequential Shift and All Surface Progress Control\*

2.0 Litre i4 180 Turbocharged Diesel with either 6-speed manual transmission\* or 8-speed electronic automatic transmission, Jaguar Sequential Shift and All Surface Progress Control

2.0 Litre i4 200 Turbocharged Petrol with 8-speed electronic automatic transmission, Jaguar Sequential Shift and All Surface Progress Control

2.0 Litre i4 240 Turbocharged Petrol with 8-speed electronic automatic transmission, Jaguar Sequential Shift and All Surface Progress Control

### KEY FEATURES

18" Star 5 Spoke Silver/Diamond Turned Alloy Wheels

17" Lightweight 15 Spoke Sparkle Silver Alloy Wheels (E-Performance)

Interior featuring Luxtec Sports seats with Technical Mesh inserts

Etched Aluminium veneer

R-Sport branded Soft grain Leather steering wheel

Radiator Grille – Black with Satin Chrome surround

R-Sport bodykit – R-Sport Front Bumper, R-Sport body-coloured side sills, Satin Chrome Side Power Vents with R-Sport Badge and Bootlid Spoiler

Metal sill finishers with Jaguar R-Sport branding

Sports suspension



## XE S

### ENGINE

3.0 Litre V6 340 Supercharged Petrol with 8-speed electronic automatic transmission, Jaguar Sequential Shift and All Surface Progress Control

### KEY FEATURES

18" Templar 5 Twin Spoke Silver/Diamond Turned Alloy Wheels

Interior featuring Taurus grain Leather Sports seats with Suedecloth inserts and contrast stitch

Meshed Aluminium veneer

S Branded Soft grain Leather Sports steering wheel

Radiator Grille – Gloss Black with Satin Chrome surround and S Badge

S Bodykit – S Front Bumper, S Body-coloured and Gloss Black side sills, S Gloss Black rear valance and Bootlid Spoiler

Satin Chrome Side Power Vents

Red Brake Calipers

Bi-function HID Xenon headlamps

Metal sill finishers with Jaguar S branding

Bright stainless steel pedal covers

Adaptive Dynamics





## XE PURE

### ENGINES

2.0 i4 163 Diesel E-Performance with either 6-speed manual transmission\* or 8-speed electronic automatic transmission, Jaguar Sequential Shift and All Surface Progress Control\*

2.0 Litre i4 180 Turbocharged Diesel with either 6-speed manual transmission\* or 8-speed electronic automatic transmission, Jaguar Sequential Shift and All Surface Progress Control

2.0 Litre i4 200 Turbocharged Petrol with 8-speed electronic automatic transmission, Jaguar Sequential Shift and All Surface Progress Control

2.0 Litre i4 240 Turbocharged Petrol with 8-speed electronic automatic transmission, Jaguar Sequential Shift and All Surface Progress Control

### KEY FEATURES

17" Turbine 10 Spoke Sparkle Silver Alloy Wheels

17" Lightweight 15 Spoke Sparkle Silver Alloy Wheels (E-Performance)

Interior featuring Cloth seats

Gloss Black veneer

Leather steering wheel

Radiator Grille - Black with Chrome surround

Chrome Side Power Vents

Sill finishers with Jaguar lettering



## XE PRESTIGE

### ENGINES

2.0 i4 163 Diesel E-Performance with either 6-speed manual transmission\* or 8-speed electronic automatic transmission, Jaguar Sequential Shift and All Surface Progress Control\*

2.0 Litre i4 180 Turbocharged Diesel with either 6-speed manual transmission\* or 8-speed electronic automatic transmission, Jaguar Sequential Shift and All Surface Progress Control

2.0 Litre i4 200 Turbocharged Petrol with 8-speed electronic automatic transmission, Jaguar Sequential Shift and All Surface Progress Control

2.0 Litre i4 240 Turbocharged Petrol with 8-speed electronic automatic transmission, Jaguar Sequential Shift and All Surface Progress Control

### KEY FEATURES

17" Turbine 10 Spoke Sparkle Silver Alloy Wheels

17" Lightweight 15 Spoke Sparkle Silver Alloy Wheels (E-Performance)

Interior featuring Taurus Leather seats with contrast stitch

Brushed Aluminium veneer

Soft grain Leather steering wheel

Radiator Grille - Black with Chrome surround

Chrome Side Power Vents

Metal sill finishers with Jaguar lettering



## XE PORTFOLIO

### ENGINES

2.0 i4 163 Diesel E-Performance with either 6-speed manual transmission\* or 8-speed electronic automatic transmission, Jaguar Sequential Shift and All Surface Progress Control\*

2.0 Litre i4 180 Turbocharged Diesel with either 6-speed manual transmission\* or 8-speed electronic automatic transmission, Jaguar Sequential Shift and All Surface Progress Control

2.0 Litre i4 200 Turbocharged Petrol with 8-speed electronic automatic transmission, Jaguar Sequential Shift and All Surface Progress Control

2.0 Litre i4 240 Turbocharged Petrol with 8-speed electronic automatic transmission, Jaguar Sequential Shift and All Surface Progress Control

### KEY FEATURES

18" Arm 6 Spoke Sparkle Silver Alloy Wheels

17" Lightweight 15 Spoke Sparkle Silver Alloy Wheels (E-Performance)

Interior featuring Windsor grain Leather seats with Herringbone perforations and tonal stitch

Embossed Aluminium veneer

Soft grain Leather steering wheel

Radiator Grille - Gloss Black with Chrome surround

Chrome Side Power Vents

Metal sill finishers with Jaguar lettering

Bi-Function HID Xenon headlamps



\*Available from mid 2015

# XE R-SPORT

Bolder and more assertive. Unmistakable sportiness outside and inside.

## OPTIONS AND ACCESSORIES\*



Accessory Sports Roof Box



Heated Door Mirror with Memory. Available as part of Memory Pack



Accessory Gloss Black Side Power Vents



Optional Bi-Function HID Xenon Headlamp with Headlamp Power Wash

\*Available at extra cost

VEHICLE SHOWN: XE R-SPORT IN BLUEFIRE WITH OPTIONAL 19" STAR ALLOY WHEELS





 Configure your vehicle at [JAGUAR.COM](https://www.jaguar.com)













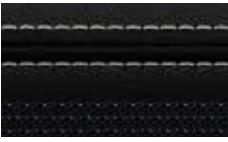



Interior Shown: Jet Luxtec Sports seats with Midnight Blue technical mesh inserts and Blue contrast stitch, Jet fascia, Etched Aluminium finisher and Gloss Black console finisher



# XE R-SPORT

## INTERIOR COLOUR COMBINATIONS

### STANDARD

	DUOTONE SEAT WITH CONTRAST STITCH	FACIA	FINISHER*	HEADLINING	CARPET
TR08	 Jet/Jet with Light Oyster	 Jet	 Etched Aluminium	 Jet	 Jet
TR09	 Jet/Red with Red	 Jet	 Etched Aluminium	 Jet	 Jet
TR11	 Jet/Midnight Blue with Blue	 Jet	 Etched Aluminium	 Jet	 Jet

### VENEER OPTIONS

Satin Ash Burl, Gloss Figured Ebony, Satin Grey Ash, Satin Grey Figured Ebony, Satin Fine Line Wood or Carbon Fibre

\*Console finisher is Gloss Black

IMAGE SHOWN TOP RIGHT: ACCESSORY SPORTS PEDALS  
 CENTRE: OPTIONAL ACCESSORY SILVER ALUMINIUM GEARSHIFT PADDLES  
 BOTTOM: OPTIONAL INCONTROL CONNECT







Interior Shown: Jet and Jet perforated leather Sports seats with Light Oyster contrast stitch, Jet fascia with Light Oyster contrast stitch, Etched Aluminium finisher and Gloss Black console finisher

# XE R-SPORT

## INTERIOR COLOUR COMBINATIONS

### OPTIONS

	DUOTONE SEAT WITH CONTRAST STITCH	FACIA WITH CONTRAST STITCH	FINISHER*	HEADLINING	CARPET
TR08+B41T					
	Jet/Jet with Light Oyster	Jet with Light Oyster	Etched Aluminium	Jet	Jet
TR10					
	Jet/Red with Red	Jet with Red	Etched Aluminium	Jet	Jet
TR12					
	Jet/Midnight Blue with Blue	Jet with Blue	Etched Aluminium	Jet	Jet
TR13					
	Jet/Light Oyster with Light Oyster	Jet with Light Oyster	Etched Aluminium	Jet	Jet

### VENEER OPTIONS

Satin Ash Burl, Gloss Figured Ebony, Satin Grey Ash, Satin Grey Figured Ebony, Satin Fine Line Wood or Carbon Fibre

\*Console finisher is Gloss Black

IMAGE SHOWN TOP RIGHT: ACCESSORY UNION JACK TREAD PLATES  
CENTRE: ACCESSORY HEADREST MOUNTED COAT HANGER  
BOTTOM: OPTIONAL PREMIUM CARPET MATS





# XE S

XE at its most thrilling and most performance-focused. XE with F-TYPE power.

## OPTIONS AND ACCESSORIES\*



Accessory Carbon Fibre Side Vents



Accessory Carbon Fibre Mirror Covers



Optional Privacy Glass



Optional Adaptive Front Headlamps. Available as part of Lighting Pack

\*Available at extra cost

VEHICLE SHOWN: XE S IN ITALIAN RACING RED WITH OPTIONAL 20" PROPELLER ALLOY WHEELS AND PANORAMIC SUNROOF





 Configure your vehicle at [JAGUAR.COM](https://www.jaguar.com)













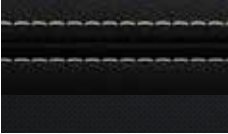



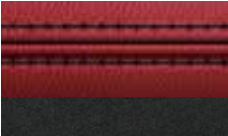



Interior Shown: Red leather Sports seats with Jet Suedecloth inserts and Jet contrast stitch, Jet fascia with Red contrast stitch, Meshed Aluminium finisher and Gloss Black console finisher

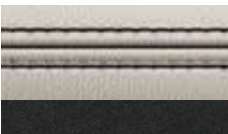

# XE S

## INTERIOR COLOUR COMBINATIONS

### STANDARD

	DUOTONE SEAT WITH CONTRAST STITCH	FACIA WITH CONTRAST STITCH	FINISHER*	HEADLINING	CARPET
TR21	 Jet/Jet with Light Oyster	 Jet with Light Oyster	 Meshed Aluminium	 Jet	 Jet
TR14	 Red/Jet with Jet	 Jet with Red	 Meshed Aluminium	 Jet	 Jet
TR15	 Midnight Blue/Jet with Jet	 Jet with Midnight Blue	 Meshed Aluminium	 Jet	 Jet
TR16	 Light Oyster/Jet with Jet	 Jet with Light Oyster	 Meshed Aluminium	 Jet	 Jet

### VENEER OPTIONS

Satin Ash Burl, Gloss Figured Ebony, Satin Grey Ash, Satin Grey Figured Ebony, Satin Fine Line Wood or Carbon Fibre

\*Console finisher is Gloss Black

IMAGE SHOWN TOP RIGHT: OPTIONAL HEAD-UP DISPLAY  
CENTRE: OPTIONAL NAVIGATION PACK  
BOTTOM: ACCESSORY RED ALUMINIUM GEARSHIFT PADDLES







Interior Shown: Jet perforated leather Sports seats with Light Oyster stitch, Jet fascia with Light Oyster contrast stitch, Meshed Aluminium finisher and Gloss Black console finisher

# XE S

## INTERIOR COLOUR COMBINATIONS

### OPTIONS

DUOTONE SEAT WITH  
CONTRAST STITCH

FACIA WITH  
CONTRAST STITCH

TR21+B41T

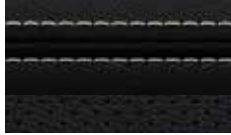

Jet/Jet with Light Oyster



Jet with Light Oyster

TR14+B41T



Red/Jet with Jet



Jet with Red

TR15+B41T

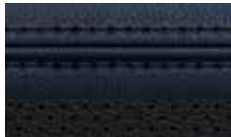

Midnight Blue/Jet with Jet



Jet with Midnight Blue

TR16+B41T



Light Oyster/Jet with Jet



Jet with Light Oyster

FINISHER\*



Meshed Aluminium

HEADLINING



Jet

CARPET



Jet



Meshed Aluminium



Jet



Jet



Meshed Aluminium



Jet



Jet



Meshed Aluminium



Jet



Jet



### VENEER OPTIONS

Satin Ash Burl, Gloss Figured Ebony, Satin Grey Ash, Satin Grey Figured Ebony, Satin Fine Line Wood or Carbon Fibre

\*Console finisher is Gloss Black

IMAGE SHOWN TOP RIGHT: ACCESSORY IPAD HOLDER  
CENTRE: OPTIONAL INCONTROL APPS (PART OF INCONTROL CONNECT)  
BOTTOM: OPTIONAL HEATED STEERING WHEEL



# XE PURE

The essence of XE. Class leading, driver-focused performance with refinement.

## OPTIONS AND ACCESSORIES\*



Accessory Cross Bars



Optional Detachable Tow Bar



Optional Panoramic Sunroof



Optional 18" Matrix 7 Twin Spoke Sparkle Silver Alloy Wheel

\*Available at extra cost

VEHICLE SHOWN: XE PURE IN GLACIER WHITE WITH OPTIONAL 18" MATRIX ALLOY WHEELS AND PANORAMIC SUNROOF





 Configure your vehicle at [JAGUAR.COM](https://www.jaguar.com)



Interior Shown: Jet cloth seats with Jet facia and Gloss Black finishers

# XE PURE

## INTERIOR COLOUR COMBINATIONS

### STANDARD

	SEAT	FACIA	FINISHER	HEADLINING*	CARPET
TR01					
	Jet	Jet	Gloss Black	Light Oyster	Jet
TR02					
	Latte	Jet	Gloss Black	Light Oyster	Jet
TR03					
	Pebble Grey	Oyster	Gloss Black	Light Oyster	Oyster



\*Jet Morzine headlining available as a cost option

IMAGE SHOWN TOP RIGHT: ACCESSORY PREMIUM SEAT BACK STOWAGE  
CENTRE: OPTIONAL REAR PARKING AID  
BOTTOM: OPTIONAL SPLIT FOLD REAR SEAT



# XE PRESTIGE

Adding even greater luxury, a contemporary space with modern materials.

## OPTIONS AND ACCESSORIES\*



Optional Adaptive Bi-function HID Xenon Headlamps with LED Daytime Running Lights



Optional Powered bootlid



Accessory Chrome Front Splitter (shown) and Body Coloured Spoiler



Accessory Chrome Mirror Covers

\*Available at extra cost

VEHICLE SHOWN: XE PRESTIGE IN TEMPEST GREY WITH OPTIONAL 18" MATRIX ALLOY WHEELS AND PANORAMIC SUNROOF



 Configure your vehicle at [JAGUAR.COM](https://www.jaguar.com)





Interior Shown: Latte leather seats with Jet contrast stitch, Jet fascia upper, Latte fascia lower, Brushed Aluminium finisher and Gloss Black console finisher



# XE PRESTIGE

## INTERIOR COLOUR COMBINATIONS

### STANDARD

	SEAT WITH CONTRAST STITCH	FACIA UPPER/LOWER	FINISHER*	HEADLINING	CARPET
TR05	 Jet with Siena Tan	 Jet with Jet	 Brushed Aluminium	 Light Oyster	 Jet
TR06	 Latte with Jet	 Jet with Latte	 Brushed Aluminium	 Light Oyster	 Jet
TR07	 Light Oyster with Pistachio	 Oyster with Light Oyster	 Brushed Aluminium	 Light Oyster	 Oyster



### OPTIONS

#### HEADLINING

Jet

#### VENEER

Satin Ash Burl, Gloss Figured Ebony, Satin Grey Ash, Satin Grey Figured Ebony, Satin Fine Line Wood or Carbon Fibre

\*Console finisher is Gloss Black

IMAGE SHOWN TOP RIGHT: ACCESSORY ILLUMINATED TREAD PLATES  
 CENTRE: OPTIONAL MERIDIAN 380W SOUND SYSTEM  
 BOTTOM: ACCESSORY CENTRE ARMREST CHILLER/WARMER

# XE PORTFOLIO

The pinnacle of XE luxury, craftsmanship and attention to detail.

## OPTIONS AND ACCESSORIES\*



Accessory Gloss Black Mirror Covers



Accessory Chrome Grille



Optional electrically deployable Tow Bar



Accessory Luggage Roof Box

\*Available at extra cost

VEHICLE SHOWN: XE PORTFOLIO IN AMMONITE GREY WITH OPTIONAL 18" MATRIX ALLOY WHEELS





 Configure your vehicle at [JAGUAR.COM](https://www.jaguar.com)













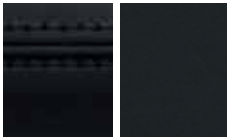



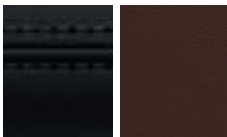

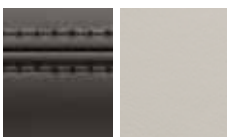



Interior Shown: Brogue leather seats with Herringbone perforations and Brogue tonal stitch, Jet fascia upper with Jet tonal stitch, Brogue fascia lower, Embossed Aluminium finisher and Gloss Black console finisher

# XE PORTFOLIO

## INTERIOR COLOUR COMBINATIONS

### STANDARD

	SEAT WITH TONAL STITCH	FACIA UPPER WITH TONAL STITCH/LOWER
TR17	 Jet with Jet	 Jet with Jet/Jet
TR18	 Siena Tan with Siena Tan	 Jet with Jet/Siena Tan
TR19	 Brogue with Brogue	 Jet with Jet/Brogue
TR20	 Light Oyster with Light Oyster	 Oyster with Oyster/ Light Oyster

FINISHER*	HEADLINING	CARPET
 Embossed Aluminium	 Light Oyster	 Jet
 Embossed Aluminium	 Light Oyster	 Jet
 Embossed Aluminium	 Light Oyster	 Jet
 Embossed Aluminium	 Light Oyster	 Oyster



### OPTIONS

#### HEADLINING

Jet

#### VENEER

Satin Ash Burl, Gloss Figured Ebony, Satin Grey Ash, Satin Grey Figured Ebony, Satin Fine Line Wood or Carbon Fibre

\*Console finisher is Gloss Black

IMAGE SHOWN TOP RIGHT: ACCESSORY LEATHER TOPPED GEAR SELECTOR  
CENTRE: OPTIONAL HEATED FRONT WINDSCREEN  
BOTTOM: OPTIONAL ADVANCED PARKING ASSIST PACK









## EXPERIENCE XE. EXPERIENCE JAGUAR

There's no better way to get to know XE and Jaguar than by taking a drive. Jaguar Experience offers a range of unique opportunities to really find out what we mean when we say our cars feel alive. Our track experiences allow you to push yourself, XE and other cars from the incredible Jaguar range to the limit. Jaguar Experience also offers the opportunity to see a Jaguar brought to life during a tour of one of our UK manufacturing facilities. Find out more by visiting [jaguar.com/experience](http://jaguar.com/experience)

To test drive XE, please contact your local Jaguar dealer directly.







# JAGUAR CARE: COMPLETE PEACE OF MIND



UNLIMITED MILEAGE

3 YEARS' WARRANTY

3 YEARS' FREE SERVICING

XE is the most appealing choice in its class. It is also one of the most cost-efficient cars in its class too. What makes it totally irresistible is that every new XE comes with Jaguar Care, which includes a three year warranty and three years' free standard servicing<sup>1</sup>. This incredible unlimited mileage programme is valid across selected European countries<sup>2</sup>. So however far you drive, every kilometre will be worry free. Kilometre after kilometre, year after year, XE is the smarter choice.

To find out more about XE's class-leading Jaguar Care programme, please go to [jaguar.com/jaguarcare](http://jaguar.com/jaguarcare)



<sup>1</sup>Excludes wear and tear items

<sup>2</sup>Visit [jaguar.com/jaguarcaretermsandconditions](http://jaguar.com/jaguarcaretermsandconditions) to find out which countries offer the Jaguar Care programme

VEHICLE SHOWN: XE PURE IN GLACIER WHITE WITH OPTIONAL 18" MATRIX ALLOY WHEELS AND PANORAMIC SUNROOF, LONDON FINANCIAL DISTRICT







#### IMPORTANT NOTICE

Jaguar Land Rover Limited is constantly seeking ways to improve the specification, design and production of its vehicles and alterations take place continually. While every effort is made to produce up-to-date literature, this brochure should not be regarded as an infallible guide to current specifications, nor does it constitute an offer for the sale of any particular vehicle. Distributors and dealers are not agents of Jaguar Land Rover Limited by any express or implied undertaking or representation. Comparisons are based on manufacturer's own data and testing.

#### ENVIRONMENTAL INNOVATION AT JAGUAR

Jaguar is proud to continue the company's tradition with its approach to Environmental Innovation. From the choice of lightweight materials and lean production methods to the efficiency of its engines and designs, Jaguar is committed to operating as a more sustainable business and reducing its overall environmental impact.

Jaguar's flagship XJ model was the first in the company to achieve ISO14040, the international standard for vehicle 'life cycle assessment'. This certification measures the environmental impact of XJ from component material sourcing and manufacturing process, through driving 200,000 km. But that's not all. Every new Jaguar is designed to be 85% Recyclable/ Reusable and 95% Recoverable at the end of the vehicle's life.

The XE, XJ, F-TYPE and XK's innovative use of lightweight aluminium, which incorporates up to 50% closed-loop recycled material from the manufacturing process of the body structures, provides considerable performance benefits. This includes improved fuel consumption and less CO<sub>2</sub> emissions during the use phase of the Life Cycle due to lighter structures. Our on-going target is to ensure scrap aluminium reclaimed from our stamping process is to be segregated and recycled through a closed loop system and re-melted into the same grade quality sheet, therefore reducing CO<sub>2</sub> emissions during the production phase of the Life Cycle. Jaguar is committed to reducing dependency on fossil fuels, using fewer resources and creating less waste as part of our approach to sustainability excellence.

The company plan includes 25% reduction targets in operating and tailpipe CO<sub>2</sub> emissions, waste to landfill, logistics efficiencies (15%) and water consumption (10%), all based on per vehicle built since 2007. In addition the manufacturing assembly CO<sub>2</sub> emissions of each Jaguar built in the UK since 2009 is 100% offset. For each tonne of CO<sub>2</sub> emitted in the assembly process, Jaguar invests in projects that reduce an equivalent tonne of CO<sub>2</sub> elsewhere. Taking into account the company's global sales growth and increased investment in more efficient operating facilities, we are proud to have delivered and in some cases exceeded our Environmental Innovation targets as planned for 2012. And we are on track to meet our 25% reduction in joint European fleet average tailpipe CO<sub>2</sub> emissions by 2015.

Looking forward, we have developed our 2020 vision for sustainable business growth that focuses on continued improvements in tailpipe CO<sub>2</sub> emissions, operational carbon neutrality and zero waste. To date the company has offset over 6 million tonnes of CO<sub>2</sub>, provided over 4,000 direct jobs in 60 emissions reductions projects in 17 countries and improved the lives of over 1 million people in our global cook stoves emissions reduction programme.

But it doesn't stop there. Our manufacturing facilities have been certified to ISO14001 since 1998 and we are credited to Platinum Plus level in the UK's Business in the Community Corporate Responsibility Index.

Castrol® EDGE™ Professional is exclusively recommended by Jaguar.

The Bluetooth® word mark and logos are owned by the Bluetooth SIG, Inc. and any use of such marks by Jaguar Land Rover Limited is under license.

iPod, iPod touch and iPad are trademarks of Apple Inc, registered in the US and other countries.

**FRONT COVER: XE S IN ITALIAN RACING RED WITH OPTIONAL 20" PROPELLER ALLOY WHEELS AND PANORAMIC SUNROOF, CENTRAL LONDON, UK**  
**BACK COVER: XE PURE IN GLACIER WHITE WITH OPTIONAL PANORAMIC SUNROOF AND REAR PARKING AID**  
**IMAGE SHOWN: XE R-SPORT IN BLUEFIRE WITH OPTIONAL 19" STAR ALLOY WHEELS**

Jaguar Land Rover Limited  
Registered Office: Abbey Road, Whitley,  
Coventry, CV3 4LF, United Kingdom  
Registered in England Number: 1672070  
jaguar.com



MIX  
Paper from  
responsible sources  
FSC® C013204

Printed in England September 2015/16MY  
JLM/24/02/86/0915

