

NEW JAGUAR XJ



THE ART OF PERFORMANCE





BY APPOINTMENT TO
HM THE QUEEN
MANUFACTURERS OF
MOTOR VEHICLES
JAGUAR LAND ROVER LIMITED
COVENTRY



BY APPOINTMENT TO
HRH THE DUKE OF EDINBURGH
MANUFACTURERS OF
MOTOR VEHICLES
JAGUAR LAND ROVER LIMITED
COVENTRY



BY APPOINTMENT TO
HRH THE PRINCE OF WALES
MANUFACTURERS OF
MOTOR VEHICLES
JAGUAR LAND ROVER LIMITED
COVENTRY



JAGUAR

THE ART OF PERFORMANCE

Every day we push performance to its limit. Our performance. Our cars' performance.
We innovate, we engineer, we design. We master rules and then break them.
Only to push further. Past the limits of convention. This is when performance becomes art.

Jaguar. The Art of Performance.



CONTENTS

INTRODUCTION

The Concept of XJ	06
XJ - The Facts	08

DESIGN

Exterior Principles	10
Exterior - A New Look	13
Exterior View	15
Interior Technology	17
Interior Luxury	18
Interior Comfort	21
Interior Space	22

PERFORMANCE

Engines	24
All-Aluminium Body	26
Advanced Driving Dynamics	28
XJR - Performance and Luxury	33
XJR - Sporting Style	34

DRIVING TECHNOLOGY

All Surface Progress Control	36
Advanced Drivetrain Technology	38

INFOTAINMENT

InControl Technologies	40
InControl Touch Pro and InControl Connect Pro	43
Audio	44

SAFETY AND EFFICIENCY

Advanced Driver Assistance	46
Efficient Technologies	48

PERSONALISATION

XJ - Your Choice	50
Choose your Engine	52
Choose your Model	54
Choose your Options	56
Choose your Colour	64
Choose your Wheels	66
Choose your Interior	68
Choose your Jaguar Accessories	84
Technical Specifications	86
Dimensions	88

JAGUAR WORLD

Jaguar Experience	90
World of Jaguar	92
Glossary and Legal Information	94



Scan to find out more about the new Jaguar XJ.

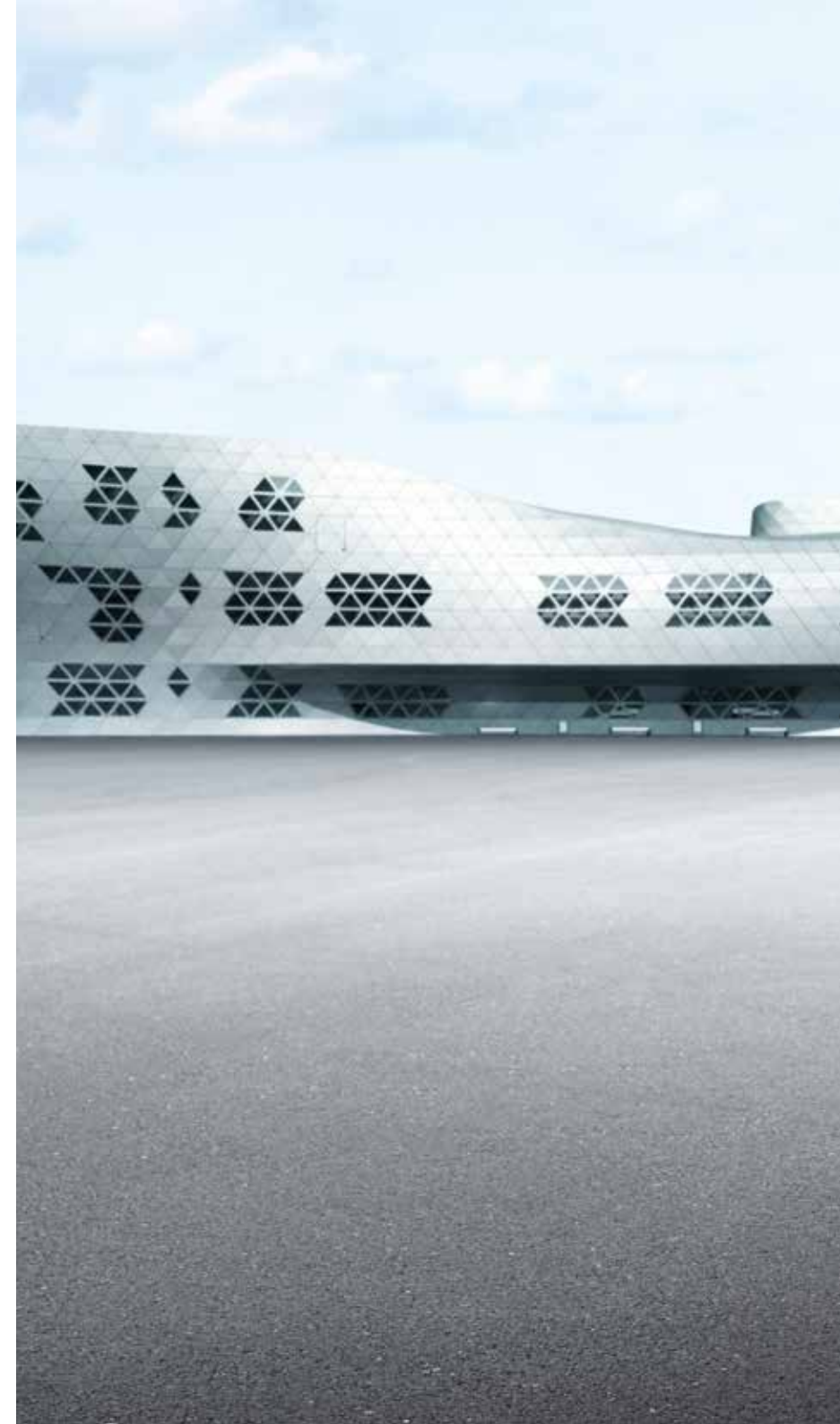

INTRODUCTION THE CONCEPT OF XJ

The new XJ is Jaguar's pinnacle saloon car, the perfect combination of cutting-edge technology, sporting vehicle dynamics, and opulent luxury. Its new more assertive styling turns heads with a remodelled front, a more upright grille and new energy efficient full-LED headlights featuring the unique 'Double J' Daytime Running Light design. While state-of-the-art systems keep you informed and safe, XJ's beauty and craftsmanship are brought together with the power and driving experience you expect from a Jaguar. In the cabin, there's space to stretch out to relax or work with the latest connected technology, InControl Connect Pro. XJ has everything to make your journey more productive, entertaining and relaxed.

VEHICLE SHOWN: XJ AUTOBIOGRAPHY LONG WHEELBASE IN DARK SAPPHIRE



XJ - THE FACTS

Jaguar's new technology is focused on enhancing the journey for you and your passengers. Dynamic systems assist performance, handling and comfort. XJ also features the latest connected technology, a more powerful engine and an array of luxury interior choices.

CONNECTED CAR*

InControl Connect Pro is a package of applications and technologies that keeps XJ connected to the world. It runs a suite of useful smartphone apps from the Touch-screen. A powerful antenna provides 3G Internet that can be accessed through an in-car Wi-Fi hotspot. With InControl Remote Premium you can connect to, and monitor, your XJ from anywhere and even pre-heat or cool the cabin before entering.

POWERFUL NEW 300PS DIESEL ENGINE

XJ's new updated 3.0 litre 300PS diesel engine offers improved performance and greater fuel efficiency delivering 0-100km/h in 6.2 seconds thanks to a torque output of 700Nm. Featuring an 8-speed automatic transmission with Intelligent Stop/Start,* it can deliver fuel economy from 5.7 l/100km and CO₂ emissions of just 149g/km.

JAGUAR CARE**

XJ is now offered with a new unlimited mileage, three year warranty and three years' standard servicing programme. We call this programme Jaguar Care.



*Market dependent

**Selected European markets only.

Some features described here are optional and market dependent.

VEHICLE SHOWN: XJ PORTFOLIO LONG WHEELBASE IN QUARTZITE WITH OPTIONAL PREMIUM REAR SEAT PACK AND OPTIONAL CLEAR GLASS

ALL ALUMINIUM CONSTRUCTION

XJ's all-aluminium body architecture is not only strong and rigid but also extremely light making the car highly responsive and agile, as well as fuel efficient. Riveted, and without a single welded joint, the 100 percent aluminium monocoque body structure makes this one of the lightest cars in its class and, without any compromise to the integrity of its body, one of the safest.

INCONTROL TOUCH PRO

Music, video, navigation, and all the essential in-car controls, including Bluetooth® phone connectivity, are at your fingertips. XJ's 8 inch Touch-screen responds to new smartphone style tap and swipe gestures and uses a powerful Intel Quad Core Processor to deliver the latest graphics and fast response.

QUILTED LEATHER SEATS

Portfolio and Autobiography models feature beautiful new seats with a classic feel. Soft grain leather upholstery is defined in a new diamond quilted contrast stitched pattern. Exclusive colour co-ordination continues throughout the cabin.



'DOUBLE J' HEADLIGHTS

Jaguar's unique 'Double J' Daytime Running Lights give XJ a new distinctive appearance. The full LED headlights supply a 'whiter' light than conventional Xenon beams. Being closer to daylight, objects can be better recognised, helping increase comfort and safety during night driving.



DESIGN EXTERIOR PRINCIPLES

DESIGN PURITY | **POWERFUL STANCE**

XJ stands out: authoritative, elegant, and powerful. XJ's teardrop shape is formed for optimum aerodynamic efficiency, reducing air resistance to a minimum, improving acceleration, fuel efficiency and CO₂ emissions. The shape is the result of exhaustive computational modelling where aesthetics and aerodynamics work together. The chrome outlined side windows emphasise XJ's pure, elongated form. XJ's low, wide stance and long, taut waistline create a commanding presence, while inside the cabin still feels airy and spacious thanks to its panoramic roof and smart design.

VEHICLE SHOWN: XJ AUTOBIOGRAPHY LONG WHEELBASE IN DARK SAPPHIRE WITH OPTIONAL 20" ORONA ALLOY WHEELS







EXTERIOR - A NEW LOOK



NEW FRONT GRILLE

'DOUBLE J' HEADLIGHTS

XJ's newly remodelled front includes a more upright front grille design with mesh detail. The grille is framed by new energy efficient full-LED headlights, sporting Jaguar's unique 'Double J' Daytime Running Light design. Producing a light with a colour temperature closer to natural daylight, objects can be better recognised helping increase comfort and safety during night driving.

At the rear, updates continue with elliptical tailpipes, a revised bumper design and new tail lights incorporating 'light pipe' LED technology. The LED light pipes are brighter, more efficient and illuminate faster than halogen bulbs - they use less energy, contributing to XJ's fuel economy. They also provide a striking, smooth uninterrupted 'ribbon of light', pinstripe graphic and combine with LED light chips to make XJ even more distinctive.

VEHICLE SHOWN: XJ R-SPORT STANDARD WHEELBASE IN ULTIMATE BLACK





EXTERIOR VIEW

FULL WIDTH PANORAMIC ROOF

The view from inside XJ is extensive: a panoramic, full width, heat-reflective glass roof sweeps back and over the rear seats. It filters UV rays and floods the interior with natural light making it feel airy, spacious and, thanks to effective tinting, very private. Power operated blinds allow you to completely block the light when required. Specially formulated toughened glass helps to keep the cabin cool.

VEHICLE SHOWN: XJ PORTFOLIO LONG WHEELBASE IN QUARTZITE WITH OPTIONAL PREMIUM REAR SEAT PACK AND OPTIONAL CLEAR GLASS





INTERIOR TECHNOLOGY

 **CONNECTED
INFOTAINMENT*** | **ADVANCED
GRAPHICS**

XJ's high-definition Instrument Panel Display puts everything you need to know about your driving right in front of you. A 12.3 inch TFT screen displays the speed, fuel and temperature gauges and can be set to display the most relevant information, depending on the situation and set up. This multi-layered virtual display has been remodelled and combines a new design and graphical interface adding advanced functionality to make finding the right settings even easier.

The Instrument Panel Display is fully integrated with the 8 inch Touch-screen to put all information behind the wheel or on the centre console. For example, when working with InControl Touch Pro Guidance the Instrument Panel Display can be reconfigured to show 3D mapping, making following your route even simpler.

*Market dependent

INTERIOR SHOWN: XJ PORTFOLIO LONG WHEELBASE SHOWING IVORY SOFT GRAIN PERFORATED LEATHER SEATS WITH JET CONTRAST STITCH, JET UPPER FACIA, JET SUEDECLOTH HEADLINING AND GLOSS RICH OAK VENEER

INTERIOR LUXURY

 CRAFTSMANSHIP | EXTENSIVE CHOICE

The quality of craftsmanship throughout the XJ cabin sets it apart. With a wide choice of colours, materials and finishes, the interior reflects the clarity and purity of XJ's exterior. The hand-crafted veneer that runs right around the cabin accentuates the sense of space. Jaguar's sporting character is present in the controls and architecture surrounding the driver including the leather-wrapped, three-spoke steering wheel that offers key controls at your fingertips.

INTERIOR SHOWN: XJ PORTFOLIO LONG WHEELBASE WITH OPTIONAL PREMIUM REAR SEAT PACK SHOWING IVORY SOFT GRAIN PERFORATED LEATHER SEATS WITH JET CONTRAST STITCH, JET UPPER FACIA, JET SUEDECLOTH HEADLINING AND GLOSS RICH OAK VENEER







INTERIOR COMFORT



FRONT PASSENGER SEAT AWAY

HEATING AND COOLING FUNCTIONS

FIVE MASSAGE PROGRAMMES

XJ's multi-functional seating gives you complete control of your comfort. Both front seats feature fine-tuned electric adjustment and can be specified with five different massage programmes. Both front and rear seats are heated. All seats feature a cooling function as well (excluding XJ Luxury model). Some XJ models also offer three position user memory on the driver and front passenger seats. Long Wheelbase models can be further enhanced with a choice of Rear Seat Option Packs, featuring two individual airline-style reclining seats complete with three massage programmes and memory. The reclining rear seats can be programmed to return to an upright position when the door is opened and a 'front passenger seat away' function allows rear occupants to move the empty front passenger seat forward to increase legroom and aid access.

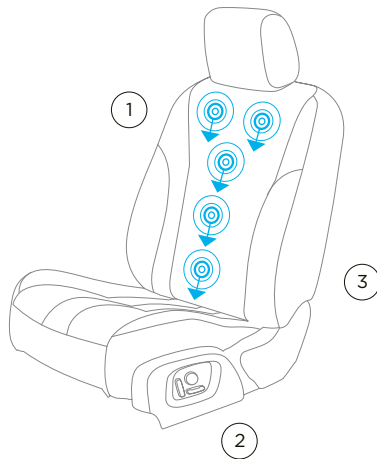

FRONT SEATS

Available with five different massage programmes, electric adjustment with three position memory and heated/cooling function.

1. Five massage programmes
2. Three position memory function
3. Cooling function

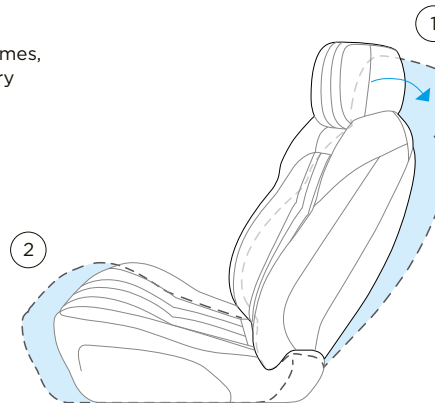

REAR SEATS

Available on Long Wheelbase models with airline-style recline, three different massage programmes, electric adjustment with two position memory.

1. Total recline movement is 11 degrees
2. 103mm of longitudinal cushion movement and separate 14.5 degrees of upper articulation movement

INTERIOR SHOWN: XJ PORTFOLIO LONG WHEELBASE WITH OPTIONAL PREMIUM REAR SEAT PACK SHOWING IVORY SOFT GRAIN PERFORATED LEATHER SEATS WITH JET CONTRAST STITCH, JET UPPER FACIA, JET SUEDECLOTH HEADLINING AND GLOSS RICH OAK VENEER

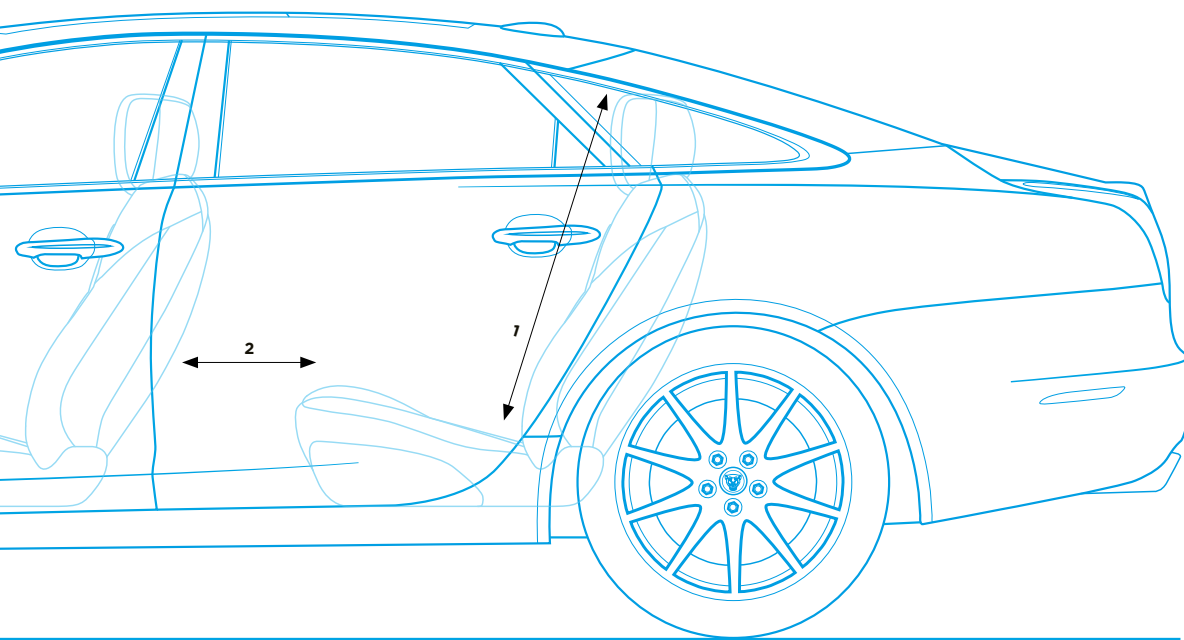

1. LWB headroom 960mm 2. LWB knee room 189mm

INTERIOR SPACE



OVER A METRE
OF LEGROOM

LIMOUSINE
RIDE

Long Wheelbase (LWB) models feature over a metre of legroom for rear seat passengers providing the perfect environment to work, enjoy a host of entertainment options, or simply stretch out and relax. Long Wheelbase models also feature a unique 'limousine' ride with revised air suspension settings for even more refined comfort.

Depending on the model, or options chosen, the rear cabin can be further enhanced with individual 10.2 inch HD screens. The centre armrest houses the multimedia remote and front and rear seat controls, as well as providing useful storage. Folding business tables, LED reading lights, drop-in footrests and electric side rear window blinds are also available to add comfort, convenience and privacy.

INTERIOR SHOWN: XJ PORTFOLIO LONG WHEELBASE WITH OPTIONAL PREMIUM REAR SEAT PACK SHOWING IVORY SOFT GRAIN PERFORATED LEATHER SEATS WITH JET CONTRAST STITCH, JET UPPER FACIA, JET SUEDECLOTH HEADLINING AND GLOSS RICH OAK VENEER



PERFORMANCE ENGINES



STOP/START[†] TECHNOLOGY

EFFICIENT DIESEL ENGINE

XJ offers a choice of a V6 Turbocharged diesel engine or three petrol engines. Petrol engines range from the 2.0 litre 4 cylinder 240PS Turbocharged to the 3.0 litre V6 Supercharged and XJR's powerful 5.0 litre V8 550PS Supercharged. All engines feature Intelligent Stop/Start[†] to further improve XJ's fuel efficiency and reduce CO₂ emissions. For information on fuel consumption, CO₂ emissions and performance figures for XJ engines, please refer to pages 86 to 87.



DIESEL ENGINE FROM

149g/km CO₂

Featuring all the fuel efficiency associated with diesel, the new updated Jaguar 3.0 litre 300PS diesel engine offers improved performance, capable of 0-100km/h in 6.2 seconds with 700Nm of torque. Fuel Economy (Combined): 5.7-5.9 l/100km* CO₂ Emissions: 149-155g/km**.

Transmission: 8-speed automatic transmission with Stop/Start[†] Technology.

[†]Market dependent

*5.7 refers to 19" wheels and 5.9 refers to 20" wheels **149 refers to 19" wheels and 155 refers to 20" wheels

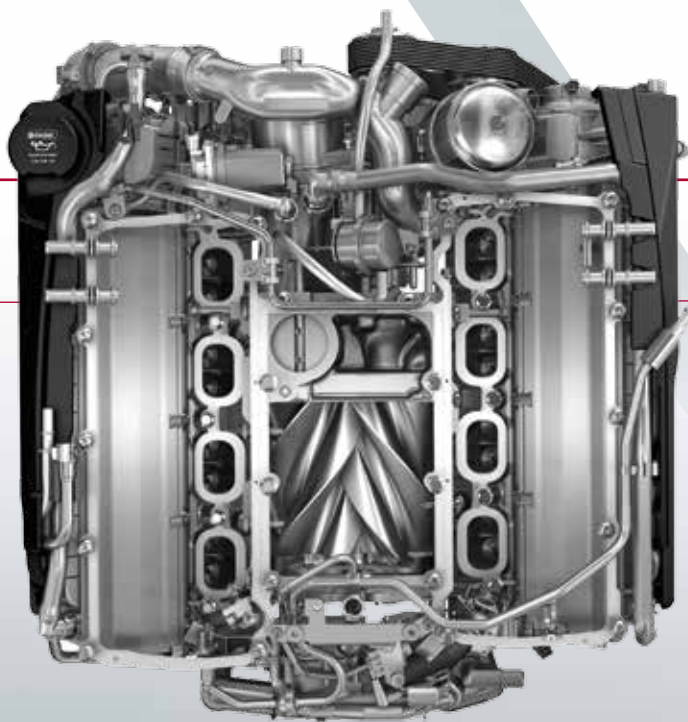

PETROL ENGINES UP TO

0-100km/h in 4.6 sec

A choice of three petrol engines means that you can select the ideal engine to suit your driving style. Our 2.0 litre 4 cylinder 240PS Turbocharged engine offers economy and performance, achieving 0-100km/h in 7.9 seconds due to its 340Nm of torque, yet can consume as little as 8.4 l/100km and produce CO₂ emissions as low as 199g/km. At the other end of the range, XJR's 5.0 litre V8 550PS Supercharged engine is engineered for both smoothness and power achieving 0-100km/h in 4.6 seconds with a top speed of 280km/h.

ALL-ALUMINIUM BODY



AGILITY ENHANCED

ECONOMY IMPROVED

100% ALUMINIUM

XJ's all-aluminium body, the core of its dynamic performance, creates a stiffer, stronger and, most importantly, lighter architecture. Developed using aerospace bonding and riveting techniques, XJ's 100 percent aluminium monocoque body structure does not have a single welded joint. With up to 50 percent of XJ's aluminium coming from recycled sources, XJ leads the way in sustainability.

One of the lightest cars in its class, XJ's excellent power-to-weight ratio improves all aspects of performance with no compromise to its strength. Acceleration is improved, and because the engine has to work less hard, it lowers fuel consumption and emissions. Its aluminium construction also enhances ride comfort, handling, agility and feel, connecting the driver seamlessly to the car and the road.

The inherent strength of aluminium and the monocoque construction offer safety benefits too. The lower weight improves braking performance and reduces the kinetic energy involved in any impact. Aluminium absorbs significantly more energy than steel when it is deformed and, because there are fewer joints, XJ's strength is increased further still.

VEHICLE SHOWN: XJ AUTOBIOGRAPHY LONG WHEELBASE IN DARK SAPPHIRE WITH OPTIONAL 20" ORONA ALLOY WHEELS





ADVANCED DRIVING DYNAMICS



AIR SUSPENSION SYSTEM

ADAPTIVE DYNAMICS

XJ delivers the comfort and refinement of a luxury car with the responsiveness and driver involvement of a sports car. Whether you're cornering, navigating uneven surfaces or accelerating, XJ's Adaptive Dynamics system continually monitors the car up to 500 times a second. Working in conjunction with the air suspension it constantly varies the damping to suit the conditions. These intelligent adjustments keep XJ flat and stable, improving control without loss of ride comfort. In unexpected road and weather conditions, Dynamic Stability Control (DSC) reacts as soon as the system detects the wheels slipping. Trac DSC provides a sportier drive and assists when using snow chains by allowing some slippage or overspin before the system engages. XJ also features selectable driving modes for specific performance requirements. In addition to 'Drive' and 'Sport', Dynamic Mode gives more responsive acceleration; Winter Mode delivers more progressive control in slippery conditions.

VEHICLE SHOWN: XJ PORTFOLIO LONG WHEELBASE IN QUARTZITE













XJR - PERFORMANCE AND LUXURY



5.0 LITRE SUPERCHARGED V8

ELECTRONIC ACTIVE DIFFERENTIAL

XJR combines supercar performance with luxury and exemplifies the pinnacle of Jaguar's engineering, design and craftsmanship: from its muscular lines to the 5.0 litre Supercharged V8 engine, which is tuned and calibrated to produce a top speed of 280km/h. This is a luxury saloon car that can accelerate from 0-100km/h in 4.6 seconds. XJR's 550PS power and outstanding 680Nm of torque deliver a thrilling driving experience.

XJR's performance driving dynamics are assisted by the Electronic Active Differential allowing for very fine control of the power delivery to limit wheelspin, maximise traction and offer greater levels of control. Working in conjunction with the stability, traction and ABS systems, the Electronic Active Differential uses an electric motor, acting on a multi-plate clutch to manage the delivery of torque to each of the rear wheels. Full electronic control of the rear differential lock enables the system to apply full locking torque almost instantaneously.

XJR's aerodynamics are sharpened with a revised front bumper, splitter and lower air intakes with chrome surrounds, side sills and a rear spoiler. Its unique exterior styling includes a gloss black grille, twin bonnet louvres, red brake calipers, signature 'R' badging and 20 inch Farallon alloy wheels. The optional Black Pack can add even more visual drama and features gloss black grille and lower air intake surrounds, side power vents and window finishers.

VEHICLE SHOWN LEFT AND PREVIOUS PAGE: XJR STANDARD WHEELBASE IN GLACIER WHITE WITH OPTIONAL BLACK PACK AND PARKING ASSIST PACK



XJR - SPORTING STYLE

> FIVE COLOURWAYS | UNIQUE 'R' INTERIOR

Inside, XJR blends sporting character with luxury. The soft grain leather upholstery is offered in five bold colourways, including the unique Jet/Red duotone, and is complemented with either Piano Black or Carbon Fibre veneers. Sports seats feature adjustable side bolsters that provide the driver and passenger with lateral support during hard cornering.

The 'R' logo appears on the steering wheel, dashboard Intaglio and is embossed on the front and rear seats. XJR offers a combination of sporting style, contemporary luxury and true performance.

VEHICLE SHOWN: XJR INTERIOR WITH JET/RED DUOTONE SOFT GRAIN LEATHER SPORTS SEATS WITH RED CONTRAST STITCH, JET UPPER FACIA, JET SUEDECLOTH HEADLINING, PIANO BLACK VENEER AND JET PREMIUM CARPET MATS WITH RED CONTRAST BINDING



DRIVING TECHNOLOGY

ALL SURFACE PROGRESS CONTROL



ADDED DRIVER CONFIDENCE

LOW SPEED CRUISE CONTROL

Now standard on every XJ, Jaguar's All Surface Progress Control (ASPC) technology is a low speed cruise control that helps the car to cope with low traction situations. ASPC allows the driver to concentrate on steering the vehicle. Once activated, you use the cruise control buttons to set a 'target' speed of between 3.6km/h and 30km/h. The system then works to achieve and maintain that speed while exerting optimum traction control. ASPC gives XJ drivers added confidence over slippery, loose or icy surfaces, undulating terrain and even while descending a difficult incline. It helps make XJ easy to drive in challenging conditions.

With any given set of tyres, ASPC can accomplish comparable levels of traction to that achievable by an expert driver. Fitting All Season or Winter tyres to XJ can improve capability on slippery surfaces.



GRAVEL



WET GRASS



SNOW/ICE



WET ROAD

ADVANCED DRIVETRAIN TECHNOLOGY



ALL WHEEL DRIVE

OVER 90% TORQUE SPLIT

INTELLIGENT AND ADAPTIVE

The optional Jaguar All Wheel Drive (AWD) system is continuously variable and intelligent. The rear wheel bias ensures a consistently true Jaguar driving experience. In normal conditions the system is 100 percent rear wheel drive but reacts intelligently to road conditions to deliver traction on demand. The AWD system reacts in the blink of an eye, so should the rear wheels start to slip, it instantly redistributes torque to compensate. Over 90 percent of engine torque can be distributed from the rear wheels to the front wheels to provide optimum traction. As well as offering a smoother, safer drive with the familiar Jaguar agility and handling, it also consumes less fuel and has lower emissions than a permanent AWD system.

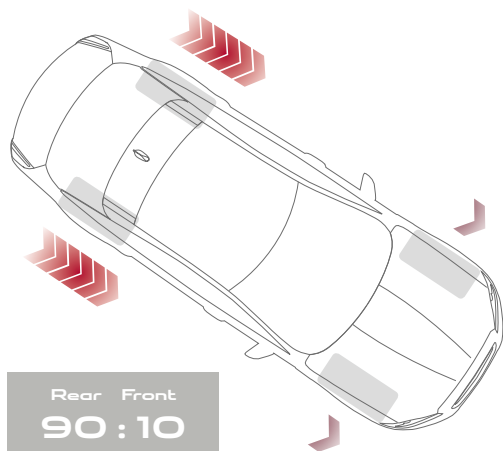

DRY ROAD CONDITIONS

In normal driving conditions, virtually all torque is distributed to the rear wheels providing signature Jaguar rear wheel drive performance.

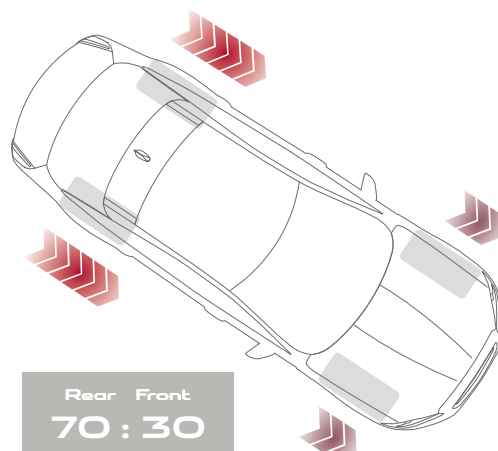

AWD WINTER MODE

At the touch of a button AWD Winter Mode can be selected to distribute 30 percent of the torque to the front wheels and 70 percent of the torque to the rear wheels maximising control in difficult conditions.

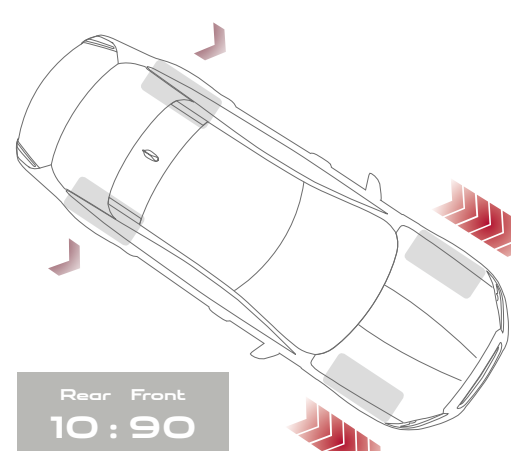

VARIABLE ROAD CONDITIONS

Where road conditions are changeable, over 90 percent of torque can be distributed to the front wheels as required to ensure optimum traction.

VEHICLE SHOWN: XJ AUTOBIOGRAPHY LONG WHEELBASE IN DARK SAPPHIRE



INFOTAINMENT INCONTROL TECHNOLOGIES



INCONTROL TOUCH PRO

INCONTROL CONNECT PRO

InControl is our suite of advanced technologies that links both you and your XJ to the wider world. XJ features the InControl Touch Pro infotainment system. This can be further enhanced by adding its connectivity package: InControl Connect Pro.

INCONTROL TOUCH PRO



STANDARD

8 inch Touch-screen with multi-touch gestures and customisable home screen

12.3 inch Instrument Panel Display with virtual dials and full screen 3D Map View

Solid State Drive Enhanced Navigation

FM Radio, iPod, Bluetooth® and 2 X USB connections

10GB of usable memory

CD/DVD Drive

OPTIONAL FEATURES



InControl Protect consists of SOS Emergency Call, Jaguar Optimised Assistance and Remote Essentials smartphone app



InControl Connect Pro consists of InControl Apps, Remote Premium smartphone app, Wi-Fi Hotspot and Pro Services



InControl Secure provides Stolen Vehicle Monitoring and notifications via your smartphone and the secure call centre



For information on InControl Connect Pro see page 43.

VEHICLE SHOWN: XJ PORTFOLIO LONG WHEELBASE IN QUARTZITE

As we systematically introduce InControl, specific features, options and its availability remain market dependent. Please consult your local Jaguar retailer for further details. Certain features require the fitment of a Micro SIM with a suitable data contract.





SWIPE



PINCH



ZOOM



VOICE
ACTIVATION

INCONTROL TOUCH PRO

NEXT GENERATION INFOTAINMENT

InControl Touch Pro's next-generation hardware and software advances XJ's connectivity and entertainment to the very highest level. The key aspects of InControl Touch Pro are:

Large, highly-responsive, 8 inch Touch-screen at the heart of the centre console with customisable home screen and lightning fast response times.

Pinpoint touch control allows you to manipulate and interact with information swiftly and seamlessly. The Touch-screen responds in the same manner as a smartphone or tablet computer, providing multi-touch gestures such as pinch, zoom and swipe.

12.3 inch Instrument Panel Display with virtual dials and full screen 3D Map View makes driving even more of a pleasure. Select full screen 3D map view or choose one of four graphical themes to suit your personal preference.

Solid State Drive Enhanced Navigation with response times that are a fraction of conventional systems. Set a destination and the system alerts you if you have insufficient fuel for the journey. It then displays filling stations on the part of the route where you may be low on fuel. The system automatically displays parking options.

Personal media storage of 10GB for your music and movies. 'Plug and play' using the two USB ports allowing for fast transfer speeds.

Dual View* allows the front passenger and driver to enjoy different media on the same 8 inch screen. For example, the front passenger can watch a film (listening to the audio with wireless surround sound headphones) while the driver views navigation guidance.

 Explore InControl at jaguar.com/incontrol

*Feature not available before December 2015.
As we systematically introduce InControl, specific features, options and its availability remain market dependent.
Please consult your local Jaguar retailer for further details. Certain features require the fitment of a Micro SIM with a suitable data contract.

INCONTROL CONNECT PRO

OPTIONAL ENHANCED CONNECTIVITY PACKAGE

InControl Connect Pro's services, technologies and applications give you the very best in connectivity and convenience. It offers many features including:

InControl Apps features a range of Jaguar approved apps that can be connected to XJ from your smartphone. It ensures safe and convenient use of apps optimised to enhance aspects of your in-car experience.

Remote Premium is an app that allows you to monitor as well as interact with your XJ from your smartphone. Remote start XJ to pre-condition the climate, lock and unlock the car, locate your XJ on a map or using the beep and flash function, and track your journeys.

Wi-Fi Hotspot gives you the option to create a strong 3G hotspot using the car's antenna when you fit a SIM card. Connect up to eight devices to read emails, browse the web and download content.

Route Planner Companion App allows you to pre-plan your route via your Apple or Android smartphone. It guides you to your car, where you will find your selected route available on XJ's Touch-screen. When you've completed your road journey, the app guides you to your destination.

Pro Services is a comprehensive suite of connected services that includes:

Share your estimated time of arrival so your selected contact(s) will know when you will arrive, as calculated by the navigation guidance system. The system can then send automatic updates via text or email, without any further action from you.

Commute Mode allows the system to learn your commutes and automatically advises you of the expected journey time and quickest routes based on live and historical traffic movements.

Arrival Mode displays interactive 360 degree street level imagery of your destination for a seamless finish to journeys. It automatically displays again upon your arrival.

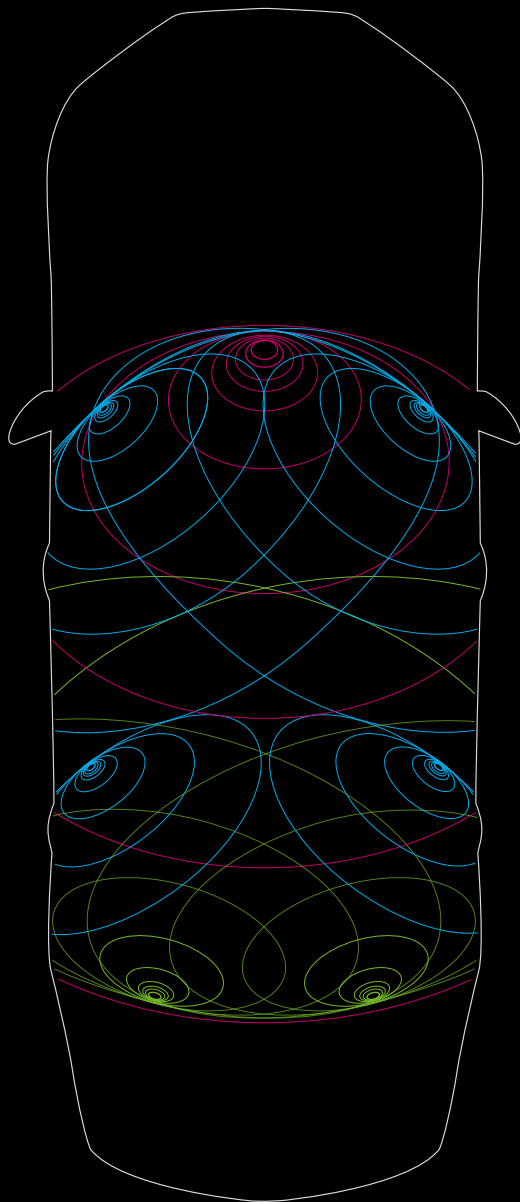

AUDIO



MERIDIAN

TRIFIELD™

CONVERSATION ASSIST

Designed for XJ by Meridian, the British audio experts, three fully Digital systems are available: the Meridian 380W Digital Sound System, the Meridian 825W Digital Surround Sound System and the Meridian Reference 1300W Digital Sound System. All feature advanced technology including Digital Sound Processor (DSP) software to create high fidelity sound throughout the cabin and optimise every element of the system, as well as Meridian Cabin Correction (MCC) to improve the clarity and authentic reproduction of your music.

The Meridian 380W Digital Sound System has 14 speakers, including 2 subwoofers and 2 x 8 inch front door woofers for a seminal audio experience. The Meridian 825W Digital Surround Sound System uses 20 speakers including 2 subwoofers with Audyssey MultEQ sound equalisation technology to produce 7.1 surround sound, with Meridian's exclusive Trifield technology ensuring a perfect stereo image for each occupant wherever they are seated.

The latest addition to the range is the Meridian Reference 1300W Digital Sound System using 26 speakers. This ultra-premium sound system employs Psychoacoustics to produce sounds that are so true to life they are perceived by the brain as the real thing.

Now you can hold a meeting or have an informal chat without ever having to raise your voice. Conversation Assist, included as standard with the Meridian Reference 1300W Digital Sound System, allows the driver or front seat passenger to talk with ease to passengers in the rear of the car, and vice versa. Microphones above each seat reinforce the occupants' voices via the audio system's speakers, making it much easier for everyone to be heard.

-  Holographic Centre Image
-  Door Waves: Tweeter, Midrange & Bass
-  Surround Sound Waves

Diagram representative of Meridian 825W Digital Surround Sound System.



MERIDIAN



250 
WATTS

12 
SPEAKERS

8 
AMPLIFIER
CHANNELS

JAGUAR SOUND SYSTEM
250W*, 12 speakers,
8 channel amplifier,
Audyssey MultEQ Audio Equalisation



380 
WATTS

14 
SPEAKERS

12 
AMPLIFIER
CHANNELS

**MERIDIAN DIGITAL
SOUND SYSTEM**
380W*, 14 speakers,
12 channel class D DSP amplifier,
Audyssey MultEQ Audio Equalisation,
Dynamic volume control



825 
WATTS

20 
SPEAKERS

15 
AMPLIFIER
CHANNELS

**MERIDIAN DIGITAL
SURROUND SOUND SYSTEM**
825W*, 20 speakers,
15 channel class D DSP amplifier,
Audyssey MultEQ Audio Equalisation,
7.1 Surround Sound,
Trifield technology



1300 
WATTS

26 
SPEAKERS

17 
AMPLIFIER
CHANNELS

**MERIDIAN REFERENCE DIGITAL
SURROUND SOUND SYSTEM**
1300W*, 26 speakers,
17 channel class D DSP amplifier,
Audyssey MultEQ Audio Equalisation,
7.1 Surround Sound,
Trifield technology,
Conversation Assist

*Trifield' and the 'three fields' device are trademarks of Trifield Productions Ltd.
*0.2% THD (Total Harmonic Distortion)

SAFETY AND EFFICIENCY ADVANCED DRIVER ASSISTANCE

XJ is equipped with an array of standard and optional driver assistance systems dependent on model chosen. All are designed to make driving easier and safer.



- ① **360° PARK DISTANCE CONTROL**
360° Park Distance Control uses ultrasonic sensors to the front, rear and sides of the vehicle to alert you to the proximity of objects when parking or exiting from a bay.



- ② **ADAPTIVE FRONT LIGHTING**
Adaptive Front Lighting adapts to steering inputs to cast a deeper beam into corners, while its Intelligent High Beam senses oncoming vehicles and automatically selects high or dipped beam as appropriate.



- ③ **ADVANCED SAFETY SYSTEMS**
Advanced safety systems actively protect everyone on board XJ with advanced airbag technology. The Pedestrian Contact Sensing System can reduce injuries to pedestrians in case of a collision.



- ④ **TRAFFIC SIGN RECOGNITION***
Traffic Sign Recognition technology can detect current speed limit signs to display them on the Instrument Panel Display. This smart system is also aware of local and conditional speed limits.



- ⑤ **BLIND SPOT MONITOR WITH CLOSING VEHICLE SENSING AND REVERSE TRAFFIC DETECTION***
Blind Spot Monitor warns you of vehicles or obstacles beside XJ, while Closing Vehicle Sensing looks out for following vehicles approaching XJ from a distance. Both provide alerts via an icon displayed in the appropriate exterior mirror. Reverse Traffic Detection alerts you, via an audio alert and the Touch-screen, of moving vehicles during reversing – for example, when leaving a parking bay with restricted vision.



- ⑥ **PARK ASSIST****
Park Assist makes life in the city easier. The system works for both parallel and perpendicular parking and automatically steers XJ into and out of a space while the driver operates the pedals.

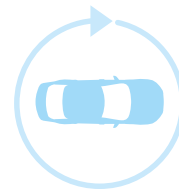

- ⑦ **SURROUND CAMERA SYSTEM**
The Surround Camera system gives you multiple views around the vehicle from four cameras, shown on the central Touch-screen. This helps with various manoeuvres, from parking by a kerb to getting in and out of tight spaces and junctions.

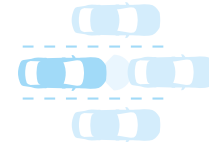

- ⑧ **ADAPTIVE CRUISE CONTROL WITH QUEUE ASSIST**
Adaptive Cruise Control with Queue Assist senses when a vehicle in front slows and reduces XJ's speed accordingly to maintain a safe distance. When the vehicle speeds up again, so does XJ.

*Optional features, availability is market dependent.
**Available on Rear Wheel Drive (RWD) models only.

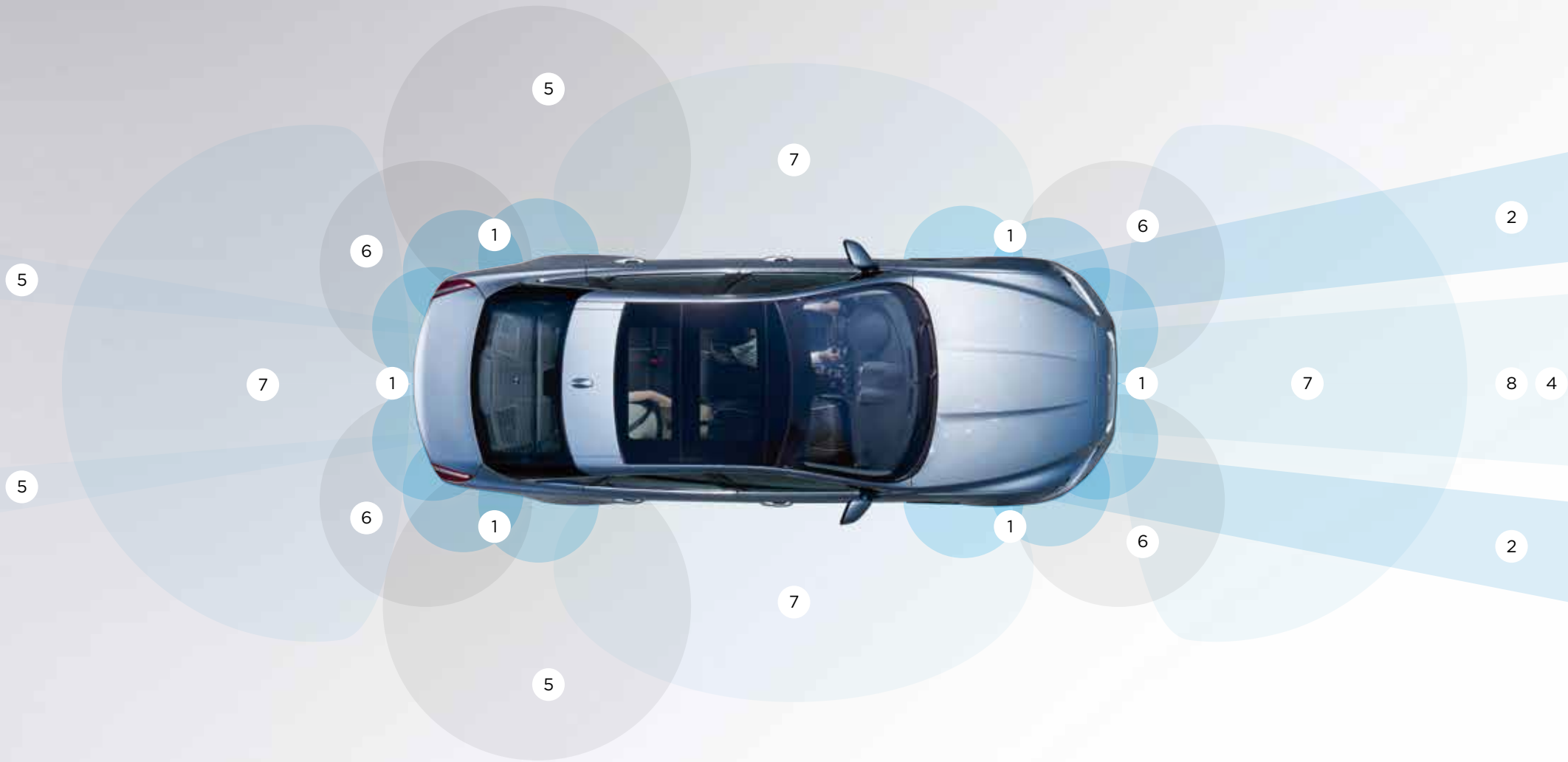

VEHICLE SHOWN: XJ PORTFOLIO LONG WHEELBASE IN AMMONITE GREY

EFFICIENT TECHNOLOGIES

 **STOP/START* TECHNOLOGY** | **CLEAN TECHNOLOGIES**

We are determined to do more with less. That is why XJ uses a range of technologies to reduce fuel consumption and CO₂ emissions, all while staying true to Jaguar's dynamic nature.



STOP/START* TECHNOLOGY

All XJ engines utilise Stop/Start* technology. It shuts down the engine when you come to a complete halt and restarts the engine immediately when required, helping to save fuel, especially during urban driving.

*Market dependent.



ELECTRIC POWER ASSISTED STEERING (EPAS)

XJ's next generation Electric Power Assisted Steering (EPAS) offers outstanding feedback, control and immediate power assistance. Electrically driven, it's only active on demand which saves fuel. Only available on rear wheel drive vehicles.



AERODYNAMICS

XJ's highly efficient shape is the result of hundreds of thousands of hours of Computational Fluid Dynamics testing. Jaguar created one of the world's most advanced automotive virtual testing labs, honing XJ's shape through virtual wind tunnels to slice through wind resistance.

AdBlue®

ADBLUE*

XJ's diesel engine is fitted with AdBlue to help clean exhaust gases. AdBlue is a non-toxic, non-flammable, biodegradable additive that processes the gases in the car's exhaust system to remove harmful nitrogen oxide emissions.



ALUMINIUM ARCHITECTURE

XJ's All-Aluminium architecture makes it one of the lightest vehicles in its class, meaning less fuel is needed to move it and consequently creating lower emissions. With 50 percent of the aluminium used coming from recycled sources, XJ's green credentials are assured.

PERSONALISATION XJ - YOUR CHOICE

 Configure your vehicle at jaguar.com



CHOOSE YOUR ENGINE

Page 52

Select one of XJ's powerful, efficient petrol or diesel engines to suit your driving style.

CHOOSE YOUR MODEL & OPTIONS

Page 54

Compare the wealth of standard features and options on XJ models.

CHOOSE YOUR COLOUR

Page 64

Express your individuality with one of XJ's stunning exterior colours.

CHOOSE YOUR WHEELS

Page 66

Add the personal finishing touch to your new XJ, and complement its stunning style, with a set of beautifully designed alloy wheels.

CHOOSE YOUR INTERIOR

Page 68

There's a wide selection of premium materials, leathers, veneers and finishes for every personal taste.

CHOOSE YOUR JAGUAR ACCESSORIES

Page 84

Really make it yours by adding style, practicality and versatility with official XJ accessories from your local Jaguar retailer.

1 CHOOSE YOUR ENGINE

 Configure your vehicle at jaguar.com

PETROL ENGINES

2.0 LITRE

4 CYLINDER

TURBOCHARGED PETROL

MAXIMUM POWER 240PS

MAXIMUM TORQUE 340Nm

ACCELERATION 0-100km/h 7.9 seconds

TOP SPEED 241km/h

COMBINED 8.4 l/100km*

CO₂ EMISSIONS 199g/km

LUXURY, PREMIUM LUXURY



0-100 KM/H



TOP SPEED KM/H

3.0 LITRE V6

TURBOCHARGED PETROL RWD

MAXIMUM POWER 340PS

MAXIMUM TORQUE 450Nm

ACCELERATION 0-100km/h 5.9 seconds

TOP SPEED 250km/h

COMBINED 9.1 l/100km*

CO₂ EMISSIONS 211g/km

LUXURY, PREMIUM LUXURY,
PORTFOLIO, AUTOBIOGRAPHY, R-SPORT



0-100 KM/H



TOP SPEED KM/H

3.0 LITRE V6

TURBOCHARGED PETROL AWD

MAXIMUM POWER 340PS

MAXIMUM TORQUE 450Nm

ACCELERATION 0-100km/h 6.4 seconds

TOP SPEED 250km/h

COMBINED 9.8 l/100km*

CO₂ EMISSIONS 234g/km

LUXURY, PREMIUM LUXURY,
PORTFOLIO, AUTOBIOGRAPHY, R-SPORT



0-100 KM/H



TOP SPEED KM/H

*Official EU test figures. For comparison purposes only. Real world figures may differ. Refer to Technical Specification pages for full fuel consumption figures.

> DIESEL ENGINE

5.0 LITRE V8

SUPERCHARGED PETROL

MAXIMUM POWER 550PS

MAXIMUM TORQUE 680Nm

ACCELERATION 0-100km/h 4.6 seconds

TOP SPEED 280km/h

COMBINED 11.1 l/100km*

CO₂ EMISSIONS 264g/km

XJR



0-100 KM/H

TOP SPEED KM/H

3.0 LITRE V6

TURBOCHARGED DIESEL

MAXIMUM POWER 300PS

MAXIMUM TORQUE 700Nm

ACCELERATION 0-100km/h 6.2 seconds

TOP SPEED 250km/h

COMBINED 5.7 l/100km*

CO₂ EMISSIONS 149g/km

LUXURY, PREMIUM LUXURY,
PORTFOLIO, AUTOBIOGRAPHY, R-SPORT



0-100 KM/H

TOP SPEED KM/H

2 CHOOSE YOUR MODEL

 Configure your vehicle at jaguar.com

> LUXURY



LUXURY

KEY FEATURES

- 14 Way Seats with Lumbar Adjustment
- Heated Front and Rear Seats
- Carpet Mat Set
- Satellite Navigation System
- Jaguar Sound System (250W)
- Dual-Zone Climate Control
- Bluetooth® Audio and Video Streaming
- Front and Rear Parking Aid
- All Surface Progress Control
- Full LED Headlights
- Twin Oval Exhausts
- Chrome Grille with Chrome Surround
- Chrome Side Power Vent



PREMIUM LUXURY

KEY FEATURES

(IN ADDITION TO 'LUXURY')

- Heated and Cooled Front and Rear Seats
- Soft Door Close and Keyless Entry
- Power Fold Exterior Mirror



PORTFOLIO

KEY FEATURES

(IN ADDITION TO 'PREMIUM LUXURY')

- 18 Way Seats with Lumbar Adjustment
- Front Seat with Five Massage Programmes
- Extended range of interior trim themes
- Heated Steering Wheel
- Premium Carpet Mat Set
- Meridian Digital Sound System (380W)
- Four-Zone Climate Control



AUTOBIOGRAPHY

KEY FEATURES

(IN ADDITION TO 'PORTFOLIO')

- LED Rear Reading Lights
- Illuminated Tread Plates
- Metallic Foot Pedals
- Full LED Headlights with Adaptive Lighting and Automatic High Beam Assist
- Traffic Sign Recognition
- Surround Camera System
- Closing Vehicle Sensing with Blind Spot Monitoring and Reverse Traffic Detection
- 360° Park Distance Control
- Park Assist - Parallel, Bay and Exit

Images feature optional equipment.
Please note that standard features may be replaced when selecting alternative trim levels.
Standard features may also vary depending on country of purchase, engine variant and transmission.
Standard features: Please refer to Specification and Price Guide or website for your local market.

> SPORT



R-SPORT

**KEY FEATURES
(IN ADDITION TO 'PREMIUM LUXURY')**

Heated Steering Wheel
R-Sport Front and Rear Tread Plates
Metallic Foot Pedals
Premium Carpet Mat Set
Meridian Digital Sound System (380W)
Four-Zone Climate Control
Gloss Black Front Grille and Rear Valance
Rear Spoiler, Side Sills and Front Splitter



XJR

**KEY FEATURES
(IN ADDITION TO 'R-SPORT')**

'R' Front and Rear Tread Plates
Meridian Digital Surround Sound System (825W)
Full LED Headlights with Adaptive Lighting and Automatic High Beam Assist
XJR Quad Pipe Exhaust Finishers
Red Painted Brake Calipers with Jaguar Script
XJR Bonnet Louvres
Body Coloured Rear Valance
XJR Sports Exhaust System
XJR Suspension
Active Differential

2 CHOOSE YOUR OPTIONS

 Configure your vehicle at jaguar.com

KEY STANDARD FEATURES

	LUXURY	PREMIUM LUXURY	PORTFOLIO	AUTOBIOGRAPHY	R-SPORT	XJR	DESCRIPTION
Stop/Start*	●	●	●	●	●	●	Refer to page 48
Electric Parking Brake with Drive Away Release	●	●	●	●	●	●	
JaguarDrive Control with Dynamic, Normal and Winter modes	●	●	●	●	●	●	Refer to page 38
All Surface Progress Control (ASPC)	●	●	●	●	●	●	Refer to page 36
Variable Ratio Power Assisted Steering	●	●	●	●	●	●	Electric on Rear Wheel Drive cars. Hydraulic on All Wheel Drive cars
Adaptive Dynamics	●	●	●	●	●	●	Refer to page 28
Automatic Speed Limiter (ASL)	●	●	●	●	●	●	
Emergency Brake Assist	●	●	●	●	●	●	
Automatic Headlights	●	●	●	●	●	●	
LED Rear Lights	●	●	●	●	●	●	Refer to page 13
Heated Rear Windscreen	●	●	●	●	●	●	
Rain Sensing Windscreen Wipers	●	●	●	●	●	●	
Electric Front and Rear Windows with One-Touch Open/Close	●	●	●	●	●	●	
Solar Attenuating Panoramic Glass Roof with One-Touch Open/Close Front Section and Fixed Rear Section	●	●	●	●	●	●	
Jaguar Smart Key System – Keyless Start	●	●	●	●	●	●	
Power Open/Close Trunk with Adjustable Opening	●	●	●	●	●	●	
Airbags Front and Side with Side Curtain Airbags	●	●	●	●	●	●	
Whiplash Protection System (Front Seats)	●	●	●	●	●	●	
Pedestrian Contact Sensing	●	●	●	●	●	●	Refer to page 46
Tyre Pressure Monitoring System (TPMS)	●	●	●	●	●	●	
Seat Belt Reminder (Front and Rear Seats)	●	●	●	●	●	●	
Front and Rear Parking Aid (includes Touch-screen Visual Indicator)	●	●	●	●	●	●	
Rear Camera Parking Aid	●	●	●	●	●	●	
Reverse Dip Mirror Function	●	●	●	●	●	●	
Security System – Alarm and Engine Immobiliser	●	●	●	●	●	●	
Electric Steering Column Adjustment with Entry and Exit Tilt-Away	●	●	●	●	●	●	
Auto-Dimming Interior Rear View Mirror	●	●	●	●	●	●	
Front and Rear Courtesy Footwell Lights	●	●	●	●	●	●	
Phosphor Blue Halo Illumination and Interior Mood Lighting	●	●	●	●	●	●	
12.3 inch Instrument Panel Display	●	●	●	●	●	●	Refer to page 43
Rear Auxiliary Power Points (x2)	●	●	●	●	●	●	

*Market dependent

● Standard ○ Option — Not available

Please consult your local Jaguar retailer for details.

For a complete list of optional features and packs refer to the XJ Specification and Price Guide or configure your vehicle at jaguar.com

KEY OPTIONAL FEATURES

		LUXURY	PREMIUM LUXURY	PORTFOLIO	AUTOBIOGRAPHY	R-SPORT	XJR	
POWERTRAIN AND DRIVING DYNAMICS								DESCRIPTION
Cruise control	H41C	●	●	●	●	●	●	
Adaptive Cruise Control	H41F	○	○	○	○	○	○	Refer to page 46
Active Differential Control	—	—	—	—	—	—	●	
Red Brake Calipers	C10R	—	—	—	—	—	●	
Raised Electronic Speed Limiter (280km/h)	S51B	—	—	—	—	—	●	
Carbon Fibre Engine Cover	S58B	—	—	—	—	—	○	

EXTERIOR FEATURES

Twin Oval Chrome Exhaust Finishers	—	●	●	●	—	●	—	
Autobiography Twin Oval Chrome Exhaust Finishers	—	—	—	—	●	—	—	
XJR Quad Pipe Exhaust Finishers	—	—	—	—	—	—	●	
Standard Exhaust System	—	●	●	●	●	●	—	
XJR Sports Exhaust System	—	—	—	—	—	—	●	
Heated Electric Door Mirrors with Puddle Lamps and Memory Function	B28N	●	—	—	—	—	—	
Heated Power Fold Electric Door Mirrors with Auto-Dimming, Puddle Lamps and Memory Function	B28M	○	●	●	●	●	●	
R-Sport Body Kit; 3 Piece Front Splitter, Black Grille Mesh, R-Sport Side Power Vents, R Style Side Sills, Rear Spoiler, Gloss Black Rear Valence	—	—	—	—	—	●	—	
XJR Body Kit; 3 Piece Front Splitter, Chrome Air Intake Surrounds, Black Grille Mesh, Bonnet Louvres, Black Side Power Vent Mesh, R Style Side Sills, Rear Spoiler, Body Coloured Rear Valence with Black Insert	—	—	—	—	—	—	●	
Non Heated Front Windscreen	D96Z	●	●	●	●	●	●	
Heated Front Windscreen	D96A	○	○	○	○	○	○	
LED Headlights	D90R	●	●	●	—	●	—	Refer to page 13
Adaptive LED Headlights (requires Auto High Beam Assist)	D90T	○	○	○	●	○	●	
Auto High Beam Assist (requires Adaptive LED Headlights)	D91A	○	○	○	●	○	●	
PAINT								(Please see pages 64-65 for full colour palette)
Solid Paint	—	●	●	●	●	●	●	
Metallic Paint	—	○	○	○	○	○	○	
Premium Metallic Paint	—	○	○	○	○	○	○	

2 CHOOSE YOUR OPTIONS

 Configure your vehicle at jaguar.com

EXTERIOR FEATURES CONTINUED

WHEELS	CODE	LUXURY	PREMIUM LUXURY	PORTFOLIO	AUTOBIOGRAPHY	R-SPORT	XJR	
18" Meru	C45B	●	—	—	—	—	—	(Availability of wheels is subject to choice of engine, please see pages 66-67 to see the full range)
18" Manra	C51S	○	—	—	—	—	—	Not available with Diesel engines or All Wheel Drive
19" Aleutian	C45C	○	○	○	○	—	—	Standard on Luxury and Premium Luxury specifications with Diesel engines
19" Toba	C45D	○	●	●	○	—	—	Optional on Premium Luxury specifications with Diesel engines
19" Toba Polished	C45E	○	○	○	○	—	—	
20" Kasuga	C45G	○	○	○	○	—	—	
20" Kasuga Polished	C45H	○	○	○	○	—	—	
20" Orona	C45J	○	○	○	○	—	—	
20" Orona Polished	C45K	○	○	○	○	—	—	
20" Mataiva	C45L	—	—	—	●	—	—	
20" Venom - Sparkle Silver	C46A	—	—	—	—	●	—	
20" Venom - Gloss Black	C52J	—	—	—	—	○	—	
20" Farallon - Technical Grey	C51Y	—	—	—	—	—	●	
20" Farallon - Sparkle Silver	C51Z	—	—	—	—	—	○	
20" Farallon - Gloss Black	C52H	—	—	—	—	—	○	
20" Maroa	C46B	—	—	—	○	—	—	
Jaguar Tyre Repair System	C40J	●	●	●	—	—	—	
18" Alloy Space Saver Spare Wheel	C40D	○	○	○	●	●	—	
19" Alloy Space Saver Spare Wheel	C40K	—	—	—	—	—	●	

INTERIOR FEATURES

								DESCRIPTION
Dual-Zone Climate Control	C88A	●	●	—	—	—	—	
Four-Zone Climate Control	C88G	○	○	●	●	●	●	Fitted as standard to all Long Wheelbase cars
Air Quality Sensing with Auto-Recirculation	C89A	○	○	○	○	○	○	
Garage Door Opener	B20B	○	○	○	—	○	○	Not available with Traffic Sign Recognition
Clear Glass	H75B	●	●	●	○	●	●	
Privacy Glass - Rear of B Post	H75A	○	○	○	●	○	○	Fitted as standard to Long Wheelbase Premium Luxury, Portfolio and XJR
Illuminated Front Stowage Tray	A03C	●	●	●	●	●	●	
Front Ashtray and Cigar Lighter	A03B	○	○	○	○	○	○	
Electric Rear Window Sunblind	H76G	○	○	○	●	○	○	Fitted as standard to all Long Wheelbase cars
Illuminated Air Vents	B19B	—	○	○	●	—	—	Only available as part of Illumination Pack unless standard

● Standard ○ Option — Not available

Please consult your local Jaguar retailer for details.

For a complete list of optional features and packs refer to the XJ Specification and Price Guide or configure your vehicle at jaguar.com

INTERIOR FEATURES CONTINUED

		LUXURY	PREMIUM LUXURY	PORTFOLIO	AUTOBIOGRAPHY	R-SPORT	XJR	
	CODE							DESCRIPTION
LED Rear Reading Lights	B78A	○	○	○	●	○	○	
Metallic Foot Pedals	G48S	—	—	—	●	●	●	
Stainless Steel Sill Tread Plates	F28E	●	●	●	—	—	—	
Illuminated Stainless Steel Sill Tread Plates	F28F	○	○	○	●	—	—	Only available as part of Illumination Pack unless standard
"R-Sport" Stainless Steel Tread Plates	F28N	—	—	—	—	●	—	
"R" Stainless Steel Tread Plates	F28R	—	—	—	—	—	●	
Carpet Mat Set	H69H	●	●	—	—	—	—	
Premium Carpet Mat Set	H69J	—	—	●	●	●	●	
Soft Door Close including Keyless Entry	F42C/F04B	○	●	●	●	●	●	
SAFETY AND SECURITY								
360° Park Distance Control	C13B	○	○	○	●	○	○	Only available as part of Parking Assist Pack unless standard
Surround Camera System (requires Power Fold Door Mirrors)	C14C	○	○	○	●	○	○	Only available as part of Parking Assist Pack unless standard
Closing Vehicle Sensing with Blind Spot Monitoring and Reverse Traffic Detection (requires Power Fold Door Mirrors)	H71C	○	○	○	●	○	○	Only available as part of Highway Pack unless standard
Traffic Sign Recognition (Must be specified with Auto High Beam Assist)	A41A	○	○	○	●	○	○	Only available as part of Highway Pack unless standard. Not available with Garage Door Opener
Park Assist - Parallel, Bay and Exit	C18B	○	○	○	●	○	○	Only available as part of Parking Assist Pack unless standard. Not available with All Wheel Drive
InControl Protect	D45D	○	○	○	○	○	○	Availability varies by market
InControl Remote Premium for Warranty Period (requires InControl Protect)	D47A	○	○	○	○	○	○	Only available as part of InControl Connect Pro pack. Availability varies by market
InControl Secure for Warranty period (requires InControl Protect)	D44A	○	○	○	○	○	○	Availability varies by market
INTERIOR TRIM								
(Please see pages 68-81 to see the full range)								
Bond Grain Upper Facia	H03A	●	—	—	—	—	—	
Soft Feel Upper Facia	H03L	—	●	—	—	—	—	
Soft Grain Upper Facia	H03E	—	○	●	●	●	●	
Morzine Headlining	H01E	●	●	—	—	—	—	
Premium Suedecloth Headlining	H01D	—	—	●	—	●	●	
Leather Headlining	H01C	—	—	—	●	—	—	
Ivory Headlining	HNAA	●	●	●	●	○	—	
Jet Headlining	HPFD	—	—	○	○	●	●	Only available with certain interior trim colour ways
STEERING WHEEL								
Soft Grain Leather Steering Wheel	F95L	●	●	●	●	—	—	
Soft Grain Leather and Wood Steering Wheel	F95W	—	○	○	○	—	—	Not available with all veneers/colour way combinations
Soft Grain Leather Steering Wheel with "R" Logo	F95R	—	—	—	—	—	●	
Soft Grain Leather Steering Wheel with "R-Sport" Logo	F96G	—	—	—	—	●	—	
Non Heated Steering Wheel	F97Z	●	●	—	—	—	—	
Heated Steering Wheel	F97A	○	○	●	●	●	●	

2 CHOOSE YOUR OPTIONS

 Configure your vehicle at jaguar.com

SEATING AND VENEERS

SEATING	CODE	LUXURY	PREMIUM LUXURY	PORTFOLIO	AUTOBIOGRAPHY	R-SPORT	XJR	DESCRIPTION
Bond Grain Leather Seats	B40K	●	—	—	—	—	—	
Soft Grain Leather Perforated Seats	B40U	—	●	—	—	●	●	
Quilted Soft Grain Leather Perforated Seats	B41L	—	—	●	—	—	—	
Quilted Semi-Aniline Leather Perforated Seats	B40V	—	—	—	●	—	—	
Heated Front and Rear Seats	F53B	●	—	—	—	—	—	
Heated and Cooled Front and Rear Seats	F53D	—	●	●	●	●	●	
14 Way Front Seats	Z03K/Z03L	●	●	—	—	—	—	Seat movement includes; Electric - Fore/Aft x 2, Cushion Height x 2, Squab Recline x 2, Cushion Tilt x 2, Lumbar Support x 4, Manual - Headrest x 2
18 Way Front Seats with Massage Function	Z03M	—	○	●	●	—	—	Seat movement includes; Electric - Fore/Aft x 2, Cushion Height x 2, Squab Recline x 2, Cushion Tilt x 2, Headrest x 2, Cushion Extension x 2, Side Bolsters x 2, Lumbar Support x 4
18 Way Front Sports Seats	Z03N	—	—	—	—	●	●	Seat movement includes; Electric - Fore/Aft x 2, Cushion Height x 2, Squab Recline x 2, Cushion Tilt x 2, Headrest x 2, Cushion Extension x 2, Side Bolsters x 2, Lumbar Support x 4
Fixed Rear Bench Seat	B59V	●	●	●	●	—	—	
Sports Style Fixed Rear Bench Seat	B59P	—	—	—	—	●	●	
VENEERS								(Please see pages 82-83 to see the full range)
Satin Rosewood	VRGR	●	○	○	○	—	—	
Gloss Rich Oak	VSAL	○	●	○	○	—	—	
Gloss Figured Ebony	VSAN	○	○	●	○	—	—	
Gloss Rich Oak with Linear Laser Inlay	VSEP	○	○	○	●	—	—	
Gloss Burr Walnut	VSAB	○	○	○	○	—	—	
Satin Elm	VAPK	○	○	○	○	—	—	
Gloss Walnut Curl	VSEN	○	○	○	○	—	—	
Satin Mid Zebrano	VSEL	○	○	○	○	—	—	
Gloss Figured Ebony with Ribbon Laser Inlay	VSEO	○	○	○	○	—	—	
Gloss Shadow Walnut	VSEU	○	○	○	○	—	—	Not available with Wood/Leather Steering Wheel
Piano Black	VPFB	○	○	○	○	●	●	
Carbon Fibre	VPFA	○	○	○	○	○	○	

● Standard ○ Option — Not available

Please consult your local Jaguar retailer for details.

For a complete list of optional features and packs refer to the XJ Specification and Price Guide or configure your vehicle at jaguar.com

INFORMATION, COMMUNICATION AND ENTERTAINMENT

		LUXURY	PREMIUM LUXURY	PORTFOLIO	AUTOBIOGRAPHY	R-SPORT	XJR	
INFOTAINMENT	CODE							DESCRIPTION
Jaguar Sound System (250W)	B44U	●	●	—	—	—	—	Refer to page 44-45
Meridian Digital Sound System (380W)	B44V	○	○	●	●	●	—	Refer to page 44-45
Meridian Digital Surround Sound System (825W)	B44W	○	○	○	○	○	●	Refer to page 44-45
Meridian Reference Digital Sound System (1300W) with Conversation Assist	B44I	—	○	○	○	—	—	Refer to page 44-45
Digital Audio Broadcasting (DAB) Radio Receiver	B51A	○	○	○	○	○	○	
Bluetooth® - including Audio and Video Streaming	H74V	●	●	●	●	●	●	
InControl Pro Services	A44D	○	○	○	○	○	○	Only available as part of InControl Connect Pro pack. Availability varies by market. Refer to page 40-43
InControl Apps	H57A	○	○	○	○	○	○	Only available as part of InControl Connect Pro pack. Availability varies by market. Refer to page 40-43
Satellite Navigation System	—	●	●	●	●	●	●	
Single View Touch-screen Display	D70C	●	●	●	●	●	●	
Dual View Touch-screen Display (Requires a Meridian Sound System)	D70A	○	○	○	○	○	○	Feature not available before December 2015
Digital TV	G52G	○	○	○	○	○	○	
Rear Seat Entertainment System with 2 x Folding 10.2" HD screens (Requires a Meridian Sound System)	G51E	—	○	○	○	—	—	
Interactive Voice - Front Voice Control of Audio, Bluetooth® and Navigation	P52R	●	●	●	●	●	●	Availability varies by market

2 CHOOSE YOUR OPTIONS

 Configure your vehicle at jaguar.com

INFORMATION, COMMUNICATION AND ENTERTAINMENT CONTINUED

		LUXURY	PREMIUM LUXURY	PORTFOLIO	AUTOBIOGRAPHY	R-SPORT	XJR	
OPTIONS AVAILABLE ON LONG WHEELBASE ONLY								
Illuminated Rear Vanity Mirrors	B30A	●	●	●	●	—	●	
Rear Business Tables	G73C	—	○	○	○	—	—	
Manual Rear Side Window Blinds	H73B	●	●	●	—	—	●	
Electric Rear Side Window Blinds	H73C	○	○	○	●	—	○	
Individual Electric Rear Seats with Massage Function	B59G	—	○	○	○	—	—	Only available as part of the Rear Seat Pack
Individual Electric Rear Seats with Massage Function and Memory	B59Q	—	○	○	○	—	—	Only available as part of the Premium Rear Seat Pack/ Premium Rear Seat Pack with Dual View
OPTION PACKS								
Illumination Pack	Z46B	—	○	○	—	—	—	Includes Illuminated Air Vents, Illuminated Tread Plates and LED Rear Reading Lights
R-Sport Black Pack	Z93U	—	—	—	—	○	—	Includes Gloss Black Radiator Grille and Surround, Front Bumper Air Intake Blades, Side Window Finishers and Side Power Vents
XJR Black Pack	Z93W	—	—	—	—	—	○	Includes Gloss Black Radiator Grille and Surround, Front Bumper Air Intake Surrounds, Side Window Finishers and Side Power Vents
Parking Assist Pack (Requires Power Fold Mirror)	Z68R	○	○	○	—	○	○	Includes 360° Park Distance Control, Surround Camera System and Park Assist. Park Assist not available in pack on All Wheel Drive cars
Highway Pack (Requires Power Fold Mirror)	Z37H	○	○	○	—	○	○	Includes Closing Vehicle Sensing with Blind Spot Monitoring and Reverse Traffic Detection, Traffic Sign Recognition, Adaptive LED Headlamps and Auto High Beam Assist. Not available with Garage Door Opener
InControl Connect Pro Pack (Requires InControl Protect)	Z77A	○	○	○	○	○	○	Includes InControl Remote Premium, InControl Pro Services and InControl Apps

● Standard ○ Option — Not available

Please consult your local Jaguar retailer for details.

For a complete list of optional features and packs refer to the XJ Specification and Price Guide or configure your vehicle at jaguar.com

INFORMATION, COMMUNICATION AND ENTERTAINMENT CONTINUED

OPTION PACKS AVAILABLE ON LONG WHEELBASE ONLY	CODE	LUXURY	PREMIUM LUXURY	PORTFOLIO	AUTOBIOGRAPHY	R-SPORT	XJR	DESCRIPTION
Rear Seat Pack (Requires 18 Way Front Seats)	Z30A	-	○	○	○	-	-	Includes Individual Electric Rear Seats with Massage Function, LED Rear Reading Lights, Winged Front and Rear Headrests and Electric Rear Side Window Blinds
Premium Rear Seat Pack (Requires 18 Way Front Seats)	Z30B	-	○	○	○	-	-	Includes Individual Electric Rear Seats with Massage Function and Memory, Rear Seat Entertainment System, Rear Business Tables, LED Rear Reading Lights, Winged Front and Rear Headrests and Electric Rear Side Window Blinds
Premium Rear Seat Pack with Dual View* (Requires 18 Way Front Seats)	Z30C	-	○	○	○	-	-	Includes Individual Electric Rear Seats with Massage Function and Memory, Rear Seat Entertainment System, Rear Business Tables, LED Rear Reading Lights, Winged Front and Rear Headrests, Electric Rear Side Window Blinds and Dual View Touch-screen

*Feature not available before December 2015.

3 CHOOSE YOUR COLOUR

 [Configure your vehicle at jaguar.com](https://www.jaguar.com)

SOLID

Polaris White

Ebony

METALLIC

Glacier White

Rhodium Silver

Quartzite

Ammonite Grey

Dark Sapphire

Odyssey Red

Aurora Red



PREMIUM METALLIC

Italian Racing Red

British Racing Green

Ultimate Black

Ingot

Tempest Grey

Storm Grey

Black Berry

Celestial Black

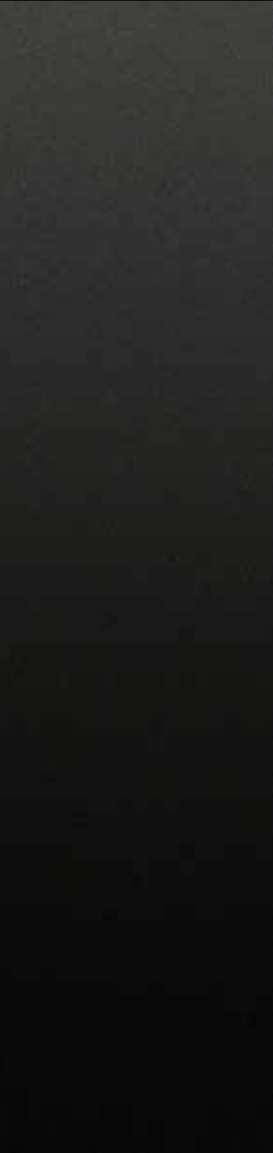

4 CHOOSE YOUR WHEELS

 Configure your vehicle at jaguar.com



	18" MANRA	18" MERU	19" ALEUTIAN	19" TOBA	19" TOBA POLISHED
ALLOY WHEEL FINISH	Sparkle Silver	Sparkle Silver	Sparkle Silver	Sparkle Silver	Polished
ALLOY WHEEL / SIZE	8.0J x 18" / 9.0J x 18"	8.0J x 18" / 9.0J x 18"	9.0J x 19" / 10.0J x 19"	9.0J x 19" / 10.0J x 19"	9.0J x 19" / 10.0J x 19"
TYRE SIZE	245/50ZR18 / 275/45ZR18	245/50ZR18 / 275/45ZR18	245/45ZR19 / 275/40ZR19	245/45ZR19 / 275/40ZR19	245/45ZR19 / 275/40ZR19
CODE	C51S	C45B	C45C	C45D	C45E
Luxury	<input type="radio"/>	<input checked="" type="radio"/>	<input checked="" type="radio"/>	<input type="radio"/>	<input type="radio"/>
Premium Luxury	—	<input checked="" type="radio"/>	<input checked="" type="radio"/>	<input checked="" type="radio"/>	<input type="radio"/>
Portfolio	—	—	<input type="radio"/>	<input checked="" type="radio"/>	<input type="radio"/>
Autobiography	—	—	<input type="radio"/>	<input type="radio"/>	<input type="radio"/>
R-Sport	—	—	—	—	—
XJR	—	—	—	—	—



	20" KASUGA	20" KASUGA POLISHED	20" ORONA
ALLOY WHEEL FINISH	High Gloss Silver	Polished	Silver
ALLOY WHEEL / SIZE	9.0J x 20" / 10.0J x 20"	9.0J x 20" / 10.0J x 20"	9.0J x 20" / 10.0J x 20"
TYRE SIZE	245/40ZR20 / 275/35ZR20	245/40ZR20 / 275/35ZR20	245/40ZR20 / 275/35ZR20
CODE	C45G	C45H	C45J
Luxury	<input type="radio"/>	<input type="radio"/>	<input type="radio"/>
Premium Luxury	<input type="radio"/>	<input type="radio"/>	<input type="radio"/>
Portfolio	<input type="radio"/>	<input type="radio"/>	<input type="radio"/>
Autobiography	<input type="radio"/>	<input type="radio"/>	<input type="radio"/>
R-Sport	<input type="radio"/>	<input type="radio"/>	<input type="radio"/>
XJR	—	—	—

● Standard ○ Option — Not Applicable

Standard and optional features may differ depending on market availability.

Please consult your local Jaguar retailer for details.



	20" ORONA POLISHED	20" MATAIVA	20" MAROA	20" VENOM	20" VENOM GLOSS BLACK
ALLOY WHEEL FINISH	Polished	Light Silver	Satin Grey and Diamond Turned	Sparkle Silver	Gloss Black
ALLOY WHEEL / SIZE	9.0J x 20" / 10.0J x 20"	9.0J x 20" / 10.0J x 20"	9.0J x 20" / 10.0J x 20"	9.0J x 20" / 10.0J x 20"	9.0J x 20" / 10.0J x 20"
TYRE SIZE	245/40ZR20 / 275/35ZR20	245/40ZR20 / 275/35ZR20	245/40ZR20 / 275/35ZR20	245/40ZR20 / 275/35ZR20	245/40ZR20 / 275/35ZR20
CODE	C45K	C45L	C46B	C46A	C52J
Luxury	<input type="radio"/>	—	—	—	—
Premium Luxury	<input type="radio"/>	—	—	—	—
Portfolio	<input type="radio"/>	—	—	—	—
Autobiography	<input type="radio"/>	<input checked="" type="radio"/>	<input type="radio"/>	—	—
R-Sport	—	—	—	<input checked="" type="radio"/>	<input type="radio"/>
XJR	—	—	—	—	—



	20" FARALLON TECHNICAL GREY	20" FARALLON SPARKLE SILVER	20" FARALLON GLOSS BLACK
ALLOY WHEEL FINISH	Technical Grey	Sparkle Silver	Gloss Black
ALLOY WHEEL / SIZE	9.0J x 20" / 10.0J x 20"	9.0J x 20" / 10.0J x 20"	9.0J x 20" / 10.0J x 20"
TYRE SIZE	265/35R20 / 295/30R20	265/35R20 / 295/30R20	265/35R20 / 295/30R20
CODE	C51Y	C51Z	C52H
Luxury	—	—	—
Premium Luxury	—	—	—
Portfolio	—	—	—
Autobiography	—	—	—
R-Sport	—	—	—
XJR	<input checked="" type="radio"/>	<input type="radio"/>	<input type="radio"/>

5 CHOOSE YOUR INTERIOR

 Configure your vehicle at jaguar.com

LUXURY							
	SEAT BOND GRAIN LEATHER WITH STITCH	VENEER	MORZINE HEADLINING	UPPER FACIA BOND GRAIN LEATHER	LOWER FACIA	CARPET	INTERIOR TRIM AND OPTION CODES
Standard							
	Cashew/Cashew	Satin Rosewood	Ivory	Truffle	Cashew	Truffle	BAON
	Jet/Jet	Satin Rosewood	Ivory	Jet	Jet	Jet	BAOM
PREMIUM LUXURY							
	SEAT SOFT GRAIN PERFORATED LEATHER WITH STITCH/PIPING	VENEER	MORZINE HEADLINING	UPPER FACIA SOFT FEEL	LOWER FACIA	CARPET	INTERIOR TRIM AND OPTION CODES
Standard							
	Ivory/Oyster/Oyster	Gloss Rich Oak	Ivory	Oyster	Ivory	Oyster	BAOR
	Cashew/Truffle/Truffle	Gloss Rich Oak	Ivory	Truffle	Cashew	Truffle	BAOQ
	London Tan/Jet/Jet	Gloss Rich Oak	Ivory	Jet	London Tan	Jet	BAOS
	Jet/Ivory/Ivory	Gloss Rich Oak	Ivory	Jet	Jet	Jet	BAOP
PORTFOLIO							
	SEAT SOFT GRAIN QUILTED AND PERFORATED LEATHER WITH STITCH	VENEER	PREMIUM SUEDECLOTH HEADLINING	UPPER FACIA SOFT GRAIN LEATHER	LOWER FACIA	CARPET	INTERIOR TRIM AND OPTION CODES
Standard							
	Navy/Ivory	Gloss Figured Ebony	Ivory	Navy	Navy	Navy	BAOY
	Jet/Ivory	Gloss Figured Ebony	Ivory or Jet	Jet	Jet	Jet	BAOT
	Cirrus/Mineral	Gloss Figured Ebony	Ivory	Mineral	Cirrus	Mineral	BAOX
	London Tan/Jet	Gloss Figured Ebony	Ivory or Jet	Jet	London Tan	Jet	BAOZ
	Cashew/Truffle	Gloss Figured Ebony	Ivory	Truffle	Cashew	Truffle	BAOU
	Ivory/Oyster	Gloss Figured Ebony	Ivory	Oyster	Ivory	Oyster	BAOW
	Ivory/Jet	Gloss Figured Ebony	Ivory or Jet	Jet	Ivory	Jet	BAOV

Please consult your local Jaguar retailer for details.

AUTOBIOGRAPHY							
	SEAT SEMI-ANILINE QUILTED AND PERFORATED LEATHER WITH STITCH	VENEER	SOFT GRAIN LEATHER HEADLINING	UPPER FACIA SOFT GRAIN LEATHER	LOWER FACIA	CARPET	INTERIOR TRIM AND OPTION CODES
Standard							
	Ivory/Mineral	Gloss Rich Oak with Linear Laser Inlay	Ivory	Mineral	Ivory	Mineral	BAPE
	Ivory/Jet	Gloss Rich Oak with Linear Laser Inlay	Ivory or Jet	Jet	Ivory	Jet	BAPC
	Cirrus/Navy	Gloss Rich Oak with Linear Laser Inlay	Ivory	Navy	Cirrus	Navy	BAPF
	Cashew/Truffle	Gloss Rich Oak with Linear Laser Inlay	Ivory	Truffle	Cashew	Truffle	BAPB
	London Tan/Jet	Gloss Rich Oak with Linear Laser Inlay	Ivory or Jet	Jet	London Tan	Jet	BAPG
	Bordeaux/Bordeaux	Gloss Rich Oak with Linear Laser Inlay	Ivory or Jet	Jet	Bordeaux	Jet	BAPD
	Jet/Ivory	Gloss Rich Oak with Linear Laser Inlay	Ivory or Jet	Jet	Jet	Jet	BAPA
R-SPORT							
	SEAT SOFT GRAIN PERFORATED LEATHER WITH STITCH	VENEER	PREMIUM SUEDECLOTH HEADLINING	UPPER FACIA SOFT GRAIN LEATHER	LOWER FACIA	CARPET	INTERIOR TRIM AND OPTION CODES
Standard							
	Jet/Red	Piano Black	Ivory or Jet	Jet	Jet	Jet	BAPK
	Ivory/Jet	Piano Black	Ivory or Jet	Jet	Ivory	Jet	BAPL
XJR							
	SEAT SOFT GRAIN PERFORATED LEATHER WITH STITCH	VENEER	SOFT GRAIN LEATHER HEADLINING	UPPER FACIA SOFT GRAIN LEATHER	LOWER FACIA	CARPET	INTERIOR TRIM AND OPTION CODES
Standard							
	Jet/Red duo-tone/Red	Piano Black	Jet	Jet	Jet	Jet	BAMT
	Jet/Red	Piano Black	Jet	Jet	Jet	Jet	BAMQ
	Jet/London Tan duo-tone/London Tan	Piano Black	Jet	Jet	Jet	Jet	BAMU
	Jet/London Tan	Piano Black	Jet	Jet	Jet	Jet	BAMR
	Jet/Ivory duo-tone/Ivory	Piano Black	Jet	Jet	Jet	Jet	BAMS

5 CHOOSE YOUR INTERIOR

Configure your vehicle at jaguar.com

Interior Shown: Cashew Bond grain leather seats with Truffle upper facia, Ivory morzine headlining, Satin Rosewood veneer and Truffle carpet.



LUXURY

INTERIOR COLOUR COMBINATIONS

STANDARD - BOND GRAIN LEATHER

1

SEAT WITH TONAL STITCH

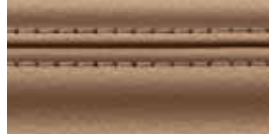

Cashew with Cashew stitch

2

VENEER



Satin Rosewood

3

MORZINE HEADLINING



Ivory

4

UPPER FACIA



Truffle

5

LOWER FACIA



Cashew

6

CARPET



Truffle

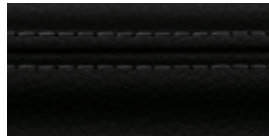

Jet with Jet stitch



Satin Rosewood



Ivory



Jet

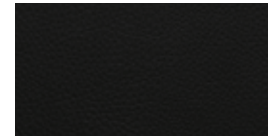

Jet



Jet

VENEER OPTIONS

Carbon Fibre, Gloss Figured Ebony, Gloss Figured Ebony with Ribbon Laser Inlay, Gloss Burr Walnut, Gloss Rich Oak, Gloss Walnut Curl, Piano Black, Gloss Rich Oak with Linear Laser Inlay, Satin Elm, Satin Mid Zebrano or Shadow Walnut

5 CHOOSE YOUR INTERIOR

⚙️ Configure your vehicle at jaguar.com

























Interior shown: Ivory soft grain leather seats with Oyster upper facia, Ivory morzine headlining, Gloss Rich Oak veneer and Oyster carpet.



PREMIUM LUXURY

INTERIOR COLOUR COMBINATIONS

STANDARD - SOFT GRAIN LEATHER SEAT

1	2	3	4	5	6
SEAT WITH CONTRAST STITCH AND PIPING	VENEER	MORZINE HEADLINING	UPPER FACIA	LOWER FACIA	CARPET
 Ivory with Oyster stitch	 Gloss Rich Oak	 Ivory	 Oyster	 Ivory	 Oyster
 Cashew with Truffle stitch	 Gloss Rich Oak	 Ivory	 Truffle	 Cashew	 Truffle
 London Tan with Jet stitch	 Gloss Rich Oak	 Ivory	 Jet	 London Tan	 Jet
 Jet with Ivory stitch	 Gloss Rich Oak	 Ivory	 Jet	 Jet	 Jet

VENEER OPTIONS

Carbon Fibre, Gloss Figured Ebony, Gloss Figured Ebony with Ribbon Laser Inlay, Gloss Burr Walnut, Satin Rosewood, Gloss Walnut Curl, Piano Black, Gloss Rich Oak with Linear Laser Inlay, Satin Elm, Satin Mid Zebrano or Shadow Walnut

5 CHOOSE YOUR INTERIOR

Configure your vehicle at jaguar.com























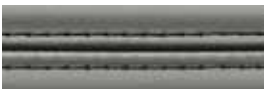



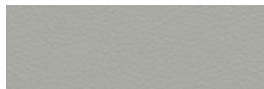















Interior Shown: Navy soft grain perforated quilted leather seats with Ivory contrast stitch, Navy upper fascia, Ivory Suedecloth headlining, Gloss Figured Ebony veneer and Navy carpet.



PORTFOLIO

INTERIOR COLOUR COMBINATIONS

STANDARD - SOFT GRAIN LEATHER SEAT

1	2	3	4	5	6
SEAT WITH CONTRAST STITCH	VENEER	SUEDECLOTH HEADLINING	UPPER FACIA	LOWER FACIA	CARPET
 Navy with Ivory stitch	 Gloss Figured Ebony	 Ivory	 Navy	 Navy	 Navy
 Jet with Ivory stitch	 Gloss Figured Ebony	 Ivory or Jet	 Jet	 Jet	 Jet
 Cirrus with Mineral stitch	 Gloss Figured Ebony	 Ivory	 Mineral	 Cirrus	 Mineral
 London Tan with Jet stitch	 Gloss Figured Ebony	 Ivory or Jet	 Jet	 London Tan	 Jet
 Cashew with Truffle stitch	 Gloss Figured Ebony	 Ivory	 Truffle	 Cashew	 Truffle
 Ivory with Oyster stitch	 Gloss Figured Ebony	 Ivory	 Oyster	 Ivory	 Oyster
 Ivory with Jet stitch	 Gloss Figured Ebony	 Ivory or Jet	 Jet	 Ivory	 Jet

VENEER OPTIONS

Carbon Fibre, Gloss Figured Ebony with Ribbon Laser Inlay, Gloss Burr Walnut, Gloss Rich Oak, Gloss Walnut Curl, Piano Black, Gloss Rich Oak with Linear Laser Inlay, Satin Elm, Satin Mid Zebrano, Satin Rosewood or Shadow Walnut

5 CHOOSE YOUR INTERIOR

⚙️ Configure your vehicle at jaguar.com













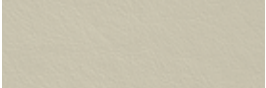





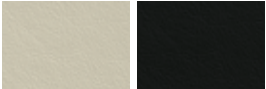





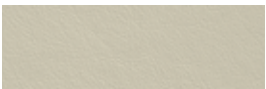

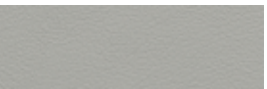

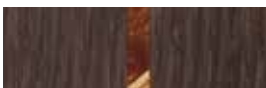
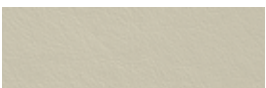





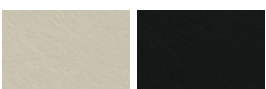

Interior shown: Ivory semi-aniline perforated leather seats with Mineral contrast stitch, Mineral upper fascia, Ivory leather headlining and Gloss Rich Oak with Linear Laser Inlay veneer and Mineral carpet.

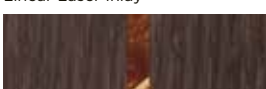
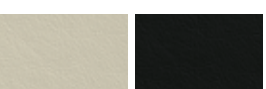

AUTOBIOGRAPHY

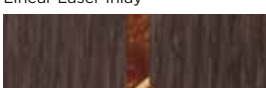
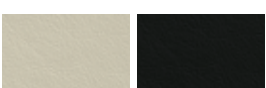
INTERIOR COLOUR COMBINATIONS

STANDARD - SEMI-ANILINE LEATHER SEAT

1	2	3	4	5	6
SEAT WITH CONTRAST STITCH	VENEER	LEATHER HEADLINING	UPPER FACIA	LOWER FACIA	CARPET
 Ivory with Mineral stitch	 Gloss Rich Oak with Linear Laser Inlay	 Ivory	 Mineral	 Ivory	 Mineral
 Ivory with Jet stitch	 Gloss Rich Oak with Linear Laser Inlay	 Ivory or Jet	 Jet	 Ivory	 Jet
 Cirrus with Navy stitch	 Gloss Rich Oak with Linear Laser Inlay	 Ivory	 Navy	 Cirrus	 Navy
 Cashew with Truffle stitch	 Gloss Rich Oak with Linear Laser Inlay	 Ivory	 Truffle	 Cashew	 Truffle
 London Tan with Jet stitch	 Gloss Rich Oak with Linear Laser Inlay	 Ivory or Jet	 Jet	 London Tan	 Jet
 Bordeaux with Bordeaux stitch	 Gloss Rich Oak with Linear Laser Inlay	 Ivory or Jet	 Jet	 Bordeaux	 Jet
 Jet with Ivory stitch	 Gloss Rich Oak with Linear Laser Inlay	 Ivory or Jet	 Jet	 Jet	 Jet

VENEER OPTIONS

Carbon Fibre, Gloss Figured Ebony, Gloss Figured Ebony with Ribbon Laser Inlay, Gloss Burr Walnut, Gloss Rich Oak, Gloss Walnut Curl, Piano Black, Satin Elm, Satin Mid Zebrano, Satin Rosewood or Shadow Walnut

5 CHOOSE YOUR INTERIOR

⚙️ Configure your vehicle at jaguar.com













Interior shown: Jet soft grain leather sports seats with Red contrast stitch, Jet upper facia, Ivory suedecloth headlining, Piano Black veneer and Jet carpet.

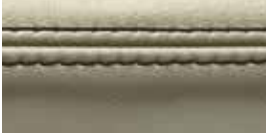

R-SPORT

INTERIOR COLOUR COMBINATIONS

STANDARD - SOFT GRAIN LEATHER SEAT

①	②	③	④	⑤	⑥
<p>LEATHER SEAT WITH CONTRAST STITCH</p>  <p>Jet with Red stitch</p>	<p>VENEER</p>  <p>Piano Black</p>	<p>SUEDECLOTH HEADLINING</p>  <p>Ivory or Jet</p>	<p>UPPER FACIA</p>  <p>Jet</p>	<p>LOWER FACIA</p>  <p>Jet</p>	<p>CARPET</p>  <p>Jet</p>
 <p>Ivory with Jet stitch</p>	 <p>Piano Black</p>	 <p>Ivory or Jet</p>	 <p>Jet</p>	 <p>Ivory</p>	 <p>Jet</p>

VENEER OPTION

Carbon Fibre

5 CHOOSE YOUR INTERIOR

⚙️ Configure your vehicle at jaguar.com

















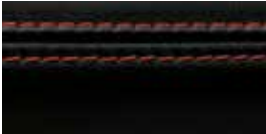













Interior shown: Jet/Red soft grain duotone leather seats with Red contrast stitch, Jet upper fascia, Jet Suedecloth headlining, Piano Black veneer and Jet carpet.

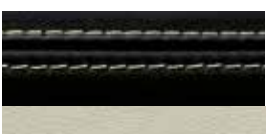

XJR

INTERIOR COLOUR COMBINATIONS

STANDARD - SOFT GRAIN LEATHER SEAT

1	2	3	4	5	6
LEATHER SEAT WITH CONTRAST STITCH	VENEER	SUEDECLOTH HEADLINING	UPPER FACIA	LOWER FACIA	CARPET
 <p>Jet/Red duotone with Red stitch</p>	 <p>Piano Black</p>	 <p>Jet</p>	 <p>Jet</p>	 <p>Jet</p>	 <p>Jet</p>
 <p>Jet with Red stitch</p>	 <p>Piano Black</p>	 <p>Jet</p>	 <p>Jet</p>	 <p>Jet</p>	 <p>Jet</p>
 <p>Jet/London Tan duotone with London Tan stitch</p>	 <p>Piano Black</p>	 <p>Jet</p>	 <p>Jet</p>	 <p>Jet</p>	 <p>Jet</p>
 <p>Jet with London Tan stitch</p>	 <p>Piano Black</p>	 <p>Jet</p>	 <p>Jet</p>	 <p>Jet</p>	 <p>Jet</p>
 <p>Jet/Ivory duotone with Ivory stitch</p>	 <p>Piano Black</p>	 <p>Jet</p>	 <p>Jet</p>	 <p>Jet</p>	 <p>Jet</p>

VENEER OPTION

Carbon Fibre

5 CHOOSE YOUR INTERIOR

 Configure your vehicle at jaguar.com

Piano Black

Carbon Fibre

Gloss Rich Oak

Satin Rosewood

Gloss Figured Ebony

Gloss Rich Oak
with Linear Laser Inlay



Gloss Figured Ebony
with Ribbon Laser Inlay

Gloss Walnut Curl

Gloss Burr Walnut

Gloss Shadow Walnut

Satin Elm

Satin Mid Zebrano



6 CHOOSE YOUR JAGUAR ACCESSORIES

To find out more about the full range of retailer fit Jaguar Accessories, please refer to your retailer or go to accessories.jaguar.com

Polished Tailpipe Finishers



Styled Valve Caps



Chrome Mirror Covers

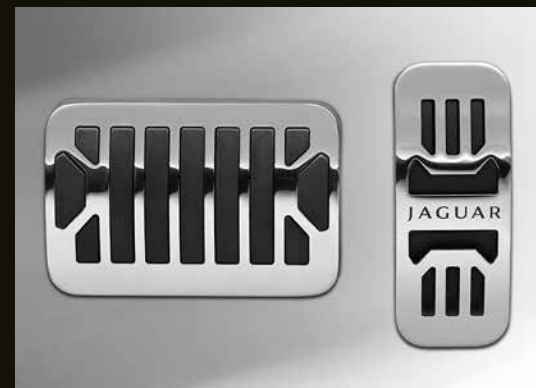

Sport Pedal Covers

JaguarDrive Selector - Black Leather Top



Headrest Coat Hanger



iPad Holder



Aluminium Gearshift Paddles



Luggage Compartment Net



Premium Loadspace Mat

TECHNICAL SPECIFICATIONS

 Configure your vehicle at jaguar.com

ENGINES		JAGUAR 2.0 LITRE 4 CYLINDER 240 TURBOCHARGED PETROL	JAGUAR 3.0 LITRE V6 300 TURBOCHARGED DIESEL	JAGUAR 3.0 LITRE V6 340 SUPERCHARGED PETROL	JAGUAR 5.0 LITRE V8 550 SUPERCHARGED PETROL
Drive		RWD	RWD	RWD	AWD
Capacity	cc	1999	2993	2995	2995
Maximum power	EEC-PS (kW)	240 (177)	300 (221)	340 (250)	340 (250)
@rev/min		5,500	4,000	6,500	6,500
Maximum torque	EEC-Nm (lb.ft.)	340 (251)	700 (516)	450 (332)	450 (332)
@rev/min		2,000-4,000	2,000	3,500-5,000	3,500-5,000
Transmission		8-speed automatic	8-speed automatic	8-speed automatic	8-speed automatic
PERFORMANCE					
0-100 km/h	seconds	7.9	6.2	5.9	6.4
0-60 mph	seconds	7.5	5.9	5.7	6.1
Top speed	km/h (mph)	241 (150)	250 (155) limited	250 (155) limited	250 (155) limited
280 (174) limited					
FUEL CONSUMPTION ¹ - STANDARD WHEELBASE					
Urban	l/100km (mpg)	11.4 (24.8)	7.0 (40.4)	12.5 (22.6)	13.6 (20.8)
Extra Urban	l/100km (mpg)	6.7 (42.2)	5.2 (54.3)	7.1 (39.8)	7.6 (37.2)
Combined	l/100km (mpg)	8.4 (33.6)	5.7 (49.6)	9.1 (31.0)	9.8 (28.8)
Carbon dioxide emissions	g/km	199	149	211	234
Tank capacity (usable)	ltr approx.	80	77	80	80
FUEL CONSUMPTION ¹ - LONG WHEELBASE					
Urban	l/100km (mpg)	11.4 (24.8)	7.0 (40.4)	12.5 (22.6)	13.6 (20.8)
Extra Urban	l/100km (mpg)	6.7 (42.2)	5.2 (54.3)	7.1 (39.8)	7.6 (37.2)
Combined	l/100km (mpg)	8.4 (33.6)	5.7 (49.6)	9.1 (31.0)	9.8 (28.8)
Carbon dioxide emissions	g/km	199	149	211	234
Tank capacity	ltr approx.	80	77	80	80
ENGINE AVAILABILITY					
Luxury		●	●	●	—
Premium Luxury		●	●	—	●
Portfolio		—	●	—	●
Autobiography		—	●	—	●
R-Sport		—	●	—	●
XJR		—	—	—	●

● Standard — Not available

¹The figures provided are as a result of official manufacturer's tests in accordance with EU legislation. A vehicle's actual fuel consumption may differ from that achieved in such tests and these figures are for comparative purposes only.

²Weights reflect vehicles to standard specifications. Optional extras increase weight.

Please consult your local Jaguar retailer for details.

STANDARD WHEELBASE		JAGUAR 2.0 LITRE 4 CYLINDER 240 TURBOCHARGED PETROL	JAGUAR 3.0 LITRE V6 300 TURBOCHARGED DIESEL	JAGUAR 3.0 LITRE V6 340 SUPERCHARGED PETROL	JAGUAR 5.0 LITRE V8 550 SUPERCHARGED PETROL
Drive		RWD	RWD	RWD	AWD
Overall length	mm	5,130	5,130	5,130	5,130
Overall width (inc./exc. mirrors)	mm	2,105/1,899	2,105/1,899	2,105/1,899	2,105/1,899
Overall height (inc. antenna)	mm	1,460	1,460	1,460	1,460
Wheelbase	mm	3,032	3,032	3,032	3,032
Front/Rear track	mm	1,626/1,604	1,626/1,604	1,626/1,604	1,626/1,604
Turning circle diameter (kerb to kerb)	m (ft.in)	11.9 (39.0)	11.9 (39.0)	11.9 (39.0)	12.4 (40.7)
Boot volume with tyre repair system	litres - VDA (cu.ft.)	478	478	478	478
Front/Rear legroom	mm	1,055/988	1,055/988	1,055/988	1,055/988
Headroom with sunroof (front)	mm	1,004	1,004	1,004	1,004
Headroom (rear)	mm	946	946	946	946
Front/Rear shoulder room	mm	1,464/1,437	1,464/1,437	1,464/1,437	1,464/1,437
Weight ²	kg (lbs)	1,735 (3,825)	1,835 (4,045)	1,765 (3,891)	1,865 (4,112)
Gross vehicle weight ²	kg (lbs)	2,280 (5026)	2,400 (5,291)	2,350 (5,181)	2,430 (5,357)
LONG WHEELBASE					
Overall length	mm	5,255	5,255	5,255	5,255
Overall width (inc./exc. mirrors)	mm	2,105/1,899	2,105/1,899	2,105/1,899	2,105/1,899
Overall height (inc. antenna)	mm	1,460	1,460	1,460	1,460
Wheelbase	mm	3,157	3,157	3,157	3,157
Front/Rear track	mm	1,626/1,604	1,626/1,604	1,626/1,604	1,626/1,604
Turning circle diameter (kerb to kerb)	m (ft.in)	12.3 (40.4)	12.3 (40.4)	12.3 (40.4)	12.9 (42.3)
Boot volume with tyre repair system	litres - VDA (cu.ft.)	478	478	478	478
Front/Rear legroom	mm	1,055/1,109	1,055/1,109	1,055/1,109	1,055/1,109
Rear legroom with Rear Seat Package (rear seat fully upright)	mm	1,109	1,109	1,109	1,109
Rear legroom with Rear Seat Package (rear seat fully reclined)	mm	1,021	1,021	1,021	1,021
Rear legroom with Premium Rear Seat Package (rear seat fully upright)	mm	1,087	1,087	1,087	1,087
Rear legroom with Premium Rear Seat Package (rear seat fully reclined)	mm	989	989	989	989
Headroom with sunroof (front)	mm	1,004	1,004	1,004	1,004
Headroom (rear)	mm	960	960	960	960
Front/Rear shoulder room	mm	1,464/1,437	1,464/1,437	1,464/1,437	1,464/1,437
Weight ²	kg (lbs)	1,755 (3,869)	1,860 (4,101)	1,775 (3,913)	1,875 (4,134)
Gross vehicle weight ²	kg (lbs)	2,320 (5,115)	2,450 (5,401)	2,400 (5,291)	2,450 (5,401)

DIMENSIONS

(inc mirrors) 2,105mm
(exc mirrors) 1,899mm
478 Litres

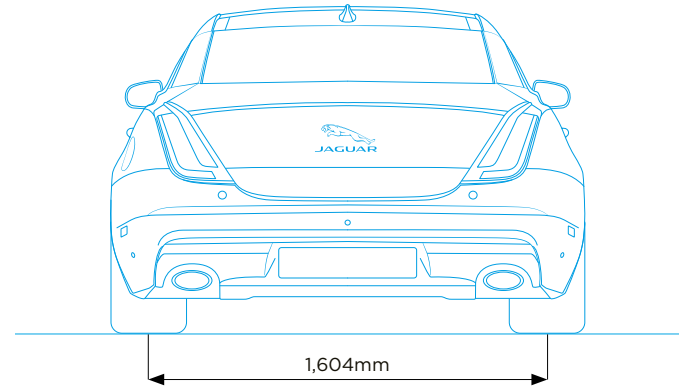
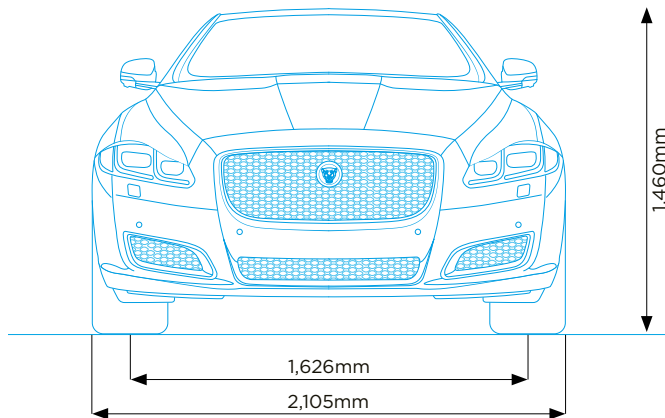

VEHICLE SHOWN: XJ PORTFOLIO STANDARD WHEELBASE (SWB)

Kerb-to-kerb RWD 11.90m
Kerb-to-kerb AWD 12.40m

Kerb-to-kerb RWD 12.30m
Kerb-to-kerb AWD 12.90m

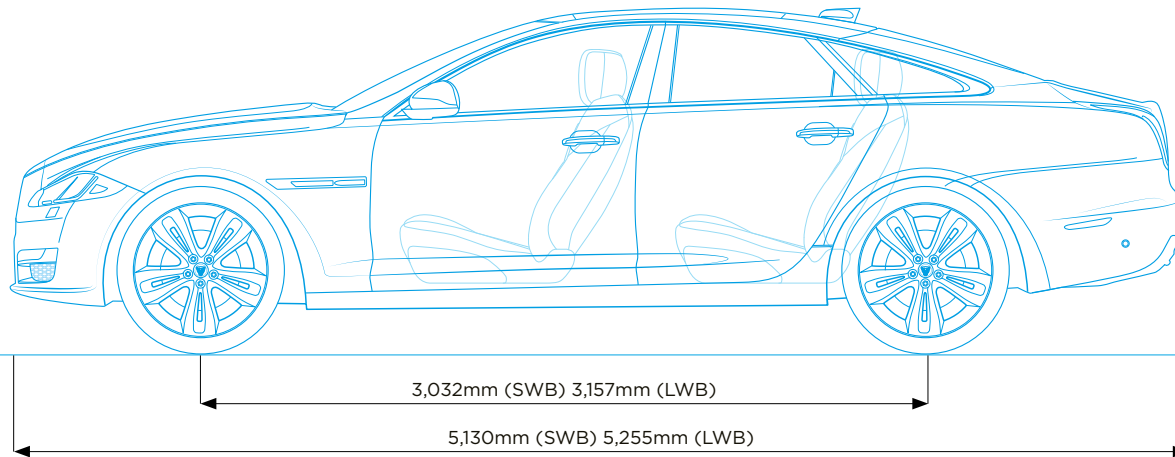
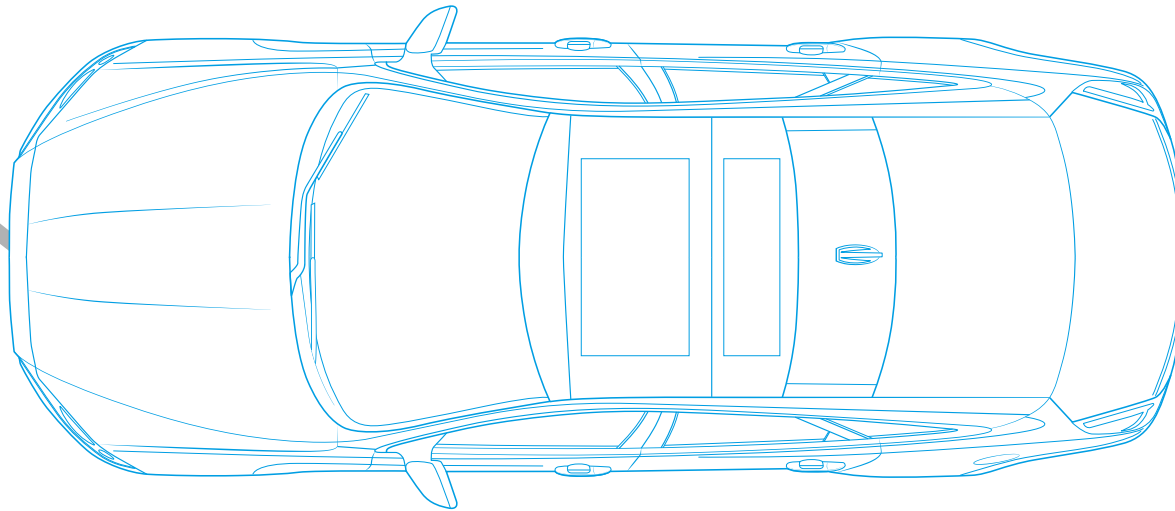

Dimensions were measured with vehicle at unladen weight.
Boot volume measured by VDA standard test method using 200 x 100 x 50mm blocks.



JAGUAR EXPERIENCE

There's no better way to get to know XJ and Jaguar than by taking a drive. Jaguar Experience offers a range of unique opportunities to really find out what it feels like to get the most out of a Jaguar. Our track experiences allow you to push yourself, XJ and other cars from the incredible Jaguar range to the limit. Jaguar Experience also offers the opportunity to see a Jaguar brought to life during a tour of one of our UK manufacturing facilities. Find out more by visiting jaguar.com/experience



Follow us on:



Facebook.com



Instagram.com



Twitter.com



Youtube.com

THE WORLD OF JAGUAR

Choose an XJ and you're joining the exciting World of Jaguar. It makes owning and driving carefree and easy, as well as providing a range of exclusive services and lifestyle products.



JAGUAR CARE*

XJ is now offered with a new unlimited mileage, three year warranty and three years' standard servicing programme. We call this programme Jaguar Care.



GENUINE PARTS

Jaguar Genuine Parts are designed, tested and manufactured to our uncompromising standards for quality, fit and durability. Each part is engineered specifically for your XJ to contribute to optimum performance and to help maximise its lifespan.



FLEET & BUSINESS

Jaguar is dedicated to being the premium manufacturer of choice for fleets and businesses by providing a highly attractive car range and exemplary customer service. Jaguars are dynamic and distinctive cars that help companies express the unique character and personality of their business. We are committed to providing totally customer-focused aftersales services, which keeps every Jaguar car on the move and in top condition, ensuring that they perform to the highest standard and in the most cost-efficient way for businesses. Visit jaguar.com/fleet-and-business for more information.

*Selected European Markets only.



JAGUAR FINANCIAL SERVICES

Effortless performance and style come as standard with every Jaguar. Jaguar Financial Services makes buying one just as simple and rewarding. New or used, for personal or business use, we have an option that puts you in complete control. Please speak to your local Jaguar retailer to find out more.



JAGUAR ASSISTANCE

Jaguar Assistance provides assistance in motoring emergencies, from immobilisation due to breakdown or accident to minor problems such as punctures. You can rely on our roadside assistance, whatever the situation, wherever you happen to be.

LOW INSURANCE

XJ's key components are easily accessible for time-efficient service and repair costs. With a focus on lower repair costs, XJ delivers competitive insurance group ratings**. To find out more about the compelling business case for XJ, please contact your local Jaguar retailer.



JAGUAR MAGAZINE

Jaguar Magazine is the official magazine of Jaguar Cars. It features the new Jaguar XJ, XF, XE, F-TYPE and F-PACE, and the worlds of luxury, style, design and travel.

JAGUAR COLLECTION

The latest range from the Jaguar Collection has been crafted with the same design execution and attention to detail that goes into all of our cars. This is evident in our clothing range, premium leather items and luxury travel goods. To celebrate Jaguar's heritage we also have a collection that honours past achievements and features race inspired gift items and apparel. To find out more, visit the online shop at jaguar.com/shop

**Manufacturer's estimate.

GLOSSARY

#

3D MAPPING

Three dimensional mapping is a selectable view mode in the navigation system. It provides an aerial view of the landscape with three dimensional buildings to greatly enhance user orientation.

7.1 SURROUND SOUND

7.1 Surround Sound is the common name for an eight-channel surround sound system.

A

ABS SYSTEM

The Anti-lock Braking System prevents wheel lock up under heavy braking to maintain vehicle control.

AIR SUSPENSION

Rear air suspension replaces conventional steel springs with pneumatic air springs to provide maximum ride comfort and control by automatically adjusting spring rates to suit the situation.

AUTO-DIMMING INTERIOR REAR VIEW MIRROR

Auto-dimming mirrors automatically reduce reflected glare from following cars' headlights.

D

DIGITAL SOUND PROCESSOR (DSP)

Meridian's Digital Signal Processing (DSP) technology analyses a range of variables that may impact audio quality, then processes them using sophisticated algorithms and adapts the system's output accordingly. This enables a level of powerful, authentic performance impossible with a conventional sound system.

F

FOUR ZONE CLIMATE CONTROL

Adds independent automatic temperature control for left and right rear passengers in addition to the front dual zone.

H

HEAT-REFLECTIVE GLASS

This glass reflects infrared light waves and so reduces heat build-up inside the car caused by direct sunlight.

I

INSTRUMENT PANEL DISPLAY

The Instrument Panel Display is a 12.3 inch High Definition TFT (Thin Film Transistor) screen that replaces the traditional instrument cluster. It displays a wide range of key driving information. Four graphical themes and a 3D map view are available.

J

JAGUAR SMART KEY SYSTEM - KEYLESS START

When the Smart Key is present in the car, simply push the Start button to start the engine.

JAGUARDRIVE CONTROL

Interacts with the Dynamic Stability Control system, engine and transmission management systems to alter the characteristics of the engine mapping, gear shifts and brakes. It offers different modes designed to optimise the vehicle's response to particular driving conditions and styles.

JAGUARDRIVE SELECTOR

The JaguarDrive Selector rises from the centre console on start up. It is a rotary shifter used with automatic transmissions that allows you to quickly shift between drive modes.

L

LIMOUSINE RIDE SUSPENSION

For Long Wheelbase versions of XJ, the rear air suspension has been specially recalibrated to optimise comfort, providing limousine like ride quality.

P

PSYCHOACOUSTICS

Psychoacoustics is the study of the psychological and physiological responses associated with listening to sound.

S

SOLAR ATTENUATING GLASS

This glass filters sunlight to reduce glare and prevent harmful UV rays from entering the cabin.

T

TRIFIELD™

Meridian's exclusive Trifield technology, delivers a consistent, concert-like experience, optimised for all seating positions.

W

WINTER MODE

By selecting Winter Mode, the system automatically dampens acceleration and applies more gradual torque for improved control in slippery conditions.



IMPORTANT NOTICE

Jaguar Land Rover Limited is constantly seeking ways to improve the specification, design and production of its vehicles and alterations take place continually. Whilst every effort is made to produce up-to-date literature, this brochure should not be regarded as an infallible guide to current specifications, nor does it constitute an offer for the sale of any particular vehicle. Distributors and dealers are not agents of Jaguar Land Rover Limited by any express or implied undertaking or representation.

Comparisons are based on manufacturer's own data and testing.

COLOURS

Print and online colours are representative only.

ENVIRONMENTAL INNOVATION AT JAGUAR

Jaguar is proud to continue the company's tradition with its approach to Environmental Innovation. From the choice of lightweight materials and lean production methods to the efficiency of its engines and designs, Jaguar is committed to operating as a more sustainable business and reducing its overall environmental impact.

Jaguar's flagship XJ model was the first in the company to achieve ISO14040, the international standard for vehicle 'life cycle assessment'. This certification measures the environmental impact of XJ from component material sourcing and manufacturing process, through driving 200,000 km. But that's not all. Every new Jaguar is designed to be 85% recyclable and reusable, in addition to 95% recoverable and reusable, with 10% specifically for energy recovery.

The XJ, XF, XE, F-TYPE and F-PACE's innovative use of lightweight aluminium, which incorporates up to 50% recycled material from the manufacturing process of the body structures, provided considerable performance benefits. This includes improved fuel consumption and less CO₂ emissions associated with lighter structures as well as the dynamic performance inherent in its weight saving design.

Jaguar is committed to reducing dependency on fossil fuels, using fewer resources and creating less waste as part of our approach to sustainability excellence.

The company plan includes 25% reduction targets in operating and tailpipe CO₂ emissions, waste to landfill, logistics efficiencies (15%) and water consumption (10%), all based on per vehicle built since 2007. In addition the manufacturing assembly CO₂ emissions of each Jaguar built in the UK since 2009 is 100% offset. For each tonne of CO₂ emitted in the assembly process, Jaguar invests in projects that reduce an equivalent tonne of CO₂ elsewhere.

Taking into account the company's global sales growth and increased investment in more efficient operating facilities, we are proud to have delivered and in some cases exceeded our Environmental Innovation targets as planned for 2012.

And we are on track to meet our 25% reduction in joint European fleet average tailpipe CO₂ emissions by 2015. Looking forward, we have developed our 2020 vision for sustainable business growth that focuses on continued improvements in tailpipe CO₂ emissions, operational carbon neutrality and zero waste.

To date the company has offset over 6 million tonnes of CO₂, provided over 4,000 direct jobs in 60 emissions reductions projects in 17 countries and improved the lives of over 1 million people in our global cook stoves emissions reduction programme.

But it doesn't stop there. Our manufacturing facilities have been certified to ISO14001 since 1998 and we are credited to Platinum Plus level in the UK's Business in the Community Corporate Responsibility Index.

Meridian is the registered trademark of Meridian Audio Ltd.

AdBlue® is the registered trademark of the Verband der Automobilindustrie e. V. (VDA)

The Bluetooth® word mark and logos are owned by the Bluetooth SIG, Inc. and any use of such marks by Jaguar Land Rover Limited is under licence.

iPod, iPod touch and iPad are trademarks of Apple Inc, registered in the US and other countries.

The Navigation system must always be used in conditions that will not affect the driver's ability to drive safely or affect the safety of other road users.

VEHICLE SHOWN FRONT COVER: XJ R-SPORT LONG WHEELBASE IN ULTIMATE BLACK WITH OPTIONAL CLEAR GLASS
VEHICLE SHOWN BACK COVER: XJ PORTFOLIO LONG WHEELBASE IN QUARTZITE

Jaguar Land Rover Limited
Registered Office: Abbey Road, Whitley,
Coventry, CV3 4LF, United Kingdom
Registered in England Number: 1672070
jaguar.com



October 2015/16MY
JLM/24/02/07/1015

