

JAGUAR F-TYPE



THE ART OF PERFORMANCE





BY APPOINTMENT TO
HM THE QUEEN
MANUFACTURERS OF
MOTOR VEHICLES
JAGUAR LAND ROVER LIMITED
COVENTRY



BY APPOINTMENT TO
HRH THE DUKE OF EDINBURGH
MANUFACTURERS OF
MOTOR VEHICLES
JAGUAR LAND ROVER LIMITED
COVENTRY



BY APPOINTMENT TO
HRH THE PRINCE OF WALES
MANUFACTURERS OF
MOTOR VEHICLES
JAGUAR LAND ROVER LIMITED
COVENTRY



JAGUAR

THE ART OF PERFORMANCE

Every day we push performance to its limit. Our performance. Our cars' performance.
We innovate, we engineer, we design. We master rules and then break them.
Only to push further. Past the limits of convention. This is when performance becomes art.

Jaguar. The Art of Performance.



CONTENTS

INTRODUCTION

The Concept of F-TYPE	06
F-TYPE - The Facts	08

DESIGN

Exterior Principles	10
Exterior Detail	12
Interior	15
Interior Technology	17
Luggage Space	18

PERFORMANCE

Engines	20
Automatic Transmission	24
Manual Transmission	25
Advanced Aerodynamics	27
Lightweight Aluminium Architecture	28
Chassis and Suspension	30
Tested to the Extreme	33

DRIVING TECHNOLOGY

Advanced Driving Dynamics	34
Dynamic Mode	36
Advanced Drivetrain Technology	39
Torque Vectoring	41
Stability and Control	43
Performance Braking Systems	45

INFOTAINMENT

InControl Technologies	46
InControl Touch and InControl Touch Plus	47
InControl Features and Connected Features	49
Audio	50

SAFETY AND EFFICIENCY

Advanced Driver Assistance	52
Efficient Technologies	54

F-TYPE R

R	56
Performance	59
Interior	60

F-TYPE SVR

SVR	62
The Concept of SVR	65
Special Vehicle Operations	67
Aerodynamics	68
Lightweight Technologies	71
Interior	73

PERSONALISATION

F-TYPE - Your Choice	74
Choose your Engine	76
Choose your Model	78
Choose your Options	80
Choose your Colour	90
Choose your Wheels	92
Choose your Interior	94
Choose your Jaguar Accessories	108
Technical Specifications	112
Dimensions	114

JAGUAR WORLD

Jaguar Experience	116
The World of Jaguar	118
Glossary and Legal Information	120



Scan to find out more about F-TYPE

VEHICLE SHOWN: F-TYPE S IN CALDERA RED WITH OPTIONAL EXTRAS (MARKET DEPENDENT)

INTRODUCTION

THE CONCEPT OF F-TYPE

F-TYPE is the latest in a distinguished bloodline of powerful, agile and utterly distinctive cars. It looks, feels and drives like a true Jaguar sports car. Coupé or Convertible, Rear Wheel or All Wheel Drive, manual or automatic, every F-TYPE showcases Jaguar's exhilarating performance, state-of-the-art handling and cutting-edge technology to deliver an unrivalled driver-focused experience.

Responsive supercharged engines. Lightweight aluminium body construction. Sophisticated suspension. InControl technologies to link you and your F-TYPE to the wider world. And options that include All Wheel Drive and Intelligent Driveline Dynamics for even greater performance capabilities, F-TYPE's advanced technologies keep you safe, connected and entertained.

The F-TYPE range offers sports cars that only Jaguar could create, and it now encompasses the most powerful production car Jaguar has ever unleashed: F-TYPE SVR. Featuring enhanced suspension, advanced aerodynamics, lightweight technologies and a recalibrated engine, F-TYPE SVR takes the F-TYPE range to exceptional new levels. In every F-TYPE, performance and art combine to deliver a car that is intensely Jaguar, a car that embodies the Art of Performance.

VEHICLE SHOWN: F-TYPE SVR IN FIRESAND WITH OPTIONAL EXTRAS (MARKET DEPENDENT)

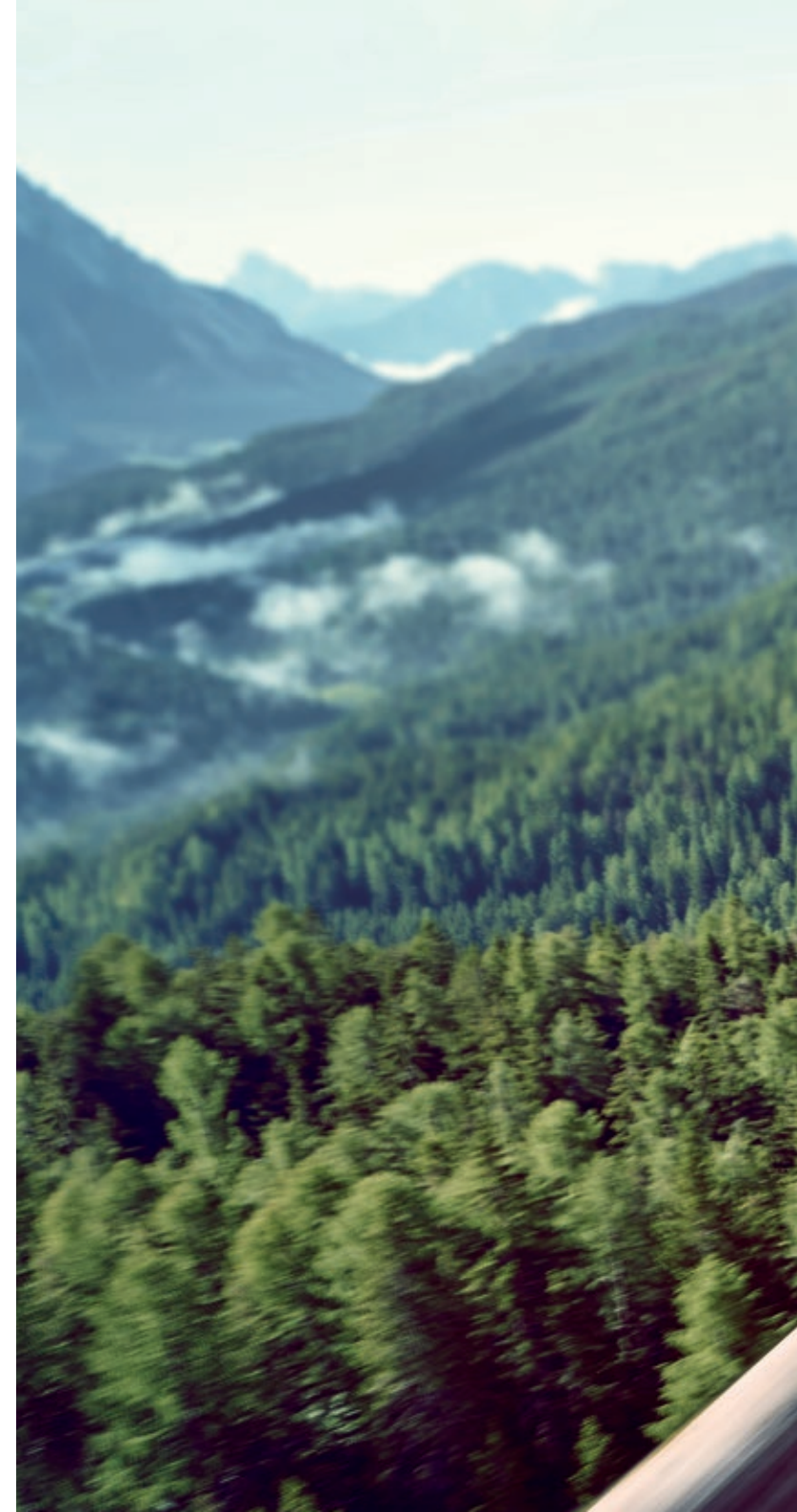



F-TYPE - THE FACTS

Stunning design, exhilarating performance, instant response, agile handling and advanced technology. F-TYPE is created to deliver breathtaking driving experiences.

JAGUAR CARE*

F-TYPE is now offered with a new unlimited mileage, three year warranty and three years' servicing programme at no additional cost. We call this programme Jaguar Care. It makes F-TYPE's overall cost of ownership one of the lowest in its class.



*Available in selected European markets only

VEHICLE SHOWN: F-TYPE R AWD IN STORM GREY WITH OPTIONAL EXTRAS (MARKET DEPENDENT)

ALL WHEEL DRIVE

F-TYPE's All Wheel Drive uses Intelligent Driveline Dynamics software to adapt to conditions, ensuring correct levels of front-to-rear torque when needed. The system preserves Jaguar's legendary handling while maximising traction and efficiency.

TECHNOLOGY

F-TYPE is as connected to the world as it is to the road. Our suite of InControl infotainment technologies ensure that your personal devices can be seamlessly integrated with your car so you are conveniently up-to-date and in touch at all times. The InControl system also allows you to remotely monitor your F-TYPE via your smartphone.

HANDLING AND AGILITY

To optimise F-TYPE's handling and agility, a range of driving technologies are available. These include Torque Vectoring, Adaptive Dynamics and an Electronic Active Differential. Each one works to enhance the driving experience through increased control, traction and feel.

DESIGN

The beauty of its lines, the purity of its form – the design of F-TYPE is a joy to behold. Coupé and Convertible bodystyles are available. Each has its own unique character, but both offer the thrills of F-TYPE performance and handling.

SUPERCHARGED PERFORMANCE

All F-TYPE engines use a twin vortex supercharger to eliminate acceleration lag. Throttle response is instantaneous with seamless power delivery and high levels of torque at all engine speeds. The latest engine to use this technology is the V8 unit found in F-TYPE SVR which makes it Jaguar's most powerful production car ever.



ADVANCED BRAKING

Power demands control – it's why we offer a number of braking systems across the F-TYPE range to match each car's performance. All deliver confident, progressive feel and consistent response. Carbon Ceramic Brakes offer up to 21kg of weight saving and sustained performance in demanding conditions.

CHOICE OF TRANSMISSIONS

The F-TYPE range offers a lightning-fast automatic transmission, with fingertip paddleshift control. It is intelligent and adaptive to exploit F-TYPE's power. A lightweight manual transmission is also available for a more involving drive.

DESIGN EXTERIOR PRINCIPLES

AWARD-WINNING DESIGN

F-TYPE is a true performance car. Its powerful shape, proportions and style have earned international acclaim as the 2013 World Car Awards' Design of the Year.

"A piece of design should tell a story. F-TYPE's lines have a start, a direction and a conclusion. Make every line individual and aesthetically correct, with the right dimensions, and it will stand the test of time."

Ian Callum, Jaguar Design Director

VEHICLE SHOWN: F-TYPE S AWD IN BLACK BERRY WITH OPTIONAL EXTRAS (MARKET DEPENDENT)

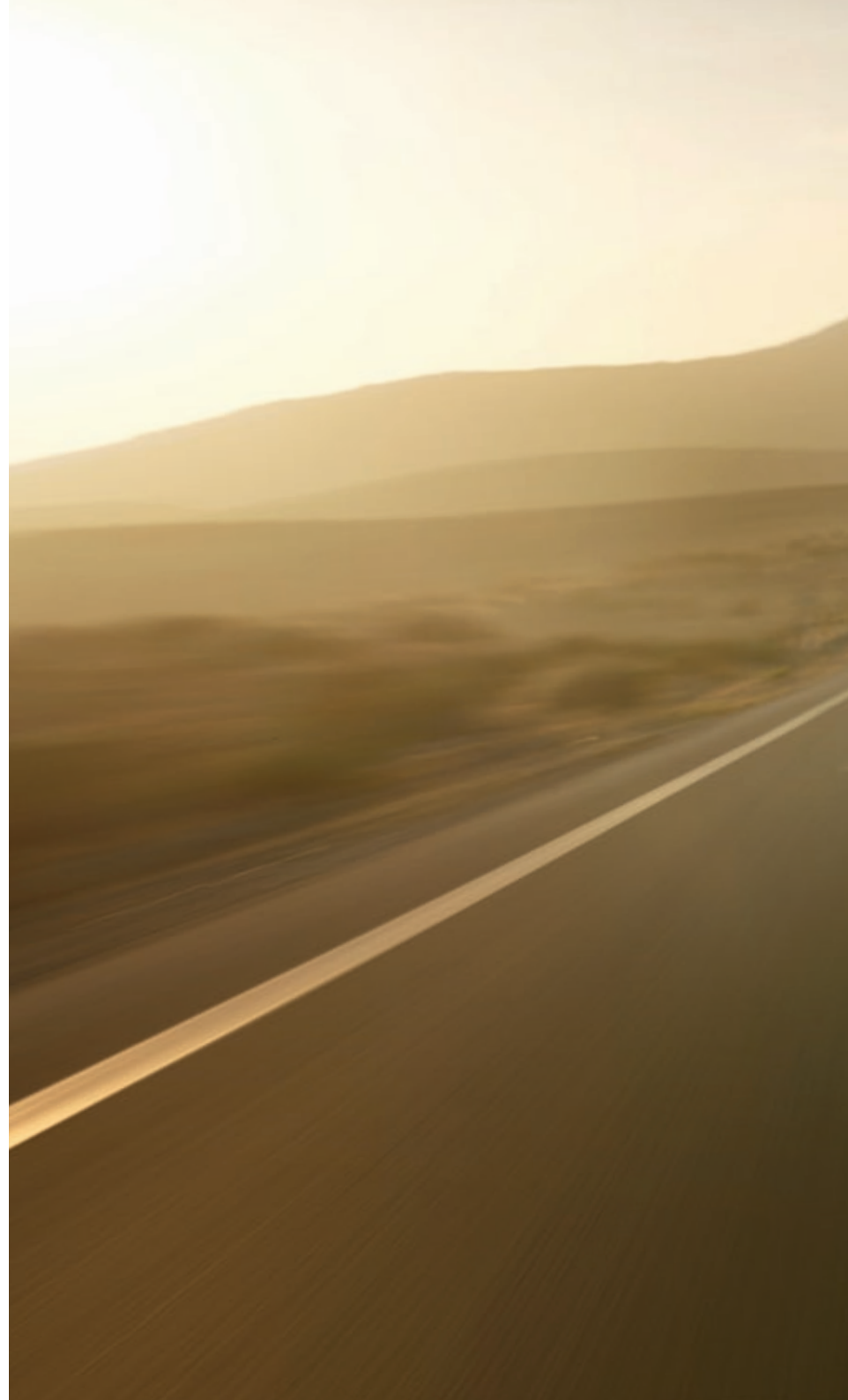



EXTERIOR DETAIL

POWERFUL FORM

Rising vertically from the front spoiler and running up through elongated headlights, F-TYPE's beautifully flowing body line begins to take shape. The line arcs over the front wheel, descending elegantly as it runs across the door, before culminating in a pronounced muscular rear haunch. F-TYPE leaves you under no illusion that this is a high performance sports car - the latest in a distinguished bloodline.

It is, in part, sculpted by the wind itself, formed by Jaguar's state-of-the-art Computational Fluid Dynamics design methods. A front splitter beneath the grille and rear venturi manage airflow along the underside, while a deployable rear spoiler automatically rises at higher speeds to increase downforce and reduce drag. Even the door handles retract when not required, their flush design creating an uninterrupted air flow along F-TYPE's flanks.

VEHICLE SHOWN: F-TYPE S IN AMMONITE WITH OPTIONAL EXTRAS (MARKET DEPENDENT)

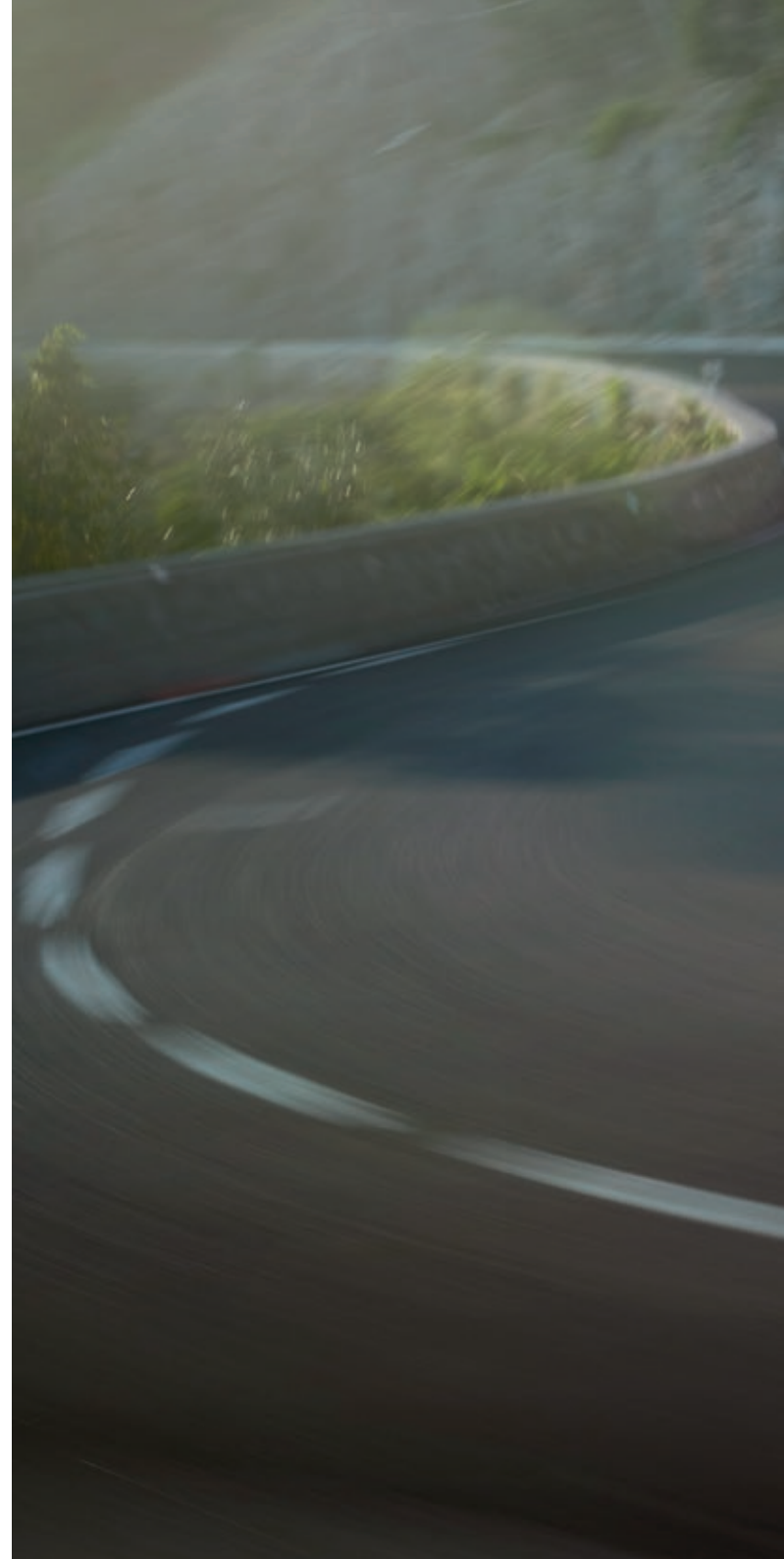





INTERIOR



CONNECTING DRIVER AND MACHINE

SUPERIOR CRAFTSMANSHIP

In F-TYPE you and the car become one. Every aspect of its 1+1 configuration is designed to create a bond. It wraps around you, taking your driving experience to greater heights.

The cockpit provides maximum visibility, minimal distractions and close-to-the-centre-of-gravity seating for a complete connection with the car. The low fascia is free from clutter to increase the view ahead. The Active Central Air Vent, part of the advanced climate control system, hides the twin central air vents, which automatically rise from the dashboard as required and retract after use.

Choose standard Sport seats or the optional Performance seats, which are upholstered in Premium Leather and offer enhanced lateral support during dynamic driving. Sport seats can also be specified with the optional Premium Leather interior. This finishes the seats, upper fascia, centre console and door casings in Premium Leather. Premium Leather interior with twin needle stitching and Performance seats are standard on F-TYPE R and F-TYPE SVR. F-TYPE SVR is also exclusively available with Quilted Leather.

VEHICLE SHOWN: F-TYPE S FEATURING CIRRUS PREMIUM LEATHER PERFORMANCE SEATS WITH JET CONTRAST STITCH WITH OPTIONAL EXTRAS (MARKET DEPENDENT)



INTERIOR TECHNOLOGY



PERFECTLY POSITIONED

FAST AND INTUITIVE

F-TYPE keeps things simple so you can concentrate on enjoying the drive. It presents information only as necessary or when requested. Simple, clear and easy to read instruments feature two large analogue dials - essential in any sports car.

The three-spoke steering wheel incorporates key controls for ease of use. On models fitted with the Quickshift eight-speed automatic gearbox, gearshift paddles mounted behind the spokes give manual control so you don't have to take your hands off the wheel. The SportShift Selector is simple and intuitive, offering full Auto mode and manual operation in Sports mode.

You can select gears sequentially by tipping the lever forward to shift down a ratio or shift up a gear by pulling the lever back.

F-TYPE's 8-inch colour Touchscreen is your single interaction point with the InControl infotainment system. This gives you direct control over navigation, music, phone, climate and many additional driver support systems including parking aids. InControl can be enhanced by its connectivity package, InControl Remote, its security package, InControl Secure, or by adding InControl Apps which enables you to control compatible apps on your Touchscreen.

Dual Mode Rotary Switches control elements of the advanced climate control system. Right and left dials control cockpit temperature on each side of the car when dual zone climate control is specified. These dials also control the optional seat heating functions.

VEHICLE SHOWN: F-TYPE S FEATURING CIRRUS PREMIUM LEATHER PERFORMANCE SEATS WITH JET CONTRAST STITCH WITH OPTIONAL EXTRAS (MARKET DEPENDENT)

LUGGAGE SPACE

 **408 LITRES** | **OPTIONAL POWERED TAILGATE***

F-TYPE Coupé is large enough to take a full set of luggage or two sets of golf clubs, with up to 408 litres of capacity. For ease of access the tailgate can be opened or closed at the touch of a button with the optional powered function.

*Option only available on Coupé derivatives.

VEHICLE SHOWN: F-TYPE S IN BLACK BERRY WITH OPTIONAL EXTRAS (MARKET DEPENDENT)



KBS 257

F-TYPE

PERFORMANCE ENGINES



SUPERCHARGED ENGINES

RESPONSIVE POWER

F-TYPE's beating heart is supercharged - delivering high levels of torque at all engine speeds, so there's no delay between the driver's demand for power and the engine's response. When cruising the engine thrums subtly, hinting at F-TYPE's latent potential. Tap the accelerator and the engine growls with the promise of more power. As the revs rise the Active Sports Exhaust builds to a race-car inspired crescendo.

The Active Sports Exhaust is standard on F-TYPE and F-TYPE S. Active bypass valves allow exhaust gases to exit more directly, delivering a deeper, more dramatic sound. F-TYPE R has a Switchable Active Exhaust allowing manual control of the system, for even greater driver involvement. SVR's Switchable Active Exhaust is made from Titanium and Inconel®, resulting in a 16kg weight saving and a supercar soundtrack.



START

ENGINE

STOP

ENGINES

F-TYPE offers two highly advanced engines with two power outputs each: 3.0 V6 340PS, 3.0 V6 380PS, 5.0 V8 550PS and 5.0 V8 575PS. Each features a Roots-type twin vortex supercharger that maintains the engine's compact dimensions. To improve fuel economy, particularly during urban driving, a fast-reacting Intelligent Stop/Start* system is fitted to every F-TYPE as standard.

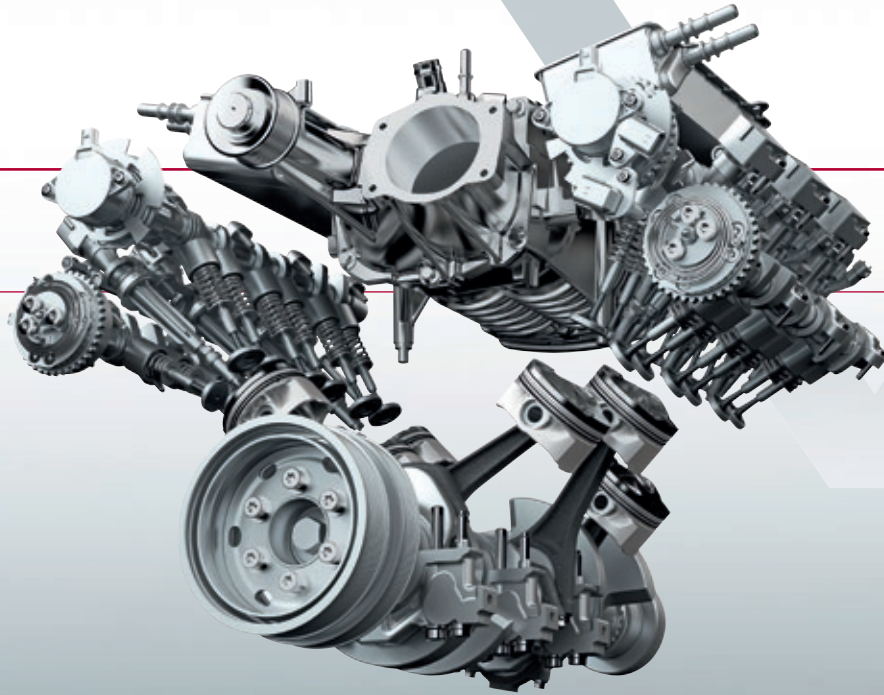

V6 ENGINES

0-100km/h from 4.9 seconds

Powerful and refined, for a thrilling and rewarding drive. The compact supercharger's sophisticated boost control and secondary throttle valve give you a burst of power when you accelerate, with no lag. The water-cooled intercooler reduces air intake temperature for more power and efficiency. Power is smoothed and refined by innovative counter-rotating front and rear balancer weights. F-TYPE's 3.0 V6 340PS engine achieves 450Nm of torque and acceleration is 0-100km/h in 5.3 seconds. The V6 engine in F-TYPE S has been modified to achieve a higher power output of 380PS and 460Nm of torque for even more potent performance. Acceleration is 0-100km/h in 4.9 seconds.

*Market dependent.
Official EU test figures for comparison purposes only. Real world figures may differ.

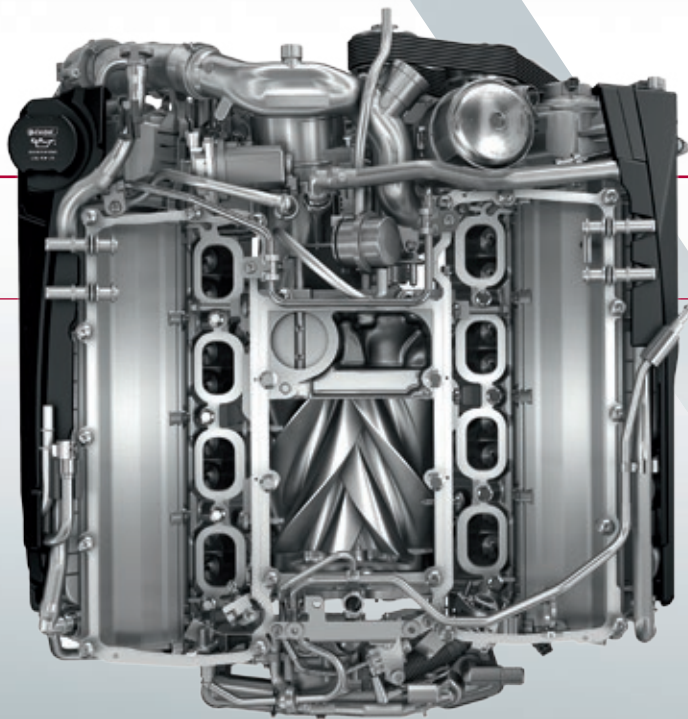

V8 ENGINES

0-100km/h from 3.7 seconds

Lightweight and powerful, this engine features a die-cast aluminium block to reduce weight. Dual independent variable cam timing optimises power at any speed. Cleaner, more efficient combustion is achieved by spray-guided direct injection of precisely measured quantities of fuel directly into the centre of the combustion chamber. F-TYPE R's 5.0 V8 delivers up to 550PS and with an impressive 680Nm of torque. Acceleration is 0-100km/h in 4.2 seconds. F-TYPE SVR's 5.0 V8 engine is the pinnacle of power, recalibrated to deliver up to an astonishing 575PS and 700Nm of torque. Acceleration is 0-100km/h in 3.7 seconds.

AUTOMATIC TRANSMISSION

EIGHT-SPEED AUTOMATIC GEARBOX

Our eight-speed Quickshift automatic gearbox offers an unequalled blend of lightning-fast changes and superb refinement. Available on every F-TYPE, its eight closely-spaced ratios keep the engine within its most effective rev range for longer. The transmission control system is intelligent and adaptive. It monitors the driving situation together with the demands the driver is making on the car, and responds to provide a truly dynamic experience. Adaptive software automatically modifies the gearshift strategy, ensuring the right gear is selected for every situation.

You can also take full manual control with the gearshift paddles mounted behind the steering wheel, or the joystick-style SportShift selector. Dynamic Launch Mode is standard on F-TYPE S. It ensures maximum torque through every gear change, for optimum acceleration from 0-100km/h.



MANUAL TRANSMISSION

SIX-SPEED MANUAL TRANSMISSION

There's nothing more thrilling than changing gear manually in a sports car. Our lightweight six-speed manual gearbox provides that thrill. Designed for the high-revving V6 and rear-wheel drive (RWD) configuration, it's the perfect choice for sports car purists. The precision-engineered short-throw gear lever delivers snappy changes. The close ratio, six-speed manual gearbox enables the driver to keep the engine within its optimum rev range for longer. The pedals are perfectly placed for heel-and-toe changes, defining the definitive Jaguar sports car experience. Available on F-TYPE and F-TYPE S.





ADVANCED AERODYNAMICS



DEPLOYABLE REAR SPOILER

LOW DRAG AND HIGH STABILITY

Aerodynamic performance is at the heart of F-TYPE's design. It is seamlessly integrated into the body for low levels of lift and excellent stability at high speed. Even the door handles retract to create an uninterrupted airflow along its flanks. The deployable rear spoiler rises at higher speeds to reduce lift by up to 120kg. A front splitter beneath the grille manages airflow along the vehicle's underside, with the sharply defined tail helping to separate air cleanly at lower speeds. The result is improved handling and stability.

VEHICLE SHOWN: F-TYPE S IN RHODIUM SILVER WITH OPTIONAL EXTRAS (MARKET DEPENDENT)

LIGHTWEIGHT ALUMINIUM ARCHITECTURE



STRONG AND RIGID

HIGH POWER-TO-WEIGHT AND TORQUE-TO-WEIGHT RATIOS



A lightweight aluminium body with a strong, stiff structure is the perfect platform for a sports car. We pioneered this technology over a decade ago and continue to push the boundaries today. It informs every aspect of how F-TYPE performs, handles and feels. A strong, stiff structure provides an inherently stable platform for precise, agile handling and allows the finely-tuned suspension system to deliver connectivity and driver feedback. Lightweight aluminium panels are bonded together with a super-strong adhesive, then punched with zinc-coated, boron steel rivets that compress the adhesive to form an airtight bond for phenomenal strength and rigidity. F-TYPE's body is the perfect complement to its high-performance engine range. Together they produce the exceptional power-to-weight and torque-to-weight ratios that deliver the real world measures of performance in a sports car.

The exterior panels are made from specially developed alloys. They combine robustness with greater formability, which gives clarity and tightness to curves and feature lines. On Coupé models, the side pressing is one of the most technically advanced in the automotive industry. It allows for cleaner lines with an extraordinarily beautiful, uninterrupted sweep from the front pillar to the trailing edge. This combination of advanced materials and innovative techniques has two advantages. It allows us to reproduce F-TYPE's crisp, crafted lines exactly as the designers intended. And it delivers a vehicle with extraordinary structural integrity.



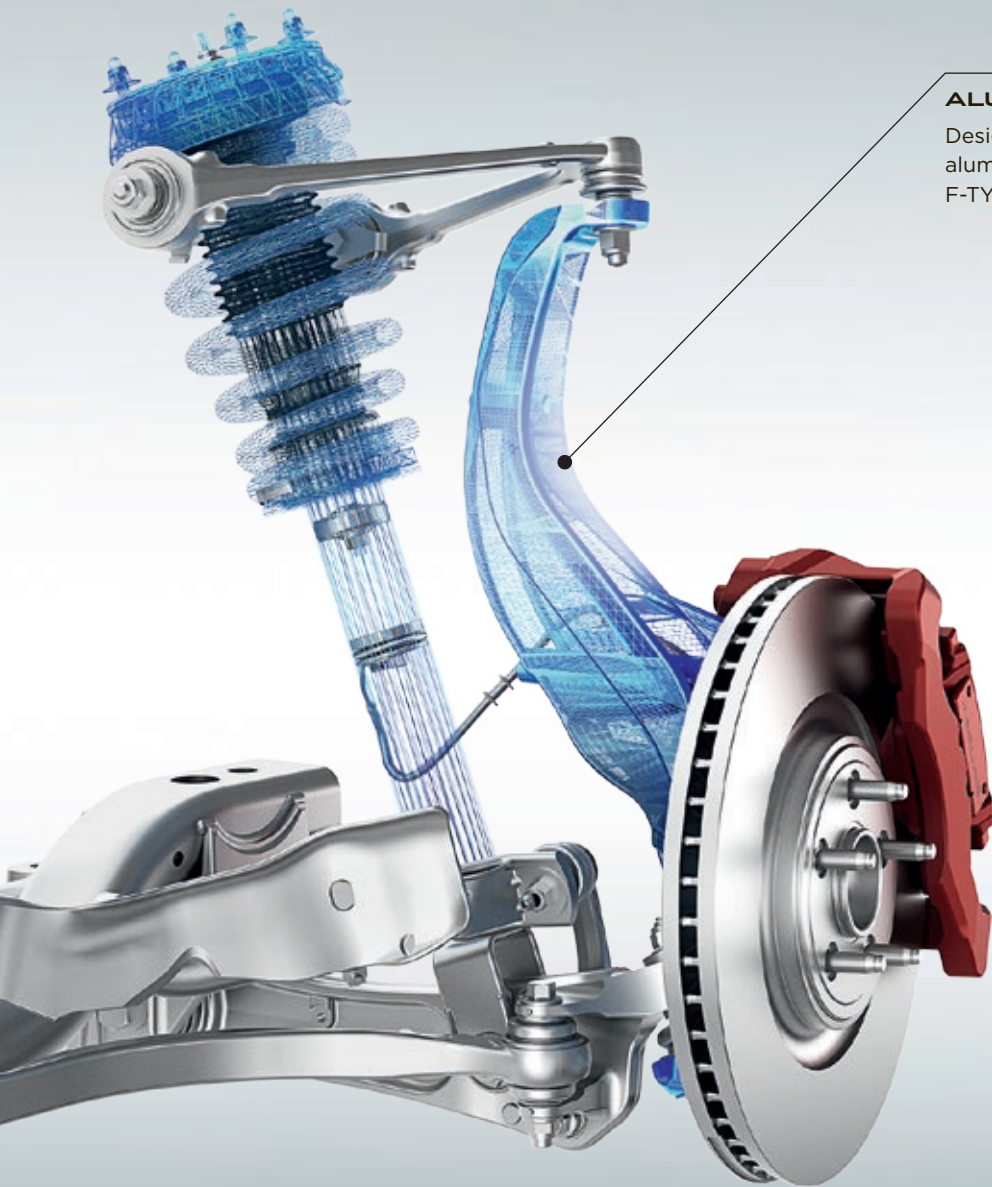

ALUMINIUM SUSPENSION KNUCKLES

Designed to optimise stiffness and strength, the lightweight aluminium front and rear suspension knuckles help improve F-TYPE's agility and responsiveness.

CHASSIS AND SUSPENSION



COMFORT
AND CONTROL

DYNAMIC
AND REFINED

F-TYPE's aluminium body creates an immensely stable platform from which the forged aluminium double wishbone suspension can control the car. With the damping set-up optimised for the best partnership between dynamics and refinement, it gives the perfect combination of control, agility and feedback.

On F-TYPE S, F-TYPE R and F-TYPE SVR, Adaptive Damping assesses body motion and pitch rates 100 times per second, and adjusts the settings for each damper accordingly. The system enhances control, handling and agility. It also rapidly detects and reacts to critical driving conditions and driver demands. This is achieved with a series of sensors that are placed around the car to monitor the body's vertical movement, pitch and roll rates. The steering wheel position is measured 500 times a second enabling the system to predict the car's movements. The stiffness of each individual damper is then adjusted to help maintain body control, stability and agility.

ADAPTIVE DAMPING

Standard on F-TYPE S, F-TYPE R and F-TYPE SVR, the Adaptive Dynamics system delivers both precise dynamics and a supple, luxurious ride by monitoring wheel position and body movements. The system constantly monitors conditions and adjusts the dampers to provide the optimum balance between comfort and refinement at all times.

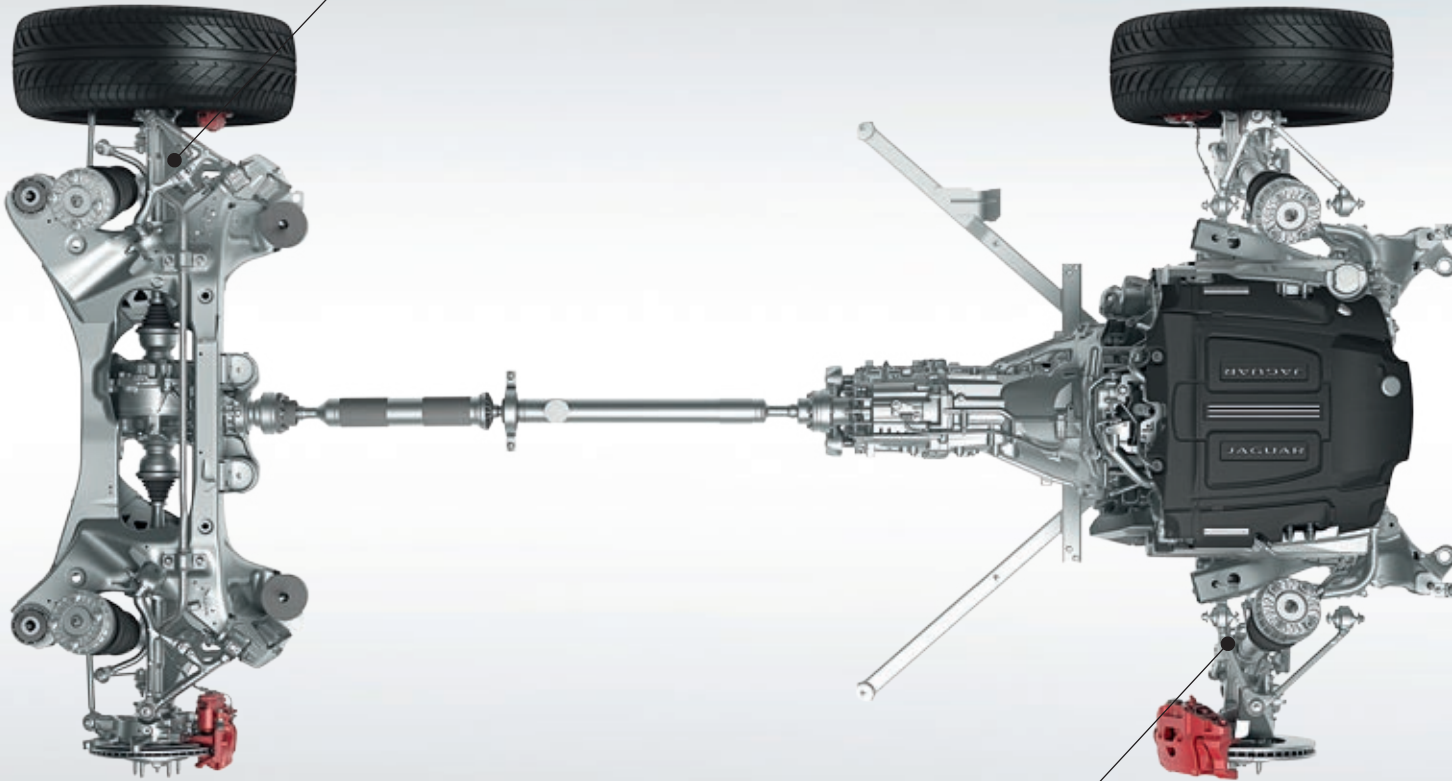

CHASSIS

Considered by Jaguar as the best configuration for a suspension system, F-TYPE's forged aluminium double wishbone design offers precise handling and control.

1,413 LITRES

OF RECYCLED WATER PER MINUTE
BLASTED AT EVERY CAR TO ENSURE F-TYPE
IS MONSOON PROOF

10,000,000 HOURS

OF VIRTUAL TESTING, REDUCING OUR IMPACT ON THE
ENVIRONMENT WITH SIGNIFICANT SAVINGS IN RESOURCE,
WASTE, POWER AND FUEL

792,000

VIRTUAL VEHICLES CREATED
TO PERFECT F-TYPE

12,000 MILES

OF EXTREME TRACK TESTING ON GERMANY'S
INFAMOUS NÜRBURGRING RACE TRACK -
EQUIVALENT TO DRIVING HALF WAY AROUND THE WORLD



90°C

DIFFERENCE BETWEEN F-TYPE'S HOTTEST
(+50°C) AND COLDEST (-40°C) EXTREME CLIMATE
TESTING ENVIRONMENTS

300 TERABYTES

OF PERFORMANCE DATA GATHERED TO REFINE
EVERY MILLIMETRE OF F-TYPE

TESTED TO THE EXTREME



VIRTUAL
ANALYSIS

REAL WORLD
TRIALS

F-TYPE first took to the road in the virtual world of Jaguar's Computer Aided Engineering (CAE) systems ensuring that all components underwent extensive development and testing before being committed to the physical testing process. Engineers produced a series of virtual prototypes to realistically simulate the behaviour of complex mechanical systems allowing them to analyse multiple variations until the optimum design was achieved. For example, using a technique first used in the aerospace industry, aerodynamic testing took place in a virtual wind tunnel with Computational Fluid Dynamics running on high speed supercomputers. During its virtual life, F-TYPE completed half a million analyses, requiring 10 million computer processor hours and creating 300TB of data. The CAE development process was one of the key contributing factors in delivering F-TYPE's exhilarating performance and responsiveness.

The real world testing to fine tune the set-up took place in specialist facilities and the harshest environments across the globe in temperatures ranging from -40°C to +50°C, and at altitudes of up to 4,000m. High-speed stability tests, for example, were conducted at Nardo in southern Italy. The Nordschleife circuit at the Nürburgring in Germany was the perfect location to prove out handling, braking, cooling and durability. Known as the "Green Hell", and featuring 20.8 kilometres of track with 73 turns, it is renowned as the most demanding circuit in the world and the ultimate test of both car and driver.

VEHICLE SHOWN: F-TYPE S IN RHODIUM SILVER WITH OPTIONAL EXTRAS (MARKET DEPENDENT)

DRIVING TECHNOLOGY

ADVANCED DRIVING DYNAMICS



MAXIMISING AGILITY

CONTINUOUSLY ADAPTING

Dynamic Mode revises the car's software to further enhance F-TYPE's sporting character. It sharpens the throttle response, increases steering weighting and performs gearshifts more quickly* and at higher engine speeds. It also brings visual drama to the driver as the instrument cluster takes on a red glow. Dynamic Mode enhances your connection with F-TYPE's inherent Jaguar performance.

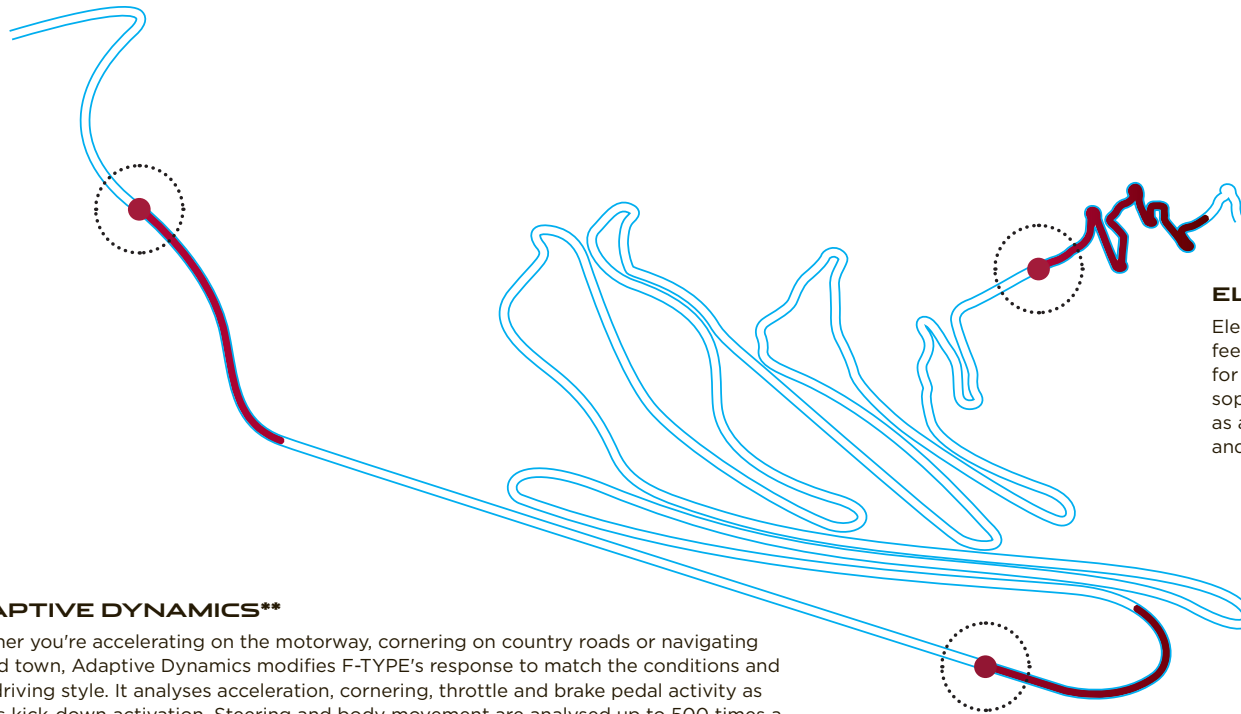

ADAPTIVE DYNAMICS**

Whether you're accelerating on the motorway, cornering on country roads or navigating around town, Adaptive Dynamics modifies F-TYPE's response to match the conditions and your driving style. It analyses acceleration, cornering, throttle and brake pedal activity as well as kick-down activation. Steering and body movement are analysed up to 500 times a second. Electronically controlled dampers then constantly adjust to optimise the suspension settings and maintain F-TYPE's dynamism and comfort.

ELECTRIC POWER ASSISTED STEERING

Electric Power Assisted Steering (EPAS) offers outstanding feedback, control and it is active on demand - saving power for where you really need it, as well as saving fuel. EPAS' sophisticated computer management varies steering assistance as appropriate - increasing assistance for low speed manoeuvring and improving feel at higher speeds.

CONFIGURABLE DYNAMICS**

The Configurable Dynamics system allows you to set up F-TYPE's dynamics for throttle mapping, gearbox shift points*, steering and configuring the damper settings to suit your performance driving needs.

*Automatic transmission only.

**Standard on F-TYPE S, F-TYPE R and F-TYPE SVR.





DYNAMIC MODE

CONFIGURABLE DYNAMICS | **QUICKER GEARSHIFTS**

Engaging Dynamic Mode through the toggle switch sharpens throttle response, increases steering weighting and performs gearshifts faster at higher engine speeds. Dynamic Mode also prevents automatic upshifts when you're driving in Manual Mode*.

F-TYPE S, F-TYPE R and F-TYPE SVR feature our Configurable Dynamics system. This lets you define which characteristics are altered in Dynamic Mode. This option also features the Dynamic-i system which can display G-Force and lap time as well as throttle, steering and brake inputs on the 8-inch Touchscreen.



*Automatic transmissions only.



DRY ROAD CONDITIONS

In normal conditions virtually all torque is distributed to the rear wheels, delivering legendary Jaguar agility and handling.

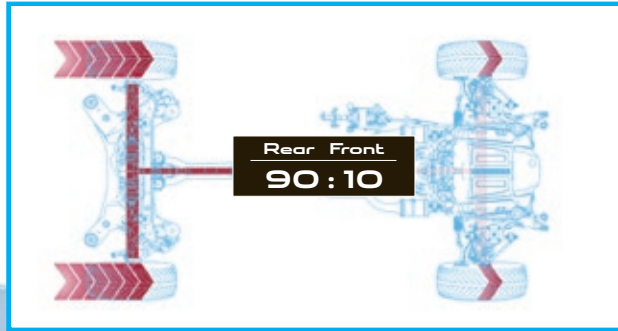

LOW TRACTION CONDITIONS

On slippery surfaces, such as grass and mud, torque can be balanced 50:50 between the front and rear wheels to maximise traction.

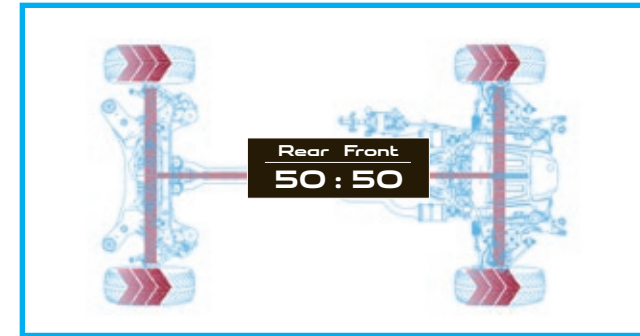

VARIABLE ROAD CONDITIONS

In very extreme conditions, over 90 percent of engine torque can be distributed from the rear wheels to the front wheels to provide optimum grip.

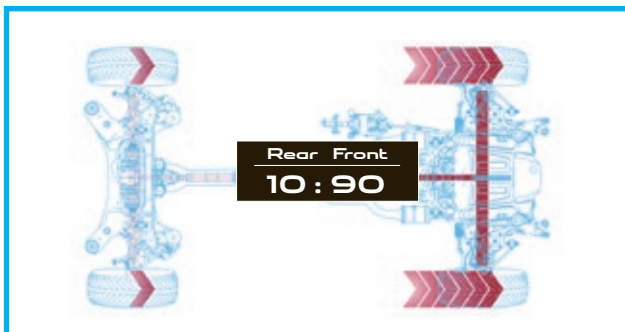

ADVANCED DRIVETRAIN TECHNOLOGY

> ALL WHEEL DRIVE

F-TYPE's All Wheel Drive (AWD) system delivers confident handling on all surfaces. Available with Quickshift automatic transmissions, it makes F-TYPE S AWD, F-TYPE R AWD and F-TYPE SVR the most capable of sports cars.

Class-leading drivetrain technology offers a reduction in weight and an increase in efficiency compared to previous generation systems. The unique Intelligent Driveline Dynamics software features sophisticated algorithms that react intelligently to road conditions for traction on demand. As well as offering a smoother, safer drive, it also uses less fuel and has lower emissions than permanent AWD. Predictive, as well as reactive, the system helps prevent you from losing traction instead of working to regain it.

AWD also offers distinct characteristics between F-TYPE's driver-selected modes. Dynamic Mode delivers a more energetic driving experience, with the added assurance of AWD stability. The Rain/Ice/Snow Mode improves control in poor conditions. The result is phenomenal cornering capabilities, providing outstanding levels of performance and control, whatever the road throws at you.



BRAKE PRESSURE
APPLIED TO INSIDE
REAR WHEEL

MORE POWER
DISTRIBUTED TO
OUTER REAR WHEEL

ADDITIONAL ROTATIONAL
FORCE APPLIED AROUND
VEHICLE'S AXIS

TORQUE VECTORING



INCREASED STEERING
PERFORMANCE

ENHANCED
CORNERING CAPABILITY

F-TYPE's Torque Vectoring maximises capability through even the tightest corners. Torque Vectoring technology provides controlled independent braking of the individual, inside front and rear wheels to add to the turning forces acting on the car. In most conditions more braking pressure is applied to the rear inside wheel as this supports the most increased cornering capability, while the front inside wheel is braked for greater effectiveness and refinement. The result is reduced understeer for sharper turning and more consistent road holding. Torque Vectoring delivers increased agility and added driver confidence.

On F-TYPE R and F-TYPE SVR, Torque Vectoring works together with the Electronic Active Differential system, complementing each other to optimise traction and cornering ability as well as maximising steering feel and agility.

VEHICLE SHOWN: F-TYPE R IN POLARIS WHITE WITH OPTIONAL EXTRAS (MARKET DEPENDENT)



STABILITY AND CONTROL

> LOW CENTRE OF GRAVITY | **GREATER CONTROL AND TRACTION**

Jaguar's stability systems keep F-TYPE well-balanced whether you're driving enthusiastically or simply require the assurance of a car that will remain stable in challenging conditions.

Optimum Weight Distribution: F-TYPE's low centre of gravity reduces body roll in corners, while short front and rear overhangs concentrate mass within the wheel base. Meticulous attention to detail in the design and construction has put the battery, electronic systems, and even the washer bottle, at the rear to give perfect balance. All these factors combine to ensure that F-TYPE is inherently agile and a real pleasure to drive.

Electronic Active Differential: On F-TYPE R and F-TYPE SVR, the Electronic Active Differential works with the stability, traction and ABS systems to manage torque delivery to each of the rear wheels. Full electronic control of the rear differential lock lets the system apply full locking torque almost instantaneously. On AWD models, the Intelligent Driveline Dynamics (IDD) system works together with the Electronic Active Differential. It helps increase traction and stability, giving full rein to F-TYPE R and F-TYPE SVR's towering performance.

MASS MOMENT OF INERTIA

The closer the weight is to the centre of the car, the easier it is to turn

$$I = \sum_{i=1}^N m_i r_i^2$$

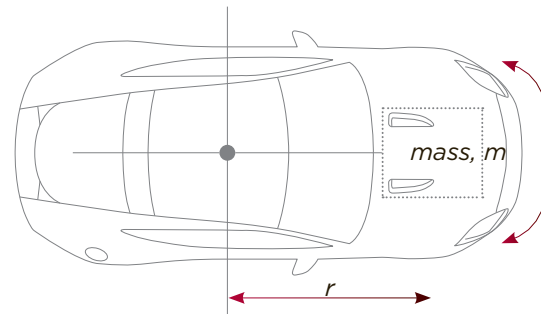

VEHICLE SHOWN: F-TYPE R IN POLARIS WHITE WITH OPTIONAL EXTRAS (MARKET DEPENDENT)



JAGUAR
CARBON CERAMIC

PERFORMANCE BRAKING SYSTEMS

➤ LIGHTWEIGHT | POWERFUL | RELIABLE

A range of braking systems are available, each one engineered to deliver a confident, progressive feel and consistent high performance. The calipers use aluminium to reduce the unsprung mass of the car, benefiting both handling and ride refinement. Each system features large, ventilated brake discs – up to 398mm in diameter on the Carbon Ceramic system. This large swept area improves braking force as well as providing greater capacity for the discs to absorb and dissipate the heat energy generated during braking.

Jaguar's Carbon Ceramic Braking system, with its striking yellow monobloc calipers, is optional on F-TYPE S, F-TYPE R and F-TYPE SVR. The most powerful braking system ever fitted to a Jaguar road car, it offers up to 21kg of weight saving, further reducing unsprung mass. With greater resistance to fade and wear it delivers high levels of sustained performance in the most demanding conditions.



*Jaguar Super Performance Brakes available as an option on F-TYPE and F-TYPE S.
 **Carbon Ceramic Brakes available as an option on F-TYPE S automatic models, F-TYPE R and F-TYPE SVR.

INFOTAINMENT INCONTROL TECHNOLOGIES

 INCONTROL TOUCH | INCONTROL TOUCH PLUS

InControl is our suite of advanced technologies that links both you and your F-TYPE to the wider world. Choose from two InControl Infotainment systems*: InControl Touch, available as standard, or for upgraded audio options, InControl Touch Plus.

*As we systematically introduce InControl, specific features, options and its availability remain market dependent.



INCONTROL TOUCH



STANDARD ON EVERY F-TYPE

8 inch Touchscreen
 5 inch instrument panel display with analogue dials
 Jaguar Sound System (180W)
 FM Radio
 iPod, USB, Bluetooth and AUX connections



InControl Remote consists of SOS Emergency Call, Jaguar Optimised Assistance and the Jaguar Remote smartphone app



OPTIONAL

InControl Secure provides Stolen Vehicle Monitoring and notifications via your smartphone and the secure call centre

ADDITIONAL OPTIONS

Meridian Sound System (380W)
 InControl Touch Navigation
 DAB Radio



INCONTROL TOUCH PLUS



FOR UPGRADED AUDIO OPTIONS

8 inch Touchscreen
 5 inch instrument panel display with analogue dials
 Meridian Surround Sound System (770W)
 FM Radio
 iPod, USB, Bluetooth and AUX connections
 CD/DVD Drive



InControl Remote consists of SOS Emergency Call, Jaguar Optimised Assistance and the Jaguar Remote smartphone app



OPTIONAL

InControl Secure provides Stolen Vehicle Monitoring and notifications via your smartphone and the secure call centre

ADDITIONAL OPTIONS

InControl Touch Plus Navigation
 DAB Radio



INCONTROL FEATURES



ADVANCED INFOTAINMENT AS STANDARD

The InControl Touch and InControl Touch Plus multimedia systems are F-TYPE's hub for connectivity, control and entertainment. The key features are:

8-inch Touchscreen at the heart of the centre console. Clear graphical interface responds directly to touch for quick control.

Navigation guidance makes planning journeys and following routes easy, thanks to turn-by-turn voice guidance and junction view. 'Dead-reckoning' functionality can accurately position the vehicle even when GPS signals can no longer be received – perfect for city centres or driving through tunnels.

Bluetooth phone connectivity allows you to link and control your smartphone via InControl Touch either for phone calls or music playback - simple, easy and wire-free.

Access a world of music thanks to FM, DAB, Satellite and HD radio (subject to regional fitment), as well as iPod, USB and AUX connections.

Integrated text-to-voice technology reduces distraction by reading out incoming text messages. You can easily respond with short, prepared messages.*

Precise climate control is available via the Touchscreen. Adjust temperature levels, direction and intensity of airflow.



Explore InControl at jaguar.com/incontrol

*InControl Touch only. Requires compatible handset. Consult your local Jaguar Retailer for more details.

InControl is the very latest in in-car technology for Jaguar. As we systematically roll out InControl its availability remains market dependent.

**Market dependent.

Please consult your local Jaguar retailer for further details.

CONNECTED FEATURES



INCONTROL PACKAGES AND APPLICATIONS

Standard on all F-TYPE models, InControl Remote is a package of technologies and applications that takes your F-TYPE's connectivity to the next level.

SOS Emergency Call automatically sends your location to, and puts you in contact with, the emergency services if the airbags deploy following an accident.

Breakdown Call provides optimised assistance at the touch of a button. This feature puts you in contact with the recovery service and transmits key vehicle information, location, and certain diagnostics for a rapid response.

Remote App is a multi-function app that allows you to monitor as well as interact with your F-TYPE from your smartphone. It gives you vital information and statistics about your car, including its location and whether any doors and windows are open or unlocked. The app can start the engine to pre-condition the climate**, lock and unlock the car, locate your F-TYPE on a map or by using the beep and flash function.

Optional Features are available to further enhance your infotainment connectivity. These include:

InControl Secure** provides the ultimate in peace of mind by detecting any unauthorised movement of your F-TYPE. The app will alert you via your smartphone, whilst the secure call centre will liaise with the authorities to pinpoint the vehicles whereabouts.

InControl Apps** connects your smartphone with the Touchscreen in your vehicle, meaning you can stay safely connected to your smartphone even whilst in the car. InControl Apps enables you to control compatible apps on your Touchscreen, ensuring the safe and convenient use of apps that have been optimised specifically for use within your vehicle.

Simply download Jaguar InControl Apps to your smartphone. You can then connect your smartphone via a dedicated USB port to display compatible apps on the Touchscreen in the centre console.

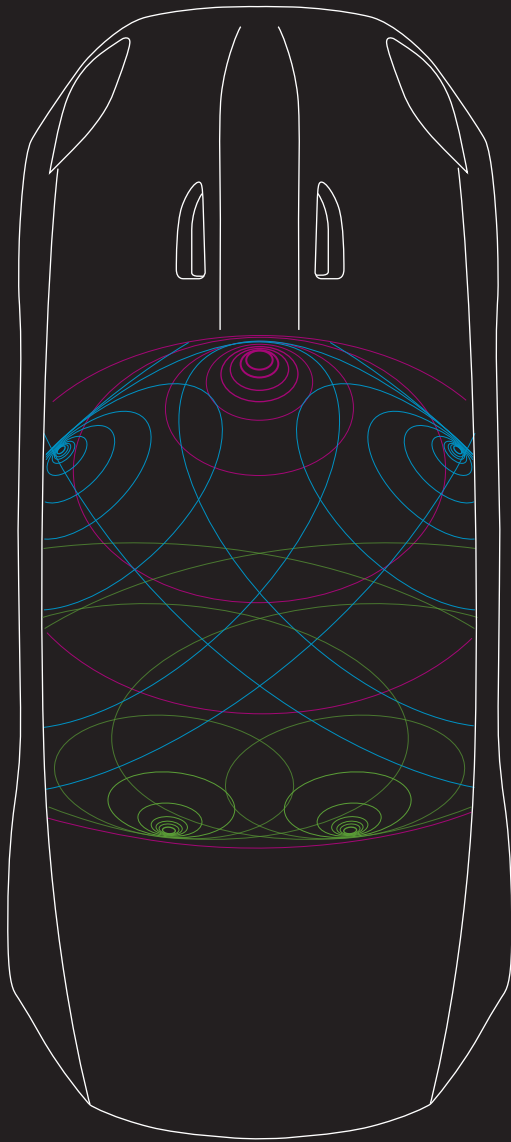

AUDIO



JAGUAR
SOUND SYSTEM

MERIDIAN SOUND AND
SURROUND SOUND SYSTEMS

Three superb sound systems bring F-TYPE's cockpit to life. The Jaguar Sound System adds depth and power to in-car entertainment with 6 speakers, 180W and 8 channels.

Working with British audio experts Meridian, we designed two higher specification systems specifically for F-TYPE. Digital Signal Processing (DSP) optimises Meridian's advanced Cabin Correction algorithm. This tailors the music to the unique acoustics of F-TYPE's interior. Dynamic Volume Control compensates for changes in sound levels, so you hear consistent sound through 10 speakers including 2 sub woofers, 380W and 12 channels.

The ultimate Meridian Surround Sound System for F-TYPE delivers 770W through 12 speakers. Using Meridian's exclusive Trifield technology it creates an authentic and consistent music experience.



-  Holographic Centre Image
-  Door Waves: Tweeter, Midrange and Bass
-  Surround Sound Waves

Diagram representative of Meridian 770W Surround Sound System.



MERIDIAN

SOUND SYSTEMS AVAILABLE IN CONJUNCTION WITH **INCONTROL TOUCH**

Standard



180
WATTS

6
SPEAKERS

8
AMPLIFIER CHANNELS

JAGUAR SOUND SYSTEM

180 watts
6 speakers
8 channel amplifier

Optional



380
WATTS

10
SPEAKERS

12
AMPLIFIER CHANNELS

MERIDIAN SOUND SYSTEM

Dynamic Volume Control
380 watts
10 speakers
12 channel class D DSP amplifier

SOUND SYSTEM AVAILABLE IN CONJUNCTION WITH **INCONTROL TOUCH PLUS**

Optional



770
WATTS

12
SPEAKERS

16
AMPLIFIER CHANNELS

MERIDIAN SURROUND SOUND SYSTEM

Dynamic Volume Control
770 watts
12 speakers
16 channel class D DSP amplifier
Audyssey MultEQ Audio Equalisation
7.1 Surround Sound
Meridian Trifield Technology

'Trifield' and the 'three fields' device are trademarks of Trifield Productions Ltd.
VEHICLE SHOWN: F-TYPE S IN CALDERA RED WITH OPTIONAL EXTRAS (MARKET DEPENDENT)

SAFETY AND EFFICIENCY

ADVANCED DRIVER ASSISTANCE

F-TYPE's advanced technology is designed to keep you safe and take the stress out of driving. It can help with everything from reducing the chance of a motorway collision to avoiding minor bumps in a car park. This range of advanced active and passive safety systems give you the reassurance, information and control to focus on the pleasure of the drive.



1 REVERSE TRAFFIC DETECTION

This optional system helps you reverse safely out of a parking space. Sensors detect approaching vehicles from either direction and warnings are audible and displayed on the Touchscreen.



2 CLOSING VEHICLE SENSING WITH BLIND SPOT MONITOR

Optional Closing Vehicle Sensing uses sophisticated sensors to help warn if faster moving vehicles are approaching from behind at a distance of up to approximately 60m. Blind Spot Monitoring is designed to provide an extra alert should the system detect a vehicle entering a pre-defined blind spot.



3 BI-FUNCTION HID XENON HEADLIGHTS

These deliver an intense white light for both main and dipped beam in a single unit for improved night vision.



4 ADAPTIVE FRONT LIGHTING

This optional system measures the speed of the car and angle of the steering wheel, swivelling the headlights by up to 14 degrees out and up to 7 degrees in, for improved visibility during cornering.

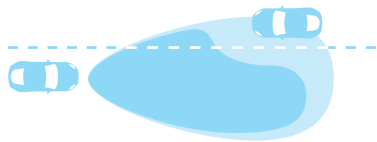

5 INTELLIGENT HIGH BEAM

The optional Intelligent High Beam system automatically switches between low and high beam when necessary, using a sensor mounted at the front of the rear view mirror.



6 LED REAR LIGHTS

LED technology creates the distinctive design of F-TYPE's rear lights. They illuminate to full brightness faster than conventional bulbs, giving drivers behind you more time to react.



7 PEDESTRIAN CONTACT SENSING SYSTEM

Help protect the people outside your car as well as those inside. If the car makes contact with a pedestrian, our industry-leading Pedestrian Contact Sensing System is designed to automatically raise the bonnet to help cushion a potential impact.



8 EMERGENCY BRAKE ASSIST

If the brakes are applied rapidly, this system boosts braking force to the maximum for shorter stopping distances. It can also help retain greater steering control in unexpected situations.

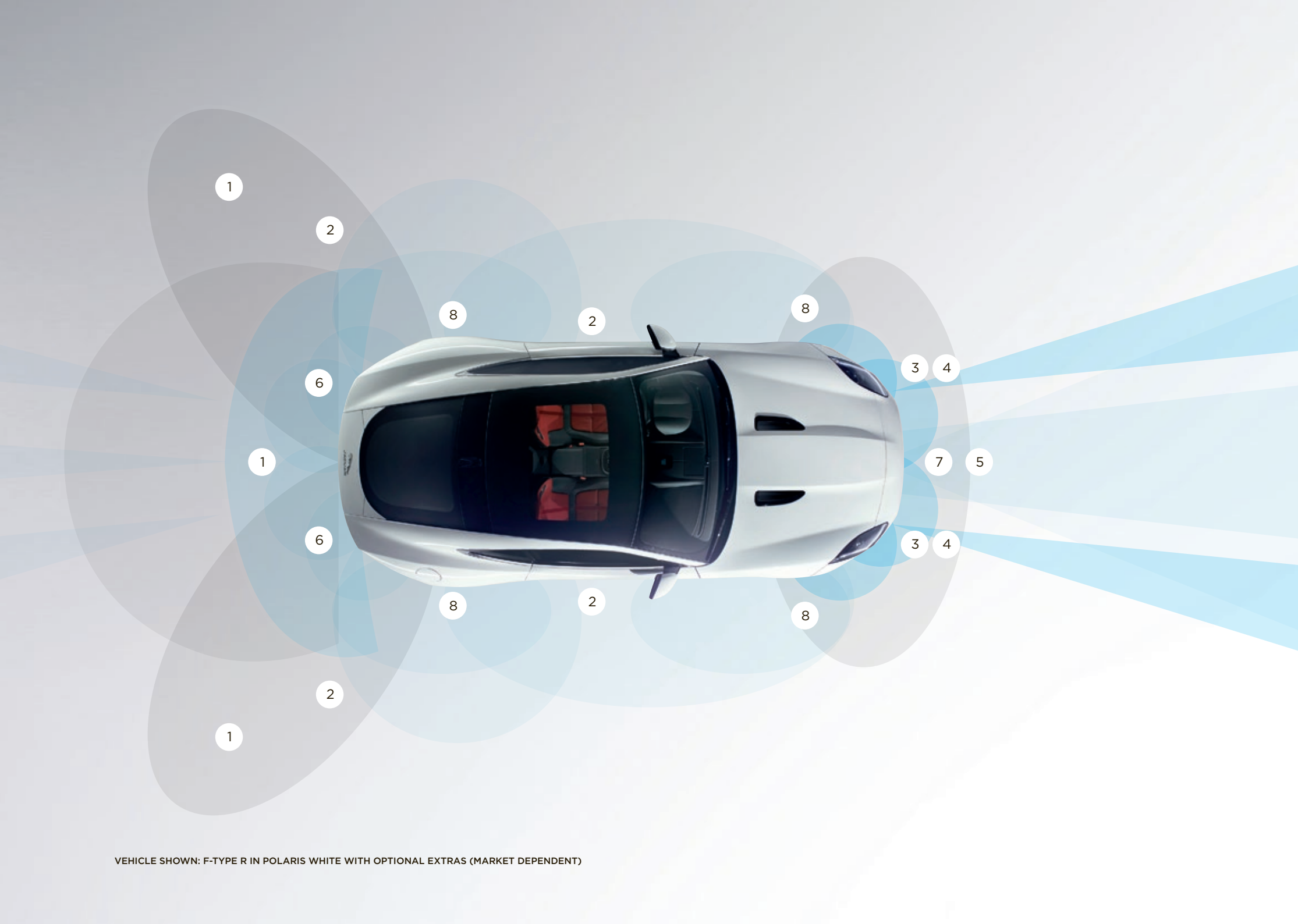

VEHICLE SHOWN: F-TYPE R IN POLARIS WHITE WITH OPTIONAL EXTRAS (MARKET DEPENDENT)

EFFICIENT TECHNOLOGIES



LIGHTWEIGHT MATERIALS

CLEAN TECHNOLOGIES

F-TYPE uses a range of technologies to help reduce fuel consumption and CO₂ emissions, all while staying true to Jaguar's dynamic nature.



INTELLIGENT STOP/START*

All F-TYPE's engines are available with Intelligent Stop/Start. The system shuts down the engine when you come to a complete halt and restarts the engine immediately when required. It helps save fuel, especially during urban driving.

*Market dependent.



ELECTRIC POWER ASSISTED STEERING (EPAS)

F-TYPE's next generation Electric Power Assisted Steering (EPAS) offers outstanding feedback, control and immediate power assistance. Electrically driven, it's only active on demand which saves fuel.



SUSTAINABLE CONSTRUCTION

The aluminium alloy used for much of F-TYPE's construction is from a high level of recycled aluminium. Using significantly less energy than primary aluminium to produce, it minimises F-TYPE's environmental impact.



ADVANCED AERODYNAMICS

Aerodynamic performance is seamlessly integrated into F-TYPE's design for low levels of lift and excellent stability at high speeds. This has the positive effect of reducing F-TYPE's fuel consumption and CO₂ emissions.



R IS INTENSITY. IT PROVIDES MORE. MORE POWER. MORE DYNAMIC CAPABILITY. MORE THRILLS. F-TYPE R IS THE SPORTS CAR THAT IS MORE HONED, SENSUOUS AND EXCITING.







PERFORMANCE

 **5.0 LITRE V8 550PS ENGINE** | **0-100KM/H IN 4.2 SECONDS**

F-TYPE R is powered by Jaguar's 5.0 V8 550PS supercharged engine with 680Nm of torque taking you from 0-100km/h in 4.2 seconds. With finely balanced power output and power-to-weight ratios, F-TYPE R's extremely rigid bodyshell provides the definitive platform for suspension enhancements that harness every ounce of power on hand. When F-TYPE R is combined with optional All Wheel Drive (AWD), its synthesis of power, performance and handling is ready to take on almost any road conditions.

VEHICLE SHOWN PREVIOUS PAGE: F-TYPE R AWD IN STORM GREY WITH OPTIONAL EXTRAS (MARKET DEPENDENT)
VEHICLE SHOWN THIS PAGE: F-TYPE R IN STORM GREY WITH OPTIONAL EXTRAS (MARKET DEPENDENT)

INTERIOR



PREMIUM LEATHER INTERIOR

R EMBOSSED HEADRESTS

F-TYPE R's interior dials up the intensity of the 1+1 experience. The R theme gives the car a unique personality and includes Dark Linear Aluminium on the centre console finishers. Enjoy Premium Leather with twin needle stitching and, for more lateral support during more enthusiastic driving, body-hugging Performance seats with embossed R logo on the headrest. Take complete control with the R 3-spoke leather steering wheel with Silver paddles.

VEHICLE SHOWN: F-TYPE R AWD FEATURING PERFORMANCE SEATS IN JET AND IVORY DUOTONE WITH OPTIONAL EXTRAS (MARKET DEPENDENT)





HOW CAN YOU IMPROVE ON THE TECHNICAL EXCELLENCE AND INTENSE THRILLS OF F-TYPE R? SVR IS THE FASTEST F-TYPE EVER. EVERY DETAIL DELIVERS ENHANCED PERFORMANCE. OVER 100 REFINEMENTS, WEIGHT REDUCTIONS AND TECHNICAL REINVENTIONS HAVE CREATED AN EXHILARATING SPORTS CAR THAT IS PURE JAGUAR.







THE CONCEPT OF SVR



STATE-OF-THE-ART MATERIALS

ADVANCED AERODYNAMICS

SVR is F-TYPE honed beyond perfection. Its state-of-the-art materials and advanced aerodynamic design push F-TYPE beyond the extraordinary. Delivering supreme performance, ride and handling, the car creates once-in-a-lifetime driving experiences - every day. Its exceptional powertrain makes SVR our fastest production car ever. SVR is our ultimate sports car.







SPECIAL VEHICLE OPERATIONS



JAGUAR'S CENTRE
OF EXCELLENCE

0-100KM/H
IN 3.7 SECONDS

Based at a new Formula 1-inspired manufacturing facility, complete with customer commissioning suite, Special Vehicle Operations (SVO) is Jaguar's centre of excellence and has been established to enable our most discerning customers to indulge their passion for Jaguar. SVR is designed and engineered at SVO where our highly skilled engineers and aerodynamics experts have scrutinised every possible component to maximise SVR's performance.

SVR's lightweight All Wheel Drive system, with Intelligent Driveline Dynamics, delivers its power with efficiency and control. The engine has been recalibrated. The 5.0 litre V8 unit's twin vortex supercharger eliminates drag and surge for responsive performance at all engine speeds. 575PS and torque of 700Nm is maximised by a power-to-weight ratio of 337PS/tonne. Hold tight – it will take you from 0-100km/h in just 3.7 seconds and on to a top speed of 322km/h.* But it is about more than numbers, more than just a machine. Jaguar makes performance an art. SVR is our latest masterpiece.



SPECIAL VEHICLE
OPERATIONS

*Coupé only.

VEHICLE SHOWN PREVIOUS PAGE (LEFT) AND ONE PRECEDING: F-TYPE SVR IN FIRESAND WITH OPTIONAL EXTRAS (MARKET DEPENDENT)

VEHICLE SHOWN PREVIOUS PAGE (RIGHT) AND THIS PAGE: F-TYPE SVR IN AMMONITE WITH OPTIONAL EXTRAS (MARKET DEPENDENT)



AERODYNAMICS



**MAXIMISED
CAPABILITY**

**ADJUSTABLE
DOWNFORCE**

SVR's performance is not expressed by its exterior design: it is created by it. Form follows function in every swooping curve and finely drawn line. Each unique styling element, down to the smallest, subtle detail, improves SVR. Its advanced aerodynamic design offers less drag and higher levels of downforce. As a result SVR slices cleanly through the air, achieving rapid acceleration and effortlessly efficient cruising. Strong downforce improves stability and handling, road holding and dynamic capability.

FRONT INTAKES AND SPLITTER

Unique large lower bumper intakes maximise airflow for cooling of both the engine and brakes for improved performance. A precision splitter designed specially for SVR directs airflow into the car for optimum cooling. It also creates downforce at the front of the car to balance the rear wing.

BONNET LOUVRES AND SIDE POWER VENTS

Uniquely shaped louvres maximise airflow through the engine bay. This aids cooling, so the engine can operate at the highest level. Air from the wheel housing is released through side power vents which manage airflow around the wheel arch to minimise drag and improve SVR's efficiency.

ENHANCED COOLING

SVR's cooling system has been enhanced with significant improvements to airflow. To achieve this, the auxiliary radiator has been relocated, while the bumper beam profile and inlet trumpet size have been reduced. This increases the full performance envelope on SVR for greater endurance in extreme driving situations.



AERODYNAMIC WING

The aerodynamic wing is integral to SVR's enhanced performance. Compared with the standard F-TYPE Coupé's rear wing, SVR produces more downforce but crucially less drag. The wing is more elevated and wider than the standard F-TYPE R Coupé's spoiler, enabling it to act over the whole width of the car rather than just the width of the boot lid.

Air passes both over and under the wing, allowing Bernoulli's principle to act in the car's favour - faster moving air underneath the wing is at a lower pressure than that passing over the top, resulting in additional downforce.

SVR's wing operates in two different positions:

On F-TYPE SVR Coupé the aerodynamic wing deploys at 113km/h and stows at 80km/h.

On F-TYPE SVR Convertible the aerodynamic wing deploys at 97km/h and stows at 64km/h.

DEPLOYED

When SVR's wing is deployed it increases downforce for greater stability and improved handling at top speed. In this position the wing gives a drag coefficient reduction of 2.5 percent and a lift coefficient reduction of 15 percent.

STOWED

For maximum top speed (V-Max), the wing is stowed to reduce drag. It works in conjunction with the front spoiler and other aerodynamic enhancements to bring a drag coefficient improvement of 7.5 percent and lift coefficient reduction of 45 percent.

V-MAX

In order to achieve 322km/h* you must consciously prepare your SVR. Select 'Dynamic Mode' and press the deployable aerodynamic wing switch for 3 seconds to enable V-Max mode. While active, a permanent symbol appears on the instrument cluster. In this mode the spoiler remains stowed at all speeds keeping drag to a minimum.

REAR UNDERFLOOR AND DIFFUSER

The smooth rear underfloor reduces drag, whilst the rear diffuser works with the rear underfloor to manage airflow, adding to SVR's stability.

*Coupé only.



986 UDY

F-TYPE

LIGHTWEIGHT TECHNOLOGIES



WEIGHT SAVING

INNOVATIVE DESIGN

Weight is the enemy of performance. So we designed SVR to be as lean as possible. Every gram has a reason to be there. Every milligram saved gives you more rapid acceleration, more agile handling and sharper braking. Yet the interior still offers comfort and luxury in equal measures. SVR has the capability to make performance effortlessly enjoyable.

FORGED ALLOY WHEELS

SVR's bespoke Forged Alloy Wheels are fitted with unique Pirelli P ZERO™ tyres. Its rear tyres are 10mm wider than standard F-TYPE tyres, for improved handling and grip. While the striking Forged Alloys offer a 13.8kg overall weight saving.

CERAMIC BRAKES

SVR's optional CCM Brakes save up to 21kg of weight compared with non-ceramic alternatives.

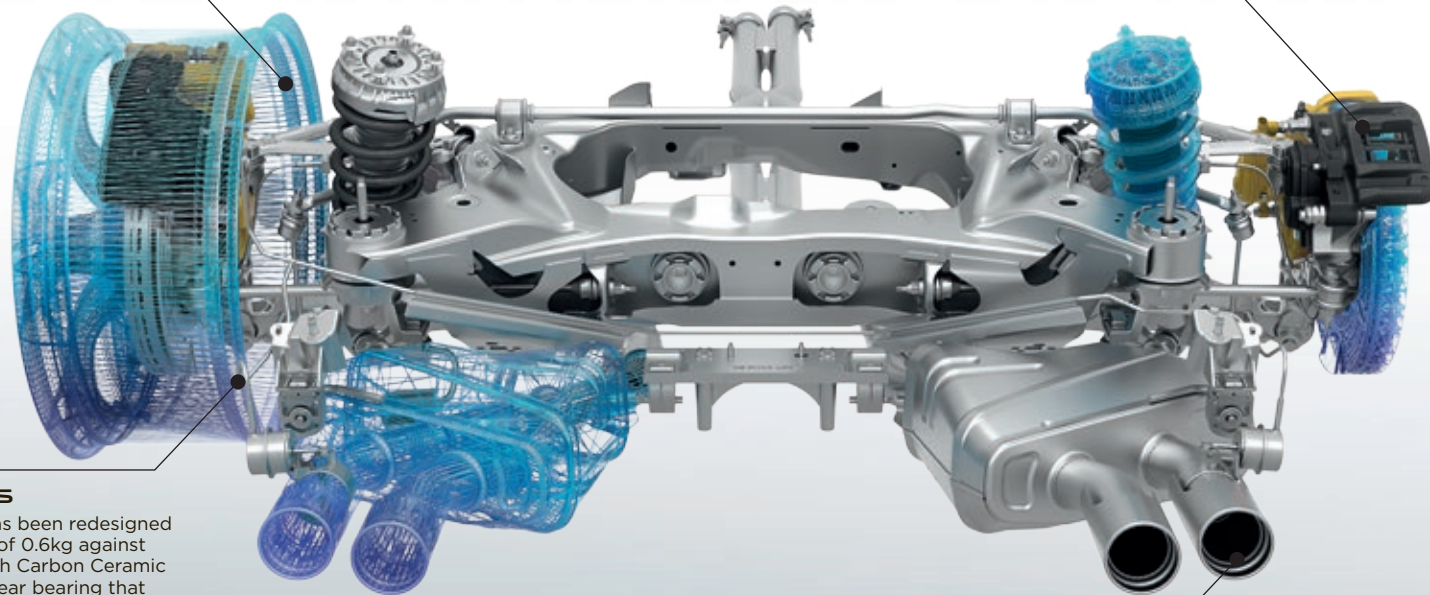

REAR KNUCKLES

The suspension system has been redesigned enabling a weight saving of 0.6kg against conventional knuckles with Carbon Ceramic brakes. SVR has a larger rear bearing that contributes towards an increased stiffness of up to 37 percent over conventional F-TYPE knuckles. This enables the car to handle even higher lateral G-forces.

TITANIUM EXHAUST

The lightweight Titanium and Inconel® exhaust system saves 16kg. With its SVR badged tailpipes, it not only looks unique, it sounds unique - SVR is recognisable by the distinctive rumble of its exhaust.



INTERIOR

 **UNIQUE DETAILS** | **SPORTING CRAFTSMANSHIP**

Just as no detail of SVR's engineering and exterior design has been overlooked, its interior is testament to the SVO division's attention to detail. The moment you open the door, the SVR treadplate shows that you are entering a special space.

Exclusive materials are everywhere you look, from fine contrast stitching to ultra-modern finishes that create a sense of total luxury. The SVR badged steering wheel with larger aluminium anodised shifter paddles offers the perfect connection to the road and the quilted Performance seats offer comfort and support while you enjoy the dynamic drive.

VEHICLE SHOWN: F-TYPE SVR FEATURING SIENA TAN PERFORMANCE SEATS WITH CIRRUS STITCH WITH OPTIONAL EXTRAS (MARKET DEPENDENT)



PERSONALISATION F-TYPE - YOUR CHOICE

 Configure your vehicle at jaguar.com



CHOOSE YOUR ENGINE

Page 76

Select one of F-TYPE's powerful, efficient petrol engines to suit your driving style.

CHOOSE YOUR MODEL & OPTIONS

Page 78

Compare the wealth of standard features and options on F-TYPE models.

CHOOSE YOUR COLOUR

Page 90

Express your individuality with one of F-TYPE's stunning exterior colours.

CHOOSE YOUR WHEELS

Page 92

Complement your F-TYPE's stunning style, with a set of beautifully designed alloy wheels.

CHOOSE YOUR INTERIOR

Page 94

There's a wide selection of premium materials, leathers, veneers and finishes for every personal taste.

CHOOSE YOUR JAGUAR ACCESSORIES

Page 108

Really make it yours by adding style, practicality and versatility with official F-TYPE Accessories from your local Jaguar Retailer.

1 CHOOSE YOUR ENGINE

 Configure your vehicle at jaguar.com

> V6 ENGINES

3.0 LITRE V6

SUPERCHARGED PETROL [340PS]

MAXIMUM POWER 340PS

MAXIMUM TORQUE 450Nm

ACCELERATION 0-100 km/h
Manual 5.7 seconds/Automatic 5.3 seconds

TOP SPEED 260 km/h

COMBINED FUEL CONSUMPTION
Manual 9.8 l/100km/Automatic 8.4 l/100km

CARBON DIOXIDE EMISSIONS
Manual 234 g/km/Automatic 199 g/km

F-TYPE

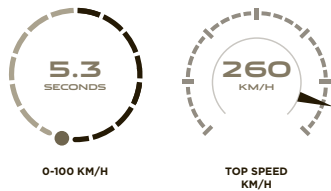

3.0 LITRE V6

SUPERCHARGED PETROL [380PS]

MAXIMUM POWER 380PS

MAXIMUM TORQUE 460Nm

ACCELERATION 0-100 km/h
Manual 5.5 seconds/Automatic 4.9 seconds

TOP SPEED 275 km/h

COMBINED FUEL CONSUMPTION
Manual 9.8 l/100km/Automatic 8.6 l/100km

CARBON DIOXIDE EMISSIONS
Manual 234 g/km/Automatic 203 g/km

F-TYPE S

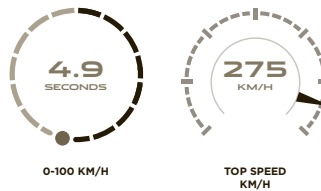

3.0 LITRE V6

SUPERCHARGED PETROL [380PS] AWD

MAXIMUM POWER 380PS

MAXIMUM TORQUE 460Nm

ACCELERATION 0-100 km/h 5.1 seconds

TOP SPEED 275 km/h

COMBINED FUEL CONSUMPTION 8.9 l/100km

CARBON DIOXIDE EMISSIONS 211 g/km

F-TYPE S AWD

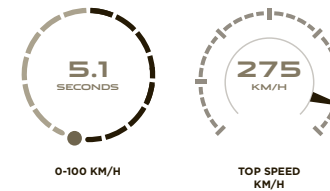

*Official EU test figures. For comparison purposes only. Real world figures may differ.

> V8 ENGINES

5.0 LITRE V8

SUPERCHARGED PETROL [550PS]

MAXIMUM POWER 550PS
MAXIMUM TORQUE 680Nm
ACCELERATION 0-100 km/h 4.2 seconds
TOP SPEED 300 km/h
COMBINED FUEL CONSUMPTION 10.7 l/100km
CARBON DIOXIDE EMISSIONS 255 g/km
F-TYPE R



0-100 KM/H

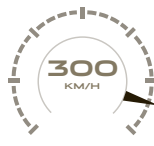

TOP SPEED
KM/H

5.0 LITRE V8

SUPERCHARGED PETROL [550PS] AWD

MAXIMUM POWER 550PS
MAXIMUM TORQUE 680Nm
ACCELERATION 0-100 km/h 4.1 seconds
TOP SPEED 300 km/h
COMBINED FUEL CONSUMPTION 11.3 l/100km
CARBON DIOXIDE EMISSIONS 269 g/km
F-TYPE R AWD



0-100 KM/H

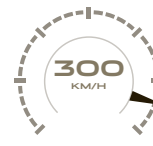

TOP SPEED
KM/H

5.0 LITRE V8

SUPERCHARGED PETROL [575PS] AWD

MAXIMUM POWER 575PS
MAXIMUM TORQUE 700Nm
ACCELERATION 0-100 km/h 3.7 seconds
TOP SPEED 322 km/h
COMBINED FUEL CONSUMPTION 11.3 l/100km
CARBON DIOXIDE EMISSIONS 269 g/km
F-TYPE SVR



0-100 KM/H

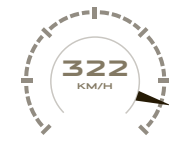

TOP SPEED
KM/H

2 CHOOSE YOUR MODEL

 Configure your vehicle at jaguar.com

> REAR WHEEL DRIVE [RWD] COUPÉ AND CONVERTIBLE



F-TYPE

KEY FEATURES

- Jaguar Performance Braking System with Silver calipers
- Sports suspension
- Active Sports Exhaust with centre mounted twin exhaust pipes
- 18" Vela alloy wheels
- Sport seats with Leather and Suedecloth facings
- 3-spoke leather steering wheel with Black gearshift paddles (automatic only)
- Light Hex Aluminium console finisher
- Available with Quickshift 8-speed automatic or 6-speed manual transmission



F-TYPE S

KEY FEATURES

- Jaguar High Performance Braking System with Black calipers
- Sports suspension with Adaptive Dynamics
- Active Sports Exhaust with centre mounted twin exhaust pipes
- 19" Propeller alloy wheels
- Configurable Dynamics System
- Limited Slip Differential
- Sport seats with Leather and Suedecloth facings
- 3-spoke leather steering wheel with Ignis gearshift paddles (automatic only)
- Dark Hex Aluminium console finisher with 'S' graphic
- Configurable Ambient Interior Lighting with selectable palette
- Available with Quickshift 8-speed automatic or 6-speed manual transmission



F-TYPE R

KEY FEATURES

- Jaguar Super Performance Braking System with Red calipers
- Sports suspension with Adaptive Dynamics
- Switchable Active Sports Exhaust with quad exhaust pipes
- 20" Gyrodyne Silver alloy wheels
- Configurable Dynamics System
- Electronic Active Differential with Torque Vectoring
- Performance seats with Premium Leather facings and R embossing
- 3-spoke leather steering wheel with Silver gearshift paddles
- Dark Linear Aluminium console finisher with R graphic
- Configurable Ambient Interior Lighting with selectable palette
- Available with Quickshift 8-speed automatic transmission

> ALL WHEEL DRIVE [AWD] COUPÉ AND CONVERTIBLE



F-TYPE S AWD

KEY FEATURES (IN ADDITION TO F-TYPE S)

All Wheel Drive System
Intelligent Driveline Dynamics
'AWD' bonnet with body coloured vents
19" Volution Silver alloy wheels
Available with Quickshift 8-speed automatic transmission



F-TYPE R AWD

KEY FEATURES (IN ADDITION TO F-TYPE R)

All Wheel Drive System
Intelligent Driveline Dynamics
'AWD' bonnet with body coloured vents
Available with Quickshift 8-speed automatic transmission



F-TYPE SVR

KEY FEATURES

All Wheel Drive System
Redesigned aerodynamics
Carbon Fibre Aerodynamic Wing
Jaguar Super Performance Braking System with Red calipers
Sports suspension with Adaptive Dynamics
Lightweight Titanium and Inconel® Exhaust
20" Coriolis Technical Grey forged alloy wheels
Configurable Dynamics System
Electronic Active Differential with Torque Vectoring
Quilted Performance seats with Premium Leather facings and SVR embossing
3-spoke leather SVR steering wheel with Aluminium gearshift paddles and twin needle contrast stitching
Dark Brushed Aluminium console finisher with SVR graphic
Configurable Ambient Interior Lighting with selectable palette
Available with Quickshift 8-speed automatic transmission

2 CHOOSE YOUR OPTIONS

 Configure your vehicle at jaguar.com

ROOF STYLES

F-TYPE offers a range of different roofs to suit your own personal style. Each delivering their own distinctive characteristics, they provide a powerful expression of individual flair both inside the cabin and to the outside world.



ALUMINIUM ROOF

For the pure Coupé look, F-TYPE's aluminium roof is as strong and lightweight as the rest of the vehicle. It provides the ideal complement in colour, style and line to the powerful F-TYPE profile. The aluminium roof expresses F-TYPE in its clearest sports car form.



PANORAMIC GLASS ROOF

Introducing even more natural light and airiness to the interior, a full width panoramic glass roof is optional on F-TYPE Coupé models. For increased seclusion, should it be required, the roof features a manually sliding 'black-out' blind, which can screen the occupants from up to 99 percent of the incoming light.



CARBON FIBRE ROOF*

With Carbon Fibre outer and inner panels bonded together to create a strong yet light roof structure, F-TYPE Coupé's optional Carbon Fibre roof is 20 percent lighter than the standard aluminium roof. It features Carbon Fibre weave visible through a deep, high-grade lacquered finish.



FABRIC ROOF

F-TYPE Convertible's lightweight fabric roof is acoustically enhanced with composite fabric to reduce noise and features a flush fitting heated glass rear window. The roof can be raised or lowered in just 12 seconds and operated fully automatically at speeds of up to 50km/h.

*Please consult your retailer for availability.

VEHICLES SHOWN: F-TYPE R IN POLARIS WHITE WITH OPTIONAL EXTRAS (MARKET DEPENDENT)

CONVERTIBLE ROOF COLOURS

STANDARD

Jet

OPTIONAL

Grey

Red

Beige

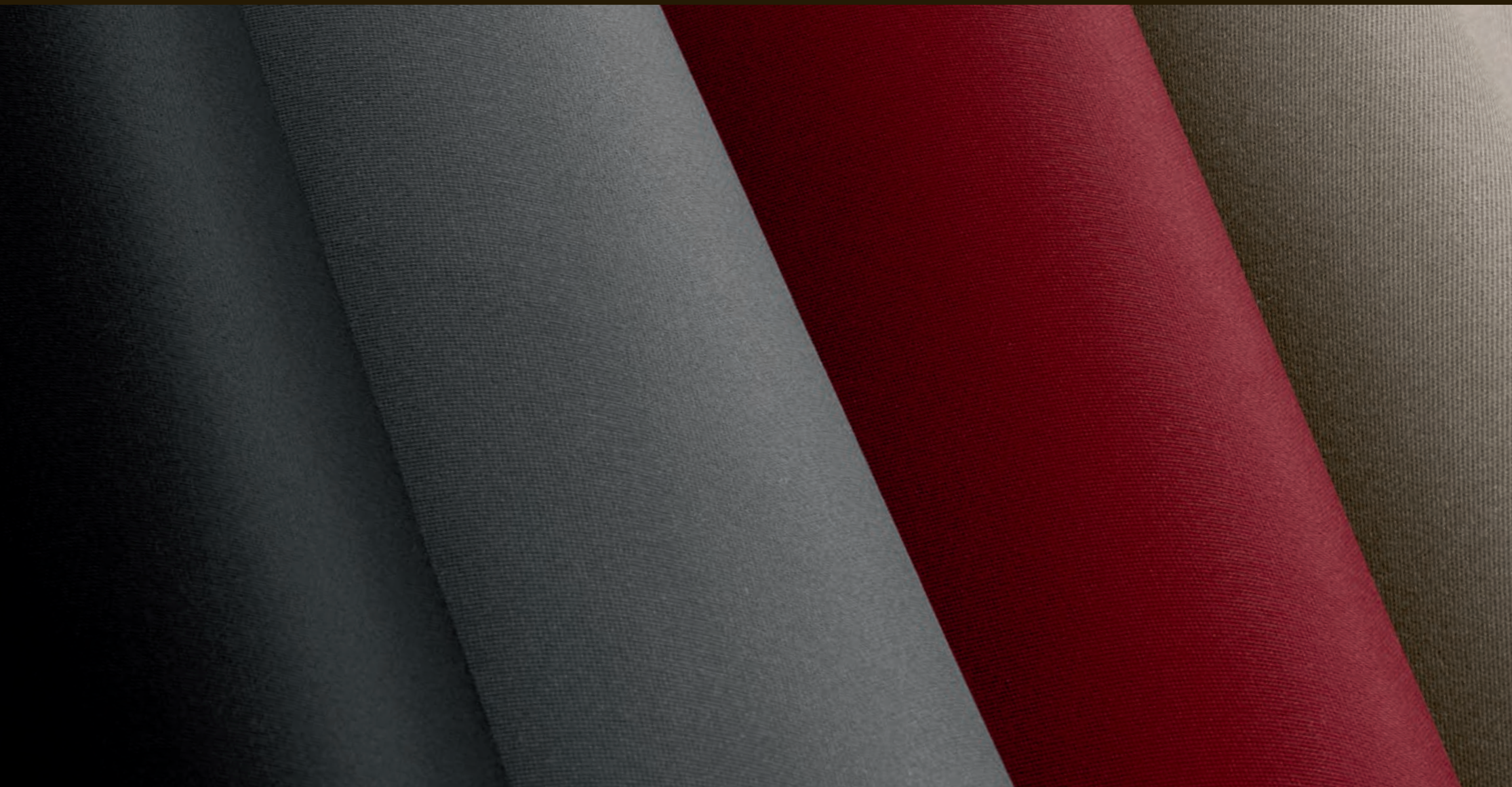

2 CHOOSE YOUR OPTIONS

 Configure your vehicle at jaguar.com

KEY STANDARD FEATURES

	CODE	F-TYPE	F-TYPE S	F-TYPE R	F-TYPE SVR	DESCRIPTION
Intelligent Stop/Start	H58A	●	●	●	●	
Active Sports Exhaust	S65B	●	●	●	●	
Tyre Pressure Monitoring System (TPMS)	C42R	●	●	●	●	
Tyre Repair System	C69A	●	●	●	●	
Emergency Brake Assist (EBA)	—	●	●	●	●	
Electronic Brake-force Distribution (EBD)	—	●	●	●	●	
Bi-function HID Xenon headlamps with LED Daytime Running Lights and automatic levelling	—	●	●	●	●	
Jaguar Smart Key System with Keyless start	—	●	●	●	●	
Pedestrian Contact Sensing	B93A	●	●	●	●	
Roll over protection system	—	●	●	●	●	
Deployable door handles	—	●	●	●	●	
Solid paint	—	●	●	●	●	
Rain sensing windscreen wipers	—	●	●	●	●	
Single Zone Climate control	C88J	●	●	●	●	
Active Central Air Vent	—	●	●	●	●	
Auto-Dimming interior rear view mirror	B68B	●	●	●	●	
Jet headlining	HPDB	●	●	●	●	
8 inch colour Touchscreen display	—	●	●	●	●	
5 inch Instrument Display with analogue dials	—	●	●	●	●	
USB (inc iPod) and Auxiliary power socket in centre cubby box	—	●	●	●	●	
Auxiliary power socket in centre console	—	●	●	●	●	
InControl Remote for Warranty Period	D45A	●	●	●	●	
Jaguar Sound System	B43T	●	●	●	●	

● Standard ○ Option — Not available ■ Part of Pack

Please consult your local Jaguar retailer for details.

For a complete list of optional features and packs refer to the F-TYPE Specification and Price Guide or configure your vehicle at jaguar.com

KEY OPTIONAL FEATURES

		F-TYPE	F-TYPE S	F-TYPE R	F-TYPE SVR	
TRANSMISSION AND DYNAMIC FEATURES						
6-Speed manual transmission	A40G	●	●	—	—	
8-Speed automatic transmission with Jaguar Sequential Shift RWD	A40E	○	○	●	—	
8-Speed automatic transmission with Jaguar Sequential Shift AWD	A40F	—	○	○	●	
Passive Suspension	C35Z	●	—	—	—	
Adaptive Dynamics	C35A	—	●	●	●	
Open Differential	C37A	●	—	—	—	
Open Differential and Torque Vectoring	C37E	○	—	—	—	
Limited Slip Differential	C37B	—	●	—	—	
Limited Slip Differential and Torque Vectoring	C37F	—	○	—	—	
Electronic Active Differential and Torque Vectoring	C37D	—	—	●	●	
Dynamic Mode	B73B	●	—	—	—	
Configurable Dynamic Mode with Dynamic-i	B73C	—	●	●	●	
Switchable Active Sports Exhaust	S66A	○	○	●	●	
Centre Mounted Twin Exhaust Pipes	S64C	●	●	—	—	
Outboard Mounted Quad Exhaust Pipes	S64B	—	—	●	—	
Outboard Mounted Lightweight Inconel® and Titanium Quad Exhaust Pipes	S64G	—	—	—	●	
BRAKES						
Jaguar Performance braking system	C08G	●	—	—	—	
Jaguar High Performance braking system	C08F	—	●	—	—	
Jaguar Super Performance braking system	C08C	○	○	●	●	Requires 19" wheels or larger. Requires red or black brake calipers
Jaguar Carbon Ceramic braking system	C08H	—	■	■	■	Part of Carbon Ceramic Brake Pack (Automatic models only)
Silver brake calipers	C10W	●	—	—	—	
Red brake calipers	C10R	○	○	●	●	
Black brake calipers	C10Y	—	●	○	○	Requires Jaguar High Performance braking system or Jaguar Super Performance braking system
Yellow brake calipers	C10P	—	■	■	■	Part of Carbon Ceramic Brake Pack

2 CHOOSE YOUR OPTIONS

 Configure your vehicle at jaguar.com

EXTERIOR FEATURES AND FINISHERS

		F-TYPE	F-TYPE S	F-TYPE R	F-TYPE SVR	
EXTERIOR FEATURES AND TRIM						DESCRIPTION
Red full Electric convertible roof	LCHH	○	○	○	○	Only available on Convertible models
Grey full Electric convertible roof	LLKB	○	○	○	○	Only available on Convertible models
Beige full Electric convertible roof	LSAL	○	○	○	○	Only available on Convertible models
Fixed Panoramic roof	F45A	○	○	○	○	Only available on Coupé models
Carbon Fibre roof	F45B	○	○	○	○	Only available on Coupé models
Powered tailgate/boot lid	B69B	○	○	○	○	Only available on Coupé models
Satin Chrome roll over protection bars	B67C	●	●	—	—	Only available on Convertible models
Gloss Black roll over protection bars	B67B	■	■	●	●	Only available on Convertible models
Body coloured roll over protection bars	B67D	○	○	○	○	Only available on Convertible models. Not available with Exterior Black Pack or Design Packs with Black Pack
Carbon Fibre roll over protection bars	B67A	—	—	—	■	Only available on Convertible models. Part of Carbon Fibre Exterior Pack
Body coloured Fixed Rear Spoiler	B09F	■	■	■	—	Only available on Coupé models. Requires Switchable Active Exhaust. Part of Sport Design Pack with Fixed Rear Spoiler
Body coloured Deployable Rear Spoiler	B09M	●	●	●	○	
Carbon Fibre Rear Aerodynamic Wing	B09C	—	—	—	●	

GLASS AND EXTERIOR MIRRORS

Heated door mirrors	B28J	●	●	●	—	
Power Fold, Heated door mirrors	B28R	○	○	○	—	
Power Fold, Heated door mirrors with Memory	B28S	—	—	—	●	Part of Seat Memory Pack 1
Auto-Dimming, Power Fold and Heated door mirrors	B28P	○	○	○	—	
Auto-Dimming, Power Fold, Heated door mirrors with Memory	B28T	■	■	■	○	Part of Seat Memory Pack 2
Infrared Reflective windscreen	D97B	○	○	○	○	Not available with Digital TV
Heated front windscreen	D96A	○	○	○	○	

HEADLIGHTS AND LIGHTING

Adaptive front lighting with cornering lights	D90K	○	○	○	○	
Auto High Beam Assist	D91A	○	○	○	○	

EXTERIOR COLOURS

Metallic paint	—	○	○	○	○	
Premium paint	—	○	○	○	○	

WHEELS

Alloy space saver spare wheel	C40N	○	○	○	○	Not available with Carbon Ceramic Braking System
-------------------------------	------	---	---	---	---	--

● Standard ○ Option — Not available ■ Part of pack

Please consult your local Jaguar retailer for details.

For a complete list of optional features and packs refer to the F-TYPE Specification and Price Guide or configure your vehicle at jaguar.com

INTERIOR SEATING

SEATING	CODE	F-TYPE	F-TYPE S	F-TYPE R	F-TYPE SVR	DESCRIPTION
Sport seats	B55A	●	●	—	—	
Performance seats	B55C	○	○	■	—	Not available with Leather and Suedecloth Sport seats or Leather seats. Linked to Premium Leather Interior Pack, Suedecloth Interior Pack or Full Leather Interior Pack for F-TYPE and F-TYPE S. Only available on F-TYPE R as part of 'Suedecloth Interior Pack' or 'Full Leather Interior Pack'
R Performance seats	B55D	—	—	●	—	
SVR Performance seats	B55H	—	—	—	●	
Leather and Suedecloth Sport seats	B40N	●	●	—	—	
Leather seats	B40W	○	○	—	—	
Premium Leather seats	B41H	■	■	●	—	Requires Premium Leather interior where optional
Lozenge Quilted Premium Leather seats	B41U	—	—	—	●	
6-Way Electric seats	H53H	●	●	●	—	
14-Way Electric seats with Memory	H53F	■	■	■	●	
Heated front seats	F53A	○	○	○	○	
Red seatbelts	RCHX	○	○	○	○	
Camel seatbelts	RSFA	○	○	○	—	

HEADLINING

HEADLINING	CODE	F-TYPE	F-TYPE S	F-TYPE R	F-TYPE SVR	DESCRIPTION
Morzine headlining	H01E	●	●	●	—	
Stone Grey headlining	HLFZ	○	○	○	—	
Red headlining	HCHX	○	○	○	○	Only available on Convertible models
Ivory headlining	HNAA	○	○	○	—	Not available with Panoramic Glass Roof

2 CHOOSE YOUR OPTIONS

 Configure your vehicle at jaguar.com

INTERIOR FEATURES

INTERIOR FEATURES	CODE	F-TYPE	F-TYPE S	F-TYPE R	F-TYPE SVR	DESCRIPTION
Sports Sunvisor	F57B	●	●	●	—	
Sports Sunvisor with Mirror	F57C	○	○	○	—	Requires Morzine Jet or Stone Grey headlining
Suede cloth Sports Sunvisor with Mirror	F57G	■	■	■	●	
Suede cloth headlining	H01D	■	■	■	●	
Cirrus carpet	KLDN	○	○	—	—	
Premium carpet mats with contrast edging	H69R	○	○	—	—	
Twin stitched carpet mats	H69V	■	■	●	—	
Premium carpet mats	H69K	○	○	—	—	
Nubuck edged carpet mats	H69N	■	■	—	●	Part of TP23 Interior Pack
Illuminated metal treadplates with Jaguar script	F28F	○	○	○	○	
Multi-function Leather steering wheel	F95Y	●	●	—	—	
Multi-function Flat Bottomed Leather steering wheel	F95T	○	○	—	—	
R branded Multi-function Leather steering wheel	F96L	—	—	●	—	
R branded Multi-function Leather flat bottomed steering wheel	F95R	—	—	○	—	
SVR branded Multi-function Leather steering wheel	F96Q	—	—	—	●	
SVR branded Multi-function Suede cloth steering wheel	F96P	—	—	—	○	Not available with Heated steering wheel
Non-heated steering wheel	F97Z	●	●	●	○	Only optional when selected with Suede cloth steering wheel
Heated steering wheel	F97A	○	○	○	●	Requires Cruise Control and Speed Limiter

● Standard ○ Option — Not available ■ Part of pack

Please consult your local Jaguar retailer for details.

For a complete list of optional features and packs refer to the F-TYPE Specification and Price Guide or configure your vehicle at jaguar.com

INTERIOR FEATURES [CONTINUED]	CODE	F-TYPE	F-TYPE S	F-TYPE R	F-TYPE SVR	DESCRIPTION
Electrically adjustable steering column	D07E	●	●	●	—	
Electrically adjustable steering column with memory	D07F	■	■	■	●	Part of Seat Memory Packs
Configurable interior mood lighting	B65D	○	●	●	●	
Lockable storage box	B32T	○	○	○	○	Only available on Convertible models
Front Parking Aid	C13A	○	○	○	●	Requires Rear Parking Aid
Rear Parking Aid	C11A	○	○	○	●	
Rear View Camera	C14A	○	○	○	●	Requires Rear Parking Aid
Blind Spot Monitor	H71B	○	○	○	○	Requires Auto-Dimming, Power Fold, Heated door mirrors with Approach Lights and Auto-Dimming interior rear view mirror
Blind Spot Monitor and Reverse Traffic Detection	H71C	○	○	○	○	Requires Rear Parking Aid and Auto-Dimming, Power Fold, Heated door mirrors with Approach Lights
Keyless Entry	F04B	○	○	○	○	
2-Zone climate control	C88H	○	○	○	○	
Air Quality Sensor	C89A	○	○	○	○	
Cruise Control and Speed Limiter	H41C	○	○	○	●	
Garage door opener (HomeLink®)	B20B	○	○	○	○	Only available on Convertible models
Wind deflector	B74A	○	○	○	○	Only available on Convertible models
Bright Sport pedals	G48S	○	○	○	●	Only available on Automatic models

2 CHOOSE YOUR OPTIONS

 Configure your vehicle at jaguar.com

INFORMATION, COMMUNICATION AND ENTERTAINMENT

INFORMATION AND COMMUNICATION	CODE	F-TYPE	F-TYPE S	F-TYPE R	F-TYPE SVR	DESCRIPTION
Navigation System - HDD	G56V	<input type="radio"/>	<input type="radio"/>	<input type="radio"/>	<input type="radio"/>	Requires Meridian Sound System - 770W with single slot CD/DVD
Navigation System - SD Card	G61C	<input type="radio"/>	<input type="radio"/>	<input type="radio"/>	<input type="radio"/>	
Bluetooth® connectivity	H74V	<input type="radio"/>	<input type="radio"/>	<input type="radio"/>	<input type="radio"/>	
InControl Apps	H57A	<input type="radio"/>	<input type="radio"/>	<input type="radio"/>	<input type="radio"/>	Requires Navigation
InControl Secure for Warranty period	D44A	<input type="radio"/>	<input type="radio"/>	<input type="radio"/>	<input type="radio"/>	
AUDIO						
Meridian Sound System - 380W	B44V	<input type="radio"/>	<input type="radio"/>	<input type="radio"/>	<input type="radio"/>	
Meridian Sound System - 770W with single slot CD/DVD	B44Z	<input type="radio"/>	<input type="radio"/>	<input type="radio"/>	<input type="radio"/>	Linked to InControl Apps
Digital TV	G52G	<input type="radio"/>	<input type="radio"/>	<input type="radio"/>	<input type="radio"/>	Requires Meridian Sound System - 770W with single slot CD/DVD (Not available with Digital TV on Convertible models)
Digital Audio Broadcast (DAB) Radio	B51A	<input type="radio"/>	<input type="radio"/>	<input type="radio"/>	<input type="radio"/>	Not available with Digital TV on Convertible models

OPTION PACKS

Black Pack	Z93L	<input type="radio"/>	<input type="radio"/>	<input type="radio"/>	<input type="checkbox"/>	Gloss Black finish to side window surrounds (Coupé only), aerodynamic splitters, front grille surround, side power vents, bonnet louvres and Roll Over Protection Bars (Convertible only)
Design Pack	Z93M	<input type="radio"/>	<input type="radio"/>	<input type="checkbox"/>	<input type="checkbox"/>	Body coloured front bumper splitter, aerodynamic splitters, side sills and rear bumper venturi
Design Pack with Black Pack	Z93N	<input type="radio"/>	<input type="radio"/>	<input type="checkbox"/>	<input type="checkbox"/>	Body coloured front bumper splitter, aerodynamic splitters, side sills and rear bumper venturi. Gloss Black finish to side window surrounds (Coupé only), side power vents, bonnet louvres and Roll Over Protection Bars (Convertible only)
Sport Design Pack	Z93Q	<input type="radio"/>	<input type="radio"/>	<input type="radio"/>	<input type="checkbox"/>	Body coloured extended front bumper, aerodynamic splitters, side sills and rear bumper venturi
Sport Design Pack with Fixed Rear Spoiler	Z94F	<input type="radio"/>	<input type="radio"/>	<input type="radio"/>	<input type="checkbox"/>	Body coloured extended front bumper, aerodynamic splitters, side sills, rear bumper venturi and fixed rear spoiler. (Coupé Only)
Sport Design Pack with Black Pack	Z93Z	<input type="radio"/>	<input type="radio"/>	<input type="radio"/>	<input type="checkbox"/>	Body coloured extended front aerodynamic splitters, side sills, rear bumper venturi. Gloss Black finish to side window surrounds (Coupé only), front grille surround, side power vents, bonnet louvres and Roll Over Protection Bars (Convertible only)
Sport Design Pack with Fixed Rear Spoiler and Black Pack	Z94G	<input type="radio"/>	<input type="radio"/>	<input type="radio"/>	<input type="checkbox"/>	Body coloured extended front bumper, aerodynamic splitters, side sills, rear bumper venturi and fixed rear spoiler. Gloss Black finish to side window surrounds, front grille surround, side power vents and bonnet louvres. (Coupé only)
Exterior Carbon Fibre Pack	Z94I	<input type="checkbox"/>	<input type="checkbox"/>	<input type="checkbox"/>	<input type="radio"/>	Carbon Fibre Louvred AWD Bonnet Vents, Carbon Fibre Mirror Caps, Carbon Fibre Venturi Blade, Carbon Fibre Front Chin Moulding and Carbon Fibre Front Wing Ingots

● Standard ○ Option — Not available ■ Part of pack

Please consult your local Jaguar retailer for details.

For a complete list of optional features and packs refer to the F-TYPE Specification and Price Guide or configure your vehicle at jaguar.com

OPTION PACKS (CONTINUED)

		F-TYPE	F-TYPES	F-TYPE R	F-TYPE SVR	DESCRIPTION
Carbon Ceramic Brake Pack 1	Z73P	—	—	○	—	Jaguar Carbon Ceramic brakes, Yellow brake calipers, 20" Storm cast wheels in Satin Anthracite Grey and bright finish stainless steel pedal covers. Only available on models with automatic transmission
Carbon Ceramic Brake Pack 2	Z73N	—	—	○	—	Jaguar Carbon Ceramic brakes, Yellow brake calipers, 20" Storm forged wheels in Satin Black/Polished and bright finish stainless steel pedal covers. Only available on models with automatic transmission
Carbon Ceramic Brake Pack with SVR Forged Wheel	Z73R	—	—	—	○	Jaguar Carbon Ceramic braking system, Yellow brake calipers, 20" Maelstrom Forged wheels with Satin Black and Diamond Turned finish
Seat Memory Pack 1	Z15V	○	○	○	—	(14x14 way) electrically adjustable seat with memory. Steering column electrically adjustable with memory. Power fold exterior mirrors with memory
Seat Memory Pack 2	Z15W	○	○	○	—	(14x14 way) electrically adjustable seat with memory. Steering column electrically adjustable with memory. Power fold exterior mirrors with memory and Auto-Dimming
Full Premium Leather Interior Pack	Z84T	○	○	○	○	Full Red (available on all models) or Siena Tan Interior (SVR only)
Extended Leather Pack	Z23C	○	○	○	○	Leather headlining and sports sunvisors with mirrors in a choice of 2 colours - Jet or Ivory. Requires Premium Leather Interior
Suedecloth Upper Environment Pack	Z23D	○	○	○	—	Suedecloth headlining (Coupé) or Suedecloth front pillars and header (Convertible) and Suedecloth sports sunvisors with mirrors in Jet
Interior Black Pack	Z01P	○	○	—	—	Flat-bottomed leather Sports steering wheel with Black trim finished and Black gear shift paddles (Automatic only). Gloss Black instrument cluster dial rings, air vent surrounds and door switch pack surrounds. Black Hex Aluminium console finisher
Vision Pack	Z37B	○	○	○	—	Adaptive front lighting with pivoting headlamps and integrated cornering lights. Automatic headlamps. Front and rear parking aid with Touch-screen visual indicator. Reverse park camera with guidance
Climate Pack	Z88L	○	○	○	○	Heated windscreen with timer, heated seats and heated steering wheel. Climate Control - automatic with air filtration and dual zone temperature for driver and passenger
Convenience Pack	Z29D	○	○	○	○	Jaguar Smart Key System with keyless start and keyless entry. Premium carpet mats. Valet mode (Coupé only). Wind Deflector and lockable interior stowage (Convertible only)
Performance Pack	Z38D	○	○	—	—	Jaguar Super Performance Braking System with Red calipers and Switchable Active Sports Exhaust. Includes bright finish stainless steel pedals with automatic transmission
Technology Pack	Z80M	○	○	○	○	SD Card Navigation with route guidance, Bluetooth® telephone connectivity, and Cruise Control with Automatic Speed Limiter
Technology & Audio Pack	Z80V	○	○	○	○	Meridian Sound System - 770W with single slot CD, HDD Navigation System, InControl Apps, Bluetooth® telephone connectivity and Cruise Control with Automatic Speed Limiter
Premium Leather Interior Pack	Z84M	○	○	—	—	Premium Leather seats, upper fascia, centre console and door casings

3 CHOOSE YOUR COLOUR

 [Configure your vehicle at jaguar.com](https://www.jaguar.com)

SOLID

Polaris White

Caldera Red

Ebony Black

METALLIC

Glacier White

Rhodium Silver

Ammonite

Ultimate Black

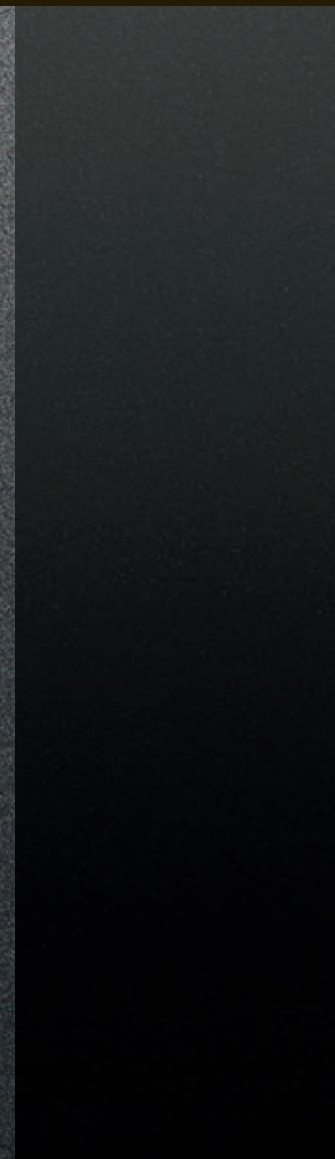
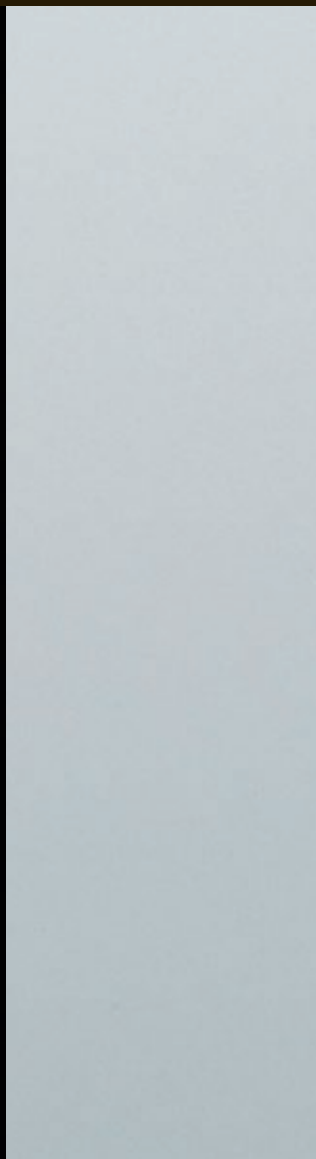
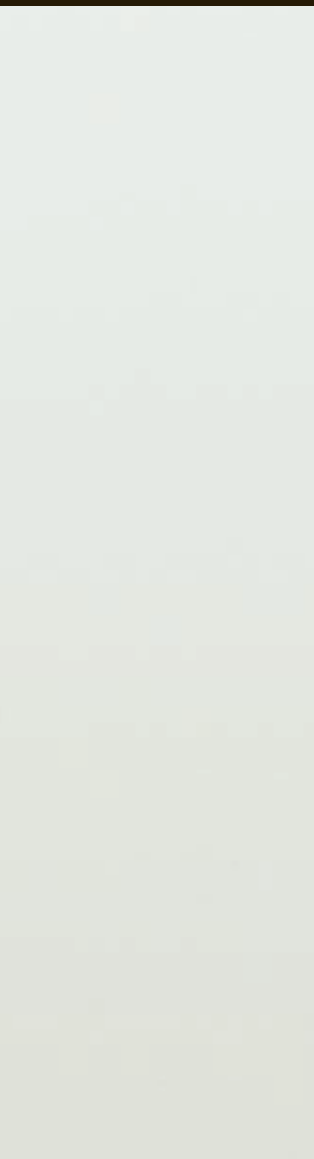

Dark Sapphire



Firesand



Italian Racing Red



British Racing Green



Ultra Blue



PREMIUM

Storm Grey



Black Berry



4 CHOOSE YOUR WHEELS

 Configure your vehicle at jaguar.com



18" VELA



19" PROPELLER



19" CENTRIFUGE



19" CENTRIFUGE



19" ORBIT



19" ORBIT

ALLOY WHEEL FINISH	Silver	Silver	Silver	Gloss Black	Silver	Gloss Black/ Diamond Turned
FRONT ALLOY WHEELS	8.5J x 18"	8.5J x 19"	8.5J x 19"	8.5J x 19"	8.5J x 19"	8.5J x 19"
FRONT TYRES	245/45 R18	245/40 R19	245/40 R19	245/40 R19	245/40 R19	245/40 R19
REAR ALLOY WHEELS	9.5J x 18"	9.5J x 19"	9.5J x 19"	9.5J x 19"	9.5J x 19"	9.5J x 19"
REAR TYRES	275/40 R18	275/35 R19	275/35 R19	275/35 R19	275/35 R19	275/35 R19

F-TYPE	●	○	○	○	○	○
F-TYPE S	—	●	○	○	○	○
F-TYPE S AWD	—	○	○	○	○	○
F-TYPE R	—	—	—	—	—	—
F-TYPE R AWD	—	—	—	—	—	—
F-TYPE SVR	—	—	—	—	—	—



19" VOLUTION



19" VOLUTION



20" CYCLONE



20" CYCLONE



20" GYRODYNE



20" GYRODYNE

ALLOY WHEEL FINISH	Silver	Technical Grey/ Diamond Turned	Silver	Gloss Black	Silver	Dark Grey/ Diamond Turned
FRONT ALLOY WHEELS	8.5J x 19"	8.5J x 19"	9.0J x 20"	9.0J x 20"	9.0J x 20"	9.0J x 20"
FRONT TYRES	245/40 R19	245/40 R19	255/35 R20	255/35 R20	255/35 R20	255/35 R20
REAR ALLOY WHEELS	9.5J x 19"	9.5J x 19"	10.5J x 20"	10.5J x 20"	10.5J x 20"	10.5J x 20"
REAR TYRES	275/35 R19	275/35 R19	295/30 R20	295/30 R20	295/30 R20	295/30 R20

F-TYPE	—	—	○	○	—	—
F-TYPE S	—	—	○	○	—	—
F-TYPE S AWD	●	○	○	○	—	—
F-TYPE R	—	—	○	○	●	○
F-TYPE R AWD	—	—	○	○	●	○
F-TYPE SVR	—	—	—	—	—	—



20" TURBINE

20" ROTOR

20" TORNADO

20" TORNADO

20" BLADE

20" STORM

ALLOY WHEEL FINISH	Silver	Forged Alloy. Gloss Black/Carbon Fibre	Silver	Gloss Black	Forged Alloy. Technical Grey/Carbon Fibre	Satin Anthracite Grey
FRONT ALLOY WHEELS	9.0J x 20"	9.0J x 20"	9.0J x 20"	9.0J x 20"	9.0J x 20"	9.0J x 20"
FRONT TYRES	255/35 R20	255/35 R20	255/35 R20	255/35 R20	255/35 R20	255/35 R20
REAR ALLOY WHEELS	10.5J x 20"	10.5J x 20"	10.5J x 20"	10.5J x 20"	10.5J x 20"	10.5J x 20"
REAR TYRES	295/30 R20	295/30 R20	295/30 R20	295/30 R20	295/30 R20	295/30 R20

F-TYPE	○	○	○	○	○	—
F-TYPE S	○	○	○	○	○	■
F-TYPE S AWD	○	○	○	○	○	■
F-TYPE R	○	○	○	○	○	■
F-TYPE R AWD	○	○	○	○	○	■
F-TYPE SVR	—	—	—	—	—	—



20" STORM

20" CORIOLIS

20" CORIOLIS

20" MAELSTROM

ALLOY WHEEL FINISH	Forged Alloy. Satin Black/Polished	Forged Alloy. Technical Grey	Forged Alloy. Gloss Black	Forged Alloy. Satin Black/Diamond Turned
FRONT ALLOY WHEELS	9.0J x 20"	9.0J x 20"	9.0J x 20"	9.0J x 20"
FRONT TYRES	255/35 R20	265/35 R20	265/35 R20	265/35 R20
REAR ALLOY WHEELS	10.5J x 20"	11J x 20"	11J x 20"	11J x 20"
REAR TYRES	295/30 R20	305/30 R20	305/30 R20	305/30 R20

F-TYPE	—	—	—	—
F-TYPE S	■	—	—	—
F-TYPE S AWD	■	—	—	—
F-TYPE R	■	—	—	—
F-TYPE R AWD	■	—	—	—
F-TYPE SVR	—	●	○	■

● Standard ○ Option — Not available ■ Part of pack
Please consult your local Jaguar retailer for details.

5 CHOOSE YOUR INTERIOR

 Configure your vehicle at jaguar.com

F-TYPE, F-TYPE S AND F-TYPE S AWD						
	SEAT WITH STITCH	UPPER FACIA WITH STITCH	INTERIOR TRIM AND OPTION CODES	HEADLINING	CARPETS	SEATBELTS
Standard						
Sport seats with Leather and Suedecloth facings	Jet with Jet	Jet with Jet	TP01	Jet or Stone	Jet or Cirrus	Jet or Red
	Cirrus with Cirrus	Jet with Jet	TP04	Jet or Stone	Jet or Cirrus	Jet
Optional						
Sport seats with Leather facings	Jet with Jet	Jet with Jet	TP01+B40W	Jet or Stone	Jet or Cirrus	Jet or Red
	Cirrus with Cirrus	Jet with Jet	TP04+B40W	Jet or Stone	Jet or Cirrus	Jet
Sport seats in Premium Leather and Premium Leather interior ¹	Jet with Jet	Jet with Jet	TP01+Z84M	Jet or Stone	Jet or Cirrus	Jet or Red
	Cirrus with Cirrus	Jet with Jet	TP04+Z84M	Jet or Stone	Jet or Cirrus	Jet
Performance seats in Premium Leather and Premium Leather interior ¹	Jet with Jet	Jet with Jet	TP01+B55C+Z84M	Jet, Stone or Red	Jet or Cirrus	Jet or Red
	Jet with Red	Jet with Jet	TP05	Jet or Stone	Jet or Cirrus	Jet or Red
	Jet with Camel	Jet with Jet	TP06	Jet or Stone	Jet or Cirrus	Jet or Camel
	Jet with Firesand	Jet with Jet	TP07	Jet or Stone	Jet or Cirrus	Jet
	Brogue with Ivory	Jet with Jet	TP11	Jet, Stone or Ivory	Jet or Cirrus	Jet
	Red with Jet	Jet with Jet	TP12	Jet, Stone or Red	Jet or Cirrus	Jet or Red
	Camel with Jet	Jet with Jet	TP13	Jet or Stone	Jet or Cirrus	Jet or Camel
	Cirrus with Jet	Jet with Jet	TP27	Jet or Stone	Jet or Cirrus	Jet
	Ivory with Jet	Jet with Jet	TP28	Jet, Stone or Ivory	Jet or Cirrus	Jet
Performance seats in Premium Leather and Suedecloth and Premium Leather interior ¹	Jet with Cirrus	Jet with Cirrus	TP22	Jet Suedecloth	Jet	Jet
Performance seats in Red Premium Leather and Red Premium Leather interior with Jet twin needle contrast stitching ²	Red with Jet	Red with Jet	TP23	Jet or Red	Jet	Jet or Red

F-TYPE R AND F-TYPE R AWD						
	SEAT WITH STITCH	UPPER FACIA WITH STITCH	INTERIOR TRIM AND OPTION CODES	HEADLINING	CARPETS	SEATBELTS
Standard						
Performance seats in Premium Leather with R embossed headrests and Carbon Fibre effect centre strip and Premium Leather interior with twin needle stitching	Jet with Jet	Jet with Jet	TP01	Jet or Stone	Jet	Jet
	Jet with Ivory	Jet with Ivory	TP17	Jet, Stone or Ivory ⁴	Jet	Jet
	Jet with Red	Jet with Red	TP24	Jet or Stone	Jet	Jet or Red
	Jet with Firesand	Jet with Firesand	TP18	Jet or Stone	Jet	Jet
Performance seats in Premium Leather with R embossed headrests and Premium Leather interior with twin needle stitching	Camel and Jet duotone with Camel	Jet with Camel	TP21	Jet or Stone	Jet	Jet or Camel
	Ivory and Jet duotone with Ivory	Jet with Ivory	TP20	Jet, Stone or Ivory ⁴	Jet	Jet
	Red and Jet duotone with Red	Jet with Red	TP19	Jet, Stone or Red	Jet	Jet or Red
Optional						
Performance seats in Premium Leather and Suedecloth and Premium Leather interior	Jet with Cirrus	Jet with Cirrus	TP22	Jet Suedecloth	Jet	Jet
Performance seats in Red Premium Leather and Red Premium Leather interior with Jet twin needle contrast stitching ²	Red with Jet	Red with Jet	TP23	Jet or Red	Jet	Jet or Red
F-TYPE SVR						
	SEAT WITH STITCH	UPPER FACIA WITH STITCH	INTERIOR TRIM AND OPTION CODES	HEADLINING	CARPETS	SEATBELTS
Standard						
Quilted Performance seats in Premium Leather with SVR embossed headrests with twin needle stitching and Suedecloth driver's Instrument Panel area	Jet with Cirrus	Jet with Cirrus	TP31	Jet	Jet	Jet
	Jet with Red	Jet with Red	TP30	Jet or Red	Jet	Jet or Red
	Jet with Reims Blue	Jet with Reims Blue	TP32	Jet	Jet	Jet
Optional						
Quilted Performance seats in Premium Leather with SVR embossed headrests with twin needle stitching and extended Leather upper facia ³	Red with Jet	Red with Jet	TP23	Jet or Red	Jet	Red
	Siena Tan with Cirrus	Siena Tan with Cirrus	TP34	Jet	Jet	Jet

¹Premium Leather interior adds Premium Leather to the upper facia, centre console and door casings.

²Includes Red Premium Leather passenger side upper facia, upper door casings, centre console and Jet carpet mats with Red Leather edging and Jet contrast stitching.

³Includes coloured Premium Leather passenger side upper facia, upper door facings, centre console and Jet carpet mats with coloured Leather edging and contrast stitching.

⁴Ivory Leather headlining not available with panoramic roof.

Please consult your retailer for details.

5 CHOOSE YOUR INTERIOR

⚙️ Configure your vehicle at [jaguar.com](https://www.jaguar.com)









Interior shown: Jet Leather and Suedecloth Sport seats with Light Hex Aluminium finisher with Jet Morzine headlining, Jet upper facia and Jet carpets.

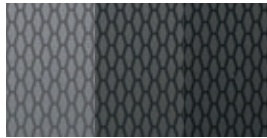

F-TYPE, F-TYPE S AND F-TYPE S AWD

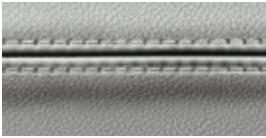
INTERIOR COLOUR COMBINATIONS

STANDARD LEATHER AND SUEDECLOTH FACINGS, OPTIONAL LEATHER FACINGS AND OPTIONAL PREMIUM LEATHER INTERIOR

①	②	③	④	⑤
SEAT WITH STITCH	FINISHER	HEADLINING*	UPPER FACIA WITH STITCH	CARPET
				
Jet with Jet	Light, Dark or Black Hex†	Jet or Stone	Jet with Jet	Jet or Cirrus
				
Cirrus with Cirrus	Light, Dark or Black Hex†	Jet or Stone	Jet with Jet	Jet or Cirrus

OPTIONAL PERFORMANCE SEATS IN PREMIUM LEATHER AND PREMIUM LEATHER INTERIOR

SEAT WITH STITCH	FINISHER	HEADLINING*	UPPER FACIA WITH STITCH	CARPET
				
Jet with Jet	Light, Dark or Black Hex†	Jet or Stone	Jet with Jet	Jet or Cirrus
				
Jet with Red	Light, Dark or Black Hex†	Jet, Stone or Red**	Jet with Jet	Jet or Cirrus

*Jet Morzine standard, Stone Morzine and Jet Suedecloth optional.











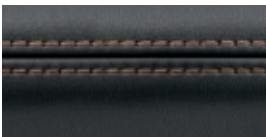

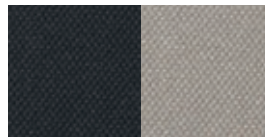

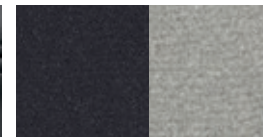
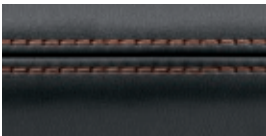

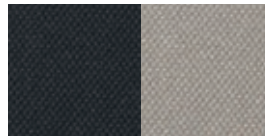

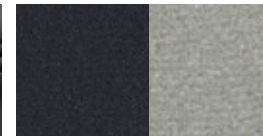

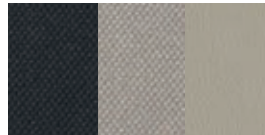
**Red headlining on convertible only.

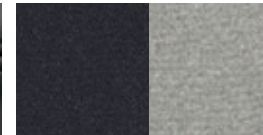
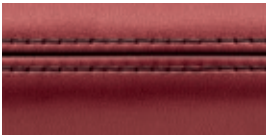
†Black Hex Aluminium console finisher only available with Interior Black Pack.

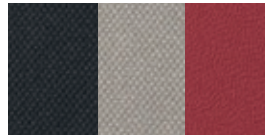
F-TYPE, F-TYPE S AND F-TYPE S AWD

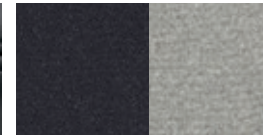
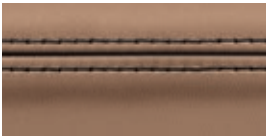
INTERIOR COLOUR COMBINATIONS

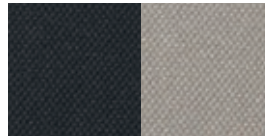
OPTIONAL PERFORMANCE SEATS IN PREMIUM LEATHER AND PREMIUM LEATHER INTERIOR [CONTINUED]

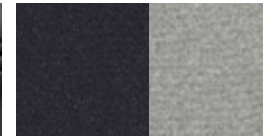
1	2	3	4	5
SEAT WITH STITCH	FINISHER	HEADLINING*	UPPER FACIA WITH STITCH	CARPET
 Jet with Camel	 Light, Dark or Black Hex [†]	 Jet or Stone	 Jet with Jet	 Jet or Cirrus
 Jet with Firesand	 Light, Dark or Black Hex [†]	 Jet or Stone	 Jet with Jet	 Jet or Cirrus
 Brogue with Ivory	 Light, Dark or Black Hex [†]	 Jet, Stone or Ivory [‡]	 Jet with Jet	 Jet or Cirrus
 Red with Jet	 Light, Dark or Black Hex [†]	 Jet, Stone or Red ^{**}	 Jet with Jet	 Jet or Cirrus
 Camel with Jet	 Light, Dark or Black Hex [†]	 Jet or Stone	 Jet with Jet	 Jet or Cirrus

*Jet Morzine standard, Stone Morzine and Jet Suedecloth optional.

**Red headlining available on Convertible only.

†Black Hex Aluminium console finisher only available with Interior Black Pack.

‡Ivory Leather headlining not available with Panoramic Glass Roof.

OPTIONAL PERFORMANCE SEATS IN PREMIUM LEATHER AND PREMIUM LEATHER INTERIOR [CONTINUED]

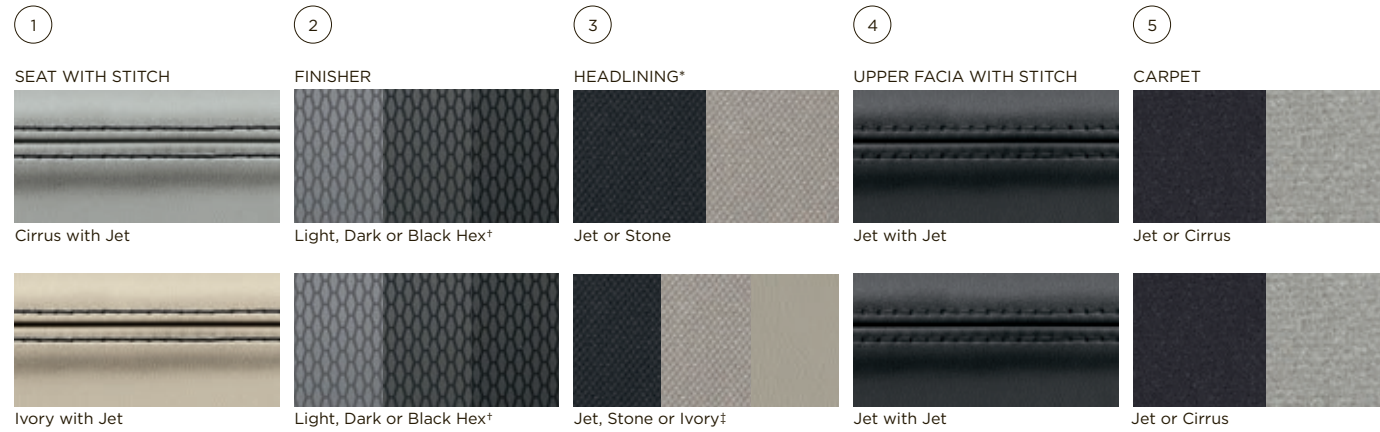

PERFORMANCE SEATS IN PREMIUM LEATHER AND SUEDECLOTH AND PREMIUM LEATHER INTERIOR



PERFORMANCE SEATS IN RED PREMIUM LEATHER AND RED PREMIUM LEATHER INTERIOR WITH JET TWIN NEEDLE CONTRAST STITCHING**



5 CHOOSE YOUR INTERIOR

⚙️ Configure your vehicle at [jaguar.com](https://www.jaguar.com)









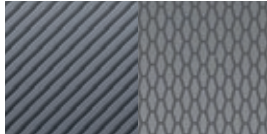
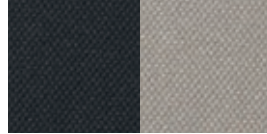

Interior shown: Red Premium Leather Performance seats with Dark Linear Aluminium finisher, Jet headlining, Red upper facia and Jet carpets.

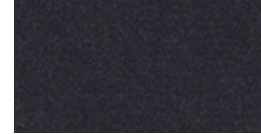

F-TYPE R AND F-TYPE R AWD

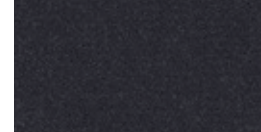
INTERIOR COLOUR COMBINATIONS

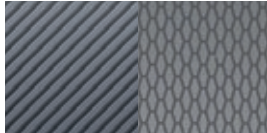
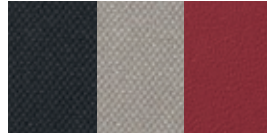
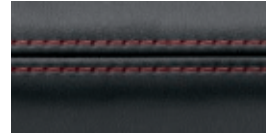
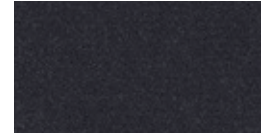
STANDARD R-PERFORMANCE SEATS WITH PREMIUM LEATHER AND PREMIUM LEATHER INTERIOR WITH TWIN NEEDLE STITCHING

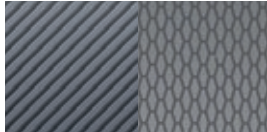
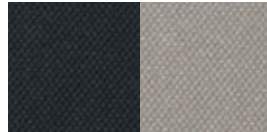
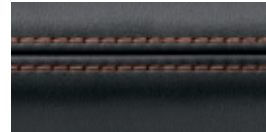
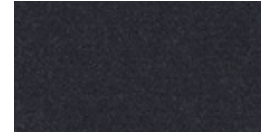
1	2	3	4	5
SEAT WITH STITCH	FINISHER	HEADLINING*	UPPER FACIA WITH STITCH	CARPET
 Jet with Jet	 Dark Linear or Light Hex	 Jet or Stone	 Jet with Jet	 Jet
 Jet with Ivory	 Dark Linear or Light Hex	 Jet, Stone or Ivory†	 Jet with Ivory	 Jet
 Jet with Red	 Dark Linear or Light Hex	 Jet, Stone or Red**	 Jet with Red	 Jet
 Jet with Firesand	 Dark Linear or Light Hex	 Jet or Stone	 Jet with Firesand	 Jet

*Jet Morzine standard, Stone Morzine and Jet Suedecloth optional.







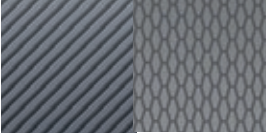
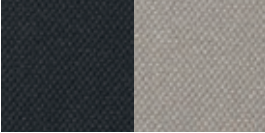

**Red headlining available on Convertible only.

†Ivory Leather headlining not available with Panoramic Glass Roof.

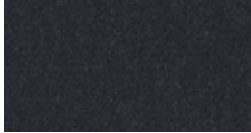
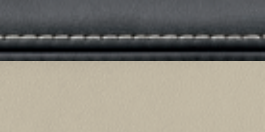
F-TYPE R AND F-TYPE R AWD

INTERIOR COLOUR COMBINATIONS

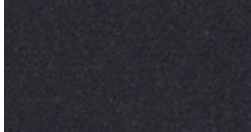
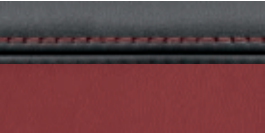
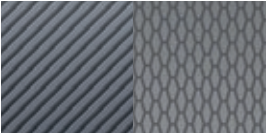
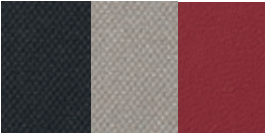
STANDARD R-PERFORMANCE SEATS WITH PREMIUM LEATHER AND PREMIUM LEATHER INTERIOR WITH TWIN NEEDLE STITCHING [CONTINUED]

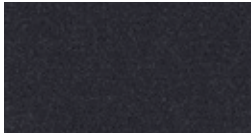
1	2	3	4	5
DUOTONE SEAT WITH STITCH	FINISHER	HEADLINING*	UPPER FACIA WITH STITCH	CARPET
				
Jet with Camel	Dark Linear or Light Hex	Jet or Stone	Jet with Camel	Jet
				
Jet with Ivory	Dark Linear or Light Hex	Jet, Stone or Ivory‡	Jet with Ivory	Jet
				
Jet with Red	Dark Linear or Light Hex	Jet, Stone or Red**	Jet with Red	Jet

*Jet Morzine standard, Stone Morzine and Jet Suedecloth optional.

**Red headlining available on Convertible only.

‡Ivory Leather headlining not available with Panoramic Glass Roof.

OPTIONAL R-PERFORMANCE SEATS IN PREMIUM LEATHER AND SUEDECLOTH AND PREMIUM LEATHER INTERIOR WITH TWIN NEEDLE STITCHING



OPTIONAL R-PERFORMANCE SEATS IN RED PREMIUM LEATHER AND RED PREMIUM LEATHER INTERIOR WITH JET TWIN NEEDLE CONTRAST STITCHING**



5 CHOOSE YOUR INTERIOR

⚙️ Configure your vehicle at [jaguar.com](https://www.jaguar.com)











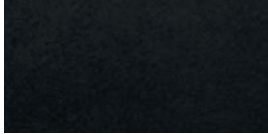

Interior shown: Siena Tan Quilted Premium Leather Performance seats with Cirrus stitch and Cirrus micro-piping, Dark Brushed Aluminium finisher with Jet Suedecloth headlining, Siena Tan upper fascia and Jet carpets.

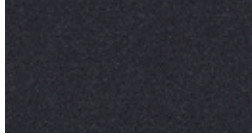

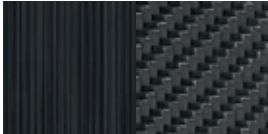

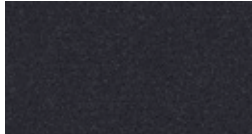
F-TYPE SVR

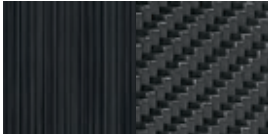
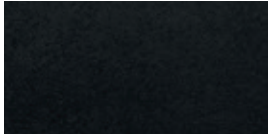
INTERIOR COLOUR COMBINATIONS

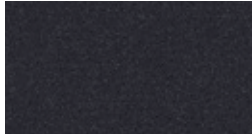
STANDARD SVR QUILTED PREMIUM LEATHER PERFORMANCE SEATS WITH PREMIUM LEATHER AND SUEDECLOTH INTERIOR WITH TWIN NEEDLE STITCHING

1	2	3	4	5
SEAT WITH STITCH	FINISHER	HEADLINING*	UPPER FACIA WITH STITCH	CARPET
				
Jet with Cirrus	Dark Brushed Aluminium or Carbon Fibre	Jet	Jet with Cirrus	Jet
				
Jet with Red	Dark Brushed Aluminium or Carbon Fibre	Jet or Red**	Jet with Red	Jet
				
Jet with Reims Blue	Dark Brushed Aluminium or Carbon Fibre	Jet	Jet with Reims Blue	Jet

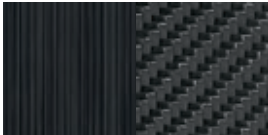
OPTIONAL SVR QUILTED PREMIUM LEATHER PERFORMANCE SEATS WITH PREMIUM LEATHER INTERIOR WITH TWIN NEEDLE STITCHING

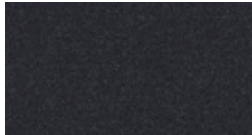
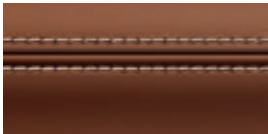
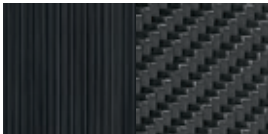
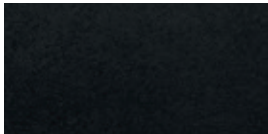
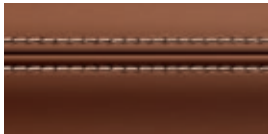
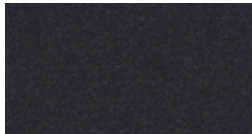
SEAT WITH STITCH	FINISHER	HEADLINING*	UPPER FACIA WITH STITCH	CARPET
				
Red with Jet	Dark Brushed Aluminium or Carbon Fibre	Jet or Red**	Red with Jet	Jet
				
Siena Tan with Cirrus	Dark Brushed Aluminium or Carbon Fibre	Jet	Siena Tan with Cirrus	Jet

*Jet Suedecloth standard. Jet Leather optional.

**Red Leather headlining only available on Convertible.

5 CHOOSE YOUR INTERIOR

 Configure your vehicle at [jaguar.com](https://www.jaguar.com)

Light Hex Aluminium Centre Console

Dark Hex Aluminium Centre Console

Black Hex Aluminium Centre Console

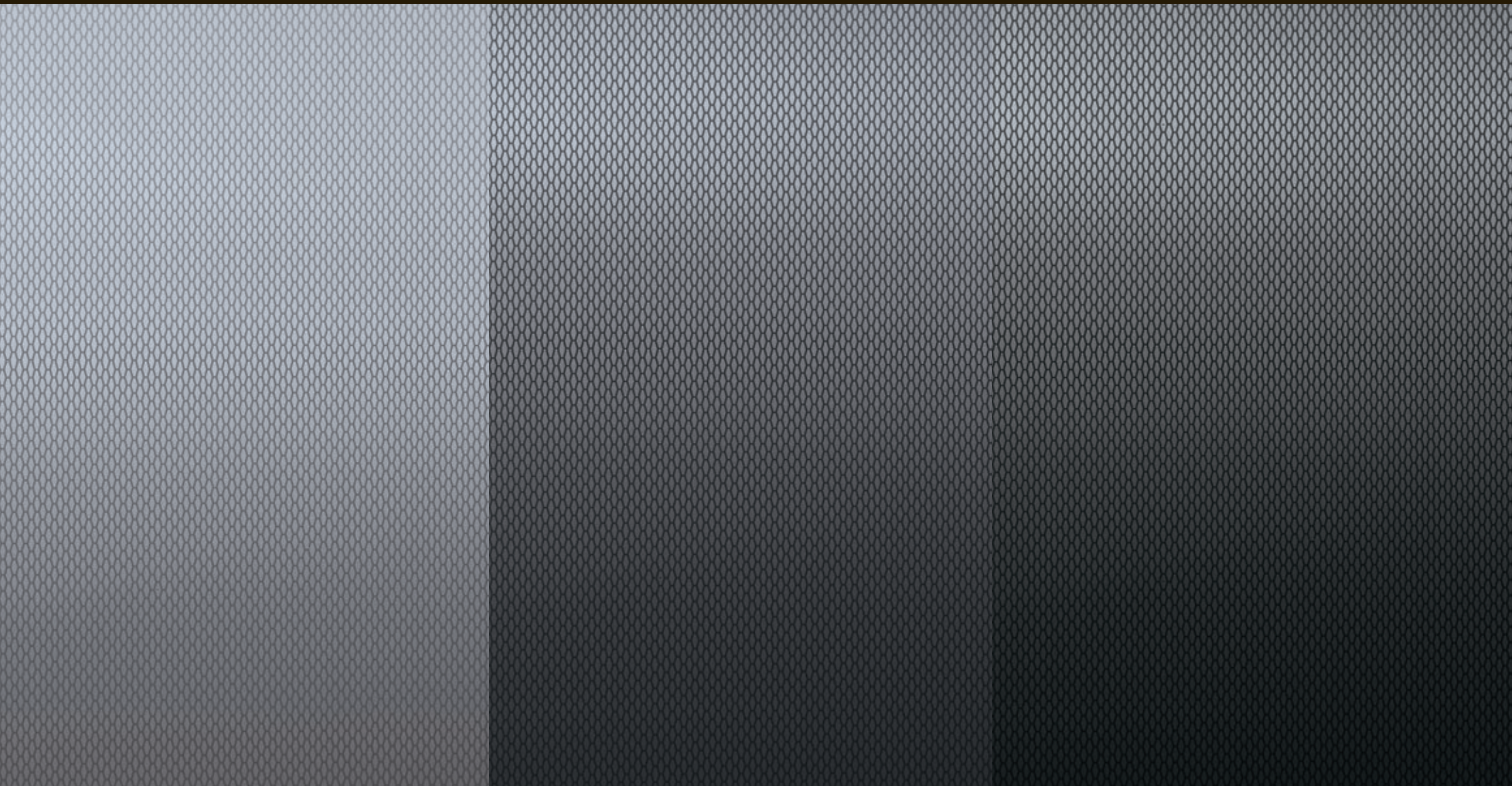

Dark Linear Aluminium with R Graphic Centre Console



Dark Brushed Aluminium with SVR Graphic Centre Console

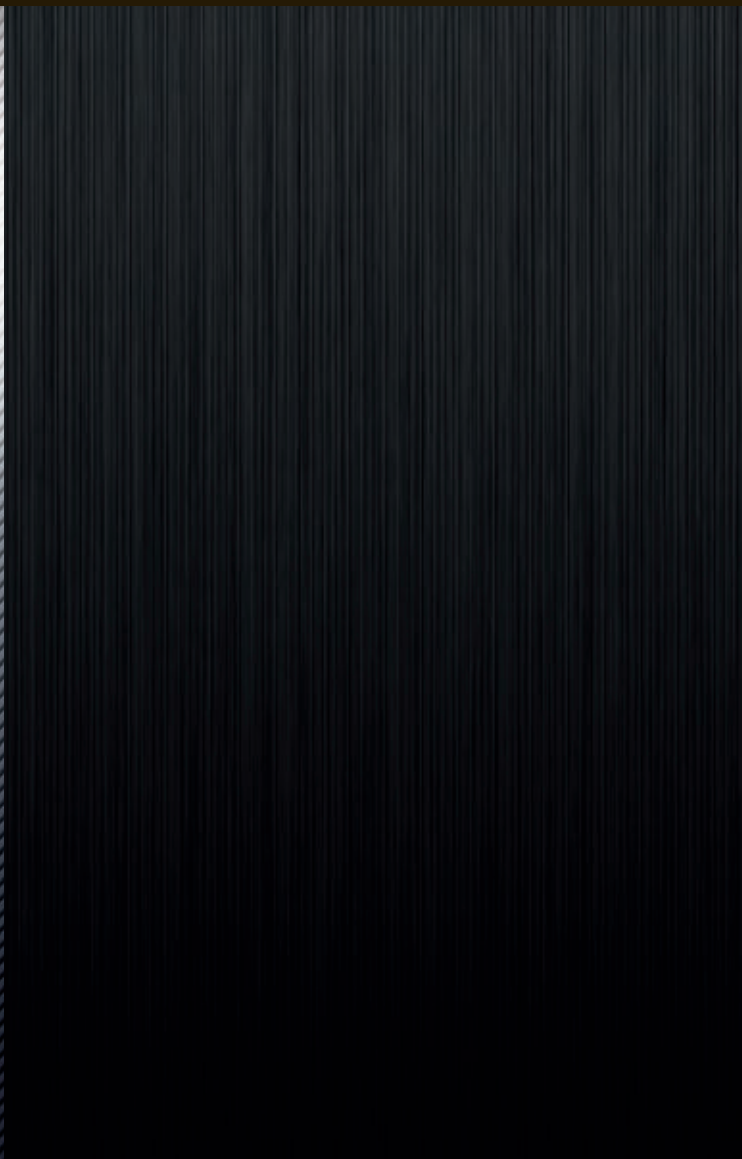

Carbon Fibre with SVR Graphic Centre Console



6 CHOOSE YOUR JAGUAR ACCESSORIES

To find out more about the full range of retailer fit Jaguar Accessories, please refer to your retailer or go to accessories.jaguar.com



**F-TYPE S in Caldera Red with Carbon Fibre Pack
and 20 inch Rotor Gloss Black/Carbon Fibre alloy wheels**



Personalised Illuminated Sill Treadplates
T2R6091

Elegantly styled stainless steel sill treadplates finishers for driver or passenger doors. Illuminates when either the driver or passenger doors are opened. Highlighted by soft phosphor blue lighting. Allows customer to specify a monochrome 'motif' in a choice of approved typefaces/scripts.



Chrome Gearshift Paddles
T2R6547MMU

Replacement steering wheel gearshift paddles offered in a premium Chrome material providing a high quality finish to a key contact point in the vehicle.



Carbon Fibre Console Finisher
T2R5267

Exclusive premium finish for the centre console offered in a Satin finish to minimise glare and reflections. Comprises Carbon Fibre centre console, centre dial and centre fascia replacement trim.



Sports Pedal Covers (Automatic)
C2P23554

Made from stainless steel and rubber, the pedal kit fits securely over existing pedals for a contemporary, sporting appearance.



Premium Carpet Mats
T2R16570PVJ - Left Hand Drive
T2R16571PVJ - Right Hand Drive

Luxurious, tailored 2,050g/m2 pile front carpet mats with embossed Jaguar logo and nubuck edge binding. The premium mats provide a well appointed finishing touch to the interior.



Premium Luggage Compartment Carpet Mat
T2R11270PVJ

Luxurious soft luggage mat in Jet Black with the Jaguar logo. Deep premium 2,050g/m2 pile with nubuck edging.

6 CHOOSE YOUR JAGUAR ACCESSORIES

 Configure your vehicle at jaguar.com



Chrome Side Power Vents
T2R2262 - Left Side
T2R2263 - Right Side

Add distinctive sporting style to your vehicle with Chrome finish side power vents with Gloss Black mesh infill panel. Left and right side options available.



Carbon Fibre Side Power Vents
T2R5394 - Left Side
T2R5393 - Right Side

High grade Carbon Fibre side power vents provide a performance-inspired styling upgrade. Left and right side options available.



Carbon Fibre Bonnet Louvres*
T2R5275PEC - Left Side RWD T2R5274PEC - Right Side RWD
T2R16704 - Left Side AWD T2R16703 - Right Side AWD

High grade Carbon Fibre bonnet louvre featuring a 2x2 twill weave and a High Gloss lacquered finish. Provides a performance-inspired styling enhancement coupled with weight benefits associated with Carbon Fibre. Left and right side options available.



Chrome Mirror Covers
T2R5399 - Left Side
T2R5400 - Right Side

Chrome mirror covers accentuate the stylish design of the exterior mirrors. Left and right side options available.



Carbon Fibre Mirror Covers
T2R5390 - Left Side
T2R5389 - Right Side

High grade Carbon Fibre mirror covers provide a performance-inspired styling upgrade. Left and right side options available.



Carbon Fibre Front Splitter Blade
T2R12001

Premium exterior styling upgrade to highlight the dynamic capabilities of the F-TYPE. Kit includes lower centre section of the bumper along with the two outer splitters in a premium high grade Carbon Fibre with a 2x2 twill weave and a High Gloss lacquered finish. Provides a performance-inspired styling enhancement coupled with weight benefits associated with Carbon Fibre.

*Not applicable for AWD models.

**Available for F-TYPE Convertible only.



Carbon Fibre Roll Hoops**
T2R5396 - Left Side
T2R5395 - Right Side

High grade Carbon Fibre roll hoops featuring a 2x2 twill weave and a High Gloss lacquered finish. Provides a performance-inspired styling enhancement coupled with weight benefits associated with Carbon Fibre. Left and right side options available.



Rear Mounted Ski Carrier
T2R13769 - V6
T2R11987 - V8

Carrying up to two pairs of skis of up to 1.9m in length, this lockable carrier has been designed to ensure skis remain at ambient temperature in transit with minimal wind noise and resistance. Mounting mechanism has been positioned discreetly beneath the rear bumper ensuring a clean finish when the carrier mounting arms are removed. Following initial retailer installation the carrier can be removed easily in a matter of minutes.



Carbon Fibre Engine Cover
T2R8019

Carbon Fibre engine cover provides weight benefits and premium finish to the engine compartment. Features Jaguar branding.



Chrome Roll Hoops**
T2R5402 - Left Side
T2R5401 - Right Side

Bright finish accents highlight the F-TYPE exterior styling cues. Left and right side options available.



Wind Deflector**
T2R6106

Simple to fit and remove, the wind deflector reduces air draught and turbulence in the passenger compartment, even at high speeds. Supplied with a Jaguar branded stowage bag. Optional roll hoops shown.



All Weather Car Cover
T2R4364

All-weather tailored cover for the F-TYPE with the Jaguar logo. Protect your F-TYPE from the elements, including showers, frost and dust. Quick and easy to fit.

TECHNICAL SPECIFICATIONS

 Configure your vehicle at jaguar.com

ENGINES		F-TYPE JAGUAR 3.0 LITRE V6 340 SUPERCHARGED PETROL				F-TYPE S JAGUAR 3.0 LITRE V6 380 SUPERCHARGED PETROL			
Cylinders/Valves per Cylinder		6/4				6/4			
Bore/Stroke	mm	84.5/89				84.5/89			
Capacity	cc	2,995				2,995			
Maximum power	EEC-PS (kW)	340 (250)				380 (280)			
@rev/min		6,500				6,500			
Maximum torque	EEC-Nm (lb.ft.)	450 (332)				460 (339)			
@rev/min		3,500 - 5,000				3,500 - 5,000			
Compression	ratio:1	10.5				10.5			
PERFORMANCE		COUPÉ		CONVERTIBLE		COUPÉ		CONVERTIBLE	
		MANUAL	AUTOMATIC	MANUAL	AUTOMATIC	MANUAL	AUTOMATIC	MANUAL	AUTOMATIC
0-100 km/h	seconds	5.7	5.3	5.7	5.3	5.5	4.9	5.5	4.9
0-60 mph	seconds	5.5	5.1	5.5	5.1	5.3	4.8	5.3	4.8
80-120 km/h (manual in 5 th gear)	seconds	7.2	3.3	7.2	3.3	7.2	3.1	7.2	3.1
50-75 mph (manual in 5 th gear)	seconds	7.2	3.3	7.2	3.3	7.2	3.1	7.2	3.1
Top speed	km/h (mph)	260 (161)	260 (161)	260 (161)	260 (161)	275 (171)	275 (171)	275 (171)	275 (171)
FUEL CONSUMPTION ¹		COUPÉ		CONVERTIBLE		COUPÉ		CONVERTIBLE	
		MANUAL	AUTOMATIC	MANUAL	AUTOMATIC	MANUAL	AUTOMATIC	MANUAL	AUTOMATIC
Urban	l/100km (mpg)	13.5 (20.9)	11.7 (24.1)	13.5 (20.9)	11.7 (24.1)	13.5 (20.9)	12.0 (23.5)	13.5 (20.9)	12.0 (23.5)
Extra Urban	l/100km (mpg)	7.6 (37.2)	6.5 (43.5)	7.6 (37.2)	6.5 (43.5)	7.6 (37.2)	6.6 (42.8)	7.6 (37.2)	6.6 (42.8)
Combined	l/100km (mpg)	9.8 (28.8)	8.4 (33.6)	9.8 (28.8)	8.4 (33.6)	9.8 (28.8)	8.6 (32.9)	9.8 (28.8)	8.6 (32.9)
Carbon dioxide emissions	g/km	234	199	234	199	234	203	234	203
Tank capacity (usable)	ltr (gals) approx.	70.0 (15.4)	70.0 (15.4)	70.0 (15.4)	70.0 (15.4)	70.0 (15.4)	70.0 (15.4)	70.0 (15.4)	70.0 (15.4)
DIMENSIONS		COUPÉ		CONVERTIBLE		COUPÉ		CONVERTIBLE	
Overall length	mm	4,470		4,470		4,470		4,470	
Overall width (inc. mirrors)	mm	2,042		2,042		2,042		2,042	
Overall width (exc. mirrors)	mm	1,923		1,923		1,923		1,923	
Overall height	mm	1,311		1,308		1,311		1,308	
Wheelbase	mm	2,622		2,622		2,622		2,622	
Front track	mm	1,597		1,597		1,597		1,597	
Rear track	mm	1,649		1,649		1,649		1,649	
Ground clearance	mm	101		101		101		101	
Turning circle diameter (kerb to kerb)	m (ft.in.)	10.7 (35.0)		10.7 (35.0)		10.7 (35.0)		10.7 (35.0)	
Convertible boot volume	litres (cu.ft.)	—		207 (7.3)		—		207 (7.3)	
Coupé boot volume with parcel tray	litres (cu.ft.)	310 (10.9)		—		310 (10.9)		—	
Coupé boot volume without parcel tray	litres (cu.ft.)	408 (14.4)		—		408 (14.4)		—	
WEIGHT ²		COUPÉ		CONVERTIBLE		COUPÉ		CONVERTIBLE	
		MANUAL	AUTOMATIC	MANUAL	AUTOMATIC	MANUAL	AUTOMATIC	MANUAL	AUTOMATIC
Weight from	kg	1,567	1,577	1,587	1,597	1,584	1,594	1,604	1,614
Gross vehicle weight	kg	2,000	2,000	2,000	2,000	2,050	2,050	2,050	2,050

¹The fuel consumption figures were obtained in tests carried out in line with the Passenger Car Fuel Consumption and CO₂ Emissions Information Regulations 2001 (Reflecting EU Directive 80/1268/EEC as amended by 2004/3/EC). These figures are correct at time of going to press. ²Please consult your retailer for details of charges associated with option fitment. Weights reflect vehicles to standard specifications. Optional extras increase weight.

F-TYPE S JAGUAR 3.0 LITRE V6 380 SUPERCHARGED PETROL AWD		F-TYPE R JAGUAR 5.0 LITRE V8 550 SUPERCHARGED PETROL		F-TYPE R JAGUAR 5.0 LITRE V8 550 SUPERCHARGED PETROL AWD		F-TYPE SVR JAGUAR 5.0 LITRE V8 575 SUPERCHARGED PETROL AWD	
6/4		8/4		8/4		8/4	
84.5/89		92.5/93		92.5/93		92.5/93	
2,995		5,000		5,000		5,000	
380 (280)		550 (405)		550 (405)		575 (423)	
6,500		6,500		6,500		6,500	
460 (339)		680 (502)		680 (502)		700 (516)	
3,500 - 5,000		3,500		3,500		3,500 - 5,000	
10.5		9.5		9.5		9.5	
COUPÉ AUTOMATIC	CONVERTIBLE AUTOMATIC	COUPÉ AUTOMATIC	CONVERTIBLE AUTOMATIC	COUPÉ AUTOMATIC	CONVERTIBLE AUTOMATIC	COUPÉ AUTOMATIC	CONVERTIBLE AUTOMATIC
5.1	5.1	4.2	4.2	4.1	4.1	3.7	3.7
4.9	4.9	4.0	4.0	3.9	3.9	3.5	3.5
3.3	3.3	2.4	2.4	2.5	2.5	2.3	2.3
3.3	3.3	2.4	2.4	2.5	2.5	2.3	2.3
275 (171)	275 (171)	300 (186)	300 (186)	300 (186)	300 (186)	322 (200)	314 (195)
COUPÉ AUTOMATIC	CONVERTIBLE AUTOMATIC	COUPÉ AUTOMATIC	CONVERTIBLE AUTOMATIC	COUPÉ AUTOMATIC	CONVERTIBLE AUTOMATIC	COUPÉ AUTOMATIC	CONVERTIBLE AUTOMATIC
12.4 (22.8)	12.4 (22.8)	15.3 (18.5)	15.3 (18.5)	16.2 (17.4)	16.2 (17.4)	16.2 (17.4)	16.2 (17.4)
6.9 (40.9)	6.9 (40.9)	8.0 (35.3)	8.0 (35.3)	8.5 (33.2)	8.5 (33.2)	8.5 (33.2)	8.5 (33.2)
8.9 (31.7)	8.9 (31.7)	10.7 (26.4)	10.7 (26.4)	11.3 (25.0)	11.3 (25.0)	11.3 (25.0)	11.3 (25.0)
211	211	255	255	269	269	269	269
70.0 (15.4)	70.0 (15.4)	70.0 (15.4)	70.0 (15.4)	70.0 (15.4)	70.0 (15.4)	70.0 (15.4)	70.0 (15.4)
COUPÉ	CONVERTIBLE	COUPÉ	CONVERTIBLE	COUPÉ	CONVERTIBLE	COUPÉ	CONVERTIBLE
4,470	4,470	4,470	4,470	4,470	4,470	4,475	4,475
2,042	2,042	2,042	2,042	2,042	2,042	2,042	2,042
1,923	1,923	1,923	1,923	1,923	1,923	1,923	1,923
1,311	1,308	1,311	1,308	1,311	1,308	1,311	1,308
2,622	2,622	2,622	2,622	2,622	2,622	2,622	2,622
1,597	1,597	1,585	1,585	1,585	1,585	1,585	1,585
1,649	1,649	1,627	1,627	1,627	1,627	1,611	1,611
104	104	101	101	100	100	107	107
11.3 (37.0)	11.3 (37.0)	10.7 (35.0)	10.7 (35.0)	11.3 (37.0)	11.3 (37.0)	11.3 (37.0)	11.3 (37.0)
—	207 (7.3)	—	207 (7.3)	—	207 (7.3)	—	207 (7.3)
310 (10.9)	—	310 (10.9)	—	310 (10.9)	—	310 (10.9)	—
408 (14.4)	—	408 (14.4)	—	408 (14.4)	—	408 (14.4)	—
COUPÉ AUTOMATIC	CONVERTIBLE AUTOMATIC	COUPÉ AUTOMATIC	CONVERTIBLE AUTOMATIC	COUPÉ AUTOMATIC	CONVERTIBLE AUTOMATIC	COUPÉ AUTOMATIC	CONVERTIBLE AUTOMATIC
1,674	1,694	1,650	1,665	1,730	1,745	1,705	1,720
2,150	2,150	2,050	2,050	2,150	2,150	2,150	2,150

DIMENSIONS

Dimensions shown are based upon F-TYPE R, Coupé and Convertible. For details of all derivatives please refer to the Technical Specifications page 112 and 113.

Overall Width (inc mirrors) 2,042mm

Overall Width (exc mirrors) 1,923mm

Boot Volume 408 litres (Coupé) 207 litres (Convertible)



Turning Circle
Kerb to Kerb 10.7m



Dimensions were measured with vehicle at unladen weight. (Measured by VDA standard test method using 200 x 100 x 50mm blocks; second value: with rear seat folded down).
VEHICLE SHOWN F-TYPE R IN POLARIS WHITE WITH OPTIONAL EXTRAS (MARKET DEPENDENT)

JAGUAR EXPERIENCE

There's no better way to get to know Jaguar than by taking a drive. The Jaguar Experience offers a range of unique opportunities to really find out what it feels like to get the most out of a Jaguar. Our track experiences allow you to push yourself and cars from the incredible Jaguar range to the limit. Jaguar Experience also offers the opportunity to see a Jaguar brought to life during a tour of one of our UK manufacturing facilities.

Find out more by visiting jaguar.com/experience



BEHIND THE SCENES

Our factory tours give you the unique opportunity to experience the whole process of how our cars are brought to life - from the moulding of sheet metal to those intricate final touches. At our state-of-the-art production facilities, you'll get to see how skilled technicians and sophisticated machines work seamlessly together to perfect some of Jaguar's most breathtaking cars - from the powerful F-TYPE to the groundbreaking F-PACE performance SUV.

Find out more at jaguar.com/experience-jaguar/behind-the-scenes



DRIVING EXPERIENCES

The opportunity to drive the latest Jaguar cars at their limits, or relive iconic Jaguar history, is rare. Jaguar Driving Experiences offer unique driving adventures you will never forget. Imagine yourself behind the wheel of our highest performing Jaguar models, on a private track, with a Jaguar Experience Instructor at your side. This is the Jaguar Performance Driving Academy.

Find out more at [jaguar.com/experience-jaguar/driving-experiences](https://www.jaguar.com/experience-jaguar/driving-experiences)



ICONIC EXPERIENCES

Take your driving to the next level with our international adventures facing extreme on-road, and off-road, conditions. Our Iconic Experiences offer journeys and challenges that will test and develop your performance driving skills. Every year, Jaguar customers and enthusiasts join us for our luxury Ice Driving Experience. The exclusive ski resort in Gstaad, Switzerland, is the perfect location to enjoy the thrill of performance driving on ice. Our Ice Driving Experience is a two-day getaway held each winter. You can get a flavour of the event below. Then, if you'd like to be part of it in the next experience, we can keep you posted.

Find out more by visiting [jaguar.com/experience-jaguar/iconic-experiences](https://www.jaguar.com/experience-jaguar/iconic-experiences)

THE WORLD OF JAGUAR

Choose an F-TYPE and you're joining the exciting World of Jaguar. It makes owning and driving carefree and easy, as well as providing a range of exclusive services and lifestyle products.



JAGUAR CARE*

F-TYPE is now offered with a new unlimited mileage, three year warranty and three years' servicing programme at no additional cost. We call this programme Jaguar Care. It makes F-TYPE's overall cost of ownership one of the lowest in its class.



GENUINE PARTS

Jaguar Genuine Parts are designed, tested and manufactured to our uncompromising standards for quality, fit and durability. Each part is engineered specifically for your F-TYPE to contribute to optimum performance and to help maximise its lifespan.



JAGUAR FINANCIAL SERVICES

Effortless performance and style come as standard with every Jaguar. Jaguar Financial Services makes buying one just as simple and rewarding. New or used, for personal or business use, we have an option that puts you in complete control. Please speak to your local Jaguar retailer to find out more.

*Available on selected European markets only



JAGUAR ASSISTANCE

Jaguar Assistance provides assistance in motoring emergencies, all the way from immobilisation due to breakdown or accident to minor problems such as punctures. You can rely on our roadside assistance, whatever the situation, wherever you happen to be.



FLEET & BUSINESS

Jaguar is dedicated to being the premium manufacturer of choice for fleets and businesses by providing a highly attractive car range and exemplary customer service. Jaguars are dynamic and distinctive cars that help companies express the unique character and personality of their business. We are committed to providing totally customer-focused aftersales services, which keeps every Jaguar car on the move and in top condition, ensuring that they perform to the highest standard and in the most cost-efficient way for businesses. Visit jaguar.com/fleet-and-business for more information.



JAGUAR MAGAZINE

Jaguar Magazine is the official magazine of Jaguar Cars. It features the Jaguar F-TYPE, F-PACE, XJ, XE and XF, and the worlds of luxury, style, design and travel.

JAGUAR MERCHANDISE

The latest Jaguar Collection has been crafted with the same design execution and attention to detail that goes into all of our cars. This is evident in our clothing range, premium leather items and luxury travel goods. To celebrate Jaguar's heritage we also have a collection that honours past achievements and features race inspired gift items and apparel. To find out more, visit the online shop at www.jaguar.co.uk/shop

GLOSSARY

A

ABS SYSTEM

This anti-lock braking system prevents wheel lock up under heavy braking to maintain vehicle control.

ACTIVE SPORTS EXHAUST

This system features active valves that, when open, allow the exhaust gases to exit via a more direct route producing a richer, more exhilarating noise. The system also allows the driver to use a button on the centre console (if optioned) to manually activate the valves.

AMBIENT INTERIOR MOOD LIGHTING

Ambient Interior Mood Lighting highlights many of the cabin's key features and design details in a relaxing soft phosphor blue glow.

C

CABIN CORRECTION ALGORITHM

Meridian's Cabin Correction Algorithm intelligently and discreetly optimises the audio system to the precise acoustics of the vehicle cabin, preserving the natural rhythm of the performance.

CAE DEVELOPMENT PROCESS

Computer-Aided Engineering (CAE) is the usage of computer models and software to aid engineering analysis.

COMBUSTION CHAMBER

A Combustion Chamber is the part of an engine where the fuel and air mixture is burned.

D

DIE-CAST ALUMINIUM BLOCKS

Die-casting is a metal casting process used to form the aluminium blocks for F-TYPE's engines. It involves forcing molten metal under high pressure into a mould. This allows for excellent dimensional accuracy and the casting of thinner walls.

DSP AMPLIFIER

Meridian's Digital Signal Processing (DSP) technology analyses a range of variables that may impact audio quality, then processes them using sophisticated algorithms and adapts the system's output accordingly. This enables a level of powerful, authentic performance impossible with a conventional sound system.

DUAL INDEPENDENT VARIABLE CAMSHAFT TIMING

Dual Independent Variable Camshaft Timing is a feature whereby the engine can adjust the timing of both the intake and exhaust valves independently. This allows for improved power and torque, particularly at lower engine revs, as well as improved fuel economy and reduced emissions.

DAMPERS/DAMPING

Dampers absorb forces acting on the suspension for greater ride comfort and control. Dampers are also known as shock absorbers.

F

FORGED ALUMINIUM DOUBLE WISHBONE SUSPENSION

F-TYPE's front and rear double wishbone suspension is an independent suspension design using two wishbone-shaped arms to place the wheel. Double wishbone designs deliver precise handling and steering response.

I

INCONEL®

Inconel is a family of austenite nickel-chromium-based superalloys. Inconel alloys are oxidation and corrosion resistant materials well suited for service in extreme environments subjected to pressure and heat.

INTELLIGENT STOP/START

Stop/Start is a technology that stops the engine when it is not needed, improving the fuel economy and reducing the car's CO₂ emissions. The engine will restart immediately as soon as the driver's foot comes off the brake pedal. The engine will be operating at full capacity before the driver's foot has touched the accelerator pedal.

M

MANUAL MODE

Manual Mode is a mode available on automatic transmissions that allows you to manually upshift and downshift.

MERIDIAN TRIFIELD TECHNOLOGY

Meridian's exclusive Trifield technology, delivers a consistent, concert-like experience, optimised for all seating positions.

MONOBLOC CALIPERS

Monobloc Calipers are forged from one piece of metal. This makes them more resistant to flex under load, so they waste less energy and deliver consistent braking feel.

MULTI-PLATE CLUTCH

A Multi-plate Clutch uses several friction discs to transmit power from the engine to the transmission. This decreases drag and increases the amount of torque that is transmitted while minimising the amount of force needed to operate the clutch, enabling faster and smoother shifting.

S

SHORT-THROW GEAR LEVER

A short-throw gear lever has a reduced length to enable swifter gear changes.

SUPERCHARGED PETROL

A petrol engine with a supercharger. A supercharger is a forced induction device mechanically driven by the engine. It offers higher power outputs and immediate, linear response at all engine speeds.

X

XENON HEADLIGHTS

Bi-function Xenon headlights offer improved illumination and feature LED 'J' Blade Daytime Running Lights for a striking on-road style.



IMPORTANT NOTICE

Jaguar Land Rover Limited is constantly seeking ways to improve the specification, design and production of its vehicles and alterations take place continually. While every effort is made to produce up-to-date literature, this brochure should not be regarded as an infallible guide to current specifications, nor does it constitute an offer for the sale of any particular vehicle. Distributors and Retailers are not agents of Jaguar Land Rover Limited by any express or implied undertaking or representation. Comparisons are based on manufacturer's own data and testing prior to publication.

COLOURS

Print and online colours are representative only.

ENVIRONMENTAL INNOVATION AT JAGUAR

F-PACE, XF, XE, XJ and F-TYPE's innovative use of lightweight aluminium, which incorporates up to 50% closed-loop recycled material from the manufacturing process of the body structures, provides considerable performance benefits. This includes improved fuel consumption and less CO₂ emissions during the use phase of the Life Cycle due to lighter structures. Our on-going target is to ensure scrap aluminium reclaimed from our stamping process is to be segregated and recycled through a closed loop system and incorporated back into the same grade quality aluminium sheet, therefore reducing CO₂ emissions, versus the use of virgin aluminium sheets, during the production phase of the Life Cycle.

Jaguar is committed to reducing dependency on fossil fuels, using fewer natural resources and creating less waste as part of our approach to responsible and sustainable business development, called Environmental Innovation.

The company plan includes ongoing reduction in CO₂ emissions and the use of natural resources and at the end of 2014 we have achieved a 28% reduction in operating CO₂ emissions, 25% in the Company's European fleet average tailpipe emissions, 75% in waste to landfill, logistics efficiencies (18%) and water consumption (10%), all based on per vehicle built since 2007. In addition the manufacturing assembly CO₂ emissions of each Jaguar built in the UK since 2009, is 100% offset as part of our 2020 strategy for carbon neutral manufacturing assembly and since 2013 carbon-for-development projects form a key part of the company's Global Corporate Social Responsibility (CSR) programme.

For each tonne of CO₂ emitted in the assembly process, the company invests in emissions reductions projects that reduce an equivalent tonne of CO₂ elsewhere and provide social and humanitarian benefits at the same time.

Since 2013 the programme has offset 800,000 tonnes of CO₂ and improved the lives of over 2 million people from our award winning Lifestraw carbon-for-water emissions reduction programme. Taking into account the company's global sales growth and increased investment in more efficient operating facilities, we are proud to have delivered and in some cases exceeded our Environmental Innovation targets as planned between 2012-2015.

But it doesn't stop there. Our manufacturing facilities have been certified to ISO14001 since 1998 and in 2013 the Company was recognised as the UK's Responsible Business of the Year by leading CR index, Business in the Community. In 2014 we built on this success through the Queens award for Enterprise in Sustainable Development for 2014.

Looking forward, we have developed our 2020 vision for sustainable business growth that focuses on continued improvements in operating and tailpipe CO₂ emissions, carbon neutral manufacturing and zero waste. The company will also improve the lives of 12 million people by 2020 as part of the global Corporate Social Responsibility programme.

Meridian is the registered trademark of Meridian Audio Ltd.

The Bluetooth® word mark and logos are owned by the Bluetooth SIG, Inc. and any use of such marks by Jaguar Land Rover Limited is under license.

iPod and iPhone are a trademark of Apple Inc, registered in the US and other countries.

The Navigation system must always be used in conditions that will not affect the driver's ability to drive safely or affect the safety of other road users.

VEHICLE SHOWN FRONT COVER: F-TYPE SVR IN FIRESAND WITH OPTIONAL EXTRAS (MARKET DEPENDENT)

VEHICLE SHOWN BACK COVER: F-TYPE SVR IN AMMONITE WITH OPTIONAL EXTRAS (MARKET DEPENDENT)

Jaguar Land Rover Limited
Registered Office: Abbey Road, Whitley,
Coventry, CV3 4LF, United Kingdom
Registered in England Number: 1672070
jaguar.com

