

# JAGUAR F-PACE



THE ART OF PERFORMANCE





BY APPOINTMENT TO  
HM THE QUEEN  
MANUFACTURERS OF  
MOTOR VEHICLES  
JAGUAR LAND ROVER LIMITED  
COVENTRY

BY APPOINTMENT TO  
HRH THE DUKE OF EDINBURGH  
MANUFACTURERS OF  
MOTOR VEHICLES  
JAGUAR LAND ROVER LIMITED  
COVENTRY

BY APPOINTMENT TO  
HRH THE PRINCE OF WALES  
MANUFACTURERS OF  
MOTOR VEHICLES  
JAGUAR LAND ROVER LIMITED  
COVENTRY



## THE ART OF PERFORMANCE

Every day we push performance to its limit. Our performance. Our cars' performance.  
We innovate, we engineer, we design. We master rules and then break them.  
Only to push further. Past the limits of convention. This is when performance becomes art.

Jaguar. The Art of Performance.





## CONTENTS

### INTRODUCTION

The Concept of F-PACE	06
F-PACE - The Facts	08

### DESIGN

Exterior Principles	10
Exterior Detail	12
Interior Choice	15
Interior Space	18
Practicality	20

### PERFORMANCE

Engines	22
Automatic Transmission	26
Manual Transmission	27
Advanced Aerodynamics	28
Lightweight Aluminium Architecture	31
Chassis and Suspension	32
Tested to the Extreme	34

### DRIVING TECHNOLOGY

Advanced Driving Dynamics	37
Added Driver Confidence	38
Advanced Drivetrain Technology	41
Torque Vectoring	42
Stability and Control	45
Head-Up Display	47
Activity Key	49

### INCONTROL TECHNOLOGIES

Infotainment and Connectivity	50
Touch and Connect	53
Touch Pro and Connect Pro	55
Audio	56

### SAFETY AND EFFICIENCY

Advanced Driver Assistance	58
Efficient Technologies	60

### PERSONALISATION

F-PACE - Your Choice	62
Choose your Engine	64
Choose your Model	66
Choose your Options	68
Choose your Colour	76
Choose your Wheels	78
Choose your Interior	80
Choose your Jaguar Gear Accessories	94
Technical Specifications	100
Dimensions	102

### JAGUAR WORLD

Jaguar Experience	104
The World of Jaguar	106
Glossary and Legal Information	108



Scan to find out more about the Jaguar F-PACE.

VEHICLE SHOWN: F-PACE S IN CAESIUM BLUE WITH OPTIONAL FEATURES FITTED (MARKET DEPENDENT)  
VEHICLES SHOWN ARE FROM THE JAGUAR GLOBAL RANGE. SPECIFICATIONS, OPTIONS AND AVAILABILITY  
WILL VARY BETWEEN MARKETS AND SHOULD BE VERIFIED WITH YOUR LOCAL JAGUAR RETAILER

## INTRODUCTION

# THE CONCEPT OF F-PACE

F-PACE is inspired by the acclaimed C-X17 concept vehicle. It takes the pure Jaguar DNA of legendary performance, handling and luxury. Then it adds space and practicality.

The F-PACE range features an extended engine choice, including the new 2.0 litre 4 cylinder 250PS Turbocharged Ingenium Petrol engine and 2.0 litre 4 cylinder 240PS Turbocharged Ingenium Diesel engine. With advanced technology and all-aluminium construction, they both deliver impressive fuel consumption and CO<sub>2</sub> emissions. Or choose the new 2.0 litre 4 cylinder 163PS Turbocharged Ingenium Diesel engine which achieves fuel consumption as low as 4.8 l/km on the combined cycle.

F-PACE is a performance SUV that combines maximum driving exhilaration with efficiency. All enhanced by technologies that keep you safe, connected and entertained. F-PACE has the capability for every road and the capacity for every day. It is the latest in a bloodline of beautiful, exciting cars. F-PACE is a Jaguar for you, a Jaguar for your family.

VEHICLE SHOWN: F-PACE S IN CAESIUM BLUE WITH OPTIONAL FEATURES FITTED  
(MARKET DEPENDENT)

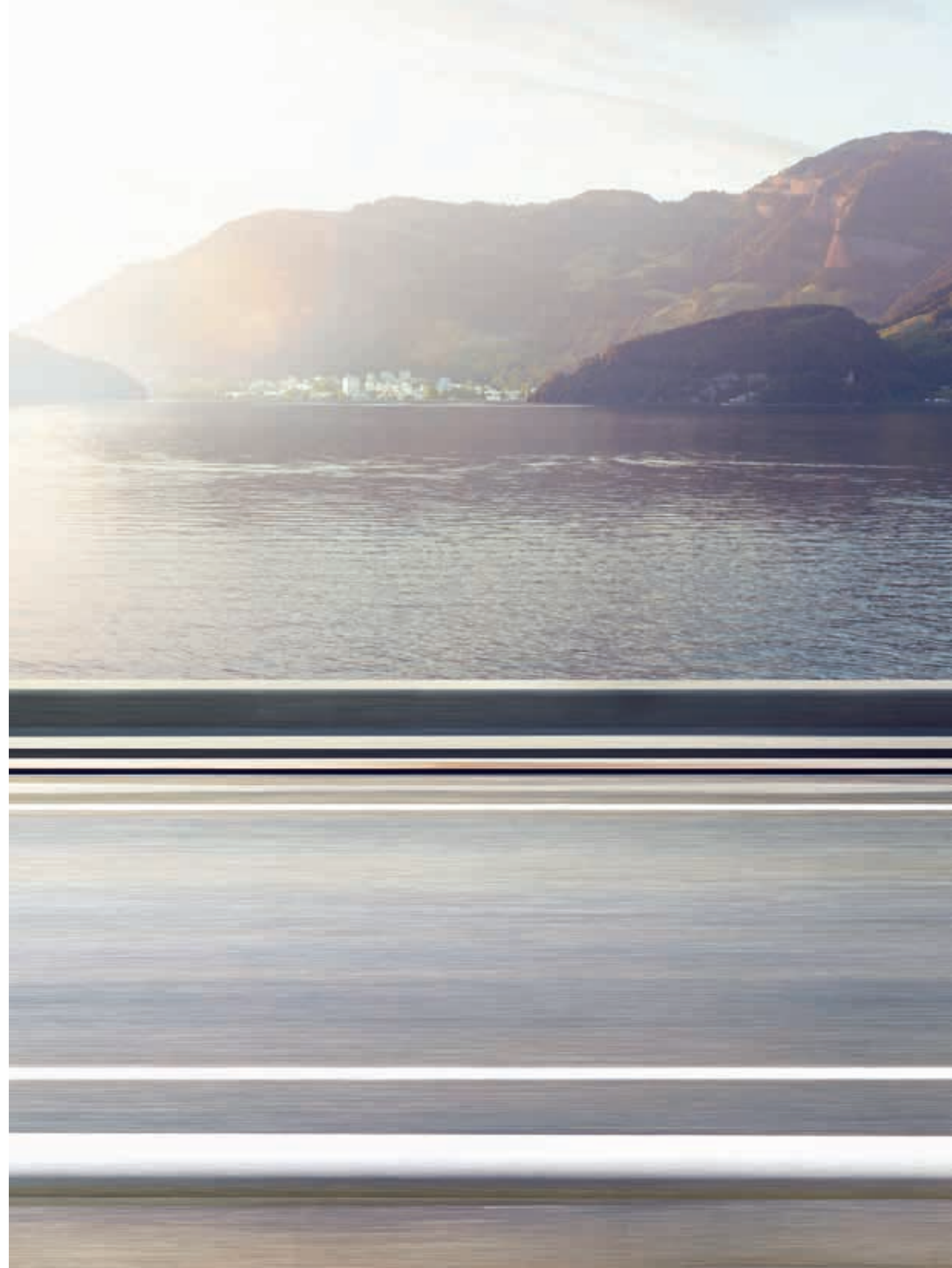



# F-PACE - THE FACTS

Performance, handling and refinement. Practicality, capability and efficiency.

## JAGUAR CARE<sup>‡</sup>

F-PACE is offered with unlimited mileage, three year warranty and three years' standard servicing programme. We call this programme Jaguar Care. It makes F-PACE's overall cost of ownership one of the lowest in its class.



## EFFICIENCY

Every F-PACE is designed and engineered for maximum efficiency. Low friction technologies, a lightweight body structure and streamlined aerodynamics all contribute to enhanced fuel economy. For example, the 2.0 litre 4 cylinder 163PS Turbocharged Diesel from the Ingenium range can achieve up to 4.8 l/100km and CO<sub>2</sub> emissions as low as 126g/km.

## PRACTICALITY

F-PACE's rear knee and leg room is among the best-in-class and it has 40:20:40 seating configuration for greater flexibility. Loadspace is class-leading at 650 litres\*, with carefully considered dimensions designed to maximise its usability. With Powered Gesture Tailgate\*\* you can access the boot when your hands are full. Simply present your foot under either rear corner and the boot opens or closes.

## CAPABILITY

F-PACE matches your practical driving needs and the demands of your lifestyle by offering the choice of either Rear Wheel Drive<sup>†</sup> or All Wheel Drive for performance across an even wider range of conditions. Capabilities can be further enhanced by All Surface Progress Control<sup>††</sup>, a low speed cruise control that helps F-PACE to cope with low traction situations.

\*With tyre repair system. 508 litres with space saver spare wheel. 463 litres with full size spare wheel.

\*\*Optional feature.

†Rear Wheel Drive availability is market dependent.

††Not available on manual transmission, standard on automatic transmission.

‡Selected European Markets only.

VEHICLE SHOWN: F-PACE PORTFOLIO IN YULONG WHITE WITH OPTIONAL FEATURES FITTED (MARKET DEPENDENT)



## PERFORMANCE

Discover exhilarating driving experiences across the entire F-PACE range. Our highly efficient performance engines offer a balance between economy and power. Engines include the new 2.0 litre 4 cylinder 163PS Turbocharged Diesel from the Ingenium range, which can achieve from 126g/km CO<sub>2</sub> and up to 4.8 l/100 km. The 3.0 litre V6 380PS Supercharged Petrol can reach a limited top speed of 250km/h with 0-100km/h acceleration in 5.5 seconds.



## REFINEMENT

Our cars have an unrivalled reputation for comfort and a smooth, quiet ride. Thanks to its stiff body structure, advanced suspension and aerodynamic design, F-PACE showcases Jaguar's supreme refinement.

## HANDLING

F-PACE's advanced chassis and suspension system is an evolution of the configuration used on our F-TYPE sports car. This robust system is lightweight to ensure F-PACE delivers true sports handling. Jaguar's Electronic Power Assisted Steering (EPAS) software is specially tuned for optimum feedback and control, while the All Wheel Drive system uses the F-TYPE-derived, unique Intelligent Driveline Dynamics software for an agile feel and to minimise understeer. F-PACE always drives, feels and handles like a Jaguar.

## DESIGN EXTERIOR PRINCIPLES

**>** F-TYPE INSPIRED STYLING | PURITY OF FORM

Visually inspired by F-TYPE, the Jaguar F-PACE is a performance SUV that has the DNA of a sports car. Its powerful, agile looks make it utterly distinctive and give it a head-turning road presence. From the bonnet bulge to the pronounced rear haunches, F-PACE reinvents the energy, strength and purity of form of F-TYPE.

VEHICLE SHOWN: F-PACE R-SPORT IN FIRENZE RED WITH OPTIONAL FEATURES FITTED (MARKET DEPENDENT)







## EXTERIOR DETAIL

### ADAPTIVE LED HEADLIGHTS\*

Even at night, F-PACE is instantly recognisable thanks to its Adaptive LED headlights\* featuring Jaguar's signature 'J' Blade Daytime Running Lights. Adding to F-PACE's commanding on-road presence, Adaptive LED headlights\* produce an intensity of light that is close to daylight, helping your eyes to distinguish objects more easily and reducing fatigue. At the rear, full LED tail lights echo F-TYPE's distinctive design.

\*Fitment dependent on derivative and market. Xenon or Halogen headlights are also available depending on model chosen.  
VEHICLE SHOWN: F-PACE S IN CAESIUM BLUE WITH OPTIONAL FEATURES FITTED (MARKET DEPENDENT)







## INTERIOR CHOICE



**SPORTS COMMAND DRIVING POSITION**

**EXTENSIVE PERSONAL CHOICE**

F-PACE's interior blends sportiness and elegance to create the latest in contemporary design. Our extensive range of premium materials, handpicked leathers and sophisticated finishes, gives F-PACE one of the most comprehensive interior choices in its class\*. This is your perfect opportunity to create a space that reflects your individual style.

Take personalisation to the next level with optional Configurable interior mood lighting\*\*. The system highlights the finest interior design details with soft pools of light in a choice of ten different colours. F-PACE can create an ambience to match your mood. F-PACE's modern interior design means essential controls are intuitive to use and always close at hand. A high centre console and the Sports Command driving position help the driver feel connected and secure. Slender roof pillars and a large windscreen mean all-round visibility is excellent.

\*Compared to segment competitors.

\*\*Fitment is market and derivative dependent.

**VEHICLE SHOWN: F-PACE PORTFOLIO WITH SIENA TAN PERFORATED WINDSOR LEATHER SEATS WITH SIENA TAN TONAL STITCH. OPTIONAL FEATURES FITTED (MARKET DEPENDENT)**









## INTERIOR SPACE

 PANORAMIC ROOF | OPTIMISED REAR SPACE

VEHICLE SHOWN PREVIOUS PAGE: F-PACE R-SPORT FEATURING EBONY/PIMENTO PERFORATED GRAINED LEATHER SPORTS SEATS WITH PIMENTO CONTRAST STITCH. OPTIONAL FEATURES FITTED (MARKET DEPENDENT)

VEHICLE SHOWN THIS PAGE: F-PACE PORTFOLIO FEATURING SIENA TAN PERFORATED WINDSOR LEATHER SEATS WITH SIENA TAN TONAL STITCH. OPTIONAL FEATURES FITTED (MARKET DEPENDENT)



Choose one of our optional panoramic glass roofs\* to flood your F-PACE's interior with light and enhance the airy, spacious feeling. The Fixed Panoramic roof\* brings the outside in by giving everyone superb views of the sky, while the Sliding Panoramic roof\* allows fresh air into the cabin whenever you want it. For greater privacy and to reduce excessive heating under intense sunlight, every panoramic roof\* is fitted with an electric blind as standard.

In the back, there's space for three adults to sit comfortably side by side. Rear leg and knee room are 945mm and 65mm respectively. Throughout the car you'll find neatly placed, versatile storage. There are useful pockets for smartphones and other small items either side of the centre console, as well as below the touchscreen.

\*Fitment of panoramic glass roof is market and model dependent.

**40:20:40**  
650 Litres\*\*†

## PRACTICALITY

**> CLASS-LEADING BOOT SPACE** | **VERSATILE SEATING**

F-PACE has a boot capacity of a class-leading 650 litres\*\*†, substantially greater than its nearest competitor. The space is made even more versatile by the rear seats' 40:20:40 configuration. They can be folded completely, or folded individually, in a variety of combinations, to accommodate both passengers and awkward items such as skis. With the rear seats folded, F-PACE's total loadspace is an impressive 1,740‡ litres.

The parcel shelf, so often a difficult object to store, can be stowed under the loadspace floor‡. The loadspace floor is reversible‡ and can be switched, in an instant, from luxury carpet to an easy-clean, rubberised surface-perfect for damp or muddy equipment. Transferring items into and out of F-PACE is made easier by the low loading height and wide boot opening.

Powered Tailgate and Powered Gesture Tailgate are available as options on F-PACE. With Powered Gesture Tailgate you don't even have to touch the car when your hands are full – simply present your foot under one of F-PACE's rear corners and the tailgate opens or closes\*\*.

\*With tyre repair system. 508 litres with space saver spare wheel. 463 litres with full size spare wheel.

\*\*Requires Jaguar Smart Key System with Keyless Entry and Push Button Start.

†Below the parcel shelf.

‡Boot configuration and total loadspace will vary depending on model and if full size spare or space saver spare wheel is fitted. Please consult your local Jaguar Retailer for further details.

VEHICLE SHOWN: F-PACE R-SPORT IN FIRENZE RED, FEATURING EBONY/PIMENTO PERFORATED GRAINED LEATHER SPORTS SEATS WITH PIMENTO CONTRAST STITCH. OPTIONAL FEATURES FITTED (MARKET DEPENDENT)



**40:20:40**  
1,214 Litres†



**40:20:40**  
1,380 Litres†



**40:20:40**  
1,740 Litres†



# PERFORMANCE ENGINES



RESPONSIVE ENGINES

EFFICIENCY AND PERFORMANCE

Ingenium technology underpins three of the diesel engines in the F-PACE range. These low friction, all-aluminium engines have stiff cylinder blocks and twin balancer shafts to ensure inherently low levels of vibration, for smooth day-to-day performance. All engines are equipped with Stop/Start technology\* and smart regenerative charging - harvesting kinetic energy from braking to charge the battery - for maximum economy, especially during urban driving. For information on fuel consumption, CO<sub>2</sub> emissions and performance figures for F-PACE's engines, please refer to pages 100 to 101.



## INGENIUM DIESEL ENGINES FROM 126g/km CO<sub>2</sub>

The **Ingenium 2.0 litre 4 cylinder 163PS Turbocharged Diesel\*\*** is refined and highly efficient. Low-flow direct injectors precisely control the amount of fuel that enters the combustion chamber for maximum efficiency. Intelligent, electronically controlled, adaptive engine cooling only engages when required - minimising fuel consumption and CO<sub>2</sub> emissions. This doesn't limit driving pleasure, the engine's strong torque gives good performance from low down in the rev range for brisk acceleration.

The **Ingenium 2.0 litre 4 cylinder 180PS Turbocharged Diesel** offers impressive performance and economy. For an engine of this size it offers high levels of torque, but not at the expense of efficiency - a balance achieved thanks to its variable geometry turbocharger. Adapting to the changing flow of exhaust gases, it maximises low speed torque for broad power and responsiveness that is uniform, progressive and avoids lag.

The **Ingenium 2.0 litre 4 cylinder 240PS Twin Turbocharged Diesel** delivers high power and torque. Its series sequential twin turbocharger uses high and low pressure spools to give continuous acceleration and maximise performance. A higher specific power output is created by building on Ingenium technology. Upgrades include a higher pressure common rail fuel system, increased from 1,800 to 2,200 bar, and an improved fuel injector flow rate.

\*Market dependent.

\*\*Available in Rear Wheel Drive (RWD) only.



#### DIESEL ENGINE

**0-100km/h in 6.2 seconds**

The **3.0 litre V6 Twin Turbocharged Diesel engine** offers exceptional power, torque and drivability. It uses innovative twin-parallel sequential turbocharging - a concept pioneered by Jaguar Land Rover - for smooth, more immediate delivery of power at all engine speeds, as well as two-stage water cooling to conserve energy.

F-PACE offers a choice of petrol engines, including one from our Ingenium range. With their lightweight, all-aluminium design, and widespread use of low-friction roller bearings, Ingenium petrol engines are built for smooth, highly efficient performance. All engines are equipped with Stop/Start technology\* and smart regenerative charging - harvesting kinetic energy from braking to charge the battery - for maximum economy, especially during urban driving.



INGENIUM PETROL ENGINE UP TO

**0-100km/h in as little as 6.8 seconds**

The **Ingenium 250PS 2.0 litre 4 cylinder Turbocharged Petrol engine** delivers outstanding usable power and torque. For excellent acceleration and effortless overtaking, maximum torque is available between 1,200-4,500 rpm. This engine's twin scroll turbocharger is fed by an integrated exhaust manifold that synchronises exhaust pulses from two separate pairs of cylinders - significantly reducing turbo lag and improving engine response.

\*Market dependent.



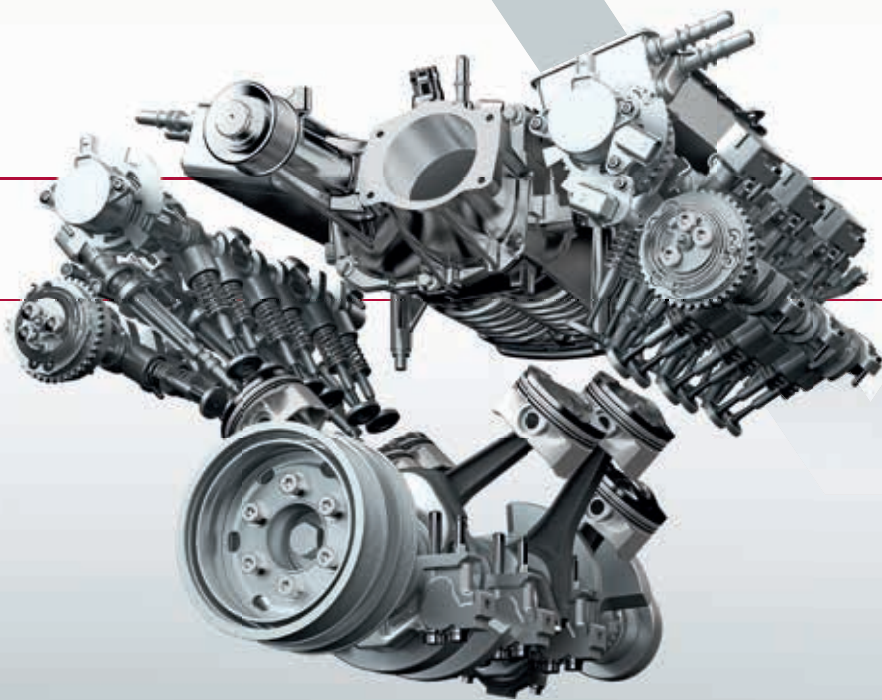

#### PETROL ENGINES

## 0-100km/h in 5.5 seconds

The **3.0 litre V6 Supercharged Petrol engine** features a Roots-type twin vortex supercharger that provides linear delivery of power and maximises responsiveness. This results in performance matching much larger engines, while optimising economy and reducing emissions. The engine also features dual independent variable cam timing to vary inlet and exhaust valve operation, working alongside lightweight pistons with ultra-low friction piston rings, for increased performance and efficiency. For added refinement there is a twin, contra-rotating balancer shaft system.

## AUTOMATIC TRANSMISSION

### 8-SPEED AUTOMATIC TRANSMISSION

F-PACE's automatic transmission is highly responsive, smooth and efficient. Developed specifically for the demands of a performance SUV, it delivers rapid shifting for effortless acceleration and overtaking. This intelligent, adaptive system subtly changes the way the throttle delivers power, as well as gearshift patterns, to suit your particular driving circumstances. The unique JaguarDrive Control system offers even quicker shifts and sportier kickdown in Dynamic Mode, and earlier up-shifts in Eco Mode to improve efficiency while the Rain Ice Snow Mode enhances the vehicle stability in low grip conditions by allowing for more gentle progress. The driver can also opt to manually control gearshifts via the steering wheel paddles at the touch of a finger.



## MANUAL TRANSMISSION

### 6-SPEED MANUAL TRANSMISSION\*

Choose the 6-speed manual transmission\* for even greater driver involvement. This lightweight, highly advanced gearbox contributes to F-PACE's outstanding efficiency. Its aluminium alloy casing, hollow shafts and pocketed gears save every gram of weight possible. We use an advanced direct lubrication system to reduce friction and drag for greater efficiency and further weight saving. Originally designed for the performance requirements of sports cars, F-PACE's outstanding 6-speed manual transmission delivers slick, short changes and superb levels of comfort.

\*Only available on 2.0 litre 4 cylinder 163PS and 2.0 litre 4 cylinder 180PS Diesel engines (Market dependent).





## ADVANCED AERODYNAMICS

 **LOW DRAG** | **INCREASED STABILITY**

F-PACE's aerodynamic performance is a key function of its body design and supports an impressive drag coefficient from Cd 0.34\*. The result is that F-PACE really is as sleek as it looks. Highly advanced aerodynamics reduce fuel consumption, CO<sub>2</sub> emissions and wind noise while adding to high speed stability and driver confidence. F-PACE's innovative, lightweight underbody design is as important as the body you can see. The smooth underbody surfaces manage airflow to optimise cooling of the engine and brakes as well as helping to minimise drag, reduce turbulence and increase efficiency. As air reaches the back of F-PACE, the car's sharply angled rear corners and integrated spoiler limit pressure differences forming in the wake of the car for improved fuel economy.

\*Engine and model dependent.

VEHICLE SHOWN: F-PACE PORTFOLIO IN YULONG WHITE WITH OPTIONAL FEATURES FITTED (MARKET DEPENDENT)



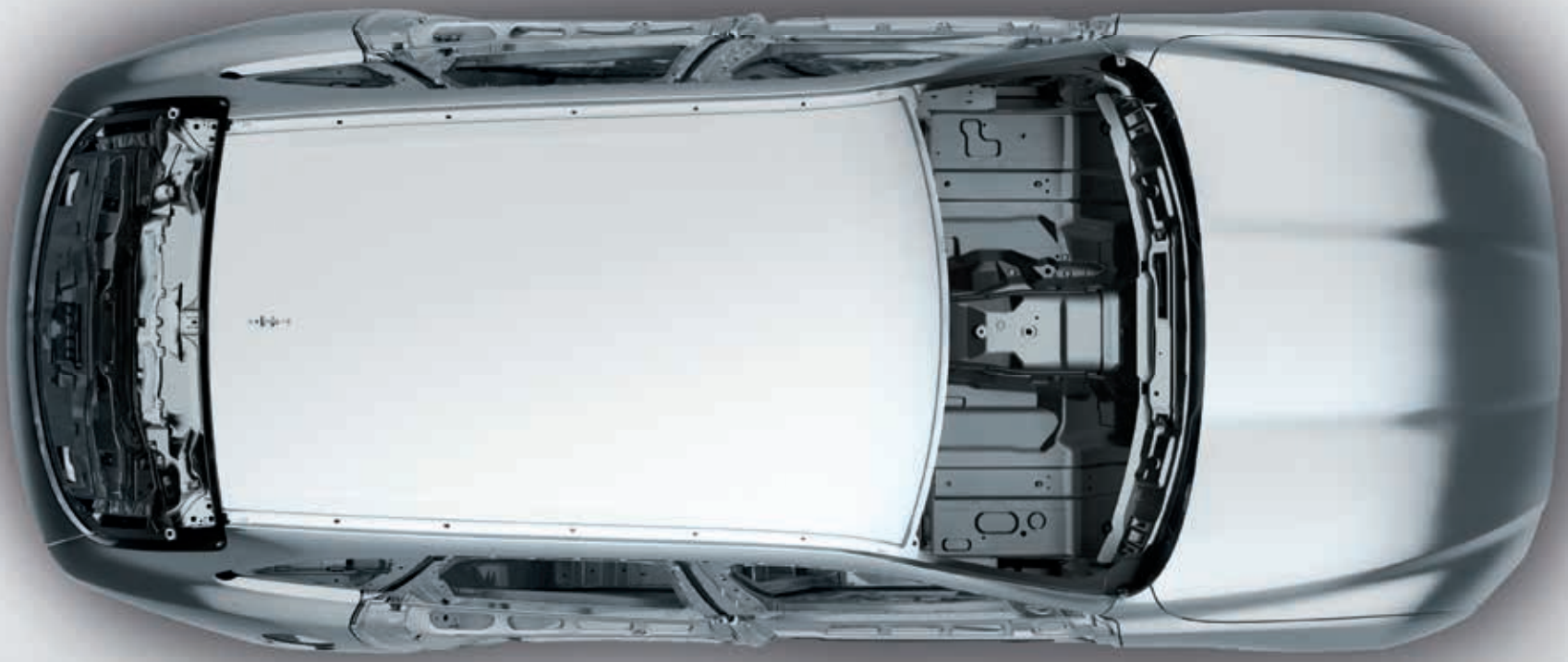

# LIGHTWEIGHT ALUMINIUM ARCHITECTURE

 **STRONG** | **RIGID** | **80% ALUMINIUM\***

Jaguar has been at the forefront of aluminium car construction for more than a decade. Our latest innovation is the Lightweight Aluminium Architecture that provides the foundations for F-PACE. We use aluminium where possible because it creates a stiff, strong and, most importantly, lighter architecture. The architecture's incredible strength offers excellent protection to all occupants, while its reduced weight enhances handling and braking. Aluminium has also been used to form the body sides, bonnet and front wings of F-PACE.

The use of aluminium enables F-PACE to be amongst the lightest cars in its class\*\* - boosting efficiency from the outset. The reduced weight of F-PACE's structure is distributed with a near perfect 50:50\*\* balance for a sporting performance and an impeccable ride.

\*Aluminium content based on volume for body structure excluding doors, bonnet and tailgate.

\*\*Model and engine dependent.

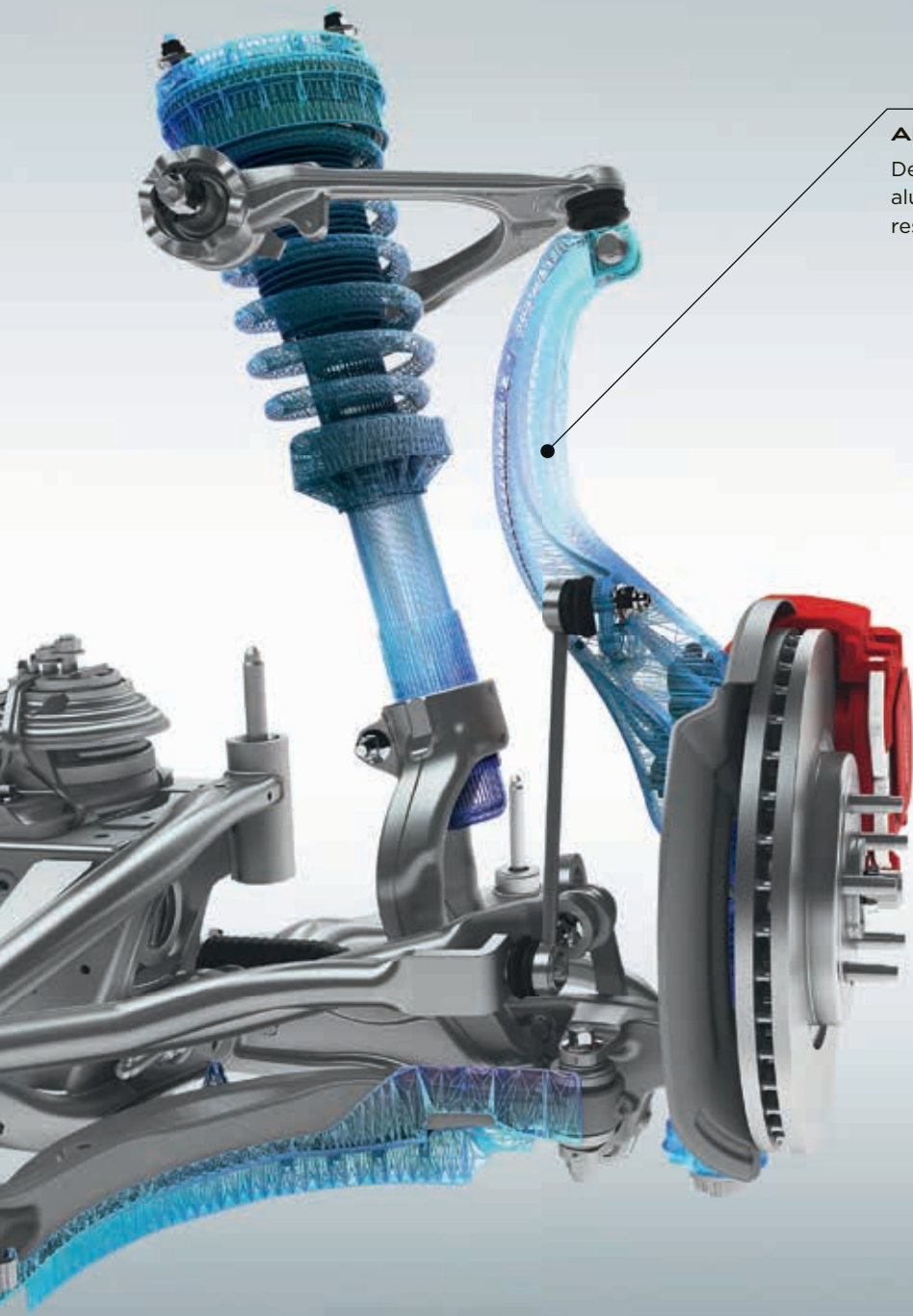

#### ALUMINIUM FRONT KNUCKLE

Designed to optimise stiffness and strength, the lightweight aluminium front knuckle helps improve F-PACE's agility, responsiveness and refinement for sports car inspired control.

## CHASSIS AND SUSPENSION



**SUPERB RIDE  
AND HANDLING**

**UNIQUE SUSPENSION  
TECHNOLOGY**

Underpinning F-PACE is an evolution of F-TYPE's chassis and suspension system - it offers a unique balance between agility and ride comfort. This ensures that F-PACE feels like a true Jaguar and is a pleasure to drive or be driven in. In combination with this suspension, F-PACE's stiff body structure and the use of lightweight acoustic damping materials create supreme refinement.



### **INTEGRAL LINK REAR SUSPENSION**

Integral Link suspension allows F-PACE to realise a perfect combination of a refined, luxurious ride and sharp, responsive handling. The system, unique for this class of car, separates and independently manages the lateral, longitudinal and vertical forces acting on the suspension for enhanced control and comfort. Many components are forged or hollow-cast in aluminium - the optimum production techniques for strong, lightweight suspension.

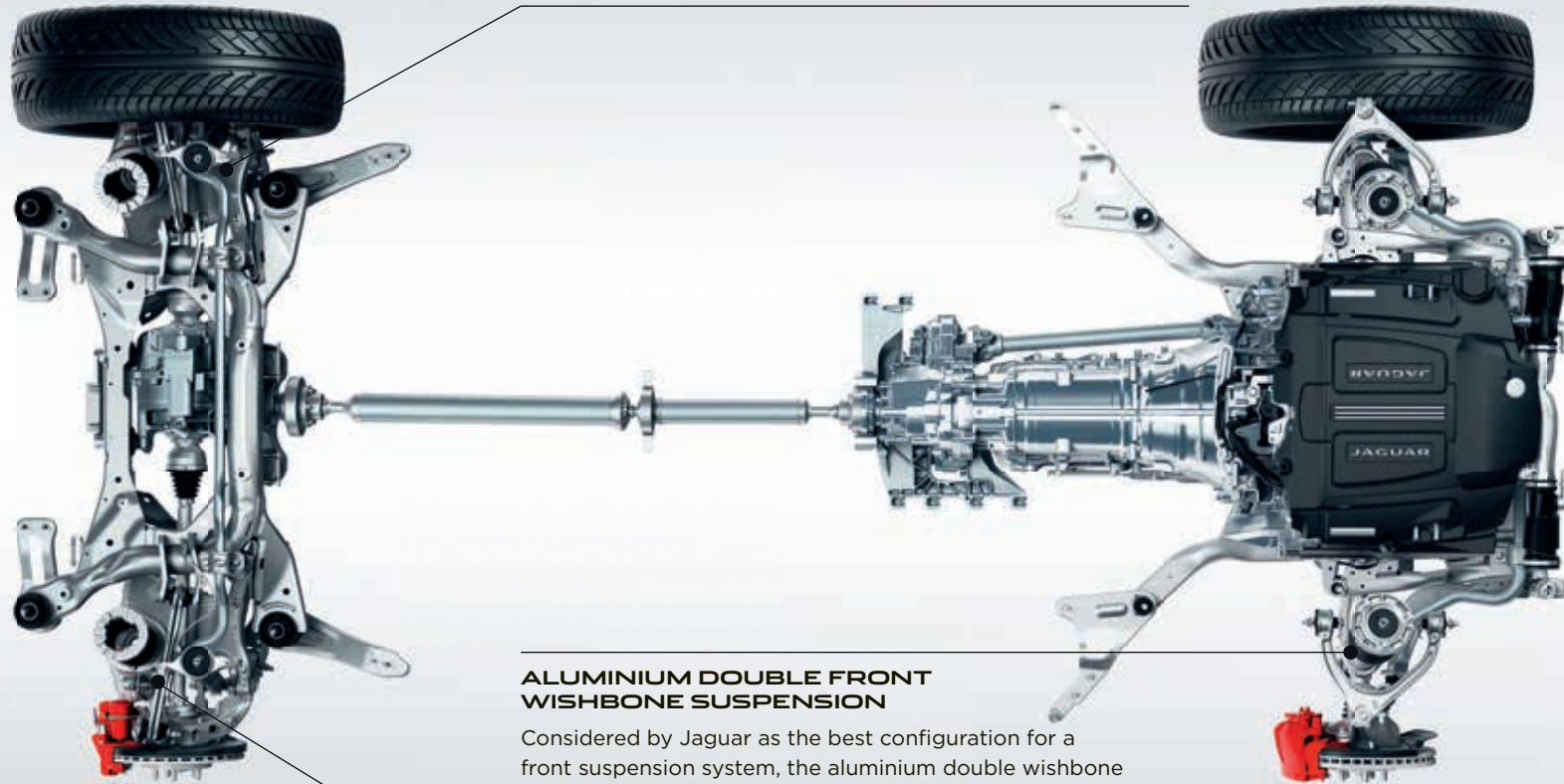

### **ALUMINIUM DOUBLE FRONT WISHBONE SUSPENSION**

Considered by Jaguar as the best configuration for a front suspension system, the aluminium double wishbone design is modelled closely on F-TYPE's for precise handling and control.

### **ADAPTIVE DYNAMICS\***

The Adaptive Dynamics system delivers both precise dynamics and a supple, luxurious ride by monitoring wheel position and body movements. The system constantly monitors conditions and adjusts the dampers to provide the optimum balance between comfort and refinement at all times.

\*Standard on F-PACE S, not available on 2.0 litre 4 cylinder 163PS Diesel engine. Optional on all other derivatives.



#### SUSPENSION

We create unique algorithms to represent the strains and stress equivalent to 250,000 km or ten years of driving on our state-of-the-art rig.



#### COLD CLIMATE

-40°C in our cold climate chamber ensures that when F-PACE is hard at work outside in freezing conditions, everything on the inside is working for your total comfort.



#### HOT TESTING

In the hot room temperatures can soar up to 55°C. We can recreate wind speeds of up to 240km/h and roads speeds as high as 250km/h. There's nowhere you can take F-PACE that it hasn't been already.

## TESTED TO THE EXTREME

**>** -40°C TO 55°C | FROM THE ARCTIC TO DUBAI

From the Arctic Circle and the mountains of China to the sands of Dubai and coast to coast in North America, F-PACE has seen almost everything the world's roads can throw at it. Then we brought F-PACE home to our UK testing facilities and things got really tough...



### **MONSOON TESTING**

The Monsoon chamber drenches F-PACE at every stage of the development process. We test for water management and dispersal along its body and over its windows. And we make sure that F-PACE stays dry inside as well as corrosion-free.



### **SEMI-ANECHOIC CHAMBER**

Our 'neutral sound' room is where we make sure F-PACE sounds like a true Jaguar with its distinctive exhaust note.



### **FINAL INSPECTION**

At the end of the production line every car is scrutinised by one of the most complex instruments in the world – the human eye. F-PACE undergoes an exhaustive visual inspection by expert quality inspectors.



# DRIVING TECHNOLOGY ADVANCED DRIVING DYNAMICS



MAXIMISING AGILITY

CONTINUOUSLY ADAPTING

Dynamic Mode revises the car's software to further enhance F-PACE's sporting character. It sharpens the throttle response, increases steering weighting and performs gearshifts more quickly\* and at higher engine speeds. It also brings visual drama to the driver as the instrument cluster takes on a red glow. Dynamic Mode enhances your connection with F-PACE's inherent Jaguar performance.

## ELECTRIC POWER ASSISTED STEERING

Electric Power Assisted Steering (EPAS) offers outstanding feedback, control and it is active on demand - saving power for where you really need it, as well as saving fuel. EPAS' sophisticated computer management varies steering assistance as appropriate - increasing assistance for low speed manoeuvring and improving feel at higher speeds. It also enables advanced safety features such as Lane Keep Assist and Park Assist.

## ADAPTIVE DYNAMICS†

Whether you're accelerating on the motorway, cornering on country roads or navigating around town, optional Adaptive Dynamics modifies F-PACE's response to match the conditions and your driving style. It analyses acceleration, cornering, throttle and brake pedal activity as well as kick-down activation. Steering movement is analysed up to 500 times a second and body movement up to 100 times a second. Electronically controlled dampers then constantly adjust to optimise the suspension settings and maintain F-PACE's dynamism and comfort.

## CONFIGURABLE DYNAMICS\*†

Bringing technology from F-TYPE, the optional Configurable Dynamics\*† system allows you to set up F-PACE's dynamics for throttle mapping, gearbox shift points and steering to suit your performance driving needs. When optional Adaptive Dynamics is fitted, you can make your setting even more personal by configuring the damper settings.

\*Automatic transmission only.

†Standard on F-PACE S, not available on 2.0 litre 4 cylinder 163PS Diesel engine.

## ADDED DRIVER CONFIDENCE



ALL SURFACE PROGRESS CONTROL\*

ADAPTIVE SURFACE RESPONSE

Unique in this class of car, Jaguar's All Surface Progress Control (ASPC) technology is a low speed cruise control that helps F-PACE to cope with low traction situations. ASPC allows the driver to concentrate on steering the vehicle. Once activated, you use the cruise control buttons to set a 'target' speed of between 3.6km/h and 30km/h. The system then works to achieve and maintain that speed while exerting optimum traction control.

ASPC is standard on all engines fitted with automatic transmissions and gives F-PACE drivers added confidence over slippery, loose or icy surfaces, undulating terrain and even while descending a difficult incline. It helps make F-PACE easy to drive in challenging conditions. ASPC also has a pull-away function allowing F-PACE to progress from rest on low grip surfaces and ascending gradients, as well as a hill descent function that controls vehicle speed on steeper inclines.

On All Wheel Drive vehicles fitted with Adaptive Dynamics\*\*, optional Adaptive Surface Response (AdSR) recognises differences between surfaces to exploit the maximum available grip. Drawing on Jaguar Land Rover's unrivalled expertise with All Wheel Drive systems, AdSR constantly monitors the car's environment and adjusts the appropriate engine and brake settings. Once selected, AdSR works at all speeds to support you in adverse weather and across challenging surfaces.

\*Automatic transmission only.

\*\*Standard on F-PACE S, not available on 2.0 litre 4 cylinder 163PS Diesel engine.



GRAVEL



WET GRASS



SNOW/ICE



WET ROAD

### DRY ROAD CONDITIONS

In normal conditions, torque is distributed to the rear wheels, delivering acclaimed Jaguar agility and handling.

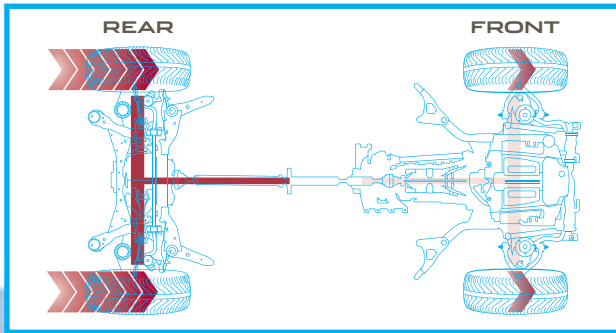

### LOW TRACTION CONDITIONS

On slippery surfaces, such as grass and snow, torque can be balanced between the front and rear wheels to maximise traction.

In extreme conditions where only the front wheels have traction, up to 100 percent of engine torque can be distributed to the front wheels for optimum grip.

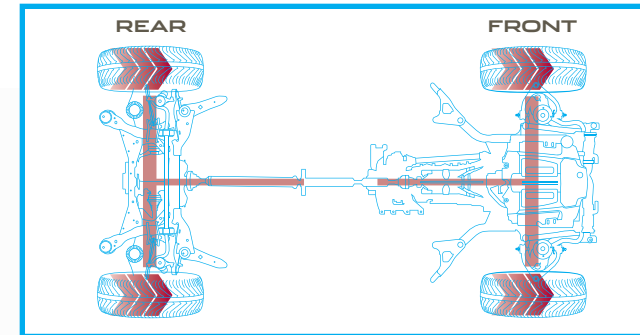



# ADVANCED DRIVETRAIN TECHNOLOGY



ALL WHEEL DRIVE

INTELLIGENT DRIVELINE DYNAMICS

F-PACE's All Wheel Drive (AWD) system combines the agility and character of Rear Wheel Drive (RWD) with the increased security and traction provided by AWD. In normal driving, F-PACE is predominantly RWD to deliver handling purity, feel and balance. But when roads become more challenging, or when you accelerate more keenly on low-grip surfaces, the system subtly channels power forwards enabling F-PACE to maintain optimum traction for comfortable progress in all conditions.

F-PACE's AWD uses a transfer case at the back of the 8-speed Automatic Transmission to manage the appropriate distribution of torque to the front and rear wheels. Engineered to ensure that F-PACE retains the dynamic behaviour of a Jaguar, the transfer case contains an electro-mechanically activated multi-plate clutch with an actuator to build hydraulic pressure. This pressure is quickly and accurately controlled to generate the required force in the clutch to transfer the optimal amount of torque to the front wheels.

Unlike other systems that react to wheel slip, Jaguar's Intelligent Driveline Dynamics (IDD) software is predictive and uses sensors measuring throttle and steering inputs to anticipate wheel slip. IDD seamlessly co-ordinates these inputs and compares them with responses from the engine, transmission and traction control systems to calculate the traction available and distribute torque accordingly even before grip is lost. From a standstill F-PACE can transition from RWD to AWD in as little as 165 milliseconds or just 100 milliseconds when the car is moving.

The result is a drive which blends the character of RWD with the capability of AWD, providing outstanding levels of performance and control whatever the road throws at you.

# TORQUE VECTORING



## MAXIMISED CORNERING CAPABILITY

F-PACE's Torque Vectoring by braking maximises capability through even the tightest corners. Torque Vectoring technology provides controlled independent braking on the individual inside front and rear wheels to add to the turning forces acting on the car. In most conditions more braking pressure is applied to the rear inside wheel as this supports the most increased cornering capability, while the front inside wheel is braked for greater effectiveness and refinement. The result is reduced understeer for sharper turning and more consistent road holding. Torque Vectoring delivers increased sports car-like agility and added driver confidence.

ADDITIONAL ROTATIONAL FORCE  
APPLIED AROUND VEHICLE'S AXIS

TORQUE VECTORING APPLIES  
BRAKE PRESSURE TO SLOW  
THE INSIDE FRONT AND INSIDE  
REAR WHEELS INDEPENDENTLY

POWER IS SUSTAINED TO  
MAINTAIN CONSTANT SPEED  
OF OUTER DRIVEN WHEELS

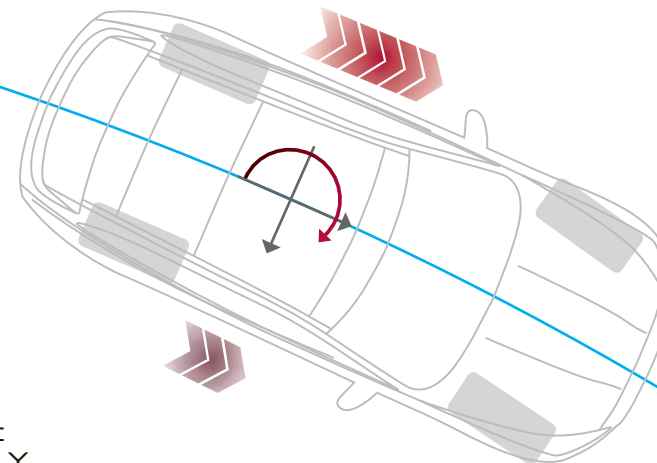

VEHICLE SHOWN: F-PACE R-SPORT IN FIRENZE RED WITH OPTIONAL FEATURES FITTED (MARKET DEPENDENT)







UNDERSTEER

OVERSTEER

BRAKING APPLIED TO APPROPRIATE WHEELS TO COUNTERACT UNDERSTEER/ OVERSTEER

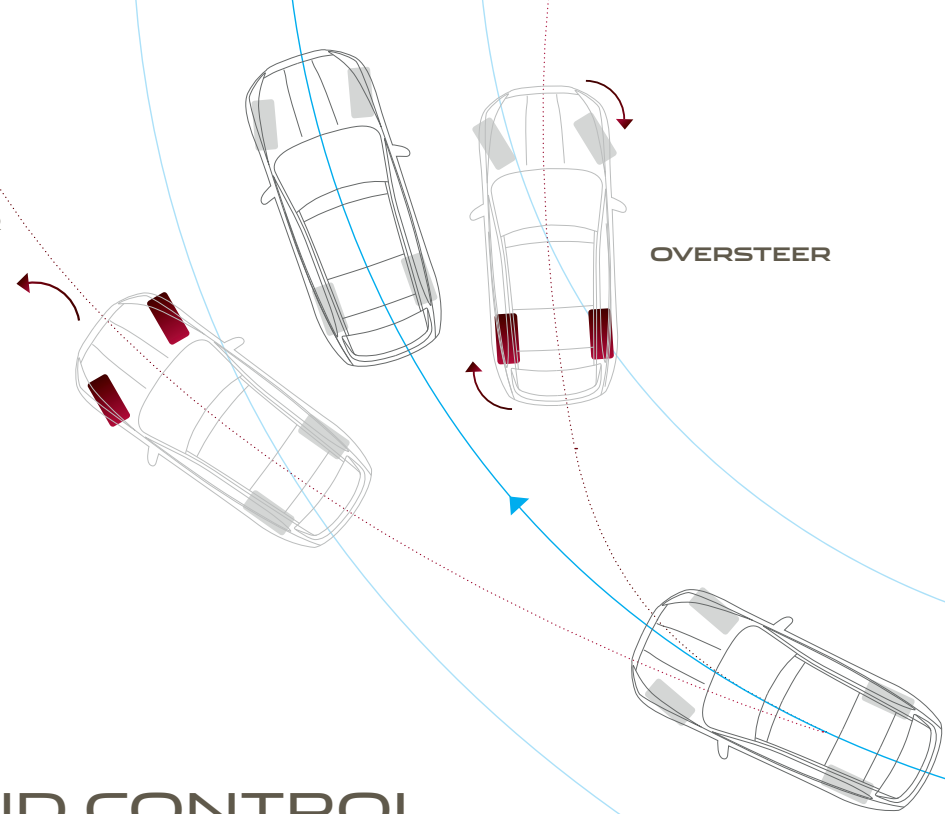

## STABILITY AND CONTROL



DYNAMIC STABILITY CONTROL

ENGINE DRAG TORQUE CONTROL

TRAILER STABILITY ASSIST

Jaguar's stability systems keep F-PACE safely balanced whether you're driving enthusiastically or simply want the assurance of a car that will remain stable in challenging conditions.

**Dynamic Stability Control (DSC)** monitors F-PACE's dynamic behaviour, intervening to maximise vehicle stability and optimising available grip. DSC reduces engine torque and applies braking to the appropriate wheels to correct the car's direction of travel by counteracting understeer or oversteer. F-PACE's DSC system has enhanced understeer control to reduce speed and regain control more effectively.

**Engine Drag torque Control (EDC)** mitigates the chance of wheel lock-up caused by strong engine braking in slippery conditions. It acts by briefly increasing torque to the wheels as appropriate.

**Trailer Stability Assist (TSA)** gives you greater stability when towing. Should TSA detect a dangerous trailer sway situation is developing, it can help you regain control by gradually reducing F-PACE's speed through lowering engine power and applying the brakes individually on each side of the vehicle to control the sway.

VEHICLE SHOWN: F-PACE R-SPORT IN FIRENZE RED WITH OPTIONAL FEATURES FITTED (MARKET DEPENDENT)



95  
90 km/h 100

Darkness  
Oliver Daldry  
Darkness  
6/12

90 km/h  
95 km/h

rpm x 1000  
5

17:06

15°C

OFF  
AUTO  
ON

SET +



# HEAD-UP DISPLAY

## > HEAD-UP DISPLAY WITH LASER TECHNOLOGY

The optional Head-Up Display (HUD)\* with laser technology projects key information onto the windscreen. Remaining clear even in direct sunlight, the crisp, bright image can display vehicle speed, navigation, cruise control notifications, and Traffic Sign Recognition data, where available. This technology helps you minimise time spent looking down at the instrument cluster and can help you maintain continuous awareness of the car's speed.

### ADAPTIVE CRUISE CONTROL WITH QUEUE ASSIST\*\*

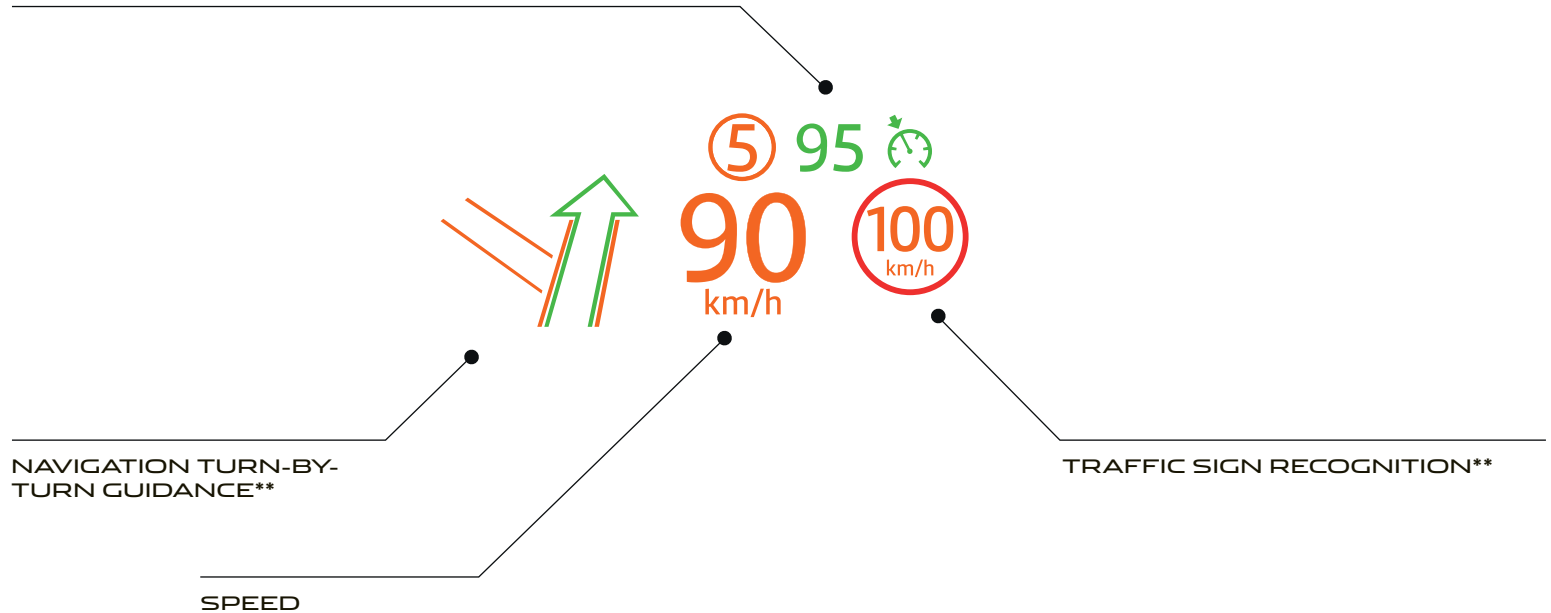

\*Requires Infrared Reflective windscreen to be fitted.  
\*\*Optional features with fitment market dependent.







## ACTIVITY KEY



ROBUST

WATERPROOF

SECURE

Activity Key\* makes living life to the full even easier. For extra convenience, you can wear the Activity Key if you prefer not to carry a key fob. The wristband is robust and fully waterproof. It allows you to enjoy a range of activities – from skydiving to swimming – and keep your car key with you. You can use the Activity Key to lock and unlock your car. When exiting the car, you can leave the conventional key fob in the car and present the Activity Key to the tailgate to lock it. The conventional key fob is then automatically deactivated for security.

\*Optional feature. Also available as Jaguar Retailer fit Accessory.

VEHICLE SHOWN: F-PACE PORTFOLIO IN YULONG WHITE WITH OPTIONAL FEATURES FITTED (MARKET DEPENDENT)

## INCONTROL TECHNOLOGIES INFOTAINMENT AND CONNECTIVITY

 TOUCH | TOUCH PRO

InControl\* is our suite of advanced technologies that links both you and your F-PACE to the wider world. Choose from two InControl infotainment systems: Touch, available as standard, or upgrade to Touch Pro. These can be further enhanced by adding their respective connectivity packages, Connect and Connect Pro\*\*.

\*As we roll out InControl, specific features described may be optional, and market or powertrain dependent. Please consult your country-specific Jaguar website or local Jaguar Retailer for availability and full terms in your country. Certain features require an appropriate SIM with a suitable data contract which will require further subscription after the initial term advised by your Retailer. Mobile connectivity cannot be guaranteed in all locations.

\*\*In selected markets where Navigation Pro is fitted you must select all the features of Connect Pro. Please consult your local Jaguar Retailer for further details.

†Only available with InControl Apps or Connect Pro (see optional connectivity packages for Touch Pro).

Third Party programmes or applications may require an end user license from the supplier.



**TOUCH**



**STANDARD ON EVERY F-PACE**

8" Touchscreen

Instrument Cluster with 5" Central TFT Display

Jaguar Sound System (80W)

AM/FM Radio

USB, Bluetooth® and AUX connections



**Protect** consists of SOS Emergency Call, Jaguar Optimised Assistance and Remote Essentials smartphone app



**OPTIONAL**

**Connect** consists of InControl Apps, Remote Premium smartphone app and Wi-Fi Hotspot



**Secure Tracker** provides Stolen Vehicle Monitoring and notifications via your smartphone and the secure call centre

**ADDITIONAL OPTIONS**

Meridian™ Sound System (380W)

Navigation

DAB Radio

InControl Apps



For information on Touch see pages 52-53.



**TOUCH PRO**



**AVAILABLE AS AN UPGRADE**

10.2" Touchscreen with multi-touch gestures and customisable homescreen

12.3" Instrument Panel Display with virtual dials and full screen 3D Map View

Navigation Pro

Meridian™ Sound System (380W)

AM/FM Radio, Bluetooth® and 2 x USB connections

10GB of usable memory

CD/DVD Drive



**Protect** consists of SOS Emergency Call, Jaguar Optimised Assistance and Remote Essentials smartphone app



**OPTIONAL**

**Connect Pro\*\*** consists of InControl Apps, Remote Premium smartphone app, Wi-Fi Hotspot and Pro Services including Real Time Traffic information



**Secure Tracker** provides Stolen Vehicle Monitoring and notifications via your smartphone and the secure call centre

**ADDITIONAL OPTIONS**

Meridian™ Surround Sound System (825W)

Digital TV, HDMI†, MHL†

DAB Radio

Dual View

InControl Apps



For information on Touch Pro see pages 54-55.



8" TOUCHSCREEN SHOWN AT ACTUAL SIZE

<b>Audio</b>	Standard: Jaguar Sound System (80W) Optional: Meridian™ Sound System (380W)
<b>Navigation Guidance</b>	Navigation*
<b>Display</b>	8" Touchscreen
<b>Multimedia</b>	AM/FM and DAB Radio*. 1 x USB, Bluetooth® and 1 x AUX connection
<b>Standard InControl Package</b>	Protect consists of SOS Emergency Call, Jaguar Optimised Assistance and Remote Essentials smartphone app
<b>Optional Connectivity Package</b>	Connect consists of InControl Apps, Remote Premium smartphone app and Wi-Fi Hotspot

\*Optional features.

\*\*Optional feature, availability and fitment is market dependent.

# TOUCH



## ADVANCED INFOTAINMENT AS STANDARD

The Touch multimedia system is F-PACE's hub for connectivity, control and entertainment. The key features are:

**8" Touchscreen** at the heart of the centre console. Clear and responsive graphical interface for quick control.

**Easy to use Touchscreen** responds directly to touch and swipe gestures.

**Navigation guidance\*** makes planning journeys and following routes easy, thanks to turn-by-turn voice guidance and junction view. 'Dead-reckoning' functionality can accurately position the vehicle even when GPS signals can no longer be received – perfect for city centres or driving through tunnels.

**Bluetooth phone connectivity** allows you to link and control your smartphone via Touch either for phone calls or music playback: simple, easy and wire-free.

**Access a world of music** thanks to AM/FM, DAB Radio\*, as well as USB and AUX connections.

**Integrated text-to-voice** technology reduces distraction by reading out incoming text messages. You can easily respond with short, prepared messages.

**Precise climate control** is available via the Touchscreen. Adjust temperature levels, direction and intensity of airflow and operate heated or cooled seats (if fitted).

# CONNECT



## OPTIONAL CONNECTIVITY PACKAGE

Connect\* is a bundle of technologies and applications that takes your F-PACE's connectivity to the next level.

**InControl Apps** features a range of bespoke Jaguar approved apps that can be connected to the car from your smartphone. It ensures the safe and convenient use of these apps that have been optimised specifically to enhance aspects of your in-car experience.

**Wi-Fi Hotspot** gives you the option to create a 3G hotspot using the car's antenna when you fit a SIM card. This strengthens your link to the outside world, for a more stable connection than an individual device could maintain. Connect up to eight devices to read emails, browse the web and download content.

**Remote Premium** is a multi-function app that allows you to monitor as well as interact with your F-PACE from your smartphone. Remote start the engine\*\* to pre-condition the climate, lock and unlock the car, locate your F-PACE on a map or by using the beep and flash function, and track your journeys – all via the app.



Explore InControl at [jaguar.com/incontrol](http://jaguar.com/incontrol)

As we roll out InControl, specific features described may be optional, and market or powertrain dependent. Please consult your country-specific Jaguar website or local Jaguar Retailer for availability and full terms in your country. Certain features require an appropriate SIM with a suitable data contract which will require further subscription after the initial term advised by your Retailer. Mobile connectivity cannot be guaranteed in all locations.



10.2" TOUCHSCREEN SHOWN AT ACTUAL SIZE

<b>Audio</b>	Standard: Meridian™ Sound System (380W) Optional: Meridian™ Surround Sound System (825W)
<b>Navigation Guidance</b>	Navigation Pro
<b>Display</b>	10.2" Touchscreen
<b>Multimedia</b>	AM/FM and DAB Radio*, Dual View*, Bluetooth®, HDMI**, MHL** and 2 x USB connections. Digital TV*, 10GB of usable memory and CD/DVD Drive
<b>Standard InControl Package</b>	Protect consists of SOS Emergency Call, Jaguar Optimised Assistance and Remote Essentials
<b>Optional Connectivity Packages</b>	Connect Pro+ consists of InControl Apps, Remote Premium, Wi-Fi Hotspot and Pro Services (including Route Planner Companion App, share your destination and ETA, Commute Mode, Arrival Mode, Real Time Traffic information and fuel and parking services)



12.3" Full Digital Instrument Panel with virtual dials

\*Optional features.

\*\*Only available with InControl Apps or Connect Pro (see optional connectivity packages for Touch Pro).

\*In selected markets where Navigation Pro is fitted you must select all the features of Connect Pro. Please consult your local Jaguar Retailer for further details.

# TOUCH PRO

## UPGRADE TO NEXT GENERATION INFOTAINMENT

Touch Pro's next-generation hardware and software advances F-PACE's connectivity and entertainment to the very highest level. Touch Pro's features replace or enhance those found in Touch. The key aspects of Touch Pro are:

**Larger, highly-responsive, 10.2"** Touchscreen at the heart of the centre console with customisable home screen and lightning fast response times. Its interactive side panel makes multi-tasking easy.

**Pinpoint touch control** allows you to manipulate and interact with information swiftly and seamlessly. The Touchscreen responds in the same manner as a smartphone or tablet computer, providing multi-touch gestures such as pinch to zoom and swipe.

**12.3" Instrument Panel Display with Virtual Dials** and full screen 3D Map View makes driving even more of a pleasure. It is housed in the instrument display directly in front of the driver. Select full screen 3D Map View or choose one of four graphical themes to suit your personal preference.

**Enhanced Navigation** with faster response times. One of the many innovative features of Touch Pro's Navigation is that it allows you to set a destination and the system alerts you if you have insufficient fuel for the journey. It then displays filling stations on the part of the route where you may be low on fuel. The system automatically displays parking options.

**Personal media storage** of 10GB of usable memory for your music and movies. 'Plug and play' using the two USB ports allowing for fast transfer speeds.

**Dual View\*** allows the front passenger and driver to enjoy different media on the same 10.2" Touchscreen. For example, the front passenger can watch a film (listening to the audio with wireless headphones) while the driver views navigation.



Explore InControl at [jaguar.com/incontrol](http://jaguar.com/incontrol)

As we roll out InControl, specific features described may be optional, and market or powertrain dependent. Please consult your country-specific Jaguar website or local Jaguar Retailer for availability and full terms in your country. Certain features require an appropriate SIM with a suitable data contract which will require further subscription after the initial term advised by your Retailer. Mobile connectivity cannot be guaranteed in all locations.

# CONNECT PRO

## OPTIONAL ENHANCED CONNECTIVITY PACKAGE†

Connect Pro's services, technologies and applications give you the very best in connectivity and convenience. It offers all the benefits of Connect (see pg. 53) plus many more features, including:

**Route Planner Companion App** offers true door-to-door navigation. Pre-plan your destination and route via your Apple or Android smartphone. The app will guide you to your car, where you will find your selected route available on the car's Touchscreen. When you've completed your road journey, the app can guide you by foot or public transport (where supported) to your destination.

**Real Time Traffic** uses millions of live traffic data feeds to give a highly accurate picture of traffic on the way to your destination, helping you choose the best route. As you progress, the system continues to monitor live traffic conditions, and can automatically reroute you to help avoid congestion.

**Share your estimated time of arrival** so your selected contact(s) will know exactly when you will arrive, as calculated by the navigation guidance system. If you're running late, the system can then send automatic updates via text or email, without any further action from you.

**Commute Mode** allows the system to learn your commutes and automatically advises you of the expected journey time based on live and historical traffic movements. The system learns the routes you take for a given destination and then advises which of those is the quickest.

**Arrival Mode** displays interactive 360° street level imagery of your destination for seamless finishes to journeys. It automatically displays again upon your arrival. You then simply tap the Touchscreen to select a nearby car park, which appears as an updated destination.



## AUDIO



JAGUAR  
SOUND SYSTEM

MERIDIAN™  
SOUND SYSTEMS

F-PACE's superb sound systems bring your music to life. The Jaguar Sound System provides acoustic range through 6 speakers. Offering an enhanced listening experience are the optional Meridian™ Sound Systems. Designed in conjunction with the British audio experts Meridian™, these systems use innovative audio technology and precise speaker placement to give perfectly optimised sound quality.

Choose from a range of audio systems, including the 380W Sound System with 11 speakers or the 825W Surround Sound System with 17 speakers. All systems ensure that, wherever you or your passengers sit in your F-PACE, everyone will enjoy a rich, enveloping audio experience.



-  Fresh air subwoofer
-  Front door waves tweeter midrange bass
-  Rear door waves tweeter midrange

Diagram representative of Meridian™ 380W Sound System.



MERIDIAN



SOUND SYSTEMS AVAILABLE IN CONJUNCTION WITH **TOUCH**

**Standard**

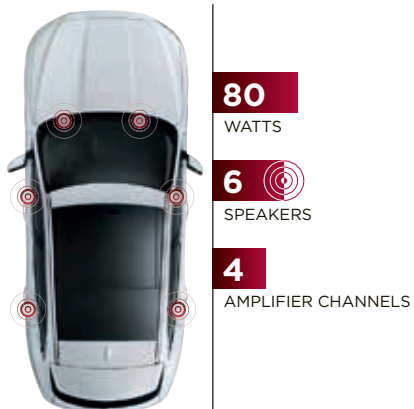

**JAGUAR SOUND SYSTEM**

Dynamic Volume Control\*  
80 watts  
6 speakers  
4 amplifier channels

**Optional**

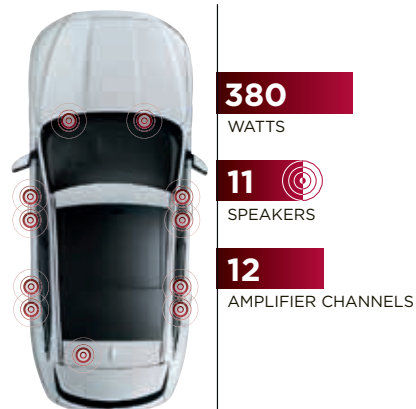

**MERIDIAN™ SOUND SYSTEM**

Dynamic Volume Control\*  
380 watts  
11 speakers including sub woofer  
12 amplifier channels

SOUND SYSTEMS AVAILABLE IN CONJUNCTION WITH **TOUCH PRO**

**Standard**

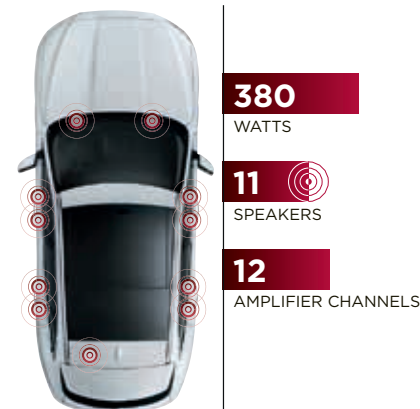

**MERIDIAN™ SOUND SYSTEM**

Dynamic Volume Control\*\*  
380 watts  
11 speakers including sub woofer  
12 amplifier channels  
Advanced DSP with fully digital amplification  
Audyssey MultEQ Audio Equalisation

**Optional**

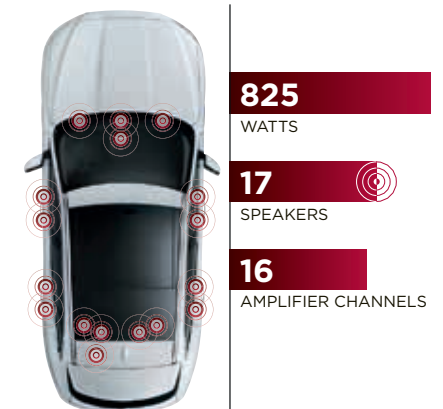

**MERIDIAN™ SURROUND SOUND SYSTEM**

Dynamic Volume Control\*\*  
825 watts  
17 speakers including sub woofer  
16 amplifier channels  
Advanced DSP with fully digital amplification  
Audyssey MultEQ Audio Equalisation  
Meridian™ Trifield Technology

\*Automatically adjusts as vehicle speed changes.

\*\*Automatically adjusts as vehicle speed changes and/or ambient noise levels change.

VEHICLE SHOWN: F-PACE PORTFOLIO IN YULONG WHITE WITH OPTIONAL FEATURES FITTED (MARKET DEPENDENT)

# SAFETY AND EFFICIENCY ADVANCED DRIVER ASSISTANCE



## 1 AUTONOMOUS EMERGENCY BRAKING\*

Should a potential collision be detected, F-PACE gives an audible forward collision warning. Visual warnings follow. If the driver takes no action, the system applies the brakes to help reduce the severity of the possible impact. This system also includes pedestrian sensing.

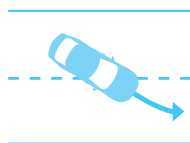

## 2 LANE DEPARTURE WARNING\*

Lane Departure Warning (LDW) notifies the driver with a visual alert and a gentle vibration of the steering wheel should the car detect an unintentional drift from its lane, helping to keep everyone on board safe.

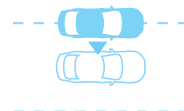

## 3 LANE KEEP ASSIST AND DRIVER CONDITION MONITOR\*\*

Building on Lane Departure Warning, Lane Keep Assist (LKA) senses unintentional lane drift and helps steer F-PACE back into its lane. Driver Condition Monitor (DCM) detects lapses in concentration due to tiredness by monitoring driver inputs and suggests taking a break via an audible alert and a visual notification in the instrument cluster.



## 4 TRAFFIC SIGN RECOGNITION WITH INTELLIGENT SPEED LIMITER\*\*

Traffic Sign Recognition technology detects speed limits, including variable limits, and no overtaking signs via the forward-facing camera, then displays them to the driver. The Intelligent Speed Limiter uses detected traffic sign information to help keep F-PACE within the appropriate speed limit. Where no traffic sign is detected, the Intelligent Speed Limiter can also use the map data from the optional navigation system.



## 5 BLIND SPOT MONITOR AND REVERSE TRAFFIC DETECTION\*\*

Blind Spot Monitor alerts you to vehicles or obstacles beside F-PACE, as well as ones approaching from a distance behind, via an icon displayed in the appropriate exterior mirror. Reverse Traffic Detection extends the Blind Spot Monitor function and alerts you via the Touchscreen of moving vehicles during reversing - for example, when leaving a parking bay with restricted vision.



## 6 PARK ASSIST\*\*

Park Assist makes parking in tight spaces easier than ever. F-PACE can accurately steer itself during both parallel and bay parking manoeuvres - the driver only has to control the brakes and accelerator. An exit-assist function can help guide F-PACE while leaving a parallel space.

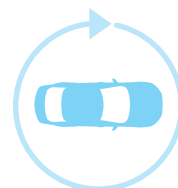

## 7 SURROUND CAMERA SYSTEM\*\*

Helping with various manoeuvres, from parking by a kerb to getting in and out of tight spaces and junctions, Surround Camera System gives you 360° exterior vision on the Touchscreen. To enhance this system further, new Forward Vehicle Guidance and Forward Traffic Detection are also available. Forming part of the Surround Camera System, Forward Vehicle Guidance provides the driver with an on-screen visualisation of the vehicle and parking distance. Forward Traffic Detection helps avoid potential collisions in situations where forward manoeuvres involve restricted views.

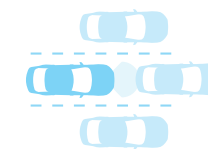

## 8 ADAPTIVE CRUISE CONTROL WITH QUEUE ASSIST\*\*

Adaptive Cruise Control<sup>1</sup> uses radar technology to automatically adjust your speed to maintain a safe distance from the vehicle ahead. If that vehicle slows, your F-PACE reduces its speed to maintain a safe distance. F-PACE resumes its pre-set speed as soon as the road in front is clear. Should the car in front stop completely, the Queue Assist function brings F-PACE to a smooth halt. Once the traffic moves off, touch the accelerator and F-PACE will follow the car in front again.

\*Standard feature.

\*\*Optional features, availability and fitment is market dependent.

<sup>1</sup>Only available on automatic transmission.

Please refer to pages 68-73 for fitment requirements.

VEHICLE SHOWN: F-PACE PORTFOLIO IN YULONG WHITE WITH OPTIONAL FEATURES FITTED (MARKET DEPENDENT)

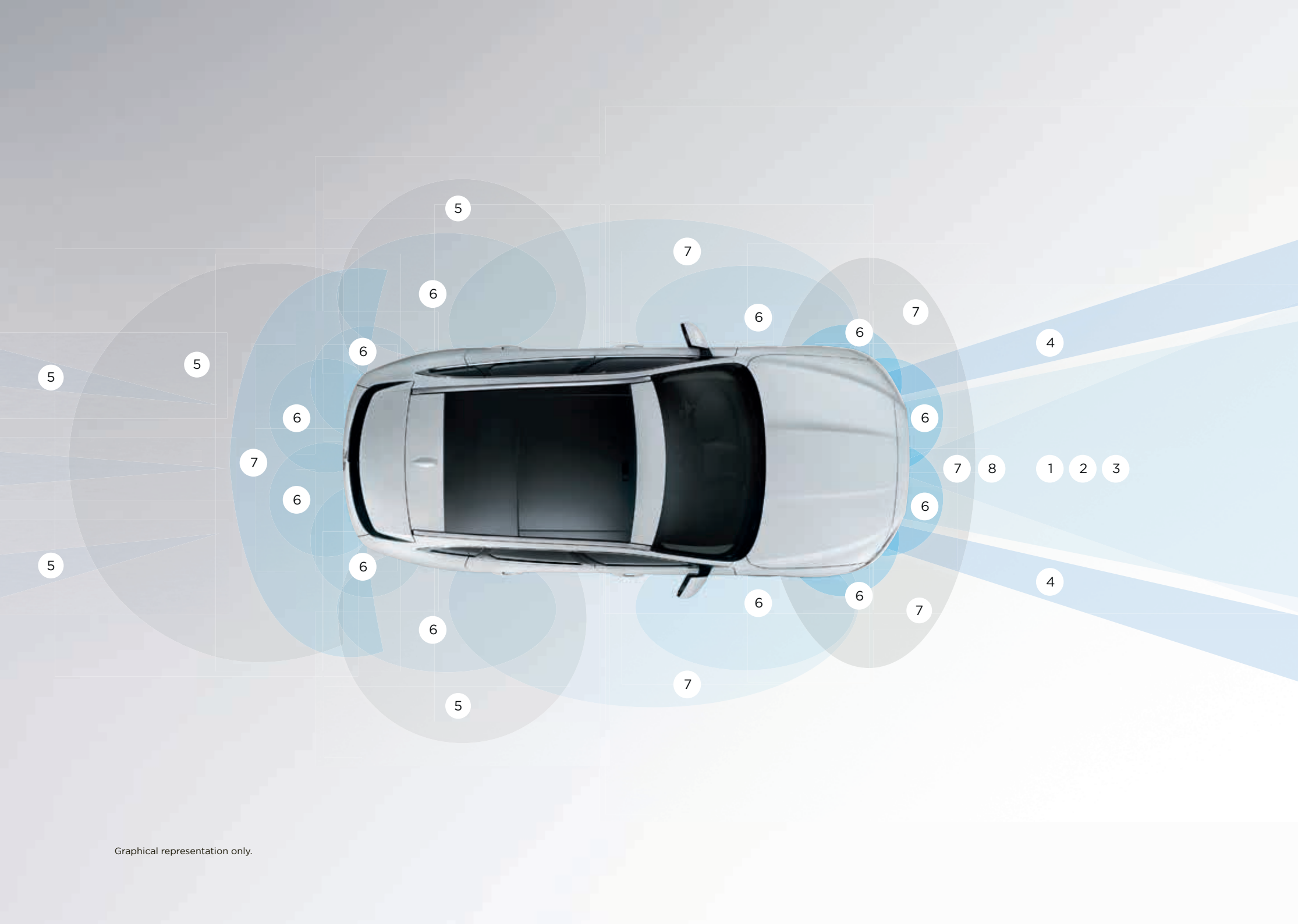

Graphical representation only.

## EFFICIENT TECHNOLOGIES

### LOW FRICTION | CLEAN TECHNOLOGIES

Everyone wants to do more with less. That is why F-PACE uses a range of technologies to reduce fuel consumption and CO<sub>2</sub> emissions, all while staying true to Jaguar's dynamic nature.



#### SUSTAINABLE CONSTRUCTION

The aluminium alloy used for much of F-PACE's construction is from a high level of recycled aluminium. Using significantly less energy than primary aluminium to produce, it minimises F-PACE's environmental impact.

#### STOP/START

All F-PACE's engines are available with Stop/Start\*. It shuts down the engine when you come to a complete halt and restarts the engine immediately when required. Helping to save fuel, especially during urban driving.

\*Market dependent.  
\*\*Engine and transmission dependent.



#### LIGHTWEIGHT MATERIALS

At every stage of the development process, engineers maximised weight saving across all the car's elements. This produces an optimum balance between best performance and weight saving for greater efficiency.



#### ADVANCED AERODYNAMICS

F-PACE's aerodynamics are developed and optimised with the aid of computational fluid dynamics analysis. By increasing stability and minimising drag, F-PACE's fuel consumption can reach up to 4.8 l/100km\*\* with CO<sub>2</sub> emissions as low as 126g/km\*\*.

AdBlue®

#### ADBLUE®\*

F-PACE's diesel models are fitted with AdBlue® to help clean exhaust gases. AdBlue® is a non-toxic, non-flammable, biodegradable additive that cleanses the gases in the car's exhaust system to remove harmful nitrogen oxide emissions.



#### LOW FRICTION TECHNOLOGIES

The Ingenium engine range uses smart coating technologies on pistons, needle roller bearings and other mechanical parts. This helps to reduce friction, especially at low engine temperatures, so the car performs at its efficient best.

# PERSONALISATION F-PACE - YOUR CHOICE

 Configure your vehicle at [jaguar.com](http://jaguar.com)



## 1 CHOOSE YOUR ENGINE

**Page 64**

Select one of F-PACE's powerful, efficient petrol or diesel engines to suit your driving style.

## 2 CHOOSE YOUR MODEL & OPTIONS

**Page 66**

Compare the wealth of standard features and options on F-PACE models.

## 3 CHOOSE YOUR COLOUR

**Page 76**

Express your individuality with one of F-PACE's stunning exterior colours.



CHOOSE YOUR  
**WHEELS**

**Page 78**

Add the personal finishing touch to your new F-PACE, and complement its stunning style, with a set of beautifully designed alloy wheels.



CHOOSE YOUR  
**INTERIOR**

**Page 80**

There's a wide selection of premium materials, leathers, veneers and finishes for every personal taste.



CHOOSE YOUR  
**JAGUAR GEAR  
ACCESSORIES**

**Page 94**

Really make it yours by adding style, practicality and versatility with official F-PACE Gear Accessories from your local Jaguar Retailer.

# 1 CHOOSE YOUR ENGINE

 Configure your vehicle at [jaguar.com](http://jaguar.com)

## > DIESEL ENGINES

### 2.0 LITRE 4 CYLINDER RWD TURBOCHARGED

MAXIMUM POWER 163PS
MAXIMUM TORQUE 380 Nm
ACCELERATION 0-100 km/h 10.2 seconds
TOP SPEED 195 km/h
COMBINED FUEL CONSUMPTION Manual 4.8*-4.9 l/100km
COMBINED CO <sub>2</sub> Manual 126**-129 g/km
PURE, PRESTIGE, PORTFOLIO, R-SPORT

### 2.0 LITRE 4 CYLINDER RWD TURBOCHARGED

MAXIMUM POWER 180PS
MAXIMUM TORQUE 430 Nm
ACCELERATION 0-100 km/h 8.5 seconds
TOP SPEED 208 km/h
COMBINED FUEL CONSUMPTION Auto 5.1 l/100km
COMBINED CO <sub>2</sub> Auto 134 g/km
PURE, PRESTIGE, PORTFOLIO, R-SPORT

### 2.0 LITRE 4 CYLINDER AWD TURBOCHARGED

MAXIMUM POWER 180PS
MAXIMUM TORQUE 430 Nm
ACCELERATION 0-100 km/h 8.7 seconds
TOP SPEED 208 km/h
COMBINED FUEL CONSUMPTION Auto 5.3 l/100km Manual 5.2 l/100km
COMBINED CO <sub>2</sub> Auto 139 g/km Manual 134 g/km
PURE, PRESTIGE, PORTFOLIO, R-SPORT

### 2.0 LITRE 4 CYLINDER AWD TWIN TURBOCHARGED

MAXIMUM POWER 240PS
MAXIMUM TORQUE 500 Nm
ACCELERATION 0-100 km/h 7.2 seconds
TOP SPEED 217 km/h
COMBINED FUEL CONSUMPTION Auto 5.8 l/100km
COMBINED CO <sub>2</sub> Auto 153 g/km
PURE, PRESTIGE, PORTFOLIO, R-SPORT

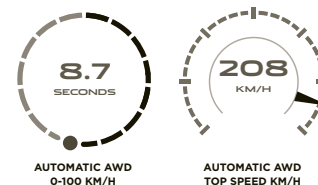
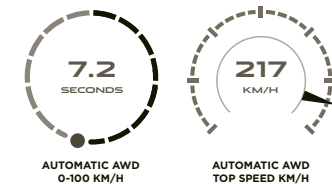
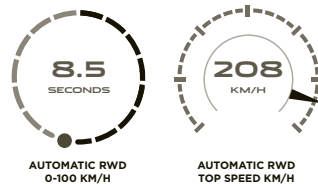

\*4.8 l/100km refers to cars fitted with 235/65 R18 tyres on 'Style 1021' or 'Style 1022' wheels.

\*\*126g/km refers to cars fitted with 235/65 R18 tyres on 'Style 1021' or 'Style 1022' wheels.

\*Limited top speed.

Please refer to Technical Specification pages for full fuel consumption figures. The figures provided are as a result of official manufacturer's tests in accordance with EU legislation. A vehicle's actual fuel consumption may differ from that achieved in such tests and these figures are for comparative purposes only.



## > PETROL ENGINES

### 3.0 LITRE V6 AWD

TWIN TURBOCHARGED

MAXIMUM POWER 300PS

MAXIMUM TORQUE 700 Nm

ACCELERATION 0-100 km/h 6.2 seconds

TOP SPEED 241 km/h

COMBINED FUEL CONSUMPTION  
Auto 6.0 l/100km

COMBINED CO<sub>2</sub> Auto 159 g/km

PURE, PRESTIGE, PORTFOLIO, R-SPORT, S



AUTOMATIC AWD  
0-100 KM/H



AUTOMATIC AWD  
TOP SPEED KM/H

### 2.0 LITRE 4 CYLINDER AWD

TURBOCHARGED

MAXIMUM POWER 250PS

MAXIMUM TORQUE 365 Nm

ACCELERATION 0-100 km/h 6.8 seconds

TOP SPEED 217 km/h

COMBINED FUEL CONSUMPTION  
Auto 7.4 l/100km

COMBINED CO<sub>2</sub> Auto 170 g/km

PURE, PRESTIGE, PORTFOLIO, R-SPORT



AUTOMATIC AWD  
0-100 KM/H

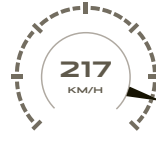

AUTOMATIC AWD  
TOP SPEED KM/H

### 3.0 LITRE V6 AWD

SUPERCHARGED

MAXIMUM POWER 340PS

MAXIMUM TORQUE 450 Nm

ACCELERATION 0-100 km/h 5.8 seconds

TOP SPEED 250 km/h<sup>†</sup>

COMBINED FUEL CONSUMPTION  
Auto 8.9 l/100km

COMBINED CO<sub>2</sub> Auto 209 g/km

PURE, PRESTIGE, PORTFOLIO, R-SPORT



AUTOMATIC AWD  
0-100 KM/H



AUTOMATIC AWD  
TOP SPEED KM/H

### 3.0 LITRE V6 AWD

SUPERCHARGED

MAXIMUM POWER 380PS

MAXIMUM TORQUE 450 Nm

ACCELERATION 0-100 km/h 5.5 seconds

TOP SPEED 250 km/h<sup>†</sup>

COMBINED FUEL CONSUMPTION  
Auto 8.9 l/100km

COMBINED CO<sub>2</sub> Auto 209 g/km

S



AUTOMATIC AWD  
0-100 KM/H



AUTOMATIC AWD  
TOP SPEED KM/H

# 2 CHOOSE YOUR MODEL

 Configure your vehicle at [jaguar.com](http://jaguar.com)

## > LUXURY



### PURE

#### KEY FEATURES

- 18" alloy wheels
- Halogen headlights with Daytime Running Lights
- Premium Fabric seats
- 8-way Manual front seats
- Gloss Black trim finisher
- Soft Grain Steering Wheel



### PRESTIGE

#### KEY FEATURES (IN ADDITION TO PURE)

- Bi-function Xenon headlights with LED 'J' Blade Daytime Running Lights
- Headlight powerwash
- Grained Leather seats
- Chrome side window surround
- Front fog lights
- Carpet mats
- Interior mood lighting
- Sport Steering Wheel



### PORTFOLIO

#### KEY FEATURES (IN ADDITION TO PRESTIGE)

- 18" alloy wheels (style change)
- Perforated Windsor Leather Luxury seats
- 10-way Electric front seats
- Configurable interior mood lighting
- Gloss Figured Ebony veneer

Standard features may vary depending on market, engine variant and transmission. Please refer to Specification and Price guide or website for your local market.

## > SPORT



### R-SPORT

#### KEY FEATURES (IN ADDITION TO PURE)

- 19" alloy wheels
- R-Sport Body kit including R-Sport front and rear bumpers, Body-coloured door claddings with Satin Black finishers
- Satin Chrome radiator grille surround and side power vents
- Gloss Black side window surrounds
- Metal treadplates with R-Sport branding
- Bi-function Xenon headlights with LED 'J' Blade Daytime Running Lights
- Headlight powerwash
- Luxtec and Technical Mesh Sport Seats
- Satin Chrome gearshift paddles
- Interior mood lighting
- Front fog lights



### S

#### KEY FEATURES (IN ADDITION TO R-SPORT)

- 20" alloy wheels
- S Body kit including S front and rear bumpers, Body-coloured S door claddings with Satin Chrome finishers
- Metal treadplates with S branding
- Adaptive LED headlights with LED 'J' Blade Daylight Running Lights
- Grained Leather and Suedecloth Sport seats
- 10-way Electric front seats
- Meshed Aluminium trim finisher
- Bright Sport pedals
- Adaptive Dynamics
- Red brake calipers
- Suedecloth headlining - Ebony

# 2 CHOOSE YOUR OPTIONS

 Configure your vehicle at [jaguar.com](http://jaguar.com)

## KEY STANDARD AND OPTIONAL FEATURES

	PURE	PRESTIGE	PORTFOLIO	R-SPORT	S	DESCRIPTION
Stop/Start*	●	●	●	●	●	Refer to page 60
Hill Launch Assist	●	●	●	●	●	Prevents your F-PACE from rolling backwards when pulling away on an incline, helping you to make the perfect hill start every time
JaguarDrive Control with Eco, Dynamic, Normal, Rain Ice Snow Mode	●	●	●	●	●	Refer to page 26
Electric Power Assisted Steering (EPAS)	●	●	●	●	●	Refer to page 37
Electric Parking Brake with drive away release	●	●	●	●	●	Automatically releases the parking brake without the need for driver input as you press the accelerator to drive away
Emergency Brake Assist	●	●	●	●	●	Increases braking pressure in an emergency situation
Autonomous Emergency Braking	●	●	●	●	●	Refer to page 58
Hazard lights under heavy braking	●	●	●	●	●	
Airbags	●	●	●	●	●	Driver and front passenger with seat occupant detector for passenger, front side and full length side window curtain
Torque Vectoring	●	●	●	●	●	Refer to page 42
Dynamic Stability Control and Traction Control	●	●	●	●	●	Refer to page 45
Cruise Control and Speed Limiter	●	●	●	●	●	
Lane Departure Warning	●	●	●	●	●	Refer to page 58
Trailer Stability Assist	●	●	●	●	●	Intervenes when the system detects sway or potentially dangerous movement to bring the trailer back under control. Refer to page 45
Electric front and rear windows with one-touch open/close and anti-trap	●	●	●	●	●	
Rain sensing windscreen wipers	●	●	●	●	●	
Two-zone climate control	●	●	●	●	●	
USB, Auxiliary socket and iPod® connectivity	●	●	●	●	●	Refer to page 51
Bluetooth® connectivity	●	●	●	●	●	Refer to page 51
Bluetooth® streaming	●	●	●	●	●	Refer to page 53
Push Button Start	●	●	●	●	●	

\*Market dependent.

● Standard ○ Option — Not available

Please consult your local Jaguar Retailer for details.

Availability and fitment of features is market dependent.

For a complete list of optional features and packs refer to the F-PACE Specification and Price Guide or configure your vehicle at [jaguar.com](http://jaguar.com)

		PURE	PRESTIGE	PORTFOLIO	R-SPORT	S		
<b>TRANSMISSION AND DYNAMIC FEATURES</b>		<b>CODE</b>					<b>DESCRIPTION</b>	
6-speed manual transmission (only available on 2.0 litre 4 cylinder Turbocharged Diesel engines)	A40G	●	●	●	●	—	Refer to page 27	
8-speed automatic transmission with Jaguar Sequential Shift (includes gearshift paddles and All Surface Progress Control)	A40H	○	○	○	○	●	Refer to page 26	
Configurable Dynamics (requires automatic transmission)	G75A	○	○	○	○	●		
Adaptive Dynamics (includes Configurable Dynamics when selected with automatic transmissions. Not available on 2.0 litre 4 cylinder 163PS Diesel engine)	C35A	○	○	○	○	●		
Adaptive Cruise Control with Queue Assist (requires automatic transmission)	H41F	○	○	○	○	○	Refer to page 58	
Adaptive Surface Response (requires AWD, automatic transmission and Adaptive Dynamics)	B73G	○	○	○	○	○	Refer to page 41	
350mm front brakes (standard on V6 engines)	G36B	○	○	○	○	●		

## EXTERIOR FEATURES AND FINISHERS

<b>EXTERIOR FEATURES AND TRIM</b>							
Fixed Panoramic roof	F45A	○	○	○	○	○	
Sliding Panoramic roof	F45C	○	○	○	○	○	
Powered tailgate	B69B	○	○	○	○	○	
Gesture tailgate (requires Jaguar Smart Key System with Keyless Entry and Push Button Start)	B69C	○	○	○	○	○	
Chrome side window surround (not available with Black Exterior Pack)	D53C	—	●	●	○	○	
Gloss Black roof rails	B16D	○	○	○	○	○	
Satin Chrome roof rails	B16F	○	○	○	○	○	
R-Sport Body kit		—	—	—	●	—	Includes R-Sport front bumper, Body-coloured R-Sport door claddings with Satin Black finishers, Satin Chrome side power vents with R-Sport badge, R-Sport rear bumper
S Body kit		—	—	—	—	●	Includes S front bumper, Body-coloured S door claddings with Satin Chrome finishers, S rear bumper with Gloss Black finish and Satin Chrome diffuser
Delete Powertrain badging (not available on 2.0 litre 4 cylinder 163PS Diesel engine)	B05H	○	○	○	○	—	

# 2 CHOOSE YOUR OPTIONS

 Configure your vehicle at [jaguar.com](http://jaguar.com)

## EXTERIOR FEATURES AND FINISHERS CONTINUED

		PURE	PRESTIGE	PORTFOLIO	R-SPORT	S	
<b>GLASS AND EXTERIOR MIRRORS</b>							<b>DESCRIPTION</b>
Infrared Reflective windscreen (front screen only)	D97B	<input type="radio"/>	<input type="radio"/>	<input type="radio"/>	<input type="radio"/>	<input type="radio"/>	Filters sunlight to reduce glare and prevent harmful UV rays from entering the cabin
Heated front windscreen with heated washer jets	D96A	<input type="radio"/>	<input type="radio"/>	<input type="radio"/>	<input type="radio"/>	<input type="radio"/>	
Privacy glass	H75A	<input type="radio"/>	<input type="radio"/>	<input type="radio"/>	<input type="radio"/>	<input type="radio"/>	
Heated door mirrors	B28J	<input checked="" type="radio"/>	<input checked="" type="radio"/>	<input checked="" type="radio"/>	<input checked="" type="radio"/>	<input checked="" type="radio"/>	
Heated door mirrors with Power Fold and Approach Lights	B28U	<input type="radio"/>	<input type="radio"/>	<input type="radio"/>	<input type="radio"/>	<input type="radio"/>	
Auto-Dimming Heated door mirrors with Power Fold and Approach Lights (requires Auto-Dimming interior rear view mirror)	B28P	<input type="radio"/>	<input type="radio"/>	<input type="radio"/>	<input type="radio"/>	<input type="radio"/>	
<b>HEADLIGHTS AND LIGHTING</b>							
Halogen headlights with Daytime Running Lights	D90V	<input checked="" type="radio"/>	<input type="radio"/>	<input type="radio"/>	<input type="radio"/>	<input type="radio"/>	
Bi-function Xenon headlights with LED 'J' blade Daytime Running Lights	D90L	<input type="radio"/>	<input checked="" type="radio"/>	<input checked="" type="radio"/>	<input checked="" type="radio"/>	<input type="radio"/>	Includes Headlight Powerwash
Adaptive LED headlights with 'J' blade Daytime Running Lights	D90T	<input type="radio"/>	<input type="radio"/>	<input type="radio"/>	<input type="radio"/>	<input checked="" type="radio"/>	Includes Auto High Beam Assist and Headlight Powerwash. Refer to page 12
Front fog lights	D01S	<input type="radio"/>	<input checked="" type="radio"/>	<input checked="" type="radio"/>	<input checked="" type="radio"/>	<input checked="" type="radio"/>	
<b>TOWING</b>							
Detachable tow bar	C05C	<input type="radio"/>	<input type="radio"/>	<input type="radio"/>	<input type="radio"/>	<input type="radio"/>	
Electrically deployable tow bar	C05B	<input type="radio"/>	<input type="radio"/>	<input type="radio"/>	<input type="radio"/>	<input type="radio"/>	
<b>EXTERIOR COLOURS</b>							(Please see pages 76-77 for full colour palette)
Solid paint		<input checked="" type="radio"/>	<input checked="" type="radio"/>	<input checked="" type="radio"/>	<input checked="" type="radio"/>	<input checked="" type="radio"/>	Refer to page 76
Metallic paint		<input type="radio"/>	<input type="radio"/>	<input type="radio"/>	<input type="radio"/>	<input type="radio"/>	Refer to pages 76-77
Premium paint		<input type="radio"/>	<input type="radio"/>	<input type="radio"/>	<input type="radio"/>	<input type="radio"/>	Refer to page 77
<b>WHEELS</b>							(Please see pages 78-79 to see the full range)
Tyre Repair System	C40S/C40T	<input checked="" type="radio"/>	<input checked="" type="radio"/>	<input checked="" type="radio"/>	<input checked="" type="radio"/>	<input checked="" type="radio"/>	
Space saver spare wheel	C40Q	<input type="radio"/>	<input type="radio"/>	<input type="radio"/>	<input type="radio"/>	<input type="radio"/>	When selected this feature decreases boot volume to 508 litres
Full size spare wheel (not available with loadspace storage rails)	C40R	<input type="radio"/>	<input type="radio"/>	<input type="radio"/>	<input type="radio"/>	<input type="radio"/>	When selected this feature decreases boot volume to 463 litres due to raised boot floor
Tyre Pressure Monitoring System (TPMS)	C42R	<input checked="" type="radio"/>	<input checked="" type="radio"/>	<input checked="" type="radio"/>	<input checked="" type="radio"/>	<input checked="" type="radio"/>	

● Standard ○ Option — Not available

Please consult your local Jaguar Retailer for details.

For a complete list of optional features and packs refer to the F-PACE Specification and Price Guide or configure your vehicle at [jaguar.com](http://jaguar.com)

## SEATING AND VENEERS

		PURE	PRESTIGE	PORTFOLIO	R-SPORT	S	
<b>SEATING</b>		<b>CODE</b>					<b>DESCRIPTION</b>
Heated front seats	F53A	○	○	○	○	○	
Heated front and rear seats	F53B	—	○	○	○	○	
Climate front seats with Heated rear seats (requires Leather seats and 4-Way Electric lumbar adjust)	F53C	—	○	○	○	○	
8-Way Manual front seats	Z02J	●	●	—	●	—	
10-Way Electric front seats	Z02P	○	○	●	○	●	Includes electric adjustment of fore/aft, cushion height, cushion tilt, squab recline and manual headrest height
10-Way Electric front seats with Memory (requires Auto-Dimming door mirrors)	Z02Q	○	○	○	○	○	Includes electric adjustment of fore/aft, cushion height, electric cushion tilt, squab recline and manual headrest height. Memory adjust driver seat, mirror position & steering wheel (if power adjustable column fitted)
4-Way Electric lumbar adjust (only available with 8-Way or 10-Way seats)	F52A	—	○	○	○	○	
18-Way Electric Sport front seats includes 4-Way Electric lumbar adjust	Z02R	—	—	—	○	○	Includes electric adjustment of fore/aft, cushion height, cushion tilt, cushion extension, squab recline, bolster. Manual headrest height adjustment
18-Way Electric Sport front seats includes 4-Way Electric lumbar adjust and Memory	Z02S	—	—	—	○	○	Includes electric adjustment of fore/aft, cushion height, cushion tilt, cushion extension, squab recline, bolster. Manual headrest height adjustment. Memory adjust driver seat, mirror position & steering wheel (if power adjustable column fitted)
20-Way Electric Luxury front seats includes 4-Way Electric lumbar adjust with electric headrest height and Driver and Passenger Memory	Z02M	—	—	○	—	—	Includes electric adjustment of fore/aft, cushion height, cushion tilt, cushion extension, squab recline, bolster. Electric headrest height adjustment. Manual winged headrests, Memory adjusts driver and passenger seats (not side bolsters and lumbar), mirror position and steering wheel (if power adjustable column fitted)
Perforated Grained Leather Sport seats	B41T	—	—	—	○	○	S model includes S logo embossed on front headrest
Rear armrest with twin cupholders	H51A	—	●	●	●	●	
Electrically reclining rear seats	H49A	—	○	○	○	○	
Rear seat remote release levers	H40A	○	○	○	○	○	

## VENEERS

Please see pages 94-95 for full range of veneers

## HEADLINING AND INTERIOR FEATURES

<b>HEADLINING</b>						
Light Oyster headlining	HAMT	●	●	●	●	○
Ebony headlining	HPDB	○	○	○	○	●
Suedecloth headlining	H01D	○	○	○	○	●

# 2 CHOOSE YOUR OPTIONS

 Configure your vehicle at [jaguar.com](http://jaguar.com)

## HEADLINING AND INTERIOR FEATURES CONTINUED

INTERIOR FEATURES	CODE	PURE	PRESTIGE	PORTFOLIO	R-SPORT	S	DESCRIPTION
Illuminated metal treadplates with Jaguar script and metal loadspace scuff plate	F28F	○	○	○	○	○	
Metal loadspace scuff plate	F31A	○	○	○	○	○	
Carpet mats	H69H	○	●	●	●	●	
Premium carpet mats	H69K	○	○	○	○	○	
Bright Sport pedals	G48S	—	—	—	—	●	
Soft Grain leather steering wheel	F96J	●	—	—	—	—	
Soft Grain leather Sport steering wheel	F95U	—	●	●	—	—	
R-Sport Branded Soft Grain leather steering wheel	F96G	—	—	—	●	—	
S Branded Soft Grain leather steering wheel	F95T	—	—	—	—	●	
Black gearshift paddles (requires automatic transmission)	B66G	●	●	●	—	—	
Satin Chrome gearshift paddles (requires automatic transmission)	B66H	—	—	—	●	●	
Heated steering wheel	F97A	○	○	○	○	○	
Electrically adjustable steering column (requires Driver or Driver and Passenger Memory seats)	D07J	○	○	○	○	○	
Auto-Dimming interior rear view mirror	B68B	○	○	○	○	○	
Timed Climate with Remote Control	H10F	○	○	○	○	○	
Four-Zone climate control (requires Air Quality Sensor and Cooled Glove Box. Not available with 8-Way Manual front seats)	C88G	—	○	○	○	○	
Air Quality Sensor and Lockable Cooled Glove Box	C89A, B23H	○	○	○	○	○	
Interior lighting	B65C	●	—	—	—	—	
Interior mood lighting	B65A	○	●	—	●	●	
Configurable interior mood lighting (with 10 colours)	B65B	—	○	●	○	○	
Smoker's Pack	A03B	○	○	○	○	○	
Twin front cupholders with cover (requires 8-speed automatic transmission with Jaguar Sequential Shift)	G71E	●	●	●	●	●	
2 additional Power sockets	D72B	○	●	●	●	●	USB ports located in rear centre console
Loadspace safety partition net	C02B	○	●	●	●	●	
Loadspace storage rails (not available with full size spare wheel)	H52C	○	○	●	●	●	Loadspace storage rails are required for certain accessories. To find out more please refer to your Retailer or go to <a href="http://accessories.jaguar.com">accessories.jaguar.com</a>

● Standard ○ Option — Not available

Please consult your local Jaguar Retailer for details.

For a complete list of optional features and packs refer to the F-PACE Specification and Price Guide or configure your vehicle at [jaguar.com](http://jaguar.com)



**HEADLINING AND INTERIOR FEATURES CONTINUED**

		PURE	PRESTIGE	PORTFOLIO	R-SPORT	S	
<b>INTERIOR FEATURES CONTINUED</b>							<b>DESCRIPTION</b>
	<b>CODE</b>						
Rear Parking Aid	C11A	●	●	●	●	●	
Front Parking Aid	C13A	○	○	●	○	○	
Rear View Camera (requires Front Parking Aid)	C14A	○	○	○	○	○	
Surround Camera System (requires Auto-Dimming mirrors and Front Parking Aid)	C14D	○	○	○	○	○	Refer to page 58
360° Parking Aid (requires Front Parking Aid)	C17A	○	○	○	○	○	Refer to page 58
Park Assist (requires Front Parking Aids, 360° Parking Aid)	C18B	○	○	○	○	○	Refer to page 58
Garage door opener (HomeLink®) (requires Auto-Dimming Interior Rear View Mirror)	B39N	○	○	○	○	○	
Lane Keep Assist and Driver Condition Monitor (requires Auto-Dimming mirrors)	H72D	○	○	○	○	○	Refer to page 58
Blind Spot Monitor and Reverse Traffic Detection (requires Auto-Dimming mirrors and Rear Parking Aid)	H71C	○	○	○	○	○	Refer to page 58
Traffic Sign Recognition and Intelligent Speed Limiter (requires Navigation)	A41B	○	○	○	○	○	Refer to page 58
Jaguar Smart Key System with Keyless Entry and Push Button Start	F04B	○	○	○	○	○	Refer to page 58
Activity Key	F05D	○	○	○	○	○	Refer to page 48/49

# 2 CHOOSE YOUR OPTIONS

 Configure your vehicle at [jaguar.com](http://jaguar.com)

## INCONTROL INFOTAINMENT AND CONNECTIVITY

		PURE	PRESTIGE	PORTFOLIO	R-SPORT	S	
<b>FEATURES ONLY AVAILABLE WITH TOUCH</b>							<b>DESCRIPTION</b>
8" Capacitive Touchscreen	G61C	●	●	●	●	●	Refer to page 51
Instrument Cluster with 5" Central TFT Display	P50S	●	●	●	●	●	Refer to page 51
Navigation	G50F	○	○	○	○	○	Refer to page 52
Jaguar Sound System	B43T	●	●	●	●	●	Refer to page 52
Meridian™ Sound System (380W)	B44V	○	○	○	○	○	
InControl Apps	H57A	○	○	○	○	○	
Connect Pack	Z77J	○	○	○	○	○	Consists of Wi-Fi Hotspot, InControl Apps and Remote Premium
<b>FEATURES ONLY AVAILABLE WITH OPTIONAL TOUCH PRO</b>							(Please see page 55 for more information)
Touch Pro Navigation with 10.2" Touchscreen, 12.3" HD Virtual Instrument Display and Meridian™ Sound System (380W). Requires Connect Pro (Z77A) as standard	Z59X	○	○	○	○	○	In selected markets where Navigation Pro is fitted you must select all the features of Connect Pro. Please consult your local Jaguar Retailer for further details. Refer to page 55
Touch Pro Navigation with 10.2" Touchscreen, 12.3" HD Virtual Instrument Display and Meridian™ Surround Sound System (825W). Requires Connect Pro (Z77A) as standard	Z59Y	○	○	○	○	○	In selected markets where Navigation Pro is fitted you must select all the features of Connect Pro. Please consult your local Jaguar Retailer for further details. Refer to page 55
Connect Pro Pack	Z77A	○	○	○	○	○	Consists of Pro Services, InControl Apps and Remote Premium. In selected markets where Navigation Pro is fitted you must select all the features of Connect Pro. Please consult your local Jaguar Retailer for further details
InControl Apps	H57A	○	○	○	○	○	
Digital TV	G61D	○	○	○	○	○	
10" Dual View Touchscreen	D70E	○	○	○	○	○	
<b>FEATURES AVAILABLE WITH TOUCH OR TOUCH PRO</b>							
Protect	D45D	●	●	●	●	●	Refer to page 51
Secure Tracker	D44A	○	○	○	○	○	Refer to page 51
Digital Audio Broadcast (DAB) Radio	B51A	○	○	○	○	○	

● Standard ○ Option — Not available

Please consult your local Jaguar Retailer for details.

For a complete list of optional features and packs refer to the F-PACE Specification and Price Guide or configure your vehicle at [jaguar.com](http://jaguar.com)

**OPTION PACKS**

OPTION PACKS	CODE	PURE	PRESTIGE	PORTFOLIO	R-SPORT	S	DESCRIPTION
Black Exterior Pack		○	○	○	○	○	Changes exterior finishers to Gloss Black. Black Exterior Pack differences vary by model
Cold Climate Pack	Z88D	—	○	○	○	○	Consists of Heated front windscreen with heated washer jets, Heated steering wheel and Heated front and rear seats
Adaptive Dynamics Pack	Z07A	○	○	○	○	—	Consists of Adaptive Dynamics and Adaptive Surface Response (only available with Automatic transmission and AWD vehicles)
Head-Up Display Pack	Z13A	○	○	○	○	○	Consists of Infrared Reflective windscreen and Head-Up display
Memory Pack for 10-Way seats	Z16X	○	○	○	○	○	Consists of 10-Way Electric front seats with manual headrest height and Driver Memory, Auto-Dimming interior rear view mirror, Auto-Dimming Heated door mirrors with Power Fold and Approach Lights and Electrically adjustable steering column
Memory Pack for 18-Way Sport seats	Z16Y	—	—	○	—	—	Consists of 18-Way Electric Sport front seats with 4-Way Electric lumbar adjust and Driver Memory, Auto-Dimming interior rear view mirror, Auto-Dimming Heated door mirrors with Power Fold and Approach Lights and Electrically adjustable steering column
Memory Pack for 20-Way Luxury seats	Z16W	—	—	○	—	—	Consists of 20-Way Electric Luxury front seats with 4-Way Electric lumbar adjust and Memory, Auto-Dimming, Power Fold, Heated Door Mirrors with Memory and Approach Lights, Auto-Dimming interior rear view mirror Electrically Adjustable steering column
Rear Seat Comfort Pack	Z12C	—	○	○	○	○	Consists of Heated front and rear seats, Cooled glovebox, Air Quality Sensor, Electrically reclining rear seats and Four-zone climate control
Practicality Pack	Z87A	○	○	○	○	○	Consists of Rear seat remote release levers, Gesture Tailgate, Loadspace safety partition net, Lockable cooled glovebox, Air Quality Sensor, Jaguar Smart Key System with Keyless Entry and Push Button Start
Luxury Pack	Z05C	○	○	○	○	○	Consists of Configurable interior mood lighting, Premium carpet mats, Illuminated metal treadplates with Jaguar script and metal loadspace scuff plate and Suedecloth headlining (only available with Automatic transmission)
Business Pack	Z04A	○	○	○	○	○	Consists of Front Parking Aid, Traffic Sign Recognition and Intelligent Speed Limiter, Rear View Camera, Touch Navigation
Premium Business Pack	Z04B	○	○	○	○	○	Consists of Front Parking Aid, Traffic Sign Recognition with Intelligent Speed Limiter, Rear View Camera, Touch Pro Navigation, 12.3" HD virtual Instrument Display, Meridian Sound System
Advanced Parking Assist Pack	Z68N	○	○	○	○	○	Consists of Front and Rear parking aids, Rear View Camera, 360° Parking Aid and Park Assist
Advanced Parking Assist Pack with Surround Camera	Z68Y	○	○	○	○	○	Consists of Front and Rear Parking Aids, Surround Camera System, 360° Parking Aid and Park Assist (requires Auto-Dimming door mirrors)

# 3 CHOOSE YOUR COLOUR

 [Configure your vehicle at jaguar.com](https://www.jaguar.com)

## SOLID

Fuji White



Narvik Black



## METALLIC

Yulong White

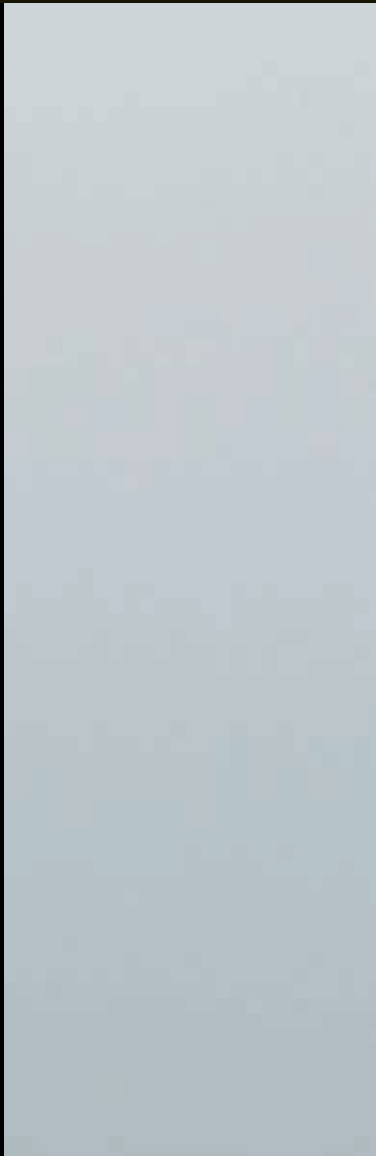

Santorini Black

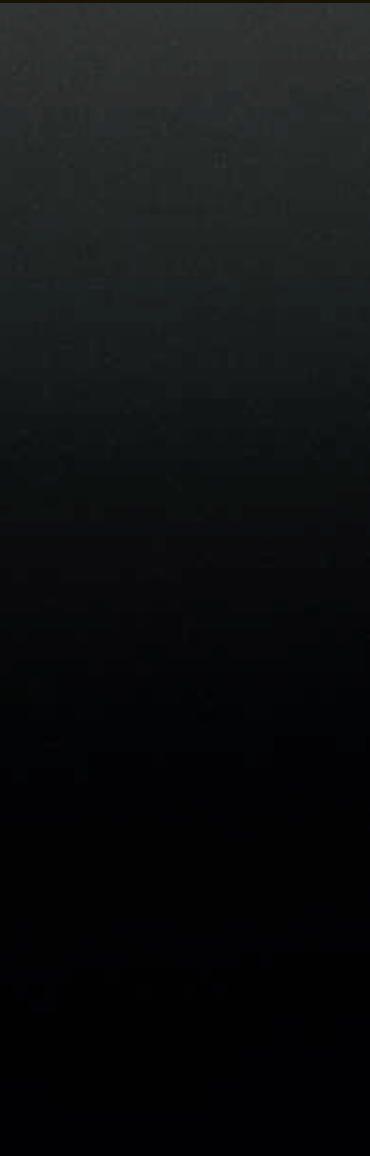

Corris Grey



Loire Blue

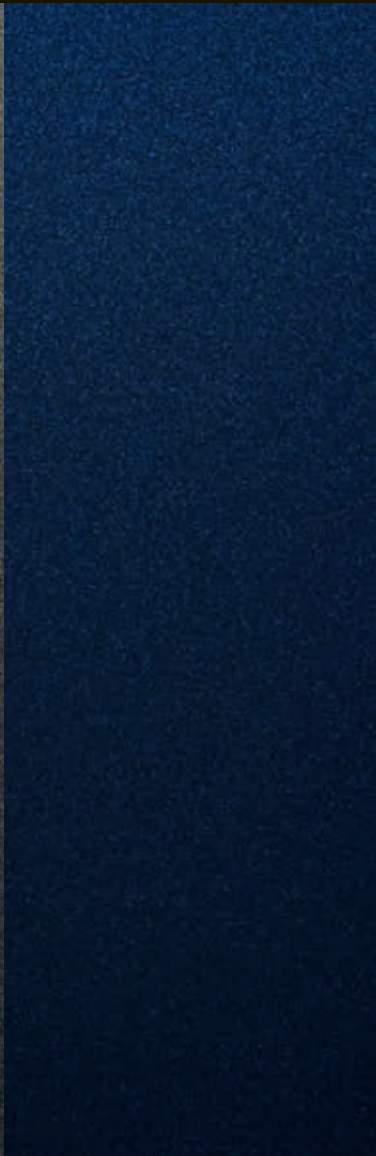

Caesium Blue



British Racing Green



Firenze Red



Indus Silver



PREMIUM PALETTE

Silicon Silver



Carpathian Grey



# 4 CHOOSE YOUR WHEELS

 Configure your vehicle at [jaguar.com](http://jaguar.com)



18" 15 SPOKE  
'STYLE 1022'

18" 10 SPOKE  
'STYLE 1021'

18" 10 SPOKE  
'STYLE 1018'

19" 5 SPOKE  
'STYLE 5037'

19" 5 SPOKE  
'STYLE 5037'

ALLOY WHEEL FINISH	Silver	Silver	Silver	Silver	Gloss Black
ALLOY WHEEL/SIZE	7.5J x 18"	7.5J x 18"	7.5J x 18"	8.5J x 19"	8.5J x 19"
TYRE SIZE	235/65 R18   255/60 R18*	235/65 R18   255/60 R18*	255/60 R18	255/55 R19	255/55 R19
CODE	C54S	C54Q	C54R	C54U	C55R
Pure	●	○	○	○	○
Prestige	●	○	○	○	○
Portfolio	○	○	●	○	○
R-Sport	—	—	—	○	○
S	○	—	○	○	○



19" 7 SPLIT-SPOKE  
'STYLE 7012'

19" 5 SPLIT-SPOKE  
'STYLE 5038'

20" 10 SPLIT-SPOKE  
'STYLE 1019'

20" 5 SPLIT-SPOKE  
'STYLE 5031'

20" 5 SPLIT-SPOKE  
'STYLE 5031'

ALLOY WHEEL FINISH	Silver	Grey and Diamond Turned	Silver	Gloss Black	Grey and Diamond Turned
ALLOY WHEEL/SIZE	8.5J x 19"	8.5J x 19"	8.5J x 20"	8.5J x 20"	8.5J x 20"
TYRE SIZE	255/55 R19	255/55 R19	255/50 R20	255/50 R20	255/50 R20
CODE	C54T	C54V	C54G	C54J	C54H
Pure	○	○	○	○	○
Prestige	○	○	○	○	○
Portfolio	○	○	○	○	○
R-Sport	○	●	○	○	○
S	○	○	○	○	○

● Standard ○ Option — Not Applicable



20" 5 SPLIT-SPOKE  
'STYLE 5036'

20" 5 SPOKE  
'STYLE 5035'

20" 5 SPOKE  
'STYLE 5035'

22" 15 SPOKE  
'STYLE 1020'

ALLOY WHEEL FINISH	Silver	Grey and Diamond Turned	Gloss Black	Silver finish and contrast inserts
ALLOY WHEEL/SIZE	8.5J x 20"	8.5J x 20"	8.5J x 20"	9.0J x 22"
TYRE SIZE	255/50 R20	255/50 R20	255/50 R20	265/40 R22
CODE	C54F	C54X	C54Y	C54K

Pure	<input type="radio"/>	<input type="radio"/>	<input type="radio"/>	<input type="radio"/>
Prestige	<input type="radio"/>	<input type="radio"/>	<input type="radio"/>	<input type="radio"/>
Portfolio	<input type="radio"/>	<input type="radio"/>	<input type="radio"/>	<input type="radio"/>
R-Sport	<input type="radio"/>	<input type="radio"/>	<input type="radio"/>	<input type="radio"/>
S	<input type="radio"/>	<input checked="" type="radio"/>	<input type="radio"/>	<input type="radio"/>



22" 15 SPOKE  
'STYLE 1020'

22" 15 SPOKE  
'STYLE 1020'

22" 9 SPOKE  
'STYLE 9006'

22" 9 SPOKE  
'STYLE 9006'

ALLOY WHEEL FINISH	Black finish and contrast inserts	Grey finish and contrast inserts	Grey and Diamond Turned	Chrome
ALLOY WHEEL/SIZE	9.0J x 22"	9.0J x 22"	9.0J x 22"	9.0J x 22"
TYRE SIZE	265/40 R22	265/40 R22	265/40 R22	265/40 R22
CODE	C54L	C54P	C54M	C54N

Pure	<input type="radio"/>	<input type="radio"/>	<input type="radio"/>	<input type="radio"/>
Prestige	<input type="radio"/>	<input type="radio"/>	<input type="radio"/>	<input type="radio"/>
Portfolio	<input type="radio"/>	<input type="radio"/>	<input type="radio"/>	<input type="radio"/>
R-Sport	<input type="radio"/>	<input type="radio"/>	<input type="radio"/>	<input type="radio"/>
S	<input type="radio"/>	<input type="radio"/>	<input type="radio"/>	<input type="radio"/>

\*Fuel consumption/Emissions figures will vary based on tyre size. See page 100 for details. Standard and optional features may differ depending on market availability.

# 5 CHOOSE YOUR INTERIOR

 Configure your vehicle at [jaguar.com](http://jaguar.com)

PURE						
	SEAT WITH TONAL STITCH	FINISHER	HEADLINING MORZINE*	UPPER FACIA WITH NO STITCH	CARPET	INTERIOR TRIM AND OPTION CODES
<b>Standard</b>						
Premium fabric seats	Ebony with Ebony	Gloss Black	Light Oyster or Ebony**	Ebony	Ebony	TR44
PRESTIGE						
	SEAT WITH CONTRAST STITCH	FINISHER	HEADLINING MORZINE*	UPPER FACIA WITH NO STITCH	CARPET	INTERIOR TRIM AND OPTION CODES
<b>Standard</b>						
Grained Leather seats	Ebony with Siena Tan	Gloss Black	Light Oyster or Ebony**	Ebony	Ebony	TR46
	Latte with Espresso	Gloss Black	Light Oyster	Espresso	Espresso	TR48
	Light Oyster with Pistachio	Gloss Black	Light Oyster or Ebony**	Ebony	Ebony	TR47
PORTFOLIO						
	SEAT WITH TONAL STITCH	FINISHER	HEADLINING MORZINE*	UPPER FACIA WITH TONAL STITCH	CARPET	INTERIOR TRIM AND OPTION CODES
<b>Standard</b>						
Perforated Windsor Leather seats	Ebony with Ebony	Gloss Figured Ebony	Light Oyster or Ebony**	Ebony with Ebony	Ebony	TR58
	Espresso with Espresso	Gloss Figured Ebony	Light Oyster	Espresso with Espresso	Espresso	TR61
	Siena Tan with Siena Tan	Gloss Figured Ebony	Light Oyster or Ebony**	Ebony with Ebony	Ebony	TR62
	Latte with Latte	Gloss Figured Ebony	Light Oyster	Espresso with Espresso	Espresso	TR59
	Light Oyster with Light Oyster	Gloss Figured Ebony	Light Oyster	Oyster with Oyster	Oyster	TR60

\*Suedecloth headlining available as an option.  
 \*\*Ebony headlining available as an option.  
 †Light Oyster headlining available as an option.  
 \*\*Morzine headlining available as an option.



<b>R-SPORT</b>						
	<b>SEAT WITH CONTRAST STITCH</b>	<b>FINISHER</b>	<b>HEADLINING MORZINE*</b>	<b>UPPER FACIA WITH NO STITCH</b>	<b>CARPET</b>	<b>INTERIOR TRIM AND OPTION CODES</b>
<b>Standard</b>						
Sports Luxtec seats with technical mesh inserts	Ebony/Ebony with Light Oyster	Gloss Black	Light Oyster or Ebony**	Ebony	Ebony	TR49
	<b>SEAT WITH CONTRAST STITCH</b>	<b>FINISHER</b>	<b>HEADLINING MORZINE*</b>	<b>UPPER FACIA WITH CONTRAST STITCH</b>	<b>CARPET</b>	<b>INTERIOR TRIM AND OPTION CODES</b>
<b>Optional</b>						
Perforated Grained Leather Sport seats	Ebony/Ebony with Light Oyster	Gloss Black	Light Oyster or Ebony**	Ebony with Light Oyster	Ebony	TR49 +B41T (leather upgrade)
	Ebony/Pimento with Pimento	Gloss Black	Light Oyster or Ebony**	Ebony with Pimento	Ebony	TR50
	Ebony/Light Oyster with Light Oyster	Gloss Black	Light Oyster or Ebony**	Ebony with Light Oyster	Ebony	TR51
	Oyster/Oyster with Lime	Gloss Black	Light Oyster	Oyster with Lime	Oyster	TR52
<b>S</b>						
	<b>SEAT WITH CONTRAST STITCH</b>	<b>FINISHER</b>	<b>HEADLINING SUEDECLOTH**</b>	<b>UPPER FACIA WITH NO STITCH</b>	<b>CARPET</b>	<b>INTERIOR TRIM AND OPTION CODES</b>
<b>Standard</b>						
Sports Grained Leather seats with Suedecloth inserts	Ebony/Ebony with Light Oyster	Meshed Aluminium	Ebony or Light Oyster†	Ebony	Ebony	TR53
	<b>SEAT WITH CONTRAST STITCH</b>	<b>FINISHER</b>	<b>HEADLINING SUEDECLOTH**</b>	<b>UPPER FACIA WITH CONTRAST STITCH</b>	<b>CARPET</b>	<b>INTERIOR TRIM AND OPTION CODES</b>
<b>Optional</b>						
Perforated Grained Leather Sport seats	Ebony/Ebony with Light Oyster	Meshed Aluminium	Ebony or Light Oyster†	Ebony with Light Oyster	Ebony	TR53+B41T (leather upgrade)
	Pimento/Ebony with Ebony	Meshed Aluminium	Ebony or Light Oyster†	Ebony with Pimento	Ebony	TR54
	Brogue/Brogue with Light Oyster	Meshed Aluminium	Ebony or Light Oyster†	Ebony with Light Oyster	Ebony	TR56
	Light Oyster/Ebony with Ebony	Meshed Aluminium	Ebony or Light Oyster†	Ebony with Light Oyster	Ebony	TR70

# 5 CHOOSE YOUR INTERIOR

⚙️ Configure your vehicle at [jaguar.com](https://www.jaguar.com)

Interior shown: Ebony fabric seats with Gloss Black finisher, Light Oyster headlining and Ebony facia.



# PURE

## INTERIOR COLOUR COMBINATIONS

### STANDARD



### FINISHER OPTIONS

Satin Fine Line Wood, Satin Burr Ash, Satin Grey Ash, Satin Grey Figured Ebony, Gloss Figured Ebony, Etched Aluminium or Meshed Aluminium

\*Suedecloth headlining available as an option.

\*\*Ebony headlining available as an option.

# 5 CHOOSE YOUR INTERIOR

⚙️ Configure your vehicle at [jaguar.com](https://www.jaguar.com)













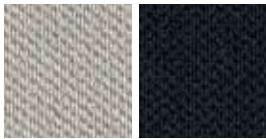

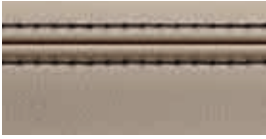
Interior shown: Latte Grained leather seats with Espresso contrast stitch, Gloss Black finisher with Light Oyster headlining and Espresso facia.



# PRESTIGE

## INTERIOR COLOUR COMBINATIONS

### STANDARD

1	2	3	4	5
SEAT WITH CONTRAST STITCH  Ebony with Siena Tan	FINISHER  Gloss Black	HEADLINING MORZINE*  Light Oyster or Ebony**	UPPER FACIA WITH NO STITCH  Ebony	CARPET  Ebony
 Latte with Espresso	 Gloss Black	 Light Oyster	 Espresso	 Espresso
 Light Oyster with Pistachio	 Gloss Black	 Light Oyster or Ebony**	 Ebony	 Ebony

### FINISHER OPTIONS

Satin Fine Line Wood, Satin Burr Ash, Satin Grey Ash, Satin Grey Figured Ebony, Gloss Figured Ebony, Etched Aluminium or Meshed Aluminium

\*Suedecloth headlining available as an option.  
\*\*Ebony headlining available as an option.

# 5 CHOOSE YOUR INTERIOR

⚙️ Configure your vehicle at [jaguar.com](https://www.jaguar.com)















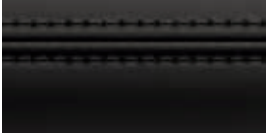





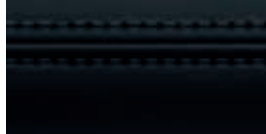

Interior shown: Siena Tan Windsor leather seats with Siena Tan tonal stitch, Gloss Figured Ebony finisher with Light Oyster headlining and Ebony facia.

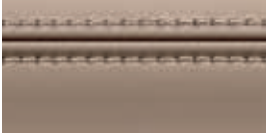

# PORTFOLIO

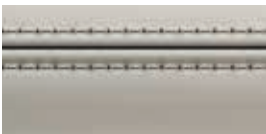
## INTERIOR COLOUR COMBINATIONS

### STANDARD

1	2	3	4	5
SEAT WITH TONAL STITCH	FINISHER	HEADLINING MORZINE*	UPPER FACIA WITH TONAL STITCH	CARPET
				
Ebony with Ebony	Gloss Figured Ebony	Light Oyster or Ebony**	Ebony with Ebony	Ebony
				
Espresso with Espresso	Gloss Figured Ebony	Light Oyster	Espresso with Espresso	Espresso
				
Siena Tan with Siena Tan	Gloss Figured Ebony	Light Oyster or Ebony**	Ebony with Ebony	Ebony
				
Latte with Latte	Gloss Figured Ebony	Light Oyster	Espresso with Espresso	Espresso
				
Light Oyster with Light Oyster	Gloss Figured Ebony	Light Oyster	Oyster with Oyster	Oyster

### FINISHER OPTIONS

Satin Fine Line Wood, Satin Burr Ash, Satin Ash Grey, Satin Grey Figured Ebony, Gloss Black, Etched Aluminium or Meshed Aluminium

\*Suedecloth headlining available as an option.  
 \*\*Ebony headlining available as an option.

# 5 CHOOSE YOUR INTERIOR

⚙️ Configure your vehicle at [jaguar.com](https://www.jaguar.com)

Interior shown: Ebony and Pimento Grained leather Sports seats with Pimento contrast stitch, Etched Aluminium finisher with Ebony headlining and Ebony facia.

















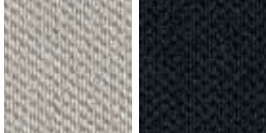

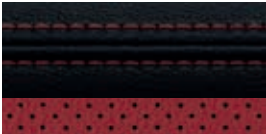

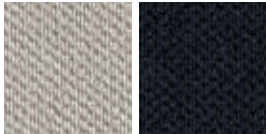

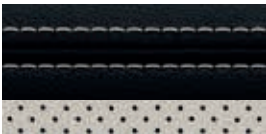
# R-SPORT

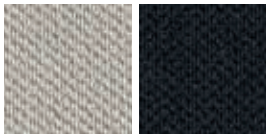
## INTERIOR COLOUR COMBINATIONS

### STANDARD

①	②	③	④	⑤
SEAT WITH CONTRAST STITCH	FINISHER	HEADLINING MORZINE*	UPPER FACIA	CARPET
				
Ebony/Ebony with Light Oyster	Gloss Black	Light Oyster or Ebony**	Ebony	Ebony

### OPTIONAL

				
Ebony/Ebony with Light Oyster	Gloss Black	Light Oyster or Ebony**	Ebony with Light Oyster	Ebony
				
Ebony/Pimento with Pimento	Gloss Black	Light Oyster or Ebony**	Ebony with Pimento	Ebony
				
Ebony/Light Oyster with Light Oyster	Gloss Black	Light Oyster or Ebony**	Ebony with Light Oyster	Ebony
				
Oyster/Oyster with Lime	Gloss Black	Light Oyster	Oyster with Lime	Oyster

### FINISHER OPTIONS

Satin Fine Line Wood, Satin Burr Ash, Satin Grey Ash, Satin Grey Figured Ebony, Gloss Figured Ebony, Etched Aluminium or Meshed Aluminium

\*Suedecloth headlining available as an option.  
 \*\*Ebony headlining available as an option.

# 5 CHOOSE YOUR INTERIOR

⚙️ Configure your vehicle at [jaguar.com](https://www.jaguar.com)

Interior shown: Brogue Grained leather Sports seats with Light Oyster contrast stitch, Meshed Aluminium finisher with Ebony headlining and Ebony facia.













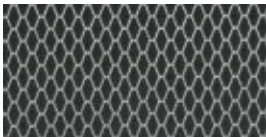

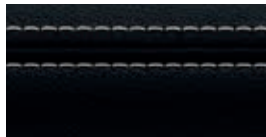

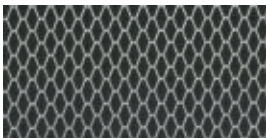

# S

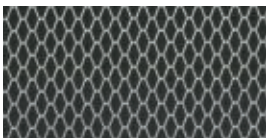
## INTERIOR COLOUR COMBINATIONS

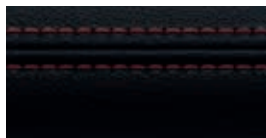
### STANDARD

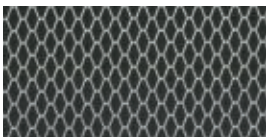
①	②	③	④	⑤
SEAT WITH CONTRAST STITCH	FINISHER	HEADLINING SUEDECLOTH*	UPPER FACIA	CARPET
				
Ebony/Ebony with Light Oyster	Meshed Aluminium	Ebony or Light Oyster**	Ebony	Ebony

### OPTIONAL

				
Ebony/Ebony with Light Oyster	Meshed Aluminium	Ebony or Light Oyster**	Ebony with Light Oyster	Ebony
				
Brogue/Brogue with Light Oyster	Meshed Aluminium	Ebony or Light Oyster**	Ebony with Light Oyster	Ebony
				
Pimento/Ebony with Ebony	Meshed Aluminium	Ebony or Light Oyster**	Ebony with Pimento	Ebony
				
Light Oyster/Ebony with Ebony	Meshed Aluminium	Ebony or Light Oyster**	Ebony with Light Oyster	Ebony

### FINISHER OPTIONS

Satin Fine Line Wood, Satin Burr Ash, Satin Grey Ash, Satin Grey Figured Ebony, Gloss Figured Ebony, Etched Aluminium or Gloss Black

\*Morzine headlining available as an option.

\*\*Light Oyster headlining available as an option.

# 5 CHOOSE YOUR INTERIOR

 Configure your vehicle at [jaguar.com](http://jaguar.com)

Gloss Black finisher



Meshed Aluminium finisher

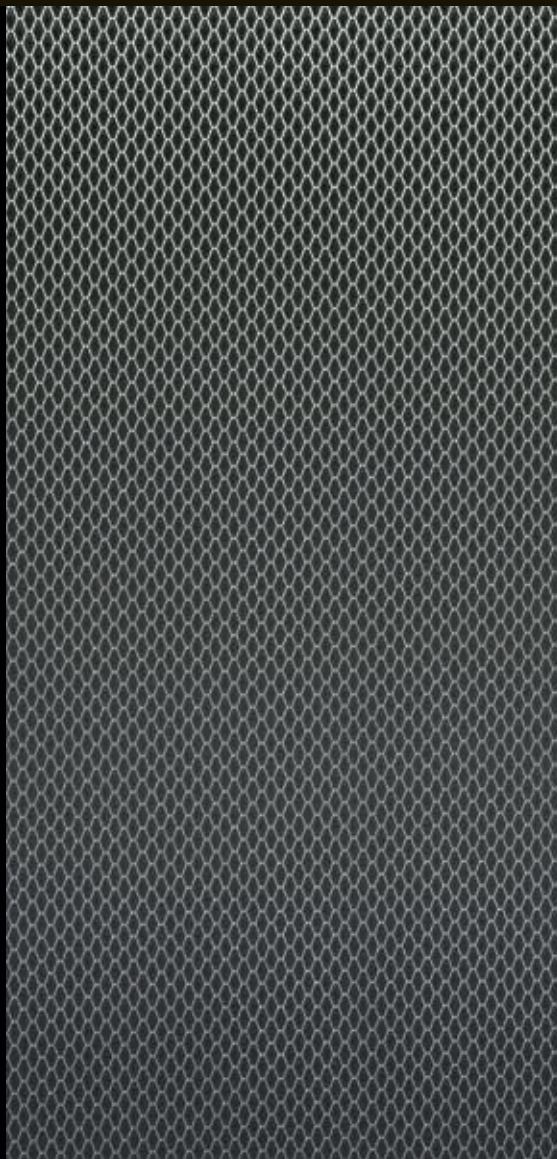

Etched Aluminium finisher

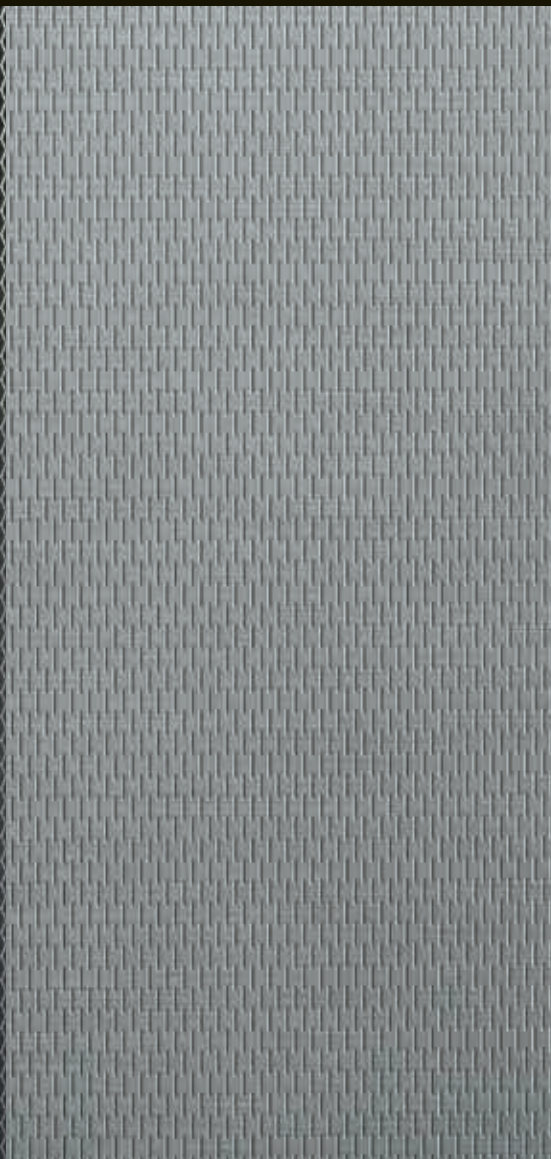

Gloss Figured Ebony veneer



Satin Grey Figured Ebony veneer



Satin Fine Line Wood veneer



Satin Burr Ash veneer



Satin Grey Ash veneer



# 6 CHOOSE YOUR JAGUAR GEAR ACCESSORIES

To find out more about the full range of Retailer fit Jaguar Gear Accessories, please refer to your Retailer or go to [accessories.jaguar.com](http://accessories.jaguar.com)



## **Ski/Snowboard Holder\*** **C2A1538**

A safe and secure Jaguar branded system for transporting winter sports equipment. Incorporates slider rails for easy loading. For four pairs of skis or two snowboards.

\*Requires Roof Rails and Roof Cross Bars.

\*\*Automatic transmission only.



**Personalised Illuminated Sill Treadplates**  
**T4A5869PVJ - Jet**

Elegantly styled stainless steel sill treadplate finishers for driver or passenger doors. Illuminates when either the driver or passenger doors are opened. Highlighted by soft Phosphor Blue lighting. Allows you to specify a monochrome 'motif' in a choice of approved typefaces/scripts.



**Union Jack Sill Treadplates**  
**T4A5867PVJ - Jet**

Elegantly styled stainless steel sill treadplate finisher for driver or passenger doors featuring a distinctly British design.



**iPad® Holder**  
**T2H7757**

Jaguar branded iPad® holder mounts to front seat headrests providing a flexible solution for rear seat entertainment. Quick release design ensures iPad® can be fitted or removed quickly and easily.



**Headrest Mounted Coat Hanger**  
**T2H7759**

The Jaguar coat hanger is a headrest mounted solution featuring Jaguar branding and a chromed 'spring fit' construction. Mounting simply and securely this coat hanger is easy to fit and remove and provides a convenient stowage point to keep clothing wrinkle free.



**Central Armrest Chiller / Warmer**  
**T2H7739**

Food and drinks chiller and warmer that acts as a rear centre armrest. With a leather-covered top, it is held in place by the centre seat belt and powered from the rear auxiliary socket. Ideal for long journeys with the family.



**Aluminium Gearshift Paddles\*\***  
**T2R6547MMU**

Replacement steering wheel gearshift paddles offered in a premium aluminium material providing a high quality finish to a key contact point in the vehicle. Manufactured from billet machined aluminium, the paddles are hand brushed for a premium finish and anodised to ensure they will not deteriorate with wear.

# 6 CHOOSE YOUR JAGUAR GEAR ACCESSORIES

 Configure your vehicle at [jaguar.com](http://jaguar.com)



**Carbon Fibre Side Power Vent**  
T4A12419 - Left Side  
T4A12418 - Right Side

High grade Carbon Fibre side power vents provide a performance-inspired styling upgrade.



**Gloss Black Side Power Vent**  
T4A4307 - Left Side  
T4A4304 - Right Side

Gloss Black side power vents provide a dynamic exterior styling enhancement.



**Wind Deflector**  
T4A7371

Simple to fit and remove, these wind deflectors will add to front seat passenger comfort by allowing air to circulate the cabin whilst reducing draughts and preventing rain from entering the vehicle. Kit includes two front and two rear deflectors.



**Carbon Fibre Mirror Cover**  
T4A7226

High grade Carbon Fibre mirror covers provide a performance-inspired styling upgrade.



**Gloss Black Mirror Cover**  
T4A12007

Gloss Black mirror covers accentuate the dynamic design of the exterior mirrors.



**Chrome Mirror Cover**  
T4A7131

Chrome mirror covers accentuate the stylish design of the exterior mirrors.

\*Not applicable for Jaguar sound system unless equipped with DAB, Navigation or Touch Pro.





**Electrically Deployable Side Steps\***  
**T4A12783 - Left Side**  
**T4A12780 - Right Side**

These smart, practical steps make it easier to get in and out of the vehicle and improve access to the roof. Neatly stowed under the sills, the side steps automatically deploy as soon as the door is opened. They stow automatically when the door is closed.



**Fixed Side Steps**  
**T4A11848**

The side steps aid entry and exit to the vehicle and improve access to the roof. Design features Jaguar branding and includes bright stainless steel edge trim and a rubber tread mat, to complement the vehicle's exterior styling cues.



**Bright Side Tubes**  
**T4A11579**

Highly polished stainless steel side tubes complement the vehicle's exterior style.



**Front Splash Guards**  
**T4A12742**

Jaguar branded, front splash guards complement the lines of your vehicle and provide protection from dirt and stone chippings.



**Rear Splash Guards**  
**T4A12743**

Jaguar branded, rear splash guards complement the lines of your vehicle and provide protection from dirt and stone chippings.



**Tow Bar Mounted Cycle Carrier**  
**C2Z22695 - Two Bike Carrier**  
**C2Z22697 - Three Bike Carrier**

Premium tow ball mounted cycle carriers provide a convenient bike carrying solution with quick release loading attachments and secure locking mechanism. Clever design allows carrier to be tilted away from vehicle when fitted allowing access into the rear tailgate.

# 6 CHOOSE YOUR JAGUAR GEAR ACCESSORIES

 Configure your vehicle at [jaguar.com](https://www.jaguar.com)



**Luggage Compartment Rubber Mat\***  
**T4A4218**

This premium mat is tailored specifically to protect the luggage compartment. Light and durable, it is easily removable for cleaning.



**Premium Luggage Compartment Carpet Mat\***  
**T4A4217**

Luxurious soft luggage mat in Ebony with the Jaguar logo. Deep premium 2,050g/m<sup>2</sup> pile with Nubuck edging and Dove contrast stitch.



**Luggage Compartment Partition Net**  
**T4A8449**

Convenient partition net fitting to luggage compartment D-loops and fixings in roof lining.



**Luggage Compartment Partition - Divider\*\***  
**T4A11741**

Offered as an addition to the full or half height luggage compartment partition to separate the loadspace into two sections across the width of the vehicle.



**Luggage Compartment Partition - Full Height\*\***  
**T4A11739**

The luggage compartment partition is designed to prevent cargo from entering the passenger compartment.\*



**Bumper Protector**  
**T2H7950**

Convenient pull out protector provides protection for the rear bumper from scratches and scuffs, helping to prevent clothing from collecting dirt from the bumper during loading/unloading. Manufactured from a robust fabric material the bumper protector has been designed to concertina into the space under the luggage compartment floor for stowage.

\*Not available with full size spare wheel.

\*\*Not compatible with rear loadspace cover, rubber loadspace liner and not available for vehicles with full size spare wheel.

†Requires Roof Rails. ‡Requires Roof Cross Bars.



**Roof Cross Bars†**  
**T4A13875**

Jaguar branded cross bars required for fitting all roof carrying equipment. Engineered specifically for your vehicle.



**Ski/Snowboard Holder†‡**  
**C2A1538**

A safe and secure Jaguar branded system for transporting winter sports equipment. Incorporates slider rails for easy loading. For four pairs of skis or two snowboards.



**Watersports Carrier†‡**  
**C2Z21730**

A versatile system for transporting a variety of water sports equipment including surfboard, kayak or sailboard. Tilts to facilitate loading/unloading.



**Roof Sport Box†‡**  
**C2C41627**

Spacious 320 litre capacity lockable roof box designed for sports equipment, measuring 206 x 84 x 34cm.



**Roof Sport Box - Large†‡**  
**T2H7753**

Power-click quick mounting system with integrated torque indicator for easy and secure fixing with a single-handed grip. The 430 litre large roof sport box opens from both sides with handles on the lid and inside the box, for convenient fitting, loading and unloading. Gloss Black finish and lockable for security.



**UV Sunshade - Front Windscreen**  
**T4A4216**

Tailor-made for the F-PACE windscreen and features Jaguar branding. Reflects the sun's rays and helps to keep the interior of the vehicle cool.

# TECHNICAL SPECIFICATIONS

 Configure your vehicle at [jaguar.com](http://jaguar.com)

ENGINES		2.0 LITRE 4 CYLINDER RWD TURBOCHARGED DIESEL	2.0 LITRE 4 CYLINDER RWD TURBOCHARGED DIESEL	2.0 LITRE 4 CYLINDER AWD TURBOCHARGED DIESEL
Capacity	cc	1,999	1,999	1,999
Maximum power	EEC-PS (kW)	163 (120)	180 (132)	180 (132)
@rev/min	rpm	4,000	4,000	4,000
Maximum torque	EEC-Nm (lb.ft.)	380 (280)	430 (317)	430 (317)
@rev/min	rpm	1,750-2,500	1,750-2,500	1,750-2,500
PERFORMANCE		MANUAL	AUTOMATIC	MANUAL/AUTOMATIC
0-100 km/h	seconds	10.2	8.5	8.7/8.7
0-60 mph	seconds	9.7	8.0	8.2/8.2
Top speed	km/h (mph)	195 (121)	208 (129)	208 (129)/208 (129)
FUEL CONSUMPTION <sup>1</sup>				
Urban	l/100km (mpg)	5.8/5.8* (48.7/49.1*)	6.0 (47.1)	6.0 (47.1)/6.2 (45.6)
Extra Urban	l/100km (mpg)	4.4/4.2* (64.2/67.2*)	4.6 (61.4)	4.7 (60.1)/4.7 (60.1)
Combined	l/100km (mpg)	4.9/4.8* (57.7/59.2*)	5.1 (55.4)	5.2 (54.3)/5.3 (53.3)
CO <sub>2</sub> Urban	g/km	151/152*	157	155/164
CO <sub>2</sub> Extra Urban	g/km	116/111*	121	122/125
CO <sub>2</sub> Combined	g/km	129/126*	134	134/139
Tank capacity (usable)	litres approx.	60	60	60
DIMENSIONS				
Overall length	mm	4,731	4,731	4,731
Overall width (inc. mirrors)	mm	2,175	2,175	2,175
Overall width (mirrors folded)	mm	2,070	2,070	2,070
Overall height (with the sunroof open)	mm	1,693	1,693	1,693
Wheelbase	mm	2,874	2,874	2,874
Front track	mm	1,641	1,641	1,641
Rear track	mm	1,654	1,654	1,654
Ground clearance	mm	213	213	213
Turning circle diameter (kerb-to-kerb)	metres	11.59	11.59	11.59
Boot volume (when tyre repair system is fitted)	litres	650**	650**	650**
WEIGHT <sup>2</sup>				
Weight from	kg	1,690	1,720	1,767/1,775
Gross vehicle weight	kg	2,380	2,380	2,460/2,460
Maximum Towing Capacity	kg	1,600	2,400	2,000/2,400
ENGINE AVAILABILITY				
Pure		●	●	●
Prestige		●	●	●
Portfolio		●	●	●
R-Sport		●	●	●
S		—	—	—

● Available — Not Available

\*Figure refers to cars fitted with 235/65 R18 tyres on 'Style 1021' or 'Style 1022' wheels. \*\*With tyre repair system. 508 litres with space saver spare wheel. 463 litres with full size spare wheel. †Limited top speed.

Engine availability is market dependent. Please consult your local Jaguar Retailer for details.

25d 2.0 LITRE 4 CYLINDER AWD TWIN TURBOCHARGED DIESEL	25t 2.0 LITRE 4 CYLINDER AWD TURBOCHARGED PETROL	30d 3.0 LITRE V6 AWD TWIN TURBOCHARGED DIESEL	35t 3.0 LITRE V6 AWD SUPERCHARGED PETROL	S 3.0 LITRE V6 AWD SUPERCHARGED PETROL
1,999	1,997	2,993	2,995	2,995
240 (177)	250 (184)	300 (221)	340 (250)	380 (280)
4,000	5,500	4,000	6,500	6,500
500 (368)	365 (269)	700 (516)	450 (332)	450 (332)
1,500	1,200-4,500	1,500-1,750	4,500	4,500
AUTOMATIC	AUTOMATIC	AUTOMATIC	AUTOMATIC	AUTOMATIC
7.2	6.8	6.2	5.8	5.5
6.7	6.4	5.8	5.4	5.1
217 (135)	217 (135)	241 (150)	250 (155) <sup>†</sup>	250 (155) <sup>†</sup>
7.1 (39.8)	9.1 (31.0)	6.9 (40.9)	12.2 (23.2)	12.2 (23.2)
5.0 (56.5)	6.6 (42.8)	5.6 (50.4)	7.1 (39.8)	7.1 (39.8)
5.8 (48.7)	7.4 (38.2)	6.0 (47.1)	8.9 (31.7)	8.9 (31.7)
188	205	181	284	284
133	150	146	166	166
153	170	159	209	209
60	63	66	63	63
4,731	4,731	4,731	4,731	4,731
2,175	2,175	2,175	2,175	2,175
2,070	2,070	2,070	2,070	2,070
1,693	1,693	1,693	1,693	1,693
2,874	2,874	2,874	2,874	2,874
1,641	1,641	1,641	1,641	1,641
1,654	1,654	1,654	1,654	1,654
213	213	213	213	213
11.59	11.59	11.59	11.59	11.59
650**	650**	650**	650**	650**
1,810	1,760	1,884	1,820	1,861
2,470	2,460	2,570	2,500	2,500
2,400	2,400	2,400	2,400	2,400
●	●	●	●	—
●	●	●	●	—
●	●	●	●	—
●	●	●	●	—
—	—	●	—	●

<sup>†</sup>The figures provided are as a result of official manufacturer's tests in accordance with EU legislation. A vehicle's actual fuel consumption may differ from that achieved in such tests and these figures are for comparative purposes only.

<sup>\*\*</sup>Weights reflect vehicles to standard specifications. Optional extras increase weight.

# DIMENSIONS

**Overall Width** (inc. mirrors) 2,175mm  
**Overall Width** (mirrors folded) 2,070mm  
**Boot Volume** 650\* Litres



**Turning Circle**

Kerb-to-kerb 11.59 metres  
Turns lock to lock 2.5

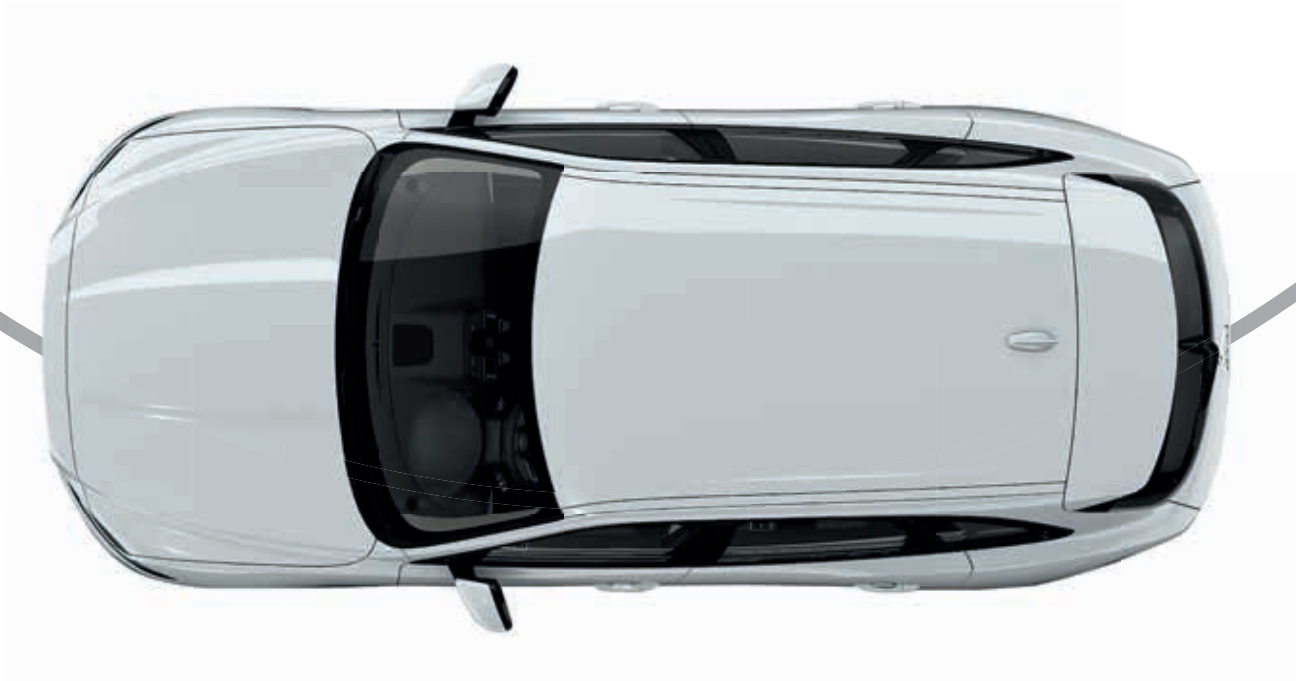

**Headroom**

Maximum front headroom  
1,007mm\*\*

**Rear Headroom**

977mm\*\*

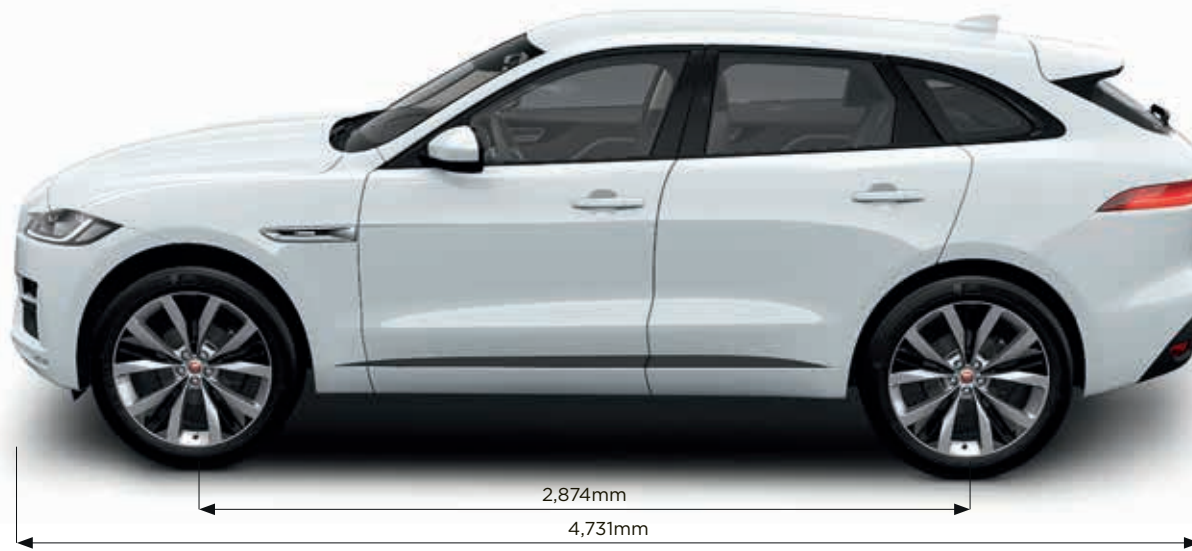

\*With tyre repair system. 508 litres with space saver spare wheel. 463 litres with full size spare wheel. \*\*Maximum headroom with fixed metal roof.  
VEHICLE SHOWN: F-PACE R-SPORT IN YULONG WHITE OPTIONAL FEATURES FITTED (MARKET DEPENDENT)

## JAGUAR EXPERIENCE

There's no better way to get to know Jaguar than by taking a drive. The Jaguar Experience offers a range of unique opportunities to really find out what it feels like to get the most out of a Jaguar. Our track experiences allow you to push yourself and cars from the incredible Jaguar range to the limit. Jaguar Experience also offers the opportunity to see a Jaguar brought to life during a tour of one of our UK manufacturing facilities.

Find out more by visiting [jaguar.com/experience](http://jaguar.com/experience)



## BEHIND THE SCENES

Our factory tours give you the unique opportunity to experience the whole process of how our cars are brought to life - from the moulding of sheet metal to those intricate final touches. At our state-of-the-art production facilities, you'll get to see how skilled technicians and sophisticated machines work seamlessly together to perfect some of Jaguar's most breathtaking cars.

Find out more at [jaguar.com/experience-jaguar/behind-the-scenes](http://jaguar.com/experience-jaguar/behind-the-scenes)





## DRIVING EXPERIENCES

The opportunity to drive the latest Jaguar cars at their limits, or relive iconic Jaguar history, is rare. Jaguar Driving Experiences offer unique driving adventures you will never forget. Imagine yourself behind the wheel of our highest performing Jaguar models, on a private track, with a Jaguar Experience Instructor at your side. This is the Jaguar Performance Driving Academy.

Find out more at [jaguar.com/experience-jaguar/driving-experiences](https://www.jaguar.com/experience-jaguar/driving-experiences)



## ICONIC EXPERIENCES

Take your driving to the next level with the Jaguar Land Rover Ice Drive Experience. From 2017, we are offering an adventure in Arjeplog, Sweden, that will test and develop your performance driving skills in extreme conditions. It's a rare chance for owners and enthusiasts to tackle some of the harshest and most challenging tracks on earth, under the skilled guidance of our experts. Our driving instructors are of the highest-calibre and will be with you every step of the way - ready to impart years of driving wisdom. You will dance on ice, glide around some of the most awe-inspiring corners imaginable and realise the true exhilarating potential of Jaguar and Land Rover.

If you'd like to be part of the next adventure, find out more by visiting [jaguar.com/experience-jaguar/iconic-experiences](https://www.jaguar.com/experience-jaguar/iconic-experiences)

# THE WORLD OF JAGUAR

Choose an F-PACE and you're joining the exciting World of Jaguar. It makes owning and driving carefree and easy, as well as providing a range of exclusive services and lifestyle products.



## JAGUAR CARE\*

F-PACE is offered with unlimited mileage, three year warranty and three years' standard servicing programme. We call this programme Jaguar Care. It makes F-PACE's overall cost of ownership one of the lowest in its class.

To find out more about F-PACE's Jaguar Care programme, please go to [jaguar.com/jaguarcare](http://jaguar.com/jaguarcare)



## SERVICING

F-PACE has been designed to keep servicing costs to a minimum - for example, the new Ingenium diesel engines can achieve an incredible 34,000km or 2 years<sup>†</sup> between services due to intelligent design and advanced oil technology.

## GENUINE PARTS

Jaguar Genuine Parts are designed, tested and manufactured to our uncompromising standards for quality, fit and durability. Each part is engineered specifically for your F-PACE to contribute to optimum performance and to help maximise its lifespan.



## FLEET & BUSINESS

Jaguar is dedicated to being the premium manufacturer of choice for fleets and businesses by providing a highly attractive car range and exemplary customer service. Jaguars are dynamic and distinctive cars that help companies express the unique character and personality of their business. We are committed to providing totally customer-focused aftersales services, which keeps every Jaguar car on the move and in top condition, ensuring that they perform to the highest standard and in the most cost-efficient way for businesses. Visit [jaguar.com/fleet-and-business](http://jaguar.com/fleet-and-business) for more information.

\*Selected European Markets only.

\*\*Manufacturer's estimate.

†Market and driving style dependent.



#### JAGUAR FINANCIAL SERVICES

Effortless performance and style come as standard with every Jaguar. Jaguar Financial Services makes buying one just as simple and rewarding. New or used, for personal or business use, we have an option that puts you in complete control. Please speak to your local Jaguar retailer to find out more.



#### JAGUAR ASSISTANCE

Jaguar Assistance provides assistance in motoring emergencies, from immobilisation due to breakdown or accident to minor problems such as punctures. You can rely on our roadside assistance, whatever the situation, wherever you happen to be.

#### INSURANCE

F-PACE's key components are easily accessible for time-efficient service and repair costs. With a focus on lower repair costs, F-PACE delivers competitive insurance group ratings\*\*. To find out more about the compelling business case for F-PACE, please contact your local Jaguar retailer.



#### JAGUAR MAGAZINE

This is our own vibrant, cosmopolitan and contemporary magazine. Produced by a team of enthusiastic designers and feature writers, it goes behind the scenes at Jaguar as well as providing insight into the world of luxury, design, style and travel. You can enjoy Jaguar Magazine twice a year completely free of charge for the first three years. Ask your retailer to ensure that you receive your copy.

#### JAGUAR COLLECTION

The latest range from the Jaguar Collection has been crafted with the same design execution and attention to detail that goes into all of our cars. This is evident in our clothing range, premium leather items and luxury travel goods. To celebrate Jaguar's heritage we also have a collection that honours past achievements and features race inspired gift items and apparel. To find out more, visit the online shop at [www.jaguar.com/shop](http://www.jaguar.com/shop)

# GLOSSARY

## A

### ADAPTIVE LED HEADLIGHTS

Adaptive LED Headlights automatically adjust to follow steering inputs, casting light where needed. They will angle the beam when indicating, as well as working in conjunction with Automatic High Beam Assist to prevent your lights from dazzling oncoming traffic.

### AUDIO EQUALISATION

Audio Equalisation lets you fine tune the sound of your car's audio system by giving you tone adjustment not covered by standard treble, mid-range, and bass controls.

## C

### Cd.

The Cd. value is the drag coefficient of the car. It gives an indication of the vehicle's aerodynamic qualities. The lower the value, the more aerodynamically efficient the vehicle's design.

## D

### DAMPERS/DAMPING

Dampers absorb forces acting on the suspension for greater ride comfort and control. Dampers are also known as shock absorbers.

### DRAG COEFFICIENT

The drag coefficient measures how aerodynamic a car is. See definition of Cd.

### DSP AMPLIFIER

Meridian's Digital Signal Processing (DSP) technology analyses a range of variables that may impact audio quality, then processes them using sophisticated algorithms and adapts the system's output accordingly. This enables a level of powerful, authentic performance impossible with a conventional sound system.

## E

### ECO MODE

Eco Mode encourages fuel efficient driving by reducing throttle sensitivity, selecting more economical engine mapping and, on manual vehicles, advising of gear shifts. It also reduces fuel consumption by reducing the energy demands placed on the engine by climate control and audio systems.

## J

### JAGUARDRIVE CONTROL

Interacts with the Dynamic Stability Control system, engine and transmission management systems to alter the characteristics of the engine mapping, gear shifts and brakes. It offers different modes designed to optimise the vehicle's response to particular driving conditions and styles.

### 'J' BLADE DAYTIME RUNNING LIGHTS

'J' Blade Daytime Running Lights are separate LED running lights, in a distinctive 'J' shape, built into the headlights. They emphasise Jaguar's striking on road style.

## S

### SUPERCHARGED PETROL

A petrol engine with a supercharger. A supercharger is a forced induction device mechanically driven by the engine. It offers higher power outputs and immediate, linear response at all engine speeds.

## T

### 10.2" MULTI-TOUCHSCREEN WITH MULTI-TOUCH GESTURES

The Multi-touch functionality of Touch Pro's 10.2" Display allows the screen to recognise multiple points of contact. This provides direct control of the system's features in a more natural, intuitive way, enabling gestures such as pinch and zoom.

### TURBOCHARGED DIESEL

Diesel engine with a turbocharger. A turbocharger is a forced induction device powered by exhaust gases. Turbocharging produces higher power outputs, lower emissions levels, and improved efficiency and refinement compared to similar capacity naturally aspirated engines.

## X

### XENON HEADLIGHTS

Bi-function Xenon headlights offer improved illumination and feature LED 'J' Blade Daytime Running Lights for a striking on road style.



#### IMPORTANT NOTICE

Jaguar Land Rover Limited is constantly seeking ways to improve the specification, design and production of its vehicles and alterations take place continually. While every effort is made to produce up-to-date literature, this brochure should not be regarded as an infallible guide to current specifications, nor does it constitute an offer for the sale of any particular vehicle. Distributors and Retailers are not agents of Jaguar Land Rover Limited by any express or implied undertaking or representation. Comparisons are based on manufacturer's own data and testing prior to publication.

#### COLOURS

Print and online colours are representative only.

#### ENVIRONMENTAL INNOVATION AT JAGUAR

Jaguar is committed to reducing dependency on fossil fuels, using fewer natural resources and creating less waste as part of our approach to responsible and sustainable business development, called Environmental Innovation.

Our innovative use of lightweight aluminium (featured in the F-PACE, XF, XE, XJ and F-TYPE) is helping to improve fuel consumption and lower tailpipe CO<sub>2</sub> emissions, as well as delivering other handling and performance benefits to these vehicles.

At the same time, our smart management of resources enables scrap aluminium reclaimed from our stamping process to be segregated and recycled to create the same quality of aluminium sheet with up to 50% recycled content. Compared to using virgin aluminium, this closed-loop recycling system also reduces CO<sub>2</sub> emissions during the manufacturing process.

As a whole, Jaguar Land Rover has reduced its European fleet average tailpipe emissions by 25% versus 2007 and operational CO<sub>2</sub> emissions per vehicle by 30.5%. Our manufacturing facilities are all certified to ISO14001 and we have cut the amount of manufacturing waste to landfill per vehicle by 75%\* and reduced our water consumption per vehicle by 34%\*. (\*versus 2007)

As part of our journey to Carbon Neutral Manufacturing by 2020, we offset 100% of (currently unavoidable) operational CO<sub>2</sub> emissions by investing in projects that reduce the equivalent amount of CO<sub>2</sub> emissions in other ways, providing social and humanitarian benefits at the same time. For example, our award winning Lifestraw 'carbon for water' emissions reduction project has prevented the release of 968,000 tonnes of CO<sub>2</sub> (since it began in 2013) and improved the lives of 2.4 million people in Kenya.

Taking into account the company's global sales growth and increased investment in more efficient operating facilities, we are proud of the progress we have made against our 2020 Environmental Innovation targets to date. Our achievements have also been recognised externally: In 2013 the Company was recognised as the UK's Responsible Business of the Year by leading CR index, Business in the Community and in 2014 we were awarded the Queen's Award for Enterprise in Sustainable Development.

Looking forward, we have developed a 2020 vision for sustainable business growth that focuses on continued improvements in operating & tailpipe CO<sub>2</sub> emissions, carbon neutral manufacturing and zero waste. Jaguar Land Rover also aims to improve the lives of 12 million people by 2020 as part of its global Corporate Social Responsibility programme.

Meridian is the registered trademark of Meridian Audio Ltd.

AdBlue® is the registered trademark of the Verband der Automobilindustrie e. V. (VDA).

The Bluetooth, word mark and logos are owned by the Bluetooth SIG, Inc. and any use of such marks by Jaguar Land Rover Limited is under licence.

iPod, iPod touch and iPad are trademarks of Apple Inc. registered in the US and other countries.

The Navigation system must always be used in conditions that will not affect the driver's ability to drive safely or affect the safety of other road users.

**VEHICLE SHOWN FRONT COVER: F-PACE S IN CAESIUM BLUE WITH OPTIONAL FEATURES FITTED (MARKET DEPENDENT)**

**VEHICLE SHOWN BACK COVER: F-PACE R-SPORT IN FIRENZE RED WITH OPTIONAL FEATURES FITTED (MARKET DEPENDENT)**

Jaguar Land Rover Limited  
Registered Office: Abbey Road, Whitley,  
Coventry, CV3 4LF, United Kingdom  
Registered in England Number: 1672070  
jaguar.com

PRINTER  
TO REPLACE  
FSC LOGO

