

JAGUAR XE



THE ART OF PERFORMANCE





BY APPOINTMENT TO
HM THE QUEEN
MANUFACTURERS OF
MOTOR VEHICLES
JAGUAR LAND ROVER LIMITED
COVENTRY



BY APPOINTMENT TO
HRH THE DUKE OF EDINBURGH
MANUFACTURERS OF
MOTOR VEHICLES
JAGUAR LAND ROVER LIMITED
COVENTRY



BY APPOINTMENT TO
HRH THE PRINCE OF WALES
MANUFACTURERS OF
MOTOR VEHICLES
JAGUAR LAND ROVER LIMITED
COVENTRY



JAGUAR

THE ART OF PERFORMANCE

Every day we push performance to its limit. Our performance. Our cars' performance.
We innovate, we engineer, we design. We master rules and then break them.
Only to push further. Past the limits of convention. This is when performance becomes art.

Jaguar. The Art of Performance.



CONTENTS

INTRODUCTION

The Concept of XE	07
XE - The Facts	08

DESIGN

Exterior Principles	10
Exterior Detail	12
Interior	17

PERFORMANCE

Engines	18
Transmissions	22
Advanced Aerodynamics	24
Lightweight Aluminium Architecture	27
Chassis and Suspension	28

DRIVING TECHNOLOGY

Advanced Driving Dynamics	31
Added Driver Confidence	32
Advanced Drivetrain Technology	35
Torque Vectoring	37
Stability and Control	38
Head-up Display	41

INCONTROL TECHNOLOGIES

Infotainment and Connectivity	42
Touch and Connect	45
Touch Pro and Connect Pro	47
Audio	48

SAFETY AND EFFICIENCY

Advanced Driver Assistance	50
Efficient Technologies	52

PERSONALISATION

XE - Your Choice	54
Choose your Engine	56
Choose your Model	58
Choose your Options	60
Choose your Colour	66
Choose your Wheels	68
Choose your Interior	70
Choose your Jaguar Gear Accessories	88
Technical Specifications	92
Dimensions	94

JAGUAR WORLD

Jaguar Experience	96
The World of Jaguar	98
Glossary and Legal Information	100



Scan to find out more about the Jaguar XE.

VEHICLE SHOWN: XE R-SPORT IN CAESIUM BLUE WITH OPTIONAL FEATURES FITTED (MARKET DEPENDENT)
VEHICLES SHOWN ARE FROM THE JAGUAR GLOBAL RANGE. SPECIFICATIONS, OPTIONS AND AVAILABILITY
WILL VARY BETWEEN MARKETS AND SHOULD BE VERIFIED WITH YOUR LOCAL JAGUAR RETAILER





INTRODUCTION

THE CONCEPT OF XE

XE is the foundation of the Jaguar saloon car family. A distillation of the design, luxury and technology found in XF and XJ. Inspired by our F-TYPE sports car, with its assertive looks and agile drive.

The XE range features an extended engine choice, including the new 2.0 litre 4 cylinder 250PS Turbocharged Ingenium Petrol engine and 2.0 litre 4 cylinder 240PS Twin Turbocharged Ingenium Diesel engine. They both offer effortless performance with low fuel consumption and CO₂ emissions. There's also the 2.0 litre 163PS Turbocharged Ingenium Diesel engine which achieves fuel consumption as low as 3.8 l/km on the combined cycle. Or choose the dynamic uprated 3.0 litre 380PS V6 Supercharged Petrol engine and bring the 0-100Km/h time down to 5.0 seconds.

XE is an exceptional blend of technology, design, and driving dynamics that rewrites all the rules.

VEHICLE SHOWN: XE S IN FIRENZE RED WITH OPTIONAL FEATURES FITTED (MARKET DEPENDENT)

XE - THE FACTS

XE brings together the latest Jaguar innovation, technology and design.

EFFICIENCY AND PERFORMANCE

Find your perfect balance of dynamism and efficiency in XE's range of engines. There are two petrol and three diesel engines from our state-of-the-art Ingenium range. All deliver strong, high-torque performance. The most frugal achieves fuel consumption of up to 3.8 l/100km and CO₂ emissions as low as 99g/km. But if pure power is your preference, then XE S with its uprated 380PS V6 Petrol engine should satisfy: from a standstill it can reach 100km/h in 5.0 seconds.

JAGUAR CARE*

XE is offered with unlimited mileage, three year warranty and three years' standard servicing programme. We call this programme Jaguar Care. It makes XE's overall cost of ownership one of the lowest in its class.



*Selected European Markets only.

VEHICLE SHOWN: XE S IN FIRENZE RED WITH OPTIONAL FEATURES FITTED (MARKET DEPENDENT)

CAPABILITY

XE offers Jaguar's unique All Wheel Drive with Intelligent Driveline Dynamics and Adaptive Surface Response. Available with selected engines, this maximises the legendary Jaguar handling, agility and ride, and gives added confidence in all conditions.

ADDED INTELLIGENCE

Innovative technologies make every drive easier and safer. XE offers adaptive Xenon headlights, Traffic Sign Recognition with Adaptive Speed Limiter, Lane Keep Assist with Driver Condition Monitor, Autonomous Emergency Braking, Adaptive Cruise Control with Queue Assist, Park Assist, and now Blind Spot Assist. With Powered Gesture Boot Lid you can access the boot when your hands are full. Simply present your foot under either rear corner and the boot opens or closes.

ALWAYS CONNECTED

Our most advanced infotainment system ever – InControl Touch Pro – is available in XE. Its next-generation hardware and software enhances every journey through added connectivity, convenience and entertainment. Some of the outstanding features it supports include a Dual View Touchscreen in the centre console, Meridian™ Sound Systems, connected navigation and a new 12.3” full digital instrument panel.



LIGHTWEIGHT ALUMINIUM ARCHITECTURE

XE's lightweight architecture creates an incredibly strong body – underpinning power with responsive handling, and refinement with beautiful design.



DESIGN EXTERIOR PRINCIPLES



DYNAMIC PROPORTIONS

MUSCULAR LOOKS

"It's about paring it down to the bare essentials. Good designers have always said less is more."
Ian Callum, Jaguar Design Director.

XE stands out from the competition with the clean surfaces and dynamic looks that form the core of Jaguar design. This is because XE's Lightweight Aluminium Architecture gave its designers the freedom to work alongside engineers to optimise the car's proportions – XE is unmistakably a Jaguar. The long, distinctly defined bonnet is aerodynamically sculpted to channel air over and around the body for greater efficiency. Along with the rising waistline and 'cab rearward' design, it ensures that XE shares the athleticism of the other cars in the Jaguar range. XE is crouching, ready to pounce.

VEHICLE SHOWN RIGHT: XE S IN FIRENZE RED
WITH OPTIONAL FEATURES FITTED (MARKET DEPENDENT)



EXTERIOR DETAIL

INNOVATIVE DESIGN

One glance at XE and you know that it could only be a Jaguar. From the headlights featuring Jaguar signature 'J' blade Daytime Running Lights*, the powerfully sculpted bonnet, and the chrome side vents, stamped with the Jaguar name, all the way to those distinctive rear haunches. Only Jaguar, as a world leader in aluminium car construction, has the technology and expertise to create sharper creases from deeper, more innovatively formed pressings. The body side curvature of XE is aerodynamically honed to sweep air seamlessly rearwards to the tail. The deliberately cropped rear has a short overhang, underscoring the car's performance credentials and enhancing airflow. It culminates with those iconic tail lights that are inspired by the F-TYPE sports car.

*Available with Bi-function Xenon and Adaptive Bi-function Xenon headlights only.

VEHICLE SHOWN: XE R-SPORT IN CAESIUM BLUE WITH OPTIONAL FEATURES FITTED (MARKET DEPENDENT)





JAGUAR
XDY 446

XE









INTERIOR



COCKPIT FEEL

EXTENSIVE CHOICE

Connect with XE the moment you slide into the form-hugging seats – you sit low in a Jaguar. Next to you the raised centre console adds to the cockpit feel.

Pulsing with a heartbeat, the car creates an emotional connection between driver and machine. Its 72 per minute double beat is the same as a jaguar cat at rest. Press the Start button and XE awakes, the needles sweep, the engine growls. On cars with automatic transmissions, the JaguarDrive Selector rises to greet your hand.

The outer air vents are unique in the way that they extend the fascia to nestle in the door casings and give the feeling of width and space. Throughout XE the natural forms of the interior architecture lend themselves to the extensive choice of contemporary or traditional materials and finishes. XE is an inspired place for driver and passengers to be.

INTERIOR SHOWN LEFT AND PREVIOUS PAGE: XE S FEATURING PIMENTO LEATHER SPORT SEATS WITH EBONY SUEDECLOTH INSERTS WITH OPTIONAL FEATURES FITTED (MARKET DEPENDENT)

PERFORMANCE ENGINES



INGENIUM ENGINES

STOP/START TECHNOLOGY*

Ingenium technology underpins three of the diesel engines in the XE range. These low friction, all-aluminium engines have stiff cylinder blocks and twin balancer shafts to ensure inherently low levels of vibration for smooth day-to-day performance. All engines are equipped with Stop/Start technology* and smart regenerative charging - harvesting kinetic energy from braking to charge the battery - for maximum economy, especially during urban driving. For information on fuel consumption, CO₂ emissions and performance figures for XE's engines, please refer to pages 92 to 93.



INGENIUM DIESEL ENGINES FROM 99g/km CO₂

The **Ingenium 2.0 litre 4 cylinder 163PS Turbocharged Diesel** is refined and highly efficient. Low-flow direct injectors precisely control the amount of fuel that enters the combustion chamber for maximum efficiency. Intelligent, electronically controlled, adaptive engine cooling only engages when required - minimising fuel consumption and CO₂ emissions. This doesn't limit driving pleasure, the engine's strong torque gives good performance from low down in the rev range for brisk acceleration.

The **Ingenium 2.0 litre 4 cylinder 180PS Turbocharged Diesel** offers impressive performance and economy. For an engine of this size it offers high levels of torque, but not at the expense of efficiency - a balance achieved thanks to its variable geometry turbocharger. Adapting to the changing flow of exhaust gases, it maximises low speed torque for broad power and responsiveness that is uniform, progressive and avoids lag.

The **Ingenium 2.0 litre 4 cylinder 240PS Twin Turbocharged Diesel** delivers high power and torque. Its series sequential twin turbocharger uses high and low pressure spools to give continuous acceleration and maximise performance. A higher specific power output is created by building on Ingenium technology. Upgrades include a higher pressure common rail fuel system, increased from 1,800 to 2,200 bar, and an improved fuel injector flow rate.

*Market dependent.

XE offers a choice of petrol engines, including two from our Ingenium range. With their lightweight, all-aluminium design, and widespread use of low-friction roller bearings, Ingenium petrol engines are built for smooth, highly efficient performance. All engines are equipped with Stop/Start technology* and smart regenerative charging - harvesting kinetic energy from braking to charge the battery - for maximum economy, especially during urban driving.



INGENIUM PETROL ENGINES UP TO

0-100km/h in 6.2 seconds

The **Ingenium 2.0 litre 4 cylinder 200PS Turbocharged Petrol** engine offers the drivability of larger engines, but with much lower fuel consumption. Direct fuel injection from centrally mounted solenoid injectors ensures precise delivery of fuel for highly efficient and clean combustion. Intelligent Continuously Variable Valve Lift control manages early or late opening of inlet valves, meaning the engine can adapt its performance to all driving situations. This works with dual independent variable cam timing to optimise power at all speeds.

The **Ingenium 2.0 litre 4 cylinder 250PS Turbocharged Petrol** engine delivers outstanding usable power and torque. For excellent acceleration and effortless overtaking, maximum torque is available between 1,200-4,500 rpm. This engine's twin scroll turbocharger is fed by an integrated exhaust manifold that synchronises exhaust pulses from two separate pairs of cylinders - significantly reducing turbo lag and improving engine response.

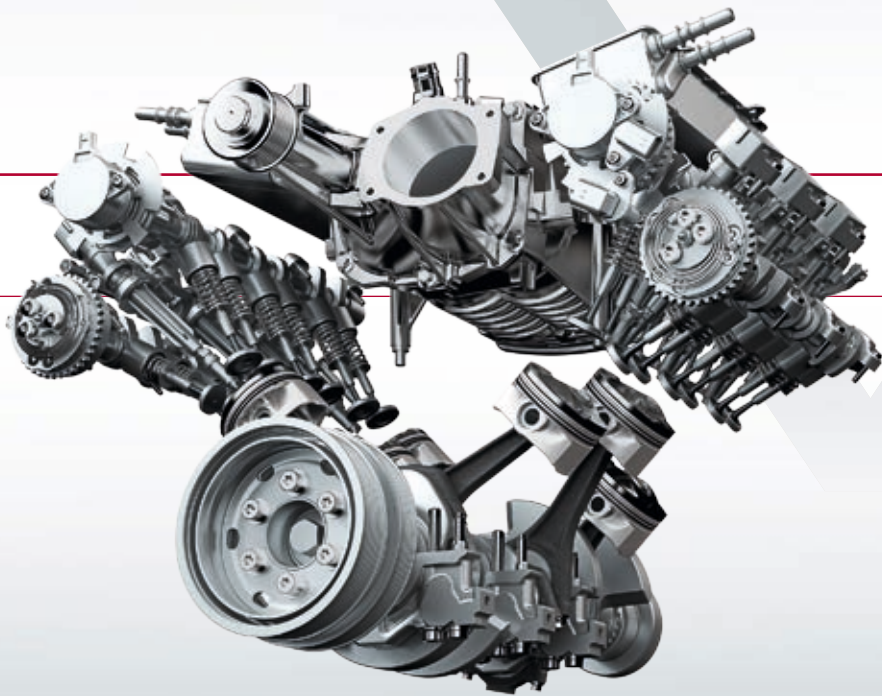

PETROL ENGINE UP TO

0-100km/h in 5.0 seconds

The **3.0 litre V6 380PS Supercharged Petrol** engine features a Roots-type twin vortex supercharger that provides linear delivery of power and maximises responsiveness. This results in performance matching much larger engines, while optimising economy and reducing emissions. The engine also features dual independent variable cam timing to vary inlet and exhaust valve operation, working alongside lightweight pistons with ultra-low friction piston rings, for increased performance and efficiency. For added refinement there is a twin, contra-rotating balancer shaft system.

VEHICLE SHOWN: XE S IN CORRIS GREY WITH OPTIONAL FEATURES FITTED (MARKET DEPENDENT)



AUTOMATIC TRANSMISSION

8-SPEED AUTOMATIC TRANSMISSION

XE's automatic transmission is highly responsive, smooth and efficient. It delivers rapid shifting for effortless acceleration and overtaking. The intelligent, adaptive system subtly changes the way the throttle delivers power, as well as gearshift patterns, to suit each particular driving circumstance. The JaguarDrive Control offers even quicker shifts and sportier kick-down in Dynamic Mode, and earlier up-shifts in Eco Mode. With the automatic transmission the driver can opt to manually control gearshifts, via steering wheel paddles, at the touch of a finger.



MANUAL TRANSMISSION

6-SPEED MANUAL TRANSMISSION

Choose the 6-speed manual gearbox* for even greater driver involvement. This lightweight, highly advanced unit contributes to XE's outstanding efficiency. Its aluminium alloy casing, hollow shafts and pocketed gears save every gram of weight possible. We use an advanced direct lubrication system to reduce friction and drag for greater efficiency and further weight saving. Specifically designed for the performance requirements of sports cars - it delivers slick, short changes and superb levels of comfort.

*Only available on 2.0 litre 4 cylinder 163PS and 2.0 litre 4 cylinder 180PS Turbocharged Ingenium Diesel engines (Market dependent).



ADVANCED AERODYNAMICS



ADVANCED AERODYNAMICS

HIGHLY EFFICIENT

XE's form has been rigorously optimised for aerodynamic efficiency and stability. With a drag co-efficient as low as Cd 0.26, XE cuts through the air - reducing fuel consumption and lowering emissions. Every element exploits the exterior's maximum aerodynamic potential while preserving XE's stunning proportions. Vertical apertures in the front bumper's outer edges channel air through vents in the wheel arches and out over the front wheels. Even the race car-inspired underbody protection and diffuser is designed to make XE as efficient, economical and refined as possible.

VEHICLE SHOWN: XE R-SPORT IN CAESIUM BLUE WITH OPTIONAL FEATURES FITTED (MARKET DEPENDENT)



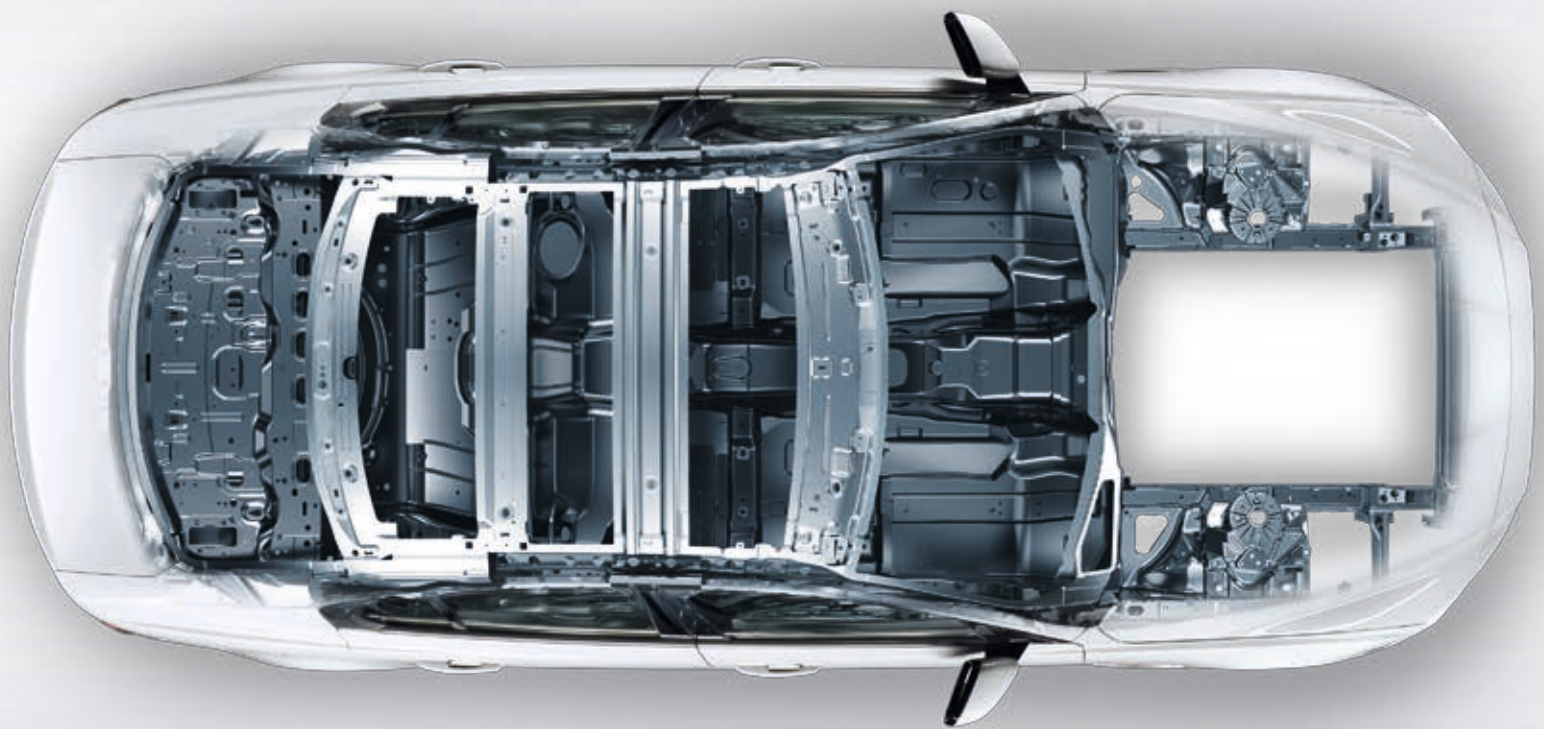

LIGHTWEIGHT ALUMINIUM ARCHITECTURE



PERFECT BALANCE

STRONG AND LIGHTWEIGHT

Jaguar Land Rover has been at the forefront of aluminium car construction for more than a decade and continues to push the boundaries of this technology. As part of our pioneering recycled aluminium project, REALCAR*, we've reclaimed over 50,000 tonnes of aluminium scrap – the weight of 200,000 XE body shells – back into the production process during 2015/16. This has prevented more than the equivalent of 500,000 tonnes of CO₂ from entering the atmosphere.

XE is based on our Lightweight Aluminium Architecture, which uses expertise derived from the aerospace industry to deliver premium vehicle characteristics in performance and refinement. This immensely strong bodyshell uses a high strength 6000 series aluminium alloy. Saving weight without compromising durability, it provides very high torsional stiffness, supporting precise handling. It helps achieve optimum weight distribution approaching 50:50. The lightweight structure not only reduces fuel consumption and CO₂ emissions, it means that the XE range is able to encompass everything from as low as 99g/km to a maximum speed of up to 250km/h.

*The REALCAR research project was a collaboration between Jaguar Land Rover and the following partners: Brunel University, Innovate UK, Innoval Technology, Norton Aluminium, Novelis, Stadco and Zyomax.

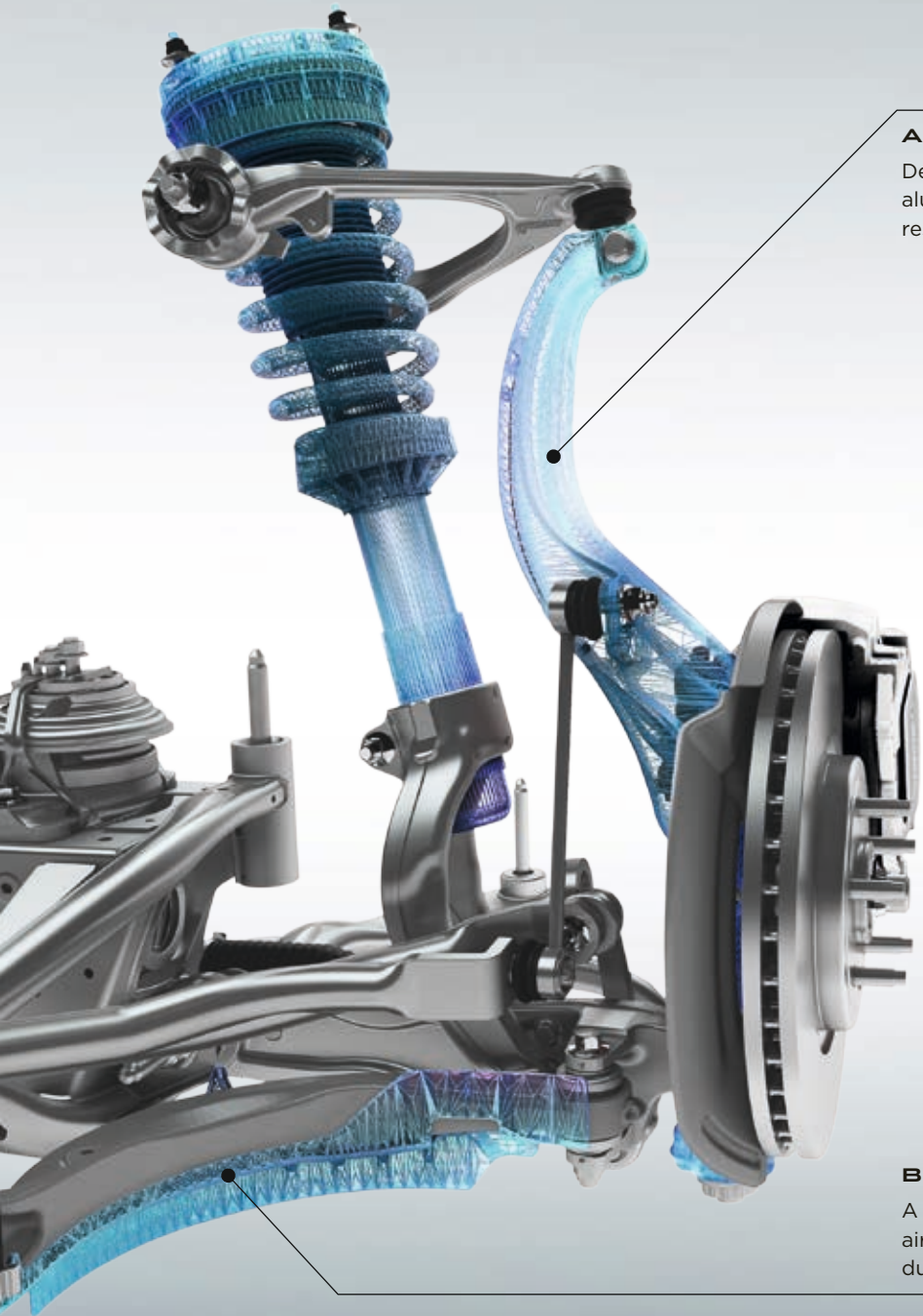

ALUMINIUM FRONT KNUCKLE

Designed to optimum stiffness and strength, the lightweight aluminium front knuckle helps improve XE's agility, responsiveness and refinement for sports car-like control.

CHASSIS AND SUSPENSION

 **UNIQUE SUSPENSION TECHNOLOGY**

COMFORTABLE AND DYNAMIC

XE responds with agility and performs with dynamism while always maintaining ride comfort – it's a unique balance that makes it a Jaguar. The ideal foundation for these driving dynamics is XE's light, yet exceptionally strong and stiff, Lightweight Aluminium Architecture with its near 50:50 weight distribution.

The sophisticated front and rear suspension systems complete a chassis that achieves a superb combination of sportiness and refinement. Advanced damper technologies – both passive and adaptive – improve ride quality still further and extend XE's breadth of dynamic capability. The suspension's control, agility and feedback give XE the spirit of a sports car.

BRAKE SCOOP

A glass-filled polypropylene brake scoop channels air onto the brakes for enhanced brake performance during enthusiastic driving.

INTEGRAL LINK REAR SUSPENSION

Integral Link rear suspension allows XE to realise a perfect combination of a refined, luxurious ride and sharp, responsive handling. The system, the benchmark for this class of car, separates and independently manages the lateral, longitudinal and vertical forces acting on the suspension for enhanced control and comfort. Many components are forged or hollow-cast in aluminium - the optimum production techniques for strong, lightweight suspension.

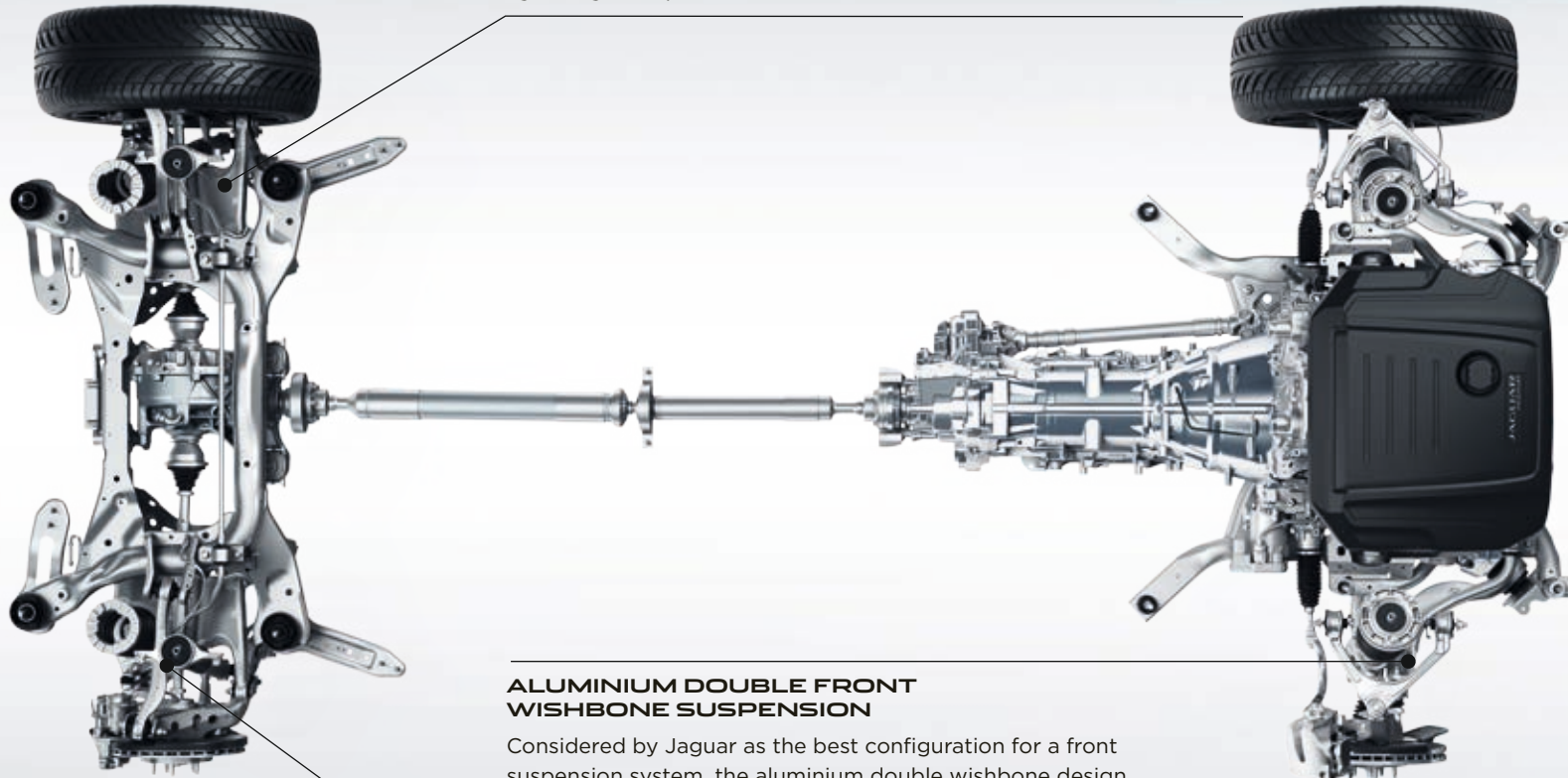

ALUMINIUM DOUBLE FRONT WISHBONE SUSPENSION

Considered by Jaguar as the best configuration for a front suspension system, the aluminium double wishbone design is modelled closely on F-TYPE's for precise handling and steering response.

ADAPTIVE DYNAMICS

The Adaptive Dynamics system delivers both precise dynamics and a supple, luxurious ride by monitoring wheel position and body movements. The system constantly monitors conditions and adjusts the dampers to provide the optimum balance between comfort and refinement at all times.



DRIVING TECHNOLOGY

ADVANCED DRIVING DYNAMICS



MAXIMISING AGILITY

CONTINUOUSLY ADAPTING

Dynamic Mode revises the car's software to further enhance XE's sporting character. It sharpens the throttle response, increases steering weighting and performs gearshifts more quickly* and at higher engine speeds. It also brings visual drama to the driver as the instrument cluster takes on a red glow. Dynamic Mode enhances your connection with XE's inherent Jaguar performance.

ELECTRIC POWER ASSISTED STEERING

Electric Power Assisted Steering (EPAS) offers outstanding feedback, control and it is active on demand - saving power for where you really need it, as well as saving fuel. EPAS' sophisticated computer management varies steering assistance as appropriate - increasing assistance for low speed manoeuvring and improving feel at higher speeds. It also enables advanced safety features such as Lane Keep Assist and Park Assist.

ADAPTIVE DYNAMICS†

Whether you're accelerating on the motorway, cornering on country roads or navigating around town, optional Adaptive Dynamics modifies XE's response to match the conditions and your driving style. It analyses acceleration, cornering, throttle and brake pedal activity, as well as kick-down activation. Steering movement is analysed up to 500 times a second and body movement up to 100 times a second. Using this information, electronically controlled adaptive dampers then constantly adjust to optimise the suspension settings and maintain XE's poise and comfort.

CONFIGURABLE DYNAMICS†

Bringing technology from F-TYPE, the optional Configurable Dynamics* system allows you to set up XE's dynamics for throttle mapping, gearbox shift points and steering to suit your performance driving needs. When optional Adaptive Dynamics is fitted, you can make your setting even more personal by configuring the damper settings.

*Automatic transmission only.

†Standard on XE S, not available on 2.0 litre 4 cylinder 163PS Diesel engine.

ADDED DRIVER CONFIDENCE



ALL SURFACE PROGRESS CONTROL*

ADAPTIVE SURFACE RESPONSE

Unique in this class of car, Jaguar's All Surface Progress Control (ASPC) technology is a low speed cruise control that helps XE to cope with low traction situations. ASPC allows the driver to concentrate on steering the vehicle. Once activated, you use the cruise control buttons to set a 'target' speed of between 3.6km/h and 30km/h. The system then works to achieve and maintain that speed while exerting optimum traction control.

ASPC is standard on all engines fitted with automatic transmissions and gives XE drivers added confidence over slippery, loose or icy surfaces, undulating terrain and even while descending a difficult incline. It helps make XE easy to drive in challenging conditions. ASPC also has a pull-away function allowing XE to progress from rest on low grip surfaces and ascending gradients, as well as a hill descent function that controls vehicle speed on steeper inclines.

On All Wheel Drive vehicles fitted with Adaptive Dynamics**, optional Adaptive Surface Response (AdSR) recognises differences between surfaces to exploit the maximum available grip. Drawing on Jaguar Land Rover's unrivalled expertise with All Wheel Drive systems, AdSR constantly monitors the car's environment and adjusts the appropriate engine and brake settings. Once selected, AdSR works at all speeds to support you in adverse weather and across challenging surfaces.

*Automatic transmission only.

**Standard on XE S, not available on 2.0 litre 4 cylinder 163PS Diesel engine.

With any given set of tyres, ASPC can accomplish comparable levels of traction to that achievable by an expert driver. Fitting All Season or Winter tyres to XE can improve capability on slippery surfaces.



MUD/GRAVEL



WET GRASS



SNOW/ICE



WET ROAD

DRY ROAD CONDITIONS

In normal conditions, torque is distributed to the rear wheels, delivering acclaimed Jaguar agility and handling.

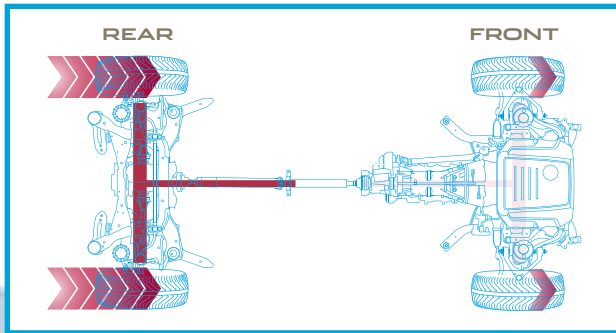

LOW TRACTION CONDITIONS

On slippery surfaces, such as grass and snow, torque can be balanced between the front and rear wheels to maximise traction.

In extreme conditions where only the front wheels have traction, up to 100 percent of engine torque can be distributed to the front wheels for optimum grip.

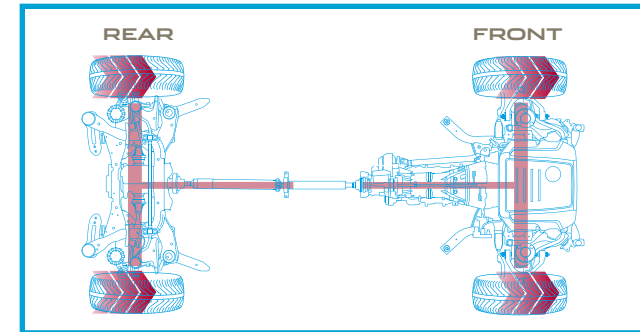

ADVANCED DRIVETRAIN TECHNOLOGY



ALL WHEEL DRIVE

INTELLIGENT DRIVELINE DYNAMICS

XE's All-Wheel Drive (AWD) system combines the agility and character of Rear Wheel Drive (RWD) with the increased security and traction provided by AWD. In normal driving, XE is predominantly RWD to deliver handling purity, feel and balance. But when roads become more challenging, or when you accelerate more keenly on low-grip surfaces, the system subtly channels power forwards enabling XE to maintain optimum traction for comfortable progress in all conditions.

XE's AWD uses a transfer case at the back of the 8-speed Automatic Transmission to manage the appropriate distribution of torque to the front and rear wheels. Engineered to ensure that XE retains the dynamic behaviour of a Jaguar, the transfer case contains an electro-mechanically activated multi-plate clutch with an actuator to build hydraulic pressure. This pressure is quickly and accurately controlled to generate the required force in the clutch to transfer the optimal amount of torque to the front wheels.

Unlike other systems that react to wheel slip, Jaguar's Intelligent Driveline Dynamics (IDD) software is predictive and uses sensors measuring throttle and steering inputs to anticipate wheel slip. IDD seamlessly co-ordinates these inputs and compares them with responses from the engine, transmission and traction control systems to calculate the traction available and distribute torque accordingly even before grip is lost. From a standstill XE can transition from RWD to AWD in as little as 165 milliseconds or just 100 milliseconds when the car is moving.

The result is a drive which blends the character of RWD with the capability of AWD, providing outstanding levels of performance and control whatever the road throws at you.

TORQUE VECTORING APPLIES
BRAKE PRESSURE TO SLOW THE
INSIDE FRONT AND INSIDE REAR
WHEELS INDEPENDENTLY.

POWER IS SUSTAINED
TO MAINTAIN CONSTANT
SPEED OF OUTER WHEELS.

TORQUE VECTORING



TORQUE VECTORING BY BRAKING

XE's Torque Vectoring by braking maximises capability through even the tightest of corners. Torque Vectoring technology provides controlled independent braking on the individual inside front and rear wheels to add to the turning forces acting on the car. In most conditions more braking pressure is applied to the rear inside wheel as this supports the most increased cornering capability, while the front inside wheel is braked for greater effectiveness and refinement. The result is reduced understeer for sharper turning and more consistent road holding. Torque Vectoring delivers increased sports car-like agility and added driver confidence.

ADDITIONAL ROTATIONAL
FORCE APPLIED AROUND
VEHICLE'S AXIS.

VEHICLE SHOWN: XE S IN FIRENZE RED WITH OPTIONAL FEATURES FITTED (MARKET DEPENDENT)

STABILITY AND CONTROL



DYNAMIC STABILITY CONTROL

ENGINE DRAG TORQUE CONTROL

TRAILER STABILITY ASSIST

Jaguar's Stability Systems keep XE safely balanced whether you're driving enthusiastically or simply want the assurance of a car that will remain stable in challenging conditions.

Dynamic Stability Control (DSC) monitors XE's dynamic behaviour, intervening to maximise vehicle stability and optimising available grip. DSC reduces engine torque and applies braking to the appropriate wheels to correct the car's direction of travel by counteracting understeer or oversteer. XE's DSC system has enhanced understeer control to reduce speed and regain control more effectively.

Engine Drag Torque Control (EDC) mitigates the chance of wheel slip caused by strong engine braking in adverse driving conditions. It acts by briefly increasing torque to the wheels as appropriate.

Trailer Stability Assist (TSA) gives you greater stability when towing. Should TSA detect a dangerous trailer sway situation is developing, it can help you regain control by gradually reducing XE's speed through lowering engine power and applying the brakes individually on each side of the vehicle to control the sway.

UNDERSTEER

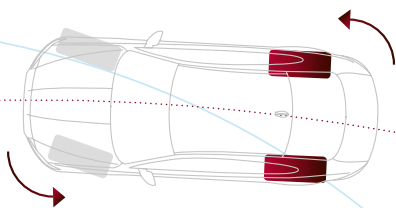
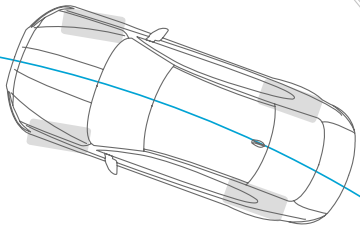
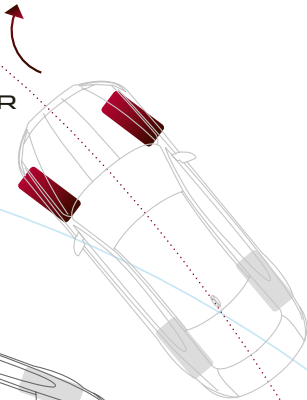

OVERSTEER

BRAKING APPLIED TO APPROPRIATE WHEELS TO COUNTERACT UNDERSTEER/OVERSTEER

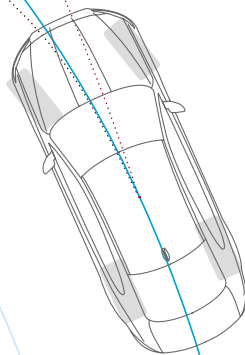

VEHICLE SHOWN: XE S IN FIRENZE RED WITH OPTIONAL FEATURES FITTED (MARKET DEPENDENT)





95
90 km/h
100

Darkness
Oliver Daldry
Darkness
6/12

140 160 180 200 220 240 260 280 300
km/h
90
95 km/h

rpm x 1000
5

17:06

15°C

SET +

HEAD-UP DISPLAY

➤ HEAD-UP DISPLAY WITH LASER TECHNOLOGY

The optional Head-up Display (HUD)* with laser technology projects key information onto the windscreen. Remaining clear even in direct sunlight, the crisp, bright image can display vehicle speed, navigation, cruise control notifications and Traffic Sign Recognition data, where available. This technology helps you minimise time spent looking down at the instrument cluster and can help you maintain continuous awareness of the car's speed.

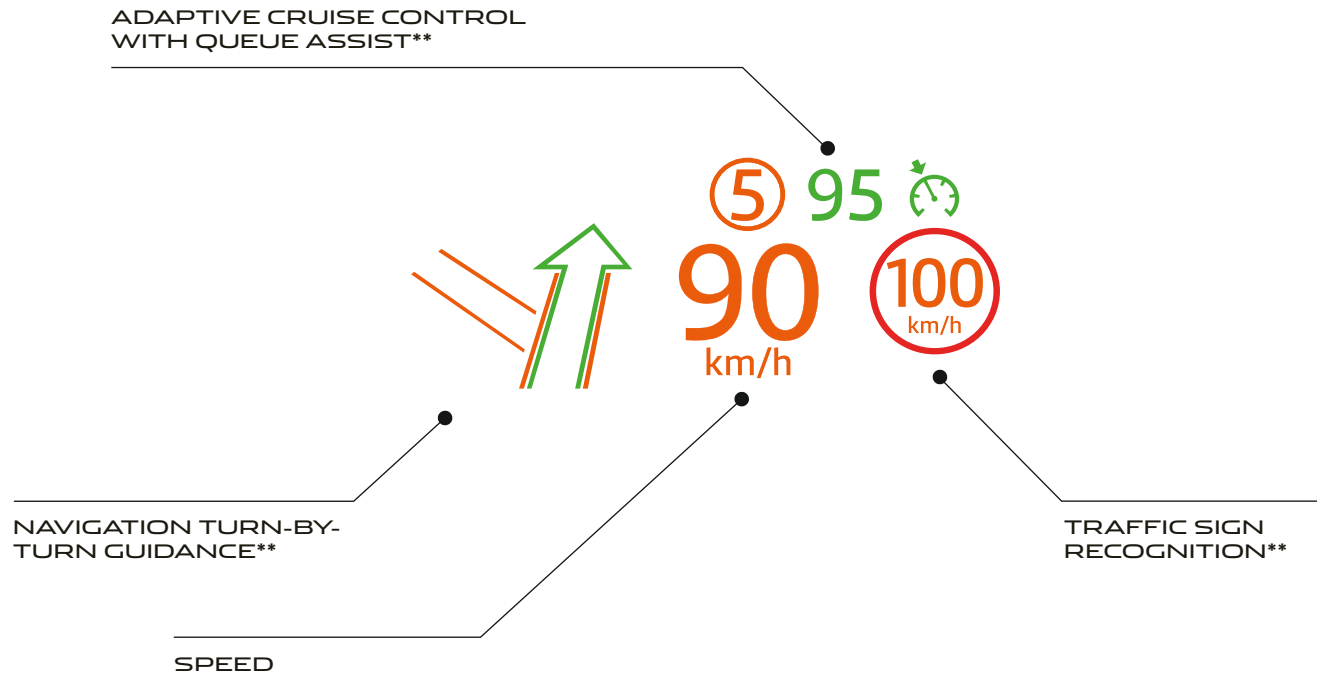

*Requires Infrared Reflective windscreen to be fitted.
**Optional features with fitment market dependent.

INCONTROL TECHNOLOGIES INFOTAINMENT AND CONNECTIVITY



InControl* is our suite of advanced technologies that links both you and your XE to the wider world. Choose from two InControl infotainment systems: Touch, available as standard, or upgrade to Touch Pro. These can be further enhanced by adding their respective connectivity packages, Connect and Connect Pro**.

*As we roll out InControl, specific features described may be optional, and market or powertrain dependent. Please consult your country-specific Jaguar website or local Jaguar Retailer for availability and full terms in your country. Certain features require an appropriate SIM with a suitable data contract which will require further subscription after the initial term advised by your Retailer. Mobile connectivity cannot be guaranteed in all locations.

**In selected markets where Navigation Pro is fitted you must select all the features of Connect Pro. Please consult your local Jaguar Retailer for further details.

†Only available with InControl Apps or Connect Pro (see optional connectivity packages for Touch Pro).

Third Party programmes or applications may require an end user license from the supplier.



TOUCH



STANDARD ON EVERY XE

8" Touchscreen

Instrument Cluster with 5" Central TFT Display

Jaguar Sound System (80W)

AM/FM Radio

USB, Bluetooth® and AUX connections



Protect consists of SOS Emergency Call, Jaguar Optimised Assistance and Remote Essentials smartphone app



OPTIONAL

Connect consists of InControl Apps, Remote Premium smartphone app and Wi-Fi Hotspot



Secure Tracker provides Stolen Vehicle Monitoring and notifications via your smartphone and the secure call centre

ADDITIONAL OPTIONS

Meridian™ Sound System (380W)

Navigation

DAB Radio

InControl Apps



TOUCH PRO



AVAILABLE AS AN UPGRADE

10.2" Touchscreen with multi-touch gestures and customisable homescreen

12.3" Instrument Panel Display with virtual dials and full screen 3D Map View

Navigation Pro

Meridian™ Sound System (380W)

AM/FM Radio, Bluetooth® and 2 x USB connections

10GB of usable memory

CD/DVD Drive



Protect consists of SOS Emergency Call, Jaguar Optimised Assistance and Remote Essentials smartphone app



OPTIONAL

Connect Pro** consists of InControl Apps, Remote Premium smartphone app, Wi-Fi Hotspot and Pro Services including Real Time Traffic information



Secure Tracker provides Stolen Vehicle Monitoring and notifications via your smartphone and the secure call centre

ADDITIONAL OPTIONS

Meridian™ Surround Sound System (825W)

Digital TV, HDMI†, MHL†

DAB Radio

Dual View

InControl Apps



8" TOUCHSCREEN SHOWN AT ACTUAL SIZE

Audio	Standard: Jaguar Sound System (80W) Optional: Meridian™ Sound System (380W)
Navigation Guidance	Navigation*
Display	8" Touchscreen
Multimedia	AM/FM and DAB Radio*. 1 x USB, Bluetooth® and 1 x AUX connection
Standard InControl Package	Protect consists of SOS Emergency Call, Jaguar Optimised Assistance and Remote Essentials smartphone app
Optional Connectivity Package	Connect consists of InControl Apps, Remote Premium smartphone app and Wi-Fi Hotspot

*Optional features.

**Optional feature, availability and fitment is market dependent.

TOUCH



ADVANCED INFOTAINMENT AS STANDARD

The Touch multimedia system is XE's hub for connectivity, control and entertainment. The key features are:

8" Touchscreen at the heart of the centre console. Clear and responsive graphical interface for quick control.

Easy to use Touchscreen responds directly to touch and swipe gestures.

Navigation guidance* makes planning journeys and following routes easy, thanks to turn-by-turn voice guidance and junction view. 'Dead-reckoning' functionality can accurately position the vehicle even when GPS signals can no longer be received – perfect for city centres or driving through tunnels.

Bluetooth phone connectivity allows you to link and control your smartphone via Touch either for phone calls or music playback: simple, easy and wire-free.

Access a world of music thanks to AM/FM, DAB Radio*, as well as USB and AUX connections.

Integrated text-to-voice* technology reduces distraction by reading out incoming text messages. You can easily respond with short, prepared messages.

Precise climate control is available via the Touchscreen. Adjust temperature levels, direction and intensity of airflow and operate heated or cooled seats (if fitted).

CONNECT



OPTIONAL CONNECTIVITY PACKAGE

Connect* is a bundle of technologies and applications that takes your XE's connectivity to the next level.

InControl Apps features a range of bespoke Jaguar approved apps that can be connected to the car from your smartphone. It ensures the safe and convenient use of these apps that have been optimised specifically to enhance aspects of your in-car experience.

Wi-Fi Hotspot gives you the option to create a 3G hotspot using the car's antenna when you fit a SIM card. This strengthens your link to the outside world, for a more stable connection than an individual device could maintain. Connect up to eight devices to read emails, browse the web and download content.

Remote Premium is a multi-function app that allows you to monitor as well as interact with your XE from your smartphone. Remote start the engine** to pre-condition the climate, lock and unlock the car, locate your XE on a map or by using the beep and flash function, and track your journeys – all via the app.



Explore InControl at jaguar.com/incontrol

As we roll out InControl, specific features described may be optional, and market or powertrain dependent. Please consult your country-specific Jaguar website or local Jaguar Retailer for availability and full terms in your country. Certain features require an appropriate SIM with a suitable data contract which will require further subscription after the initial term advised by your Retailer. Mobile connectivity cannot be guaranteed in all locations.



10.2" TOUCHSCREEN SHOWN AT ACTUAL SIZE

Audio	Standard: Meridian™ Sound System (380W) Optional: Meridian™ Surround Sound System (825W)
Navigation Guidance	Navigation Pro
Display	10.2" Touchscreen
Multimedia	AM/FM and DAB Radio*, Dual View*, Bluetooth®, HDMI**, MHL** and 2 x USB connections. Digital TV*, 10GB of usable memory and CD/DVD Drive
Standard InControl Package	Protect consists of SOS Emergency Call, Jaguar Optimised Assistance and Remote Essentials
Optional Connectivity Packages	Connect Pro+ consists of InControl Apps, Remote Premium, Wi-Fi Hotspot and Pro Services (including Route Planner Companion App, share your destination and ETA, Commute Mode, Arrival Mode, Real Time Traffic information and fuel and parking services)



12.3" Full Digital Instrument Panel with virtual dials

*Optional features.

**Only available with InControl Apps or Connect Pro (see optional connectivity packages for Touch Pro).

*In selected markets where Navigation Pro is fitted you must select all the features of Connect Pro. Please consult your local Jaguar Retailer for further details.

TOUCH PRO

UPGRADE TO NEXT GENERATION INFOTAINMENT

Touch Pro's next-generation hardware and software advances XE's connectivity and entertainment to the very highest level. Touch Pro's features replace or enhance those found in Touch. The key aspects of Touch Pro are:

Larger, highly-responsive, 10.2" Touchscreen at the heart of the centre console with customisable homescreen and lightning fast response times. Its interactive side panel makes multi-tasking easy.

Pinpoint touch control allows you to manipulate and interact with information swiftly and seamlessly. The Touchscreen responds in the same manner as a smartphone or tablet computer, providing multi-touch gestures such as pinch to zoom and swipe.

12.3" Instrument Panel Display with Virtual Dials and full screen 3D Map View makes driving even more of a pleasure. It is housed in the instrument display directly in front of the driver. Select full screen 3D Map View or choose one of four graphical themes to suit your personal preference.

Enhanced Navigation with faster response times. One of the many innovative features of Touch Pro's Navigation is that it allows you to set a destination and the system alerts you if you have insufficient fuel for the journey. It then displays filling stations on the part of the route where you may be low on fuel. The system automatically displays parking options.

Personal media storage of 10GB of usable memory for your music and movies. 'Plug and play' using the two USB ports allowing for fast transfer speeds.

Dual View* allows the front passenger and driver to enjoy different media on the same 10.2" Touchscreen. For example, the front passenger can watch a film (listening to the audio with wireless headphones) while the driver views navigation.



Explore InControl at jaguar.com/incontrol

As we roll out InControl, specific features described may be optional, and market or powertrain dependent. Please consult your country-specific Jaguar website or local Jaguar Retailer for availability and full terms in your country. Certain features require an appropriate SIM with a suitable data contract which will require further subscription after the initial term advised by your Retailer. Mobile connectivity cannot be guaranteed in all locations.

CONNECT PRO

OPTIONAL ENHANCED CONNECTIVITY PACKAGE†

Connect Pro's services, technologies and applications give you the very best in connectivity and convenience. It offers all the benefits of Connect (see pg. 45) plus many more features, including:

Route Planner Companion App offers true door-to-door navigation. Pre-plan your destination and route via your Apple or Android smartphone. The app will guide you to your car, where you will find your selected route available on the car's Touchscreen. When you've completed your road journey, the app can guide you by foot or public transport (where supported) to your destination.

Real Time Traffic uses millions of live traffic data feeds to give a highly accurate picture of traffic on the way to your destination, helping you choose the best route. As you progress, the system continues to monitor live traffic conditions, and can automatically reroute you to help avoid congestion.

Share your estimated time of arrival so your selected contact(s) will know exactly when you will arrive, as calculated by the navigation guidance system. If you're running late, the system can then send automatic updates via text or email, without any further action from you.

Commute Mode allows the system to learn your commutes and automatically advises you of the expected journey time based on live and historical traffic movements. The system learns the routes you take for a given destination and then advises which of those is the quickest.

Arrival Mode displays interactive 360° street level imagery of your destination for seamless finishes to journeys. It automatically displays again upon your arrival. You then simply tap the Touchscreen to select a nearby car park, which appears as an updated destination.

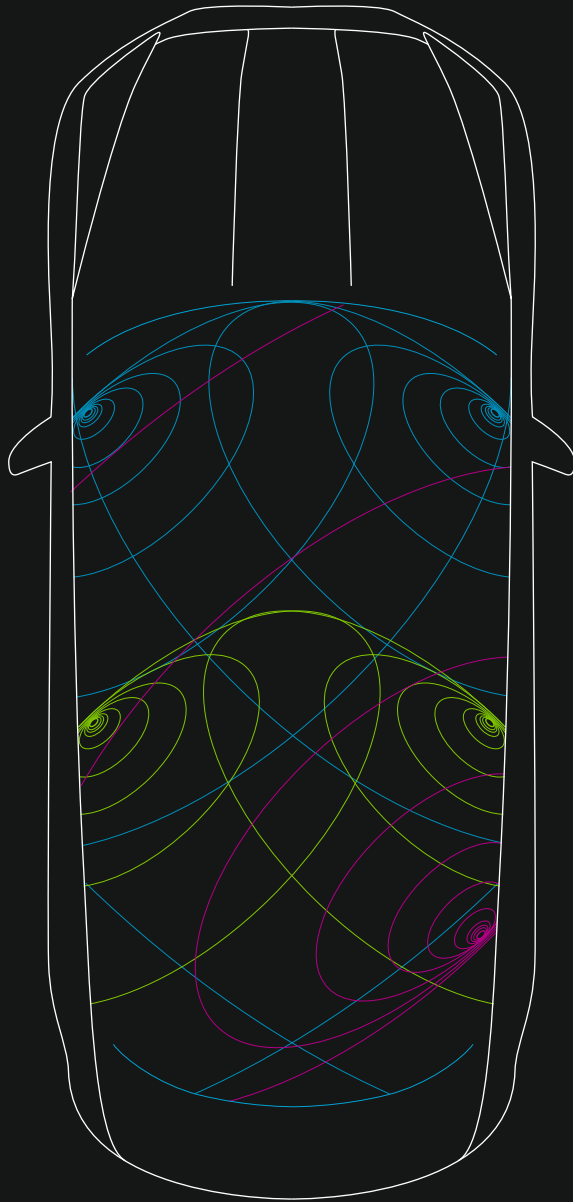

AUDIO

 **JAGUAR
SOUND SYSTEM**

**MERIDIAN™
SOUND SYSTEMS**

XE's superb sound systems bring your music to life. The Jaguar Sound System provides acoustic range through 6 speakers. Offering an enhanced listening experience are the optional Meridian™ Sound Systems. Designed in conjunction with the British audio experts Meridian™, these systems use innovative audio technology and precise speaker placement to give perfectly optimised sound quality.

Choose from a range of audio systems, including the 380W Sound System with 11 speakers or the 825W Surround Sound System with 17 speakers. All systems ensure that, wherever you or your passengers sit in your XE, everyone will enjoy a rich, enveloping audio experience.



-  Fresh air subwoofer
-  Front door waves tweeter midrange bass
-  Rear door waves tweeter midrange

Diagram representative of Meridian™ 380W Sound System.



MERIDIAN

SOUND SYSTEMS AVAILABLE IN CONJUNCTION WITH **TOUCH**

Standard

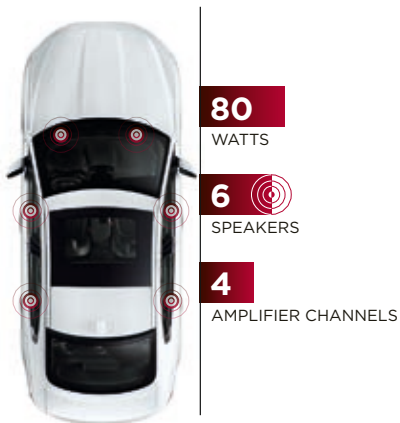

JAGUAR SOUND SYSTEM

Dynamic Volume Control*
80 watts
6 speakers
4 amplifier channels

Optional

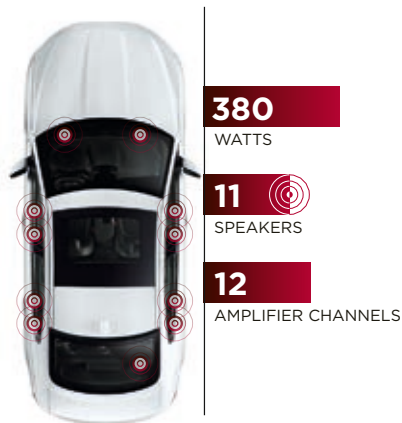

MERIDIAN™ SOUND SYSTEM

Dynamic Volume Control*
380 watts
11 speakers including subwoofer
12 amplifier channels

SOUND SYSTEMS AVAILABLE IN CONJUNCTION WITH **TOUCH PRO**

Standard

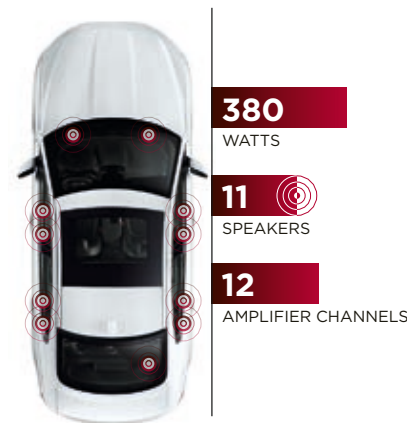

MERIDIAN™ SOUND SYSTEM

Dynamic Volume Control**
380 watts
11 speakers including subwoofer
12 amplifier channels
Advanced DSP with fully digital amplification
Audyssey MultEQ Audio Equalisation

Optional

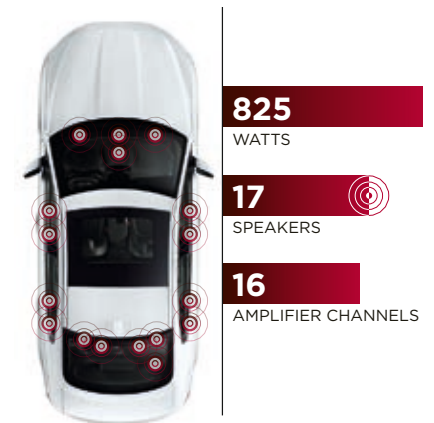

MERIDIAN™ SURROUND SOUND SYSTEM

Dynamic Volume Control**
825 watts
17 speakers including subwoofer
16 amplifier channels
Advanced DSP with fully digital amplification
Audyssey MultEQ Audio Equalisation
Meridian™ Trifield Technology

*Automatically adjusts as vehicle speed changes.

**Automatically adjusts as vehicle speed changes and/or ambient noise levels change.

VEHICLE SHOWN: XE PURE IN YULONG WHITE WITH OPTIONAL FEATURES FITTED (MARKET DEPENDENT)

SAFETY AND EFFICIENCY ADVANCED DRIVER ASSISTANCE



1 AUTONOMOUS EMERGENCY BRAKING*

Should a potential collision be detected, XE gives an audible forward collision warning. Visual warnings follow. If the driver takes no action, the system applies the brakes to help reduce the severity of the possible impact.

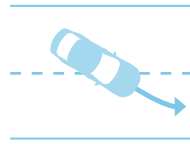

2 LANE DEPARTURE WARNING*

Lane Departure Warning (LDW) notifies the driver with a visual alert and a gentle vibration of the steering wheel should the car detect an unintentional drift from its lane, helping to keep everyone on board safe.



3 LANE KEEP ASSIST AND DRIVER CONDITION MONITOR**

Building on Lane Departure Warning, Lane Keep Assist (LKA) senses unintentional lane drift and helps steer XE back into its lane. Driver Condition Monitor (DCM) detects lapses in concentration due to tiredness by monitoring driver inputs and suggests taking a break via an audible alert and a visual notification in the instrument cluster.



4 TRAFFIC SIGN RECOGNITION AND ADAPTIVE SPEED LIMITER**

Traffic Sign Recognition technology detects speed limits, including variable limits, and no overtaking signs via the forward-facing camera, then displays them to the driver. The Adaptive Speed Limiter uses detected traffic sign information to help keep XE within the appropriate speed limit. Where no traffic sign is detected, the Adaptive Speed Limiter can also use the map data from the optional navigation system.

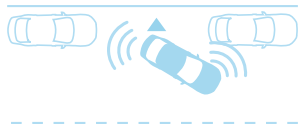

5 PARK ASSIST**

Park Assist makes parking in tight spaces easier than ever. XE can accurately steer itself during both parallel and bay parking manoeuvres – the driver only has to control the brakes and accelerator. An exit-assist function can help guide XE while leaving a parallel space.



6 BLIND SPOT ASSIST AND REVERSE TRAFFIC DETECTION**

If your car detects another vehicle in or quickly approaching your blind spot, the Blind Spot Monitor system alerts you via a small warning light in the corresponding exterior mirror. As an enhancement to this, Blind Spot Assist will apply steering torque to guide you away from the vehicle in your blind spot if you begin to change lanes. Using the same radar system, Reverse Traffic Detection alerts you via the Touchscreen of moving vehicles during reversing – for example, when leaving a parking bay with restricted vision.

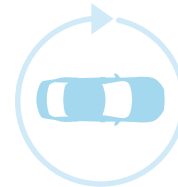

7 SURROUND CAMERA SYSTEM**

Helping with various manoeuvres, from parking by a kerb to getting in and out of tight spaces and junctions, Surround Camera System gives you 360° exterior vision on the Touchscreen. To enhance this system further, new Forward Vehicle Guidance and Forward Traffic Detection are also available. Forming part of the Surround Camera System, Forward Vehicle Guidance provides the driver with an on-screen visualisation of the vehicle and parking distance. Forward Traffic Detection helps avoid potential collisions in situations where forward manoeuvres involve restricted views.

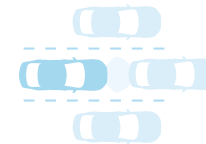

8 ADAPTIVE CRUISE CONTROL WITH QUEUE ASSIST**

Adaptive Cruise Control¹ uses radar technology to automatically adjust your speed to maintain a safe distance from the vehicle ahead. If that vehicle slows, your XE reduces its speed to maintain a safe distance. XE resumes its pre-set speed as soon as the road in front is clear. Should the car in front stop completely, the Queue Assist function brings XE to a smooth halt. Once the traffic moves off, touch the accelerator and XE will follow the car in front again.

*Standard feature.

**Optional features, availability and fitment is market dependent.

¹Only available on automatic transmission.

Please refer to page 64 for fitment requirements.

VEHICLE SHOWN: XE PURE IN YULONG WHITE WITH OPTIONAL FEATURES FITTED (MARKET DEPENDENT)

EFFICIENT TECHNOLOGIES



LOW FRICTION

CLEAN TECHNOLOGIES

Everyone wants to do more with less. That is why XE uses a range of technologies to reduce fuel consumption and CO₂ emissions, all while staying true to Jaguar's dynamic nature.



E-PERFORMANCE

The 2.0 litre 4 cylinder 163PS turbocharged diesel makes use of Jaguar's highly refined and efficient Ingenium powertrain and has aerodynamic additions to the front and underbody areas. It also uses Ultra Low Rolling Resistance tyres to reduce drag between road and tyre as well as lightweight alloy wheels designed for optimised weight. This allows XE to reduce CO₂ emissions to as low as 99g/km.



STOP/START

All XE's engines are available with Stop/Start**. It shuts down the engine when you come to a complete halt and restarts the engine immediately when required to help save fuel, especially during urban driving.

*Available only on E-Performance models. This is market dependent.
**This is market dependent.



17" ALLOY WHEELS

XE is available with both a lightweight and aerodynamic wheel*, with Ultra Low Rolling Resistance tyres to maximise efficiency without loss of Jaguar's legendary comfort.



ADVANCED AERODYNAMICS

XE can offer an incredibly low drag co-efficient of Cd 0.26. This helps XE cut through the air with ease, meaning less work for the engine and therefore reduced fuel consumption and emissions.

AdBlue®

ADBLUE®**

XE's diesel models are fitted with AdBlue® to help clean exhaust gases. AdBlue® is a non-toxic, non-flammable, biodegradable additive that cleanses the gases in the car's exhaust system to remove harmful nitrogen oxide emissions.



LOW FRICTION TECHNOLOGIES

Technologies such as smart coatings on XE's pistons and needle roller bearings in the Ingenium engine range help to reduce friction, particularly at low engine temperatures. This helps the car perform at its efficient best.

PERSONALISATION XE - YOUR CHOICE

 Configure your vehicle at jaguar.com



CHOOSE YOUR ENGINE

Page 56

Select one of XE's powerful, efficient petrol or diesel engines to suit your driving style.

CHOOSE YOUR MODEL & OPTIONS

Page 58

Compare the wealth of standard features and options on XE models.

CHOOSE YOUR COLOUR

Page 66

Express your individuality with one of XE's stunning exterior colours.

CHOOSE YOUR WHEELS

Page 68

Add the personal finishing touch to your new XE, and complement its stunning style, with a set of beautifully designed alloy wheels.

CHOOSE YOUR INTERIOR

Page 70

There's a wide selection of premium materials, leathers, veneers and finishes for every personal taste.

CHOOSE YOUR JAGUAR GEAR ACCESSORIES

Page 88

Really make it yours by adding style, practicality and versatility with official XE Gear Accessories from your local Jaguar Retailer.

1 CHOOSE YOUR ENGINE

 Configure your vehicle at jaguar.com

> DIESEL ENGINES

2.0 LITRE

4 CYLINDER TURBOCHARGED
E-PERFORMANCE

MAXIMUM POWER 163PS
MAXIMUM TORQUE 380Nm
ACCELERATION 0-100 km/h Manual RWD 8.4 seconds / Automatic RWD 8.2 seconds
TOP SPEED Manual RWD 227 km/h / Automatic RWD 227 km/h
COMBINED FUEL CONSUMPTION Manual RWD 3.8 l/100km / Automatic RWD 4.1 l/100km
COMBINED CO ₂ Manual RWD 99 g/km / Automatic RWD 106 g/km
PURE, PRESTIGE, PORTFOLIO, R-SPORT



MANUAL RWD
0-100 KM/H



AUTOMATIC RWD
0-100 KM/H



MANUAL RWD
TOP SPEED KM/H



AUTOMATIC RWD
TOP SPEED KM/H

2.0 LITRE

4 CYLINDER TURBOCHARGED

MAXIMUM POWER 180PS
MAXIMUM TORQUE 430Nm
ACCELERATION 0-100 km/h Manual RWD 7.8 seconds / Automatic RWD 7.8 seconds / Automatic AWD 7.9 seconds
TOP SPEED Manual RWD 231 km/h Automatic RWD 228 km/h / Automatic AWD 225 km/h
COMBINED FUEL CONSUMPTION RWD 4.2 l/100km / AWD 4.7 l/100km
COMBINED CO ₂ Manual RWD 109 g/km / Automatic RWD 109-111 g/km / Automatic AWD 123 g/km
PURE, PRESTIGE, PORTFOLIO, R-SPORT



MANUAL RWD
0-100 KM/H



AUTOMATIC RWD
0-100 KM/H



AUTOMATIC AWD
0-100 KM/H



MANUAL RWD
TOP SPEED KM/H



AUTOMATIC RWD
TOP SPEED KM/H



AUTOMATIC AWD
TOP SPEED KM/H

2.0 LITRE

4 CYLINDER TWIN TURBOCHARGED

MAXIMUM POWER 240PS
MAXIMUM TORQUE 500Nm
ACCELERATION Automatic AWD 0-100 km/h 6.1 seconds
TOP SPEED Automatic AWD 250 km/h
COMBINED FUEL CONSUMPTION Automatic AWD 5.2 l/100km
COMBINED CO ₂ Automatic AWD 137 g/km
PURE, PRESTIGE, PORTFOLIO, R-SPORT



AUTOMATIC AWD
0-100 KM/H



AUTOMATIC AWD
TOP SPEED KM/H

Please refer to Technical Specification pages for full fuel consumption figures.
The figures provided are as a result of official manufacturer's tests in accordance with EU legislation.
A vehicle's actual fuel consumption may differ from that achieved in such tests and these figures are for comparative purposes only.

> PETROL ENGINES

2.0 LITRE

4 CYLINDER TURBOCHARGED

MAXIMUM POWER 200PS

MAXIMUM TORQUE 320Nm

ACCELERATION Automatic RWD 0-100 km/h 7.1 seconds

TOP SPEED Automatic RWD 238 km/h

COMBINED FUEL CONSUMPTION
Automatic RWD 6.3 l/100km

COMBINED CO₂ Automatic RWD 144 g/km

PURE, PRESTIGE, PORTFOLIO, R-SPORT



AUTOMATIC RWD
0-100 KM/H



AUTOMATIC RWD
TOP SPEED KM/H

2.0 LITRE

4 CYLINDER TURBOCHARGED

MAXIMUM POWER 250PS

MAXIMUM TORQUE 365Nm

ACCELERATION RWD 6.3 seconds / AWD 6.2 seconds

TOP SPEED RWD 250 km/h / AWD 250 km/h

COMBINED FUEL CONSUMPTION
RWD 6.3 l/100km / AWD 6.8 l/100km

COMBINED CO₂ RWD 144 g/km / AWD 154 g/km

PURE, PRESTIGE, PORTFOLIO, R-SPORT



AUTOMATIC RWD
0-100 KM/H



AUTOMATIC AWD
0-100 KM/H



AUTOMATIC RWD
TOP SPEED KM/H



AUTOMATIC AWD
TOP SPEED KM/H

3.0 LITRE V6

SUPERCHARGED

MAXIMUM POWER 380PS

MAXIMUM TORQUE 450Nm

ACCELERATION Automatic RWD 0-100 km/h 5.0 seconds

TOP SPEED Automatic RWD 250 km/h

COMBINED FUEL CONSUMPTION
Automatic RWD 8.1 l/100km

COMBINED CO₂ Automatic RWD 194 g/km

S



AUTOMATIC RWD
0-100 KM/H



AUTOMATIC RWD
TOP SPEED KM/H

2 CHOOSE YOUR MODEL

 Configure your vehicle at jaguar.com

LUXURY



PURE

KEY FEATURES

- 17" Alloy Wheels
- Premium Fabric seats (8-way manual)
- Gloss Black trim finishers
- Soft Grain Leather Steering Wheel
- All Surface Progress Control (Automatic Transmission only)
- Cruise Control and Speed Limiter
- Halogen Headlights with Daytime Running Lights
- Heated door mirrors
- Treadplates with Jaguar script
- Black radiator grille with Chrome surround



PRESTIGE

KEY FEATURES (IN ADDITION TO PURE)

- Grained Leather seats
- Rear armrest with twin cupholders
- Dark Satin Brushed Aluminium trim finisher
- Soft Grain Leather Sport Steering Wheel
- Metal treadplates with Jaguar script



PORTFOLIO

KEY FEATURES (IN ADDITION TO PRESTIGE)

- 18" 6 Spoke 'Style 6006' Alloy Wheels
- Perforated Windsor Leather seats (10-way electric)
- Embossed Aluminium trim finisher
- Bi-function Xenon headlights
- Headlight Powerwash
- Black radiator grille with Chrome surround

Images feature optional equipment. Please note that standard features may be replaced when selecting alternative trim levels. Standard features may also vary depending on country of purchase, engine variant and transmission, please refer to Specification and Price Guide or website for your local market.

> SPORT



R-SPORT

KEY FEATURES (IN ADDITION TO PRESTIGE)

- 18" 5 Spoke 'Style 5030' Alloy Wheels
- Luxtec and Technical Mesh Sport seats (8-way manual)
- R-Sport Branded Soft Grain Leather Steering Wheel
- Black radiator grille with Satin Chrome surround
- Etched Aluminium trim finishers
- R-Sport body kit - R-Sport front bumper, Body-coloured extended side sills, Satin Chrome side power vents with R-Sport Badge and Boot Lid Spoiler
- Metal treadplates with R-Sport branding
- Sports suspension



S

KEY FEATURES (IN ADDITION TO R-SPORT)

- 18" 5 Split-Spoke 'Style 5029' Alloy Wheels
- Grained Leather and Suedecloth Sport seats (10-way electric)
- S Branded Soft Grain Leather Steering Wheel
- Black radiator grille with Satin Chrome surround
- Meshed Aluminium trim finisher
- S body kit - S front bumper, S Body-coloured and Gloss Black extended side sills, S Gloss Black rear valance and Boot Lid Spoiler
- Red brake calipers
- Bi-function Xenon headlights
- Metal treadplates with S branding
- Bright Sport pedals
- Adaptive Dynamics

2 CHOOSE YOUR OPTIONS

 Configure your vehicle at jaguar.com

KEY STANDARD FEATURES	PURE	PRESTIGE	PORTFOLIO	R-SPORT	S	DESCRIPTION
	Cruise Control and Speed Limiter	●	●	●	●	
Electric Power Assisted Steering (EPAS)	●	●	●	●	●	
Stop/Start*	●	●	●	●	●	Refer to page 52
JaguarDrive Control with Eco, Dynamic, Normal and Rain Ice Snow Mode	●	●	●	●	●	Refer to page 22
Torque Vectoring	●	●	●	●	●	Refer to page 37
Dynamic Stability Control and Traction Control	●	●	●	●	●	Refer to page 38
Hill Launch Assist	●	●	●	●	●	Prevents your XE from rolling backwards when pulling away on an incline, helping you to make the perfect hill start every time
Heated rear windscreen	●	●	●	●	●	
Heated door mirrors	●	●	●	●	●	
Partial LED tail lights	●	●	●	●	●	
Jaguar Smart Key System – Keyless Start	●	●	●	●	●	
Power operated child locks	●	●	●	●	●	
ISOFIX anchor points for rear child seats	●	●	●	●	●	
Two-zone Climate Control	●	●	●	●	●	
Airbags	●	●	●	●	●	Driver and front passenger with seat occupant detector for passenger, front side and full length side window curtain
Autonomous Emergency Braking (requires Lane Departure Warning or Lane Keep Assist and Driver Condition Monitor)*	●	●	●	●	●	Refer to page 50
Lane Departure Warning*	●	●	●	●	●	Refer to page 50
Front and rear electric windows with one-touch open/close and anti-trap	●	●	●	●	●	
Electric Parking Brake with drive-away release	●	●	●	●	●	Automatically releases the parking brake without the need for driver input as you press the accelerator to drive away
Emergency Brake Assist	●	●	●	●	●	Increases braking pressure in an emergency situation
Hazard lights under heavy braking	●	●	●	●	●	
Brake pad wear indicator	●	●	●	●	●	
USB, Auxiliary socket and iPod® connectivity	●	●	●	●	●	Refer to page 43
Bluetooth® telephone connectivity	●	●	●	●	●	Refer to page 45
Bluetooth® streaming	●	●	●	●	●	Refer to page 45

*Market dependent.

● Standard ○ Option — Not available ■ Option as part of Pack

Please consult your local Jaguar Retailer for details.

For a complete list of optional features and packs refer to the XE Specification and Price Guide or configure your vehicle at jaguar.com

KEY OPTIONAL FEATURES

		PURE	PRESTIGE	PORTFOLIO	R-SPORT	S		
DYNAMIC FEATURES		CODE					DESCRIPTION	
6-Speed manual transmission with Optimal Shift Indicator (only available on 2.0 litre 4 cylinder Diesel engines)		●	●	●	●	—	Refer to page 23	
8-Speed automatic transmission with Jaguar Sequential Shift, gear shift change paddles and All Surface Progress Control		○	○	○	○	●	Refer to page 22	
Adaptive Dynamics (not available on 163PS engines. Includes Configurable Dynamics on automatic transmission)	C35A	○	○	○	○	●	Refer to page 31	
Configurable Dynamics (not available with 2.0 litre 4 cylinder 163PS Diesel engine or manual transmission)	G75A	○	○	○	○	●	Refer to page 31	
Adaptive Cruise Control with Queue Assist (requires automatic transmission)	H41F	○	○	○	○	○		
Adaptive Surface Response (requires AWD, automatic transmission and Adaptive Dynamics)	B73G	—	○	○	○	○	Refer to page 35	
350mm Front Brakes (optional only on 2.0 litre 4 cylinder 240PS Diesel and 2.0 litre 4 cylinder 250PS Petrol engines. Standard on V6 engines)		○	○	○	○	●		

EXTERIOR FEATURES AND FINISHERS

EXTERIOR FEATURES AND TRIM							
Sliding Panoramic roof	F45C	○	○	○	○	○	
Powered Boot Lid	B69B	○	○	○	○	○	
Powered Gesture Boot Lid (requires Keyless entry and Rear Park Aid)	B69C	■	■	■	■	■	Part of Power Convenience Pack
Black radiator grille with Chrome surround		●	●	●	—	—	
Black radiator grille with Satin Chrome surround		—	—	—	●	●	
Chrome radiator grille with Chrome surround	G12V	—	—	○	—	—	
Gloss Black radiator grille with Gloss Black surround	G12T	—	■	■	■	■	Part of Black Pack
Chrome side window surround with Black waist finisher		●	—	—	—	—	
Chrome side window surround	D53C	—	●	●	○	○	
Gloss Black side window surround	D53B	—	■	■	●	●	Part of Black Pack
R-Sport body kit		—	—	—	●	—	Includes R-Sport front bumper, body coloured extended side sills and boot lid mounted spoiler, Satin Chrome side power vents with R-Sport badge
S body kit		—	—	—	—	●	Includes S front bumper, Gloss Black extended side sills and rear valence, body coloured boot lid mounted spoiler, Satin Chrome side power vents
Red Brake Calipers with 'Jaguar' script		—	—	—	—	●	
Delete Powertrain badging	B05H	○	○	○	○	—	Removes engine badging

2 CHOOSE YOUR OPTIONS

 Configure your vehicle at jaguar.com

EXTERIOR FEATURES AND FINISHERS CONTINUED

		PURE	PRESTIGE	PORTFOLIO	R-SPORT	S	
GLASS AND EXTERIOR MIRRORS							DESCRIPTION
Power Fold, Auto-Dimming, Heated door mirrors with Approach Lights (requires Interior auto-dimming mirror)	B28P	○	○	○	○	○	
Infrared Reflective windscreen (front screen only)	D97B	○	○	○	○	○	This windscreen reflects infrared rays, keeping XE's interior cooler
Heated front windscreen with heated washer jets	D96A	○	○	○	○	○	
Rain sensing windscreen wipers (includes Automatic light sensing headlights)	D42R	○	○	○	○	●	
Privacy glass	H75A	○	○	○	○	○	
HEADLIGHTS AND LIGHTING							
Halogen headlights with Daytime Running Lights	D90V	●	●	—	●	—	
Bi-function Xenon headlights with LED 'J' blade Daytime Running Lights (includes Headlight Powerwash)	D90L	○	○	●	○	●	
Adaptive Bi-function Xenon headlights with LED 'J' blade Daytime Running Lights (includes Headlight Powerwash and Auto High Beam Assist) (requires rain sensing windscreen wipers)	D90K	■	■	■	■	■	Part of Lighting Pack
TOWING							
Detachable tow bar	C05C	○	○	○	○	—	
Electrically deployable tow bar	C05B	○	○	○	○	—	
EXTERIOR COLOURS							(Please see pages 66-67 for full colour palette)
Solid paint		●	●	●	●	●	Refer to page 66
Metallic paint		○	○	○	○	○	Refer to page 66-67
Premium paint		○	○	○	○	○	Refer to page 67
WHEELS							
Tyre Pressure Monitoring System		●	●	●	●	●	
Jaguar Tyre Repair System		●	●	●	●	●	
Space saver spare wheel (18") (replaces Jaguar Tyre Repair System)	C40D	○	○	○	○	○	

● Standard ○ Option — Not available ■ Option as part of Pack

Please consult your local Jaguar Retailer for details.

For a complete list of optional features and packs refer to the XE Specification and Price Guide or configure your vehicle at jaguar.com

SEATING AND VENEERS

SEATING	CODE	PURE	PRESTIGE	PORTFOLIO	R-SPORT	S	DESCRIPTION
Heated front seats	F53A	○	○	○	○	○	
Heated front and rear seats	F53B	—	○	○	○	○	
Climate front seats with heated rear seats (requires perforated leather, electric with lumbar seats)	F53C	—	○	○	○	○	Heated and cooled front seats with heated rear seats
8-Way manual front seat with electric recline	H53M	●	●	—	●	—	
10-Way electric front seats with manual headrest height	H53J	○	○	●	○	●	
4-Way electric lumbar adjust (only available with 10-way seats)	F52A	○	○	○	○	○	
18-Way electric front seats	H53K	—	—	○	○	○	
Driver Memory (requires electric seats)	H44N	■	■	■	■	■	Adjusts driver seat, mirrors and steering column
Rear armrest with twin cupholders	H51A	○	●	●	●	●	
40:20:40 split fold rear seat with rear armrest	H48W	○	○	○	○	○	

VENEERS

Please see pages 86-87 for full range of veneers

HEADLINING AND INTERIOR FEATURES

HEADLINING						
Light Oyster headlining	HAMT	●	●	●	○	○
Ebony headlining	HPDB	○	○	○	●	●

INTERIOR FEATURES					
Treadplates with Jaguar script	F28C	●	—	—	—
Metal treadplates with Jaguar script	F28E	—	●	●	—
Metal treadplates with R-Sport branding	F28N	—	—	—	●
Metal treadplates with S branding	F28S	—	—	—	●
Illuminated metal treadplates with Jaguar script	F28F	—	○	○	○
Carpet mats	H69H	○	●	—	●
Premium carpet mats	H69K	○	○	●	○

2 CHOOSE YOUR OPTIONS

 Configure your vehicle at jaguar.com

HEADLINING AND INTERIOR FEATURES CONTINUED

		PURE	PRESTIGE	PORTFOLIO	R-SPORT	S	
INTERIOR FEATURES [CONTINUED]		CODE					DESCRIPTION
Bright Sport pedals	G48S	—	—	—	○	●	
Soft Grain steering wheel	F96J	●	—	—	—	—	
Soft Grain leather sport steering wheel	F95U	—	●	●	—	—	
R-Sport Branded Soft Grain leather steering wheel	F96G	—	—	—	●	—	
S Branded Soft Grain leather steering wheel	F95T	—	—	—	—	●	
Heated steering wheel	F97A	○	○	○	○	○	
Electrically adjustable steering column	D07J	■	■	■	■	■	
Auto-Dimming interior rear view mirror	B68B	○	○	○	○	●	
Cabin Pre-Heat via remote	H10F	○	○	○	○	○	
Air Quality Sensor	C89A	○	○	○	○	○	
Electric rear window sunblind	H76G	○	○	○	○	○	
Interior Mood Lighting	B65A	○	●	●	●	●	
Configurable Interior Mood Lighting with ten colours	B65B	—	○	○	○	○	
Smoker's Pack	A03B	○	○	○	○	○	Includes single ashtray and single cigar lighter
Two additional power sockets	D72B	○	○	○	○	○	Additional 12V power socket in rear centre console and boot
SAFETY AND SECURITY							
Rear Parking Aid	C11A	○	○	○	○	○	
Front Parking Aid (requires Rear Parking Aid)	C13A	○	○	○	○	○	
Rear View Camera (requires Front and Rear Parking Aids)	C14A	○	○	○	○	○	
Surround Camera System (requires power fold mirrors)	C14D	■	■	■	■	■	Refer to page 50
Park Assist (requires Front and Rear Parking Aids)	C18B	■	■	■	■	■	Refer to page 50
360° Parking Aid (requires Front and Rear Parking Aids)	C17A	■	■	■	■	■	
Trailer Stability Assist		●	●	●	●	—	Intervenes when the system detects sway or potentially dangerous movement to bring the trailer back under control
Garage door opener (HomeLink®, requires Auto-dimming Interior Rear View Mirror)	B39N	○	○	○	○	○	
Lane Keep Assist and Driver Condition Monitor	H72D	○	○	○	○	○	Refer to page 50
Blind Spot Monitor and Reverse Traffic Detection (requires power fold mirrors and Rear Parking Aid)	H71C	○	○	○	○	○	Refer to page 50
Blind Spot Assist (requires power fold mirrors and Rear Parking Aid)	H71D	○	○	○	○	○	
Traffic Sign Recognition and Adaptive Speed Limiter (requires Navigation)	A41B	○	○	○	○	○	Refer to page 50
Keyless Entry	F04B	○	○	○	○	○	
Remote control central locking with deadlocks and drive-away locking		●	●	●	●	●	

● Standard ○ Option — Not available ■ Option as part of Pack

Please consult your local Jaguar Retailer for details.

For a complete list of optional features and packs refer to the XE Specification and Price Guide or configure your vehicle at jaguar.com

INCONTROL INFOTAINMENT AND CONNECTIVITY

		PURE	PRESTIGE	PORTFOLIO	R-SPORT	S	
FEATURES ONLY AVAILABLE WITH TOUCH							
8" Touchscreen		●	●	●	●	●	Refer to page 46
5" Instrument Display with analogue dials		●	●	●	●	●	
Jaguar Sound System (80W)	B43T	●	●	●	●	●	
Meridian™ Sound System (380W)	B44V	○	○	○	○	○	
Navigation	Z58X	■	■	■	■	■	Pack consists of Navigation, Voice Control, Traffic Sign Recognition and Adaptive Speed Limiter
Connect Pack	Z77F	○	○	○	○	○	Refer to page 45
FEATURES ONLY AVAILABLE WITH OPTIONAL TOUCH PRO							
Touch Pro Navigation Pack with Meridian™ Sound System (380W) Requires InControl Connect Pro (Z77G) as standard	Z58Y	○	○	○	○	○	
Touch Pro Navigation Pack with Meridian™ Surround Sound System (825W) Requires InControl Connect Pro (Z77G) as standard	Z59I	○	○	○	○	○	
10" Dual View Touchscreen	D70E	○	○	○	○	○	
Digital TV Tuner	G61D	○	○	○	○	○	Refer to page 46
Connect Pro Pack	Z77G	○	○	○	○	○	Refer to page 47
FEATURES AVAILABLE WITH TOUCH OR TOUCH PRO							
Protect	D45D	●	●	●	●	●	Includes SOS Emergency Call, Jaguar Optimised Assistance and Remote Essentials smartphone app. Refer to page 43
Secure Tracker	D44A	○	○	○	○	○	Stolen Vehicle Tracking via your smartphone app. Refer to page 43
Apps	H57A	○	○	○	○	○	
Head-up Display with Infrared Reflective Windscreen (requires rain sensing windscreen wipers)	G62A	○	○	○	○	○	Refer to page 41
DAB Radio	B51A	○	○	○	○	○	
OPTION PACKS							
Cold Climate Pack	Z88D	○	○	○	○	○	
Power Convenience Pack	Z19B	○	○	○	○	○	
Convenience Pack	Z28A	○	○	○	○	—	
Lighting Pack	Z37E	○	○	○	○	○	
Memory Pack (requires electric seats)	Z15X	○	○	○	○	○	
Memory Pack with Power Fold Mirrors (requires electric seats)	Z15Y	○	○	○	○	○	
Parking Pack	Z68S	○	○	○	○	○	
Advanced Park Assist Pack	Z68T	○	○	○	○	○	
Advanced Park Assist Pack with Surround Camera System (requires power fold mirrors)	Z68U	○	○	○	○	○	
Road Technology Pack (requires automatic transmission)	Z80S	—	○	○	○	○	
Head-up Display Pack	Z13A	○	○	○	○	○	
Black Pack	Z93L	—	○	○	○	○	
Advantage Pack	Z68V	○	○	—	○	—	
Winter Pack	Z88P	○	○	—	○	—	
Active Safety Pack	Z76C	○	○	○	○	○	

3 CHOOSE YOUR COLOUR

 [Configure your vehicle at jaguar.com](https://www.jaguar.com)

SOLID

Fuji White

Narvik Black

Caldera Red*

METALLIC

Yulong White

Santorini Black

Indus Silver

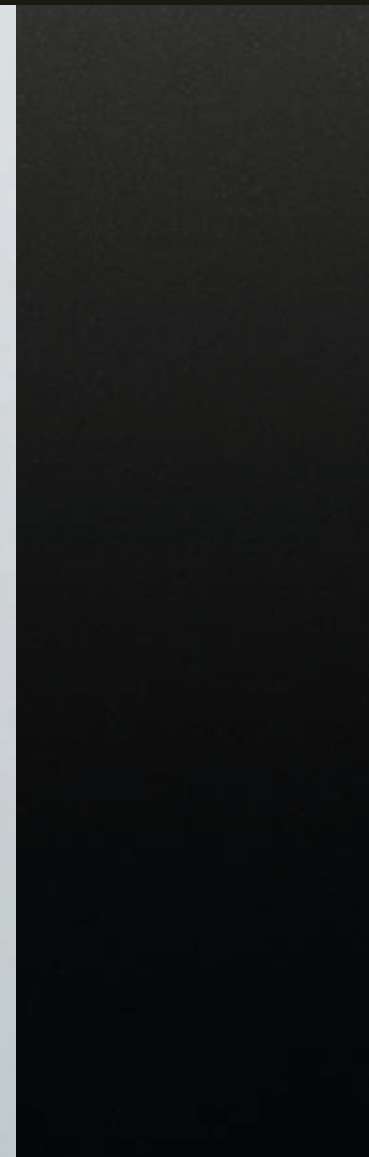
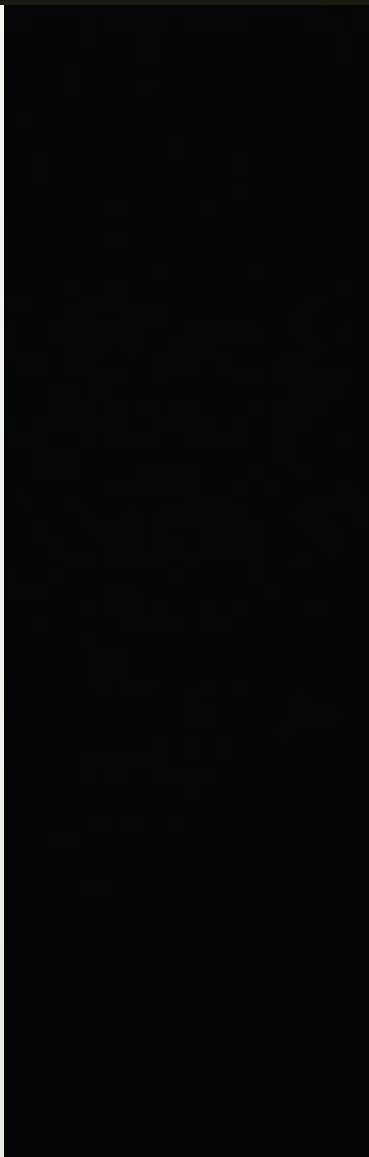
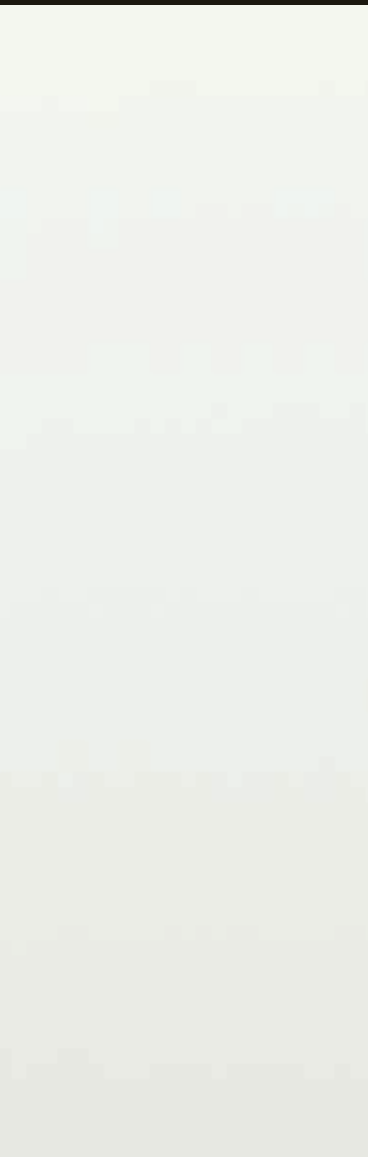

*Available from Autumn 2017.

Corris Grey

Caesium Blue

Loire Blue

Firenze Red

PREMIUM PALETTE

Silicon Silver

Carpathian Grey

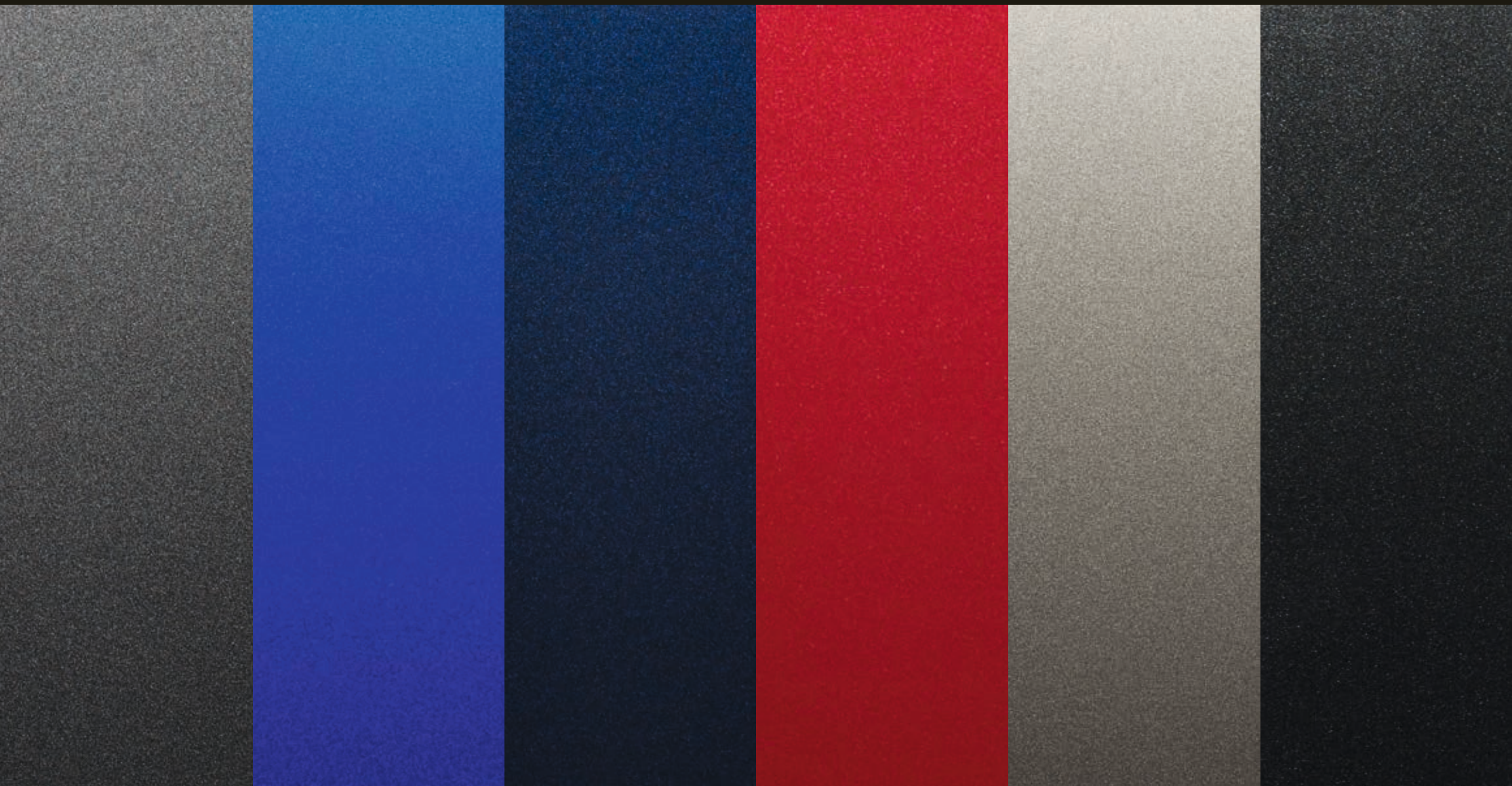

4 CHOOSE YOUR WHEELS

 Configure your vehicle at jaguar.com



17" 10 SPOKE
'STYLE 1017'¹¹



17" 15 SPOKE
'STYLE 1016'¹¹



17" 10 SPOKE
'STYLE 1047'¹²



17" 7 SPLIT-SPOKE
'STYLE 7010'¹²

ALLOY WHEEL FINISH	Sparkle Silver	Sparkle Silver	Sparkle Silver	Sparkle Silver
ALLOY WHEEL/SIZE	6.5J x 17"	6.5J x 17"	7.0J x 17"	7.0J x 17"
TYRE SIZE	205/55 R17	205/55 R17	205/55 R17 225/50 R17	205/55 R17 225/50 R17
CODE	C53E	C53C	C52Y	C53B
Pure	<input type="radio"/>	<input checked="" type="radio"/>	<input checked="" type="radio"/>	<input type="radio"/>
Prestige	<input type="radio"/>	<input checked="" type="radio"/>	<input checked="" type="radio"/>	<input type="radio"/>
Portfolio	<input type="radio"/>	<input checked="" type="radio"/>	<input type="radio"/>	<input type="radio"/>
R-Sport	<input type="radio"/>	<input checked="" type="radio"/>	<input type="radio"/>	<input type="radio"/>
S	<input type="radio"/>	<input type="radio"/>	<input type="radio"/>	<input type="radio"/>



17" 5 SPOKE
'STYLE 5032'¹²



18" 6 SPOKE
'STYLE 6006'¹²



18" 7 SPLIT-SPOKE
'STYLE 7009'¹²



18" 7 SPLIT-SPOKE
'STYLE 7009'¹²

ALLOY WHEEL FINISH	Sparkle Silver	Sparkle Silver	Sparkle Silver	Black
ALLOY WHEEL/SIZE	7.0J x 17"	7.5J x 18"	7.5J x 18"	7.5J x 18"
TYRE SIZE	225/50 R17	225/45 R18	225/45 R18	225/45 R18
CODE	C53D	C52P	C52Q	C52S
Pure	<input type="radio"/>	<input type="radio"/>	<input type="radio"/>	<input type="radio"/>
Prestige	<input type="radio"/>	<input type="radio"/>	<input type="radio"/>	<input type="radio"/>
Portfolio	<input type="radio"/>	<input checked="" type="radio"/>	<input type="radio"/>	<input type="radio"/>
R-Sport	<input type="radio"/>	<input type="radio"/>	<input type="radio"/>	<input type="radio"/>
S	<input type="radio"/>	<input type="radio"/>	<input type="radio"/>	<input type="radio"/>

● Standard ○ Option — Not Applicable

¹¹Only available on models with 2.0 litre 4 cylinder 163PS diesel engine. ¹²Not available with 2.0 litre 4 cylinder 163PS diesel engine.

Standard and optional features may differ depending on market availability.



18" 5 SPOKE
'STYLE 5030'¹²

Silver/Diamond Turned
7.5J x 18" | 8.5J x 18"
225/45 R18 | 245/40 R18
C52N



18" 5 SPLIT-SPOKE
'STYLE 5029'¹²

Silver/Diamond Turned
7.5J x 18" | 8.5J x 18"
225/45 R18 | 245/40 R18
C52L



19" 5 SPLIT-SPOKE
'STYLE 5071'¹²

Sparkle Silver
7.5J x 19" | 8.5J x 19"
225/40 R19 | 255/35 R19
C52T



19" 15 SPOKE
'STYLE 1015'¹²

Sparkle Silver
7.5J x 19" | 8.5J x 19"
225/40 R19 | 255/35 R19
C52U

ALLOY WHEEL FINISH	Silver/Diamond Turned	Silver/Diamond Turned	Sparkle Silver	Sparkle Silver
ALLOY WHEEL/SIZE	7.5J x 18" 8.5J x 18"	7.5J x 18" 8.5J x 18"	7.5J x 19" 8.5J x 19"	7.5J x 19" 8.5J x 19"
TYRE SIZE	225/45 R18 245/40 R18	225/45 R18 245/40 R18	225/40 R19 255/35 R19	225/40 R19 255/35 R19
CODE	C52N	C52L	C52T	C52U
Pure	<input type="radio"/>	<input type="radio"/>	<input type="radio"/>	<input type="radio"/>
Prestige	<input type="radio"/>	<input type="radio"/>	<input type="radio"/>	<input type="radio"/>
Portfolio	<input type="radio"/>	<input type="radio"/>	<input type="radio"/>	<input type="radio"/>
R-Sport	<input checked="" type="radio"/>	<input type="radio"/>	<input type="radio"/>	<input type="radio"/>
S	<input type="radio"/>	<input checked="" type="radio"/>	<input type="radio"/>	<input type="radio"/>



19" 15 SPOKE
'STYLE 1015'¹²

Black/Diamond Turned
7.5J x 19" | 8.5J x 19"
225/40 R19 | 255/35 R19
C52M



19" 5 SPLIT-SPOKE
'STYLE 5031'¹²

Silver/Diamond Turned
7.5J x 19" | 8.5J x 19"
225/40 R19 | 255/35 R19
C52V



19" 5 SPLIT-SPOKE
'STYLE 5031'¹²

Black
7.5J x 19" | 8.5J x 19"
225/40 R19 | 255/35 R19
C52W



20" 10 SPOKE
'STYLE 1014'¹

Silver/Diamond Turned
8J x 20" | 9J x 20"
235/35 R20 | 265/30 R20
C52K

ALLOY WHEEL FINISH	Black/Diamond Turned	Silver/Diamond Turned	Black	Silver/Diamond Turned
ALLOY WHEEL/SIZE	7.5J x 19" 8.5J x 19"	7.5J x 19" 8.5J x 19"	7.5J x 19" 8.5J x 19"	8J x 20" 9J x 20"
TYRE SIZE	225/40 R19 255/35 R19	225/40 R19 255/35 R19	225/40 R19 255/35 R19	235/35 R20 265/30 R20
CODE	C52M	C52V	C52W	C52K
Pure	<input type="radio"/>	<input type="radio"/>	<input type="radio"/>	-
Prestige	<input type="radio"/>	<input type="radio"/>	<input type="radio"/>	-
Portfolio	<input type="radio"/>	<input type="radio"/>	<input type="radio"/>	-
R-Sport	<input type="radio"/>	<input type="radio"/>	<input type="radio"/>	-
S	<input type="radio"/>	<input type="radio"/>	<input type="radio"/>	<input type="radio"/>

5 CHOOSE YOUR INTERIOR

 Configure your vehicle at jaguar.com

PURE						
	SEAT	UPPER FACIA	INTERIOR TRIM AND OPTION CODES	HEADLINING MORZINE*	CARPET	FINISHER
Standard						
Premium Fabric Seats	Ebony	Ebony	TR01	Light Oyster	Ebony	Gloss Black
	Latte	Ebony	TR02	Light Oyster	Ebony	Gloss Black
	Pebble Grey	Oyster	TR03	Light Oyster	Oyster	Gloss Black
PRESTIGE						
	SEAT WITH CONTRAST STITCH	FACIA UPPER/LOWER	INTERIOR TRIM AND OPTION CODES	HEADLINING	CARPET	FINISHER**
Standard						
Grained Leather Seats	Latte with Ebony	Ebony with Latte	TR06	Light Oyster	Ebony	Brushed Aluminium
	Ebony with Siena Tan	Ebony with Ebony	TR05	Light Oyster	Ebony	Brushed Aluminium
	Light Oyster with Pistachio	Oyster with Light Oyster	TR07	Light Oyster	Oyster	Brushed Aluminium
PORTFOLIO						
	SEAT WITH TONAL STITCH	UPPER FACIA WITH TONAL STITCH	INTERIOR TRIM AND OPTION CODES	HEADLINING	CARPET	FINISHER**
Standard						
Perforated Windsor Leather seats	Brogue with Brogue	Ebony with Ebony/Brogue	TR19	Light Oyster	Ebony	Embossed Aluminium
	Siena Tan with Siena Tan	Ebony with Ebony/Siena Tan	TR18	Light Oyster	Ebony	Embossed Aluminium
	Ebony with Ebony	Ebony with Ebony/Ebony	TR17	Light Oyster	Ebony	Embossed Aluminium
	Light Oyster with Light Oyster	Oyster with Oyster/Light Oyster	TR20	Light Oyster	Oyster	Embossed Aluminium

*Ebony Morzine headlining available as a cost option.

**Console finisher is Gloss Black.

†Light Oyster Morzine headlining available as a cost option.

R-SPORT						
	SEAT WITH CONTRAST STITCH	FACIA	INTERIOR TRIM AND OPTION CODES	HEADLINING†	CARPET	FINISHER**
Standard						
Luxtec and Technical Mesh Sport seats	Ebony/Eclipse with Eclipse	Ebony	TR11	Ebony	Ebony	Etched Aluminium
	Ebony/Pimento with Pimento	Ebony	TR09	Ebony	Ebony	Etched Aluminium
	Ebony/Ebony with Light Oyster	Ebony	TR08	Ebony	Ebony	Etched Aluminium
Optional						
Grained Leather Sport seats	Ebony/Ebony with Light Oyster	Ebony with Light Oyster	TR63	Ebony	Ebony	Etched Aluminium
	Ebony/Pimento with Pimento	Ebony with Pimento	TR10	Ebony	Ebony	Etched Aluminium
	Ebony/Eclipse with Eclipse	Ebony with Eclipse	TR12	Ebony	Ebony	Etched Aluminium
	Ebony/Light Oyster with Light Oyster	Ebony with Light Oyster	TR13	Ebony	Ebony	Etched Aluminium
S						
	DUOTONE SEAT WITH CONTRAST STITCH	FACIA WITH CONTRAST STITCH	INTERIOR TRIM AND OPTION CODES	HEADLINING	CARPET	FINISHER**
Standard						
Grained Leather and Suedecloth Sport seats	Pimento/Ebony with Ebony	Ebony with Pimento	TR14	Ebony	Ebony	Meshed Aluminium
	Ebony/Ebony with Light Oyster	Ebony with Light Oyster	TR21	Ebony	Ebony	Meshed Aluminium
	Eclipse/Ebony with Ebony	Ebony with Eclipse	TR15	Ebony	Ebony	Meshed Aluminium
	Light Oyster/Ebony with Ebony	Ebony with Light Oyster	TR16	Ebony	Ebony	Meshed Aluminium
Optional						
Perforated Grained Leather Sport seats	Ebony/Ebony with Light Oyster	Ebony with Light Oyster	TR21	Ebony	Ebony	Meshed Aluminium
	Pimento/Ebony with Ebony	Ebony with Pimento	TR14	Ebony	Ebony	Meshed Aluminium
	Eclipse/Ebony with Ebony	Ebony with Eclipse	TR15	Ebony	Ebony	Meshed Aluminium
	Light Oyster/Ebony with Ebony	Ebony with Light Oyster	TR16	Ebony	Ebony	Meshed Aluminium

5 CHOOSE YOUR INTERIOR

⚙️ Configure your vehicle at jaguar.com

Interior shown: Ebony fabric seats with Gloss Black finisher, Light Oyster headlining and Ebony facia.



PURE

INTERIOR COLOUR COMBINATIONS

STANDARD

1

SEAT



Ebony

2

FINISHER



Gloss Black

3

HEADLINING



Light Oyster

4

FACIA

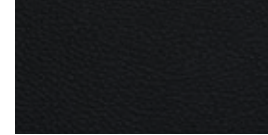

Ebony

5

CARPET



Ebony

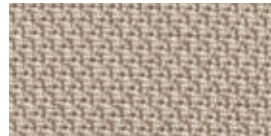

Latte



Gloss Black



Light Oyster

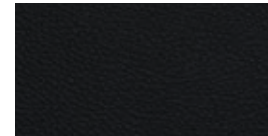

Ebony



Ebony

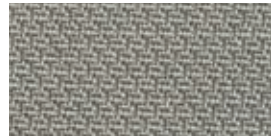

Pebble Grey



Gloss Black



Light Oyster



Oyster



Oyster

OPTIONS

HEADLINING

Ebony

FINISHER

Gloss Black, Dark Satin Brushed Aluminium, Embossed Aluminium, Etched Aluminium, Meshed Aluminium, Carbon Fibre, Satin Burr Ash, Gloss Figured Ebony, Satin Grey Ash, Satin Grey Figured Ebony or Satin Fine Line Wood

5 CHOOSE YOUR INTERIOR

⚙️ Configure your vehicle at [jaguar.com](https://www.jaguar.com)













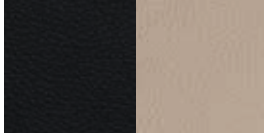

Interior shown: Latte Leather seats with Ebony contrast stitch, Brushed Aluminium finisher, Light Oyster headlining, Ebony upper facia and Latte lower facia.



PRESTIGE

INTERIOR COLOUR COMBINATIONS

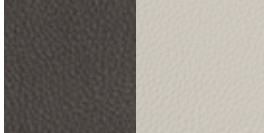
STANDARD

1	2	3	4	5
SEAT WITH CONTRAST STITCH	FINISHER*	HEADLINING	FACIA UPPER/LOWER	CARPET
				
Latte with Ebony	Brushed Aluminium	Light Oyster	Ebony with Latte	Ebony
				
Ebony with Siena Tan	Brushed Aluminium	Light Oyster	Ebony with Ebony	Ebony
				
Light Oyster with Pistachio	Brushed Aluminium	Light Oyster	Oyster with Light Oyster	Oyster

OPTIONS

HEADLINING	FINISHER
Ebony	Gloss Black, Dark Satin Brushed Aluminium, Embossed Aluminium, Etched Aluminium, Meshed Aluminium, Carbon Fibre, Satin Burr Ash, Gloss Figured Ebony, Satin Grey Ash, Satin Grey Figured Ebony or Satin Fine Line Wood

*Console finisher is Gloss Black.

5 CHOOSE YOUR INTERIOR

⚙️ Configure your vehicle at [jaguar.com](https://www.jaguar.com)













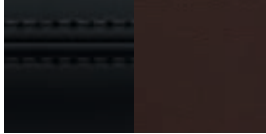

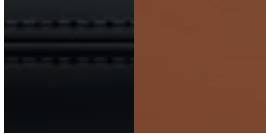

Interior shown: Brogue Leather seats with Herringbone perforations and Brogue tonal stitch. Embossed Aluminium finisher, Light Oyster headlining, Ebony upper facia and Brogue lower facia.

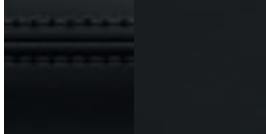

PORTFOLIO

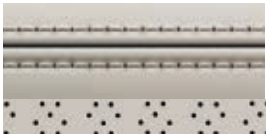
INTERIOR COLOUR COMBINATIONS

STANDARD

1	2	3	4	5
SEAT WITH TONAL STITCH	FINISHER*	HEADLINING	FACIA UPPER WITH TONAL STITCH/LOWER	CARPET
				
Brogue with Brogue	Embossed Aluminium	Light Oyster	Ebony with Ebony/Brogue	Ebony
				
Siena Tan with Siena Tan	Embossed Aluminium	Light Oyster	Ebony with Ebony/Siena Tan	Ebony
				
Ebony with Ebony	Embossed Aluminium	Light Oyster	Ebony with Ebony	Ebony
				
Light Oyster with Light Oyster	Embossed Aluminium	Light Oyster	Oyster with Oyster/Light Oyster	Oyster

OPTIONS

HEADLINING

Ebony

FINISHER

Gloss Black, Dark Satin Brushed Aluminium, Embossed Aluminium, Etched Aluminium, Meshed Aluminium, Carbon Fibre, Satin Burr Ash, Gloss Figured Ebony, Satin Grey Ash, Satin Grey Figured Ebony or Satin Fine Line Wood

*Console finisher is Gloss Black.

5 CHOOSE YOUR INTERIOR

⚙️ Configure your vehicle at [jaguar.com](https://www.jaguar.com)











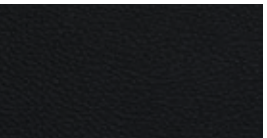

Interior shown: Ebony Luxtec Sport seats with technical mesh inserts and Eclipse contrast stitch. Etched Aluminium finisher, Ebony headlining and Ebony fascia.

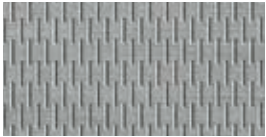

R-SPORT

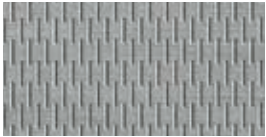
INTERIOR COLOUR COMBINATIONS

STANDARD

1	2	3	4	5
SEAT WITH CONTRAST STITCH	FINISHER*	HEADLINING	FACIA	CARPET
				
Ebony/Eclipse with Eclipse	Etched Aluminium	Ebony	Ebony	Ebony
				
Ebony/Pimento with Pimento	Etched Aluminium	Ebony	Ebony	Ebony
				
Ebony/Ebony with Light Oyster	Etched Aluminium	Ebony	Ebony	Ebony

OPTIONS

HEADLINING	FINISHER
Light Oyster	Gloss Black, Dark Satin Brushed Aluminium, Embossed Aluminium, Etched Aluminium, Meshed Aluminium, Carbon Fibre, Satin Burr Ash, Gloss Figured Ebony, Satin Grey Ash, Satin Grey Figured Ebony or Satin Fine Line Wood

*Console finisher is Gloss Black.

5 CHOOSE YOUR INTERIOR

⚙️ Configure your vehicle at [jaguar.com](https://www.jaguar.com)















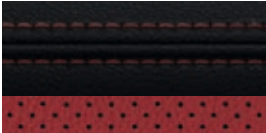

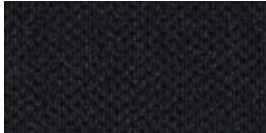

Interior shown: Ebony Perforated Leather Sport seats with Light Oyster contrast stitch. Etched Aluminium finisher, Ebony headlining and Ebony facia with Light Oyster contrast stitch.

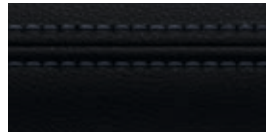

R-SPORT

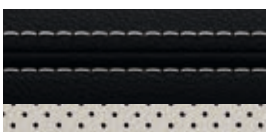
INTERIOR COLOUR COMBINATIONS

OPTIONS

1	2	3	4	5
SEAT WITH CONTRAST STITCH	FINISHER*	HEADLINING	FACIA	CARPET
				
Ebony/Ebony with Light Oyster	Etched Aluminium	Ebony	Ebony with Light Oyster	Ebony
				
Ebony/Pimento with Pimento	Etched Aluminium	Ebony	Ebony with Pimento	Ebony
				
Ebony/Eclipse with Eclipse	Etched Aluminium	Ebony	Ebony with Eclipse	Ebony
				
Ebony/Light Oyster with Light Oyster	Etched Aluminium	Ebony	Ebony with Light Oyster	Ebony

OPTIONS

HEADLINING

Light Oyster

FINISHER

Gloss Black, Dark Satin Brushed Aluminium, Embossed Aluminium, Etched Aluminium, Meshed Aluminium, Carbon Fibre, Satin Burr Ash, Gloss Figured Ebony, Satin Grey Ash, Satin Grey Figured Ebony or Satin Fine Line Wood

*Console finisher is Gloss Black.

5 CHOOSE YOUR INTERIOR

⚙️ Configure your vehicle at [jaguar.com](https://www.jaguar.com)











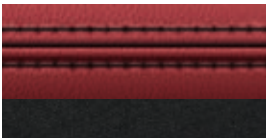
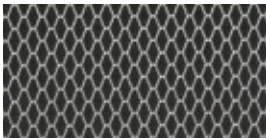



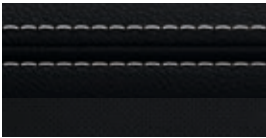
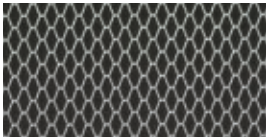

Interior shown: Pimento Leather Sport seats with Ebony Suedecloth inserts and Ebony contrast stitch. Meshed Aluminium finisher, Ebony headlining and Ebony facia with Pimento contrast stitch.

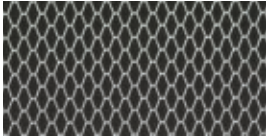

S

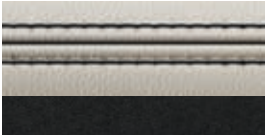
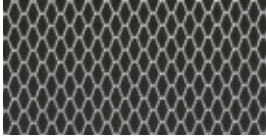
INTERIOR COLOUR COMBINATIONS

STANDARD

1	2	3	4	5
<p>DUOTONE SEAT WITH CONTRAST STITCH</p>  <p>Pimento/Ebony with Ebony</p>	<p>FINISHER*</p>  <p>Meshed Aluminium</p>	<p>HEADLINING</p>  <p>Ebony</p>	<p>FACIA WITH CONTRAST STITCH</p>  <p>Ebony with Pimento</p>	<p>CARPETS</p>  <p>Ebony</p>
 <p>Ebony/Ebony with Light Oyster</p>	 <p>Meshed Aluminium</p>	 <p>Ebony</p>	 <p>Ebony with Light Oyster</p>	 <p>Ebony</p>
 <p>Eclipse/Ebony with Ebony</p>	 <p>Meshed Aluminium</p>	 <p>Ebony</p>	 <p>Ebony with Eclipse</p>	 <p>Ebony</p>
 <p>Light Oyster/Ebony with Ebony</p>	 <p>Meshed Aluminium</p>	 <p>Ebony</p>	 <p>Ebony with Light Oyster</p>	 <p>Ebony</p>

OPTIONS

HEADLINING

Light Oyster

FINISHER

Gloss Black, Dark Satin Brushed Aluminium, Embossed Aluminium, Etched Aluminium, Meshed Aluminium, Carbon Fibre, Satin Burr Ash, Gloss Figured Ebony, Satin Grey Ash, Satin Grey Figured Ebony or Satin Fine Line Wood

*Console finisher is Gloss Black.

5 CHOOSE YOUR INTERIOR

⚙️ Configure your vehicle at [jaguar.com](https://www.jaguar.com)











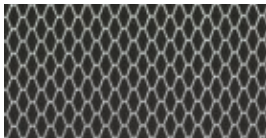



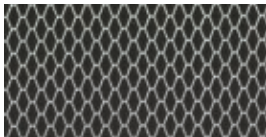

Interior shown: Ebony Perforated Leather seats with Light Oyster contrast stitch.
Meshed Aluminium finisher, Ebony headlining and Ebony facia with Light Oyster contrast stitch.

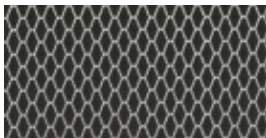

S

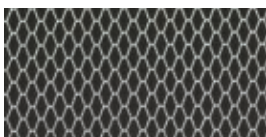
INTERIOR COLOUR COMBINATIONS

OPTIONS

1	2	3	4	5
DUOTONE SEAT WITH CONTRAST STITCH	FINISHER*	HEADLINING	FACIA WITH CONTRAST STITCH	CARPET
 Ebony/Ebony with Light Oyster	 Meshed Aluminium	 Ebony	 Ebony with Light Oyster	 Ebony
 Pimento/Ebony with Ebony	 Meshed Aluminium	 Ebony	 Ebony with Pimento	 Ebony
 Eclipse/Ebony with Ebony	 Meshed Aluminium	 Ebony	 Ebony with Eclipse	 Ebony
 Light Oyster/Ebony with Ebony	 Meshed Aluminium	 Ebony	 Ebony with Light Oyster	 Ebony

OPTIONS

HEADLINING

Light Oyster

FINISHER

Gloss Black, Dark Satin Brushed Aluminium, Embossed Aluminium, Etched Aluminium, Meshed Aluminium, Carbon Fibre, Satin Burr Ash, Gloss Figured Ebony, Satin Grey Ash, Satin Grey Figured Ebony or Satin Fine Line Wood

*Console finisher is Gloss Black.

5 CHOOSE YOUR INTERIOR

 Configure your vehicle at jaguar.com

Gloss Black

Dark Satin Brushed Aluminium

Embossed Aluminium

Etched Aluminium

Meshed Aluminium

Carbon Fibre

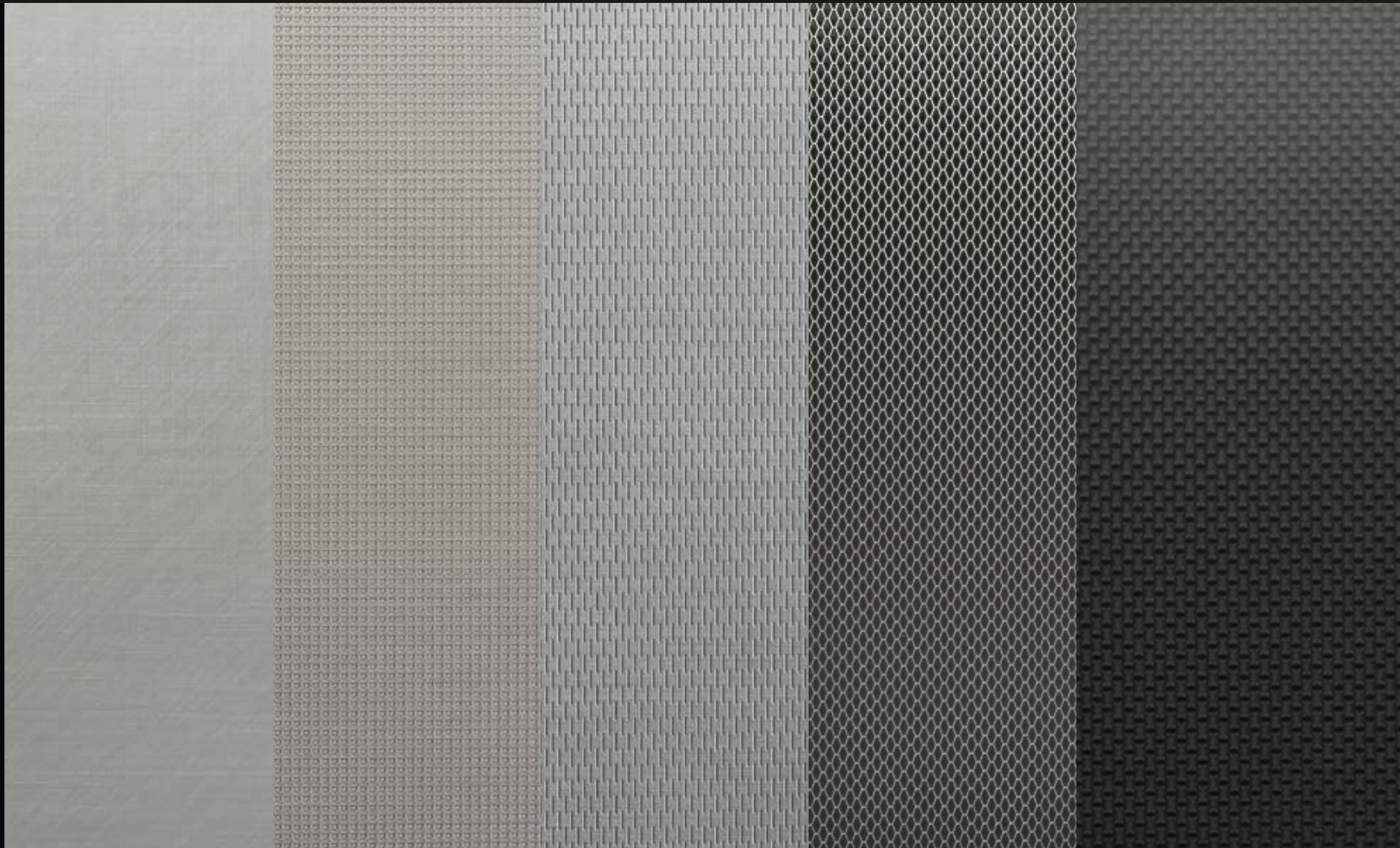

Satin Burr Ash



Gloss Figured Ebony



Satin Grey Ash



Satin Grey Figured Ebony



Satin Fine Line Wood



6 CHOOSE YOUR JAGUAR GEAR ACCESSORIES

To find out more about the full range of Retailer fit Jaguar Gear Accessories, please refer to your retailer or go to accessories.jaguar.com



Roof Mounted Cycle Carrier* **C2A1539**

An easy to fit, roof mounted, lockable cycle carrier which carries one bike per holder. A maximum of three holders can be fitted.

*Requires Roof Cross Bars T4N4709. **Not available on Pure. †Automatic only. ‡Offered for models fitted with space saver spare wheel only.
VEHICLE SHOWN: XE S IN FIRENZE RED WITH OPTIONAL FEATURES FITTED (MARKET DEPENDENT)



Personalised Illuminated Sill Treadplates**
T4N7511

Elegantly styled stainless steel sill treadplate finishers for driver or passenger doors. Illuminates when either the driver or passenger doors are opened. Highlighted by soft Phosphor Blue lighting. Allows you to specify a monochrome 'motif' in a choice of approved typefaces/scripts.



Aluminium Gearshift Paddles†
T2R6547MMU

Replacement steering wheel gearshift paddles offered in a premium aluminium material providing a high quality finish to a key contact point in the vehicle. Manufactured from billet machined aluminium, the paddles are hand brushed for a premium finish and anodised to ensure they will not deteriorate with wear.



iPad® Holder
T2H7757

Jaguar branded iPad® holder mounts to front seat headrests providing a flexible solution for rear seat entertainment. Quick release design ensures iPad® can be fitted or removed quickly and easily.



Sport Pedal Covers
T2H3747 - Manual Transmission Vehicles
T2H3746 - Automatic Transmission Vehicles (not shown)

Made from stainless steel and rubber, the pedal kit fits securely over existing pedals for a contemporary, sporting appearance.



Rubber Mats
T4N7496 - LHD
T4N16396 - LHD AWD

Hard wearing Jaguar branded rubber mats provide added protection for your vehicle's carpets.



Premium Luggage Compartment Carpet Mat†
T4N7147PVJ

Luxurious soft luggage mat in Ebony Black with the Jaguar logo. Deep premium 2,050g/m² pile with nubuck edging and Dove contrast stitch.

6 CHOOSE YOUR JAGUAR GEAR ACCESSORIES

 Configure your vehicle at jaguar.com



Gloss Black Side Power Vent
T4N5176 - Left Side
T4N5178 - Right Side

Gloss Black side power vents provide a dynamic exterior styling enhancement.



Carbon Fibre Side Power Vent
T2H6208 - Left Side
T2H6209 - Right Side

High grade Carbon Fibre side power vents provide a performance-inspired styling upgrade.



Chrome Grille
T4N10516

Provides a Chrome finish to the grille surround and bumper beam accentuating the XE's luxury appearance.



Gloss Black Mirror Cover
C2D6066PEC - Left Side
C2D6067PEC - Right Side

Gloss Black mirror covers accentuate the dynamic design of the exterior mirrors.



Carbon Fibre Mirror Cover
C2P24176 - Left Side
C2P24177 - Right Side

High grade Carbon Fibre mirror covers provide a performance-inspired styling upgrade.



Chrome Mirror Cover
C2D5489 - Left Side
C2D5488 - Right Side

Chrome mirror covers accentuate the stylish design of the exterior mirrors.

*Requires roof cross bars T4N4709. **For Pure, Prestige and Portfolio.



Roof Cross Bars
T4N4709

Jaguar branded cross bars required for fitting all roof carrying equipment. Engineered specifically for your vehicle.



Watersports Carrier*
C2Z21730

A versatile system for transporting a variety of water sports equipment including surfboard, kayak or sailboard. Tilts to facilitate loading/unloading.



Roof Sport Box*
C2C41627

Spacious 320 litre capacity lockable roof box designed for sports equipment, measuring 206 x 84 x 34cm.

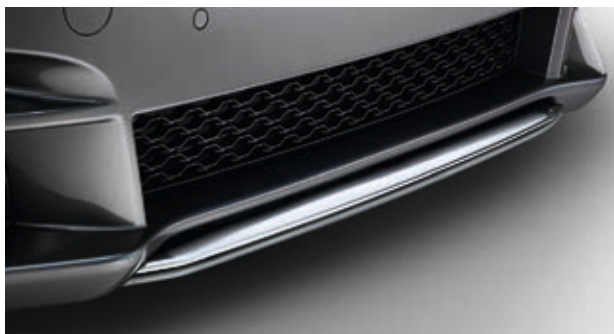

Chrome Front Splitter**
T4N7599

Give XE an even more stylish look with this bright finish front splitter blade. Body coloured rear spoiler is also available. (T4N5462LML)



Rear Splash Guards
T4N7514

Jaguar branded, rear splash guards complement the lines of your vehicle and provide protection from dirt and stone chippings.



Tow Bar Mounted Cycle Carrier
C2Z22695 - Two Bike Carrier
C2Z22697 - Three Bike Carrier

Premium tow ball mounted cycle carriers provide a convenient bike carrying solution with quick release loading attachments and secure locking mechanism. Clever design allows carrier to be tilted away from vehicle when fitted allowing access into the rear tailgate.

TECHNICAL SPECIFICATIONS

 Configure your vehicle at jaguar.com

ENGINES		E-PERFORMANCE 2.0 LITRE 4 CYLINDER TURBOCHARGED DIESEL		20d 2.0 LITRE 4 CYLINDER TURBOCHARGED DIESEL		
Capacity	cc	1,999		1,999		
Maximum power	EEC-PS (kW)	163 (120)		180 (132)		
@rev/min	rpm	4,000		4,000		
Maximum torque	EEC-Nm (lb.ft.)	380 (280)		430 (318)		
@rev/min	rpm	1,750-2,500		1,750-2,500		
PERFORMANCE		MANUAL RWD	AUTO RWD	MANUAL RWD	AUTO RWD	AUTO AWD
0-100 km/h	seconds	8.4	8.2	7.8	7.8	7.9
0-60 mph	seconds	7.9	7.7	7.4	7.4	7.5
Top speed	km/h (mph)	227 (141)	227 (141)	231 (144)	228 (142)	225 (140)
FUEL CONSUMPTION ¹						
Urban	l/100km (mpg)	4.4 (64.2)	5.0 (56.5)	5.0 (56.5)	5.0-5.1 (56.5-55.4)	5.5 (51.4)
Extra Urban	l/100km (mpg)	3.4 (83.1)	3.5 (80.7)	3.7 (76.4)	3.7 (76.4)	4.2 (67.8)
Combined	l/100km (mpg)	3.8 (75.0)	4.1 (68.9)	4.2 (67.3)	4.2 (67.3)	4.7 (60.6)
Carbon dioxide Urban	g/km	114	130	130	130-134	145
Carbon dioxide Extra Urban	g/km	90	92	97	97-98	110
Carbon dioxide Combined	g/km	99	106	109	109-111	123
Tank capacity (usable)	ltr approx.	47	56	56	56	56
DIMENSIONS						
Overall length	mm	4,672		4,672		
Overall width (inc. mirrors)	mm	2,075		2,075		
Overall width (mirrors folded)	mm	1,967		1,967		
Overall height	mm	1,416		1,416-1,425		
Wheelbase	mm	2,835		2,835		
Front track	mm	1,607		1,597-1,602		
Rear track	mm	1,608		1,585-1,603		
Ground clearance	mm	110		110-119		
Turning circle diameter (kerb to kerb)	m	11.22		11.22		
Boot volume	litres	455		455		
WEIGHT ²						
Weight from	kg	1,435	1,450	1,490	1,505	1,615
Gross vehicle weight	kg	2,100	2,100	2,135	2,135	2,230
ENGINE AVAILABILITY						
Pure		●			●	
Prestige		●			●	
Portfolio		●			●	
R-Sport		●			●	
S		—			—	

● Available — Not Available

¹The figures provided are as a result of official manufacturer's tests in accordance with EU legislation. A vehicle's actual fuel consumption may differ from that achieved in such tests and these figures are for comparative purposes only.

²Weights reflect vehicles to standard specifications. Optional extras increase weight.

25d 2.0 LITRE 4 CYLINDER TWIN TURBOCHARGED DIESEL	20t 2.0 LITRE 4 CYLINDER TURBOCHARGED PETROL	25t 2.0 LITRE 4 CYLINDER TURBOCHARGED PETROL	S 3.0 LITRE V6 SUPERCHARGED PETROL
1,999	1,998	1,998	2,995
240 (177)	200 (147)	250 (184)	380 (280)
4,000	5,500	5,500	6,500
500 (368)	320 (236)	365 (269)	450 (332)
1,500	1,200-4,500	1,200-4,500	3,500-5,000
AUTO AWD	AUTO RWD	AUTO RWD	AUTO AWD
6.1	7.1	6.3	6.2
5.8	6.7	6.0	5.8
250 (155)	238 (148)	250 (155)	250 (155)
6.4 (44.1)	8.2 (34.5)	8.2 (34.5)	8.4 (33.8)
4.5 (62.8)	5.2 (54.3)	5.2 (54.3)	5.8 (49.2)
5.2 (54.4)	6.3 (45.1)	6.3 (45.1)	6.8 (42.2)
168	186	186	192
119	120	120	132
137	144	144	154
56	63	63	63
4,672	4,672	4,672	4,672
2,075	2,075	2,075	2,075
1,967	1,967	1,967	1,967
1,425	1,416	1,416-1,425	1,416
2,835	2,835	2,835	2,835
1,597-1,602	1,597-1,602	1,597-1,602	1,596-1,602
1,585-1,603	1,585-1,603	1,585-1,603	1,573-1,603
119	110	110-119	110
11.22	11.22	11.22	11.22
455	455	455	455
1,650	1,540	1,540	1,595
2,260	2,150	2,150	2,210
●	●	●	—
●	●	●	—
●	●	●	—
●	●	●	—
—	—	—	●

DIMENSIONS

Overall Width (inc mirrors) 2,075mm
Overall Width (mirrors folded) 1,967mm
Boot Volume 455 Litres



Turning Circle
Kerb to Kerb 11.22m

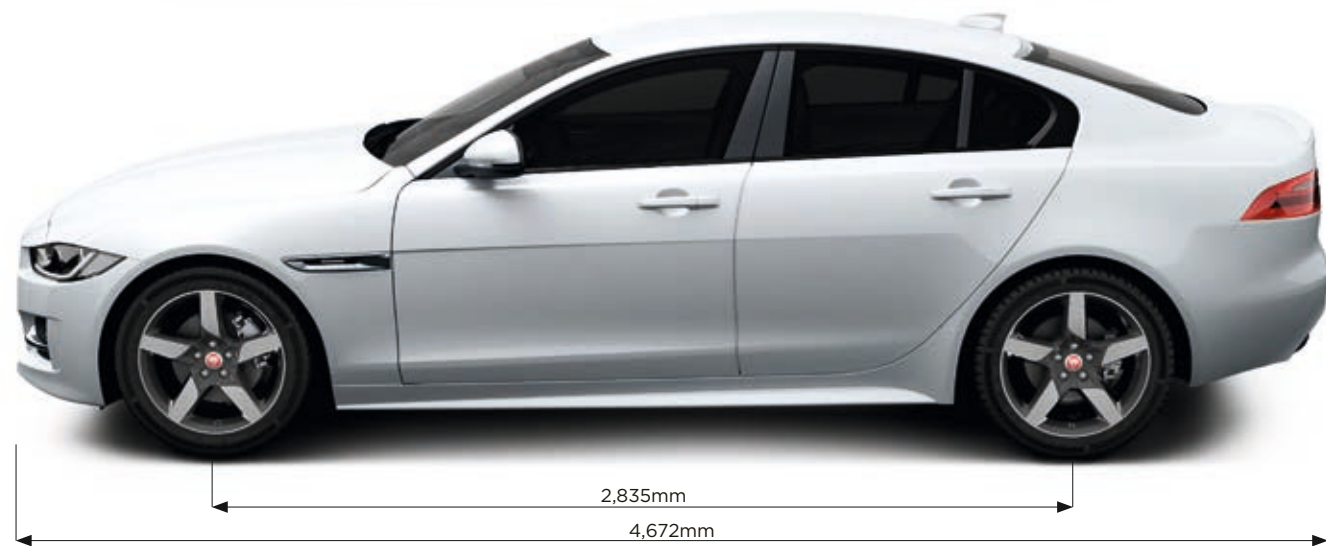

Dimensions were measured with vehicle at unladen weight.
(measured by VDA standard test method using 200 x 100 x 50mm blocks.)

VEHICLE SHOWN: XE R-SPORT IN YULONG WHITE WITH OPTIONAL FEATURES FITTED (MARKET DEPENDENT)

JAGUAR EXPERIENCE

There's no better way to get to know Jaguar than by taking a drive. The Jaguar Experience offers a range of unique opportunities to really find out what it feels like to get the most out of a Jaguar. Our track experiences allow you to push yourself and cars from the incredible Jaguar range to the limit. Jaguar Experience also offers the opportunity to see a Jaguar brought to life during a tour of one of our UK manufacturing facilities.

Find out more by visiting jaguar.com/experience



BEHIND THE SCENES

Our factory tours give you the unique opportunity to experience the whole process of how our cars are brought to life - from the moulding of sheet metal to those intricate final touches. At our state-of-the-art production facilities, you'll get to see how skilled technicians and sophisticated machines work seamlessly together to perfect some of Jaguar's most breathtaking cars.

Find out more at jaguar.com/experience-jaguar/behind-the-scenes



DRIVING EXPERIENCES

The opportunity to drive the latest Jaguar cars at their limits, or relive iconic Jaguar history, is rare. Jaguar Driving Experiences offer unique driving adventures you will never forget. Imagine yourself behind the wheel of our highest performing Jaguar models, on a private track, with a Jaguar Experience Instructor at your side. This is the Jaguar Performance Driving Academy.

Find out more at jaguar.com/experience-jaguar/driving-experiences



ICONIC EXPERIENCES

Take your driving to the next level with the Jaguar Land Rover Ice Drive Experience. From 2017, we are offering an adventure in Arjeplog, Sweden, that will test and develop your performance driving skills in extreme conditions. It's a rare chance for owners and enthusiasts to tackle some of the harshest and most challenging tracks on earth, under the skilled guidance of our experts. Our driving instructors are of the highest-calibre and will be with you every step of the way - ready to impart years of driving wisdom. You will dance on ice, glide around some of the most awe-inspiring corners imaginable and realise the true exhilarating potential of Jaguar and Land Rover.

If you'd like to be part of the next adventure, find out more by visiting: jaguar.com/experience-jaguar/iconic-experiences

THE WORLD OF JAGUAR

Choose an XE and you're joining the exciting World of Jaguar. It makes owning and driving carefree and easy, as well as providing a range of exclusive services and lifestyle products.



JAGUAR CARE*

XE is offered with unlimited mileage, three year warranty and three years' standard servicing programme. We call this programme Jaguar Care. It makes XE's overall cost of ownership one of the lowest in its class.

To find out more about XE's superbly competitive Jaguar Care programme, please go to jaguar.com/jaguarcare

SERVICING

XE has been designed to keep servicing costs to a minimum - for example, the new Ingenium diesel engines can achieve an incredible 34,000km or 2 years** between services due to intelligent design and advanced oil technology.

GENUINE PARTS

Jaguar Genuine Parts are designed, tested and manufactured to our uncompromising standards for quality, fit and durability. Each part is engineered specifically for your XE to contribute to optimum performance and to help maximise its lifespan.

FLEET & BUSINESS

Jaguar is dedicated to being the premium manufacturer of choice for fleets and businesses by providing a highly attractive car range and exemplary customer service. Jaguars are dynamic and distinctive cars that help companies express the unique character and personality of their business. We are committed to providing totally customer-focused aftersales services, which keeps every Jaguar car on the move and in top condition, ensuring that they perform to the highest standard and in the most cost-efficient way for businesses. Visit jaguar.com/fleet-and-business

*Selected European Markets only.
**Market and driving style dependent.
†Manufacturer's estimate.



JAGUAR FINANCIAL SERVICES

Effortless performance and style come as standard with every Jaguar. Jaguar Financial Services makes buying one just as simple and rewarding. New or used, for personal or business use, we have an option that puts you in complete control. Please speak to your local Jaguar Retailer to find out more.



JAGUAR ASSISTANCE

Jaguar Assistance provides assistance in motoring emergencies, from immobilisation due to breakdown or accident to minor problems such as punctures. You can rely on our roadside assistance, whatever the situation, wherever you happen to be.

LOW INSURANCE

XE's key components are easily accessible for time-efficient service and repair and to minimise scheduled maintenance and repair costs. With a focus on lower repair costs, XE delivers competitive insurance group ratings[†]. To find out more about the compelling business case for XE, please contact your local Jaguar Retailer.



JAGUAR MAGAZINE

This is our own vibrant, cosmopolitan and contemporary magazine. Produced by a team of enthusiastic designers and feature writers, it goes behind the scenes at Jaguar as well as providing insight into the world of luxury, design, style and travel. You can enjoy Jaguar Magazine twice a year completely free of charge for the first three years. Ask your retailer to ensure that you receive your copy.

JAGUAR COLLECTION

The latest range from the Jaguar Collection has been crafted with the same design execution and attention to detail that goes into all of our cars. This is evident in our clothing range, premium leather items and luxury travel goods. To celebrate Jaguar's heritage we also have a collection that honours past achievements and features race-inspired gift items and apparel. To find out more, visit the online shop at www.jaguar.com/shop

GLOSSARY

A

AUDIO EQUALISATION

Audio Equalisation lets you fine tune the sound of your car's audio system by giving you tone adjustment not covered by standard treble, mid-range, and bass controls.

C

Cd

The Cd value is the drag coefficient of the car. It gives an indication of the vehicle's aerodynamic qualities. The lower the value, the more aerodynamically efficient the vehicle's design.

D

DAMPERS/DAMPING

Dampers absorb forces acting on the suspension for greater ride comfort and control. Dampers are also known as shock absorbers.

DRAG COEFFICIENT

The drag coefficient measures how aerodynamic a car is. See definition of Cd.

DSP AMPLIFIER

Meridian's Digital Signal Processing (DSP) technology analyses a range of variables that may impact audio quality, then processes them using sophisticated algorithms and adapts the system's output accordingly. This enables a level of powerful, authentic performance impossible with a conventional sound system.

E

ECO MODE

Eco Mode encourages fuel efficient driving by reducing throttle sensitivity, selecting more economical engine mapping and, on manual vehicles, advising of gear shifts. It also reduces fuel consumption by reducing the energy demands placed on the engine by climate control and audio systems.

J

JAGUARDRIVE CONTROL

Interacts with the Dynamic Stability Control system, engine and transmission management systems to alter the characteristics of the engine mapping, gear shifts and brakes. It offers different modes designed to optimise the vehicle's response to particular driving conditions and styles.

'J' BLADE DAYTIME RUNNING LIGHTS

'J' blade Daytime Running Lights are separate LED running lights, in a distinctive 'J' shape, built into the headlights. They emphasise Jaguar's striking on road style.

JAGUARDRIVE SELECTOR

The JaguarDrive Selector rises from the centre console on start up. It is a rotary shifter used with automatic transmissions that allows you to quickly shift between drive modes.

M

MHL CONNECTION

A Mobile High-Definition Link (MHL) enables connection between a personal device and the infotainment system. It is designed for seamless transfer of audio-visual data.

S

SUPERCHARGED PETROL

A petrol engine with a supercharger. A supercharger is a forced induction device mechanically driven by the engine. It offers higher power outputs and immediate, linear response at all engine speeds.

T

10.2" MULTI-TOUCHSCREEN WITH MULTI-TOUCH GESTURES

The Multi-touch functionality of Touch Pro's 10.2" Display allows the screen to recognise multiple points of contact. This provides direct control of the system's features in a more natural, intuitive way, enabling gestures such as pinch and zoom.

TURBOCHARGED DIESEL

Diesel engine with a turbocharger. A turbocharger is a forced induction device powered by exhaust gases. Turbocharging produces higher power outputs, lower emissions levels, and improved efficiency and refinement compared to similar capacity naturally aspirated engines.

X

XENON HEADLIGHTS

Bi-function Xenon headlights offer improved illumination and feature LED 'J' blade Daytime Running Lights for a striking on road style.



IMPORTANT NOTICE

Jaguar Land Rover Limited is constantly seeking ways to improve the specification, design and production of its vehicles and alterations take place continually. While every effort is made to produce up-to-date literature, this brochure should not be regarded as an infallible guide to current specifications, nor does it constitute an offer for the sale of any particular vehicle. Distributors and Retailers are not agents of Jaguar Land Rover Limited by any express or implied undertaking or representation. Comparisons are based on manufacturer's own data and testing prior to publication.

COLOURS

Print and online colours are representative only.

ENVIRONMENTAL INNOVATION AT JAGUAR

Jaguar is committed to reducing dependency on fossil fuels, using fewer natural resources and creating less waste as part of our approach to responsible and sustainable business development, called Environmental Innovation.

Our innovative use of lightweight aluminium (featured in the F-PACE, XF, XE, XJ and F-TYPE) is helping to improve fuel consumption and lower tailpipe CO₂ emissions, as well as delivering other handling and performance benefits to these vehicles.

At the same time, our smart management of resources enables scrap aluminium reclaimed from our stamping process to be segregated and recycled to create the same quality of aluminium sheet with up to 50% recycled content. Compared to using virgin aluminium, this closed-loop recycling system also reduces CO₂ emissions during the manufacturing process.

As a whole, Jaguar Land Rover has reduced its European fleet average tailpipe emissions by 25% versus 2007 and operational CO₂ emissions per vehicle by 30.5%. Our manufacturing facilities are all certified to ISO14001 and we have cut the amount of manufacturing waste to landfill per vehicle by 75%* and reduced our water consumption per vehicle by 34%*. (*versus 2007).

As part of our journey to Carbon Neutral Manufacturing by 2020, we offset 100% of (currently unavoidable) operational CO₂ emissions by investing in projects that reduce the equivalent amount of CO₂ emissions in other ways, providing social and humanitarian benefits at the same time. For example, our award winning Lifestraw 'carbon for water' emissions reduction project has prevented the release of 968,000 tonnes of CO₂ (since it began in 2013) and improved the lives of 2.4 million people in Kenya.

Taking into account the company's global sales growth and increased investment in more efficient operating facilities, we are proud of the progress we have made against our 2020 Environmental Innovation targets to date. Our achievements have also been recognised externally: In 2013 the Company was recognised as the UK's Responsible Business of the Year by leading CR index, Business in the Community and in 2014 we were awarded the Queen's Award for Enterprise in Sustainable Development.

Looking forward, we have developed a 2020 vision for sustainable business growth that focuses on continued improvements in operating & tailpipe CO₂ emissions, carbon neutral manufacturing and zero waste. Jaguar Land Rover also aims to improve the lives of 12 million people by 2020 as part of its global Corporate Social Responsibility programme.

Meridian is the registered trademark of Meridian Audio Ltd.

AdBlue is the registered trademark of the Verband der Automobilindustrie e. V. (VDA).

The Bluetooth® word mark and logos are owned by the Bluetooth SIG, Inc. and any use of such marks by Jaguar Land Rover Limited is under licence.

iPod, iPod touch and iPad are trademarks of Apple Inc, registered in the US and other countries.

The Navigation system must always be used in conditions that will not affect the driver's ability to drive safely or affect the safety of other road users

VEHICLE SHOWN FRONT COVER: XE S IN FIRENZE RED WITH OPTIONAL FEATURES FITTED (MARKET DEPENDENT)

VEHICLE SHOWN BACK COVER: XE S IN YULONG WHITE WITH OPTIONAL FEATURES FITTED (MARKET DEPENDENT)

Jaguar Land Rover Limited
Registered Office: Abbey Road, Whitley,
Coventry, CV3 4LF, United Kingdom
Registered in England Number: 1672070
jaguar.com

PRINTER
TO REPLACE
FSC LOGO

