

JAGUAR XF



THE ART OF PERFORMANCE





BY APPOINTMENT TO
HM THE QUEEN
MANUFACTURERS OF
MOTOR VEHICLES
JAGUAR LAND ROVER LIMITED
COVENTRY



BY APPOINTMENT TO
HRH THE DUKE OF EDINBURGH
MANUFACTURERS OF
MOTOR VEHICLES
JAGUAR LAND ROVER LIMITED
COVENTRY



BY APPOINTMENT TO
HRH THE PRINCE OF WALES
MANUFACTURERS OF
MOTOR VEHICLES
JAGUAR LAND ROVER LIMITED
COVENTRY



JAGUAR

THE ART OF PERFORMANCE

Every day we push performance to its limit. Our performance. Our cars' performance.
We innovate, we engineer, we design. We master rules and then break them.
Only to push further. Past the limits of convention. This is when performance becomes art.

Jaguar. The Art of Performance.





CONTENTS

INTRODUCTION

The Concept of XF	06
XF - The Facts	08

DESIGN

Exterior Principles	10
Exterior Aerodynamics	13
Interior	15
Interior Space	17

PERFORMANCE

Engines Overview	18
Advanced Aerodynamics	22
Lightweight Aluminium Architecture	25
Chassis and Suspension	26

DRIVING TECHNOLOGY

Advanced Driving Dynamics	28
Added Driver Confidence	30
Advanced Drivetrain Technology	33
Torque Vectoring	35
Stability and Control	37
Head-up Display	39

INCONTROL TECHNOLOGIES

Infotainment and Connectivity	40
Touch and Connect	43
Touch Pro and Connect Pro	45
Audio	46

SAFETY

Advanced Driver Assistance	48
----------------------------	----

PERSONALISATION

XF - Your Choice	50
Choose your Engine	52
Choose your Model	54
Choose your Options	56
Choose your Colour	64
Choose your Wheels	66
Choose your Interior	68
Choose your Jaguar Gear Accessories	86
Technical Specifications	90
Dimensions	94

JAGUAR WORLD

Jaguar Experience	96
The World of Jaguar	98
Glossary and Legal Information	100



Scan to find out more about the Jaguar XF.

VEHICLE SHOWN: XF R-SPORT IN CORRIS GREY WITH OPTIONAL FEATURES FITTED (MARKET DEPENDENT)
VEHICLES SHOWN ARE FROM THE JAGUAR GLOBAL RANGE. SPECIFICATIONS, OPTIONS AND AVAILABILITY
WILL VARY BETWEEN MARKETS AND SHOULD BE VERIFIED WITH YOUR LOCAL JAGUAR RETAILER

INTRODUCTION

THE CONCEPT OF XF

XF builds on the success of Jaguar's most award-winning car ever. Possessing an unrivalled combination of style and substance, it delivers an utterly seductive blend of design, dynamics and refinement to create a car that offers both excitement and efficiency. All enhanced by state-of-the-art technologies that keep you safe, connected and entertained.

XF is now available with even more engine choice, including the 2.0 litre 4 cylinder 240PS Twin Turbocharged Ingenium Diesel engine and a new 2.0 litre 4 cylinder 200PS or 250PS Turbocharged Ingenium Petrol engine. They offer effortless performance with low fuel consumption and CO₂ emissions. While the option of All Wheel Drive with Intelligent Driveline Dynamics, on both diesel and petrol models, gives XF even greater capability in challenging road conditions.

XF sits in the Jaguar range between XE's taut athleticism and the supreme luxury of XJ. The fusion of these outstanding Jaguar attributes is what creates XF - the most dynamic, premium business car of its generation.

VEHICLE SHOWN: XF R-SPORT IN CORRIS GREY WITH OPTIONAL FEATURES FITTED (MARKET DEPENDENT)

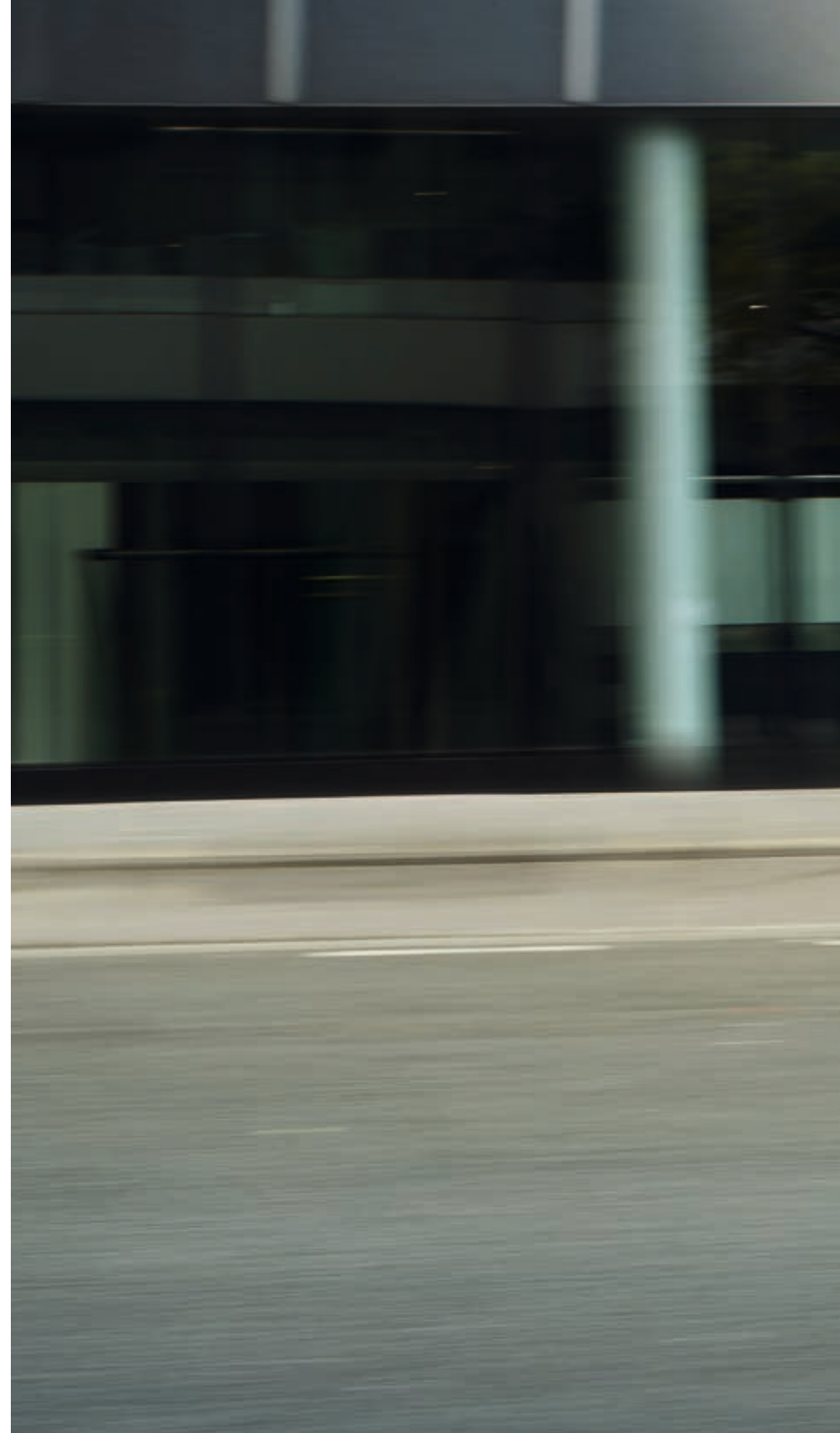



XF - THE FACTS

An outstanding combination of advanced engineering, the latest technology and contemporary design sets XF apart.

ADVANCED AERODYNAMICS

XF is capable of achieving a drag coefficient of just Cd 0.26, one of the lowest in its class. Even the underside of the car is aerodynamically designed to be as smooth as possible, while apertures in the front bumper optimise airflow through the wheel arches. XF cuts through the air, reducing wind noise for enhanced refinement and improved efficiency.

EFFICIENCY AND PERFORMANCE

The XF range offers a choice of performance engines. From CO₂ emissions and fuel economy as low as 104g/km and up to 4.0 l/100km respectively, to a top speed limited to 250km/h and 0-100km/h in 5.3 seconds - there is an XF for every driver.

JAGUAR CARE*

XF is offered with unlimited mileage, three year warranty and three years' standard servicing programme. We call this programme Jaguar Care. It makes XF's overall cost of ownership one of the lowest in its class.



*Selected European markets only.

Some features described here are optional and market dependent.

VEHICLE SHOWN: XF S IN YULONG WHITE WITH OPTIONAL FEATURES FITTED (MARKET DEPENDENT)

CRAFTSMANSHIP AND SPACE

Contemporary craftsmanship and a luxurious, practical interior with the space to stretch out and enjoy every journey. Your front and rear passengers will appreciate leg, knee and headroom that are among the best in class. You can choose the optional 40:20:40 rear seating configuration for increased volume and versatility.

LIGHTWEIGHT ALUMINIUM ARCHITECTURE

XF's Lightweight Aluminium Architecture creates an incredibly strong body that delivers precise and responsive sports handling with impressive fuel efficiency.

ADDED INTELLIGENCE

Innovative technologies make every drive easier and safer. XF offers adaptive LED headlights, Traffic Sign Recognition with Adaptive Speed Limiter, Lane Keep Assist with Driver Condition Monitor, Autonomous Emergency Braking, Adaptive Cruise Control with Queue Assist, Park Assist, and now Blind Spot Assist. With Powered Gesture Boot Lid you can access the boot when your hands are full. Simply present your foot under either rear corner and the boot opens or closes.



ADVANCED DRIVETRAIN TECHNOLOGY

XF offers Jaguar's unique All Wheel Drive with Intelligent Driveline Dynamics (IDD) and Adaptive Surface Response (AdSR) on both petrol and diesel models. This maximises the legendary Jaguar handling, agility and ride, and gives added confidence in all conditions.

CONNECTIVITY

Every drive in XF is enhanced by InControl technologies. InControl is a suite of products and services that connects you with your XF and links XF to the wider world. It ensures you are always in touch. Available for the first time on XF, Dual View allows the front passenger and driver to enjoy different media on the same Touchscreen.



DESIGN EXTERIOR PRINCIPLES



DESIGN PURITY

ADAPTIVE LED HEADLIGHTS

VEHICLE SHOWN RIGHT: XF R-SPORT IN CORRIS GREY WITH OPTIONAL FEATURES FITTED (MARKET DEPENDENT)

"It's about paring it down to the bare essentials. Good designers have always said less is more." Ian Callum, Jaguar Design Director.

XF demonstrates the Jaguar principles of design purity. Strong lines radiate dynamic character and enhance its capabilities - be it improving aerodynamics, visibility, stability or safety. XF is available with adaptive LED headlights* featuring Jaguar signature 'J' blade Daytime Running Lights to give XF a striking on road presence. The quality of LED light is close to daylight, helping your eyes to distinguish objects more easily and reducing fatigue at night.

*Optional feature, Xenon or Halogen headlights are also available depending on the model chosen.



776 XCN





EXTERIOR AERODYNAMICS



F-TYPE INSPIRED DESIGN

AERODYNAMIC DESIGN

At the rear, XF's tail lights feature a distinctive, F-TYPE inspired roundel and intersecting horizontal detail. The LED brake lights are not only brighter than halogen bulbs, they use less energy - contributing to XF's overall drive for greater efficiency. LEDs also illuminate faster - so following drivers can react more quickly to XF's braking. Within the tail lights is a pinstripe graphic - one of XF's many exquisite finishing touches.

XF's sweeping exterior design is naturally aerodynamic. Its advanced form enhances handling, dynamics and refinement. Even the boot lid's height and pitch, as well as its overall curvature and subtle spoiler, are designed to reduce drag and increase downforce. For example, the body generates as much as 50kg of extra downforce at 160km/h for greater stability and helps XF maintain its connection with the road.

VEHICLE SHOWN: XF S IN YULONG WHITE WITH OPTIONAL FEATURES FITTED (MARKET DEPENDENT)





INTERIOR



**DRAMATIC START-UP
SEQUENCE**

**CONTEMPORARY
CRAFTSMANSHIP**

Open XF's door and the Start button entices you inside. Pulsing with a heartbeat it creates an emotional connection between driver and machine. Its 72 per minute double beat is the same as a jaguar cat at rest. XF is poised, ready for action. Now push the Start button. The car awakens and its mood lighting illuminates. With perfect choreography, air vents rotate open, the JaguarDrive Selector rises smoothly, and the engine growls - all inspiring you to anticipate the drive ahead.

XF's interior offers outstanding comfort, a sense of wellbeing and a wealth of choice. The number of switches and buttons is kept to a minimum to keep the look clean and tidy, as well as making them easy to use. Whichever XF interior combination you choose, materials used are always of the highest quality. Leather and finishes are selected with the greatest care to ensure that, inside XF, everything is luxurious to the touch. Whether you prefer aluminium, Carbon Fibre, or wood veneer finishes to complement the beautiful selection of leathers, your XF will always look and feel just right.

INTERIOR SHOWN: XF S FEATURING LIGHT OYSTER/EBONY SEATS WITH EBONY UPPER FACIA WITH CONTRAST STITCH, EBONY CARPET AND EBONY HEADLINING WITH OPTIONAL FEATURES FITTED (MARKET DEPENDENT)





1. Headroom 970mm 2. Knee room 87mm

INTERIOR SPACE



GENEROUS REAR SPACE

IMPRESSIVE VERSATILITY

The rear of XF's cabin is a destination of luxury, choice and space. The generous rear knee room is among the best in class, while the ample rear legroom and rear headroom gives you room to relax. It all adds up to greater comfort and wellbeing for passengers.

At 540 litres* XF's loadspace offers plenty of carrying capacity. For even greater versatility, choose the optional 40:20:40 rear seating configuration - it increases loadspace to an impressive 885 litres.

Interior mood lighting also enhances XF's atmosphere. Opt for Configurable Interior Mood Lighting and you'll have a choice of ten interior colours. The choice continues with optional Four-zone Climate Control, giving individual passengers the opportunity to set their own temperature and airflow.

*With Tyre Repair System. 505 litres with space saver spare wheel.

INTERIOR SHOWN: XF S FEATURING LIGHT OYSTER/EBONY SEATS WITH CONTRAST STITCH, EBONY CARPET AND EBONY HEADLINING WITH OPTIONAL FEATURES FITTED (MARKET DEPENDENT)

PERFORMANCE ENGINES OVERVIEW



INGENIUM ENGINES

STOP/START TECHNOLOGY*

Ingenium technology underpins one of the diesel engines in the XF range. These low friction, all-aluminium engines have stiff cylinder blocks and twin balancer shafts to ensure inherently low levels of vibration, for smooth day-to-day performance. All engines are equipped with Stop/Start technology* and smart regenerative charging - harvesting kinetic energy from braking to charge the battery - for maximum economy, especially during urban driving. For information on fuel consumption, CO₂ emissions and performance figures for XF's engines, please refer to pages 90 to 93.



AdBlue®

INGENIUM DIESEL ENGINES FROM
104g/km CO₂

The **Ingenium 2.0 litre 4 cylinder 163PS Turbocharged Diesel** is refined and highly efficient. Low-flow direct injectors precisely control the amount of fuel that enters the combustion chamber for maximum efficiency. Intelligent, electronically controlled, adaptive engine cooling only engages when required - minimising fuel consumption and CO₂ emissions. This doesn't limit driving pleasure, the engine's strong torque gives good performance from low down in the rev range for brisk acceleration.

The **Ingenium 2.0 litre 4 cylinder 180PS Turbocharged Diesel** offers impressive performance and economy. For an engine of this size it offers high levels of torque, but not at the expense of efficiency - a balance achieved thanks to its variable geometry turbocharger. Adapting to the changing flow of exhaust gases, it maximises low speed torque for broad power and responsiveness that is uniform, progressive and avoids lag.

The **Ingenium 2.0 litre 4 cylinder 240PS Twin Turbocharged Diesel** delivers high power and torque. Its series sequential twin turbocharger uses high and low pressure spools to give continuous acceleration and maximise performance. A higher specific power output is created by building on Ingenium technology. Upgrades include a higher pressure common rail fuel system, increased from 1,800 to 2,200 bar, and an improved fuel injector flow rate.

*Market dependent.



AdBlue®

DIESEL ENGINE

0-100km/h in 6.2 seconds

The **3.0 litre V6 Twin Turbocharged Diesel** engine offers exceptional power, torque and drivability. It uses innovative twin-parallel sequential turbocharging - a concept pioneered by Jaguar Land Rover - for smooth, more immediate delivery of power at all engine speeds, as well as two-stage water cooling to conserve energy.

XF offers a choice of petrol engines, including one from our Ingenium range. With their lightweight, all-aluminium design, and widespread use of low-friction roller bearings, Ingenium petrol engines are built for smooth, highly efficient performance. All engines are equipped with Stop/Start technology* and smart regenerative charging - harvesting kinetic energy from braking to charge the battery - for maximum economy, especially during urban driving.



INGENIUM PETROL ENGINES UP TO

0-100km/h in 6.6 seconds

The **Ingenium 2.0 litre 4 cylinder 200PS Turbocharged Petrol** engine offers the drivability of larger engines, but with much lower fuel consumption. Direct fuel injection from centrally mounted solenoid injectors ensures precise delivery of fuel for highly efficient and clean combustion. Intelligent Continuously Variable Valve Lift control manages early or late opening of inlet valves, meaning the engine can adapt its performance to all driving situations. This works with dual independent variable cam timing to optimise power at all speeds.

The **Ingenium 2.0 litre 4 cylinder 250PS Turbocharged Petrol** engine delivers outstanding usable power and torque. For excellent acceleration and effortless overtaking, maximum torque is available between 1,200-4,500 rpm. This engine's twin scroll turbocharger is fed by an integrated exhaust manifold that synchronises exhaust pulses from two separate pairs of cylinders - significantly reducing turbo lag and improving engine response.

*Market dependent.

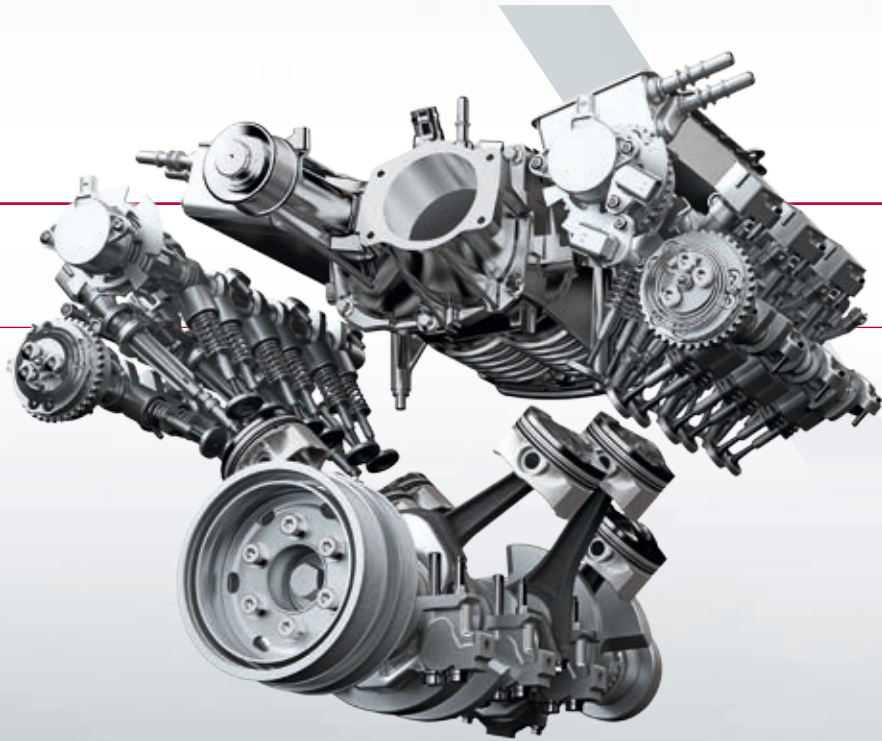

PETROL ENGINES UP TO

0-100km/h in 5.3 seconds

The **3.0 litre V6 Supercharged Petrol engine** features a Roots-type twin vortex supercharger that provides linear delivery of power and maximises responsiveness. This results in performance matching much larger engines, while optimising economy and reducing emissions. The engine also features dual independent variable cam timing to vary inlet and exhaust valve operation, working alongside lightweight pistons with ultra-low friction piston rings, for increased performance and efficiency. For added refinement there is a twin, contra-rotating balancer shaft system.

ADVANCED AERODYNAMICS



LOW DRAG

| Cd 0.26

XF's form has been rigorously optimised for aerodynamic efficiency and stability at motorway speeds. With a drag coefficient as low as Cd 0.26, XF cuts through the air – reducing fuel consumption and lowering emissions. Every element exploits the exterior's maximum aerodynamic potential while preserving XF's stunning proportions. Vertical apertures in the front bumper outer edges channel air through vents in the wheel arches and out over the front wheels. The airflow then passes along XF's sides where the doors have a flatter cross sectional profile to minimise air pressure differences and contribute further to reduced drag. Even the extensive under body protection is designed to make XF as efficient, economical and refined as possible.

VEHICLE SHOWN: XF PORTFOLIO IN SANTORINI BLACK WITH OPTIONAL FEATURES FITTED (MARKET DEPENDENT)



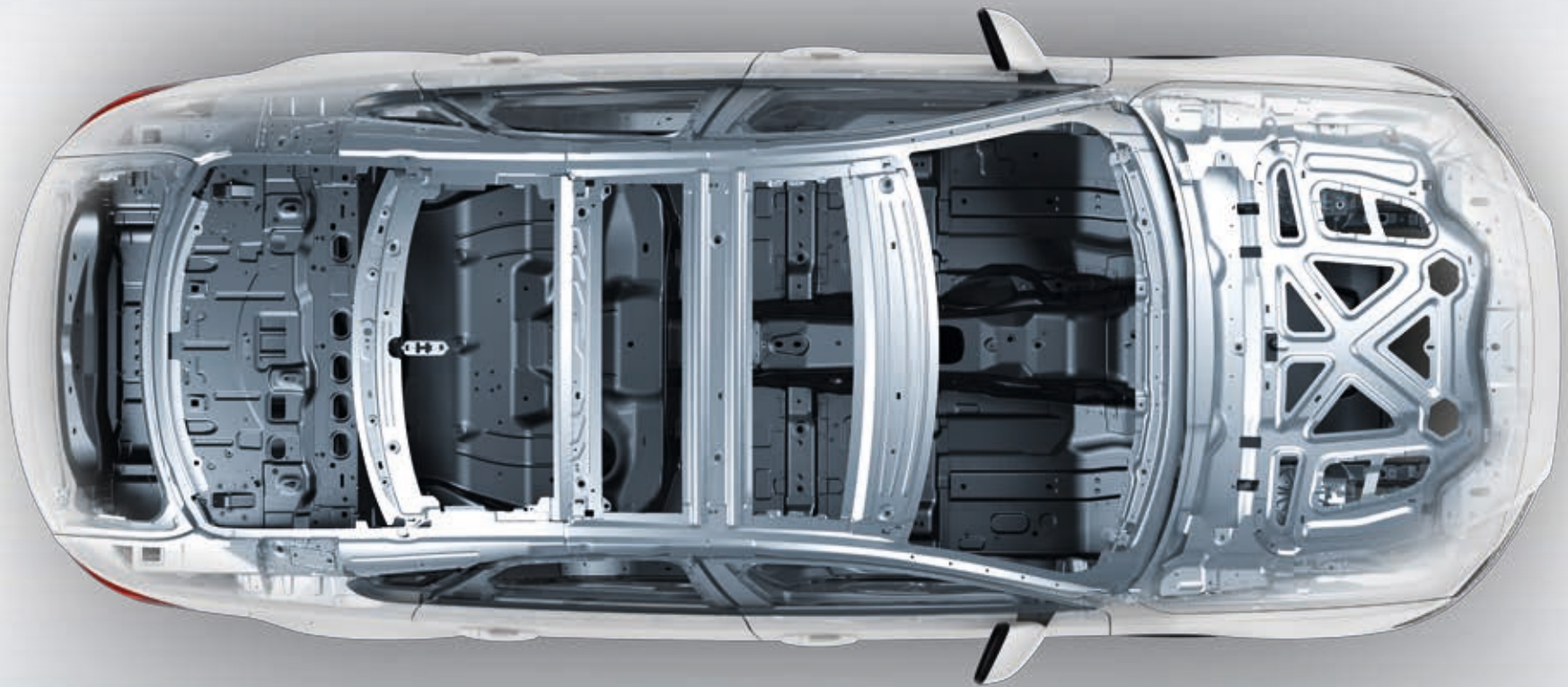

LIGHTWEIGHT ALUMINIUM ARCHITECTURE

 **STRONG** | **RIGID** | **75% ALUMINIUM**

Jaguar has been at the forefront of aluminium car construction for more than a decade. The latest innovation is our high-strength Lightweight Aluminium Architecture, which is not only incredibly strong and reduces weight, it is also extremely stiff - underpinning XF's precise, agile handling. Aluminium has also been used to form the body sides, bonnet and front wings. These panels are bonded together with a super-strong adhesive, then punched with zinc-coated, boron steel rivets that compress the adhesive to form an airtight bond and a phenomenally strong, rigid structure. This cutting-edge process, coupled with the Lightweight Aluminium Architecture, makes XF among the lightest cars in its class. This weight saving facilitates fuel efficiency up to 4.0 l/100km and reduces CO₂ emissions to as low as 104g/km.

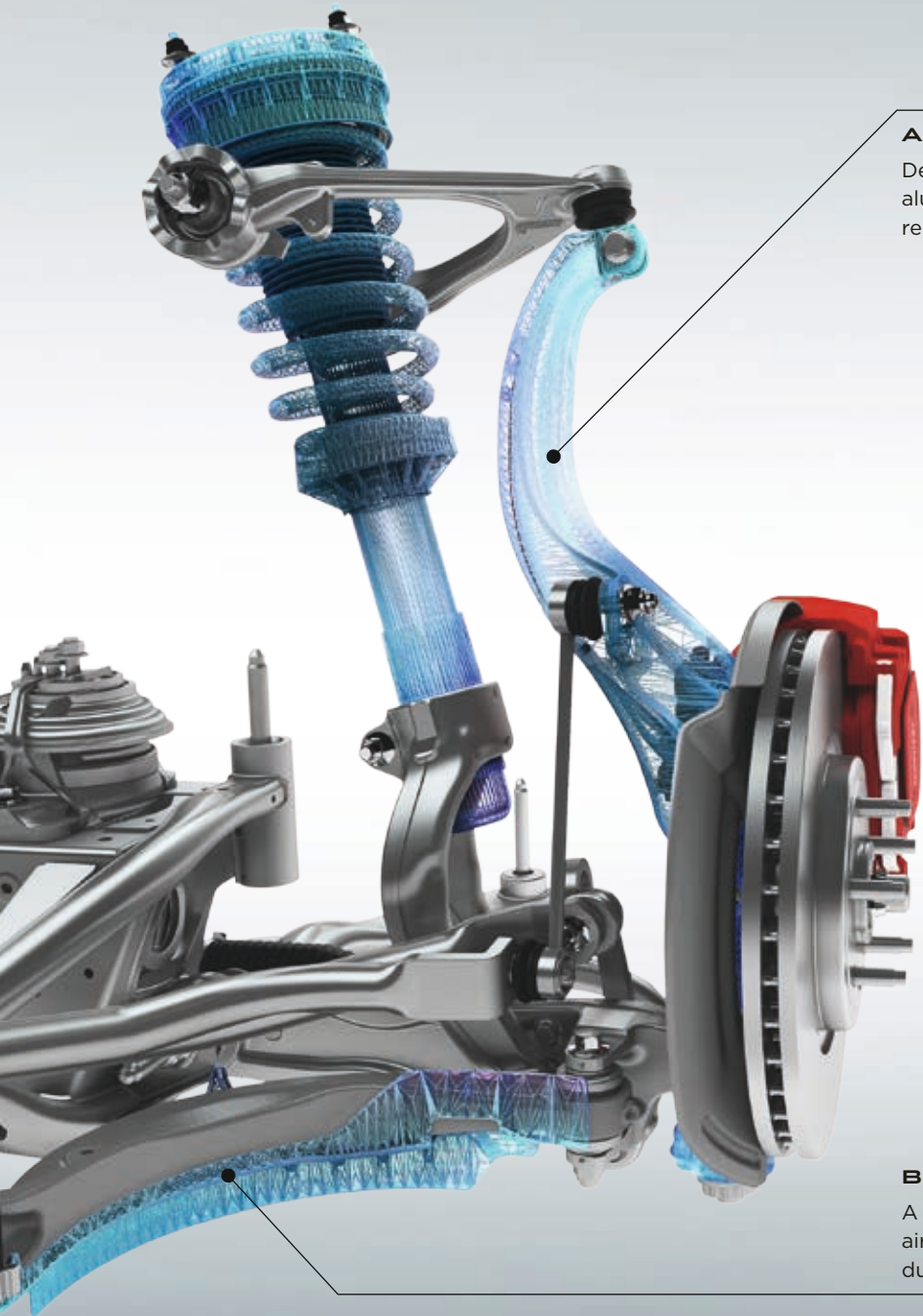

ALUMINIUM FRONT KNUCKLE

Designed to optimise stiffness and strength, the lightweight aluminium front knuckle helps improve XF's agility, responsiveness and refinement for sports car-like control.

CHASSIS AND SUSPENSION



UNIQUE SUSPENSION
TECHNOLOGY

COMFORTABLE
AND DYNAMIC

XF responds with agility and performs with dynamism while always maintaining ride comfort - it's a unique balance that makes it a Jaguar. The ideal foundation for these driving dynamics is XF's light, yet exceptionally strong and stiff, Lightweight Aluminium Architecture with its near 50:50 weight distribution.

The sophisticated front and rear suspension systems complete a chassis that achieves a superb combination of sportiness and refinement. Advanced damper technologies - both passive or adaptive - improve ride quality still further and extend XF's breadth of dynamic capability. The suspension's control, agility and feedback give XF the spirit of a sports car.

BRAKE SCOOP

A glass-filled polypropylene brake scoop channels air onto the brakes for enhanced brake performance during enthusiastic driving.

INTEGRAL LINK REAR SUSPENSION

Integral Link suspension allows XF to realise a perfect combination of a refined, luxurious ride and sharp, responsive handling. The system, the benchmark for this class of car, separates and independently manages the lateral, longitudinal and vertical forces acting on the suspension for enhanced control and comfort. Many components are forged or hollow-cast in aluminium – the optimum production techniques for strong, lightweight suspension.

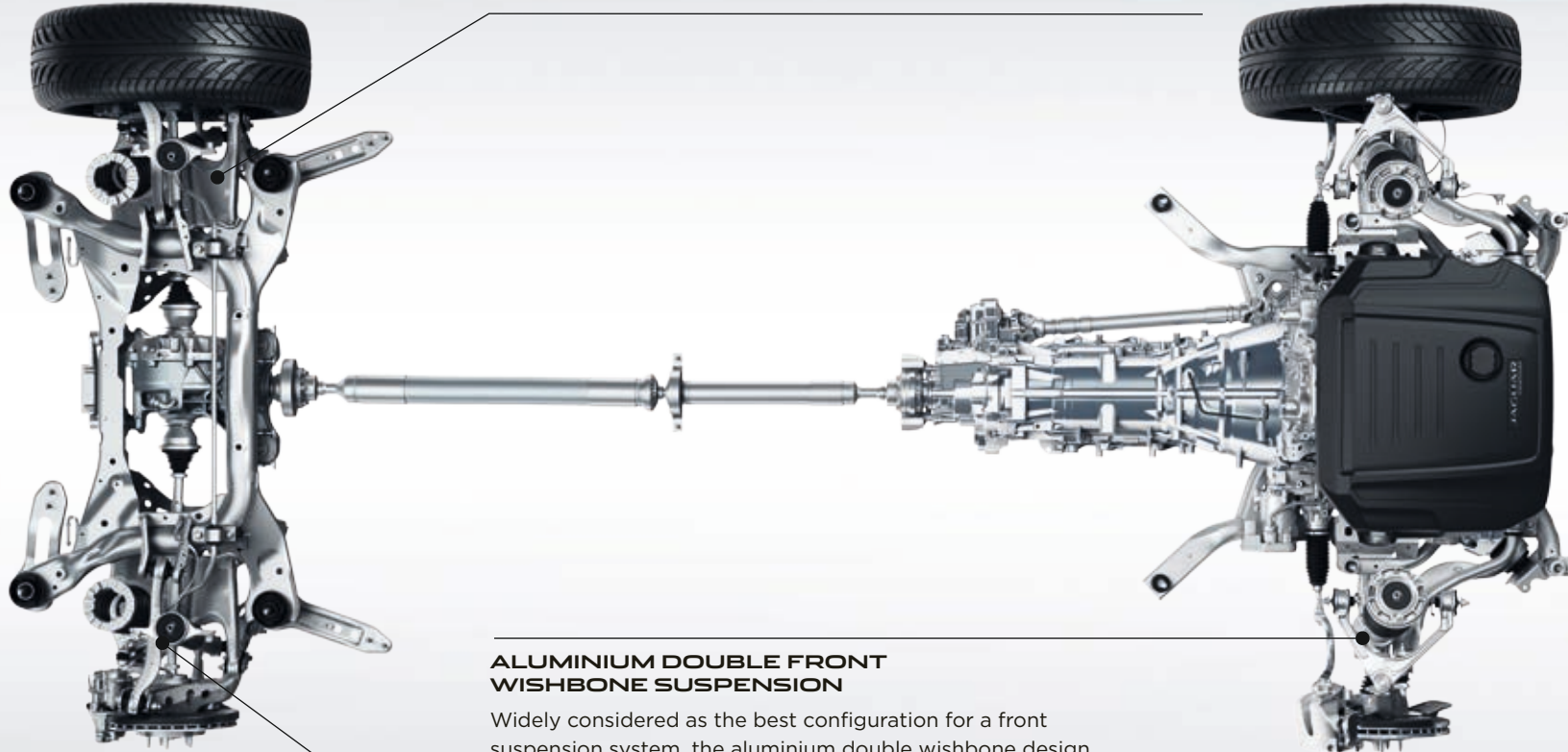

ALUMINIUM DOUBLE FRONT WISHBONE SUSPENSION

Widely considered as the best configuration for a front suspension system, the aluminium double wishbone design is modelled closely on F-TYPE's for precise handling and steering response.

ADAPTIVE DYNAMICS

The optional Adaptive Dynamics system delivers both precise dynamics and a supple, luxurious ride by monitoring wheel position and body movements. The active dampers adjust the suspension to provide the optimum balance between comfort and refinement at all times.

DRIVING TECHNOLOGY

ADVANCED DRIVING DYNAMICS

> MAXIMISING AGILITY

Dynamic Mode revises the car's software to further enhance XF's sporting character. It sharpens the throttle response, increases steering weighting and performs gearshifts more quickly* and at higher engine speeds. It also brings visual drama to the driver as the instrument cluster takes on a red glow. Dynamic Mode enhances your connection with XF's inherent Jaguar performance.

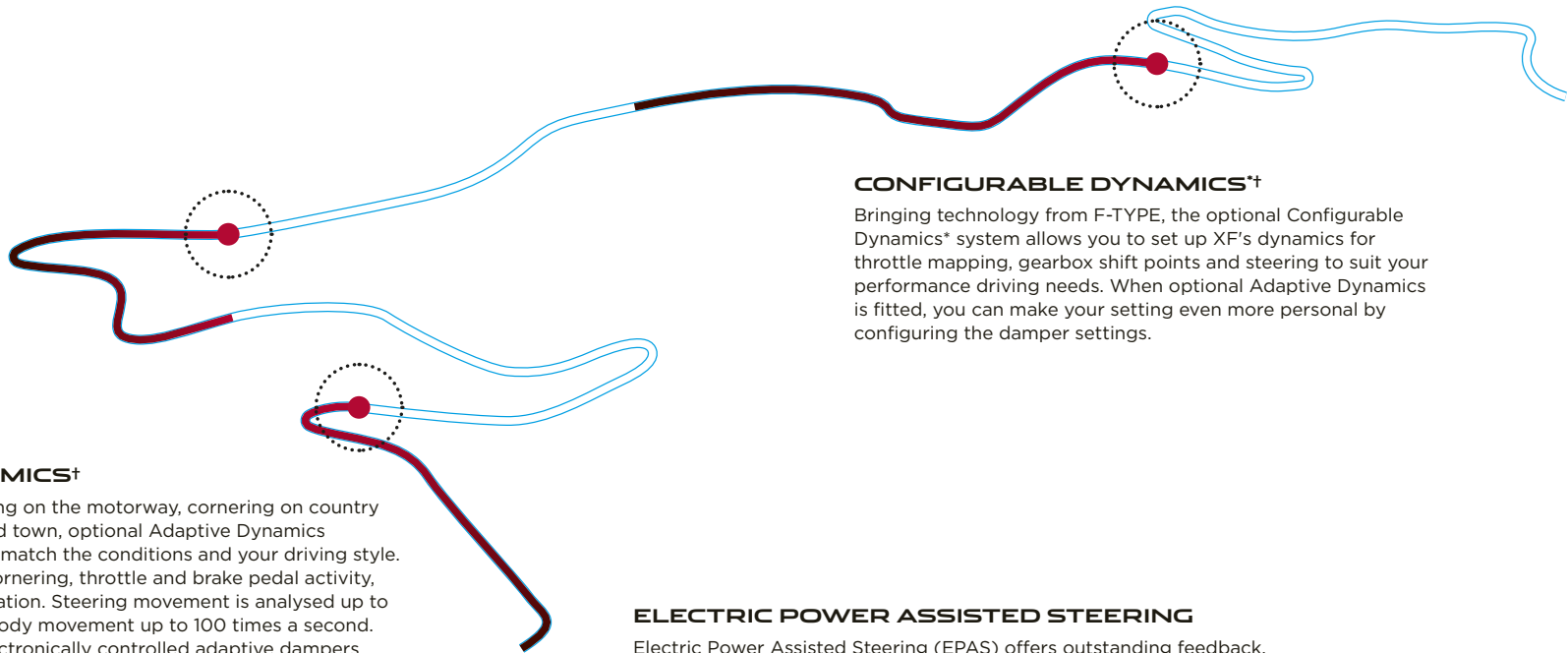

ADAPTIVE DYNAMICS†

Whether you're accelerating on the motorway, cornering on country roads or navigating around town, optional Adaptive Dynamics modifies XF's response to match the conditions and your driving style. It analyses acceleration, cornering, throttle and brake pedal activity, as well as kick-down activation. Steering movement is analysed up to 500 times a second and body movement up to 100 times a second. Using this information, electronically controlled adaptive dampers then constantly adjust to optimise the suspension settings and maintain XF's poise and comfort.

CONFIGURABLE DYNAMICS*†

Bringing technology from F-TYPE, the optional Configurable Dynamics* system allows you to set up XF's dynamics for throttle mapping, gearbox shift points and steering to suit your performance driving needs. When optional Adaptive Dynamics is fitted, you can make your setting even more personal by configuring the damper settings.

ELECTRIC POWER ASSISTED STEERING

Electric Power Assisted Steering (EPAS) offers outstanding feedback, control and it is active on demand - saving power for where you really need it, as well as saving fuel. EPAS' sophisticated computer management varies steering assistance as appropriate - increasing assistance for low speed manoeuvring and improving feel at higher speeds. It also enables advanced safety features such as Lane Keep Assist and Park Assist.

*Automatic transmission only.

†Standard on XF S, not available on 2.0 litre 4 cylinder 163PS Diesel engine.



ADDED DRIVER CONFIDENCE



ALL SURFACE PROGRESS CONTROL*

ADAPTIVE SURFACE RESPONSE

Unique in this class of car, Jaguar's All Surface Progress Control (ASPC) technology is a low speed cruise control that helps XF to cope with low traction situations. ASPC allows the driver to concentrate on steering the vehicle. Once activated, you use the cruise control buttons to set a 'target' speed of between 3.6km/h and 30km/h. The system then works to achieve and maintain that speed while exerting optimum traction control.

ASPC is standard on all engines fitted with automatic transmissions and gives XF drivers added confidence over slippery, loose or icy surfaces, undulating terrain and even while descending a difficult incline. It helps make XF easy to drive in challenging conditions. ASPC also has a pull-away function allowing XF to progress from rest on low grip surfaces and ascending gradients, as well as a hill descent function that controls vehicle speed on steeper inclines.

On All Wheel Drive vehicles fitted with Adaptive Dynamics**, optional Adaptive Surface Response (AdSR) recognises differences between surfaces to exploit the maximum available grip. Drawing on Jaguar Land Rover's unrivalled expertise with All Wheel Drive systems, AdSR constantly monitors the car's environment and adjusts the appropriate engine and brake settings. Once selected, AdSR works at all speeds to support you in adverse weather and across challenging surfaces.

*Automatic transmission only.

**Standard on XF S, not available on 2.0 litre 4 cylinder 163PS Diesel engine.

With any given set of tyres, ASPC can accomplish comparable levels of traction to that achievable by an expert driver. Fitting All-season or Winter tyres to XF can improve capability on slippery surfaces.

GRAVEL



WET GRASS



SNOW/ICE



WET ROAD



HBS 991

XF



ADVANCED DRIVETRAIN TECHNOLOGY



ALL WHEEL DRIVE

INTELLIGENT DRIVELINE DYNAMICS

XF's All Wheel Drive (AWD) system combines the agility and character of Rear Wheel Drive (RWD) with the increased security and traction provided by AWD. In normal driving, XF is predominantly RWD to deliver handling purity, feel and balance. But when roads become more challenging, or when you accelerate more keenly on low-grip surfaces, the system subtly channels power forwards enabling XF to maintain optimum traction for comfortable progress in all conditions.

XF's AWD uses a transfer case at the back of the 8-speed Automatic Transmission to manage the appropriate distribution of torque to the front and rear wheels. Engineered to ensure that XF retains the dynamic behaviour of a Jaguar, the transfer case contains an electro-mechanically activated multi-plate clutch with an actuator to build hydraulic pressure. This pressure is quickly and accurately controlled to generate the required force in the clutch to transfer the optimal amount of torque to the front wheels.

Unlike other systems that react to wheel slip, Jaguar's Intelligent Driveline Dynamics (IDD) software is predictive and uses sensors measuring throttle and steering inputs to anticipate wheel slip. IDD seamlessly co-ordinates these inputs and compares them with responses from the engine, transmission and traction control systems to calculate the traction available and distribute torque accordingly even before grip is lost. From a standstill XF can transition from RWD to AWD in as little as 165 milliseconds or just 100 milliseconds when the car is moving. The result is a drive which blends the character of RWD with the capability of AWD, providing outstanding levels of performance and control whatever the road throws at you.

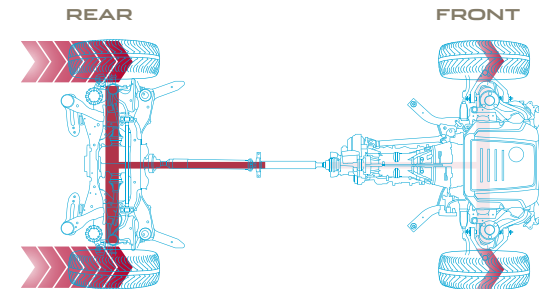

DRY ROAD CONDITIONS

In normal conditions, torque is distributed to the rear wheels, delivering acclaimed Jaguar agility and handling.

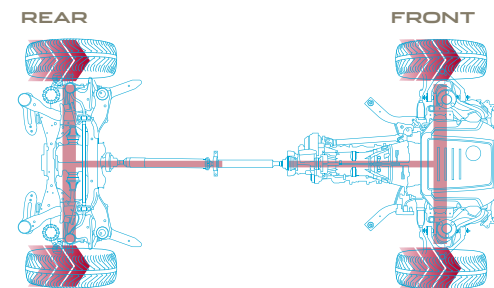

LOW TRACTION CONDITIONS

On slippery surfaces, such as grass and snow, torque can be balanced between the front and rear wheels to maximise traction.

In extreme conditions where only the front wheels have traction, up to 100 percent of engine torque can be distributed to the front wheels for optimum grip.

VEHICLE SHOWN: XF S IN YULONG WHITE WITH OPTIONAL FEATURES FITTED (MARKET DEPENDENT)



TORQUE VECTORING

➤ MAXIMISED CORNERING CAPABILITY

XF's Torque Vectoring by Braking maximises capability through even the tightest corners. Torque Vectoring technology provides controlled independent braking on the individual inside front and rear wheels to add to the turning forces acting on the car. In most conditions more braking pressure is applied to the rear inside wheel as this supports the most increased cornering capability, while the front inside wheel is braked for greater effectiveness and refinement. The result is reduced understeer for sharper turning and more consistent road holding. Torque Vectoring delivers increased sports car-like agility and added driver confidence.

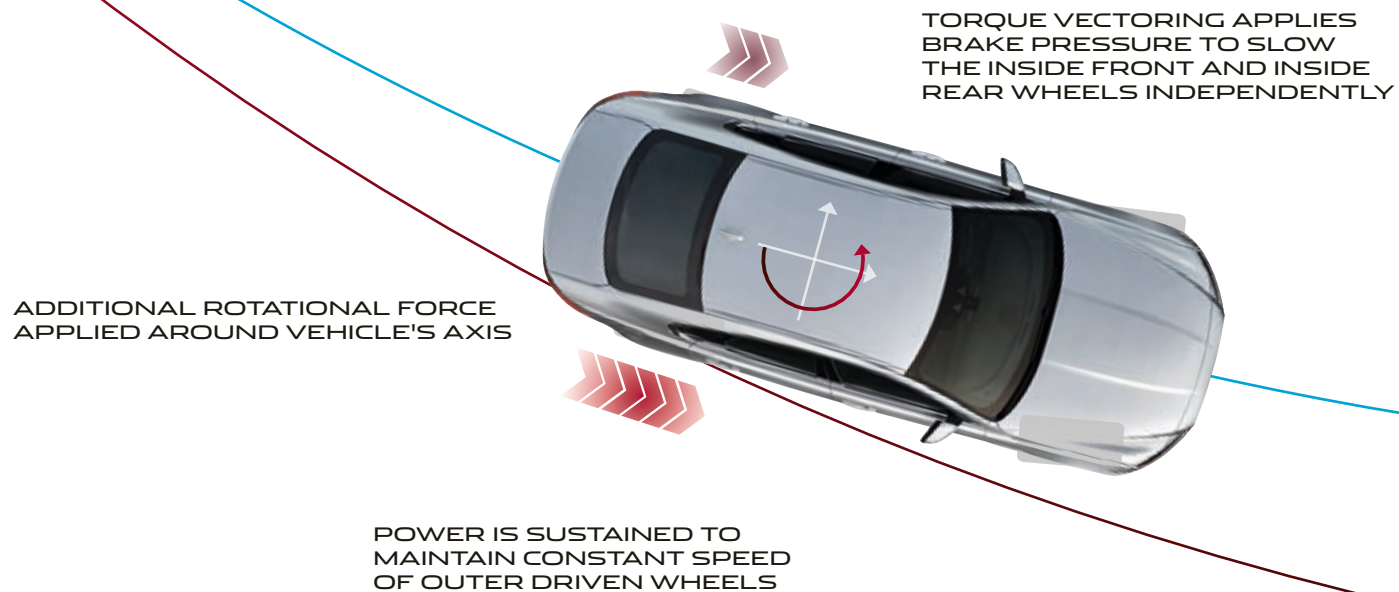

Graphical representation only.

VEHICLE SHOWN PREVIOUS PAGE: XF S IN YULONG WHITE WITH OPTIONAL FEATURES FITTED (MARKET DEPENDENT)



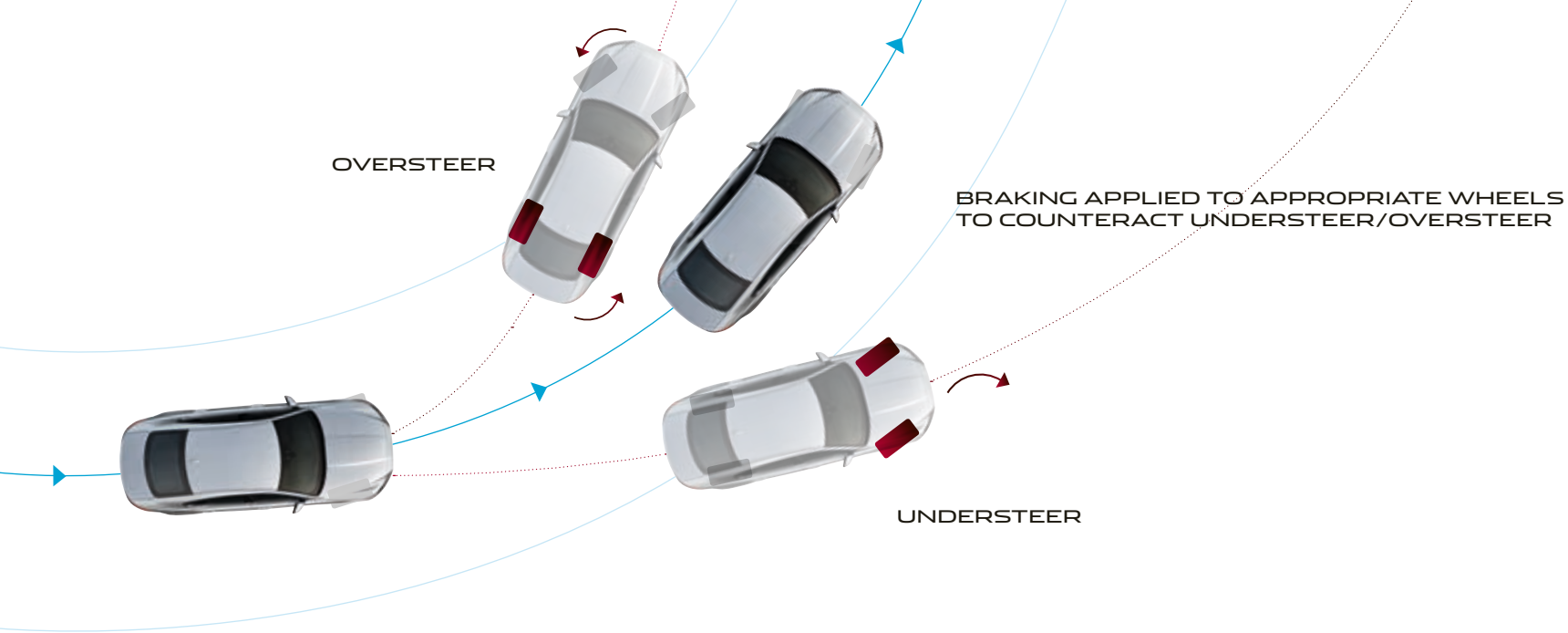

STABILITY AND CONTROL



DYNAMIC STABILITY CONTROL

ENGINE DRAG TORQUE CONTROL

TRAILER STABILITY ASSIST

Jaguar's Stability Systems keep XF safely balanced whether you're driving enthusiastically or simply want the assurance of a car that will remain stable in challenging conditions.

Dynamic Stability Control (DSC) monitors XF's dynamic behaviour, intervening to maximise vehicle stability and optimising available grip. DSC reduces engine torque and applies braking to the appropriate wheels to correct the car's direction of travel by counteracting understeer or oversteer. XF's DSC system has enhanced understeer control to reduce speed and regain control more effectively.

Engine Drag Torque Control (EDC) mitigates the chance of wheel lock-up caused by strong engine braking in slippery conditions. It acts by briefly increasing torque to the driven wheels as appropriate.

Trailer Stability Assist (TSA) gives you greater stability when towing. Should TSA detect a dangerous trailer sway situation is developing, it can help you regain control by gradually reducing XF's speed through lowering engine power and applying the brakes individually on each side of the vehicle to control the sway.

Graphical representation only.

VEHICLE SHOWN PREVIOUS PAGE: XF S IN YULONG WHITE WITH OPTIONAL FEATURES FITTED (MARKET DEPENDENT)



95
90 km/h 100

Darkness
Oliver Daldry
Darkness
6/12

140 160 180 200 220 240 260 280 300
km/h
90
95 km/h

rpm x 1000
5

17:06

15°C

SET +



HEAD-UP DISPLAY

➤ HEAD-UP DISPLAY WITH LASER TECHNOLOGY

The optional Head-up Display (HUD)* with laser technology projects key information onto the windscreen. Remaining clear even in direct sunlight, the crisp, bright image can display vehicle speed, navigation, cruise control notifications and Traffic Sign Recognition data, where available. This technology helps you minimise time spent looking down at the instrument cluster and can help you maintain continuous awareness of the car's speed.

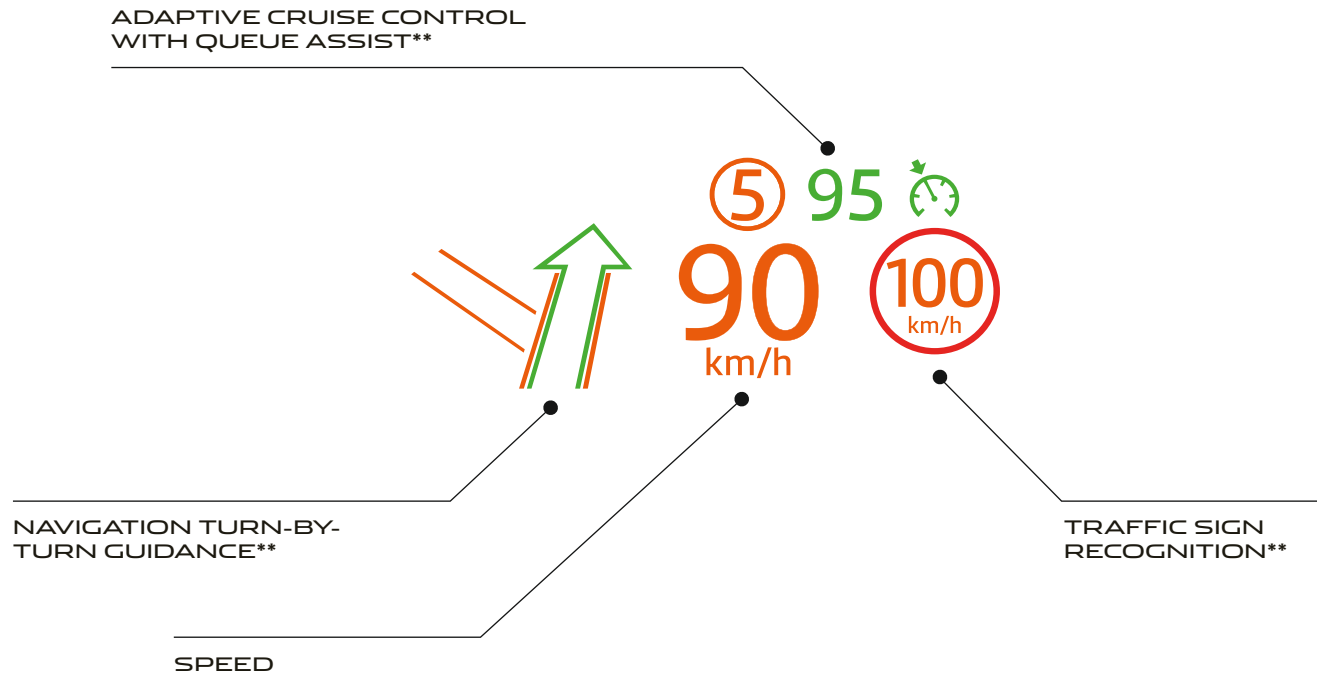

*Requires Infrared Reflective windscreen to be fitted.
**Optional features with fitment market dependent.

INCONTROL TECHNOLOGIES INFOTAINMENT AND CONNECTIVITY

 TOUCH | TOUCH PRO

InControl* is our suite of advanced technologies that links both you and your XF to the wider world. Choose from two InControl infotainment systems: Touch, available as standard, or upgrade to Touch Pro. These can be further enhanced by adding their respective connectivity packages, Connect and Connect Pro**.

*As we roll out InControl, specific features described may be optional, and market or powertrain dependent. Please consult your country-specific Jaguar website or local Jaguar Retailer for availability and full terms in your country. Certain features require an appropriate SIM with a suitable data contract which will require further subscription after the initial term advised by your Retailer. Mobile connectivity cannot be guaranteed in all locations.

**In selected markets where Navigation Pro is fitted you must select all the features of Connect Pro. Please consult your local Jaguar Retailer for further details.

†Only available with InControl Apps or Connect Pro (see optional connectivity packages for Touch Pro).

Third Party programmes or applications may require an end user license from the supplier.



TOUCH



STANDARD ON EVERY XF

8" Touchscreen

Instrument Cluster with 5" Central TFT Display

Jaguar Sound System (80W)

AM/FM Radio

USB, Bluetooth® and AUX connections



Protect consists of SOS Emergency Call, Jaguar Optimised Assistance and Remote Essentials smartphone app



OPTIONAL

Connect consists of InControl Apps, Remote Premium smartphone app and Wi-Fi Hotspot



Secure Tracker provides Stolen Vehicle Monitoring and notifications via your smartphone and the secure call centre

ADDITIONAL OPTIONS

Meridian™ Sound System (380W)

Navigation

DAB Radio

InControl Apps



TOUCH PRO



AVAILABLE AS AN UPGRADE

10.2" Touchscreen with multi-touch gestures and customisable homescreen

12.3" Instrument Panel Display with virtual dials and full screen 3D Map View

Navigation Pro

Meridian™ Sound System (380W)

AM/FM Radio, Bluetooth® and 2 x USB connections

10GB of usable memory

CD/DVD Drive



Protect consists of SOS Emergency Call, Jaguar Optimised Assistance and Remote Essentials smartphone app



OPTIONAL

Connect Pro** consists of InControl Apps, Remote Premium smartphone app, Wi-Fi Hotspot and Pro Services including Real Time Traffic information



Secure Tracker provides Stolen Vehicle Monitoring and notifications via your smartphone and the secure call centre

ADDITIONAL OPTIONS

Meridian™ Surround Sound System (825W)

Digital TV, HDMI⁺, MHL⁺

DAB Radio

Dual View

InControl Apps



8" TOUCHSCREEN SHOWN AT ACTUAL SIZE

Audio	Standard: Jaguar Sound System (80W) Optional: Meridian™ Sound System (380W)
Navigation Guidance	Navigation*
Display	8" Touchscreen
Multimedia	AM/FM and DAB Radio*. 1 x USB, Bluetooth® and 1 x AUX connection
Standard InControl Package	Protect consists of SOS Emergency Call, Jaguar Optimised Assistance and Remote Essentials smartphone app
Optional Connectivity Package	Connect consists of InControl Apps, Remote Premium smartphone app and Wi-Fi Hotspot

*Optional features.

**Optional feature, availability and fitment is market dependent.

TOUCH



ADVANCED INFOTAINMENT AS STANDARD

The Touch multimedia system is XF's hub for connectivity, control and entertainment. The key features are:

8" Touchscreen at the heart of the centre console. Clear and responsive graphical interface for quick control.

Easy to use Touchscreen responds directly to touch and swipe gestures.

Navigation guidance* makes planning journeys and following routes easy, thanks to turn-by-turn voice guidance and junction view. 'Dead-reckoning' functionality can accurately position the vehicle even when GPS signals can no longer be received – perfect for city centres or driving through tunnels.

Bluetooth phone connectivity allows you to link and control your smartphone via Touch either for phone calls or music playback: simple, easy and wire-free.

Access a world of music thanks to AM/FM, DAB Radio*, as well as USB and AUX connections.

Integrated text-to-voice* technology reduces distraction by reading out incoming text messages. You can easily respond with short, prepared messages.

Precise climate control is available via the Touchscreen. Adjust temperature levels, direction and intensity of airflow and operate heated or cooled seats (if fitted).

CONNECT



OPTIONAL CONNECTIVITY PACKAGE

Connect* is a bundle of technologies and applications that takes your XF's connectivity to the next level.

InControl Apps features a range of bespoke Jaguar approved apps that can be connected to the car from your smartphone. It ensures the safe and convenient use of these apps that have been optimised specifically to enhance aspects of your in-car experience.

Wi-Fi Hotspot gives you the option to create a 3G hotspot using the car's antenna when you fit a SIM card. This strengthens your link to the outside world, for a more stable connection than an individual device could maintain. Connect up to eight devices to read emails, browse the web and download content.

Remote Premium is a multi-function app that allows you to monitor as well as interact with your XF from your smartphone. Remote start the engine** to pre-condition the climate, lock and unlock the car, locate your XF on a map or by using the beep and flash function, and track your journeys – all via the app.



Explore InControl at jaguar.com/incontrol

As we roll out InControl, specific features described may be optional, and market or powertrain dependent. Please consult your country-specific Jaguar website or local Jaguar Retailer for availability and full terms in your country. Certain features require an appropriate SIM with a suitable data contract which will require further subscription after the initial term advised by your Retailer. Mobile connectivity cannot be guaranteed in all locations.



10.2" TOUCHSCREEN SHOWN AT ACTUAL SIZE

Audio	Standard: Meridian™ Sound System (380W) Optional: Meridian™ Surround Sound System (825W)
Navigation Guidance	Navigation Pro
Display	10.2" Touchscreen
Multimedia	AM/FM and DAB Radio*, Dual View*, Bluetooth®, HDMI**, MHL** and 2 x USB connections. Digital TV*, 10GB of usable memory and CD/DVD Drive
Standard InControl Package	Protect consists of SOS Emergency Call, Jaguar Optimised Assistance and Remote Essentials
Optional Connectivity Packages	Connect Pro+ consists of InControl Apps, Remote Premium, Wi-Fi Hotspot and Pro Services (including Route Planner Companion App, share your destination and ETA, Commute Mode, Arrival Mode, Real Time Traffic information and fuel and parking services)



12.3" Full Digital Instrument Panel with virtual dials

*Optional features.

**Only available with InControl Apps or Connect Pro (see optional connectivity packages for Touch Pro).

*In selected markets where Navigation Pro is fitted you must select all the features of Connect Pro. Please consult your local Jaguar Retailer for further details.

TOUCH PRO

UPGRADE TO NEXT GENERATION INFOTAINMENT

Touch Pro's next-generation hardware and software advances XF's connectivity and entertainment to the very highest level. Touch Pro's features replace or enhance those found in Touch. The key aspects of Touch Pro are:

Larger, highly-responsive, 10.2" Touchscreen at the heart of the centre console with customisable homescreen and lightning fast response times. Its interactive side panel makes multi-tasking easy.

Pinpoint touch control allows you to manipulate and interact with information swiftly and seamlessly. The Touchscreen responds in the same manner as a smartphone or tablet computer, providing multi-touch gestures such as pinch to zoom and swipe.

12.3" Instrument Panel Display with Virtual Dials and full screen 3D Map View makes driving even more of a pleasure. It is housed in the instrument display directly in front of the driver. Select full screen 3D Map View or choose one of four graphical themes to suit your personal preference.

Enhanced Navigation with faster response times. One of the many innovative features of Touch Pro's Navigation is that it allows you to set a destination and the system alerts you if you have insufficient fuel for the journey. It then displays filling stations on the part of the route where you may be low on fuel. The system automatically displays parking options.

Personal media storage of 10GB of usable memory for your music and movies. 'Plug and play' using the two USB ports allowing for fast transfer speeds.

Dual View* allows the front passenger and driver to enjoy different media on the same 10.2" Touchscreen. For example, the front passenger can watch a film (listening to the audio with wireless headphones) while the driver views navigation.



Explore InControl at jaguar.com/incontrol

As we roll out InControl, specific features described may be optional, and market or powertrain dependent. Please consult your country-specific Jaguar website or local Jaguar Retailer for availability and full terms in your country. Certain features require an appropriate SIM with a suitable data contract which will require further subscription after the initial term advised by your Retailer. Mobile connectivity cannot be guaranteed in all locations.

CONNECT PRO

OPTIONAL ENHANCED CONNECTIVITY PACKAGE†

Connect Pro's services, technologies and applications give you the very best in connectivity and convenience. It offers all the benefits of Connect (see pg. 43) plus many more features, including:

Route Planner Companion App offers true door-to-door navigation. Pre-plan your destination and route via your Apple or Android smartphone. The app will guide you to your car, where you will find your selected route available on the car's Touchscreen. When you've completed your road journey, the app can guide you by foot or public transport (where supported) to your destination.

Real Time Traffic uses millions of live traffic data feeds to give a highly accurate picture of traffic on the way to your destination, helping you choose the best route. As you progress, the system continues to monitor live traffic conditions, and can automatically reroute you to help avoid congestion.

Share your estimated time of arrival so your selected contact(s) will know exactly when you will arrive, as calculated by the navigation guidance system. If you're running late, the system can then send automatic updates via text or email, without any further action from you.

Commute Mode allows the system to learn your commutes and automatically advises you of the expected journey time based on live and historical traffic movements. The system learns the routes you take for a given destination and then advises which of those is the quickest.

Arrival Mode displays interactive 360° street level imagery of your destination for seamless finishes to journeys. It automatically displays again upon your arrival. You then simply tap the Touchscreen to select a nearby car park, which appears as an updated destination.

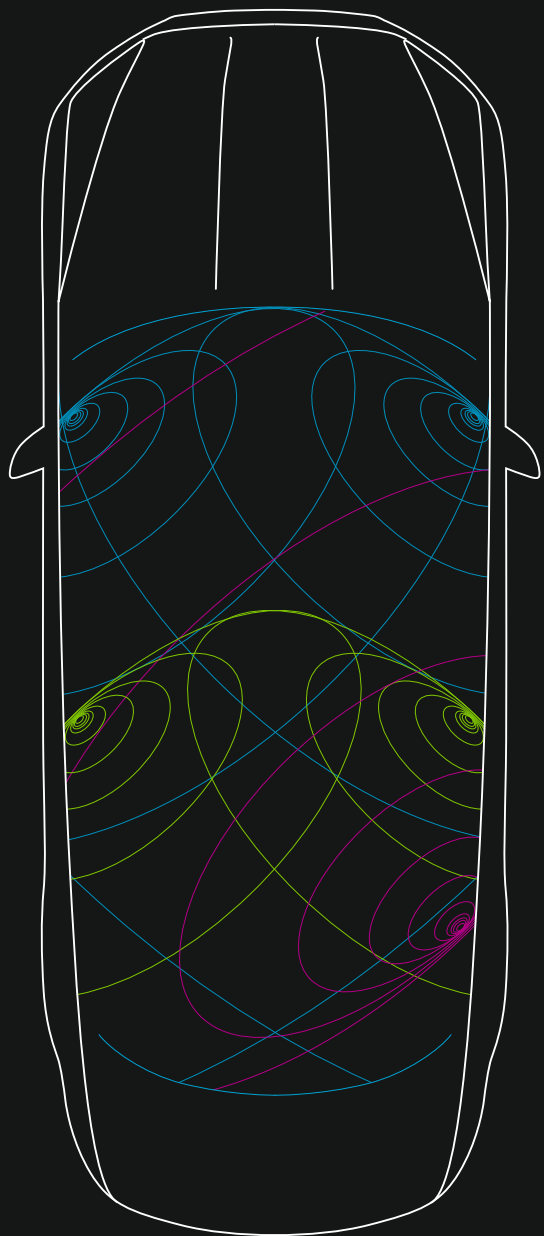

AUDIO

 **JAGUAR
SOUND SYSTEM**

**MERIDIAN™
SOUND SYSTEMS**

XF's superb sound systems bring your music to life. The Jaguar Sound System provides acoustic range through 8 speakers. Offering an enhanced listening experience are the optional Meridian™ Sound Systems. Designed in conjunction with the British audio experts Meridian™, these systems use innovative audio technology and precise speaker placement to give perfectly optimised sound quality.

Choose from a range of sound systems, including the new 380W Sound System with 11 speakers or the 825W Surround Sound System with 17 speakers. All ensure that, wherever you or your passengers sit in your XF, everyone will enjoy a rich, enveloping audio experience.



-  Fresh air subwoofer
-  Front door waves tweeter midrange bass
-  Rear door waves tweeter midrange

Diagram representative of Meridian™ 380W Sound System.



MERIDIAN

SOUND SYSTEMS AVAILABLE IN CONJUNCTION WITH **TOUCH**

Standard

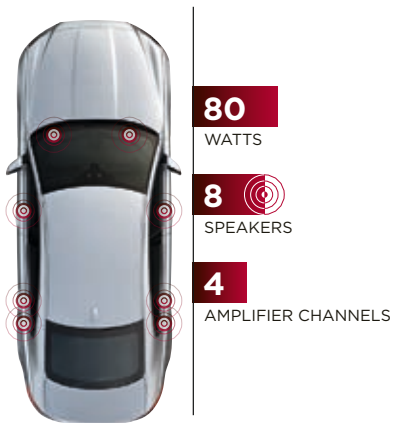

JAGUAR SOUND SYSTEM

Speed Dependent Volume*
80 watts
8 speakers
4 amplifier channels

Optional

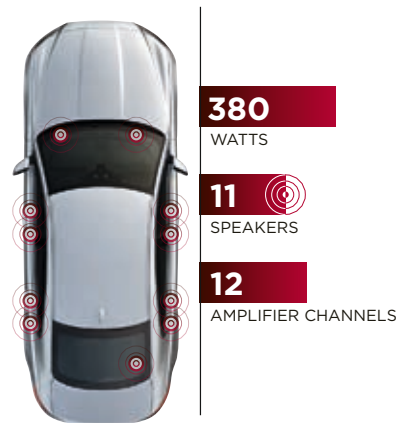

MERIDIAN™ SOUND SYSTEM

DSP amplifier
Speed Dependent Volume*
380 watts
11 speakers
12 amplifier channels

SOUND SYSTEMS AVAILABLE IN CONJUNCTION WITH **TOUCH PRO**

Standard

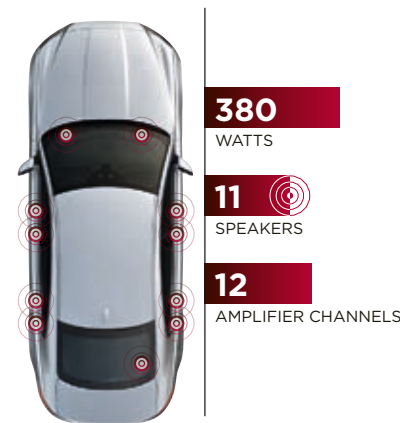

MERIDIAN™ SOUND SYSTEM

DSP amplifier
Audyssey MultEQ Audio Equalisation
Dynamic Volume Control**
380 watts
11 speakers
12 amplifier channels

Optional

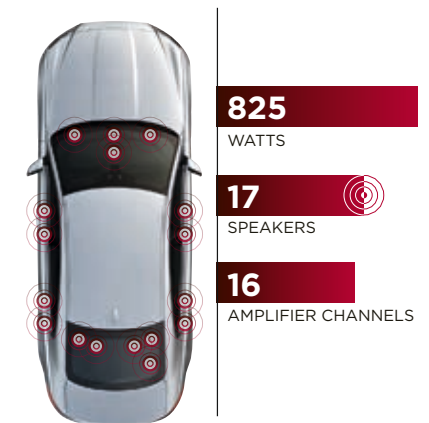

MERIDIAN™ SURROUND SOUND SYSTEM

DSP amplifier
Audyssey MultEQ Audio Equalisation
Dynamic Volume Control**
825 watts
17 speakers
16 amplifier channels

*Automatically adjusts as vehicle speed changes.

**Automatically adjusts as vehicle speed changes and/or ambient noise levels change.

VEHICLE SHOWN: XF PRESTIGE IN INDUS SILVER WITH OPTIONAL FEATURES FITTED (MARKET DEPENDENT)

SAFETY

ADVANCED DRIVER ASSISTANCE



1 AUTONOMOUS EMERGENCY BRAKING*

Should a potential collision be detected, XF gives an audible forward collision warning. Visual warnings follow. If the driver takes no action the system applies the brakes to help reduce the severity of the possible impact.

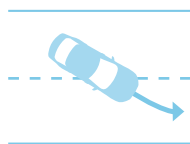

2 LANE DEPARTURE WARNING*

Lane Departure Warning notifies the driver with a visual alert and a gentle vibration of the steering wheel should the car detect an unintentional drift from its lane, helping to keep everyone on board safe.

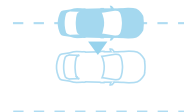

3 LANE KEEP ASSIST AND DRIVER CONDITION MONITOR**

Building on Lane Departure Warning, Lane Keep Assist (LKA) senses unintentional lane drift and helps steer XF back into its lane. Driver Condition Monitor (DCM) detects lapses in concentration due to tiredness by monitoring driver inputs and suggests taking a break via an audible alert and a visual notification in the instrument cluster.



4 TRAFFIC SIGN RECOGNITION WITH ADAPTIVE SPEED LIMITER**

Traffic Sign Recognition (TSR) technology detects speed limits, including variable limits, and no overtaking signs via the forward-facing camera, then displays them to the driver. The Adaptive Speed Limiter uses TSR's information, supported by map data from the optional navigation system, to help keep XF within the appropriate speed limit.



5 PARK ASSIST**

Park Assist makes parking in tight spaces easier than ever. XF can accurately steer itself during both parallel and bay parking manoeuvres – the driver only has to control the brakes and accelerator. An exit-assist function can help guide XF while leaving a parallel space.



6 BLIND SPOT ASSIST AND REVERSE TRAFFIC DETECTION**

If your car detects another vehicle in or quickly approaching your blind spot, the Blind Spot Monitor system alerts you via a small warning light in the corresponding exterior mirror. As an enhancement to this, Blind Spot Assist will apply steering torque to guide you away from the vehicle in your blind spot if you begin to change lanes. Using the same radar system, Reverse Traffic Detection alerts you via the Touchscreen of moving vehicles during reversing – for example, when leaving a parking bay with restricted vision.

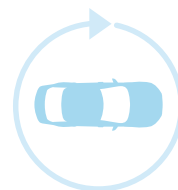

7 SURROUND CAMERA SYSTEM**

Helping with various manoeuvres, from parking by a kerb to getting in and out of tight spaces and junctions, Surround Camera System gives you 360° exterior vision on the Touchscreen. To enhance this system further, new Forward Vehicle Guidance and Forward Traffic Detection are also included. Forming part of the Surround Camera System, Forward Vehicle Guidance provides the driver with an on-screen visualisation of the vehicle and parking distance. Forward Traffic Detection helps avoid potential collisions in situations where forward manoeuvres involve restricted views.

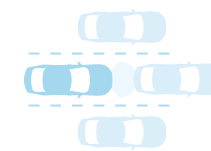

8 ADAPTIVE CRUISE CONTROL WITH QUEUE ASSIST**

Adaptive Cruise Control[†] uses radar technology to automatically adjust your speed to maintain a safe distance from the vehicle ahead. If that vehicle slows, your XF reduces its speed to maintain a safe distance. XF resumes its pre-set speed as soon as the road in front is clear. Should the car in front stop completely, the Queue Assist function brings XF to a smooth halt. Once the traffic moves off, touch the accelerator and XF will follow the car in front again.

*Standard feature.

**Optional features, availability is market dependent.

[†]Only available with automatic transmission.

Please refer to page 61 for fitment requirements.

VEHICLE SHOWN: XF PRESTIGE IN INDUS SILVER WITH OPTIONAL FEATURES FITTED (MARKET DEPENDENT)

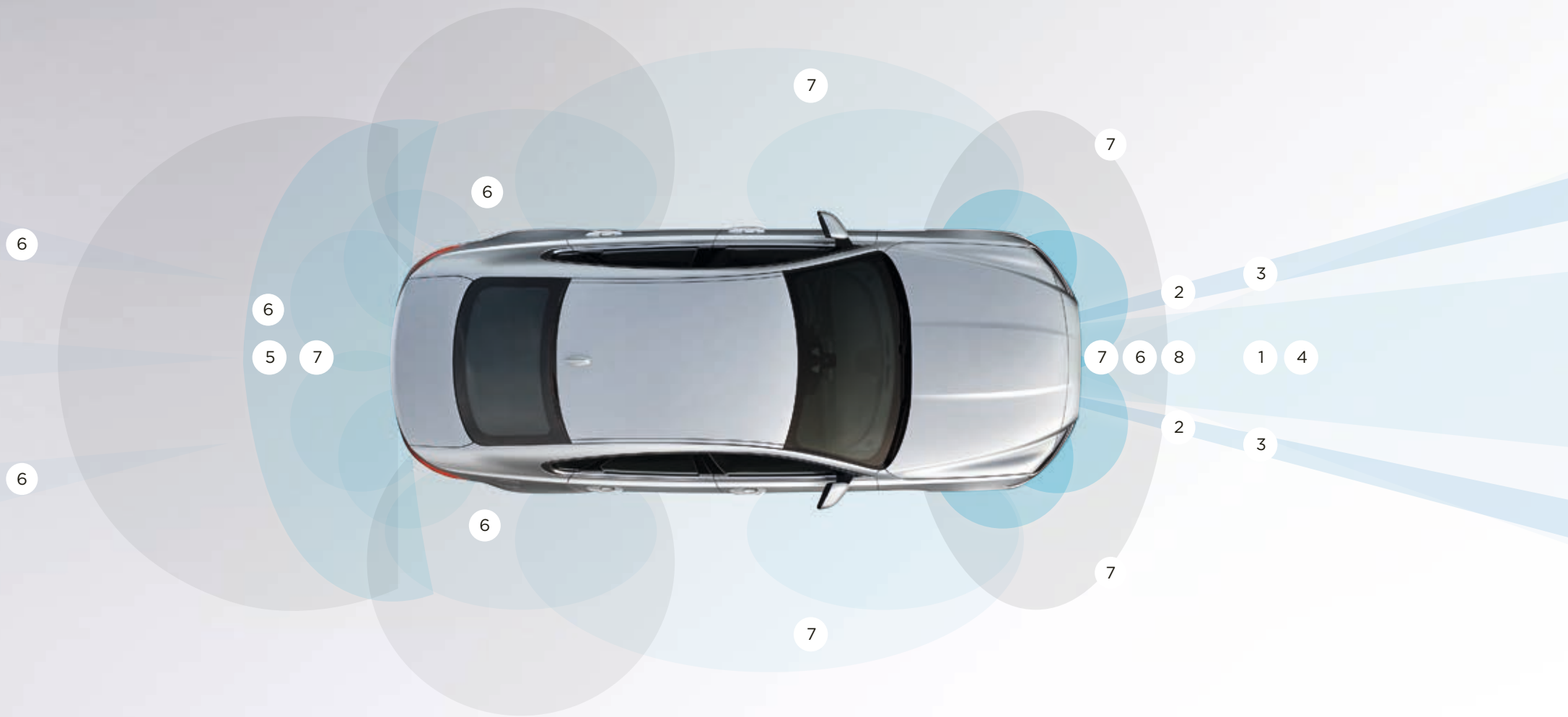

Graphical representation only.

PERSONALISATION XF - YOUR CHOICE



Configure your vehicle at jaguar.com



CHOOSE YOUR ENGINE

Page 52

Select one of XF's powerful, efficient petrol or diesel engines to suit your driving style.

CHOOSE YOUR MODEL & OPTIONS

Page 54

Compare the wealth of standard features and options on XF models.

CHOOSE YOUR COLOUR

Page 64

Express your individuality with one of XF's stunning exterior colours.

CHOOSE YOUR WHEELS

Page 66

Add the personal finishing touch to your new XF, and complement its stunning style, with a set of beautifully designed alloy wheels.

CHOOSE YOUR INTERIOR

Page 68

There's a wide selection of premium materials, leathers, veneers and finishes for every personal taste.

CHOOSE YOUR JAGUAR GEAR ACCESSORIES

Page 86

Really make it yours by adding style, practicality and versatility with official XF Gear Accessories from your local Jaguar Retailer.

1 CHOOSE YOUR ENGINE

 Configure your vehicle at jaguar.com

> DIESEL ENGINES

2.0 LITRE

4 CYLINDER TURBOCHARGED
E-PERFORMANCE

MAXIMUM POWER 163PS
MAXIMUM TORQUE 380Nm
ACCELERATION 0-100 km/h 8.7 seconds
TOP SPEED Manual 229 km/h Automatic 227 km/h
COMBINED FUEL CONSUMPTION Manual 4.0 l/100km Automatic 4.1 l/100km
COMBINED CO ₂ Manual 104 g/km Automatic 109 g/km
PURE, PRESTIGE, PORTFOLIO, R-SPORT

2.0 LITRE

4 CYLINDER TURBOCHARGED

MAXIMUM POWER 180PS
MAXIMUM TORQUE 430Nm
ACCELERATION 0-100 km/h Manual RWD 8.0 seconds Automatic RWD 8.1 seconds Automatic AWD 8.4 seconds
TOP SPEED Manual RWD 230 km/h Automatic RWD 229 km/h Automatic AWD 222 km/h
COMBINED FUEL CONSUMPTION RWD 4.3 l/100km AWD 4.9 l/100km
COMBINED CO ₂ RWD 114 g/km AWD 129 g/km
PURE, PRESTIGE, PORTFOLIO, R-SPORT

2.0 LITRE

4 CYLINDER TWIN TURBOCHARGED

MAXIMUM POWER 240PS
MAXIMUM TORQUE 500Nm
ACCELERATION 0-100 km/h 6.5 seconds
TOP SPEED 246 km/h
COMBINED FUEL CONSUMPTION RWD 5.3 l/100km AWD 5.5 l/100km
COMBINED CO ₂ RWD 139 g/km AWD 144 g/km
PURE, PRESTIGE, PORTFOLIO, R-SPORT

3.0 LITRE V6

TWIN TURBOCHARGED

MAXIMUM POWER 300PS
MAXIMUM TORQUE 700Nm
ACCELERATION 0-100 km/h 6.2 seconds
TOP SPEED 250 km/h
COMBINED FUEL CONSUMPTION 5.5 l/100km
COMBINED CO ₂ 144 g/km
PRESTIGE, PORTFOLIO, R-SPORT, S



MANUAL
0-100 KM/H



AUTOMATIC
0-100 KM/H



MANUAL RWD
0-100 KM/H



AUTOMATIC RWD
0-100 KM/H



AUTOMATIC AWD
0-100 KM/H



0-100 KM/H



0-100 KM/H



MANUAL
TOP SPEED KM/H



AUTOMATIC
TOP SPEED KM/H



MANUAL RWD
TOP SPEED KM/H



AUTOMATIC RWD
TOP SPEED KM/H



AUTOMATIC AWD
TOP SPEED KM/H



TOP SPEED KM/H



TOP SPEED KM/H

Please refer to Technical Specification pages for full fuel consumption figures.
The figures provided are as a result of official manufacturer's tests in accordance with EU legislation.
A vehicle's actual fuel consumption may differ from that achieved in such tests and these figures are for comparative purposes only.

> PETROL ENGINES

2.0 LITRE

4 CYLINDER TURBOCHARGED

MAXIMUM POWER 200PS

MAXIMUM TORQUE 320Nm

ACCELERATION 0-100 km/h 7.5 seconds

TOP SPEED 235 km/h

COMBINED FUEL CONSUMPTION 6.8 l/100km

COMBINED CO₂ 154 g/km

PURE, PRESTIGE, PORTFOLIO, R-SPORT



0-100 KM/H



TOP SPEED KM/H

2.0 LITRE

4 CYLINDER TURBOCHARGED

MAXIMUM POWER 250PS

MAXIMUM TORQUE 365Nm

ACCELERATION 0-100 km/h 6.6 seconds

TOP SPEED Automatic RWD 244 km/h
Automatic AWD 237 km/h

COMBINED FUEL CONSUMPTION
RWD 6.8 l/100km AWD 6.9 l/100km

COMBINED CO₂ RWD 154 g/km AWD 159 g/km

PURE, PRESTIGE, PORTFOLIO, R-SPORT



AUTOMATIC RWD
0-100 KM/H



AUTOMATIC AWD
0-100 KM/H

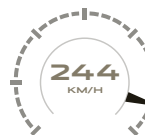

AUTOMATIC RWD
TOP SPEED KM/H



AUTOMATIC AWD
TOP SPEED KM/H

3.0 LITRE V6

SUPERCHARGED

MAXIMUM POWER 340PS

MAXIMUM TORQUE 450Nm

ACCELERATION 0-100 km/h 5.4 seconds

TOP SPEED 250 km/h

COMBINED FUEL CONSUMPTION
RWD 8.3 l/100km AWD 8.6 l/100km

COMBINED CO₂ RWD 198 g/km AWD 204 g/km

PURE, PRESTIGE, PORTFOLIO, R-SPORT



0-100 KM/H



TOP SPEED KM/H

3.0 LITRE V6

SUPERCHARGED

MAXIMUM POWER 380PS

MAXIMUM TORQUE 450Nm

ACCELERATION 0-100 km/h 5.3 seconds

TOP SPEED 250 km/h

COMBINED FUEL CONSUMPTION
RWD 8.3 l/100km AWD 8.6 l/100km

COMBINED CO₂ RWD 198 g/km AWD 204 g/km

S



0-100 KM/H



TOP SPEED KM/H

2 CHOOSE YOUR MODEL

 Configure your vehicle at jaguar.com

LUXURY



PURE

KEY FEATURES

- 17" alloy wheels (18" alloy wheels on V6 engines)
- Halogen headlights
- Premium fabric seats
- 10-way electric front seats*
- Gloss Black veneer
- Morse Code Aluminium instrument panel finisher
- All Surface Progress Control (Automatic Transmission only)



PRESTIGE

KEY FEATURES (IN ADDITION TO PURE)

- Bi-functional Xenon headlights with LED 'J' blade Daytime Running Lights and power wash
- Grained leather seats
- Rear armrest with cupholders
- Soft grain leather sport steering wheel
- Carpet mats
- Interior mood lighting



PORTFOLIO

KEY FEATURES (IN ADDITION TO PRESTIGE)

- 18" alloy wheels (17" alloy wheels on 2.0 litre 4 cylinder 163PS Diesel engine)
- Windsor leather seats
- Windsor leather instrument panel finisher
- Gloss Figured Ebony veneer

*8-way manual front seats with electric recline standard on XF Pure 2.0 litre 4 cylinder 163PS Diesel engine.

Images feature optional equipment.

Please note that standard features may be replaced when selecting alternative trim levels.

Standard features may also vary depending on country of purchase, engine variant and transmission, please refer to Specification and Price Guide or website for your local market.

> SPORT



R-SPORT

KEY FEATURES (IN ADDITION TO PRESTIGE)

18" alloy wheels (17" alloy wheels on 2.0 litre 4 cylinder 163PS Diesel engine)

R-Sport body kit including sports front bumper, side sills and boot mounted spoiler

Sports suspension (only available on Ingenium 2.0 litre Petrol 200PS and 250PS RWD engines and Ingenium Diesel 180PS and 240PS RWD engines)

Sports Grained leather seats with technical mesh inserts

Metal treadplates and multi-function steering wheel with R-Sport branding

Gloss Black side window surround

Dark Morse Code Aluminium instrument panel finisher



S

KEY FEATURES (IN ADDITION TO R-SPORT)

19" alloy wheels

S body kit including sports front bumper, Gloss Black side sills, rear valance and boot mounted spoiler

Red brake calipers

Sports Grained leather S embossed seats with suedecloth inserts

Grey Figured Ebony veneer

Dark Hex Aluminium instrument panel finisher

Bright sport pedals

Metal treadplates and multi-function steering wheel with S branding

Adaptive Dynamics

2 CHOOSE YOUR OPTIONS

 Configure your vehicle at jaguar.com

KEY STANDARD FEATURES

	PURE	PRESTIGE	PORTFOLIO	R-SPORT	S	DESCRIPTION
Intelligent Stop/Start system	●	●	●	●	●	Refer to page 18
Hill Launch Assist	●	●	●	●	●	Prevents your XF from rolling backwards when pulling away on an incline, helping you to make the perfect hill start every time
JaguarDrive Control with Eco, Dynamic, Normal and Rain Ice Snow Mode	●	●	●	●	●	Refer to page 18
Electric Power Assisted Steering (EPAS)	●	●	●	●	●	Refer to page 28
Electric Park Brake with drive away release	●	●	●	●	●	Automatically releases the parking brake without the need for driver input as you press the accelerator to drive away
Emergency Brake Assist	●	●	●	●	●	Increases braking pressure in an emergency situation
Autonomous Emergency Braking	●	●	●	●	●	Refer to page 48
Hazard lights under heavy braking	●	●	●	●	●	
Airbags	●	●	●	●	●	Driver and front passenger with seat occupant detector for passenger, front side and full length side window curtain
Torque Vectoring	●	●	●	●	●	Refer to page 35
Dynamic Stability Control and Traction Control	●	●	●	●	●	Refer to page 37
Cruise Control with Speed Limiter	●	●	●	●	●	
Lane Departure Warning	●	●	●	●	●	Refer to page 48
Trailer Stability Assist	●	●	●	●	●	Intervenes when the system detects sway or potentially dangerous movement to bring the trailer back under control
Electric front and rear windows with one-touch open/close and anti-trap	●	●	●	●	●	
Rain sensing windscreen wipers	●	●	●	●	●	
Body-coloured, heated, electric exterior door mirror	●	●	●	●	●	
Two-zone Climate Control	●	●	●	●	●	
USB, Auxiliary socket and iPod® connectivity	●	●	●	●	●	Refer to page 41
Bluetooth® telephone connectivity	●	●	●	●	●	Refer to page 41
Bluetooth® streaming	●	●	●	●	●	Refer to page 41
Interior lighting	●	●	●	●	●	
Jaguar Smart Key System – Keyless Start	●	●	●	●	●	
Partial LED tail lights	●	●	●	●	●	
ISOFIX anchor points for rear child seats	●	●	●	●	●	
Heated rear windscreen	●	●	●	●	●	
Power operated child locks	●	●	●	●	●	

● Standard ○ Option — Not available ■ Part of Pack

Please consult your local Jaguar Retailer for details.

For a complete list of optional features and packs refer to the XF Specification and Price Guide or configure your vehicle at jaguar.com

KEY OPTIONAL FEATURES

		PURE	PRESTIGE	PORTFOLIO	R-SPORT	S	
DYNAMIC FEATURES							DESCRIPTION
6-speed Manual Transmission with Optimal Shift Indicator (only available on 2.0 litre 4 cylinder Diesel engines)		●	●	●	●	—	
8-speed Automatic Transmission with Jaguar Sequential Shift, gearshift paddles and All Surface Progress Control		○	○	○	○	●	
Sports suspension upgrade (only available on 2.0 litre 4 cylinder Petrol 200PS and 250PS RWD engines and 2.0 litre 4 cylinder Diesel 180PS and 240PS RWD engines)		—	—	—	●	—	Adds sports springs and dampers
Adaptive Dynamics (not available on 2.0 litre 4 cylinder 163PS Diesel engine. Includes Configurable Dynamics on automatic transmission)	C35A	○	○	○	○	●	Refer to page 27 and 28
Configurable Dynamics (not available with 163PS Diesel engine or manual transmission)	G75A	○	○	○	○	●	Refer to page 28
Adaptive Cruise Control with Queue Assist (requires automatic transmission)	H41F	○	○	○	○	○	Refer to page 48
Adaptive Surface Response (replaces Rain Ice Snow Mode, requires AWD, automatic transmission and Adaptive Dynamics)	B73G	—	○	○	○	○	Refer to page 30
350mm brakes (option only on 2.0 litre 4 cylinder 180PS and 240PS Diesel engines and 2.0 litre 4 cylinder 250PS Petrol engine. Standard on V6)	G36B	○	○	○	○	●	

EXTERIOR FEATURES AND FINISHERS

EXTERIOR FEATURES AND TRIM							
Electric tilt/slide sunroof	F45C	○	○	○	○	○	
Powered Boot Lid	B69B	○	○	○	○	○	
Powered Gesture Boot Lid (requires Keyless Entry and Rear Park Aid)	B69C	○	○	○	○	○	Refer to page 9
Soft door close (requires Keyless Entry)	G45B	○	○	○	○	○	Automatically ensures that doors close softly, securely and with minimum exertion
Chrome radiator grille with Chrome surround	G12V	—	○	○	—	—	
Chrome side window surround	D53C	●	●	●	○	○	
Gloss Black side window surround		—	■	■	●	●	Part of Black Pack
R-Sport body kit		—	—	—	●	—	Includes R-Sport front bumper, body-coloured side sills and boot lid mounted spoiler, Satin Chrome side power vents with R-Sport badge
S body kit		—	—	—	—	●	Includes S front bumper, Gloss Black side sills and rear valance, body-coloured boot lid mounted spoiler, Satin Chrome side power vents
Engine de-badging	B05H	○	○	○	○	—	Removes engine badging

2 CHOOSE YOUR OPTIONS

 Configure your vehicle at jaguar.com

EXTERIOR FEATURES AND FINISHERS CONTINUED

		PURE	PRESTIGE	PORTFOLIO	R-SPORT	S	
GLASS AND EXTERIOR MIRRORS							DESCRIPTION
Infrared reflective windscreen (front screen only)	D97B	<input type="radio"/>	<input type="radio"/>	<input type="radio"/>	<input type="radio"/>	<input type="radio"/>	Filters sunlight to reduce glare and prevent harmful UV rays from entering the cabin
Heated front windscreen with heated washer jets	D96A	<input type="radio"/>	<input type="radio"/>	<input type="radio"/>	<input type="radio"/>	<input type="radio"/>	
Privacy glass	H75A	<input type="radio"/>	<input type="radio"/>	<input type="radio"/>	<input type="radio"/>	<input type="radio"/>	
Auto-dimming heated door mirrors with power fold and approach lights (requires auto-dimming interior rear view mirror)	B28P	<input type="radio"/>	<input type="radio"/>	<input type="radio"/>	<input type="radio"/>	<input type="radio"/>	
HEADLIGHTS AND LIGHTING							
Halogen headlights with Daytime Running Lights		●	—	—	—	—	
Bi-function Xenon headlights with LED 'J' blade Daytime Running Lights, automatic levelling and headlight power wash	D90L	<input type="radio"/>	●	●	●	●	
LED headlights with LED 'J' blade Daytime Running Lights, adaptive lighting, turning light, Automatic High Beam Assist and headlight power wash	D90T	<input type="radio"/>	<input type="radio"/>	<input type="radio"/>	<input type="radio"/>	<input type="radio"/>	Refer to page 10
TOWING							
Detachable tow bar	C05C	<input type="radio"/>	<input type="radio"/>	<input type="radio"/>	<input type="radio"/>	<input type="radio"/>	
Electrically deployable tow bar	C05B	<input type="radio"/>	<input type="radio"/>	<input type="radio"/>	<input type="radio"/>	<input type="radio"/>	
EXTERIOR COLOURS							(Please see pages 64-65 for full colour palette)
Solid paint		●	●	●	●	●	Refer to page 64
Metallic paint		<input type="radio"/>	<input type="radio"/>	<input type="radio"/>	<input type="radio"/>	<input type="radio"/>	Refer to page 64-65
Premium paint		<input type="radio"/>	<input type="radio"/>	<input type="radio"/>	<input type="radio"/>	<input type="radio"/>	Refer to page 65
WHEELS							(Availability of wheels is subject to choice of engine, please see pages 66-67 to see the full range)
Jaguar Tyre Repair System		●	●	●	●	●	
Space saver spare wheel (18")	C40D	<input type="radio"/>	<input type="radio"/>	<input type="radio"/>	<input type="radio"/>	<input type="radio"/>	
Tyre Pressure Monitoring System		●	●	●	●	●	

*Only available in Sports Grained leather (B41T).

● Standard ○ Option — Not available

Please consult your local Jaguar Retailer for details.

For a complete list of optional features and packs refer to the XF Specification and Price Guide or configure your vehicle at jaguar.com

SEATING AND VENEERS

		PURE	PRESTIGE	PORTFOLIO	R-SPORT	S	
SEATING	CODE						DESCRIPTION
Heated front seats	F53A	○	○	○	○	○	
Heated front and rear seats	F53B	—	○	○	○	○	
Climate front seats (requires leather seats and 4-way electric lumbar adjust)	F53F	—	○	○	○	○	Heated and cooled front seats
Climate front seats and heated rear seats (requires leather seats and 4-way electric lumbar adjust)	F53C	—	○	○	○	○	Heated and cooled front and rear seats
8-way manual front seat with electric recline (standard on 2.0 litre 4 cylinder 163PS Diesel engine only)		●	—	—	—	—	
10-way electric front seats with manual headrest height (optional on 2.0 litre 4 cylinder 163PS Diesel engine only)	Z03V	○/●	●	●	●	●	
4-way electric lumbar adjust (only available with 10-way seats)	F52A	○	○	○	○	○	
Driver memory (only available with 10-way seats)	H44N	○	○	○	○	○	Adjusts driver seat, mirrors and steering column
18-way electric front sports seats	Z03Q	—	—	—	○*	○	With manual headrest height, 4-way electric lumbar adjust and passenger and driver memory
20-way electric front luxury seats	Z03X	—	—	○	—	—	With manual winged headrest height, 4-way electric lumbar adjust and passenger and driver memory
Sports Grained leather seats	B41T	—	—	—	○	○	
40:20:40 split fold rear seat with armrest	H48W	○	○	○	○	○	

VENEERS

Please see pages 84-85 for full range of veneers

HEADLINING AND INTERIOR FEATURES

HEADLINING						
Light Oyster headlining	HAMT	●	●	●	○	○
Ebony headlining	HPDB	○	○	○	●	●
Suedecloth headlining	H01D	○	○	○	○	○

2 CHOOSE YOUR OPTIONS

 Configure your vehicle at jaguar.com

HEADLINING AND INTERIOR FEATURES CONTINUED

INTERIOR FEATURES	CODE	PURE	PRESTIGE	PORTFOLIO	R-SPORT	S	DESCRIPTION
Illuminated metal treadplates with Jaguar script	F28F	—	○	○	○	○	
Carpet mats	H69H	○	●	●	●	●	
Premium carpet mats	H69K	○	○	○	○	○	
Bright sport pedals	G48S	○	○	○	○	●	
Soft Grain leather steering wheel	F96J	●	—	—	—	—	
Soft Grain leather sport steering wheel	F95U	—	●	●	—	—	
R-Sport branded Soft Grain leather steering wheel	F96G	—	—	—	●	—	
S branded Soft Grain leather steering wheel	F95T	—	—	—	—	●	
Heated steering wheel (requires heated front seats)	F97A	○	○	○	○	○	
Electrically adjustable steering column	D07J	○	○	○	○	○	
Auto-dimming interior rear view mirror	B68B	○	○	○	○	○	
Timed Climate with remote heat function	H10F	○	○	○	○	○	
Four-zone Climate Control with two additional power sockets (requires air quality sensor and cooled glove box)*	C88G	○	○	○	○	○	Refer to page 100
Air quality sensor and cooled glove box	C89A, B23H	○	○	○	○	○	
Manual rear side window sunblinds	H73B	○	○	○	○	○	
Electric rear window sunblind	H76G	○	○	○	○	○	
Interior mood lighting	B65A	○	●	●	●	●	
Configurable Interior Mood Lighting with ten colours	B65B	○	○	○	○	○	Refer to page 17
Smoker's Pack	A03B	○	○	○	○	○	Includes single front ashtray, single cigar lighter and two single ashtray holders in rear door bins
Two additional power sockets	D72B	○	○	○	○	○	Additional 12V power socket in rear centre console and boot

*Not available on 2.0 litre 4 cylinder 163PS Diesel engine.

● Standard ○ Option — Not available

Please consult your local Jaguar Retailer for details.

For a complete list of optional features and packs refer to the XF Specification and Price Guide or configure your vehicle at jaguar.com

HEADLINING AND INTERIOR FEATURES CONTINUED

		PURE	PRESTIGE	PORTFOLIO	R-SPORT	S	
SAFETY AND SECURITY							
Front parking aid (requires rear parking aid)	C13A	○	○	○	○	○	
Rear parking aid	C11A	○	○	○	○	○	
Rear view camera (requires rear parking aid)	C14A	○	○	○	○	○	
Surround Camera System (requires power fold mirrors)	C14D	○	○	○	○	○	Refer to page 48
Park Assist (requires front and rear parking aids)	C18B	○	○	○	○	○	Refer to page 48
360° Parking Aid (requires front and rear parking aids)	C17A	○	○	○	○	○	Refer to page 48
Garage Door Opener (HomeLink®, requires auto-dimming interior rear view mirror)	B39N	○	○	○	○	○	
Lane Keep Assist and Driver Condition Monitor	H72D	○	○	○	○	○	Refer to page 48
Blind Spot Monitor and Reverse Traffic Detection (requires power fold mirrors and rear parking aid)	H71C	○	○	○	○	○	Refer to page 48
Blind Spot Assist (requires power fold mirrors and rear parking aid)	H71D	○	○	○	○	○	Refer to page 48
Traffic Sign Recognition with Adaptive Speed Limiter (requires navigation)	A41B	○	○	○	○	○	Refer to page 48
Jaguar Smart Key System – Keyless Entry	F04B	○	○	○	○	○	

2 CHOOSE YOUR OPTIONS

 Configure your vehicle at jaguar.com

INCONTROL INFOTAINMENT AND CONNECTIVITY

		PURE	PRESTIGE	PORTFOLIO	R-SPORT	S	
FEATURES ONLY AVAILABLE WITH TOUCH							
Touch with 8" Touchscreen		●	●	●	●	●	Refer to page 42
Instrument Cluster with 5" Central TFT Display		●	●	●	●	●	Refer to page 41
Navigation	G61C	○	○	○	○	○	Refer to page 43
Jaguar Sound System (80W)		●	●	●	●	●	Refer to page 46-47
Meridian™ Sound System (380W)	B44V	○	○	○	○	○	Refer to page 46-47
Connect	Z77F	○	○	○	○	○	Refer to page 42-43
FEATURES ONLY AVAILABLE WITH OPTIONAL TOUCH PRO							
Touch Pro with 10.2" Touchscreen, 12.3" high-definition virtual instrument display, Navigation Pro and Meridian™ Sound System (380W)	Z59X	○	○	○	○	○	Refer to page 44-45
Touch Pro with 10.2" Touchscreen, 12.3" high-definition virtual instrument display, Navigation Pro and Meridian™ Surround Sound System (825W)	Z59Y	○	○	○	○	○	Refer to page 44-45
Connect Pro Pack	Z77G	○	○	○	○	○	Refer to page 45
10.2" Dual view Touchscreen	D70E	○	○	○	○	○	Refer to page 45
Digital TV Tuner	G61D	○	○	○	○	○	Refer to page 41
FEATURES AVAILABLE WITH TOUCH OR TOUCH PRO							
Protect		●	●	●	●	●	Includes SOS Emergency Call, Jaguar Optimised Assistance and Remote Essentials smartphone app. Refer to page 41
Secure Tracker	D44A	○	○	○	○	○	Stolen Vehicle Tracking via your smartphone app. Refer to page 41
Head-up Display with infrared reflective windscreen	Z13A	○	○	○	○	○	Refer to page 39
DAB Radio	B51A	○	○	○	○	○	Refer to page 41

*Not available on 2.0 litre 4 cylinder 163PS Diesel engine.

● Standard ○ Option — Not available

Please consult your local Jaguar Retailer for details.

For a complete list of optional features and packs refer to the XF Specification and Price Guide or configure your vehicle at jaguar.com

OPTION PACKS

		PURE	PRESTIGE	PORTFOLIO	R-SPORT	S	
Cold Climate Pack	Z88D	○	○	○	○	○	Consists of heated front windscreen, heated washer jets, heated steering wheel and heated front and rear seats (heated front seats only on Pure)
Power Convenience Pack	Z28B	○	○	○	○	○	Consists of Keyless Entry, Powered Gesture Boot Lid and two additional power sockets
Parking Pack	Z68S	○	○	○	○	○	Consists of front and rear parking aids and rear view camera
Advanced Park Assist Pack	Z68T	○	○	○	○	○	Consists of Parking Pack features plus 360° Parking Aid and Park Assist. Refer to page 48
Advanced Park Assist Pack with Surround Camera System	Z68U	○	○	○	○	○	Consists of Advanced Parking Assist Pack features plus Surround Camera System (replaces rear view camera). Refer to page 48
Active Safety Pack	Z76C	○	○	○	○	○	Consists of Adaptive Cruise Control with Queue Assist (only available with automatic transmission), Lane Keep Assist and Driver Condition Monitor, Blind Spot Monitor and Reverse Traffic Detection (requires power fold mirrors and rear parking aid)
Black Pack	Z93L	—	○	○	○	○	Consists of Gloss Black radiator grille and surround, side power vents, boot lid finisher, side window surround and body kit blades (except S)
Memory Pack without power fold mirrors	Z15X	○	○	○	○	○	Consists of heated door mirrors with memory, electrically adjustable steering column, driver seat memory and 10-way electric front seats
Memory Pack with power fold mirrors	Z15Y	○	○	○	○	○	Consists of auto-dimming, power fold, heated door mirrors with memory and approach lights, auto-dimming rear view mirror, electrically adjustable steering column, driver seat memory and 10-way electric front seats
Premium Seat Upgrade with Memory Pack	Z16U	—	—	○	○	○	Consists of auto-dimming, power fold, heated door mirrors with memory and approach lights, auto-dimming rear view mirror, electrically adjustable steering column, driver and passenger seat memory, 18-way electric front Sport seats or 20-way electric front Luxury seats
Rear Comfort Pack*	Z12A	○	○	○	○	○	Consists of heated front and rear seats (heated front seats only on Pure), Four-zone Climate Control, manual rear side window sunblinds and electric rear window sunblind

3 CHOOSE YOUR COLOUR

 [Configure your vehicle at jaguar.com](https://www.jaguar.com)

SOLID

Fuji White

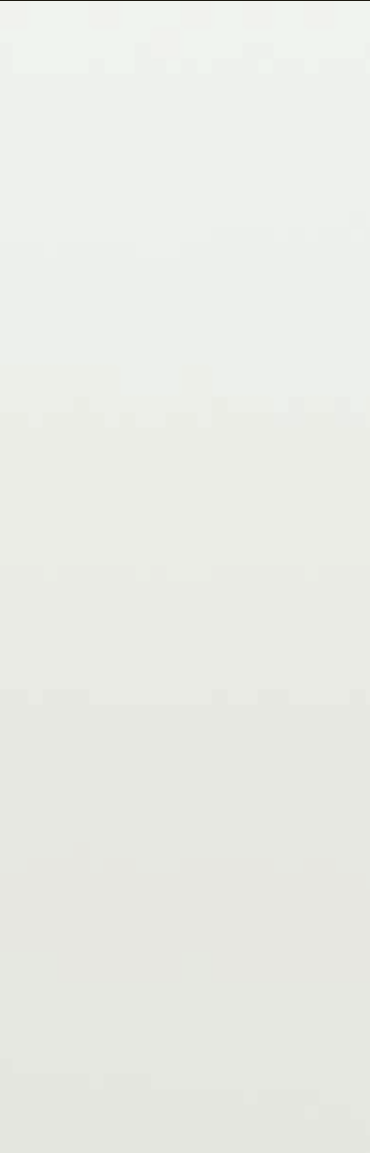

Narvik Black



METALLIC

Yulong White



Santorini Black

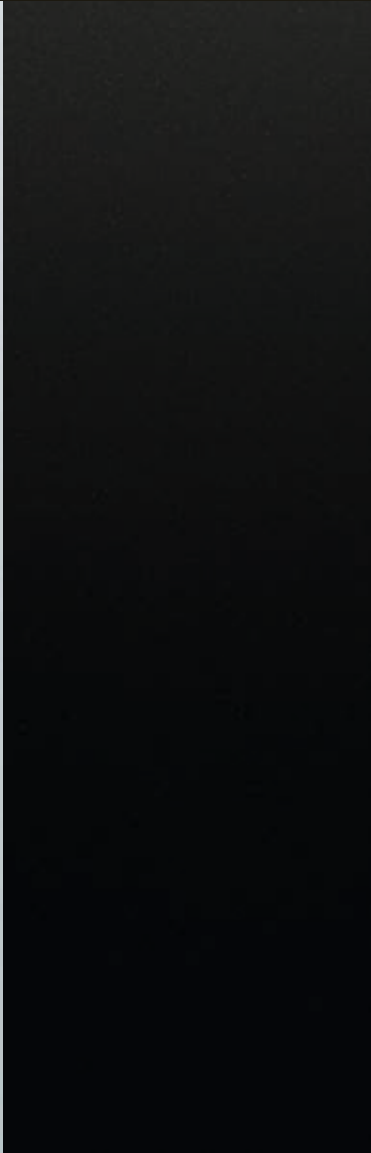

Indus Silver



Corris Grey



Loire Blue



Caesium Blue



Firenze Red



Rossello Red



PREMIUM PALETTE

Carpathian Grey

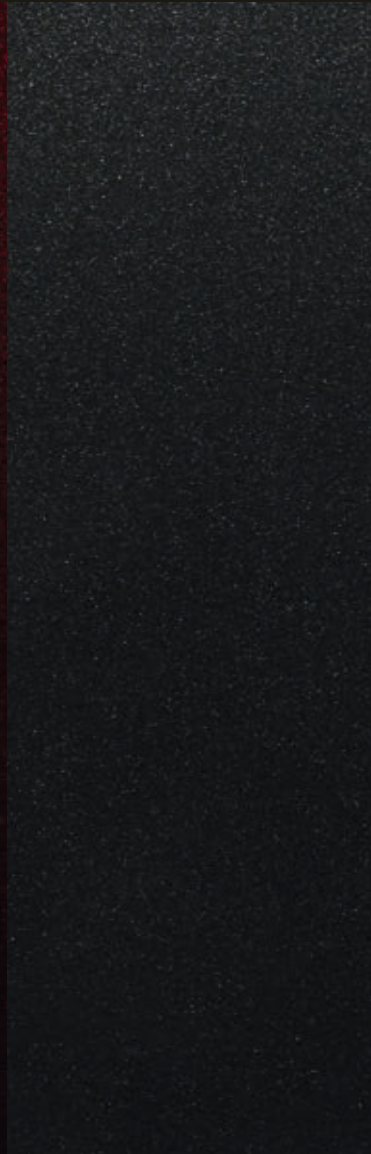

Silicon Silver

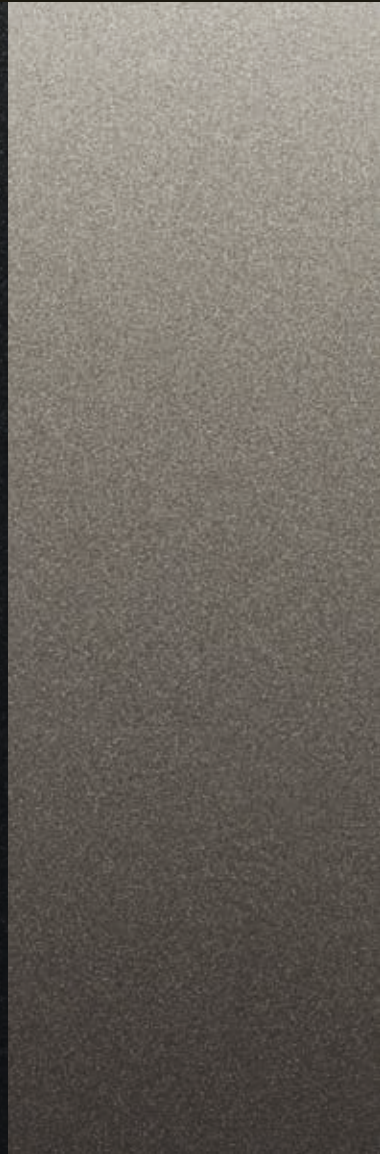

4 CHOOSE YOUR WHEELS

 Configure your vehicle at jaguar.com



17" 10 SPOKE
'STYLE 1017'¹



17" 15 SPOKE
'STYLE 1016'²



17" 9 SPOKE
'STYLE 9005'²



18" 5 SPOKE
'STYLE 5034'^{1*}



18" 7 SPLIT-SPOKE
'STYLE 7011'^{1*}

ALLOY WHEEL FINISH	Silver	Silver	Silver	Silver	Silver
ALLOY WHEEL/SIZE	7.5J x 17"	7.5J x 17"	7.5J x 17"	8.0J x 18"	8.0J x 18"
TYRE SIZE	225/55 R17	225/55 R17	225/55 R17	245/45 R18	245/45 R18
CODE	C54A	C54B	C54C	C53R	C53S
Pure	—	●	○*	○/● ³	○
Prestige	○	●	○ ²	○/● ³	○
Portfolio	●	○ ¹	○ ¹	○	●
R-Sport	○	○ ¹	● ¹	○	○
S	—	—	—	—	—



18" 5 SPLIT-SPOKE
'STYLE 5033'^{1*}



18" 5 SPLIT-SPOKE
'STYLE 5033'^{1*}



18" 5 SPLIT-SPOKE
'STYLE 5033'^{1*}



19" 7 SPLIT-SPOKE
'STYLE 7012'^{1*}



19" 7 SPLIT-SPOKE
'STYLE 7013'^{1*}

ALLOY WHEEL FINISH	Silver	Contrast/Diamond Turned	Gloss Black	Silver	Silver
ALLOY WHEEL/SIZE	8.0J x 18"	8.0J x 18"	8.0J x 18"	8.0J x 19"	8.0J x 19"
TYRE SIZE	245/45 R18	245/45 R18	245/45 R18	245/40 R19	245/40 R19
CODE	C53T	C53P	C530	C53U	C53V
Pure	○	○	○	○	○
Prestige	○	○	○	○	○
Portfolio	○	○	○	○	○
R-Sport	●	○	○	○	○
S	—	—	—	○	○

● Standard ○ Option — Not Applicable

*Not available with 2.0 litre 4 cylinder 163PS Diesel engine.

¹Only available on models with 2.0 litre 4 cylinder 163PS Diesel engine ²Only available on 4 cylinder engines ³Optional on 4 cylinder engines, standard on V6 engines

Standard and optional features may differ depending on market availability.



19" 7 SPLIT-SPOKE
'STYLE 7013'*



19" 10 SPOKE
'STYLE 1018'*



19" 5 SPOKE
'STYLE 5035'*



19" 5 SPOKE
'STYLE 5035'*



20" 9 SPLIT-SPOKE
'STYLE 9004!'

ALLOY WHEEL FINISH	Contrast/Diamond Turned	Silver	Gloss Dark Grey/Diamond Turned	Gloss Black	Silver
ALLOY WHEEL/SIZE	8.0J x 19"	8.0J x 19"	8.0J x 19"	8.0J x 19"	8.5J x 20"
TYRE SIZE	245/40 R19	245/40 R19	245/40 R19	245/40 R19	255/35 R20
CODE	C53Z	C53W	C53Y	C53X	C53H

Pure	<input type="radio"/>	<input type="radio"/>	<input type="radio"/>	<input type="radio"/>	<input type="radio"/>
Prestige	<input type="radio"/>	<input type="radio"/>	<input type="radio"/>	<input type="radio"/>	<input type="radio"/>
Portfolio	<input type="radio"/>	<input type="radio"/>	<input type="radio"/>	<input type="radio"/>	<input type="radio"/>
R-Sport	<input type="radio"/>	<input type="radio"/>	<input type="radio"/>	<input type="radio"/>	<input type="radio"/>
S	<input type="radio"/>	<input type="radio"/>	<input checked="" type="radio"/>	<input type="radio"/>	<input type="radio"/>



20" 9 SPLIT-SPOKE
'STYLE 9004!'



20" 5 SPLIT-SPOKE
'STYLE 5071!'



20" 5 SPLIT-SPOKE
'STYLE 5031!'



20" 5 SPLIT-SPOKE
'STYLE 5031!'



20" 5 SPLIT-SPOKE
'STYLE 5036!'

ALLOY WHEEL FINISH	Contrast/Diamond Turned	Silver	Gloss Dark Grey/Diamond Turned	Gloss Black	Gloss Dark Grey/Diamond Turned
ALLOY WHEEL/SIZE	8.5J x 20"	8.5J x 20"	8.5J x 20"	8.5J x 20"	8.5J x 20"
TYRE SIZE	255/35 R20	255/35 R20	255/35 R20	255/35 R20	255/35 R20
CODE	C53J	C53K	C53F	C53L	C53G

Pure	<input type="radio"/>	<input type="radio"/>	<input type="radio"/>	<input type="radio"/>	<input type="radio"/>
Prestige	<input type="radio"/>	<input type="radio"/>	<input type="radio"/>	<input type="radio"/>	<input type="radio"/>
Portfolio	<input type="radio"/>	<input type="radio"/>	<input type="radio"/>	<input type="radio"/>	<input type="radio"/>
R-Sport	<input type="radio"/>	<input type="radio"/>	<input type="radio"/>	<input type="radio"/>	<input type="radio"/>
S	<input type="radio"/>	<input type="radio"/>	<input type="radio"/>	<input type="radio"/>	<input type="radio"/>

5 CHOOSE YOUR INTERIOR

 Configure your vehicle at jaguar.com

PURE						
	SEAT WITH TONAL STITCH	UPPER FACIA WITH TONAL STITCH	INTERIOR TRIM AND OPTION CODES	HEADLINING MORZINE*	CARPET	VENEER
Standard						
Premium fabric seats (EU only)	Ebony with Ebony	Ebony with Ebony	TR23	Ebony** or Light Oyster	Ebony	Gloss Black
	Latte with Latte	Espresso with Espresso	TR24	Light Oyster	Espresso	Gloss Black
PRESTIGE						
	SEAT WITH TONAL STITCH	UPPER FACIA WITH TONAL STITCH	INTERIOR TRIM AND OPTION CODES	HEADLINING MORZINE*	CARPET	VENEER
Standard						
Grained leather seats	Ebony with Ebony	Ebony with Ebony	TR26	Ebony** or Light Oyster	Ebony	Gloss Black
	Latte with Latte	Espresso with Espresso	TR27	Light Oyster	Espresso	Gloss Black
	Light Oyster with Light Oyster	Oyster with Oyster	TR28	Light Oyster	Oyster	Gloss Black
PORTFOLIO						
	SEAT WITH TONAL STITCH	UPPER FACIA WITH TONAL STITCH	INTERIOR TRIM AND OPTION CODES	HEADLINING MORZINE*	CARPET	VENEER
Standard						
Windsor leather seats	Ebony with Ebony	Ebony with Ebony	TR37	Ebony** or Light Oyster	Ebony	Gloss Figured Ebony
	Latte with Latte	Espresso with Espresso	TR38	Light Oyster	Espresso	Gloss Figured Ebony
	Light Oyster with Light Oyster	Oyster with Oyster	TR39	Light Oyster	Oyster	Gloss Figured Ebony
	Espresso with Espresso	Espresso with Espresso	TR40	Light Oyster	Espresso	Gloss Figured Ebony
	Siena Tan with Siena Tan	Ebony with Ebony	TR41	Ebony** or Light Oyster	Ebony	Gloss Figured Ebony

*Suedecloth headlining available as an option.
 **Ebony headlining available as an option.
 †Light Oyster headlining available as an option.

R-SPORT						
	DUO TONE SEAT WITH CONTRAST STITCH	UPPER FACIA WITH CONTRAST STITCH	INTERIOR TRIM AND OPTION CODES	HEADLINING MORZINE*	CARPET	VENEER
Standard						
Sports Grained leather seats with technical mesh inserts	Ebony/Ebony with Light Oyster	Ebony with Light Oyster	TR29	Ebony or Light Oyster†	Ebony	Gloss Black
Option						
Grained leather Sports seats	Ebony/Ebony with Light Oyster	Ebony with Light Oyster	TR29 + B41T	Ebony or Light Oyster†	Ebony	Gloss Black
	Ebony/Pimento with Pimento	Ebony with Pimento	TR30	Ebony or Light Oyster†	Ebony	Gloss Black
	Ebony/Light Oyster with Light Oyster	Ebony with Light Oyster	TR31	Ebony or Light Oyster†	Ebony	Gloss Black
	Brogue/Brogue with Light Oyster	Ebony with Light Oyster	TR32	Ebony or Light Oyster†	Ebony	Gloss Black
S						
	DUO TONE SEAT WITH CONTRAST STITCH	UPPER FACIA WITH CONTRAST STITCH	INTERIOR TRIM AND OPTION CODES	HEADLINING MORZINE*	CARPET	VENEER
Standard						
Sports Grained leather seats with suedecloth inserts	Ebony/Ebony with Light Oyster	Ebony with Light Oyster	TR33	Ebony or Light Oyster†	Ebony	Grey Figured Ebony
	Pimento/Ebony with Ebony	Ebony with Pimento	TR34	Ebony or Light Oyster†	Ebony	Grey Figured Ebony
Option						
Grained leather Sports seats	Ebony/Ebony with Light Oyster	Ebony with Light Oyster	TR33 + B41T	Ebony or Light Oyster†	Ebony	Grey Figured Ebony
	Pimento/Ebony with Ebony	Ebony with Pimento	TR34 + B41T	Ebony or Light Oyster†	Ebony	Grey Figured Ebony
	Light Oyster/Ebony with Ebony	Ebony with Light Oyster	TR35	Ebony or Light Oyster†	Ebony	Grey Figured Ebony
	Brogue/Brogue with Light Oyster	Ebony with Light Oyster	TR36	Ebony or Light Oyster†	Ebony	Grey Figured Ebony

5 CHOOSE YOUR INTERIOR

⚙️ Configure your vehicle at [jaguar.com](https://www.jaguar.com)

Interior shown: Ebony fabric seats with Ebony facia, Morse Code Aluminium finisher, Gloss Black veneer and optional Ebony headlining.



PURE

INTERIOR COLOUR COMBINATIONS

STANDARD

1	2	3	4	5	6
SEAT WITH TONAL STITCH	VENEER	HEADLINING MORZINE*	UPPER FACIA WITH TONAL STITCH	FINISHER	CARPETS
					
Ebony	Gloss Black	Ebony** or Light Oyster	Ebony with Ebony	Morse Code Aluminium	Ebony
					
Latte	Gloss Black	Light Oyster	Espresso with Espresso	Morse Code Aluminium	Espresso

VENEER OPTIONS

Carbon Fibre Veneer, Satin Burr Ash Veneer, Gloss Figured Ebony Veneer, Grey Figured Ebony Veneer, Satin Fine Line Veneer, Satin Rosewood Veneer or Gloss Burr Walnut Veneer

*Suedecloth headlining available as an option.
**Ebony headlining available as an option.

5 CHOOSE YOUR INTERIOR

⚙️ Configure your vehicle at jaguar.com













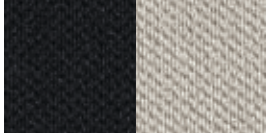



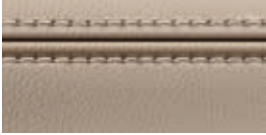

Interior shown: Ebony Grained leather seats with Ebony tonal stitch, Ebony facia, Morse Code Aluminium finisher, Gloss Black veneer and optional Ebony headlining.



PRESTIGE

INTERIOR COLOUR COMBINATIONS

STANDARD

1	2	3	4	5	6
SEAT WITH TONAL STITCH	VENEER	HEADLINING MORZINE*	UPPER FACIA WITH TONAL STITCH	FINISHER	CARPETS
					
Ebony with Ebony	Gloss Black	Ebony** or Light Oyster	Ebony with Ebony	Morse Code Aluminium	Ebony
					
Latte with Latte	Gloss Black	Light Oyster	Espresso with Espresso	Morse Code Aluminium	Espresso
					
Light Oyster with Light Oyster	Gloss Black	Light Oyster	Oyster with Oyster	Morse Code Aluminium	Oyster

VENEER OPTIONS

Carbon Fibre Veneer, Satin Burr Ash Veneer, Gloss Figured Ebony Veneer, Grey Figured Ebony Veneer, Satin Fine Line Veneer, Satin Rosewood Veneer or Gloss Burr Walnut Veneer

*Suedecloth headlining available as an option.
 **Ebony headlining available as an option.

5 CHOOSE YOUR INTERIOR

⚙️ Configure your vehicle at [jaguar.com](https://www.jaguar.com)











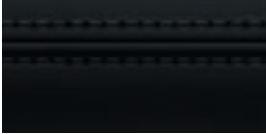

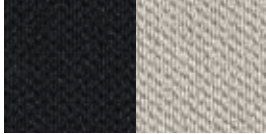
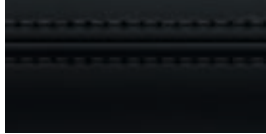















Interior shown: Latte Windsor leather seats with Latte tonal stitch, Espresso facia, Morse Code Aluminium finisher, Gloss Figured Ebony veneer and Light Oyster headlining.

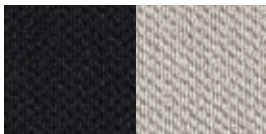

PORTFOLIO

INTERIOR COLOUR COMBINATIONS

STANDARD

1	2	3	4	5	6
SEAT WITH TONAL STITCH	veneer	HEADLINING MORZINE*	UPPER FACIA WITH TONAL STITCH	FINISHER	CARPETS
					
Ebony with Ebony	Gloss Figured Ebony	Ebony** or Light Oyster	Ebony with Ebony	Morse Code Aluminium	Ebony
					
Latte with Latte	Gloss Figured Ebony	Light Oyster	Espresso with Espresso	Morse Code Aluminium	Espresso
					
Light Oyster with Light Oyster	Gloss Figured Ebony	Light Oyster	Oyster with Oyster	Morse Code Aluminium	Oyster
					
Espresso with Espresso	Gloss Figured Ebony	Light Oyster	Espresso with Espresso	Morse Code Aluminium	Espresso
					
Siena Tan with Siena Tan	Gloss Figured Ebony	Ebony** or Light Oyster	Ebony with Ebony	Morse Code Aluminium	Ebony

VENEER OPTIONS

Gloss Black Veneer, Carbon Fibre Veneer, Satin Burr Ash Veneer, Grey Figured Ebony Veneer, Satin Fine Line Veneer, Satin Rosewood Veneer or Gloss Burr Walnut Veneer

*Suedecloth headlining available as an option.
 **Ebony headlining available as an option.

5 CHOOSE YOUR INTERIOR

⚙️ Configure your vehicle at jaguar.com

Interior shown: Ebony Grained leather sports seats with Ebony technical mesh inserts and Light Oyster contrast stitch, Ebony facia with Light Oyster contrast stitch, Dark Morse Code Aluminium finisher, Gloss Black veneer and optional Light Oyster headlining.



R-SPORT

INTERIOR COLOUR COMBINATIONS

STANDARD

1

DUO TONE SEAT WITH
CONTRAST STITCH

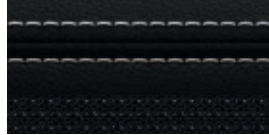

Ebony/Ebony with Light Oyster

2

VENEER



Gloss Black

3

HEADLINING MORZINE*



Ebony or Light Oyster**

4

UPPER FACIA
WITH CONTRAST STITCH

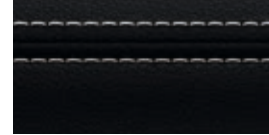

Ebony with Light Oyster

5

FINISHER



Dark Morse Code Aluminium

6

CARPETS



Ebony

VENEER OPTIONS

Carbon Fibre Veneer, Satin Burr Ash Veneer, Gloss Figured Ebony Veneer, Grey Figured Ebony Veneer, Satin Fine Line Veneer, Satin Rosewood Veneer or Gloss Burr Walnut Veneer

*Suedecloth headlining available as an option.

**Light Oyster headlining available as an option.

5 CHOOSE YOUR INTERIOR

⚙️ Configure your vehicle at jaguar.com





















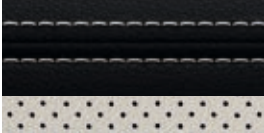

Interior shown: Ebony and Light Oyster perforated Grained leather sports seats with Light Oyster contrast stitch, Ebony facia with Light Oyster contrast stitch, Dark Morse Code Aluminium finisher, optional Satin Fine Line veneer and optional Light Oyster headlining.



R-SPORT

INTERIOR COLOUR COMBINATIONS

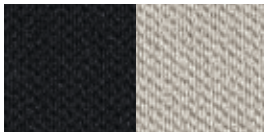
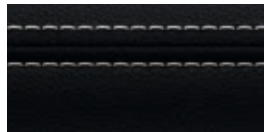
OPTION

1	2	3	4	5	6
<p>DUO TONE SEAT WITH CONTRAST STITCH</p>  <p>Ebony/Ebony with Light Oyster</p>	<p> veneer</p>  <p>Gloss Black</p>	<p>HEADLINING MORZINE*</p>  <p>Ebony or Light Oyster**</p>	<p>UPPER FACIA WITH CONTRAST STITCH</p>  <p>Ebony with Light Oyster</p>	<p>FINISHER</p>  <p>Dark Morse Code Aluminium</p>	<p>CARPETS</p>  <p>Ebony</p>
 <p>Ebony/Pimento with Pimento</p>	 <p>Gloss Black</p>	 <p>Ebony or Light Oyster**</p>	 <p>Ebony with Pimento</p>	 <p>Dark Morse Code Aluminium</p>	 <p>Ebony</p>
 <p>Ebony/Light Oyster with Light Oyster</p>	 <p>Gloss Black</p>	 <p>Ebony or Light Oyster**</p>	 <p>Ebony with Light Oyster</p>	 <p>Dark Morse Code Aluminium</p>	 <p>Ebony</p>
 <p>Brogue/Brogue with Light Oyster</p>	 <p>Gloss Black</p>	 <p>Ebony or Light Oyster**</p>	 <p>Ebony with Light Oyster</p>	 <p>Dark Morse Code Aluminium</p>	 <p>Ebony</p>

VENEER OPTIONS

Carbon Fibre Veneer, Satin Burr Ash Veneer, Gloss Figured Ebony Veneer, Grey Figured Ebony Veneer, Satin Fine Line Veneer, Satin Rosewood Veneer or Gloss Burr Walnut Veneer

*Suedecloth headlining available as an option.
 **Light Oyster headlining available as an option.

5 CHOOSE YOUR INTERIOR

⚙️ Configure your vehicle at [jaguar.com](https://www.jaguar.com)

Interior shown: Ebony Grained leather sports seats with Ebony suedecloth inserts and Light Oyster contrast stitch, Ebony facia with Light Oyster contrast stitch, Dark Hex Aluminium finisher, Grey Figured Ebony veneer and Ebony headlining.



S

INTERIOR COLOUR COMBINATIONS

STANDARD

1	2	3	4	5	6
DUO TONE SEAT WITH CONTRAST STITCH	VENEER	HEADLINING MORZINE*	UPPER FACIA WITH CONTRAST STITCH	FINISHER	CARPETS
					
Ebony/Ebony with Light Oyster	Grey Figured Ebony	Ebony or Light Oyster**	Ebony with Light Oyster	Dark Hex Aluminium	Ebony
					
Pimento/Ebony with Ebony	Grey Figured Ebony	Ebony or Light Oyster**	Ebony with Pimento	Dark Hex Aluminium	Ebony

VENEER OPTIONS

Gloss Black Veneer, Carbon Fibre Veneer, Satin Burr Ash Veneer, Gloss Figured Ebony Veneer, Satin Fine Line Veneer, Satin Rosewood Veneer or Gloss Burr Walnut Veneer

*Suedecloth headlining available as an option.
 **Light Oyster headlining available as an option.

5 CHOOSE YOUR INTERIOR

⚙️ Configure your vehicle at [jaguar.com](https://www.jaguar.com)











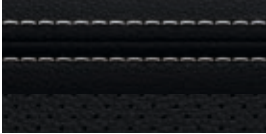

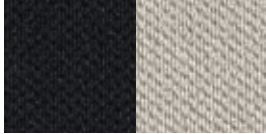
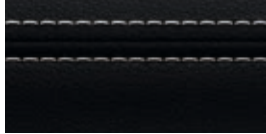



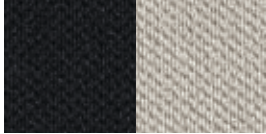
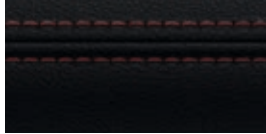

Interior shown: Light Oyster and Ebony perforated Grained leather sports seats with Ebony contrast stitch, Ebony fascia with Light Oyster contrast stitch, Dark Hex Aluminium finisher, Grey Figured Ebony veneer and Ebony headlining.

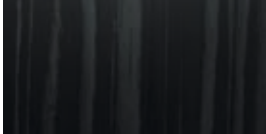

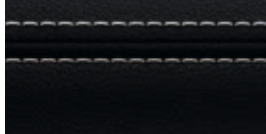
S

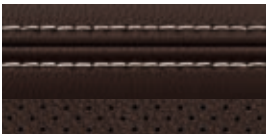
INTERIOR COLOUR COMBINATIONS

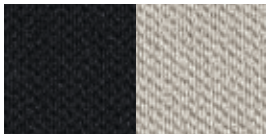
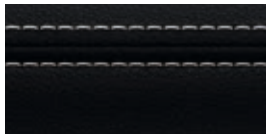
OPTION

1	2	3	4	5	6
<p>DUO TONE SEAT WITH CONTRAST STITCH</p>  <p>Ebony/Ebony with Light Oyster</p>	<p>VENEER</p>  <p>Grey Figured Ebony</p>	<p>HEADLINING MORZINE*</p>  <p>Ebony or Light Oyster**</p>	<p>UPPER FACIA WITH CONTRAST STITCH</p>  <p>Ebony with Light Oyster</p>	<p>FINISHER</p>  <p>Dark Hex Aluminium</p>	<p>CARPETS</p>  <p>Ebony</p>
 <p>Pimento/Ebony with Ebony</p>	 <p>Grey Figured Ebony</p>	 <p>Ebony or Light Oyster**</p>	 <p>Ebony with Pimento</p>	 <p>Dark Hex Aluminium</p>	 <p>Ebony</p>
 <p>Light Oyster/Ebony with Ebony</p>	 <p>Grey Figured Ebony</p>	 <p>Ebony or Light Oyster**</p>	 <p>Ebony with Light Oyster</p>	 <p>Dark Hex Aluminium</p>	 <p>Ebony</p>
 <p>Brogue/Brogue with Light Oyster</p>	 <p>Grey Figured Ebony</p>	 <p>Ebony or Light Oyster**</p>	 <p>Ebony with Light Oyster</p>	 <p>Dark Hex Aluminium</p>	 <p>Ebony</p>

VENEER OPTIONS

Gloss Black Veneer, Carbon Fibre Veneer, Satin Burr Ash Veneer, Gloss Figured Ebony Veneer, Satin Fine Line Veneer, Satin Rosewood Veneer or Gloss Burr Walnut Veneer

*Suedecloth headlining available as an option.

**Light Oyster headlining available as an option.

5 CHOOSE YOUR INTERIOR

 Configure your vehicle at [jaguar.com](https://www.jaguar.com)

Gloss Black Veneer

Carbon Fibre Veneer

Satin Burr Ash Veneer

Gloss Figured Ebony Veneer



Grey Figured Ebony Veneer



Satin Fine Line Veneer



Satin Rosewood Veneer



Gloss Burr Walnut Veneer

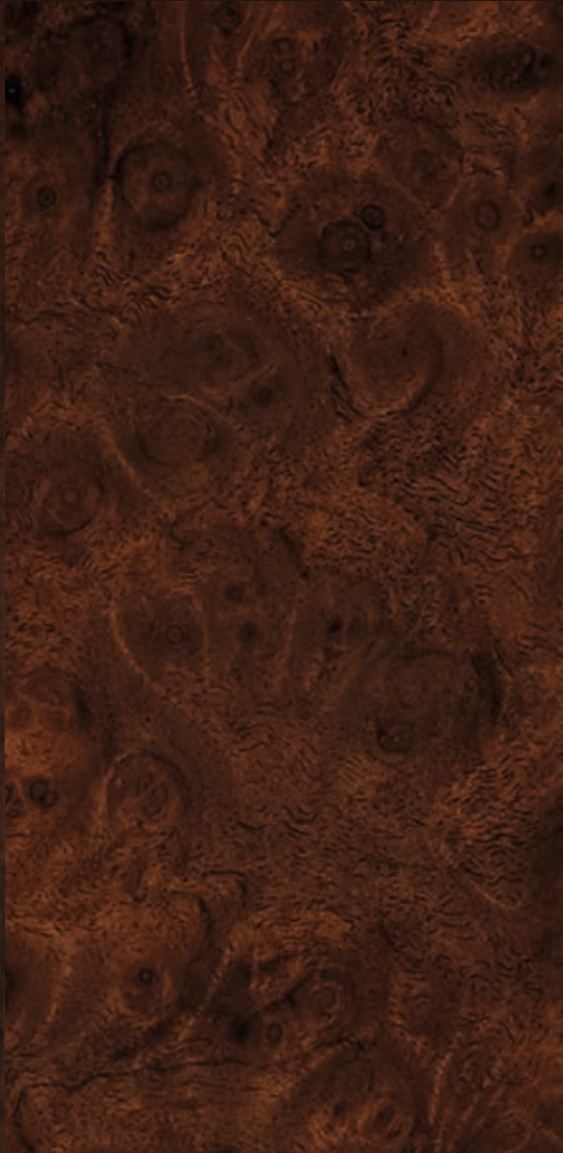

6 CHOOSE YOUR JAGUAR GEAR ACCESSORIES

To find out more about the full range of Retailer fit Jaguar Gear Accessories, please refer to your retailer or go to accessories.jaguar.com



Watersports Carrier* **C2Z21730**

A versatile system for transporting a variety of water sports equipment including surfboard, kayak or sailboard. Tilts to facilitate loading/unloading.

*Requires roof cross bars T2H14468.

**Not available for Pure.

VEHICLE SHOWN: XF S IN YULONG WHITE WITH OPTIONAL FEATURES FITTED (MARKET DEPENDENT)



Aluminium Paddle Shifters
T2R6547 Automatic transmission only.
T2R6547CAY Red. Automatic transmission only.

Replacement steering wheel gearshift paddles offered in a premium aluminium material providing a high quality finish to a key contact point in the vehicle. Manufactured from billet machined aluminium, the paddles are hand brushed for a premium finish and anodised to ensure they will not deteriorate with wear.



Premium Carpet Mats
T2H7171PVJ - LHD
T2H7173 - LHD AWD

Luxurious, tailored 2,050g/m² pile front carpet mats with embossed Jaguar logo and nubuck edge binding. The premium mats provide a well appointed finishing touch to the interior.



Central Armrest Chiller/Warmer
T2H7739

Food and drinks chiller and warmer that acts as a rear centre armrest. With a leather-covered top, it is held in place by the centre seat belt and powered from the rear auxiliary socket. Ideal for long journeys with the family.



iPad Holder
T2H7757

Jaguar branded iPad® holder mounts to front seat headrests providing a flexible solution for rear seat entertainment. Quick release design ensures iPad® can be fitted or removed quickly and easily.



Personalised Illuminated Sill Treadplates**
T2H17122PVJ

Elegantly styled stainless steel sill treadplate finishers for driver or passenger doors. Illuminates when either the driver or passenger doors are opened. Highlighted by soft Phosphor Blue lighting. Allows you to specify a monochrome 'motif' in a choice of approved typefaces/scripts.



Rubber Mats
T4N7742 - LHD
T2H7743 - LHD AWD

Hard wearing Jaguar branded rubber mats provide added protection for your vehicle's carpets.

6 CHOOSE YOUR JAGUAR GEAR ACCESSORIES

 Configure your vehicle at jaguar.com



Gloss Black Side Vent*
T4N5176 - Left Side
T4N5178 - Right Side

Jaguar branded, Gloss Black side power vents provide a dynamic exterior styling enhancement.



Carbon Fibre Side Vent
T2H18318 - Left Side
T2H18319 - Right Side

High grade Carbon Fibre side power vents provide a performance-inspired styling upgrade.



Noble Chrome Mirror Caps
T2H26929

Chrome mirror covers accentuate the stylish design of the exterior mirrors.



Gloss Black Mirror Cap
C2D6067PEC - Left Side
C2D6066PEC - Right Side

Gloss Black mirror covers accentuate the dynamic design of the exterior mirrors.



Carbon Fibre Mirror Cap
C2P24176 - Right Side
C2P24177 - Left Side

High grade Carbon Fibre mirror covers provide a performance-inspired styling upgrade.



Rear Tailgate Trim - Gloss Black
T2H17748

Add style and visual distinction with Gloss Black finish rear tailgate trim.

*Not applicable for R-Sport. **Requires roof cross bars T2H14468.



Roof Cross Bars
T2H14468

Jaguar branded cross bars required for fitting all roof carrying equipment. Engineered specifically for your vehicle.



Roof Luggage Box**
C2C41628

Spacious 410 litre capacity lockable roof luggage box, measuring 175 x 82 x 45cm.



Roof Sport Box**
C2C41627

Spacious 320 litre capacity lockable roof box designed for sports equipment, measuring 206 x 84 x 34cm.



Ski/Snowboard Holder**
C2A1538

A safe and secure Jaguar branded system for transporting winter sports equipment. Incorporates slider rails for easy loading. For four pairs of skis or two snowboards.



Fork Mounted Cycle Carrier**
C2A1540

Fitted to the roof, the fork mounted cycle carrier provides a simple and secure fitting with the bike front wheel removed, ideally suited to lightweight bikes and 'racing' wheels. A separate carrier is included for the front wheel. Easy to fit, lockable cycle carrier which carries one bike per holder. A maximum of three holders can be fitted.



Tow Bar Mounted Cycle Carrier
C2Z22695 - 2 Bike
C2Z22697 - 3 Bike

Premium tow ball mounted cycle carriers provide a convenient bike carrying solution with quick release loading attachments and secure locking mechanism. Clever design allows carrier to be tilted away from vehicle when fitted allowing access into the rear tailgate.

TECHNICAL SPECIFICATIONS

 Configure your vehicle at jaguar.com

ENGINES		E-PERFORMANCE 2.0 LITRE 4 CYLINDER TURBOCHARGED DIESEL		20d 2.0 LITRE 4 CYLINDER TURBOCHARGED DIESEL		
Capacity	cc	1,999		1,999		
Maximum power	EEC-PS (kW)	163 (120)		180 (132)		
@rev/min	rpm	4,000		4,000		
Maximum torque	EEC-Nm (lb.ft.)	380 (280)		430 (318)		
@rev/min	rpm	1,750-2,500		1,750-2,500		
PERFORMANCE		MANUAL RWD	AUTO RWD	MANUAL RWD	AUTO RWD	AUTO AWD
0-100 km/h	seconds	8.7	8.7	8	8.1	8.4
0-60 mph	seconds	8.2	8.2	7.5	7.7	7.9
Top speed	km/h (mph)	229 (142)	227 (141)	230 (143)	229 (142)	222 (138)
FUEL CONSUMPTION ¹						
Urban	l/100km (mpg)	4.8 (58.9)	5.1 (55.4)	5.1 (55.4)	5.2 (54.3)	5.7 (49.6)
Extra Urban	l/100km (mpg)	3.6 (78.5)	3.6 (78.5)	3.9 (72.4)	3.8 (74.3)	4.5 (62.8)
Combined	l/100km (mpg)	4.0 (70.6)	4.1 (68.9)	4.3 (65.7)	4.3 (65.7)	4.9 (57.7)
CO ₂ Urban	g/km	124	133	132	136	149
CO ₂ Extra Urban	g/km	94	94	102	100	117
CO ₂ Combined	g/km	104	109	114	114	129
Tank capacity (usable)	ltr approx.	55	55	66	66	66
DIMENSIONS						
Overall length	mm	4,954		4,954		
Overall width (inc. mirrors)	mm	2,091		2,091		
Overall width (mirrors folded)	mm	1,987		1,987		
Overall height	mm	1,457		1,457		
Wheelbase	mm	2,960		2,960		
Front track	mm	1,605 (1,597 20" wheels)		1,605 (1,597 20" wheels)		
Rear track	mm	1,594 (1,586 20" wheels)		1,594 (1,586 20" wheels)		
Ground clearance	mm	116		116		
Turning circle diameter (kerb-to-kerb)	m	11.61		11.61		
Boot volume*	litres	540		540		
WEIGHT ²						
Weight from	kg	1,545	1,555	1,585	1,595	1,700
Gross vehicle weight	kg	2,190	2,190	2,250	2,250	2,310
ENGINE AVAILABILITY						
Pure		●			●	
Prestige		●			●	
Portfolio		●			●	
R-Sport		●			●	
S		—			—	

● Available — Not Available

*With Tyre Repair System. 505 litres with space saver spare wheel.

¹Official EU test figures. For comparison purposes only. Real world figures may differ.

²Weights reflect vehicles to standard specifications. Optional extras increase weight.

ENGINES		25d 2.0 LITRE 4 CYLINDER TWIN TURBOCHARGED DIESEL	30d 3.0 LITRE V6 TWIN TURBOCHARGED DIESEL
Capacity	cc	1,999	2,993
Maximum power	EEC-PS (kW)	240 (177)	300 (221)
@rev/min	rpm	4,000	4,000
Maximum torque	EEC-Nm (lb.ft.)	500 (368)	700 (516)
@rev/min	rpm	1,500	2,000
PERFORMANCE		AUTO RWD	AUTO AWD
0-100 km/h	seconds	6.5	6.5
0-60 mph	seconds	6.3	6.2
Top speed	km/h (mph)	246 (153)	246 (153)
FUEL CONSUMPTION ¹			
Urban	l/100km (mpg)	6.5 (43.5)	6.7 (42.2)
Extra Urban	l/100km (mpg)	4.6 (61.4)	4.8 (58.9)
Combined	l/100km (mpg)	5.3 (53.3)	5.5 (51.4)
CO ₂ Urban	g/km	170	176
CO ₂ Extra Urban	g/km	121	126
CO ₂ Combined	g/km	139	144
Tank capacity (usable)	ltr approx.	66	66
DIMENSIONS			
Overall length	mm	4,954	4,954
Overall width (inc. mirrors)	mm	2,091	2,091
Overall width (mirrors folded)	mm	1,987	1,987
Overall height	mm	1,457	1,457
Wheelbase	mm	2,960	2,960
Front track	mm	1,605 (1,597 20" wheels)	1,605 (1,597 20" wheels)
Rear track	mm	1,594 (1,586 20" wheels)	1,594 (1,586 20" wheels)
Ground clearance	mm	116	110
Turning circle diameter (kerb-to-kerb)	m	11.61	11.61
Boot volume*	litres	540	540
WEIGHT ²			
Weight from	kg	1,680	1,740
Gross vehicle weight	kg	2,300	2,350
ENGINE AVAILABILITY			
Pure		●	—
Prestige		●	●
Portfolio		●	●
R-Sport		●	●
S		—	●

TECHNICAL SPECIFICATIONS

 Configure your vehicle at jaguar.com

ENGINES		20t 2.0 LITRE 4 CYLINDER TURBOCHARGED PETROL	25t 2.0 LITRE 4 CYLINDER TURBOCHARGED PETROL	
Capacity	cc	1,997	1,997	
Maximum power	EEC-PS (kW)	200 (147)	250 (184)	
@rev/min	rpm	5,500	5,500	
Maximum torque	EEC-Nm (lb.ft.)	320 (236)	365 (269)	
@rev/min	rpm	1,200-4,500	1,200-4,500	
PERFORMANCE		AUTO RWD	AUTO RWD	AUTO AWD
0-100 km/h	seconds	7.5	6.6	6.6
0-60 mph	seconds	7.1	6.3	6.2
Top speed	km/h (mph)	235 (146)	244 (152)	237 (147)
FUEL CONSUMPTION ¹				
Urban	l/100km (mpg)	8.4 (33.6)	8.4 (33.6)	8.7 (33.0)
Extra Urban	l/100km (mpg)	5.8 (48.7)	5.8 (48.7)	6.0 (47.4)
Combined	l/100km (mpg)	6.8 (41.5)	6.8 (41.5)	6.9 (40.9)
CO ₂ Urban	g/km	192	192	197
CO ₂ Extra Urban	g/km	132	132	137
CO ₂ Combined	g/km	154	154	159
Tank capacity (usable)	ltr approx.	74	74	74
DIMENSIONS				
Overall length	mm	4,954	4,954	4,954
Overall width (inc. mirrors)	mm	2,091	2,091	2,091
Overall width (mirrors folded)	mm	1,987	1,987	1,987
Overall height	mm	1,457	1,457	1,457
Wheelbase	mm	2,960	2,960	2,960
Front track	mm	1,605 (1,597 20" wheels)	1,605 (1,597 20" wheels)	1,605 (1,597 20" wheels)
Rear track	mm	1,594 (1,586 20" wheels)	1,594 (1,586 20" wheels)	1,594 (1,586 20" wheels)
Ground clearance	mm	116	116	116
Turning circle diameter (kerb-to-kerb)	m	11.61	11.61	11.61
Boot volume*	litres	540	540	540
WEIGHT ²				
Weight from	kg	1,635	1,635	1,685
Gross vehicle weight	kg	2,260	2,260	2,310
ENGINE AVAILABILITY				
Pure		●	●	●
Prestige		●	●	●
Portfolio		●	●	●
R-Sport		●	●	●
S		—	—	—

● Available — Not Available

*With Tyre Repair System. 505 litres with space saver spare wheel.

¹Official EU test figures. For comparison purposes only. Real world figures may differ.

²Weights reflect vehicles to standard specifications. Optional extras increase weight.

		35t 3.0 LITRE V6 SUPERCHARGED PETROL		S 3.0 LITRE V6 SUPERCHARGED PETROL	
ENGINES					
Capacity	cc	2,995		2,995	
Maximum power	EEC-PS (kW)	340 (250)		380 (280)	
@rev/min	rpm	6,500		6,500	
Maximum torque	EEC-Nm (lb.ft.)	450 (332)		450 (332)	
@rev/min	rpm	4,500		4,500	
PERFORMANCE					
		AUTO RWD	AUTO AWD	AUTO RWD	AUTO AWD
0-100 km/h	seconds	5.4	5.4	5.3	5.3
0-60 mph	seconds	5.2	5.1	5.1	5.0
Top speed	km/h (mph)	250 (155)	250 (155)	250 (155)	250 (155)
FUEL CONSUMPTION¹					
Urban	l/100km (mpg)	11.7 (24.1)	11.9 (23.7)	11.7 (24.1)	11.9 (23.7)
Extra Urban	l/100km (mpg)	6.3 (44.8)	6.7 (42.2)	6.3 (44.8)	6.7 (42.2)
Combined	l/100km (mpg)	8.3 (34.0)	8.6 (32.9)	8.3 (34.0)	8.6 (32.9)
CO ₂ Urban	g/km	278	282	278	282
CO ₂ Extra Urban	g/km	150	160	150	160
CO ₂ Combined	g/km	198	204	198	204
Tank capacity (usable)	ltr approx.	74	74	74	74
DIMENSIONS					
Overall length	mm	4,954		4,954	
Overall width (inc. mirrors)	mm	2,091		2,091	
Overall width (mirrors folded)	mm	1,987		1,987	
Overall height	mm	1,457		1,457	
Wheelbase	mm	2,960		2,960	
Front track	mm	1,605 (1,597 20" wheels)		1,605 (1,597 20" wheels)	
Rear track	mm	1,594 (1,586 20" wheels)		1,594 (1,586 20" wheels)	
Ground clearance	mm	116		116	
Turning circle diameter (kerb-to-kerb)	m	11.61		11.61	
Boot volume*	litres	540		540	
WEIGHT²					
Weight from	kg	1,710		1,710	
Gross vehicle weight	kg	2,330		2,330	
ENGINE AVAILABILITY					
Pure		●		—	
Prestige		●		—	
Portfolio		●		—	
R-Sport		●		—	
S		—		●	

DIMENSIONS

Overall Width (inc mirrors) 2,091mm
Overall Width (mirrors folded) 1,987mm
Boot Volume 540 Litres*



VEHICLE SHOWN: XF S IN YULONG WHITE WITH OPTIONAL FEATURES FITTED (MARKET DEPENDENT)

Turning Circle
Kerb-to-Kerb 11.61m

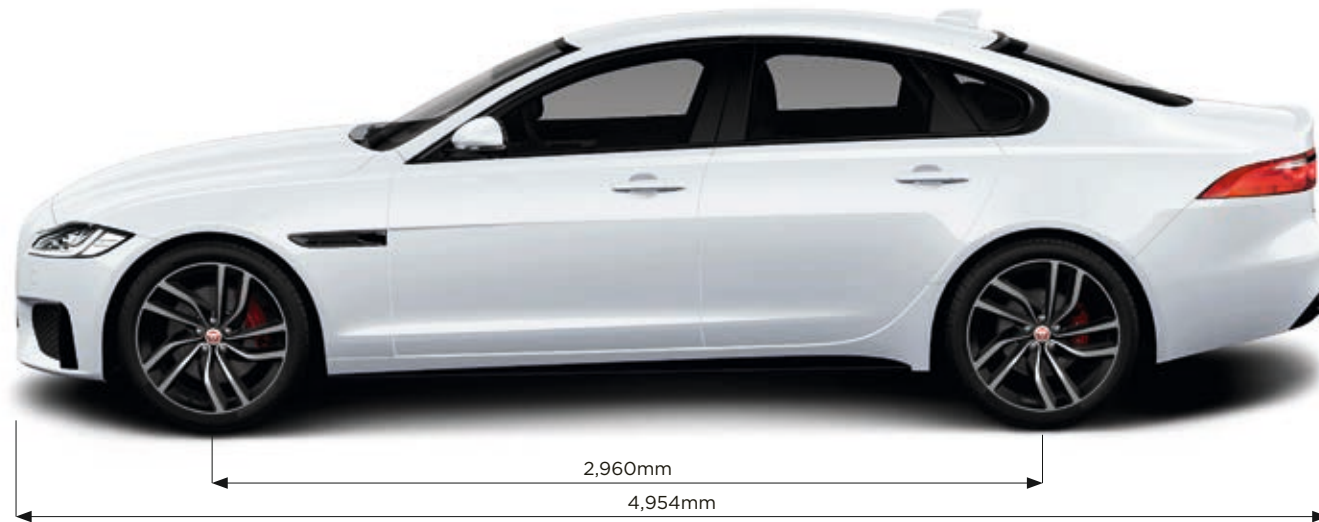

*With Tyre Repair System. 505 litres with space saver spare wheel.
**110mm for 30d 3.0 litre V6 Twin Turbocharged Diesel.
Dimensions were measured with vehicle at unladen weight.
(measured by VDA standard test method using 200 x 100 x 50mm blocks).

JAGUAR EXPERIENCE

There's no better way to get to know Jaguar than by taking a drive. The Jaguar Experience offers a range of unique opportunities to really find out what it feels like to get the most out of a Jaguar. Our track experiences allow you to push yourself and cars from the incredible Jaguar range to the limit. Jaguar Experience also offers the opportunity to see a Jaguar brought to life during a tour of one of our UK manufacturing facilities.

Find out more by visiting jaguar.com/experience



BEHIND THE SCENES

Our factory tours give you the unique opportunity to experience the whole process of how our cars are brought to life - from the moulding of sheet metal to those intricate final touches. At our state-of-the-art production facilities, you'll get to see how skilled technicians and sophisticated machines work seamlessly together to perfect some of Jaguar's most breathtaking cars.

Find out more at jaguar.com/experience-jaguar/behind-the-scenes



DRIVING EXPERIENCES

The opportunity to drive the latest Jaguar cars at their limits, or relive iconic Jaguar history, is rare. Jaguar Driving Experiences offer unique driving adventures you will never forget. Imagine yourself behind the wheel of our highest performing Jaguar models, on a private track, with a Jaguar Experience Instructor at your side. This is the Jaguar Performance Driving Academy.

Find out more at jaguar.com/experience-jaguar/driving-experiences



ICONIC EXPERIENCES

Take your driving to the next level with the Jaguar Land Rover Ice Drive Experience. From 2017, we are offering an adventure in Arjeplog, Sweden, that will test and develop your performance driving skills in extreme conditions. It's a rare chance for owners and enthusiasts to tackle some of the harshest and most challenging tracks on earth, under the skilled guidance of our experts. Our driving instructors are of the highest-calibre and will be with you every step of the way - ready to impart years of driving wisdom. You will dance on ice, glide around some of the most awe-inspiring corners imaginable and realise the true exhilarating potential of Jaguar and Land Rover.

If you'd like to be part of the next adventure, find out more by visiting: jaguar.com/experience-jaguar/iconic-experiences

THE WORLD OF JAGUAR

Choose an XF and you're joining the exciting World of Jaguar. It makes owning and driving carefree and easy, as well as providing a range of exclusive services and lifestyle products.



JAGUAR CARE*

XF is offered with unlimited mileage, three year warranty and three years' standard servicing programme. We call this programme Jaguar Care. It makes XF's overall cost of ownership one of the lowest in its class.

To find out more about XF's Jaguar Care programme, please go to jaguar.com/jaguarcare

SERVICING

XF has been designed to keep servicing costs to a minimum - for example, the new Ingenium diesel engines can achieve an incredible 34,000km or 2 years** between services due to intelligent design and advanced oil technology.

GENUINE PARTS

Jaguar Genuine Parts are designed, tested and manufactured to our uncompromising standards for quality, fit and durability. Each part is engineered specifically for your XF to contribute to optimum performance and to help maximise its lifespan.

FLEET & BUSINESS

Jaguar is dedicated to being the premium manufacturer of choice for fleets and businesses by providing a highly attractive car range and exemplary customer service. Jaguars are dynamic and distinctive cars that help companies express the unique character and personality of their business. We are committed to providing totally customer-focused aftersales services, which keeps every Jaguar car on the move and in top condition, ensuring that they perform to the highest standard and in the most cost-efficient way for businesses. Visit jaguar.com/fleet-and-business

*Selected European markets only.
**Market and driving style dependent.
†Manufacturer's estimate.



JAGUAR FINANCIAL SERVICES

Effortless performance and style come as standard with every Jaguar. Jaguar Financial Services makes buying one just as simple and rewarding. New or used, for personal or business use, we have an option that puts you in complete control. Please speak to your local Jaguar Retailer to find out more.



JAGUAR ASSISTANCE

Jaguar Assistance provides assistance in motoring emergencies, from immobilisation due to breakdown or accident to minor problems such as punctures. You can rely on our roadside assistance, whatever the situation, wherever you happen to be.

LOW INSURANCE

XF's key components are easily accessible for time-efficient service and repair and to minimise scheduled maintenance and repair costs. With a focus on lower repair costs, XF delivers competitive insurance group ratings[†]. To find out more about the compelling business case for XF, please contact your local Jaguar Retailer.



JAGUAR MAGAZINE

This is our own vibrant, cosmopolitan and contemporary magazine. Produced by a team of enthusiastic designers and feature writers, it goes behind the scenes at Jaguar as well as providing insight into the world of luxury, design, style and travel. You can enjoy Jaguar Magazine twice a year completely free of charge for the first three years. Ask your retailer to ensure that you receive your copy.

JAGUAR COLLECTION

The latest range from the Jaguar Collection has been crafted with the same design execution and attention to detail that goes into all of our cars. This is evident in our clothing range, premium leather items and luxury travel goods. To celebrate Jaguar's heritage we also have a collection that honours past achievements and features race inspired gift items and apparel. To find out more, visit the online shop at www.jaguar.com/shop

GLOSSARY

A

ADAPTIVE FULL LED HEADLIGHTS

Adaptive headlights automatically adjust to follow steering inputs, casting light where needed. They will angle the beam when indicating, as well as working in conjunction with Automatic High Beam Assist to prevent your lights from dazzling oncoming traffic.

ADVANCED PARK ASSIST

Advanced Park Assist offers all the functions of Park Assist (see pg. 48) plus 360° Park Distance Control with virtual object tracking. This gives confidence in confined situations, at speeds up to 16km/h.

ADAPTIVE SPEED LIMITER

The Adaptive Speed Limiter, when selected, will assist in limiting vehicle speed to the speed limits as recognised by the Traffic Sign Recognition system.

AUX CONNECTION

Auxiliary (AUX) connections allow for the convenient input of audio signals from personal devices.

C

Cd

The Cd value is the drag coefficient of the car. It gives an indication of the vehicle's aerodynamic qualities. The lower the value, the more aerodynamically efficient the vehicle's design.

CONFIGURABLE INTERIOR MOOD LIGHTING

Configurable Interior Mood Lighting highlights a number of your Jaguar's key functional and styling features and allows adjustment of the ambient light. Choose from a range of ten colours.

CONNECTIVITY PACKAGE

A connectivity package is a bundle of applications and technologies that enhances your connection with your Jaguar and with the world by giving internet connectivity, optimised in-car applications and remote access to your car.

D

DAB RADIO

The DAB (Digital Audio Broadcast) radio system offers clarity of reception, a wide choice of stations and live text information about the station, show and song you are listening to.

DAMPERS/DAMPING

Dampers absorb forces acting on the suspension for greater ride comfort and control. Dampers are also known as shock absorbers.

DEAD RECKONING

Dead Reckoning uses sensors to measure vehicle direction, wheel rotation and inclination. These measurements are calibrated up to 40 times per second to ensure accurate placement of the vehicle even when no GPS signal is available.

DRAG COEFFICIENT

The drag coefficient measures how aerodynamic a car is. See definition of Cd.

E

ECO MODE

Eco Mode encourages fuel efficient driving by reducing throttle sensitivity, selecting more economical engine mapping and, on manual vehicles, advising of gearshifts. It also reduces fuel consumption by reducing the energy demands placed on the engine by climate control and audio systems.

F

FORWARD ALERT

Should a potential collision be detected Forward Alert gives an audible warning and a visual warning in the instrument cluster.

FOUR-ZONE CLIMATE CONTROL

Four-zone Climate Control that can be optimised for individual occupants.

12.3" FULL DIGITAL INSTRUMENT PANEL

The 12.3" Full Digital Instrument Panel is a TFT (Thin Film Transistor) screen that replaces the traditional instrument cluster. It displays a wide range of key driving information. Four graphical themes and a 3D Map View are available.

G

GPS

The Global Positioning System (GPS) uses satellites to determine the car's position. By cross-referencing this with road maps stored in its memory, the navigation system provides route guidance and tracks the car's location.

I

INGENIUM ENGINES

Ingenium engines are manufactured in the UK at Jaguar Land Rover's state-of-the-art Engine Manufacturing Centre in the West Midlands. The aluminium engines feature lightweight construction, with stiff cylinder blocks and decoupled injectors, which ensure low levels of vibration and noise intrusion, further enhancing the driver experience. A series of advanced technologies reduce internal friction, improve refinement and enhance overall performance. In addition, Selective Catalytic Reduction and a new low-pressure exhaust gas recirculation system significantly reduce both CO₂ and NOx emissions on diesel engines.

INTERIOR MOOD LIGHTING

Interior mood lighting highlights many of the cabin's key features and design details in a relaxing soft Phosphor Blue glow.

INTELLIGENT STOP/START

Stop/Start is a technology that stops the engine when it is not needed, improving the fuel economy and reducing the car's CO₂ emissions. The engine will restart as soon as the driver's foot comes off the brake pedal. The engine will be operating at full capacity before the driver's foot has touched the accelerator pedal.

J

JAGUAR SIGNATURE 'J' BLADE DAYTIME RUNNING LIGHTS

'J' blade Daytime Running Lights are separate LED running lights, in a distinctive 'J' shape, built into the headlights. They emphasise Jaguar's striking on road style.

JAGUARDRIVE CONTROL

Interacts with the Dynamic Stability Control system, engine and transmission management systems to alter the characteristics of the engine mapping, gearshifts and brakes. It offers different modes designed to optimise the vehicle's response to particular driving conditions and styles.

JAGUARDRIVE SELECTOR

The JaguarDrive Selector rises from the centre console on start up. It is a rotary shifter used with automatic transmissions that allows you to quickly shift between drive modes.

L

LED HEADLIGHTS WITH LED 'J' BLADE DAYTIME RUNNING LIGHTS

Multiple powerful LED emitters give a clearer light in low light conditions. Further complemented with LED 'J' blade Daytime Running Lights incorporating LED direction indicators. These lights also integrate Jaguar's Adaptive Lighting and Auto High Beam Assist systems.

M

MHL CONNECTION

A Mobile High-Definition Link (MHL) enables connection between a personal device and the InControl infotainment system. It is designed for seamless transfer of audio-visual data.

10.2" MULTI-TOUCH DISPLAY

The multi-touch functionality of Touch Pro's 10.2" Display allows the screen to recognise multiple points of contact. This provides direct control of the system's features in a more natural, intuitive way, enabling gestures such as pinch and zoom.



R

RAIN ICE SNOW MODE

By selecting Rain Ice Snow Mode, the system automatically dampens acceleration and applies more gradual torque for improved traction in slippery conditions.

S

SATELLITE VIEW

Satellite View allows you to view satellite imagery as an optional view mode for the navigation system.

SECURE TRACKER

Secure Tracker provides stolen vehicle tracking. Tracking technology alerts you to an attempted theft and shares your vehicle's location with the authorities for a timely recovery.

SD CARD

A Secure Digital (SD) Card is a flash memory card used for storing large amounts of data in a compact form.

SOLID STATE DRIVE

Solid State Drives are storage devices with no moving parts designed for rapid retrieval of large quantities of data.

X

XENON HEADLIGHTS

Bi-function Xenon headlights offer improved illumination and feature LED 'J' blade Daytime Running Lights for a striking on road style.

IMPORTANT NOTICE

Jaguar Land Rover Limited is constantly seeking ways to improve the specification, design and production of its vehicles and alterations take place continually. While every effort is made to produce up-to-date literature, this brochure should not be regarded as an infallible guide to current specifications, nor does it constitute an offer for the sale of any particular vehicle. Vehicles shown in this brochure are from the Jaguar Global range. Specifications, options and availability will vary between markets and should be verified with your local Jaguar Retailer. Distributors and retailers are not agents of Jaguar Land Rover Limited by any express or implied undertaking or representation. Comparisons are based on manufacturer's own data and testing prior to publication.

COLOURS

Print and online colours are representative only.

ENVIRONMENTAL INNOVATION AT JAGUAR

Jaguar is committed to reducing dependency on fossil fuels, using fewer natural resources and creating less waste as part of our approach to responsible and sustainable business development, called Environmental Innovation.

Our innovative use of lightweight aluminium (featured in the F-PACE, XF, XE, XJ and F-TYPE) is helping to improve fuel consumption and lower tailpipe CO₂ emissions, as well as delivering other handling and performance benefits to these vehicles.

At the same time, our smart management of resources enables scrap aluminium reclaimed from our stamping process to be segregated and recycled to create the same quality of aluminium sheet with up to 50% recycled content. Compared to using virgin aluminium, this closed-loop recycling system also reduces CO₂ emissions during the manufacturing process.

As a whole, Jaguar Land Rover has reduced its European fleet average tailpipe emissions by 25% versus 2007 and operational CO₂ emissions per vehicle by 30.5%*. Our manufacturing facilities are all certified to ISO14001 and we have cut the amount of manufacturing waste to landfill per vehicle by 75%* and reduced our water consumption per vehicle by 34%*. *Versus 2007.

As part of our journey to Carbon Neutral Manufacturing by 2020, we offset 100% of (currently unavoidable) operational CO₂ emissions by investing in projects that reduce the equivalent amount of CO₂ emissions in other ways, providing social and humanitarian benefits at the same time. For example, our award winning Lifestraw 'carbon for water' emissions reduction project has prevented the release of 968,000 tonnes of CO₂ (since it began in 2013) and improved the lives of 2.4 million people in Kenya.

Taking into account the company's global sales growth and increased investment in more efficient operating facilities, we are proud of the progress we have made against our 2020 Environmental Innovation targets to date. Our achievements have also been recognised externally: In 2013 the Company was recognised as the UK's Responsible Business of the Year by leading CR index, Business in the Community and in 2014 we were awarded the Queen's Award for Enterprise in Sustainable Development.

Looking forward, we have developed a 2020 vision for sustainable business growth that focuses on continued improvements in operating & tailpipe CO₂ emissions, carbon neutral manufacturing and zero waste. Jaguar Land Rover also aims to improve the lives of 12 million people by 2020 as part of its global Corporate Social Responsibility programme.

Meridian is the registered trademark of Meridian Audio Limited.

AdBlue® is the registered trademark of the Verband der Automobilindustrie e. V. (VDA).

The Bluetooth® word mark and logos are owned by the Bluetooth SIG, Inc. and any use of such marks by Jaguar Land Rover Limited is under licence.

iPod, iPod touch and iPad are trademarks of Apple Inc, registered in the US and other countries.

VEHICLE SHOWN FRONT COVER: XF S IN YULONG WHITE WITH OPTIONAL FEATURES FITTED (MARKET DEPENDENT)

VEHICLE SHOWN BACK COVER: XF R-SPORT IN CORRIS GREY WITH OPTIONAL FEATURES FITTED (MARKET DEPENDENT)

Jaguar Land Rover Limited
Registered Office: Abbey Road, Whitley,
Coventry, CV3 4LF, United Kingdom
Registered in England Number: 1672070
jaguar.com

PRINTER
TO REPLACE
FSC LOGO

