

NEW RANGE ROVER VELAR SVAUTOBIOGRAPHY DYNAMIC EDITION



ABOVE & BEYOND





BY APPOINTMENT TO
HM THE QUEEN
MANUFACTURERS OF
MOTOR VEHICLES
JAGUAR LAND ROVER LIMITED
COVENTRY



BY APPOINTMENT TO
HRH THE DUKE OF EDINBURGH
MANUFACTURERS OF
MOTOR VEHICLES
JAGUAR LAND ROVER LIMITED
COVENTRY



BY APPOINTMENT TO
HRH THE PRINCE OF WALES
MANUFACTURERS OF
MOTOR VEHICLES
JAGUAR LAND ROVER LIMITED
COVENTRY



ABOVE & BEYOND

Ever since the first Land Rover vehicle was conceived in 1947, we have built vehicles that challenge what is possible. These in turn have challenged their owners to explore new territories and conquer difficult terrains. Our vehicles epitomise the values of the designers and engineers who have created them. Each one instilled with iconic British design cues, delivering capability with composure. Which is how we continue to break new ground, defy conventions and encourage each other to go further. Land Rover truly enables you to make more of your world, to go above and beyond.





NEW RANGE ROVER VELAR SVAUTOBIOGRAPHY DYNAMIC EDITION

“Building on Velar’s award for World Car Design of the Year 2018, the 5.0 litre V8 SVAutobiography Dynamic Edition takes refinement and performance to new levels”.

Michael Van Der Sande
Managing Director of Special Vehicle Operations

CONTENTS

INTRODUCTION	06
UNIQUE FEATURES	08
DESIGN	12
PERFORMANCE	20
TECHNOLOGY	31
SAFETY	40
VERSATILITY	42
SPECIFICATIONS	44
THE WORLD OF LAND ROVER	52
AT YOUR SERVICE	57

Vehicle shown on front cover is Range Rover Velar SVAutobiography Dynamic Edition in Byron Blue with Satin finish. Optional features fitted.

Interior shown is Range Rover Velar SVAutobiography Dynamic Edition with Ebony/Cirrus interior in Windsor leather and optional Steel Weave Carbon Fibre veneer.

Vehicles shown are from the Land Rover global range. Specifications, options and availability will vary between markets and should be verified with your nearest Land Rover Retailer.

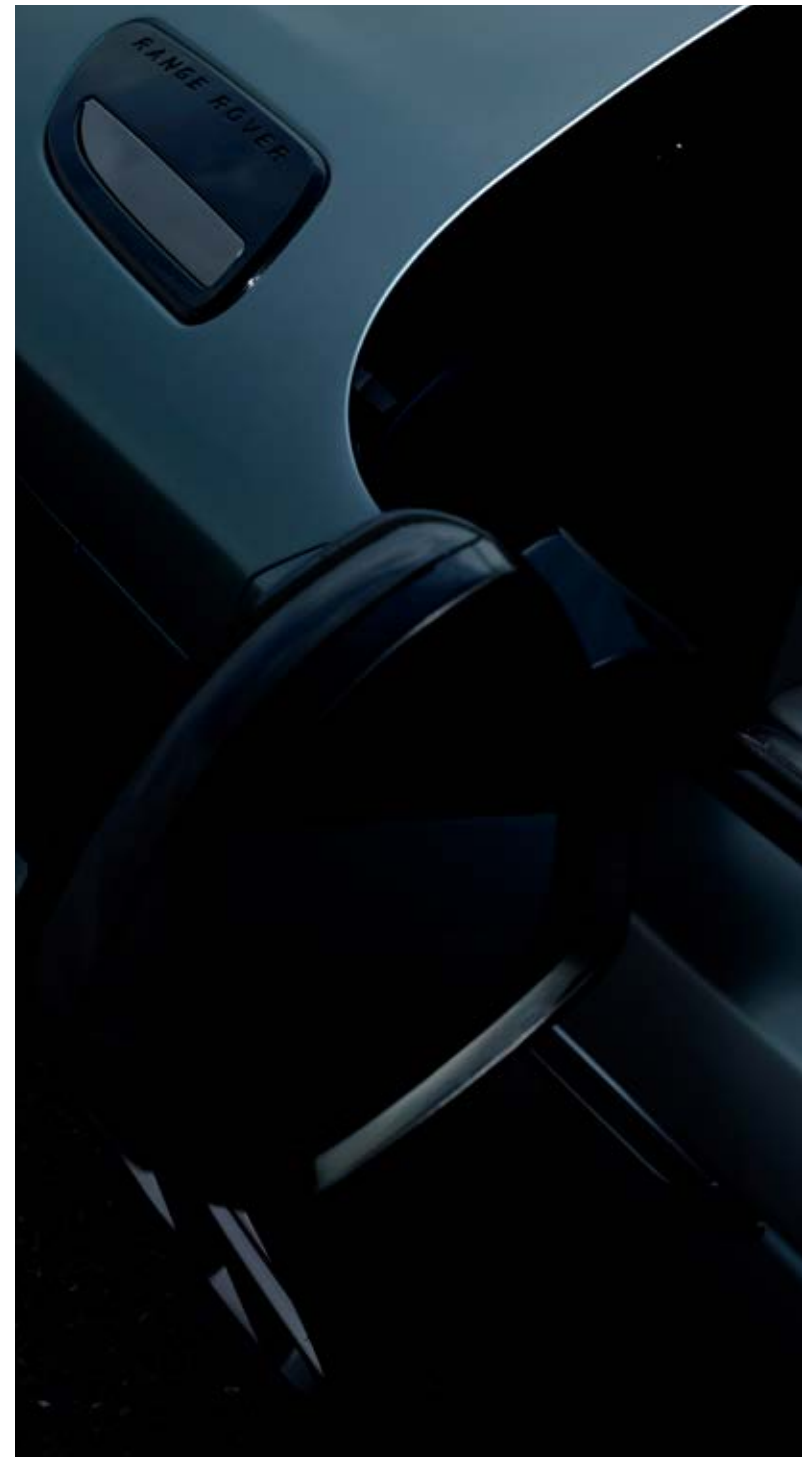



INTRODUCTION

WORLD CAR DESIGN OF THE YEAR 2018. REDEFINED.

Range Rover Velar has won plaudits and awards from owners and the world's leading design juries alike. Range Rover Velar SVAutobiography Dynamic Edition aims to dramatically add to that story. Born of reductive design principles, Velar's signature formality and sporting emphasis has been perfectly redefined to create the vehicle's dynamic stance, together with elegance and sophistication. With its V8 engine, a first for Range Rover Velar, it is both responsive and thrilling to drive. Added to which, the calm sanctuary of the interior is raised to a new level of performance focus. Range Rover Velar SVAutobiography Dynamic Edition represents the ultimate in design and refinement.





NEW RANGE ROVER VELAR SVAUTOBIOGRAPHY DYNAMIC EDITION UNIQUE FEATURES

Introducing several features found on no other Range Rover, this vehicle feels truly personal.

DESIGN

Performance-orientated design offers unique aerodynamic features including a front bumper with larger air intakes, new grille, rear bumper and side cladding. This is perfectly complemented by the bonnet and fender vents, which have a unique Gloss Black outer finish and Graphite Atlas inner finish. The forged 21" alloy wheels, exclusive to Range Rover Velar SVAutobiography Dynamic Edition, serve to enhance the striking design. See page 12 for more design details.

AERODYNAMICS

Enhancements such as the aerodynamic transmission tunnel undertray, together with SV dynamic steering calibration and uprated air suspension with SV tuning, combine to create our most refined and dynamic on-road performance vehicle.

See page 22 for details.





ENHANCED INTERIOR ENVIRONMENT

The cabin's premium sporty characteristics are further enhanced by the 20-way Windsor leather seats. These feature heated, cooled and massage functions as standard. With a Diamond quilted pattern, they provide another level of distinction. A knurled rotary shifter and control dials emphasise the vehicle's refined credentials. See page 17 for details.

PERFORMANCE

The 5.0 litre V8 Supercharged-Petrol engine with upgraded supercharger delivers the ultimate driving experience. Sports-tuned Electronic Differential (E-diff system) ensures the greatest level of traction in all weather conditions, both on and off-road. See page 20 for details.

REFINED EFFICIENT POWER

The Supercharged V8 engine effortlessly delivers class-leading 550PS power and torque of 680Nm. The 8-speed 'Quickshift' Automatic Transmission and updated Dynamic Driving Mode for Performance Driving ensure an exceptional, dynamic driving experience. See page 11 for details.





REFINED POWER

Building on the highly prized Range Rover Velar, SVAutobiography Dynamic Edition's design has been refined even further. Cleaner body sides with cladding help give the vehicle a lower, wider profile. One that truly emphasises its powerful, purposeful look. Its all-new front grille has a foil effect with a three dimensional aspect which adds another unique attribute.

Compelling design, emphasising the sporting nature of this high performance vehicle, a 5.0 litre V8 Supercharged Petrol engine delivering 550PS, 680Nm of torque and 0-100km/h in 4,5 seconds combined with a contemporary, sophisticated interior all deliver uncompromised levels of refined power.

DESIGN

DESIGNED TO PERFORM

Range Rover Velar SVAutobiography Dynamic Edition takes the Land Rover bloodline to striking new territories. New features include a unique front grille and surround, a front bumper with larger openings to aid engine cooling, and rear bumpers. Whilst such design details as quad tailpipes and forged wheels add greatly to the vehicle's dramatic looks. These elements are further complemented by a unique colour – Byron Blue in Satin finish.





RANGE ROVER

VELAR

HSW 312





Compelling design amplifies its poised, sporting stance and helps enhance its performance. The effortlessly flowing roofline smooths airflow over the vehicle to reduce drag. The optional 22" forged wheels amplify its stunning looks, while the new exhaust endows the vehicle with a distinctive sound.

Vehicles shown are Range Rover Velar SVAutobiography Dynamic Edition in Byron Blue with Satin finish. Optional features fitted.







A LUXURIOUS SPORTING INTERIOR

Unique refinements to Range Rover Velar SV Autobiography Dynamic Edition include 20-way quilted Windsor leather front seats with heated, cooled, memory and massage functions, premium carpet mats and a knurled metal rotary shifter. All of these add to the vehicle's formal yet contemporary interior, created with the driver in mind. A truly individual steering wheel with thumb rests, a thicker section and aluminium gearshift paddles, together with such features as new dials, add to that contemporary sporting feel.



Ultra-soft perforated Windsor leather seats feature a unique Diamond quilted pattern.



The dials feature knurled edging and are a delight to the touch.



Range Rover Velar SV Autobiography Dynamic Edition steering wheel features aluminium paddles.



Shadow Aluminium Finisher door panels echo the finishers.



PERFORMANCE

SUPERCHARGED PERFORMANCE

Combining exceptional on-road ability with class-leading off-road capability, Range Rover Velar SVAutobiography Dynamic Edition looks, sounds and performs like no other. Its performance is delivered by the 5.0 litre V8 Supercharged Petrol engine with an upgraded supercharger that produces class-leading power of 550PS and 680Nm of torque. The acceleration takes you from 0-100km/h in just 4,5 seconds.

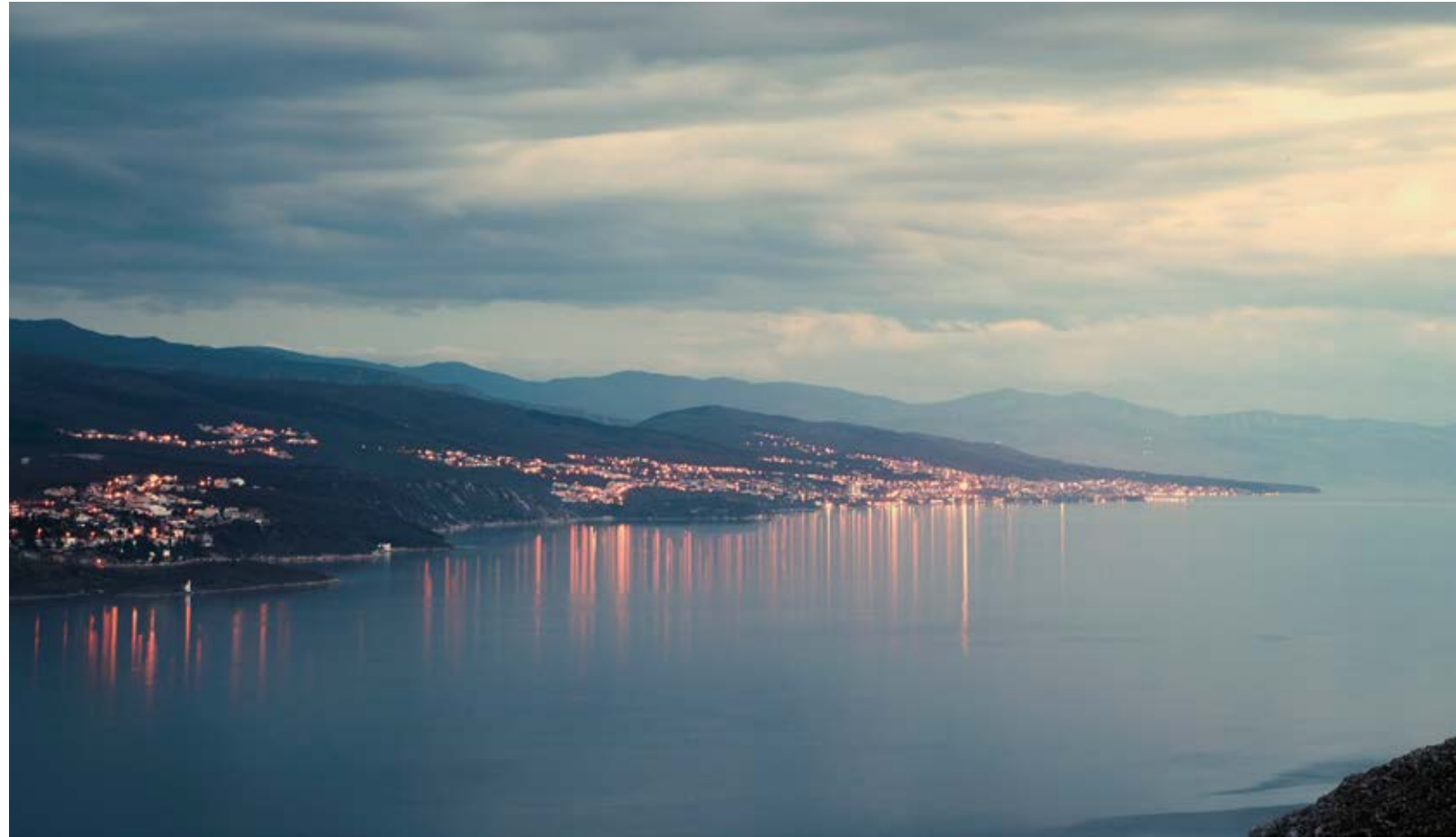



AERODYNAMICS

Range Rover Velar SVAutobiography Dynamic Edition's modern, compelling design isn't simply for appearance. Its new features combine to amplify cooling and improve the vehicle's aerodynamic performance which, together with such renowned features as Terrain Response 2, helps deliver increased breadth of capability.



TRANSMISSION TUNNEL UNDERTRAY

The revised exhaust system enables the addition of an aerodynamic tunnel tray to improve underfloor flow control and reduce drag.

FRONT BUMPER AND BRAKE DUCTS

The new front bumper intake maximises airflow, cooling both the engine and brakes for improved performance. A new front valance manages the airflow to help reduce drag.



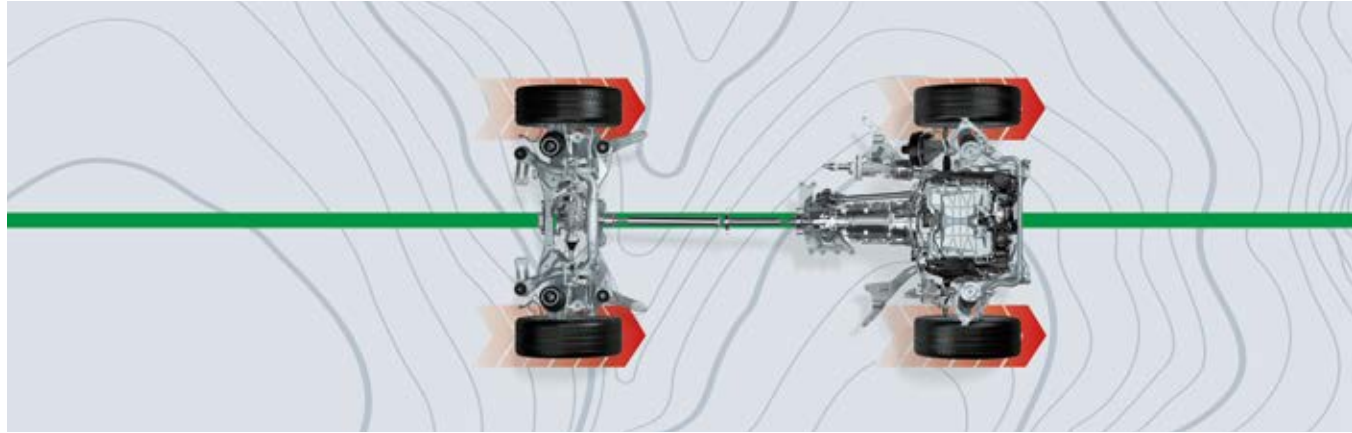

SUPREME CAPABILITY OFF AND ON-ROAD

CHASSIS AND SUSPENSION

The vehicle's strong, stiff body structure is inherently stable which enables precise, agile handling and allows the uprated suspension system to deliver better driver connection with the road. SVO has optimised the damping set-up to provide the optimum partnership between dynamics and refinement. They've also revised the damper control system, specifically tuned the shock absorbers and added new stiffer front and rear springs and stiffer suspension link bushes for the perfect combination of control, agility and feedback.

At the front, its aluminium double wishbone suspension is modelled closely on Jaguar F-TYPE for precise handling and control, while modified anti-roll bars greatly reduce the vehicle's body roll during fast cornering or over challenging road surfaces. An Integral Link suspension system at the rear provides stiffness to support handling, improve ride quality even further and to extend the breadth of dynamic capability.

PERFORMANCE BRAKING SYSTEM

Instantly recognisable with striking Red Land Rover calipers, the vehicle's Performance Braking System offers a fast, precise response – especially when repeatedly braking from high speed – due to its excellent fade resistance. The rear caliper also features an integrated Electronic Parking Brake (EPB).

ELECTRONIC ACTIVE DIFFERENTIAL

The vehicle features a new Electronic Active Differential system that works together with the Torque Vectoring by Braking (TVBB) system. A second multi-plate wet clutch between the rear wheels can lock almost instantly to provide full engine output torque to both wheels. This can be especially useful to deliver effortless capability in low-grip conditions such as patchy ice or wet grass. It also provides maximum traction when exiting a corner, as when the inside wheel loses traction due to weight transfer, the Electronic Active Differential increases torque to the outside wheel.

ALL WHEEL DRIVE WITH INTELLIGENT DRIVELINE DYNAMICS (IDD)

Special Vehicle Operations has tuned Range Rover Velar SVAutobiography Dynamic Edition's All Wheel Drive system to deliver remarkable performance and handling. The system uses a torque-biased differential that substantially improves traction. It has the full capability of 100 percent rear bias to 100 percent front wheel bias should conditions require it. Where road conditions are changeable, over 90 percent of torque can be intelligently distributed from the rear wheels to the front to optimise traction in all conditions. On slippery surfaces, such as grass and mud, torque can be balanced 50:50 between the front and rear wheels to maximise traction.

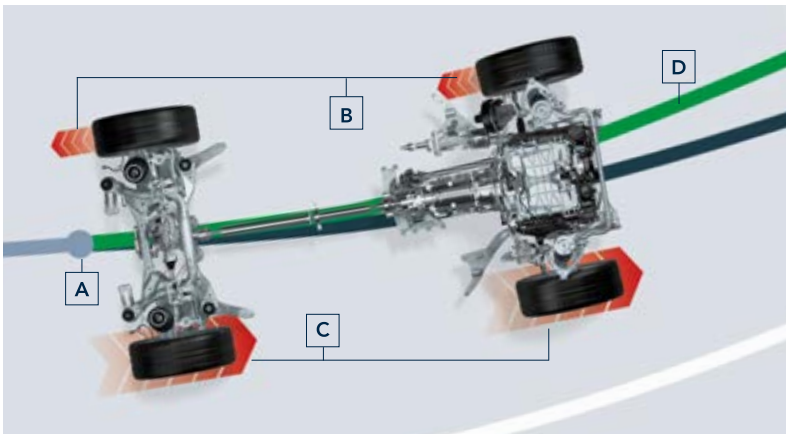

TORQUE VECTORING

Torque Vectoring by Braking delivers controlled, responsive cornering by reducing near-limit understeer through controlled braking of the inside wheels.

- A** Understeer detected
- B** Braking force to inner wheels
- C** Torque to outside wheels maintained
- D** Line corrected

ADAPTIVE DYNAMICS

The Adaptive Dynamics system delivers both precise handling and a supple, luxurious ride by monitoring wheel position and body movements. To do this, the system constantly analyses acceleration, steering, throttle and brake pedal activity. The electronically controlled dampers adjust to optimise the suspension settings and provide the optimum balance between comfort, refinement and agility at all times.

CONFIGURABLE DYNAMICS

To enhance either refinement and comfort or the vehicle's performance, the Configurable Dynamics function allows you to configure the throttle mapping, gearbox shift points, steering settings and suspension to suit your driving needs.







HILL DESCENT CONTROL

Land Rover's patented Hill Descent Control (HDC) is a standard feature. It assists the driver with controlled descents of difficult slopes. It does so by maintaining a constant speed and applying braking separately to each wheel. Hill Launch Assist, which also comes as standard, ensures the vehicle doesn't roll backwards as it pulls away on an incline. The vehicle also utilises Gradient Release Control (GRC), which again comes as standard, and is designed to prevent the vehicle accelerating too quickly on a steep incline when the driver releases the brake.

ALL TERRAIN PROGRESS CONTROL

All Terrain Progress Control (ATPC) is a state-of-the-art optional system that enables you to set and maintain a steady speed in challenging conditions such as slippery surfaces, including: mud, wet grass, ice, snow and dirt roads. Operating like a cruise control system, it functions between 3,5km/h and 30km/h, enabling you to maintain full concentration on steering and finding a path through obstacles.

TERRAIN RESPONSE

When you manually select Land Rover's unique standard Terrain Response system, it sets the vehicle up to optimally match the demands of the terrain by adapting the responses of the vehicle's engine, gearbox, differentials and chassis systems. There are six Terrain Response settings: Comfort, Grass/Gravel/Snow, Mud & Ruts, Sand, ECO and Dynamic Mode.

TERRAIN RESPONSE 2

Terrain Response 2 is an option that takes the capabilities of the award-winning system to a new level. This features an automatic setting which monitors the current driving conditions and systematically selects the most suitable terrain setting. You can manually override the system should you wish. This function works seamlessly through the Touch Pro Duo's Control Panel (lower Touchscreen).

WADE SENSING

Unique to Land Rover, this optional system uses ultrasonic sensors in the wing mirrors to visually and audibly alert the driver if the water approaches the vehicle's class-leading wading depth of up to 650mm. It does so by providing real-time pictorial information via the Touchscreen about its depth in relation to the vehicle and its maximum wading capability. Only available with 360° Surround Camera.





INFOTAINMENT

Unique to Land Rover, the InControl infotainment system, Touch Pro Duo not only looks like no other, it performs like no other. Delivering a wealth of information and entertainment, it features the most intuitive and advanced integrated technologies to ensure everyone can make the most of their journey.



TOUCH PRO DUO

The standard 10" dual high-definition Touchscreens allow the user to view required information whilst simultaneously being able to interact with additional features, for increased flexibility and efficiency of use. For instance, you can use the navigation system in the upper screen whilst playing media on the lower screen. Direct access to cabin and seat temperature controls are also available via the multi-function dynamic dials. For a truly elegant and streamlined appearance, the steering wheel also has hidden-until-lit, touch-sensitive switches as standard. One of these switches is programmable, so that it can be personalised to your preferences to accomplish a host of functions.



INTERACTIVE DRIVER DISPLAY

The 12.3" high-definition Interactive Driver Display can receive and project a vast amount of driving information, entertainment and active safety data including navigation, phone and media. Its high resolution ensures the utmost clarity and its refined processing engine delivers smooth moving pin sharp graphics. To help you find your way more easily, Navigation Pro enables you to display full screen navigation with 3D mapping.



HEAD-UP DISPLAY

To help reduce distraction or the need for you to take your eyes off the road, Head-up Display is an option that presents key vehicle data such as your speed, gear position and navigation directions on the windscreen. It features crystal clear full-colour graphics in high resolution, enabling you to see all driver inputs and information with ease. It can display important information from the Touch Pro Touchscreen and your phone. The feature can be turned on and off dependent on driver preference.



REAR SEAT ENTERTAINMENT

The optional Rear Seat Entertainment system provides two 8" screens built into the rear of the front headrests. It includes 'Journey Status': a Navigation Summary screen which displays a pop-up for the rear occupant detailing the time and distance to destination. The system comes with two pairs of WhiteFire® digital wireless headphones and HDMI, Mobile High-Definition Link (MHL) and USB connections. Passengers can also enjoy their favourite TV shows via the optional digital TV feature. Digital TV channels can be watched on the 10" Touchscreen in the front cabin and the Rear Seat Entertainment screens.

All in-car features should be used by drivers only when safe for them to do so. Drivers must ensure they are in full control of the vehicle at all times. WhiteFire® is a registered trademark of Unwired Technology LLC and any use of such marks by Land Rover is under licence.

AUDIO

A vehicle's cabin is the ideal place within which to experience your personal choice of music. Range Rover Velar SVAutobiography Dynamic Edition has the option of two different audio systems to bring your music to life:

 22 SPEAKERS

 SUBWOOFER



MERIDIAN™ SURROUND SOUND SYSTEM (STANDARD)

All the fullness and clarity of a live performance delivered through an arrangement of 16 front, side and rear speakers and a dual channel subwoofer – seamlessly brought together using Trifield™ technology. Exclusive to Meridian, Trifield perfectly blends the centre and surround channels with left and right channels ensuring an optimum, consistent sound experience for each passenger.

MERIDIAN SIGNATURE SOUND SYSTEM (OPTIONAL)

This delivers truly life-like reproduction, creating a profound, personal sound experience for every seat. World-first Trifield 3D technology takes surround sound to the next level, the Signature Sound System includes 22 speakers and a dual channel subwoofer. Incredibly authentic, the sense of cabin space is expanded to a 3D experience – rendering all the instruments, performers and venues of your favourite performances in true scale and location.

DAB RADIO (OPTIONAL)

The option of DAB radio technology offers improved sound quality, a wide choice of stations and live text information about the station, show and song you are listening to.

MERIDIAN™

Formed in 1977 in Cambridgeshire, England, Land Rover's audio partner Meridian has pioneered many firsts including active speakers and the world's first digital surround sound processor. Meridian's audio technology input has helped ensure that Range Rover Velar SVAutobiography Dynamic Edition is the most superb space within which to experience sound. Meridian Cabin Correction technology was utilised to analyse cabin shape, acoustics and resonance characteristics in order to help remove unwanted sounds.

The advanced algorithm ensures that the rhythm, punch and timing of any piece of music are heard precisely how the artist intended, providing a consistently exceptional quality audio experience for all passengers in the vehicle.



DIGITAL SIGNAL PROCESSING

Brings all elements of the audio system together as one, for performance that would otherwise require significantly larger speakers.



MERIDIAN CABIN CORRECTION

The advanced algorithm of Meridian's Cabin Correction tailors the sound experience to the precise acoustics of vehicle's interior.



MERIDIAN DIGITAL DITHER SHAPING

To maintain the quality of musical recordings, they are converted into a common digital format. Meridian Digital Dither Shaping ensures that digital signal conversions are made smoothly and seamlessly, preserving the finest details of the audio performance. The result is authentic musical conversion, evoking the emotions of the original recording.











TRIFIELD™

Exclusive to Meridian, Trifield blends the centre and surround channels seamlessly with left and right channels, delivering a consistent, concert-like experience for all occupants.



TRIFIELD 3D

Building on Meridian's proven Trifield surround sound technology – world-first in-car Trifield 3D truly brings musical performances to life. Through the addition of dedicated height channels, the sense of cabin space is expanded to a 3D experience, for a supreme sense of scale and definition to your music.

	UNIQUE MERIDIAN TECHNOLOGY				SPEAKERS	SUBWOOFER	WATTS
Meridian™ Surround Sound (standard)					16	1	825
Meridian™ Signature Sound (optional)					22	1	1600

Meridian is a registered trademark of Meridian Audio Ltd.
Trifield and the "three fields" device is a trademark of Trifield Productions Ltd.
Features and their availability may differ by vehicle specification and market.

CONNECTIVITY

InControl is Land Rover's suite of standard and optional features that connects you to your vehicle and links you seamlessly, and securely, with the outside world. With a selection of apps, even when you're away from your vehicle, some of the InControl features stay with you making sure the Land Rover experience is more enjoyable than ever.

STANDARD FEATURES

VOICE RECOGNITION SYSTEM

Understands clear spoken instructions, so you can concentrate on the road ahead without any distractions.

REMOTE¹

The **Remote** app provides upgraded information on your vehicle and enables you to interact with it remotely. Compatible with most smartphones, Android Wear™ or the Apple Watch®, this service includes:

- **Remote Lock/Unlock** – Lock or unlock your doors remotely with the click of a button. Simply press the 'lock' button on the Vehicle Security screen of the Remote smartphone app to single lock the doors, arm the alarm, fold in the wing mirrors and close the windows. Press the 'unlock' button to unfold the wing mirrors, turn on the dipped headlights and cause the hazard lights to flash twice.
- **Remote Climate** – Prepare your Land Rover in advance by pre-heating or pre-cooling the cabin, so that you and your passengers are comfortable from the moment you step inside.
- **Beep/Flash** – This feature turns on your Land Rover's hazard lights, dipped headlights and sounds an audible alert to help you locate your vehicle in a crowded car park.

- **Journey Tracking** – This opt-in feature can automatically record your journey history including your route and mileage statistics. This information can be exported by email to use for expense reporting and can be imported to a spreadsheet.
- **Vehicle Status Check** – Check current fuel level and range, and status of door and window position and locks. See the last parked location of the vehicle and find your way back to it with on-foot directions.

Land Rover Optimised Assistance² – If you break down you can make a direct call to the Land Rover Assistance team by pressing the button on the overhead console or from the Assistance screen within the Remote smartphone app.

SOS Emergency Call – In a more serious incident, SOS Emergency Call will automatically connect you to the emergency response team who will notify the emergency services to your location. For peace of mind, this service is provided for the first ten years from date of registration.

¹Remote contains subscription services that can be extended after the initial term advised by your Land Rover Retailer. InControl features, options and their availability remain market dependent – check with your Land Rover Retailer for local market availability and full terms.

²Land Rover Optimised Assistance is a subscription service that can be extended after the initial term advised by your Land Rover Retailer.

³Features within Pro Services may vary between markets. Please contact your local Land Rover Retailer for more information.

NAVIGATION PRO

Navigation Pro allows you to save your favourite places, use pinch-to-zoom gestures for simple map exploration and can display a choice of either 2D or 3D crystal clear map graphics. Traffic Sign Recognition is also included as standard. 4G Wi-Fi Hotspot, and Pro Services³, are designed to enhance your in-car and out-of-car experience, ensuring you and your passengers enjoy the journey whilst remaining connected to the world.

Pro Services Include:

- **Real Time Traffic Information** – Uses live traffic data feeds to give you the most accurate picture of what the traffic is like on the way to your destination.
- **Online Search** – Wherever you are, you can search the surrounding area for places of interest. The system can access expert destination information, travel tips and inspiration as well as online travel reviews of the local area.
- **Planning Routes and Door-to-Door Routing** – Before setting off, use the Route Planner app or go online to search, save locations or set your destination. The app uses the Cloud to send your destination automatically to your vehicle's navigation screen. Once you've parked, the Route Planner app will guide you to your destination – a true door-to-door experience which includes public transport options.
- **Share ETA** – You can share your estimated time of arrival so your selected contact(s) will know exactly when you will arrive, as calculated by the navigation guidance system. If you're running late, Share ETA can then send automatic updates via text messages or email, without any further action from you.
- **Satellite View** – There may be times when you want to get the context of your surroundings from overhead. With Connect Pro you can switch to satellite view with a single tap.



STANDARD FEATURES CONTINUED

Pro Services continued:

- **Fuel Prices** – When you're going to fill up, the Fuel Price service not only finds filling stations along your route, it also enables you to compare fuel prices so you can keep your costs down.
- **Commute Mode** – Allows the system to learn your commutes and automatically advises you of the expected journey time based on live and historical traffic movements without you having to input a destination. The system learns the routes you take for a given destination and then advises which of those is the quickest. The feature can be turned on and off dependent on driver preference.
- **Parking Service** – As you approach your destination, you can see where parking is available. Simply tap on your preferred car park and the navigation system updates to direct you to it.
- **Online Routing** – While you're on your way to a destination the system monitors live traffic conditions and takes into account typical traffic patterns for that time of day, keeping you on the optimum route.
- **Safety Cameras** – This feature tells you when you're approaching a safety camera.
- **Online Media** – Allows for the aggregation of numerous content providers and their personalised content – such as Deezer and TuneIn – that gives access to more than 40 million music tracks and four million on-demand programmes and podcasts. For the first time, these can be directly streamed from the vehicle without the need for a smartphone – providing a seamless and integrated experience.

OPTIONAL FEATURES

SECURE TRACKER¹

Uses tracking technology to alert you to an attempted theft, and signals your vehicle's location to the relevant authorities, for a timely recovery. Includes service subscription for warranty period.

¹Secure Tracker will require further subscription after the initial term as advised by your local Land Rover Retailer. Information and images displayed in relation to the InControl technology, including screens or sequences, are subject to software updates, version control and other system/visual changes depending on options selected. Mobile network connectivity cannot be guaranteed in all locations. Remote App will need to be downloaded from the Apple/Play Store. All in-car features should be used by drivers only when safe for them to do so. Drivers must ensure they are in full control of the vehicle at all times. Certain features require an appropriate SIM with a suitable data contract, which will require a further subscription after the initial term advised by your Retailer.

SMARTPHONE PACK

By screen sharing with the InControl infotainment system, the Smartphone Pack helps you stay connected to your smartphone even while in the car.

Android Auto™ was designed with safety in mind. With a simple and intuitive interface, it is designed to minimise distraction so that you can stay focused on the road. Simply connect your Android smartphone via a USB and control compatible apps on the in-car Touchscreen.

Apple CarPlay® is also designed for increased safety, enabling the use of apps while allowing the driver to concentrate on the road ahead. Connect your Apple smartphone to your car to use compatible apps such as maps, messages and music through the Touchscreen.

Applications include :

- Spotify² – Access a library of more than 30 million songs with this seamlessly integrated app. Featuring all the same intuitive functionality as the Spotify smartphone app, you can search songs, stations and recommendations, create playlists and access your music in offline mode. Simply log in using your existing Spotify Free or Spotify Premium account.
- Tile³ – Helps you find lost or misplaced items in seconds. Attach a tiny Bluetooth tracker Tile to your keys, wallet or bag. The easy-to-use Tile app can then help you find these items should they be misplaced. The app is accessible any time through your vehicle's Touchscreen, allowing you to make sure you have everything you need with you, before you set off on your journey.



²Please check App Store and Google Play for availability.

³Bluetooth tracker tiles must be purchased separately. 2016 Tile Inc. and the Tile design are trademarks of Tile, Inc.

DRIVER ASSISTANCE

EASIER AND SAFER

From negotiating city traffic or the motorway, to providing additional safety for you and your passengers, you'll find a range of features designed and engineered to heighten your enjoyment of the vehicle.

STANDARD FEATURES



Emergency Braking

Emergency Braking can help to prevent collisions with other vehicles or pedestrians. If a potential frontal collision is detected, a warning is displayed giving you time to take action. A camera at the front of the vehicle monitors at speeds from 5 to 80km/h for frontal collisions and 5 to 60km/h for pedestrians. If a collision is still anticipated and you have taken no action, this system will apply the brakes to help reduce the severity of the possible impact.

High-speed Emergency Braking detects when a potential frontal collision with another vehicle may occur and displays a forward alert to warn the driver to brake. If the driver doesn't react, the vehicle will deploy the brakes in order to reduce the severity of the possible impact. High-speed Emergency Braking is ready and active from 10km/h to 160km/h.

Driver Condition Monitor detects if you're starting to feel drowsy and gives you an early warning when you need to take a break.



360° Parking Aid

360° Parking Aid gives you complete confidence when manoeuvring in tight spaces. Sensors located around the car are automatically triggered when Reverse is selected, or can be manually activated, with a graphic appearing on the Touchscreen showing an overhead view of the vehicle. As you park, the Touchscreen display and audio feedback indicates how close you are to obstacles.



Rear Camera

Rear Camera provides improved visibility when reversing. This valuable parking aid also helps when hitching a trailer. Static lines representing the vehicle's outer perimeter and predicted path are superimposed on the rearward image, to make parking in tight spots as easy as possible.

Rear Traffic Monitor is particularly useful when reversing out of a parking bay. The system warns you of vehicles, pedestrians or other hazards, approaching from either side of your vehicle and will alert you with both audio and visual warnings so you know what's behind you even when the view is obstructed.



Lane Keep Assist

Lane Keep Assist detects when the vehicle is unintentionally drifting out of the lane, and applies a corrective torque to the steering wheel, encouraging you to guide your vehicle back.

Traffic Sign Recognition and Adaptive Speed Limiter keeps you informed and aware on the road, by displaying speed limits and no overtaking signs in the instrument cluster, where they can easily be seen. Adaptive Speed Limiter uses Traffic Sign Recognition information to adjust your vehicle's speed accordingly by using the cruise control system.

Park Assist makes parallel and perpendicular parking easier than ever by steering your vehicle into a suitable space. You just have to select the appropriate gear and control the vehicle's speed with the brake and accelerator pedals. Graphics and notifications guide you through the manoeuvres. Park Assist will also steer you out of a space, taking all of the stress out of parking.



Adaptive Cruise Control

Adaptive Cruise Control will keep your vehicle a safe distance from the one in front should it slow or stop when you're cruising on the motorway or travelling in slow-moving traffic. Should the vehicle in front stop completely, your vehicle will come to a smooth halt. In stop-start traffic, Adaptive Cruise Control will automatically resume following the car in front. The system can be activated from 20km/h and once activated will operate between 0-200km/h.

Blind Spot Assist can help you prevent collisions. If your vehicle detects another car in your blind spot when you begin to change lanes, a small warning light illuminates in the corresponding wing mirror. Corrective torque is also applied to the steering wheel, encouraging you to guide your vehicle away from the approaching vehicle.

OPTIONAL FEATURE



Surround Camera System

360° Surround Camera uses four digital cameras discretely placed around the vehicle, providing a 360° overhead view on the Touchscreen. With the capacity to display several different views at the same time, this helps with various manoeuvres from parking by a kerb, to getting in and out of tight spaces and junctions.

The optional **Driver Assist Pack** offers the 360° Surround Camera and Adaptive Cruise Control with Steering Assist.

SAFETY

SAFE AND SECURE

Designed for optimum safety, Range Rover Velar SVAutobiography Dynamic Edition has been engineered to include a wealth of standard features not only to protect you and your passengers, but to actively help prevent accidents from happening.

The elevated Sports Command Driving Position provides enhanced visibility in all conditions. You can see more of the road and be easily seen by other road users, providing an enhanced feeling of safety and confidence.

Legendary sure-footed All Wheel Drive (AWD) with Intelligent Driveline Dynamic (IDD) capability, as standard, helps you stay firmly planted on the road, whatever the weather or environment throws at you.

The safety of Range Rover Velar SVAutobiography Dynamic Edition is further enhanced by the latest technologies included as standard:

Dynamic Stability Control (DSC) monitors the vehicle's dynamic behaviour, intervening to maximise vehicle stability. DSC reduces engine torque and applies braking to the appropriate wheels to correct the vehicle's direction of travel by counteracting understeer or oversteer.

Anti-lock Braking System (ABS) allows the vehicle to maintain traction with the road surface whilst braking and prevents wheels from locking – thereby retaining the vehicle's ability to steer. The system helps to shorten the braking distance.

Electronic Brake-force Distribution (EBD) automatically varies the braking force to each axle in order to minimise stopping distance, while still maintaining stability and the vehicle's ability to steer.

Electronic Traction Control (ETC) optimises traction and stability by controlling wheel spin. The ETC system reduces torque to the spinning wheel, then applies braking to the wheel, if required.

Cornering Brake Control (CBC) automatically varies the braking force to each wheel when the vehicle's brakes are applied around a corner and the limit of grip is reached. The system will prevent the vehicle's wheels from locking up and skidding in this event through varying the braking force applied to each wheel.

Roll Stability Control (RSC) is integrated with DSC to reduce the possibility of rollover, while providing agility and ability to steer around obstacles. It monitors the vehicle motion and cornering forces to detect any potential risk of rollover. When risk is detected, braking is applied to the outside front wheel to reduce forces which contribute to rollover.

Emergency Brake Assist understands when you apply the brakes quickly but without the necessary force to maximise stopping performance. It therefore boosts the brake pressure through the ABS pump to ensure you stop in time.

To help reduce the risk of a collision, the Emergency Stop Signal system automatically activates the hazard warning lights during emergency braking.

Emergency Braking – see page 36 for details. To improve safety even further, two ISOFIX points for baby/child seat restraints are fitted on each side of the rear seats and a comprehensive system of six airbags including driver, passenger, side curtain and thorax airbags are standard to protect you.

For information on active safety features please refer to Driver Assistance pages 38 and 39.



AIRBAGS

ISOFIX POINTS

ALUMINIUM
SAFETY CELL



AIR SUSPENSION LOWERS BY 50MM

VERSATILITY

TRULY FLEXIBLE

Range Rover Velar SVAutobiography Dynamic Edition enjoys optimum levels of space. Occupants can enjoy the highest levels of comfort and exemplary levels of stowage.

Automatic Access Height allows you to get in and out of the vehicle with greater ease. When you arrive at your chosen destination and the ignition is switched off or the seat belts are unclipped, the vehicle lowers by an initial 10mm. Then, as you open the door, it drops to its full access height of 40mm lower, making exit – and entry – more relaxed and elegant. The ride height automatically returns to its normal height as you pull away.

Exceptional 966mm head clearance and 40.8mm knee clearance in the second row enables passengers to stretch out and relax. An optional electric recline function is also available for the rear seats, offering occupants in the second row additional comfort.

Four-zone Climate Control helps make life more comfortable for everyone, by adjusting temperature levels, direction and intensity of airflow.

The 40:20:40 second row seat configuration features a rear-seat pass-through for stowage of skis, an armrest and for the greatest possible storage space, the entire row can be folded. Optional rear seat remote release levers are located in the luggage compartment and, when released, mechanically fold all the seats down. Even when you're heading off on an extended road trip, you don't have to compromise on space. With a maximum loadspace of 834 litres¹, you can carry several suitcases or other bulky items with ease.



5 SEATS
632 LITRES



4 SEATS
1,161 LITRES



3 SEATS
1,344 LITRES



2 SEATS
1,690 LITRES

A detachable tow bar with a load capacity of 2.500kg is available as an option. Alternatively, there is the option of an electrically deployable tow bar², stowed in the rear bumper, with a load capacity of 2.500kg. Both allow you to use items such as bike carriers from the range of Land Rover Gear, adding even more versatility to the vehicle. Everything has been designed and engineered for ease of use and adaptability, to fit perfectly with your lifestyle.



YOUR MODEL

STANDARD FEATURES

EXTERIOR FEATURES

- Rain sensing wipers
- Flush deployable door handles
- Auto-dimming, power fold, heated door mirrors with approach lights
- Acoustic laminated windscreen
- Automatic headlights
- Follow me home lighting
- Rear fog lights
- Matrix LED headlights with signature DRL
- Black contrast roof.

WHEELS AND TYRES

- Tyre Pressure Monitoring System (TPMS)
- 21" 5 split-spoke 'Style 5083' wheels with Gloss Dark Grey finish
- Tyre Repair System
- All-season tyres.

INTERIOR FEATURES

- Sunvisors with illuminated vanity mirrors
- Push Button Start
- Suedecloth headlining
- Shadow Aluminium trim finishers
- Unique sport steering wheel
- Aluminium gearshift paddles
- Bright metal pedals
- Metal loadspace scuff plate and metal front treadplates
- Four-zone Climate Control
- Ambient Interior Lighting
- Air Quality Sensor
- Auto-dimming interior rear view mirror.

SEATING AND INTERIOR TRIM

- Perforated Windsor leather seats with unique Diamond quilted covers
- 20-way heated/cooled/massage front seats with heated rear seats
- Two piece sliding front centre armrest
- Premium carpet mats
- 40:20:40 split fold rear seat
- Second row centre headrest
- Shadow Aluminium trim finisher
- Full Extended Leather Upgrade with contrast stitch.

DYNAMICS

- Single-speed transfer box
- Electric Parking Brake (EPB)
- 8-speed Automatic Transmission
- Terrain Response with Dynamic Programme
- Anti-lock Braking System (ABS)
- Configurable Dynamics
- Electronic Active Differential with Torque Vectoring by Braking (TVBB)
- Sports Suspension
- Hill Descent Control (HDC)
- Hill Launch Assist
- Gradient Release Control (GRC)
- Electronic Traction Control (ETC)
- Dynamic Stability Control (DSC)
- Cornering Brake Control (CBC)
- Emergency Braking
- Roll Stability Control (RSC)
- Speed Proportional Electronic Power Assisted Steering (EPAS)

- Low traction launch
- Stop/Start
- Trailer Stability Assist (TSA)
- Red brake calipers
- Switchable Active Sports Exhaust
- 395mm front and 396mm rear brakes.

INFOTAINMENT

- Touch Pro Duo
- Interactive Driver Display
- Bluetooth® connectivity
- Meridian™ Surround Sound System
- Remote.

DRIVER ASSISTANCE

- Lane Keep Assist
- Electronic Brake-force Distribution (EBD)
- Adaptive Cruise Control
- Emergency Braking
- Blind Spot Assist
- Driver Condition Monitor
- High-speed Emergency Braking
- Rear Traffic Monitor
- Traffic Sign Recognition and Adaptive Speed Limiter.

SAFETY

- Perimetric alarm and immobiliser
- Advanced Emergency Brake Assist
- Brake pad wear indicator
- Six airbags
- Emergency Stop Signal (ESS)

- Seat belt reminder
- Rear ISOFIX
- Power operated child locks
- Driver Condition Monitor.

CONVENIENCE

- Keyless Entry
- 360° Parking Aid
- Park Assist
- Powered gesture tailgate
- Loadspace cover
- Voice control
- Power Socket Pack 1 – 2 x USB, 3 x 12V
- Lockable glovebox
- Electric windows with one-touch open/close and anti-trap
- Rear Camera.



YOUR ENGINE

DRIVE, ENGINE PERFORMANCE AND FUEL ECONOMY

			PETROL
			AUTOMATIC
			V8 SUPERCHARGED
POWER (PS)			
Driveline			All Wheel Drive (AWD)
Maximum power kW (PS/rpm)			405 (550)/6.000-6.500
Maximum torque (Nm/rpm)			680/2.500-5.500
Capacity (cc)			4.999
No. of cylinders			8
Cylinder layout			Longitudinal V8
PERFORMANCE			
Maximum speed	km/h (mph)		274 (170)
Acceleration (seconds)	0-100km/h (0-60mph)		4,5 (4,3)
FUEL ECONOMY – NEDC EQUIVALENT (NEDC2)*			CLASS B
NEDC2 Consumption	Urban	l/100km (mpg)	16,7 (16,9)
	Extra Urban	l/100km (mpg)	9,0 (31,5)
	Combined	l/100km (mpg)	From 11,8 (Up to 23,9)
NEDC2 CO ₂ Emissions	Urban	(g/km)	382
	Extra Urban	(g/km)	205
	Combined	(g/km)	From 270
FUEL ECONOMY – WLTP**			TEH†
WLTP Consumption	Low	l/100km (mpg)	18,4 (15,4)
	Medium	l/100km (mpg)	12,1 (23,3)
	High	l/100km (mpg)	10,5 (27,0)
	Extra High	l/100km (mpg)	11,7 (24,2)
	Combined	l/100km (mpg)	12,3 (23,0)
WLTP CO ₂ Emissions	Low	(g/km)	418
	Medium	(g/km)	275
	High	(g/km)	238
	Extra High	(g/km)	265
	Combined	(g/km)	279



**WLTP is the new official EU test used to calculate standardised fuel consumption and CO₂ figures for passenger cars. It measures fuel, energy consumption, range and emissions. This is designed to provide figures closer to real-world driving behaviour. It tests vehicles with optional equipment and with a more demanding test procedure and driving profile. †TEL (Test Energy Low) and TEH (Test Energy High) figures are shown as a range under WLTP testing measures. TEL refers to the lowest/most economical figures (with the lightest set of options). TEH refers to the highest/least economical figures (with the heaviest set of options). WLTP legislation dictates that where there is <5g CO₂ variance between TEL and TEH, only the TEH is declared.



CONFIGURE YOUR RANGE ROVER VELAR SVAUTOBIOGRAPHY DYNAMIC EDITION

CHOOSE YOUR EXTERIOR

This is where you really make it your Range Rover Velar SVAutobiography Dynamic Edition. Select the body colour, roof style and exterior options that suit you, then choose the perfect wheels to complement them.

CHOOSE YOUR ROOF



Black contrast sliding panoramic roof¹ (standard)



Body-coloured sliding panoramic roof (optional)

CHOOSE YOUR WHEELS



21" 5 SPLIT-SPOKE
'STYLE 5083'
WITH GLOSS DARK GREY FINISH
(STANDARD)



22" 5 SPLIT-SPOKE
'STYLE 5113'
WITH SPARKLE SILVER AND
DIAMOND TURNED FINISH



22" 5 SPLIT-SPOKE
'STYLE 5113'
WITH GLOSS DARK GREY FINISH



CHOOSE YOUR COLOUR

SOLID



Fuji White

METALLIC



Santorini Black



Corris Grey

SVO PREMIUM PAINT PALETTE

SATIN FINISH



Byron Blue²³



Indus Silver



Firenze Red

CHOOSE YOUR INTERIOR

To personalise the interior of your Range Rover Velar SVAutobiography Dynamic Edition even further, you can choose from a selection of materials, finishers and colourways.

CHOOSE YOUR VENEERS AND FINISHERS

STANDARD

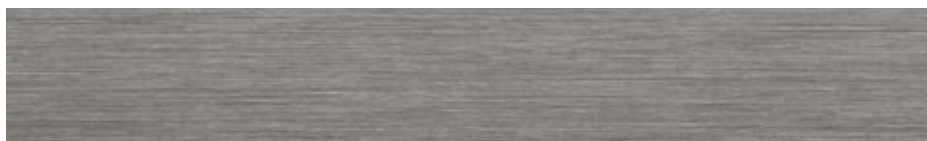

Shadow Aluminium trim finisher

OPTIONAL



Grand Black veneer

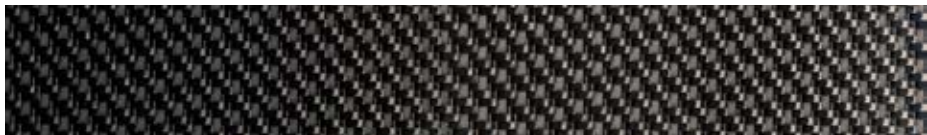

Steel Weave Carbon Fibre trim finisher

YOUR HEADLINING

STANDARD



Ebony suedecloth



CHOOSE YOUR INTERIOR COLOURWAY

Ebony/Ebony

(available in perforated Windsor leather and unique Diamond quilted seat covers)



Interior shown: Range Rover Velar SVAutobiography Dynamic Edition in Ebony/Ebony with Ebony perforated Windsor leather and optional Steel Weave Carbon Fibre trim finisher.

Ebony/Cirrus

(available in perforated Windsor leather and unique Diamond quilted seat covers)



Interior shown: Range Rover Velar SVAutobiography Dynamic Edition in Ebony/Cirrus with Ebony/Cirrus perforated Windsor leather and optional Steel Weave Carbon Fibre trim finisher.

Ebony/Pimento

(available in perforated Windsor leather and unique Diamond quilted seat covers)



Interior shown: Range Rover Velar SVAutobiography Dynamic Edition in Ebony/Pimento with Ebony/Pimento perforated Windsor leather and optional Steel Weave Carbon Fibre trim finisher.

Ebony/Vintage Tan

(available in perforated Windsor leather and unique Diamond quilted seat covers)



Interior shown: Range Rover Velar SVAutobiography Dynamic Edition in Ebony/Vintage Tan with Ebony/Tan perforated Windsor leather and optional Steel Weave Carbon Fibre trim finisher.

CHOOSE YOUR OPTIONS

You can truly bespoke your Range Rover Velar SVAutobiography Dynamic Edition with options chosen at the point of order and the range of accessories that can be fitted before or after delivery by your Land Rover Retailer.

EXTERIOR FEATURES

Black roof rails

Line-fit roof rails facilitate easy fitment of cross bars for truly stable roof carrying. Pre-set positioning points ensure that the cross bars are fixed in the optimum position for weight distribution and dynamics. Available in a Black finish. Not available as Land Rover Gear – Accessories fit.

Privacy glass

Provides privacy for rear seat passengers by restricting vision into the rear cabin.

Solar attenuating windscreen

This windscreen filters sunlight to reduce heat, and prevent UV rays from entering the cabin.

Matrix-laser LED headlights with signature DRL

WHEELS AND TYRES

Summer tyres

Summer tyres are optional on both wheel sizes. Load index and speed ratings dependent on wheel sizes. Not compatible with full size spare wheel.

SV reduced section alloy spare wheel

Lightweight reduced section alloy spare wheel. Includes tool kit.

INTERIOR FEATURES

Heated windscreen

Offers a quick and convenient way to defrost or demist the windscreen. Featured heated washer jets prevent the washer fluid from freezing so you can easily keep your windscreen clean in cold conditions.

Rear seat remote release levers

Remote release of the rear seats via levers in the loadspace area makes folding the rear seats for additional loading capacity even easier.

Illuminated metal loadspace scuff plate

Elegantly styled rear loadspace scuff plate illuminated by soft Blue lighting when the tailgate is opened. It protects the loadspace edge from scratches when loading and unloading. Not compatible with full size spare wheel.

Smoker's Pack

Add a lighter socket and ashtray to the centre console.

Configurable Ambient Interior Lighting

This feature allows you to vary the colour and shade, changing the ambience of the cabin to suit your mood. There are 10 colours in total.

Cabin Air Ionisation

This technology helps the wellbeing of both driver and passengers alike. It improves the air quality within the cabin, and can help reduce allergens, viruses, bacteria and odours. It does so by decomposing harmful substances, thus helping to cleanse the air in the cabin. This feature can be switched on or off.

8" Rear Seat Entertainment

See page 31 for details.

CONVENIENCE

Detachable tow bar

See page 43 for details.

Electrically deployable tow bar

See page 43 for details.

Advanced Tow Assist

Advanced Tow Assist allows you to control the direction of your trailer when reversing. Using the Terrain Response 2 reconfigurable rotary dial via the Touch Pro controls, the system controls the vehicle's steering to achieve the desired trailer trajectory. The Touchscreen will display both the current and desired trailer trajectory.

Fixed rear recovery eye

When another vehicle is stuck in mud, snow or sand, this feature can really come into its own. Stable, robust and strong, it is ideal for any such situation – especially off-road.

Driver Assist Pack

See page 39 for details.

360° Surround Camera

See page 39 for details.

Activity Key

Makes living life to the full even easier. For extra convenience, you can wear the Activity Key if you prefer not to carry a key fob. The wristband is robust and fully waterproof. It allows you to keep your vehicle key with you whilst enjoying a range of activities. You can use the Activity Key while keys remain inside the vehicle as the conventional key fob is deactivated for security.

Garage Door Opener (Homelink®)

The HomeLink® system is a universal transmitter fitted to the underside of the interior rear view mirror. This transmitter can be programmed to operate up to three home or office wireless controlled systems, such as garage doors, automatic gates, or security lighting. By replacing the individual remote control units normally required for each system, the driver no longer needs to search the vehicle interior for the correct handset when needed.



CHOOSE YOUR LAND ROVER GEAR-ACCESSORIES

DESIGN

Deployable side steps

Please contact your local Land Rover Retailer for fitment options

These smart, practical steps make it easier to get in and out of the vehicle. Neatly stowed under the sills, the side steps automatically deploy as soon as the door is opened, or when activated by the key fob. They stow automatically when the door is closed. The side steps are sensitive to obstructions and will not deploy in off-road or low range settings. Automatic mode can be overridden to allow access to the roof when the doors are closed. The deployable side steps are compatible with front mudflaps and feature a Stainless Steel finish with laser etched Range Rover Velar branding.

Carbon Fibre mirror covers

Stunning high-grade Carbon Fibre mirror covers, with a High Gloss finish, provide a performance-inspired Premium styling update.

Carbon Fibre side vents

High-grade Carbon Fibre side power vents with a High Gloss finish provide a performance-inspired styling upgrade.

Illuminated loadspace scuff plate*

Manufactured from stainless steel with a Bright finish, the rear loadspace treadplate finisher provides protection for the loadspace trim when loading or unloading and provides a Premium finish to the loadspace with subtle illumination.

TOURING

Electrically deployable tow bar

The electrically deployable tow bar is stowed discreetly behind the rear bumper when not in use, providing a clean attractive finish. It is designed to deploy or stow in 12 seconds, operated via a switch in the rear loadspace or by the infotainment system in the cabin. The tow bar returns to its original position if any obstructions are encountered during deploying/stowing. Includes integral 13 pin towing electrics (also hidden until deployed). Approved for up to a 3.500kg trailer load. Includes a unique trailer light test facility which allows the driver to be able to check without assistance if the trailer lights, including reverse and brake lights, are functioning correctly. The trailer light test is activated via either a switch in the loadspace or via the Touchscreen, depending on the vehicle's specification.

Wireless phone charging cupholder

The wireless phone charging cupholder has been designed to allow visibility of the phone whilst charging, utilising the cupholder space in the centre console. The holder will accommodate phones of up to 73mm wide securely in place. The charger displays an LED light to indicate when charging, and turns off when complete.

LIFESTYLE

Luxury carpet mats – Ebony

The luxurious, tailored, deep pile 2.050g/m² carpet mat set, with waterproof backing, provides a well appointed finishing touch to the interior.

Luxury loadspace carpet mat

Luxurious, tailored, deep pile 2.050g/m² loadspace carpet mat, with waterproof backing, provides a well-appointed finishing touch to the interior.

Loadspace rubber mat

Land Rover branded waterproof rubber mat, with retaining lip, helps to protect the rear loadspace carpet from general dirt. This waterproof mat extension covers the back of the rear seats when they are folded down.

*Not compatible with full size spare wheel.

HomeLink® is a registered trademark of Gentex Corporation.

THE WORLD OF LAND ROVER

Your Land Rover has been designed and engineered to help you make more of your world. It can take you to places other vehicles simply can't reach in a style that cannot be matched. To celebrate the Land Rover lifestyle, we've put together a range of experiences, publications and the Land Rover Lifestyle Collection. There's a world to explore. Get out there and enjoy it.

EXPERIENCE DRIVES



Bring out your adventurous side and experience Land Rover's legendary capability for yourself. Under the expert guidance of a world-class instructor, head to the most exciting and challenging off-road terrains and take the vehicle to its limits.

landrover.com/experience

ADVENTURE TRAVEL



From the sheer exhilaration of the Arctic ice to the awe-inspiring dunes of Namibia, Land Rover Adventure Travel offers you once-in-a-lifetime experiences that bring the spirit and emotion of our vehicles to life.

landrover.com/adventure

Follow us on:



MANUFACTURING TOURS



This is a unique opportunity to step inside our state-of-the-art manufacturing facilities and see where the latest vehicles are born. Taking you behind the scenes, our expert tour guides will show you how Land Rover combines unrivalled craftsmanship with cutting-edge robotics.

landrover.com/tours

SPECIAL VEHICLE OPERATIONS



Whether it's class-leading luxury, thrilling performance or extreme all-terrain capability, Land Rover excels. Special Vehicle Operations takes this even further. Delivering the absolute pinnacle of Land Rover engineering and design, each vehicle combines peerless refinement with power and cutting-edge technology, which is why the SV badge represents so much.

landrover.com/svo

THE LAND ROVER LIFESTYLE COLLECTION



Our latest range of clothing and lifestyle accessories are crafted with the same design excellence and attention to detail, as our vehicles. Inspired by our unique heritage, there is something for the whole family.

landrover.com/collection

ONELIFE MAGAZINE



Free twice a year for your first three years as a Land Rover owner, this award-winning magazine features the best in photography, authoritative journalism and expert insights. Onelife takes you right into the heart of exclusive experiences and extraordinary adventures, whilst keeping you up to date with the latest innovations, design and lifestyle choices.

landrover.com/onelife

Follow us on:



BRAND PARTNERSHIPS



Integrity. Courage. Pride. These are the values that Land Rover shares with its partners. Whether it's the Invictus Games, Virgin Galactic, Rugby World Cup 2019™ or the British and Irish Lions, each one is driven by exceptional people. Those who push their capabilities to the very limits and champion the determination to go above and beyond.

landrover.com/partnerships

HUMANITARIAN PARTNERSHIPS



Since 1954, Land Rover is proud to have supported the incredible humanitarian work of the International Federation of Red Cross and Red Crescent Societies (IFRC). Through vehicles, funding and combined expertise, this ambitious global partnership has helped to transform the lives of over one million people, across four continents.

landrover.com/responsibility



YOUR PEACE OF MIND

CUSTOMER SERVICE

When you bring your Land Rover to us, we use cutting-edge diagnostic equipment to assess all your vehicle's mechanical and electronic systems. Our qualified Technicians use tools specifically designed for our vehicles and only fit genuine Land Rover parts and Gear accessories. A choice of service plans are available which, together with Roadside Assistance, ensures complete peace of mind.

For further details contact your local Land Rover Retailer or search 'Land Rover Ownership'.

LAND ROVER ROADSIDE ASSISTANCE

Land Rover Assistance provides assistance in motoring emergencies, from immobilisation due to breakdown or accident to minor problems such as punctures. You can rely on our roadside assistance, whatever the situation, wherever you happen to be.

For further details please consult your Warranty Benefits handbook, contact your nearest Land Rover Approved Service Centre or search 'Land Rover Roadside Assistance'.

IMPORTANT NOTICE: Jaguar Land Rover Limited is constantly seeking ways to improve the specification, design and production of its vehicles and alterations take place continually. Whilst every effort is made to produce up-to-date literature, this brochure should not be regarded as an infallible guide to current specifications, nor does it constitute an offer for the sale of any particular vehicle. Distributors and Retailers are not agents of Jaguar Land Rover Limited by any express or implied undertaking or representation.

Images are provided for illustrative purposes only. Colours reproduced on-screen may vary compared to actual finish. The company reserves the right to alter or withdraw any colour finish without notice. Some of these colours may not be obtainable in your country. Please check availability of colours and current specifications with your Land Rover Retailer. Distributors and retailers are not agents of Jaguar Land Rover Limited and have absolutely no authority to bind Jaguar Land Rover Limited to any express or implied undertaking or representation.

TECHNICAL SPECIFICATION

If not enclosed, please contact your local Land Rover Retailer.

LAND ROVER FINANCIAL SERVICES

Getting the keys to your very own Land Rover has never been so simple. And it's more affordable than you might think. New or used, for personal or business use, we have an option that puts you in complete control.

FLEET & BUSINESS

Land Rover is dedicated to being the premium manufacturer of choice for fleets and businesses, by providing a highly attractive range of vehicles and exemplary customer service. Distinctive, capable and versatile, all Land Rover vehicles deliver low Total Cost of Ownership through strong residual values, competitive service, maintenance and repair costs, and impressive fuel economy and CO₂ emissions.

We are also committed to providing a totally customer-focused aftersales service, which will ensure every Land Rover vehicle is kept on the road and in top condition, in the easiest and most cost-efficient way for businesses.

Search 'Land Rover Fleet and Business' for full details.

Vehicle shown left and back cover is SVAutobiography Dynamic Edition in Byron Blue with Satin Finish. Optional features fitted.

Castrol EDGE Professional exclusively recommended by Land Rover. Bluetooth® word mark and logos are owned by the Bluetooth SIG, Inc. and any use of such marks by Land Rover is under licence. Android Auto is a trademark of Google Inc. iPhone and Apple CarPlay® is a registered trademark of Apple Inc., registered in the US and other countries. Please ensure iPhone compatibility is reviewed with your local Land Rover Retailer. HomeLink® is the registered trademark of Gentex Corporation. Meridian is the registered trademark of Meridian Audio Ltd.

Jaguar Land Rover Limited

Registered Office: Abbey Road, Whitley,
Coventry CV3 4LF United Kingdom.

Registered in England: Number 1672070

landrover.com

© Copyright Jaguar Land Rover Limited 2019.

1L56019200D0BXXEN01P



NEW RANGE ROVER VELAR SVAUTOBIOGRAPHY DYNAMIC EDITION

TECHNICAL SPECIFICATION

FEBRUARY 2019



ABOVE & BEYOND



ENGINE

Configure your Range Rover Velar SVAutobiography Dynamic Edition at landrover.com

TECHNICAL SPECIFICATION

POWERTRAIN		PETROL	
		V8 SUPERCHARGED	
Driveline		All Wheel Drive (AWD)	
Transmission		Automatic	
Maximum power (PS/rpm)		550 / 6.000-6.500	
Maximum torque (Nm/rpm)		680 / 2.500-5.500	
Capacity (cc)		4.999	
No. of cylinders/Valves per cylinder		8 / 4	
Cylinder layout		Longitudinal V8	
Bore/stroke (mm)		92,5 / 93	
Compression ratio (:1)		9,5:1	
PERFORMANCE AND FUEL ECONOMY			
Acceleration (secs) 0-100 km/h (0-60 mph)		4,5 (4,3)	
Maximum speed km/h (mph)		274 (170)	
Fuel tank capacity – useable litres		82	
Gasoline Particulate Filter (GPF)		■	
FUEL ECONOMY – NEDC EQUIVALENT (NEDC2)*		Class B	
NEDC2 Consumption	Urban	l/100km (mpg)	16,7 (16,9)
	Extra Urban	l/100km (mpg)	9,0 (31,5)
	Combined	l/100km (mpg)	From 11,8 (Up to 23,9)
NEDC2 CO ₂ Emissions	Urban	(g/km)	382
	Extra Urban	(g/km)	205
	Combined	(g/km)	From 270
FUEL ECONOMY – WLTP**		TEH†	
WLTP Consumption	Low	l/100km (mpg)	18,4 (15,4)
	Medium	l/100km (mpg)	12,1 (23,3)
	High	l/100km (mpg)	10,5 (27,0)
	Extra High	l/100km (mpg)	11,7 (24,2)
	Combined	l/100km (mpg)	12,3 (23,0)
WLTP CO ₂ Emissions	Low	(g/km)	418
	Medium	(g/km)	275
	High	(g/km)	238
	Extra High	(g/km)	265
	Combined	(g/km)	279

BRAKES		PETROL	
		V8 SUPERCHARGED	
Front type		4-piston aluminium monobloc fixed caliper, vented 2-piece disc	
Front diameter (mm)		395	
Rear type		Single piston sliding caliper, vented 2 piece disc	
Rear diameter (mm)		396	
Park Brake		iEPB, motor on caliper	
WEIGHTS (KG)††			
Unladen weight (EU)‡		2.160	
Unladen weight (DIN)‡		2.085	
Gross Vehicle Weight (GVW)		2.610	
TOWING (KG)			
Unbraked trailer		750	
Maximum towing		2.500	
Maximum coupling point (nose weight)		100	
Maximum vehicle and trailer combination		5.110	
ROOF CARRYING (KG)			
Maximum roof load (including roof rails)		79	

■ Standard

Class B (21" and 22" wheels with All Season and Summer Tyres).

*The figures provided are NEDC2 calculated from official manufacturer's WLTP tests in accordance with EU legislation. For comparison purposes only. Real world figures may differ. CO₂ and fuel economy figures may vary according to wheel fitment and optional extras fitted. NEDC2 are figures calculated using a Government formula from WLTP figures equivalent to what they would have been under the old NEDC test. The correct tax treatment can then be applied. **WLTP is the new official EU test used to calculate standardised fuel consumption and CO₂ figures for passenger cars. It measures fuel, energy consumption, range and emissions. This is designed to provide figures closer to real-world driving behaviour. It tests vehicles with optional equipment and with a more demanding test procedure and driving profile. †TEL (Test Energy Low) and TEH (Test Energy High) figures are shown as a range under WLTP testing measures. TEL refers to the lowest/most economical figures (with the lightest set of options). TEH refers to the highest/least economical figures (with the heaviest set of options). WLTP legislation dictates that where there is <5g CO₂ variance between TEL and TEH, only the TEH is declared.

DIMENSIONS AND CAPABILITIES

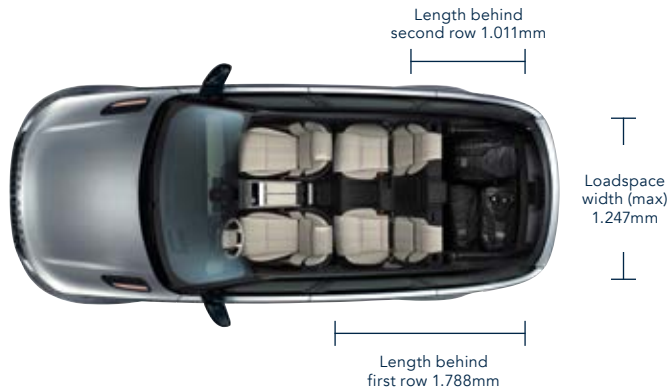

Standard Ride Height

With roof rails 1.656mm
 With roof antenna 1.676mm
 Access height air suspension setting will reduce each of the above by 40mm

Headroom

Maximum front / rear headroom with standard roof 993mm / 988mm

Maximum front / rear headroom with panoramic roof 970mm / 966mm

Legroom

Maximum front legroom 1.023mm
 Maximum rear legroom 935mm

Loadspace Capacity

Height 1.045mm, Width 1.247mm
 Loadspace width between arches 1.050mm

Maximum loadspace volume behind first row
 Dry[§] 1.079 litres, Wet[▲] 1.705 litres

Maximum loadspace volume behind second row
 Dry[§] 834 litres, Wet[▲] 834 litres



Obstacle Clearance

Standard ride height 204,8mm
 Off-road height 251mm

Turning Circle

Kerb-to-kerb 11,6m
 Wall-to-wall 11,75m
 Turns lock-to-lock 2,52

Wading Depth

Maximum wading depth 650mm



	A	B	C
Ride Height	Approach Angle	Ramp Angle	Departure Angle
Standard from	22,7°	20,2°	24,7°
Off-road from	24°	21,8°	27,5°



^{††}Weights reflect vehicles to standard specifications. Optional extras increase weight. [‡]Includes a 75kg driver, full fluids and 90% fuel. [▲]Includes full fluids and 90% fuel.

[§]Dry: Volume as measured with VDA-compliant solid blocks (200mm x 50mm x 100mm). [▲]Wet: Volume as measured by simulating the loadspace filled with liquid.

For illustrative purposes only, vehicle shown is R-Dynamic HSE in Silicon Silver with optional panoramic roof, Black contrast roof, privacy glass and 22" 9 split-spoke 'Style 9007' wheels with Diamond Turned finish.

