

JAGUAR F-TYPE



THE ART OF PERFORMANCE





BY APPOINTMENT TO
HM THE QUEEN
MANUFACTURERS OF
MOTOR VEHICLES
JAGUAR LAND ROVER LIMITED
COVENTRY



BY APPOINTMENT TO
HRH THE DUKE OF EDINBURGH
MANUFACTURERS OF
MOTOR VEHICLES
JAGUAR LAND ROVER LIMITED
COVENTRY



BY APPOINTMENT TO
HRH THE PRINCE OF WALES
MANUFACTURERS OF
MOTOR VEHICLES
JAGUAR LAND ROVER LIMITED
COVENTRY



THE ART OF PERFORMANCE

Every day we push performance to its limit. Our performance. Our cars' performance.
We innovate, we engineer, we design. We master rules and then break them.
Only to push further. Past the limits of convention. This is when performance becomes art.

Jaguar. The Art of Performance.



CONTENTS

INTRODUCTION

The Concept of F-TYPE	06
F-TYPE - The Facts	08

DESIGN

Exterior Principles	10
Exterior Detail	12
LED Headlights	14
Interior Connection	16
An Exclusive Space	18
Lightweight Seats	20
Luggage Space	22

PERFORMANCE

Engines Overview	24
i4 Engine	25
V6 Engines	26
V8 Engines	28
Lightweight Aluminium Architecture	30
Chassis and Suspension	32
Advanced Aerodynamics	34
Tested To The Extreme	36

DRIVING TECHNOLOGY

Advanced Driving Dynamics	38
Dynamic Mode and Configurable Dynamics	40
Advanced Drivetrain Technology	42
Torque Vectoring	44
Stability and Control	46
Performance Braking Systems	48

TECHNOLOGY

Infotainment	50
Connectivity	52
Audio	56

SAFETY

Driver Assistance	58
-------------------	----

F-TYPE SVR

Special Vehicle Operations	60
The Concept of F-TYPE SVR	62
F-TYPE SVR Aerodynamics	64
F-TYPE SVR	66
Lightweight Technologies	66
F-TYPE SVR Interior	68

PERSONALISATION

F-TYPE - Your Choice	70
Choose your Engine	72
New F-TYPE Chequered Flag	74
Choose your Model	76
Choose your Options	78
Choose your Colour	88
Choose your Wheels & Braking System	92
Choose your Interior	94
Choose your Jaguar Gear - Accessories	108
Technical Specifications	112
Dimensions	114

THE WORLD OF JAGUAR

AT YOUR SERVICE

VEHICLE SHOWN: F-TYPE R-DYNAMIC AWD IN SILICON SILVER WITH OPTIONAL FEATURES FITTED (MARKET DEPENDENT)

VEHICLES SHOWN ARE FROM THE JAGUAR GLOBAL RANGE. SPECIFICATIONS, OPTIONS AND AVAILABILITY WILL VARY BETWEEN MARKETS AND SHOULD BE VERIFIED WITH YOUR LOCAL JAGUAR RETAILER. CO₂ AND FUEL ECONOMY FIGURES MAY VARY ACCORDING TO WHEEL FITMENT AND OPTIONAL EXTRAS FITTED.

INTRODUCTION

THE CONCEPT OF F-TYPE

Jaguar F-TYPE is the latest in a distinguished bloodline of powerful, agile and distinctive sports cars. Combining exhilarating performance, accomplished handling and cutting-edge technology, it delivers an exceptional driver-focused experience.

F-TYPE's advanced technology makes it as up-to-date as it is special. The range features the most advanced and efficient engine ever found in an F-TYPE: a 2.0 litre 300PS Turbocharged Ingenium Petrol. While Jaguar's most powerful infotainment system, Touch Pro, is standard with a highly responsive 10" Touchscreen. A range of driver assistance features are also available, helping to keep you even safer on every drive.

LED headlights help make driving at night less tiring as they provide a quality of beam that is closer to daylight. Inside, slim seats save weight and give more space and comfort, while finishers on interior details allow even more personalisation.

Chequered Flag enhances F-TYPE's racing heritage-inspired design. Exclusive exterior features accentuate the sport styling, while the interior is both contemporary and beautifully realised. This is a car that exudes confidence and one you'll simply relish driving.

VEHICLE SHOWN: F-TYPE CHEQUERED FLAG 3.0 LITRE V6 RWD PETROL IN CARPATHIAN GREY WITH OPTIONAL FEATURES FITTED (MARKET DEPENDENT)





F-TYPE - THE FACTS

Stunning design, exhilarating performance, instant response, agile handling and advanced technology. F-TYPE is created to deliver breathtaking driving experiences.

ALL WHEEL DRIVE

F-TYPE's All Wheel Drive (AWD) combines the agility and character of Rear Wheel Drive (RWD) with the increased security and traction provided by AWD. In normal driving, F-TYPE is predominantly RWD to deliver handling purity, feel and balance. But when needed the system rapidly redistributes torque to the front axle, enabling F-TYPE to maintain optimum traction in all conditions.

TECHNOLOGY

F-TYPE's advanced technologies help keep you safe, entertained and connected. Park Assist¹ makes parking in a tight spot easier than ever, by steering your car into a suitable space. Our 10" Touch Pro infotainment system, with its tablet-style Touchscreen, offers intuitive swipe and pinch-to-zoom navigation. And, with Remote Premium², the option to remotely connect and monitor F-TYPE wherever you are in the world.

INTERIOR

Weight reduction and driver focus find their balance in F-TYPE. Slimline seats with a lightweight magnesium construction offer improved lateral support and save over 8kg of weight³ compared with previous generation models. F-TYPE is as meticulously honed and sporty on the inside as it is on the outside.

¹Optional only feature. ²Remote Premium contains subscription services that can be extended after the initial term advised by your Jaguar Retailer. ³Comparative weight saving for Performance seats. ⁴Optional on F-TYPE. Standard on F-TYPE R-Dynamic, F-TYPE R and F-TYPE SVR. ⁵Engine dependent. ⁶Only available on F-TYPE R and F-TYPE SVR.

VEHICLE SHOWN: F-TYPE R IN YULONG WHITE WITH OPTIONAL FEATURES FITTED (MARKET DEPENDENT)

INGENIUM

The Ingenium 2.0 litre 4-cylinder 300PS Turbocharged Petrol engine's impressive power is balanced with strong fuel economy. For almost instant boost and high efficiency, its low inertia twin-scroll turbocharger features low-friction ball bearings and a mixed flow turbine wheel. Underpinned by the turbocharger's increased aerodynamic efficiency, the engine delivers rapid acceleration and maximum torque of 400Nm between 1,500-4,500rpm.

SUPERCHARGED PERFORMANCE

F-TYPE's V6 and V8 engines use a twin vortex supercharger to eliminate acceleration lag. Throttle response is instantaneous with seamless power delivery and high levels of torque at all engine speeds. The latest engine to use this technology is the V8 unit found in F-TYPE SVR, which makes it Jaguar's most powerful production car ever.



DESIGN

Developed with advanced aerodynamics, F-TYPE's purposeful front end features a bumper framed by LED headlights⁴. These elegant headlights adapt the width and depth of their beam to your speed and offer a superb quality of light - so you always have the best possible illumination whatever your surroundings. F-TYPE has an exclusive range of 18 bespoke paints available in two finishes: these are in addition to the core F-TYPE colour palette.

HANDLING AND AGILITY

To optimise F-TYPE's handling and agility, a range of driving technologies are available. These include Torque Vectoring, Adaptive Dynamics⁵ and an Electronic Active Differential⁶. Each one works to enhance the driving experience through increased control, traction and feel.





DESIGN EXTERIOR PRINCIPLES

DRAMATIC DESIGN

"A piece of design should tell a story. F-TYPE's lines have a start, a direction and a conclusion. Make every line individual and aesthetically correct, with the right dimensions, and a design will stand the test of time."

Ian Callum, Jaguar Design Director

Those bold proportions. Those instinctive curves. Timeless, evocative and progressive in a way that could only be Jaguar.

Some say great design is subjective, but for us there's no debate: F-TYPE's beauty is the ultimate expression of the Art of Performance.

VEHICLE SHOWN: F-TYPE R-DYNAMIC AWD IN SILICON SILVER WITH OPTIONAL FEATURES FITTED (MARKET DEPENDENT)



EXTERIOR DETAIL

POWERFUL FORM

Rising vertically from the front spoiler and running up through elongated headlights, F-TYPE's beautifully flowing body line begins to take shape. The line arcs over the front wheel, descending elegantly as it runs across the door, before culminating in a pronounced muscular rear haunch. Whether you choose Coupé or Convertible, F-TYPE leaves you under no illusion - this is a high performance sports car, the latest in a distinguished bloodline.

VEHICLE SHOWN (LEFT): F-TYPE R-DYNAMIC AWD IN SILICON SILVER WITH OPTIONAL FEATURES FITTED (MARKET DEPENDENT)

VEHICLE SHOWN (RIGHT): F-TYPE IN INDUS SILVER WITH OPTIONAL FEATURES FITTED (MARKET DEPENDENT)



It is, in part, sculpted by the wind itself, formed by Jaguar's state-of-the-art Computational Fluid Dynamics design methods. A front splitter beneath the grille and rear venturi manage airflow along the underside, while a deployable rear spoiler* automatically rises at higher speeds to increase downforce and reduce drag. Even the door handles retract when not required, their flush design creating an uninterrupted airflow along F-TYPE's flanks.

*Optional on F-TYPE SVR.

LED HEADLIGHTS



SIGNATURE DESIGN

ENHANCED ILLUMINATION



Even at night, F-TYPE stands out. Its LED headlights* featuring LED 'J' blade Daytime Running Lights are as powerful as they look. These headlights produce a high quality of light that is closer to daylight conditions, making driving in the dark less tiring.

Optional Auto High Beam Assist provides added safety and convenience by automatically dipping the beam when other vehicles are detected. 'J' blades complete the dramatic headlight design. These crisp bars of light wrap round each light's outer edge, giving F-TYPE an instantly recognisable visual signature that adds to its assertive presence and distinctive style.

*Optional on F-TYPE. Standard on F-TYPE R-Dynamic, F-TYPE R and F-TYPE SVR.

VEHICLE SHOWN: F-TYPE R-DYNAMIC AWD IN SILICON SILVER WITH OPTIONAL FEATURES FITTED (MARKET DEPENDENT)

LED headlights feature an Adaptive Front Lighting System (AFS). This automatically provides the best possible illumination by adjusting the low beam according to your speed and the weather conditions.



City Mode

A wider beam than a standard low beam to help you see pedestrians and turnings more easily in built-up areas.

Country Mode

A low beam that is narrowed and extended, in comparison to City Mode, to offer better illumination for country driving.

Motorway Mode

A longer and narrower beam than Country Mode to improve long range visibility. The low beam is raised to extend illumination further down the road.

Bad Weather Mode

Adjusts the intensity of the low beam to minimise glare from reflections while still offering strong illumination of the road ahead. It is only activated when the windscreen wipers are in continuous operation.



INTERIOR CONNECTION



DRIVER FOCUS

CLARITY OF DESIGN

In F-TYPE, you and the car become one. Every aspect of its 1+1 configuration is designed to create a bond. It wraps around you, taking your driving experience to greater heights.

The cockpit provides maximum visibility, minimal distractions and close-to-the-centre-of-gravity seating for a complete connection with the car. The low fascia is free from clutter to increase the view ahead. The active central air vent, part of the advanced climate control system, hides the twin central air vents, which automatically rise from the dashboard as required and retract after use.

F-TYPE's easy-to-use 10" colour Touchscreen is your primary interaction point with the Touch Pro infotainment system. The system responds directly to touch and swipe gestures, providing effortless control over navigation, music, phone, climate and driver assistance features.

All in-car features should be used by drivers only when safe for them to do so. Drivers must ensure they are in full control of the vehicle at all times.

VEHICLE SHOWN: F-TYPE R-DYNAMIC AWD FEATURING EBONY WINDSOR LEATHER PERFORMANCE SEATS WITH IVORY CONTRAST STITCH WITH OPTIONAL FEATURES FITTED (MARKET DEPENDENT)





AN EXCLUSIVE SPACE



SUPERIOR CRAFTSMANSHIP

A TAILORED SPACE

We design our interiors so that nothing detracts from the outstanding driving experience. You'll always feel comfortably cocooned in F-TYPE's exquisitely crafted cockpit. The cabin's styling expresses exclusivity and refinement while always maintaining driver focus. Every element of the interior is carefully considered, with even the smallest details deepening the sense of luxury, such as the Chrome finishes on the doors and the steering wheel.

F-TYPE's interior starts with Jaguar's quintessential British character, but its unique personality is up to you. Tailor your interior styling with a variety of stitches and materials including Windsor leather and suedecloth, as well as Ebony, Pimento, Ivory and Siena Tan colour combinations. It's easy to make F-TYPE feel truly personal, to make F-TYPE your perfect sports car.

VEHICLE SHOWN: F-TYPE R-DYNAMIC AWD FEATURING EBONY WINDSOR LEATHER PERFORMANCE SEATS WITH IVORY CONTRAST STITCH WITH OPTIONAL FEATURES FITTED (MARKET DEPENDENT)



LIGHTWEIGHT SEATS



WEIGHT SAVING

COMFORT AND SUPPORT

F-TYPE's Sport and Performance seats have been engineered with sports cars in mind. The lighter magnesium construction of the seats saves over 8kg* of weight compared with previous generation models. Their streamlined form takes up less space, enabling a greater range of seating positions. Performance seats provide increased lateral support during dynamic driving and the option of cooling for greater comfort.

*Comparative weight saving for Performance seats. Sport seats are standard on F-TYPE and F-TYPE R-Dynamic. Performance seats are standard on F-TYPE R and F-TYPE SVR and optional on F-TYPE and F-TYPE R-Dynamic.

VEHICLE SHOWN ABOVE AND RIGHT: F-TYPE R-DYNAMIC AWD FEATURING EBONY WINDSOR LEATHER PERFORMANCE SEATS WITH IVORY CONTRAST STITCH WITH OPTIONAL FEATURES FITTED (MARKET DEPENDENT)







LUGGAGE SPACE

> 408 LITRES | **OPTIONAL POWERED TAILGATE***

We have designed the loadspace of F-TYPE Coupé to create a sports car that fits every lifestyle. With a capacity that is competitive with some well-known family hatchbacks – up to 408 litres (and up to 207 litres in F-TYPE Convertible) – F-TYPE Coupé certainly has the space to accommodate two generously sized suitcases for a weekend away. For added ease of access, the tailgate can be opened or closed at the touch of a button with the optional powered function.

*Coupé only.

VEHICLES SHOWN: F-TYPE IN INDUS SILVER AND F-TYPE R-DYNAMIC AWD IN SILICON SILVER WITH OPTIONAL FEATURES FITTED (MARKET DEPENDENT)

PERFORMANCE ENGINES OVERVIEW



HIGH PERFORMANCE ENGINES

RESPONSIVE POWER

All of F-TYPE's engines deliver high levels of torque and a near instantaneous response to your demand for power.

Making F-TYPE's dynamic performance more accessible is a 2.0 litre 4-cylinder 300PS Turbocharged Petrol engine from our Ingenium range. This highly advanced engine balances maximum driving pleasure with superb efficiency. One in a range of highly-acclaimed supercharged engines: a 3.0 litre V6 340PS, a 3.0 litre V6 380PS, a 5.0 litre V8 550PS and a 5.0 litre V8 575PS.

Every F-TYPE is fitted with an Active Sports Exhaust that creates a race-car inspired crescendo. The exhaust system reacts to throttle position, speed and engine revs by opening active valves. When open, these valves allow exhaust gases to take a more direct, less restrictive route through the rear silencer producing a much richer, more exhilarating sound. The Switchable Active Exhaust¹ allows you to manually open the exhaust valves so you can enjoy F-TYPE's stirring soundtrack at all engine speeds.

To improve fuel economy, particularly during urban driving, a fast-reacting intelligent Stop/Start system² is fitted to every F-TYPE as standard.



i4 ENGINE

179g/km CO₂

2.0 LITRE i4		300PS
Model availability	F-TYPE and F-TYPE R-DYNAMIC	
Cylinders/Valves per Cylinder	4/4	
Bore/Stroke	mm	83/92.3
Capacity	cc	1,997
Maximum Power	EEC-PS (kW)	300 (221)
Maximum Torque	EEC-Nm (lb. ft.)	400 (295)
Compression	ratio:1	9.5

¹Optional on F-TYPE, standard on F-TYPE R-Dynamic, F-TYPE R and F-TYPE SVR. ²Market dependent.
Fuel economy data shown is from the NEDC2 test cycle.

i4 ENGINE

> 2.0 LITRE 4-CYLINDER 300PS

The high performance Ingenium 2.0 litre 4-cylinder 300PS Turbocharged Petrol engine produces 400Nm of torque and delivers outstanding fuel economy and driveability.

- The intelligent Continuously Variable Valve Lift (CVVL) system varies the extent to which inlet valves are opened, reducing engine pumping losses. This lets the engine 'breathe' with maximum efficiency, optimising power and torque.
- CVVL works in combination with dual independent variable cam timing for ultimate operating flexibility, resulting in excellent power and fuel economy across the rev range.
- The twin-scroll Turbocharger is fed by an integrated exhaust manifold which increases the transfer of energy to the turbine - significantly reducing turbo lag and improving engine response.
- The twin-scroll Turbocharger features ceramic ball-bearings which reduce friction and improve transient response.

SINGLE CENTRE MOUNTED EXHAUST

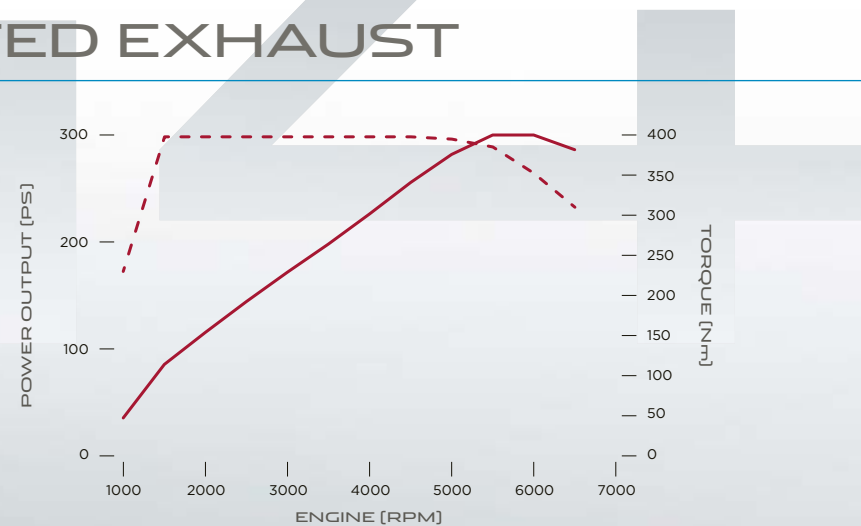

POWER [PS] ——— 300PS
TORQUE [NM] - - - - -

VEHICLE SHOWN: F-TYPE R-DYNAMIC IN YULONG WHITE WITH OPTIONAL FEATURES FITTED (MARKET DEPENDENT)

V6 ENGINES



3.0 LITRE V6 340PS

3.0 LITRE V6 380PS

3.0 litre V6 Supercharged Petrol engines produce up to 460Nm of torque for powerful and responsive performance.

- The Roots-type twin vortex supercharger provides linear power delivery and maximises responsiveness.
- A spray guided direct injection system carefully manages the air-fuel mixture in the combustion chamber for improved combustion, extracting more energy from the fuel injected. This results in excellent power, while improving fuel economy and reducing emissions.



V6 ENGINES

0-100km/h from 4.9 seconds

3.0 LITRE V6 SUPERCHARGED		340PS	380PS
Model availability		F-TYPE and F-TYPE R-DYNAMIC	
Cylinders/Valves per Cylinder		6/4	6/4
Bore/Stroke	mm	84.5/89	84.5/89
Capacity	cc	2,995	2,995
Maximum Power	EEC-PS (kW)	340 (250)	380 (280)
Maximum Torque	EEC-Nm (lb. ft.)	450 (332)	460 (339)
Compression	ratio:1	10.5	10.5

- The engine also features dual independent variable cam timing to vary inlet and exhaust valve operation, working alongside lightweight pistons with ultra-low friction piston rings, for increased performance and efficiency.
- A twin, contra-rotating balancer shaft system is employed to maximise refinement; resulting in an engine that delivers power smoothly.

CENTRE MOUNTED TWIN EXHAUSTS

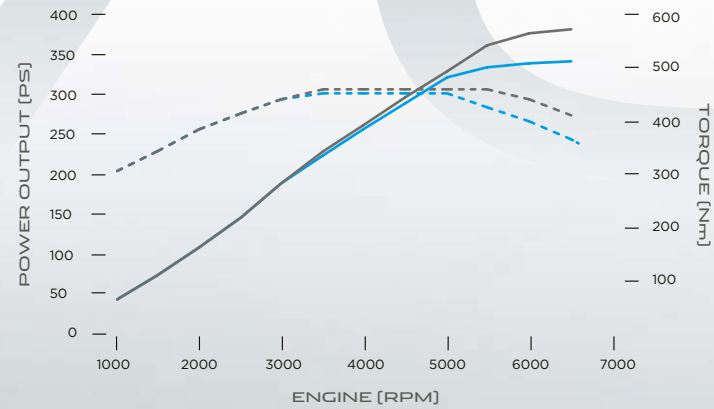

POWER [PS] 340PS 380PS
 TORQUE [NM] - - - - - - - - - -

VEHICLE SHOWN: F-TYPE IN YULONG WHITE WITH OPTIONAL FEATURES FITTED (MARKET DEPENDENT)

V8 ENGINES



5.0 LITRE V8 550PS

5.0 LITRE V8 575PS

5.0 litre V8 Supercharged Petrol engines produce up to 700Nm of torque for top of the range performance.

- The V8 has a compact and lightweight all-aluminium design, with impressively low levels of internal friction.
- The engine has been optimised around a state-of-the-art Bosch engine management system. This features high-pressure direct injection with a centrally mounted, multi-hole, spray-guided injection system.



V8 ENGINES

0-100km/h from 3.7 seconds

5.0 LITRE V8 SUPERCHARGED	550PS	575PS
Model availability	F-TYPE R	F-TYPE SVR
Cylinders/Valves per Cylinder	8/4	8/4
Bore/Stroke	mm 92.5/93	92.5/93
Capacity	cc 5,000	5,000
Maximum Power	EEC-PS (kW) 550 (405)	575 (423)
Maximum Torque	EEC-Nm (lb. ft.) 680 (502)	700 (516)
Compression	ratio:1 9.5	9.5

- Fitted with a sixth generation, Twin Vortex System (TVS) supercharger the engine offers superior thermodynamic efficiency and extremely refined noise levels. The supercharger fully utilises the additional capacity of the 5.0 litre engine, generating a torque profile that delivers outstanding levels of power in a linear and engaging manner.

OUTBOARD MOUNTED QUAD EXHAUSTS

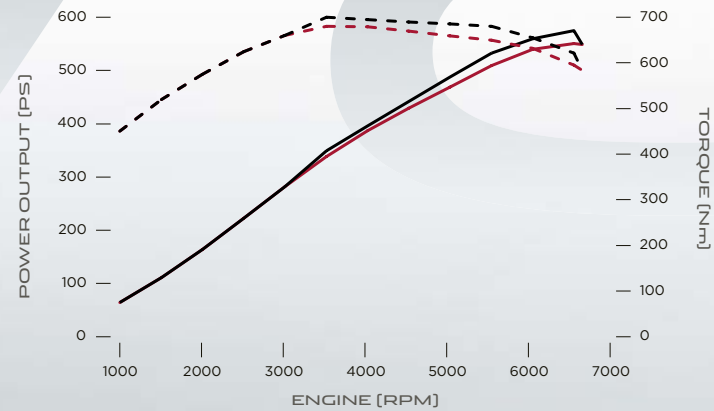

POWER [PS] 550PS 575PS
TORQUE [NM] - - - - - - - -

VEHICLE SHOWN: F-TYPE R IN YULONG WHITE WITH OPTIONAL FEATURES FITTED (MARKET DEPENDENT)

LIGHTWEIGHT ALUMINIUM ARCHITECTURE



STRONG AND RIGID

HIGH POWER-TO-WEIGHT AND TORQUE-TO-WEIGHT RATIOS



A lightweight aluminium body with a strong, stiff structure is the perfect platform for a sports car. We pioneered this technology over a decade ago and continue to push the boundaries today. It informs every aspect of how F-TYPE performs, handles and feels. A strong, stiff structure provides an inherently stable platform for precise, agile handling and allows the finely-tuned suspension system to deliver connectivity and driver feedback. Lightweight aluminium panels are bonded together with a super-strong adhesive, then punched with zinc-coated, boron steel rivets that compress the adhesive to form an airtight bond for phenomenal strength and rigidity. F-TYPE's body is the perfect complement to its high-performance engine range. Together they produce the exceptional power-to-weight and torque-to-weight ratios that deliver the real world measures of performance in a sports car.

The exterior panels are made from specially developed alloys. They combine robustness with greater formability, which gives clarity and tightness to curves and feature lines. On Coupé models, the side pressing is one of the most technically advanced in the automotive industry. It allows for cleaner lines with an extraordinarily beautiful, uninterrupted sweep from the front pillar to the trailing edge. This combination of advanced materials and innovative techniques has two advantages. It allows us to reproduce F-TYPE's crisp, crafted lines exactly as the designers intended. And it delivers a vehicle with extraordinary structural integrity.

VEHICLE SHOWN: F-TYPE IN INDUS SILVER WITH OPTIONAL FEATURES FITTED (MARKET DEPENDENT)



F-TYPE

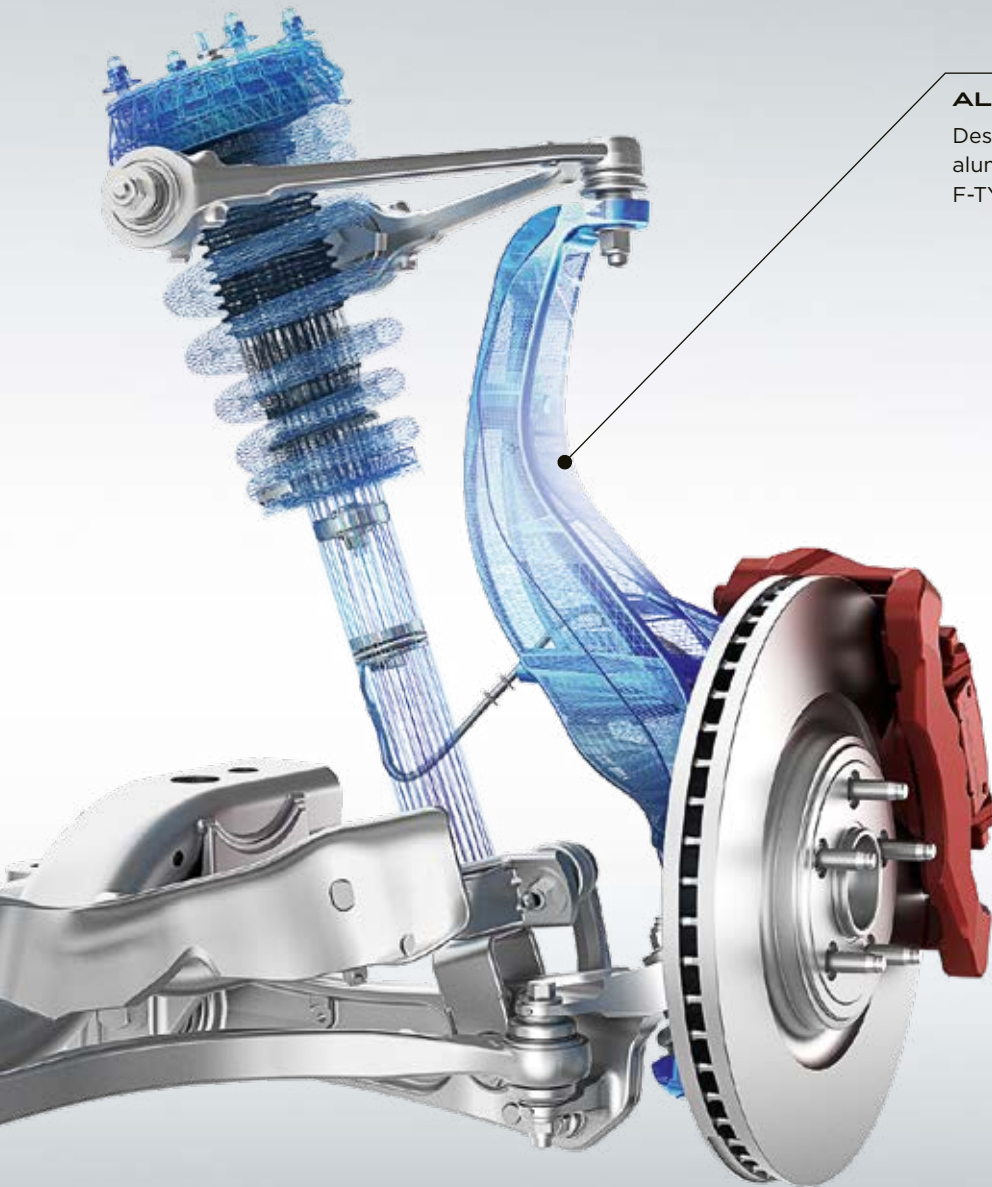

ALUMINIUM SUSPENSION KNUCKLES

Designed to optimise stiffness and strength, the lightweight aluminium front and rear suspension knuckles help improve F-TYPE's agility and responsiveness.

CHASSIS AND SUSPENSION



CONTROL AND COMFORT

DYNAMIC AND REFINED

F-TYPE's Lightweight Aluminium Architecture creates an immensely stable platform from which the forged aluminium double wishbone suspension can control the car. With the damping set-up optimised for the best partnership between dynamics and refinement, it gives the perfect combination of control, agility and feedback.

ADAPTIVE DYNAMICS

Standard on the 3.0 litre V6 380PS and 5.0 litre V8 engines, Adaptive Dynamics delivers both composed dynamics and a compliant ride. The system assesses body motion and pitch rates 100 times per second. The steering wheel position is also measured 500 times a second enabling the system to predict F-TYPE's movements. The stiffness of each damper is then adjusted to maintain body control and agility.

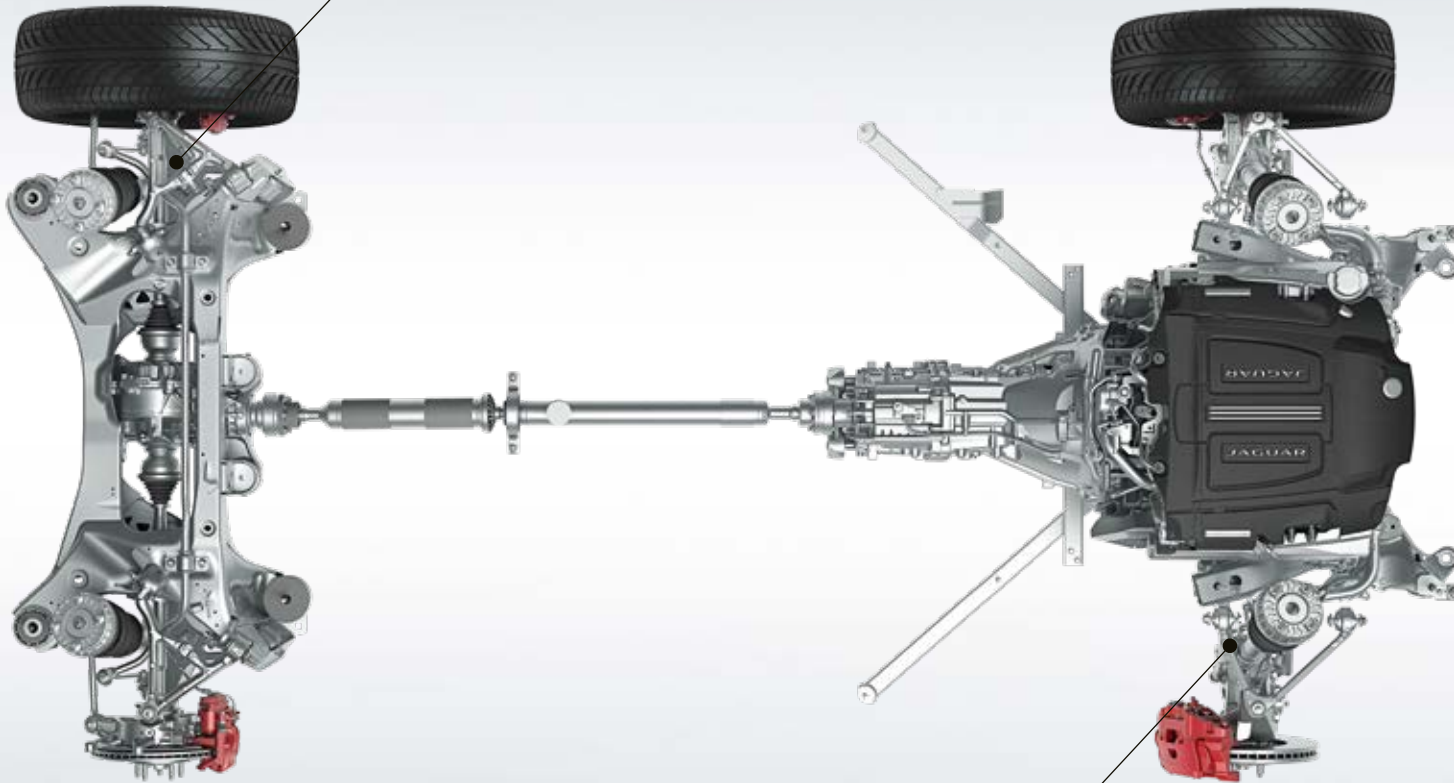

SUSPENSION

Considered by Jaguar as the best configuration for a suspension system, F-TYPE's forged aluminium double wishbone design offers precise handling and control.

ADVANCED AERODYNAMICS



LOW DRAG AND HIGH STABILITY

DEPLOYABLE REAR SPOILER

Aerodynamic performance is at the heart of F-TYPE's design. It is seamlessly integrated into the body for low levels of lift and excellent stability at high speed. Even the door handles retract to create an uninterrupted airflow along its flanks. The deployable rear spoiler* automatically rises at higher speeds to reduce lift by up to 120kg. A front splitter beneath the grille manages airflow along the vehicle's underside, with the sharply defined tail helping to separate air cleanly at lower speeds. The result is improved handling and stability.

*Optional on F-TYPE SVR.

VEHICLE SHOWN: F-TYPE R IN YULONG WHITE WITH OPTIONAL FEATURES FITTED (MARKET DEPENDENT)



1,413 LITRES

OF RECYCLED WATER PER MINUTE
BLASTED AT EVERY CAR TO ENSURE F-TYPE
IS MONSOON PROOF

10,000,000 HOURS

OF VIRTUAL TESTING, REDUCING OUR IMPACT ON THE
ENVIRONMENT WITH SIGNIFICANT SAVINGS IN RESOURCE,
WASTE, POWER AND FUEL

792,000

VIRTUAL VEHICLES CREATED
TO PERFECT F-TYPE

12,000 MILES

OF EXTREME TRACK TESTING ON GERMANY'S
INFAMOUS NÜRBURGRING RACE TRACK -
EQUIVALENT TO DRIVING HALF WAY AROUND THE WORLD



90°C

DIFFERENCE BETWEEN F-TYPE'S HOTTEST
(+50°C) AND COLDEST (-40°C) EXTREME CLIMATE
TESTING ENVIRONMENTS

300 TERABYTES

OF PERFORMANCE DATA GATHERED TO REFINE
EVERY MILLIMETRE OF F-TYPE

TESTED TO THE EXTREME



VIRTUAL ANALYSIS

REAL WORLD TRIALS

F-TYPE first took to the road in the virtual world of Jaguar's Computer Aided Engineering (CAE) systems ensuring that all components underwent extensive development and testing before being committed to the physical testing process. Engineers produced a series of virtual prototypes to realistically simulate the behaviour of complex mechanical systems allowing them to analyse multiple variations until the optimum design was achieved. For example, using a technique first used in the aerospace industry, aerodynamic testing took place in a virtual wind tunnel with Computational Fluid Dynamics running on high speed supercomputers. During its virtual life, F-TYPE completed half a million analyses, requiring 10 million computer processor hours and creating 300TB of data. The CAE development process was one of the key contributing factors in delivering F-TYPE's exhilarating performance and responsiveness.

The real world testing to fine tune the set-up took place in specialist facilities and the harshest environments across the globe in temperatures ranging from -40°C to +50°C, and at altitudes of up to 4,000m. High-speed stability tests, for example, were conducted at Nardò in southern Italy. The Nordschleife circuit at the Nürburgring in Germany was the perfect location to prove out handling, braking, cooling and durability. Known as the "Green Hell", and featuring 20.8 kilometres of track with 73 turns, it is renowned as the most demanding circuit in the world and the ultimate test of both car and driver.

VEHICLE SHOWN: F-TYPE R IN YULONG WHITE WITH OPTIONAL FEATURES FITTED
(MARKET DEPENDENT)

DRIVING TECHNOLOGY

ADVANCED DRIVING DYNAMICS



MAXIMISING AGILITY

CONTINUOUSLY ADAPTING

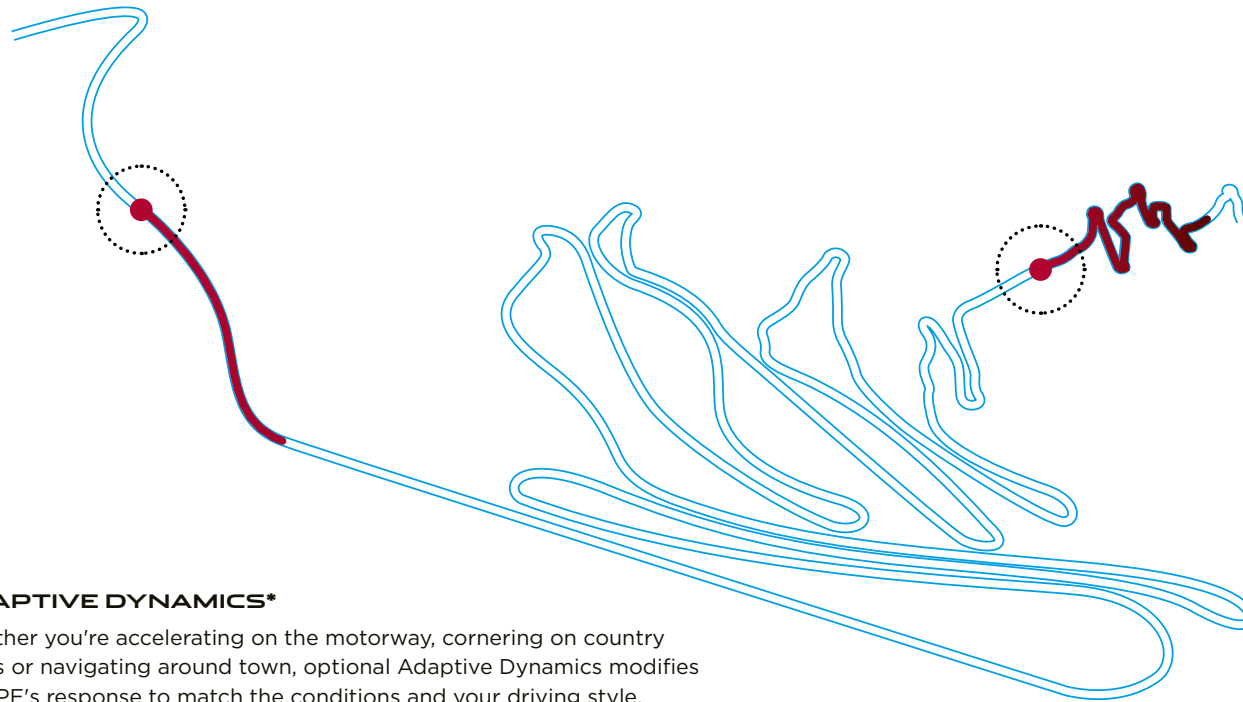

ADAPTIVE DYNAMICS*

Whether you're accelerating on the motorway, cornering on country roads or navigating around town, optional Adaptive Dynamics modifies F-TYPE's response to match the conditions and your driving style. It analyses acceleration, cornering, throttle and brake pedal activity as well as kick-down activation. Steering movement is analysed up to 500 times a second, and body movement up to 100 times a second. Electronically controlled dampers then constantly adjust to optimise the suspension settings and maintain F-TYPE's dynamism and comfort.

ELECTRIC POWER ASSISTED STEERING

Electric Power Assisted Steering (EPAS) offers outstanding feedback, control and is active on demand – saving power for where you really need it, as well as saving fuel. This steering system delivers the immediate response and connected feel expected from a Jaguar sports car. Sophisticated computer management varies steering assistance as appropriate – increasing assistance for low speed manoeuvring and improving feel at higher speeds.

*Only available with the 3.0 litre V6 380PS engine and 5.0 litre V8 engines.



INTENSIFIED PERFORMANCE



DYNAMIC MODE

CONFIGURABLE DYNAMICS



Engaging Dynamic Mode amplifies F-TYPE's sporting character. Gearshifts are faster and at higher engine speeds¹ with automatic upshifts prevented if in Manual Mode, throttle response is sharpened, the dampers are stiffened² and steering weighting is increased. Dynamic Mode also opens the Active Sports Exhaust for a more thrilling soundtrack and brings visual drama to the cabin - F-TYPE's instrument cluster and Configurable Ambient Interior Lighting³ instantly take on a red glow.

The Configurable Dynamics system² allows you to personalise F-TYPE's Dynamic Mode to create your perfect dynamic setup. Via the Touchscreen, four driving characteristics can be changed to Dynamic or left as normal. So whatever combination of throttle sensitivity, gearbox shift points¹, steering weighting or damper stiffness you want, Configurable Dynamics allows you to set up Dynamic Mode to suit your driving needs.

¹Automatic transmissions only.

²Not available with 2.0 litre 300PS engine or 3.0 litre 340PS engine.

³Standard on F-TYPE R and F-TYPE SVR. Optional on F-TYPE and F-TYPE R-Dynamic.



DRY ROAD CONDITIONS

In normal conditions, torque is distributed to the rear wheels, delivering acclaimed Jaguar agility and handling.

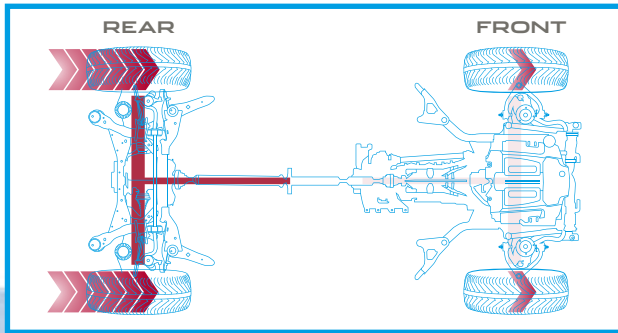

LOW TRACTION CONDITIONS

On slippery surfaces, such as grass and snow, torque can be balanced between the front and rear wheels to maximise traction. In extreme conditions where only the front wheels have traction, up to 100 percent of engine torque can be distributed to the front wheels for optimum grip.

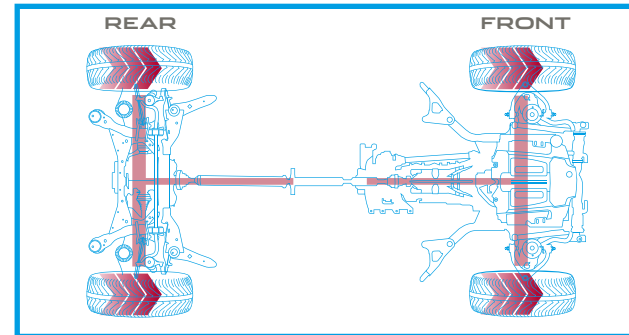

ADVANCED DRIVETRAIN TECHNOLOGY



ALL WHEEL DRIVE

INTELLIGENT DRIVELINE DYNAMICS

F-TYPE's All Wheel Drive (AWD) combines the agility and character of Rear Wheel Drive (RWD) with the increased security and traction provided by AWD. In normal driving, F-TYPE is predominantly RWD to deliver handling purity, feel and balance. But when roads become more challenging, or when you accelerate more keenly on low-grip surfaces, the system subtly channels power forwards enabling F-TYPE to maintain optimum traction for comfortable progress in all conditions.

F-TYPE's AWD uses a transfer case at the back of the 8-speed Automatic Transmission to manage the appropriate distribution of torque to the front and rear wheels. Engineered to ensure that F-TYPE retains the dynamic behaviour appropriate for a sports car, the transfer case contains an electro-mechanically activated multi-plate clutch with a smart actuator. Torque is delivered quickly and accurately, via a sophisticated ball ramp mechanism that develops the required force at the clutch, to transfer the optimal amount of torque to the front wheels.

Unlike other systems that react to wheel slip, Jaguar's Intelligent Driveline Dynamics (IDD) software is predictive and uses sensors measuring throttle and steering inputs to anticipate wheel slip. IDD seamlessly co-ordinates these inputs and compares them with responses from the engine, transmission and traction control systems to calculate the traction available and distribute torque accordingly, even before grip is lost. From a standstill, F-TYPE can transition from RWD to AWD in as little as 165 milliseconds, or just 100 milliseconds when the car is moving.

The result is a drive which blends the character of RWD with the capability of AWD, providing outstanding levels of performance and control whatever the road throws at you.

TORQUE VECTORING



**INCREASED STEERING
PERFORMANCE**

**ENHANCED
CORNERING CAPABILITY**

F-TYPE's Torque Vectoring maximises capability through even the tightest corners. Torque Vectoring technology provides controlled independent braking of the individual, inside front and rear wheels to add to the turning forces acting on the car. In most conditions more braking pressure is applied to the rear inside wheel as this supports the most increased cornering capability, while the front inside wheel is braked for greater effectiveness and refinement. The result is reduced understeer for sharper turning and more consistent road holding.

Torque Vectoring delivers increased agility and added driver confidence. On F-TYPE R and F-TYPE SVR, Torque Vectoring works together with the Electronic Active Differential system (see page 46), complementing each other to optimise traction and cornering ability as well as maximising steering feel and agility.

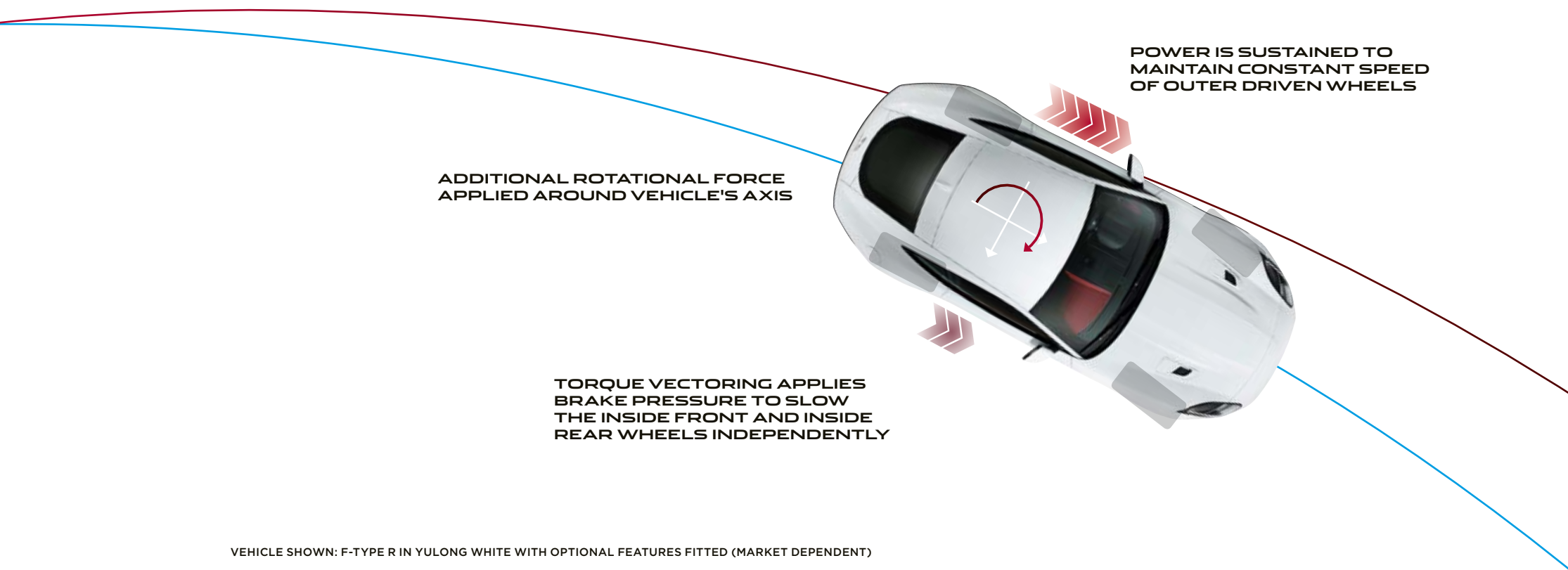

VEHICLE SHOWN: F-TYPE R IN YULONG WHITE WITH OPTIONAL FEATURES FITTED (MARKET DEPENDENT)



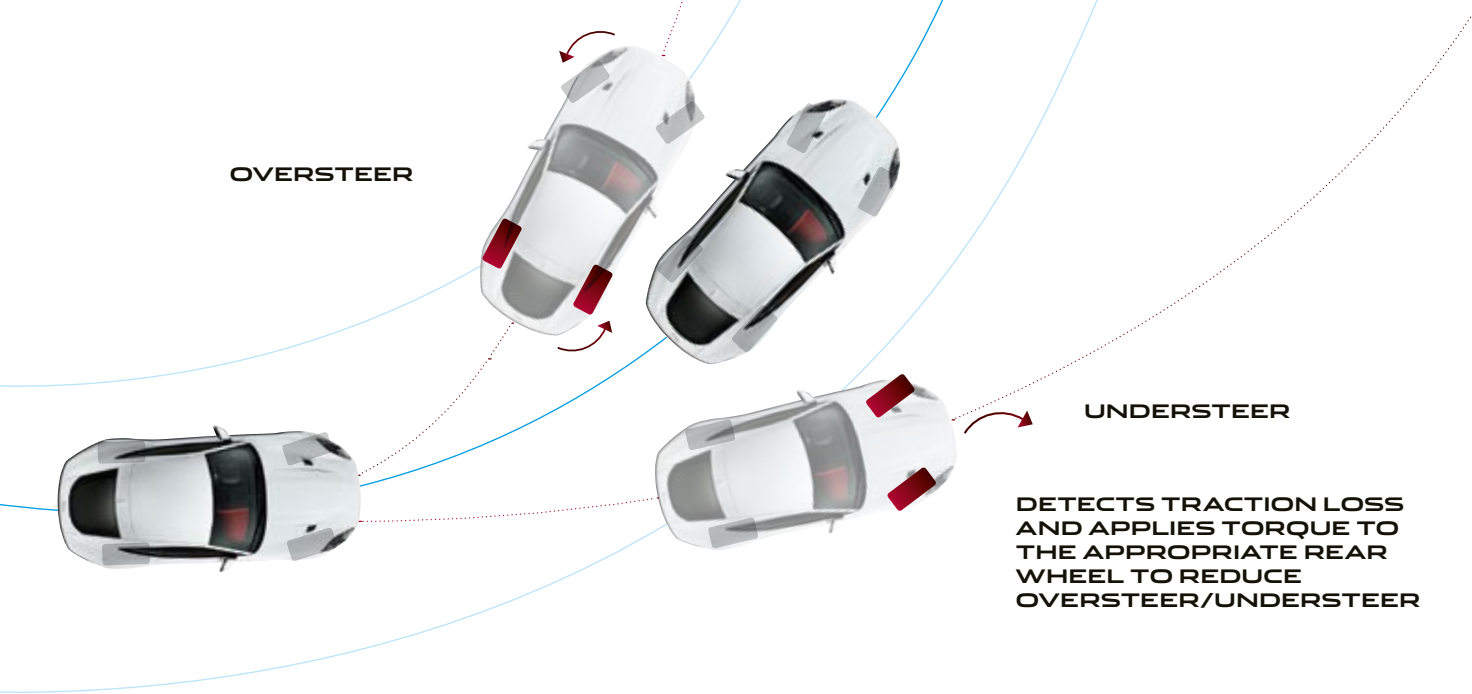

STABILITY AND CONTROL

> OUTSTANDING TRACTION | ELECTRONIC ACTIVE DIFFERENTIAL

Jaguar's stability systems keep F-TYPE well balanced whether you're driving enthusiastically or simply require the assurance of a car that will remain stable in challenging conditions. To fully harness their performance potential, and for greater control and traction, a Limited Slip Differential is fitted with the 3.0 litre V6 380PS engine and an Electronic Active Differential is fitted with the 5.0 litre V8 550PS and 575PS engines.

Limited Slip Differential: When a rear wheel has low grip, the Limited Slip Differential transfers torque through a mechanically activated clutch pack to the wheel that has more grip. This limits slip across the axle, improving control and traction for faster, more precise cornering.

Electronic Active Differential: Has a higher locking torque capacity to exploit the increased power and torque of the V8 engines. This differential works with the AWD system and Intelligent Driveline Dynamics (IDD) software, as well as F-TYPE's traction and stability systems, to maximise traction and improve cornering control. Variable electronic control allows this differential to continually adjust locking torque between the wheels - this gives sharper turn in when entering corners and the ability to accelerate sooner when leaving corners because the torque at each wheel is more controllable.

VEHICLE SHOWN: F-TYPE R IN YULONG WHITE WITH OPTIONAL FEATURES FITTED (MARKET DEPENDENT)





JAGUAR
CARBON CERAMIC

PERFORMANCE BRAKING SYSTEMS

> LIGHTWEIGHT | POWERFUL | DURABLE

A range of braking systems are available, each one engineered to deliver a confident, progressive feel and consistent high performance. The calipers use aluminium to reduce the unsprung mass of the car, benefiting both handling and ride refinement. Each system features large, ventilated brake discs – up to 398mm in diameter on the carbon ceramic system. This large swept area improves braking force as well as providing greater capacity for the discs to absorb and dissipate the heat energy generated during braking.

Jaguar's Carbon Ceramic Braking System, with its striking Yellow monobloc calipers is the most powerful braking system ever fitted to a Jaguar road car. It offers up to 21kg of weight saving, further reducing unsprung mass. With greater resistance to fade and wear, it delivers high levels of sustained performance in the most demanding conditions.

355MM FRONT AND
325MM REAR BRAKES



STANDARD ON 300PS AND 340PS ENGINES
CALIPERS: SILVER

380MM FRONT AND
325MM REAR BRAKES



STANDARD ON 380PS ENGINES
CALIPERS: BLACK OR RED

380MM FRONT AND
376MM REAR BRAKES



STANDARD ON F-TYPE R AND F-TYPE SVR
OPTIONAL ON F-TYPE AND F-TYPE R-DYNAMIC
CALIPERS: BLACK OR RED

398MM FRONT AND
380MM REAR CARBON
CERAMIC BRAKES



OPTIONAL ON MODELS WITH
AUTOMATIC TRANSMISSION*
CALIPERS: YELLOW

*Not available on 300PS and 340PS engines.

For more details on brake availability refer to page 92-93 or configure your vehicle at jaguar.com





TECHNOLOGY INFOTAINMENT

Delivering a wealth of information and entertainment, every F-TYPE is equipped with our InControl infotainment system, Touch Pro. It features intuitive and advanced integrated technologies to ensure everyone can make the most of their journey.

TOUCH PRO 10" SCREEN

The standard 10" Touchscreen at the heart of the centre console supports swipe and pinch gestures and delivers our richest ever audio-visual entertainment. To enhance the in-car experience, Touch Pro offers customisable homescreens and fast response times. Multi-tasking is also made easy thanks to the Interactive Side Panel.

All in car features should be used by drivers only when safe for them to do so. Drivers must ensure they are in full control of the vehicle at all times.

INTERIOR SHOWN: F-TYPE SVR FEATURING EBONY WINDSOR LEATHER PERFORMANCE SEATS WITH IVORY CONTRAST STITCH

CONNECTIVITY

InControl is Jaguar's suite of standard and optional features that connects you to your vehicle and links you seamlessly, and securely, with the outside world. There are a range of packs and options available to choose from. With a selection of apps, even when you're away from your car, some of the InControl features stay with you, making sure the Jaguar experience is more enjoyable than ever.

STANDARD FEATURES

NAVIGATION PRO

Navigation Pro allows you to save your favourite places, use swipe and pinch-to-zoom gestures for simple map exploration and display a choice of either 2D or 3D crystal clear map graphics. You can also keep maps up-to-date with the latest release with Map Care¹. Navigation Pro functionality is further enhanced by Connect Pro.

CONNECT PRO PACK²

Connect Pro consists of InControl Apps, Remote Premium and Pro Services. It's designed to enhance your in-car and out-of-car experience, ensuring you and your passengers enjoy the journey whilst remaining connected to the world.

SMARTPHONE PACK³

By screen sharing with F-TYPE's infotainment system, the Smartphone Pack helps you stay safely connected to your smartphone even while in the car. Featuring Jaguar InControl Apps technology, the Smartphone Pack allows vehicle-optimised apps on your Android™ or Apple® smartphone to be controlled through the Touchscreen, including your contacts, calendar and music player, via a USB cable. You can also download third-party apps offering a vast range of services.

INCONTROL APPS

Features a range of Jaguar approved apps that can be connected to F-TYPE from your smartphone. It ensures safe and convenient use of apps optimised to enhance aspects of your in-car experience. You can also download third-party apps offering a vast range of services.

¹Free map updates for the period of the warranty. ²Certain features require an appropriate micro SIM with a suitable data contract, which will require further subscription after the initial term as advised by your Jaguar Retailer. ³Features within Smartphone Pack may vary between markets.

iPhone® is a registered trademark of Apple Inc., registered in the US and other countries. Please ensure iPhone compatibility is reviewed with your local Jaguar Retailer.



PROTECT

Jaguar Optimised Assistance – If you break down, you can make a direct call to the Jaguar Assistance team by pressing the button on the overhead console or from the Assistance screen within the Remote smartphone app.

SOS Emergency Call – In a more serious incident, SOS Emergency Call will automatically connect you to the emergency response team who will notify the emergency services to your location. For peace of mind, this service is provided for the first ten years from date of registration.

Remote Essentials – Remote smartphone app provides information on your vehicle and enables you to interact with it remotely. Compatible with most smartphones, Android Wear™ or the Apple Watch®, this service includes:

- **Journey Tracking** – This opt-in feature can automatically record your journey history including your route and mileage statistics. This information can be exported by email to use for expense reporting and can be imported to a spreadsheet.
- **Vehicle Status Check** – Check current fuel level and range, and status of door and window position and locks. See the last parked location of the vehicle and find your way back to it with on-foot directions.

Remote contains subscription services that can be extended after the initial term advised by your Jaguar Retailer. InControl features, options and their availability remain market dependent – check with your Jaguar Retailer for local market availability and full terms. Information and images displayed in relation to the InControl technology, including screens or sequences, are subject to software updates, version control and other system/visual changes depending on options selected. Mobile network connectivity cannot be guaranteed in all locations. InControl Apps and Remote App will need to be downloaded from the Apple/Play Store. All in-car features should be used by drivers only when safe for them to do so. Drivers must ensure they are in full control of the vehicle at all times.

Jaguar Optimised Assistance is a subscription service that can be extended after the initial term advised by your Jaguar Retailer.

REMOTE PREMIUM

Allows you to monitor as well as interact with your F-TYPE from your smartphone. Remote start F-TYPE to pre-condition the climate, lock and unlock the car, locate your F-TYPE on a map or using the beep and flash function, and track your journeys.

- **Remote Lock/Unlock** – Lock or unlock your doors remotely with the click of a button. Simply press the 'lock' button on the Vehicle Security screen of the Remote smartphone app to single lock the doors, arm the alarm, fold in the wing mirrors¹ and close the windows². Press the 'unlock' button to unfold the wing mirrors, turn on the dipped headlights and cause the hazard lights to flash twice.
- **Remote Climate** – Prepare your F-TYPE in advance by pre-heating or pre-cooling the cabin, so that you and your passengers are comfortable from the moment you step inside.
- **Beep/Flash** – This feature turns on your Jaguar's hazard lights, dipped headlights and sounds an audible alert to help you locate your vehicle in a crowded car park.

PRO SERVICES³

Offers a number of enhanced capabilities designed to help you reach your destination easily:

- **Real Time Traffic Information** – Uses live traffic data feeds to give you the most accurate picture of what the traffic is like on the way to your destination.
- **One-Box Search** – Wherever you are, you can search the surrounding area for places of interest. The system can access expert destination information, travel tips and inspiration as well as online travel reviews of the local area.
- **Planning Routes and Door-to-Door Routing** – Before setting off, use the Route Planner app or online to search, save locations or set your destination. The app uses the Cloud to send your destination automatically to your vehicle's navigation screen. Once you've parked, the Route Planner app will guide you to your destination – a true door-to-door experience which includes public transport options.
- **Share ETA** – You can share your estimated time of arrival so your selected contact(s) will know exactly when you will arrive, as calculated by the navigation guidance system. If you're running late, Share ETA can then send automatic updates via text messages or email, without any further action from you.

¹When power fold mirrors are specified. ²Market dependent. ³Features within Pro Services may vary between markets.

⁴Secure Tracker will require further subscription after the initial term as advised by your Jaguar Retailer.

- **Satellite View** – When you want to get the context of your surroundings from overhead, simply switch to satellite view.
- **Commute Mode** – Allows the system to learn your commutes and automatically advises you of the expected journey time based on live and historical traffic movements without you having to input a destination. The system learns the routes you take for a given destination and then advises which of those is the quickest. The feature can be turned on and off dependent on driver preference.
- **Parking Service** – As you approach your destination, you can see where parking is available. Simply tap on your preferred car park and the navigation system updates to direct you to it.
- **Online Routing** – While you're on your way to a destination the system monitors live traffic conditions and takes into account typical traffic patterns for that time of day, keeping you on the optimum route.
- **Safety Cameras** – Alerts you to the location of accident black spots monitored by safety cameras.
- **Fuel Prices** – When you're going to fill up, the Fuel Price service not only finds filling stations along your route, it also enables you to compare fuel prices so you can keep your costs down.

OPTIONAL FEATURE

SECURE TRACKER⁴

Uses tracking technology to alert you to an attempted theft, and signals your vehicle's location to the relevant authorities for a timely recovery. Includes service subscription for warranty period.

Remote contains subscription services that can be extended after the initial term advised by your Jaguar Retailer. InControl features, options and their availability remain market dependent – check with your Jaguar Retailer for local market availability and full terms. Information and images displayed in relation to the InControl technology, including screens or sequences, are subject to software updates, version control and other system/visual changes depending on options selected. Mobile network connectivity cannot be guaranteed in all locations. InControl Apps and Remote App will need to be downloaded from the Apple/Play Store. All in-car features should be used by drivers only when safe for them to do so. Drivers must ensure they are in full control of the vehicle at all times.

AUDIO

A vehicle's cabin is the ideal place within which to experience your personal choice of music and Jaguar F-TYPE has the option of two different audio systems to bring your music to life:

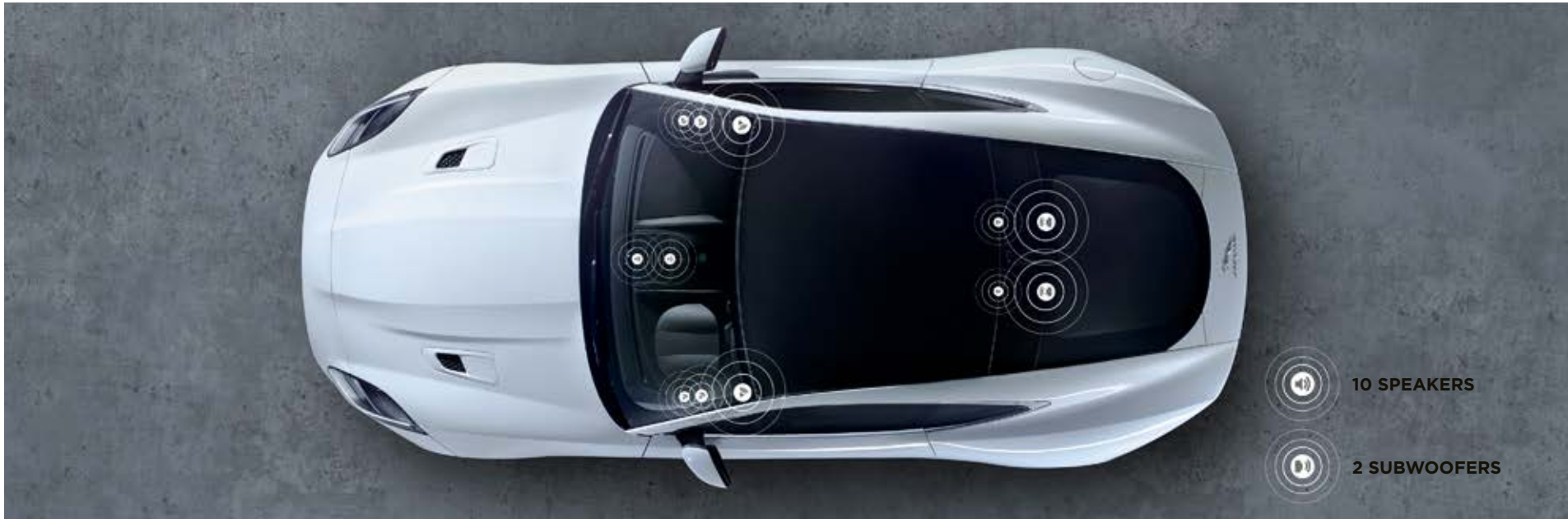

MERIDIAN™ SOUND SYSTEM - 380W¹

Great definition, crystal clear highs and full, deep bass – delivered through the careful arrangement of 8 speakers and 2 subwoofers.

MERIDIAN SURROUND SOUND SYSTEM - 770W²

All the fullness and clarity of a live performance delivered through an arrangement of 10 speakers and 2 subwoofers – seamlessly brought together using Trifield™ technology. Exclusive to Meridian, Trifield perfectly blends the centre and surround channels with left and right channels ensuring an optimum, consistent sound experience for each passenger.

DIGITAL AUDIO BROADCAST (DAB) RADIO²







The option of DAB radio technology offers improved sound quality, a wide choice of stations and live text information about the station, show and song you are listening to.

¹Standard on all models. ²Optional.

Image is representative of Meridian Surround Sound System.

MERIDIAN™

Formed in 1977 in Cambridgeshire, England, Jaguar’s audio partner Meridian has pioneered many firsts including active speakers and the world’s first digital surround sound processor. Meridian’s audio technology input has helped ensure that Jaguar F-TYPE is the most superb space within which to experience sound. Meridian Cabin Correction technology was utilised to analyse cabin shape, acoustics and resonance characteristics in order to help remove unwanted sounds. The advanced algorithm ensures that the rhythm, punch and timing of any piece of music are heard precisely how the artist intended, providing a consistently exceptional quality audio experience for all passengers in the vehicle.

	UNIQUE MERIDIAN TECHNOLOGY	SPEAKERS + SUBWOOFERS	WATTS
MERIDIAN™ SOUND	  	8 + 2	380
MERIDIAN™ SURROUND SOUND	   	10 + 2	770



DIGITAL SIGNAL PROCESSING

Brings all elements of the audio system together as one, for performance that would otherwise require significantly larger speakers.



MERIDIAN CABIN CORRECTION

The advanced algorithm of Meridian’s Cabin Correction tailors the sound experience to the precise acoustics of F-TYPE’s interior.



MERIDIAN DIGITAL DITHER SHAPING

To maintain the quality of musical recordings, they are converted into a common digital format. Meridian Digital Dither Shaping ensures that digital signal conversions are made smoothly and seamlessly, preserving the finest details of the audio performance. The result is authentic musical conversion, evoking the emotions of the original recording.



TRIFIELD

Exclusive to Meridian, Trifield™ blends the centre and surround channels seamlessly with left and right channels, delivering a consistent, concert-like experience for all occupants.

SAFETY

DRIVER ASSISTANCE

F-TYPE's technology is designed to keep you safe and take the stress out of driving. It can help with everything from reducing the chance of a motorway collision to avoiding minor bumps in a car park. This range of advanced active and passive safety systems give you the reassurance, information and control to focus on the pleasure of the drive.



PARKING AIDS

Front and Rear Parking Aids help make manoeuvring even easier. When you select Reverse, or choose to activate them manually, sensors located in the front and rear bumpers are triggered. As you park, the Touch Pro display and audio feedback indicate how close you are to obstacles.



PARK ASSIST

Our Park Assist system makes parallel parking in a tight spot easier than ever by steering your car into a suitable space. You just have to select the appropriate gear and control the car's speed. Park Assist will also steer you out of a space, taking all of the stress out of parking. Graphics and notifications guide you through both manoeuvres.



REAR CAMERA

Rear Camera provides improved visibility when reversing. Guiding lines representing the vehicle's outer perimeter and predicted path are superimposed onto the rearward image displayed.

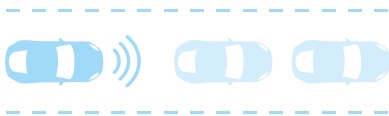

EMERGENCY BRAKING

Emergency Braking can help to prevent collisions with other vehicles or pedestrians. If a potential frontal collision is detected, a warning is displayed, giving you time to take action. A camera at the front of the vehicle monitors at speeds from 5 to 80km/h for frontal collisions and 5 to 60km/h for pedestrians. If a collision is still anticipated and you have taken no action, this system will apply the brakes to help reduce the severity of the possible impact.



EMERGENCY BRAKE ASSIST

If the brakes are applied rapidly, this system boosts braking force to the maximum for shorter stopping distances. It can also help retain greater steering control in unexpected situations.

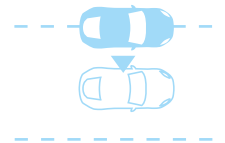

LANE KEEP ASSIST

Lane Keep Assist detects when the vehicle is unintentionally drifting out of the lane, and applies corrective torque to the steering wheel, encouraging you to guide your vehicle back.

For more details on feature availability refer to page 85 or configure your vehicle at jaguar.com. For information on airbags refer to page 80.

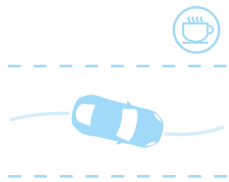

DRIVER CONDITION MONITOR

Our Driver Condition Monitor knows if you're starting to feel drowsy or fatigued – giving you an early warning when you need to take a break.



TRAFFIC SIGN RECOGNITION AND ADAPTIVE SPEED LIMITER

Our Traffic Sign Recognition system keeps you fully informed and aware on the road, by displaying speed limits and no overtaking signs in the instrument cluster where they can easily be seen. When activated, our Adaptive Speed Limiter uses Traffic Sign Recognition information to adjust your car's speed accordingly.



BLIND SPOT ASSIST AND REAR TRAFFIC MONITOR

Blind Spot Assist can help you prevent collisions. If your vehicle detects another car in your blind spot when you begin to change lanes, a small warning light illuminates in the corresponding wing mirror. Corrective torque is also applied to the steering wheel, encouraging you to guide your vehicle away from the approaching vehicle. Reverse Traffic Monitor warns you of hazards, approaching from either side of your vehicle, through both audible and visual warnings so you know what's behind you even when the view is obstructed.

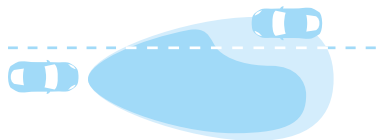

AUTO HIGH BEAM ASSIST

The Auto High Beam Assist system automatically switches between low and high beam when necessary, using a sensor mounted at the front of the rear view mirror.

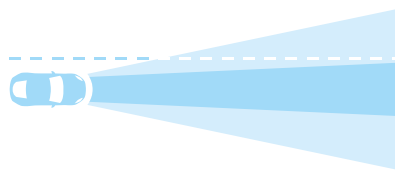

LED FRONT LIGHTING SYSTEM

This system automatically provides the best possible illumination in all driving situations by adjusting F-TYPE's headlight beam to your speed and the weather conditions. At slower speeds it widens the low beam to illuminate your peripheral vision, helping you to see pedestrians and junctions. At higher speeds the system raises and narrows the low beam for extended visibility.



PEDESTRIAN CONTACT SENSING SYSTEM

Help protect the people outside your car as well as those inside. If the car makes contact with a pedestrian, our industry-leading Pedestrian Contact Sensing System is designed to automatically raise the bonnet to help cushion a potential impact.



THE THEATRE OF DREAMS

SPECIAL VEHICLE OPERATIONS

JAGUAR'S CENTRE OF EXCELLENCE

Special Vehicle Operations (SVO) assembles and hand finishes halo models and limited run collector's editions, including the F-TYPE SVR. Each one showcases the best of Jaguar with stunning performance, exceptional luxury and cutting-edge technology. With a dedicated team of designers, engineers and technicians, SVO takes precision engineering to new heights and offers the opportunity for more individuality, choice and personalisation. A car from SVO is the ultimate expression of Jaguar.

SVO is based at a brand new Technical Centre in Warwickshire, England. This 20,000m² specialist manufacturing facility has been established to enable our most discerning clients to indulge their passion for Jaguar. Our state-of-the-art facility features over 40 engineering inspection bays, a commissioning suite and an environmentally sustainable world-class paint facility.

F-TYPE is available with an optional range of specially formulated, ultra metallic premium palette of 18 colours and finishes. These latest high technology colours and finishes are applied at our state-of-the-art SVO facility. All Ultra Metallic colours come in a Gloss Finish or, as an additional option, Satin Matte finish (See pages 90-91).





THE CONCEPT OF F-TYPE SVR



STATE-OF-THE-ART MATERIALS

ADVANCED AERODYNAMICS

F-TYPE SVR is designed and engineered at Special Vehicle Operations where our highly skilled engineers and aerodynamics experts have scrutinised every possible component to maximise F-TYPE SVR's performance. In both Coupé and Convertible form, it is the ultimate F-TYPE. State-of-the-art materials and advanced aerodynamic design push F-TYPE beyond the extraordinary with an exceptional powertrain that makes F-TYPE SVR our fastest production car ever. Delivering supreme performance, ride and handling, F-TYPE SVR creates once-in-a-lifetime driving experiences - every day.

F-TYPE SVR's lightweight All Wheel Drive with Intelligent Driveline Dynamics (IDD), delivers the engine's power with efficiency and control. The 5.0 litre V8 engine has been recalibrated to produce 575PS and 700Nm of torque, with a power-to-weight ratio of 337PS/tonne. It will take you from 0-100km/h in just 3.7 seconds and on to a top speed of 322km/h.* But it is about more than numbers, more than just a machine. Jaguar makes performance an art.

F-TYPE SVR is our latest masterpiece.

*Coupé only.





F-TYPE SVR AERODYNAMICS



**MAXIMISED
CAPABILITY**

**ADJUSTABLE
DOWNFORCE**

F-TYPE SVR's performance is not expressed by its exterior design: it is created by it. Form follows function in every swooping curve and finely drawn line. Each unique styling element, down to the smallest, subtle detail, improves F-TYPE SVR. Its advanced aerodynamic design offers less drag and higher levels of downforce. As a result F-TYPE SVR slices cleanly through the air, achieving rapid acceleration and effortlessly efficient cruising. Strong downforce improves stability and handling, road holding and dynamic capability.

FRONT INTAKES AND SPLITTER

Unique large lower bumper intakes maximise airflow for cooling of both the engine and brakes for improved performance. A precision splitter designed specially for F-TYPE SVR directs airflow into the car for optimum cooling. It also creates downforce at the front of the car to balance the rear wing.

BONNET LOUVRES AND SIDE POWER VENTS

Uniquely shaped louvres maximise airflow through the engine bay. This aids cooling, so the engine can operate at the highest level. Air from the wheel housing is released through side power vents which manage airflow around the wheel arch to minimise drag and improve F-TYPE SVR's efficiency.

ENHANCED COOLING

F-TYPE SVR's cooling system has been enhanced with significant improvements to airflow. To achieve this, the auxiliary radiator has been relocated, while the bumper beam profile and inlet trumpet size have been reduced. This increases the full performance envelope on F-TYPE SVR for greater endurance in extreme driving situations.

VEHICLES SHOWN ABOVE AND PREVIOUS PAGES: F-TYPE SVR IN CALDERA RED WITH OPTIONAL FEATURES FITTED (MARKET DEPENDENT)



AERODYNAMIC WING

The aerodynamic wing is integral to F-TYPE SVR's enhanced performance. Compared with the standard F-TYPE Coupé's rear wing, F-TYPE SVR produces more downforce but crucially less drag. The wing is more elevated and wider than the standard F-TYPE Coupé's spoiler, enabling it to act over the whole width of the car rather than just the width of the boot lid.

Air passes both over and under the wing, allowing Bernoulli's principle to act in the car's favour - faster moving air underneath the wing is at a lower pressure than that passing over the top, resulting in additional downforce.

F-TYPE SVR's wing operates in two different positions:

On F-TYPE SVR Coupé the aerodynamic wing deploys at 113km/h and stows at 80km/h.

On F-TYPE SVR Convertible the aerodynamic wing deploys at 97km/h and stows at 64km/h.

DEPLOYED WING

When F-TYPE SVR's wing is deployed it increases downforce for greater stability and improved handling at top speed. In this position the wing gives a drag coefficient reduction of 2.5 percent and a lift coefficient reduction of 15 percent.

STOWED WING

For maximum top speed (V-Max), the wing is stowed to reduce drag. It works in conjunction with the front spoiler and other aerodynamic enhancements to bring a drag coefficient improvement of 7.5 percent and lift coefficient reduction of 45 percent.

V-MAX

In order to achieve 322km/h* you must consciously prepare your F-TYPE SVR. Select 'Dynamic Mode' and press the deployable aerodynamic wing switch for 3 seconds to enable V-Max Mode. While active, a permanent symbol appears on the instrument cluster. In this mode the spoiler remains stowed at all speeds keeping drag to a minimum.

REAR UNDERFLOOR AND DIFFUSER

The smooth rear underfloor reduces drag, whilst the rear diffuser works with the rear underfloor to manage airflow, adding to F-TYPE SVR's stability.

*Coupé only.



F-TYPE SVR LIGHTWEIGHT TECHNOLOGIES



WEIGHT SAVING

INNOVATIVE DESIGN

Weight is the enemy of performance. So we designed F-TYPE SVR to be as lean as possible. Every gram has a reason to be there. Every milligram saved gives you more rapid acceleration, more agile handling and sharper braking. Yet the interior still offers comfort and luxury in equal measures. F-TYPE SVR has the capability to make performance effortlessly enjoyable.

FORGED ALLOY WHEELS

F-TYPE SVR's bespoke Forged alloy wheels are fitted with unique Pirelli P ZERO™ tyres. Its tyres are 10mm wider than standard F-TYPE tyres, for improved handling and grip. While the striking Forged alloys offer a 13.8kg overall weight saving.

CERAMIC BRAKES

F-TYPE SVR's optional CCM brakes save up to 21kg of weight compared with non-ceramic alternatives.

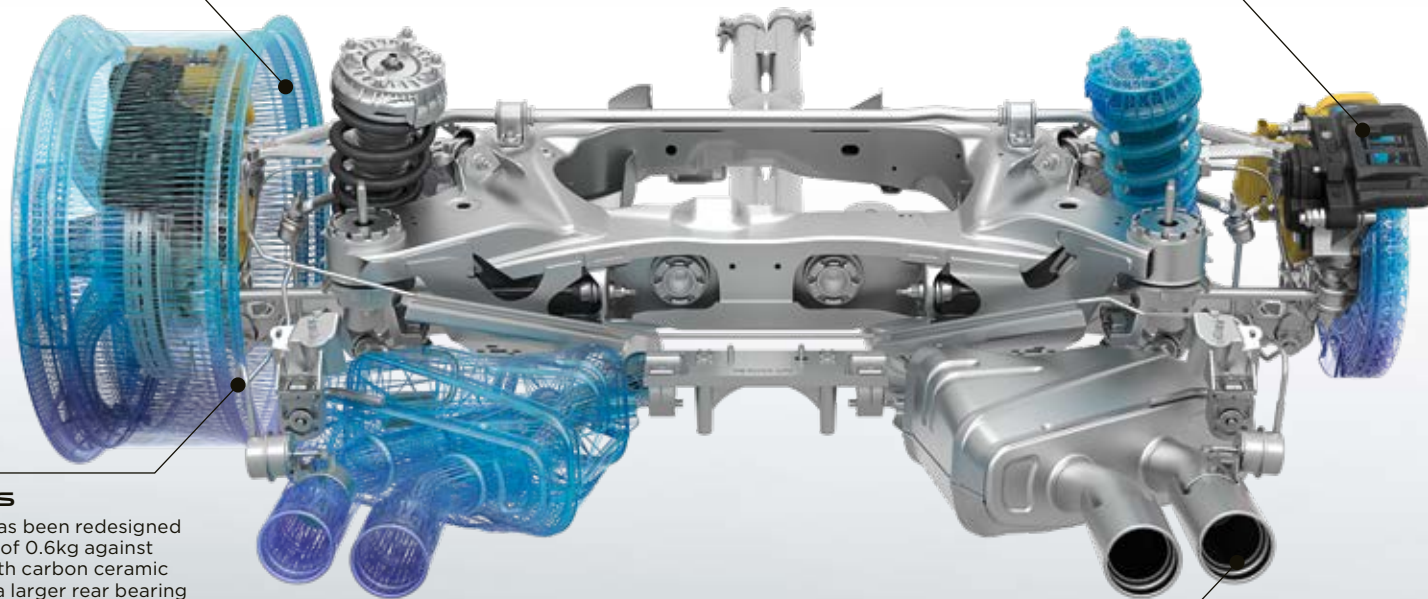

REAR KNUCKLES

The suspension system has been redesigned enabling a weight saving of 0.6kg against conventional knuckles with carbon ceramic brakes. F-TYPE SVR has a larger rear bearing that contributes towards an increased stiffness of up to 37 percent over conventional F-TYPE knuckles. This enables the car to handle even higher lateral g-forces.

TITANIUM EXHAUST

The lightweight Titanium and Inconel® exhaust system saves 16kg. With its SVR badged tailpipes, it not only looks unique, it sounds unique - F-TYPE SVR is recognisable by the distinctive rumble of its exhaust.





F-TYPE SVR INTERIOR

> UNIQUE DETAILS | SPORTING CRAFTSMANSHIP

Just as no detail of F-TYPE SVR's engineering and exterior design has been overlooked, its interior is testament to the SVO division's attention to detail. The moment you open the door, the SVR treadplate shows that you are entering a special space.

Exclusive materials are everywhere you look, from fine contrast stitching to ultra-modern finishes that create a sense of total luxury. The SVR badged steering wheel with larger aluminium anodised gearshift paddles offers the perfect connection to the road and the quilted Performance seats offer comfort and support while you enjoy the dynamic drive.

VEHICLE SHOWN: F-TYPE SVR FEATURING EBONY QUILTED LEATHER PERFORMANCE SEATS WITH CIRRUS STITCH AND MICROPING AND OPTIONAL FEATURES FITTED (MARKET DEPENDENT)

PERSONALISATION F-TYPE - YOUR CHOICE



Configure your vehicle at jaguar.com



CHOOSE YOUR ENGINE

Page 72

Select one of F-TYPE's powerful, efficient petrol engines to suit your driving style.

CHOOSE YOUR MODEL & OPTIONS

Page 76

Compare the wealth of standard features and options on F-TYPE models.

CHOOSE YOUR COLOUR

Page 88

Express your individuality with one of F-TYPE's stunning exterior colours.

CHOOSE YOUR

WHEELS & BRAKING SYSTEM

Page 92

Complement your F-TYPE's stunning style with a set of beautifully designed alloy wheels.

CHOOSE YOUR

INTERIOR

Page 94

There's a wide selection of premium materials, leathers and finishes for every personal taste.

CHOOSE YOUR

JAGUAR GEAR - ACCESSORIES

Page 108

Really make it yours by adding style, practicality and versatility with official F-TYPE Gear Accessories from your local Jaguar Retailer.

1 CHOOSE YOUR ENGINE

 Configure your vehicle at jaguar.com

> i4 ENGINE

2.0 LITRE i4

TURBOCHARGED PETROL [300PS] RWD
AUTOMATIC

MAXIMUM POWER 300PS

MAXIMUM TORQUE 400Nm

ACCELERATION 0-100 km/h
5.7 seconds

TOP SPEED 250 km/h

F-TYPE, F-TYPE R-DYNAMIC,
F-TYPE CHEQUERED FLAG EDITION



0-100 KM/H

TOP SPEED KM/H

> V6 ENGINES

3.0 LITRE V6

SUPERCHARGED PETROL [340PS] RWD
MANUAL OR AUTOMATIC

MAXIMUM POWER 340PS

MAXIMUM TORQUE 450Nm

ACCELERATION 0-100 km/h
Manual 5.7 seconds / Auto 5.3 seconds

TOP SPEED 260 km/h

F-TYPE, F-TYPE R-DYNAMIC,
F-TYPE CHEQUERED FLAG EDITION*



MANUAL
0-100 KM/H

MANUAL
TOP SPEED KM/H



AUTO
0-100 KM/H

AUTO
TOP SPEED KM/H

3.0 LITRE V6

SUPERCHARGED PETROL [380PS] RWD
MANUAL OR AUTOMATIC

MAXIMUM POWER 380PS

MAXIMUM TORQUE 460Nm

ACCELERATION 0-100 km/h
Manual 5.5 seconds / Auto 4.9 seconds

TOP SPEED 275 km/h

F-TYPE, F-TYPE R-DYNAMIC,
F-TYPE CHEQUERED FLAG EDITION*



MANUAL
0-100 KM/H

MANUAL
TOP SPEED KM/H



AUTO
0-100 KM/H

AUTO
TOP SPEED KM/H

*Automatic only. **Coupé only.

> V8 ENGINES

3.0 LITRE V6

SUPERCHARGED PETROL [380PS] AWD
AUTOMATIC

MAXIMUM POWER 380PS

MAXIMUM TORQUE 460Nm

ACCELERATION 0-100 km/h
5.1 seconds

TOP SPEED 275 km/h

F-TYPE, F-TYPE R-DYNAMIC,
F-TYPE CHEQUERED FLAG EDITION



0-100 KM/H

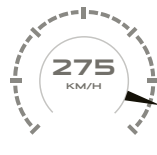

TOP SPEED KM/H

5.0 LITRE V8

SUPERCHARGED PETROL [550PS] AWD
AUTOMATIC

MAXIMUM POWER 550PS

MAXIMUM TORQUE 680Nm

ACCELERATION 0-100 km/h
4.1 seconds

TOP SPEED 300 km/h

F-TYPE R



0-100 KM/H

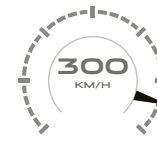

TOP SPEED KM/H

5.0 LITRE V8

SUPERCHARGED PETROL [575PS] AWD
AUTOMATIC

MAXIMUM POWER 575PS

MAXIMUM TORQUE 700Nm

ACCELERATION 0-100 km/h
3.7 seconds

TOP SPEED 322 km/h**

F-TYPE SVR



0-100 KM/H

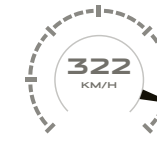

TOP SPEED KM/H



NEW F-TYPE CHEQUERED FLAG

Slip into the driving seat of Jaguar F-TYPE Chequered Flag and feel its power. This car is the embodiment of pure excitement. Pure engineering. Pure performance. Just like the years of racing heritage that inspired its design, F-TYPE Chequered Flag is a compelling achievement. Under the sculpted bonnet is the familiar, raw power of F-TYPE. Such design details as unique badging, body-coloured sport side sills and Black contrast roof add to the car's dynamic appearance. Whilst inside, 'Chequered Flag' embossed seats, a race-inspired Red top centre steering wheel marker and an uncompromising attention to detail all help to reinforce Jaguar's pedigree. Go ahead, put your foot down, make some noise. This is a car that relishes being out on the road.

F-TYPE CHEQUERED FLAG FEATURES

- A choice of i4 Ingenium and V6 Supercharged Petrol engines. Coupé or convertible. Rear Wheel Drive (RWD) or All Wheel Drive (AWD).

Exterior:

- Available in Caldera Red, Fuji White or Carpathian Grey • Exterior Black Design Pack with extended side sills
- Chequered Flag has extended side sills vs 'Exterior Black Design Pack' • Black contrast roof • 20" 6 split-spoke 'Style 6003' with Gloss Black finish • Red brake calipers • 'Chequered Flag' badge, front and rear.

Interior:

- Ebony Windsor leather interior with Pimento Red or Cirrus stitching • Ebony suedecloth headlining • 'Chequered Flag' embossed Performance seats • Red seatbelts • 'Chequered Flag' heated steering wheel with Red top centre marker
- 'Chequered Flag' embroidered mats • Black Brushed Aluminium console finisher • Red illuminated metal treadplates.



2 CHOOSE YOUR MODEL

 Configure your vehicle at jaguar.com



F-TYPE

KEY FEATURES

- Active Sports Exhaust
- Dynamic Mode
- Emergency Braking
- Deployable boot lid spoiler
- Xenon headlights with LED signature
- LED tail lights
- Infrared reflective windscreen
- Sport seats with leather and suedecloth facings
- 6-way electric front seats
- Leather steering wheel with Silver gearshift paddles (automatic only)
- Knurled Aluminium centre console
- 10" Touchscreen
- Meridian™ Sound System
- Navigation Pro
- Front and Rear Parking Aids
- Rear Camera

300PS & 340PS

- Passive suspension
- Open Differential with Torque Vectoring
- 18" alloy wheels
- 355mm front and 325mm rear brakes with Silver brake calipers

380PS

- Adaptive Dynamics
- Limited Slip Differential with Torque Vectoring
- 19" alloy wheels
- 380mm front and 325mm rear brakes with Black brake calipers
- All Wheel Drive (optional)



F-TYPE R-DYNAMIC

KEY FEATURES (IN ADDITION TO F-TYPE)

- Switchable Active Sports Exhaust
- Design Pack in Gloss Black
- LED headlights with signature DRL
- Delta Aluminium centre console
- R-Dynamic treadplates

300PS & 340PS

- Passive suspension
- Open Differential with Torque Vectoring
- 19" alloy wheels
- 355mm front and 325mm rear brakes with Silver brake calipers

380PS

- Adaptive Dynamics
- Limited Slip Differential with Torque Vectoring
- 20" alloy wheels
- 380mm front and 325mm rear brakes with Black brake calipers
- All Wheel Drive (optional)



F-TYPE R

KEY FEATURES

550PS

- All Wheel Drive
- 380mm front and 376mm rear brakes with Red brake calipers
- Electronic Active Differential with Torque Vectoring
- Configurable Dynamics Mode
- Configurable Dynamics Mode
- 20" R alloy wheels
- Bright metal pedals
- Windsor leather interior
- R Performance seats
- 12-way electric front seats with memory
- R branded leather steering wheel with Silver gearshift paddles
- Linear Vee Aluminium centre console with R branding
- Configurable Ambient Interior Lighting
- Wind deflector (Convertible only)



F-TYPE SVR

KEY FEATURES (IN ADDITION TO F-TYPE R)

575PS

- Lightweight Titanium and Inconel® exhaust
- 20" Forged alloy wheels
- Redesigned aerodynamics
- Carbon Fibre rear aerodynamic wing
- SVR Performance seats
- Suedecloth headlining
- Heated SVR branded leather steering wheel with aluminium gearshift paddles
- Dark Brushed Aluminium centre console with SVR branding

2 CHOOSE YOUR OPTIONS

 Configure your vehicle at jaguar.com

ROOF STYLES

F-TYPE offers a range of different roofs to suit your own personal style. Each delivering their own distinctive characteristics, they provide a powerful expression of individual flair both inside the cabin and to the outside world.



ALUMINIUM ROOF

For the pure Coupé look, F-TYPE's aluminium roof is as strong and lightweight as the rest of the vehicle. It provides the ideal complement in colour, style and line to the powerful F-TYPE profile. The aluminium roof expresses F-TYPE in its clearest sports car form.



PANORAMIC GLASS ROOF

Introducing even more natural light and airiness to the interior, a full width panoramic glass roof is optional on F-TYPE Coupé models. For increased seclusion, should it be required, the roof features a manually sliding 'black-out' blind, which can screen the occupants from up to 99 percent of the incoming light.



CARBON FIBRE ROOF*

With Carbon Fibre outer and inner panels bonded together to create a strong yet light roof structure, F-TYPE Coupé's optional Carbon Fibre roof is 20 percent lighter than the standard aluminium roof. It features Carbon Fibre weave visible through a deep, high-grade lacquered finish.



CONVERTIBLE ROOF

F-TYPE Convertible's lightweight fabric roof is available in a choice of four colours. Acoustically enhanced with composite fabric to reduce noise, it features a flush fitting heated glass rear window. The roof can be raised or lowered in just 12 seconds and operated fully automatically at speeds of up to 50km/h.

*Please consult your local Jaguar Retailer for availability.

VEHICLES SHOWN: F-TYPE R IN YULONG WHITE WITH OPTIONAL FEATURES FITTED (MARKET DEPENDENT)

CONVERTIBLE ROOF COLOURS

STANDARD OPTIONAL

Black

Grey

Red

Beige

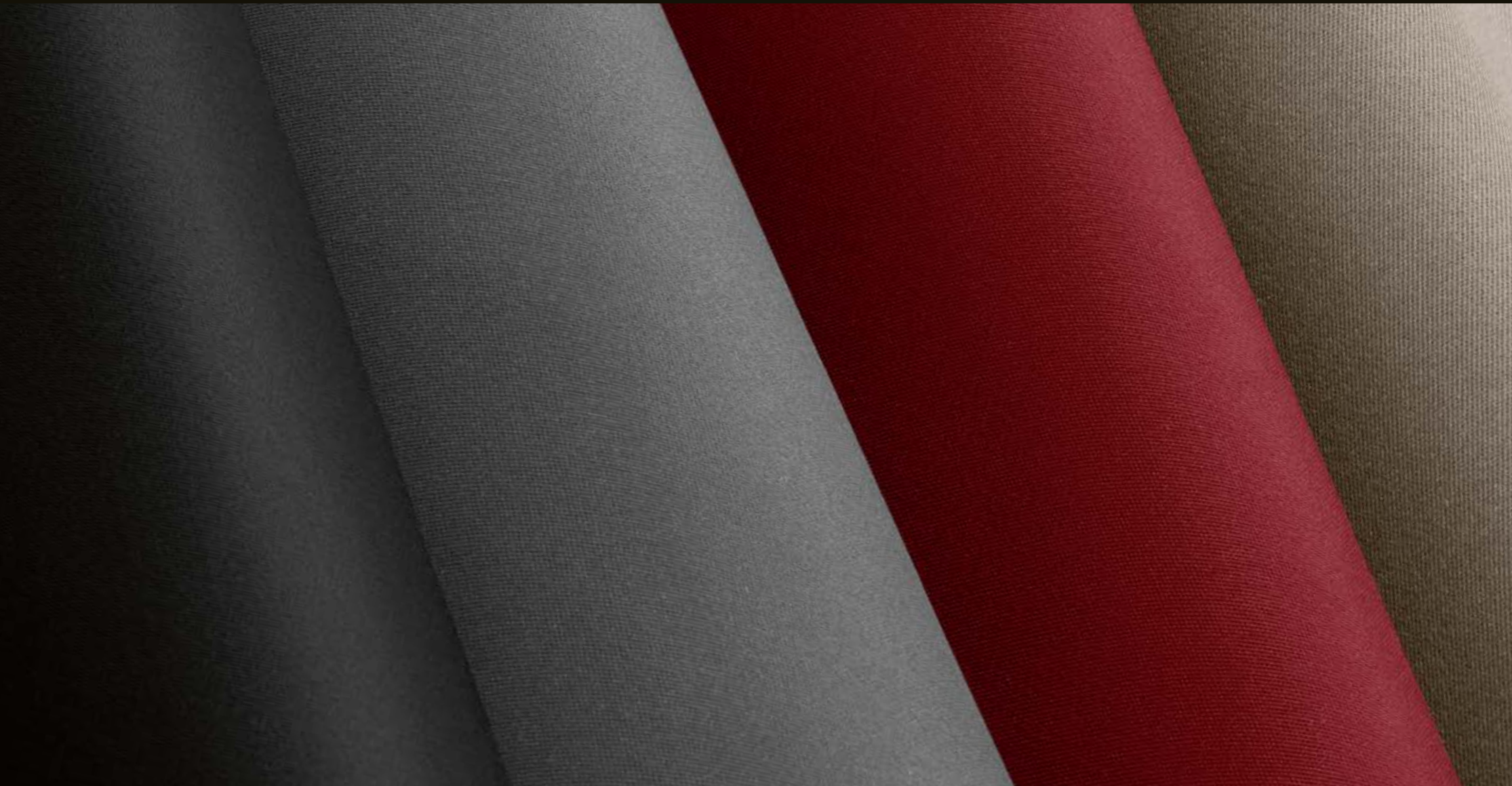

2 CHOOSE YOUR OPTIONS

 Configure your vehicle at jaguar.com

KEY STANDARD FEATURES	F-TYPE	F-TYPE R-DYNAMIC	F-TYPE R	F-TYPE SVR	DESCRIPTION
	Rain, Ice, Snow Mode	●	●	●	
Dynamic Stability Control (DSC)	●	●	●	●	
Airbags	●	●	●	●	4 airbags in Convertible, 6 airbags in Coupé
Electric Parking Brake (EPB)	●	●	●	●	
Emergency Braking	●	●	●	●	
Emergency Brake Assist	●	●	●	●	
Anti-lock Braking System (ABS)	●	●	●	●	
Electronic Brake-force Distribution (EBD)	●	●	●	●	
Flush exterior door handles	●	●	●	●	
Body-coloured door mirror caps	●	●	●	●	
Rain sensing windscreen wipers	●	●	●	●	
LED tail lights	●	●	●	●	
Deployable front air vents	●	●	●	●	
Auto-dimming Interior Rear View Mirror	●	●	●	●	
Overhead lighting console	●	●	●	●	
Twin front cupholders	●	●	●	●	
10" Touch Pro	●	●	●	●	
Power socket	●	●	●	●	
USB and 12V socket in centre console	●	●	●	●	
Remote central locking with deadlocks and drive-away locking	●	●	●	●	
Perimetric alarm and immobiliser	●	●	●	●	
Boot entrapment release lever	●	●	●	●	
Push Button Start	●	●	●	●	
Valet Mode	●	●	●	●	
Lane Keep Assist	●	●	●	●	See pages 58-59
Driver Condition Monitor	●	●	●	●	See pages 58-59
Traffic Sign Recognition and Adaptive Speed Limiter	●	●	●	●	See pages 58-59
Front and Rear Parking Aids	●	●	●	●	See pages 58-59
Rear Camera	●	●	●	●	See pages 58-59

● Standard ○ Option — Not available ■ Part of Pack

Please consult your local Jaguar Retailer for details.

For a complete list of optional features and packs refer to the F-TYPE Specification and Price Guide or configure your vehicle at jaguar.com

KEY OPTIONAL FEATURES

		F-TYPE (300PS & 340PS)	F-TYPE (380PS)	F-TYPE R-DYNAMIC (300PS & 340PS)	F-TYPE R-DYNAMIC (380PS)	F-TYPE R (550PS)	F-TYPE SVR (575PS)	
TRANSMISSION AND DYNAMIC FEATURES								DESCRIPTION
Carbon Fibre gear selector	117AT	○	○	○	○	—	—	Only available with manual transmission
Silver gearshift paddles	078CN	●	●	●	●	●	—	Only available with automatic transmission
Aluminium gearshift paddles	078CP	—	—	—	—	○	●	Only available with automatic transmission
Adaptive Dynamics	027CW	—	●	—	●	●	●	
Passive suspension	027CZ	●	—	●	—	—	—	
Dynamic Mode	088IL	●	●	●	●	—	—	
Configurable Dynamics	184AB	—	○	—	○	●	●	
Open Differential with Torque Vectoring	027DH	●	—	●	—	—	—	
Limited Slip Differential with Torque Vectoring	027DJ	—	●	—	●	—	—	
Electronic Active Differential with Torque Vectoring	027DC	—	—	—	—	●	●	
Active Sports Exhaust	037AX	●	●	—	—	—	—	
Switchable Active Exhaust	037CF	○	○	●	●	●	●	
BRAKES								
Silver brake calipers	020BJ	●	—	●	—	—	—	
Red brake calipers	020BE	○	○	○	○	●	●	Only available as an option with 380mm front and 325mm rear brakes or 380mm front and 376mm rear brakes
Black brake calipers	020BK	○	●	○	●	○	○	Only available as an option with 380mm front and 325mm rear brakes or 380mm front and 376mm rear brakes
Yellow brake calipers	020BL	—	■	—	■	■	■	Part of Carbon Ceramic Brake Pack
355mm front and 325mm rear brakes	020DV	●	—	●	—	—	—	
380mm front and 325mm rear brakes	020JC	—	●	—	●	—	—	Only available with Red brake calipers or Black brake calipers
380mm front and 376mm rear brakes	020JB	○	○	○	○	●	●	Only available with Red brake calipers or Black brake calipers. Not available with 18" wheels
398mm front and 380mm rear carbon ceramic brakes	020JD	—	■	—	■	■	■	Part of Carbon Ceramic Brake Pack

2 CHOOSE YOUR OPTIONS

 Configure your vehicle at jaguar.com

EXTERIOR FEATURES AND FINISHERS		F-TYPE	F-TYPE R-DYNAMIC	F-TYPE R	F-TYPE SVR	
EXTERIOR FEATURES AND FINISHERS						
Black fully electric convertible roof	041CM	●	●	●	●	Only available on Convertible
Grey fully electric convertible roof	041DF	○	○	○	○	Only available on Convertible
Red fully electric convertible roof	041DG	○	○	○	○	Only available on Convertible
Beige fully electric convertible roof	041DK	○	○	○	○	Only available on Convertible
Gloss Black roll over protection bars	027BU	■	■	■	●	Only available on Convertible. Part of Black Exterior Pack
Satin Chrome roll over protection bars	027BV	●	●	●	—	Only available on Convertible
Carbon Fibre roof	041CO	○	○	○	○	Only available on Coupé
Panoramic glass roof	041CX	○	○	○	○	Only available on Coupé
Powered boot lid	070AV	○	○	○	○	Only available on Coupé
Deployable rear spoiler	070CA	●	●	●	○	Reduces top speed of F-TYPE SVR to 300km/h when selected
Fixed rear spoiler	070AR	○	○	○	—	Only available on Coupé. Requires Switchable Active Exhaust
Carbon Fibre rear aerodynamic wing	070CC	—	—	—	●	
GLASS AND EXTERIOR MIRRORS						
Privacy glass	047DB	○	○	○	○	Only available on Coupé. Tailgate glass only
Heated windscreen	040AK	○	○	○	○	
Heated door mirrors	030NA	●	●	—	—	
Power fold, heated door mirrors	030NB	○	○	—	—	
Powerfold, heated door mirrors with memory	030RF	—	—	●	●	
Auto-dimming, power fold, heated door mirrors	030RG	○	○	—	—	
Auto-dimming, power fold, heated door mirrors with memory	030PC	○	○	○	○	Not available with 6 way electric front seats
Solar attenuating windscreen	047EB	●	●	●	●	
HEADLIGHTS AND LIGHTING						
Xenon headlights with LED signature	064CW	●	—	—	—	
LED headlights with signature DRL	064GK	○	●	●	●	
Auto High Beam Assist (AHBA)	030NT	○	○	○	○	Only available with LED headlights with signature DRL
EXTERIOR COLOURS						
Solid paint		●	●	●	●	
Metallic paint		○	○	○	○	
Premium Metallic paint		○	○	○	—	
SVO Ultra Metallic paint		○	○	○	○	
SVO Special Effect paint		○	○	○	○	
WHEELS						
Reduced section alloy spare wheel	029VT	○	○	○	○	Not available with Carbon Ceramic Brake Pack
Tyre Repair System	029SJ	●	●	●	●	

INTERIOR SEATING

SEATING	CODE	F-TYPE	F-TYPE R-DYNAMIC	F-TYPE R	F-TYPE SVR	DESCRIPTION
Sport seats	033MC	●	●	—	—	
Performance seats	033MT	○	○	■	—	Linked to Windsor Leather Interior Pack, Suedecloth Interior Pack or Extended Windsor Leather Interior Pack on F-TYPE and F-TYPE R-Dynamic. R embossing is removed on F-TYPE R with Suedecloth Interior Pack and Extended Windsor Leather Interior Pack
R Performance seats	033MU	—	—	●	—	
SVR Performance seats	033MW	—	—	—	●	
Grained leather and suedecloth seats	033JC	●	●	—	—	
Windsor leather seats	033HJ	■	■	●	—	Part of Windsor Leather Interior Pack
Suedecloth and Windsor leather seats with contrast stitching	033AL	■	■	■	—	Part of Suedecloth Interior Pack
Lozenge quilted leather	033YQ	—	—	—	●	
Red seat belts	032HC	○	○	○	○	Red seat belts can be fitted to Ebony seats with Ebony stitching, Pimento contrast stitching or Pimento seats
6-way electric front seats	300JA	●	●	—	—	
6-way heated electric front seats	300JB	○	○	—	—	Not available with Leather Performance seats
6-way heated and cooled electric front seats	300JC	○	○	—	—	Only available with Performance seats and Windsor Leather interior
12-way electric front seats with memory	300JD	○	○	●	●	Only available with electrically adjustable steering column with memory. Requires auto-dimming, power fold, heated door mirrors with memory on F-TYPE and F-TYPE R-Dynamic
12-way heated electric front seats with memory	300JE	○	○	○	—	Only available with electrically adjustable steering column with memory. Not available with Leather Performance seats. Requires auto-dimming, power fold, heated door mirrors with memory on F-TYPE and F-TYPE R-Dynamic
12-way heated and cooled electric front seats with memory	300JF	○	○	○	○	Only available with Performance seats and electrically adjustable steering column with memory. Requires Leather interior and auto-dimming, power fold, heated door mirrors with memory on F-TYPE and F-TYPE R-Dynamic

HEADLINING

HEADLINING	CODE	F-TYPE	F-TYPE R-DYNAMIC	F-TYPE R	F-TYPE SVR	DESCRIPTION
Leather headlining	088FE	■	■	■	■	Refer to Page 94-95 for full details on interior colour availability Requires Windsor Leather Headlining Pack
Suedecloth headlining	088HE	■	■	■	●	Requires Suedecloth Upper Environment Pack
Morzine headlining	088HH	●	●	●	—	
Ebony headlining	032BU	●	●	●	●	
Grey headlining	032FG	○	○	○	—	Morzine only
Pimento headlining	032FH	○	○	○	○	Not available on Coupé. Leather only
Ivory headlining	032CV	○	○	○	—	Not available with panoramic glass roof. Leather only

● Standard ○ Option — Not available ■ Part of Pack

Please consult your local Jaguar Retailer for details.

For a complete list of optional features and packs refer to the F-TYPE Specification and Price Guide or configure your vehicle at jaguar.com

Refer to page 94-95 for full details on interior colour availability.

2 CHOOSE YOUR OPTIONS

 Configure your vehicle at jaguar.com

INTERIOR FEATURES

INTERIOR FEATURES	CODE	F-TYPE	F-TYPE R-DYNAMIC	F-TYPE R	F-TYPE SVR	DESCRIPTION
Sunvisors	115AU	●	●	—	—	
Sunvisors with vanity mirrors	115AQ	○	○	●	—	Only available in Ebony or Grey
Suedecloth sunvisors with vanity mirrors	115AT	■	■	■	●	Part of Suedecloth Upper Environment Pack
Leather sunvisors with vanity mirrors	115AS	■	■	■	■	Part of Windsor Leather Headlining Pack
Bright metal pedals	051AJ	○	○	●	●	Only available with automatic transmissions
Wind deflector	041EB	○	○	●	●	Only available on Convertible
Electrically adjustable steering column	049AV	●	●	—	—	
Electrically adjustable steering column with memory	049AE	○	○	●	●	Not available with 6 way electric front seats
Leather steering wheel	032BV	●	●	—	—	
Flat-bottom leather steering wheel	032LF	○	○	—	—	
Flat-bottom leather steering wheel with Black spokes	032LA	■	■	—	—	Part of Interior Black Pack
R branded leather steering wheel	032FL	—	—	●	—	
R branded flat-bottom leather steering wheel	032FQ	—	—	○	—	
R branded flat-bottom leather steering wheel with Black spokes	032LE	—	—	■	—	Part of Interior Black Pack
SVR branded leather steering wheel	032FO	—	—	—	●	
SVR branded suedecloth steering wheel	032FI	—	—	—	○	Not available with heated steering wheel
Heated steering wheel	032DV	○	○	○	●	
Premium carpet mats	079CA	●	●	■	—	Part of Suedecloth Interior Pack unless standard
Sport carpet mats	079DE	○	○	—	—	
Nubuck edged carpet mats	079DG	—	—	—	●	
Contrast carpet mats	079BT	■	■	●	—	Part of Full Windsor Leather Interior Pack

● Standard ○ Option — Not available ■ Part of Pack

Please consult your local Jaguar Retailer for details.

For a complete list of optional features and packs refer to the F-TYPE Specification and Price Guide or configure your vehicle at jaguar.com

		F-TYPE	F-TYPE R-DYNAMIC	F-TYPE R	F-TYPE SVR	
INTERIOR FEATURES [CONTINUED]						
Single-zone Climate Control	022AX	●	●	●	●	
Two-zone Climate Control	022AY	○	○	○	○	
Air Quality Sensor	022FA	○	○	○	○	
Configurable Ambient Interior Lighting	064FM	○	○	●	●	
Illuminated metal treadplates with Jaguar script	048BD	○	○	○	○	

SAFETY AND SECURITY

SAFETY AND SECURITY						
Pedestrian Contact Sensing	050BC	●	●	●	●	
Garage door opener (HomeLink®)	025CT	○	○	○	○	
Keyless Entry	066AC	○	○	●	●	
Tyre Pressure Monitoring System (TPMS)	062AD	●	●	●	●	
Rear Camera	086FA	●	●	●	●	
Cruise Control and Speed Limiter	065AB	●	●	●	●	
Front Parking Aid	086EG	●	●	●	●	
Rear Parking Aid	086EH	●	●	●	●	
Emergency Braking	065EA	●	●	●	●	
Park Assist	086GZ	○	○	○	○	
Blind Spot Assist with Rear Traffic Monitor	086GM/086KB	○	○	○	○	Requires Auto-dimming, power fold, heated door mirrors
Lane Keep Assist	086BG	●	●	●	●	
Driver Condition Monitor	086DH	●	●	●	●	
Traffic Sign Recognition and Adaptive Speed Limiter	086DC	●	●	●	●	

2 CHOOSE YOUR OPTIONS

 Configure your vehicle at jaguar.com

INFORMATION, COMMUNICATION AND ENTERTAINMENT

		F-TYPE	F-TYPE R-DYNAMIC	F-TYPE R	F-TYPE SVR	
INFORMATION AND COMMUNICATION						
Protect	011BE	●	●	●	●	
Remote Premium	011DA	●	●	●	●	Part of Connect Pro Pack
InControl Apps	025PA	●	●	●	●	Part of Connect Pro Pack
10" Touch Pro	025NE	●	●	●	●	
Navigation Pro	087AU	●	●	●	●	
Secure Tracker	011AE	○	○	○	○	Includes service subscription for warranty period
Pro Services	025RK	●	●	●	●	Part of Connect Pro Pack
Bluetooth® connectivity	025MA	●	●	●	●	
Smartphone Pack		●	●	●	●	
5" central TFT display with instrument panel - 300km/h	038IE	●	●	—	—	
5" central TFT display with instrument panel - 320km/h	038IF	—	—	●	●	
AUDIO						
Digital Audio Broadcast (DAB) Radio	025JB	○	○	○	○	
Meridian™ Sound System (380W)	025LM	●	●	●	●	
Meridian™ Surround Sound System (770W)	025LN	○	○	○	○	

● Standard ○ Option — Not available ■ Part of Pack

Please consult your local Jaguar Retailer for details.

For a complete list of optional features and packs refer to the F-TYPE Specification and Price Guide or configure your vehicle at jaguar.com

Jaguar Optimised Assistance is a subscription service that can be extended after the initial term advised by your Jaguar Retailer.

Remote contains subscription services that can be extended after the initial term advised by your Jaguar Retailer. InControl features, options and their availability remain market dependent - check with your Jaguar Retailer for local market availability and full terms. Information and images displayed in relation to the InControl technology, including screens or sequences, are subject to software updates, version control and other system/visual changes depending on options selected. Mobile network connectivity cannot be guaranteed in all locations. InControl Apps and Remote App will need to be downloaded from the Apple/Play Store. All in-car features should be used by drivers only when safe for them to do so. Drivers must ensure they are in full control of the vehicle at all times.

OPTION PACKS

		F-TYPE	F-TYPE R-DYNAMIC	F-TYPE R	F-TYPE SVR	
	CODE					DESCRIPTION
Black Exterior Pack	032EI	○	○	○	—	Gloss Black finish to side window surrounds (Coupé only), front bumper splitter, front grille surround, side power vents, bonnet louvres, rear valance and roll over protection bars (Convertible only) ¹
Exterior Design Pack	032GJ	—	○	○	—	Body-coloured front bumper splitter, side sills and rear venturi ¹
Exterior Black Design Pack	032GK	—	○	○	—	Body-coloured front bumper splitter, side sills and rear venturi. Gloss Black finish to side window surrounds (Coupé only), front grille surround, side power vents, bonnet louvres and roll over protection bars (Convertible only) ¹
Exterior Carbon Fibre Pack	032IT	—	○	○	—	Body-coloured front bumper splitter, side sills and rear venturi. Gloss Black finish to side window surrounds (Coupé only) and front grille surround. Carbon Fibre side power vents, bonnet louvres, mirror caps and roll over protection bars (Convertible only) ¹
Exterior Carbon Fibre Pack SVR	032IA	—	—	—	○	Carbon Fibre side power vents, bonnet louvres, mirror caps, front bumper splitter, rear venturi and roll over bars (Convertible only)
Carbon Ceramic Brake Pack	095MA	○	○	○	—	Yellow brake calipers, Tyre Repair System, 20" 5 split-spoke 'Style 5040' alloy wheels with metallic Black finish, 398mm front and 380mm rear carbon ceramic brakes, Bright metal pedals. Requires 380PS automatic or F-TYPE R
SVR Carbon Ceramic Brake Pack	095MC	—	—	—	○	Yellow brake calipers, Tyre Repair System, 20" 10 spoke 'Style 1041' forged alloy wheels with Satin Black Diamond Turned finish, 398mm front and 380mm rear carbon ceramic brakes, Bright metal pedals
Windsor Leather Headlining Pack	021BS	○	○	○	○	Leather sunvisors with vanity mirrors, leather headlining ²
Suedecloth Headlining Pack	021BT	○	○	○	—	Suedecloth sunvisors with vanity mirrors, suedecloth headlining
Climate Pack	017DL	○	○	○	—	Two-zone Climate Control, heated windscreen, heated front seats, heated steering wheel
Windsor Leather Interior Pack	017FD	○	○	—	—	Windsor leather seats, Windsor leather door trim, Windsor leather console, Windsor leather wrapped instrument panel topper
Extended Windsor Leather Interior Pack	017FZ	○	○	○	○	Exclusive to Siena Tan and Pimento. Extended colour Windsor leather interior with contrast edge carpet mat
Suedecloth Interior Pack	SDF	○	○	○	—	Suedecloth door trim, suedecloth and Windsor leather seats with contrast stitching, Performance seats, suedecloth sunvisors with vanity mirrors, suedecloth headlining, Windsor leather console with twin stitching, suedecloth wrapped instrument panel topper with contrast stitching. Includes Premium carpet mats on F-TYPE R
Interior Black Pack	074PX	○	○	○	—	Black vent surrounds, Gloss Black instrument cluster dial rings, Gloss Black door release and flat-bottom leather steering wheel with Black spokes. (R branded on F-TYPE R)

¹Pack content varies between models. ²Vehicle must have Windsor Leather Interior Pack or Full Windsor Leather Interior Pack. Refer to Pages 94-95 for full details on interior colour availability when selecting an Interior Pack.

3 CHOOSE YOUR COLOUR

 [Configure your vehicle at jaguar.com](https://www.jaguar.com)

SOLID

Narvik Black

Fuji White

Caldera Red

METALLIC

Santorini Black

Yulong White

Eiger Grey*

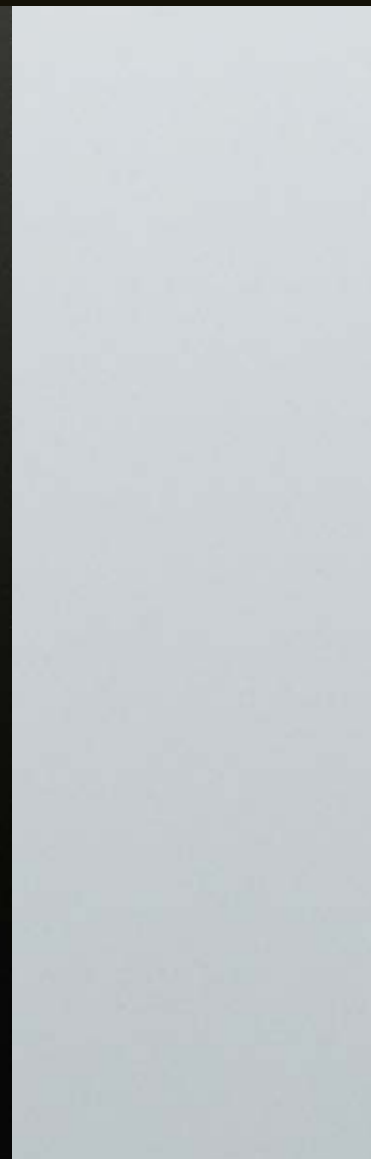
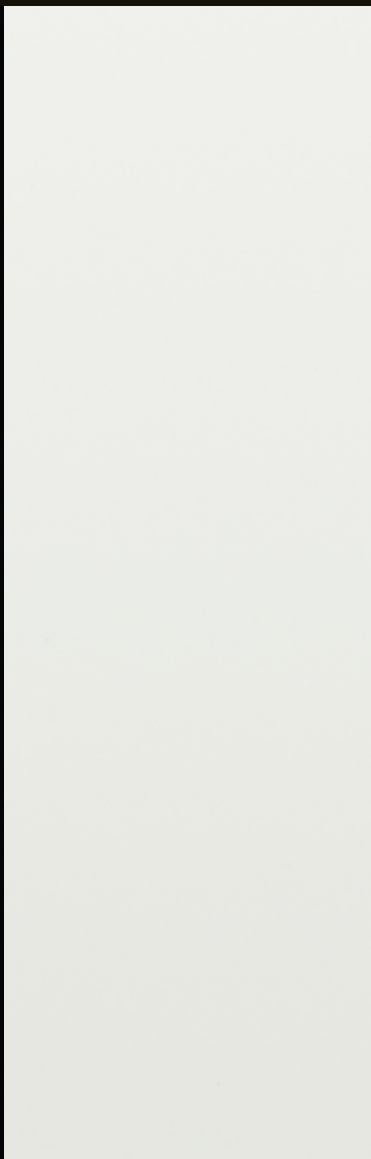

*Not available until March 2019.

PREMIUM

Indus Silver

British Racing Green

Portofino Blue*

Ultra Blue

Carpathian Grey

Silicon Silver

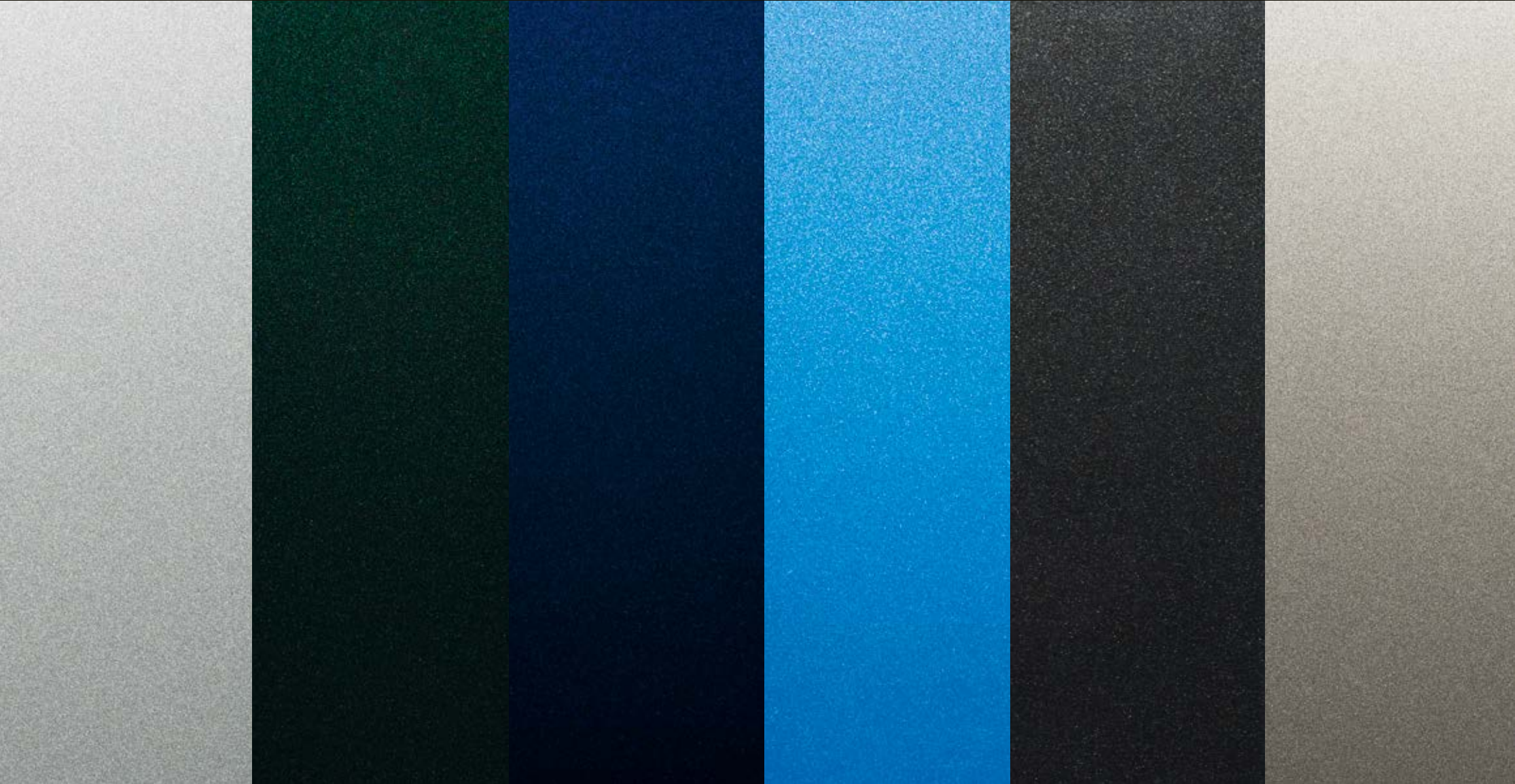

3 CHOOSE YOUR COLOUR

 Configure your vehicle at jaguar.com

SPECIAL EFFECT

Valloire
White Pearl

Meribel
White Pearl

Spectral Racing Red

ULTRA METALLIC

Velocity

Ligurian Black

Mescalito Black

Borealis Black

Bosphorus Grey

Windward Grey

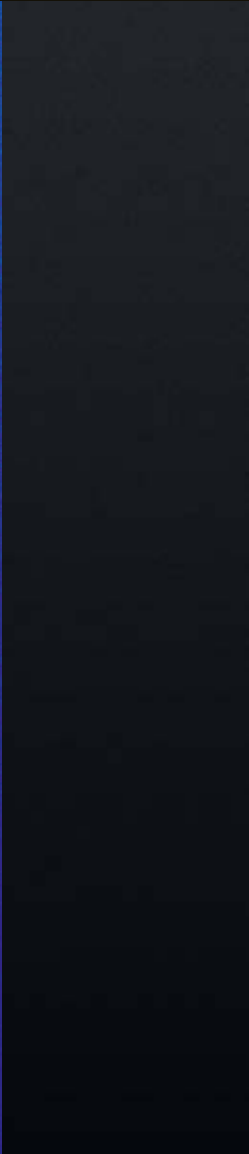



SPECIAL VEHICLE
OPERATIONS

Scafell Grey



British Racing Green

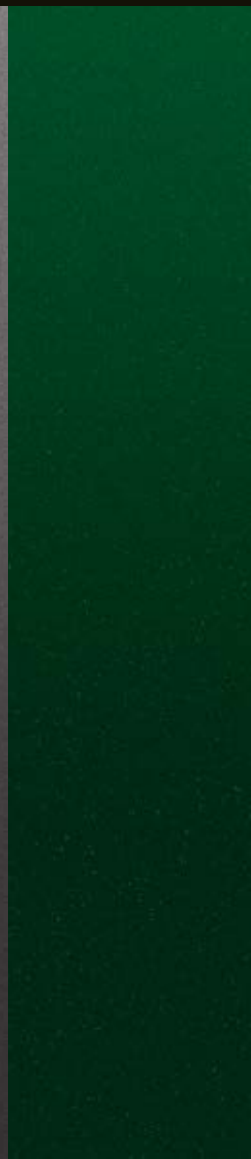

Balmoral Blue



Desire



Madagascar Orange



Flux



Rio Gold



Verbier Silver



Ethereal

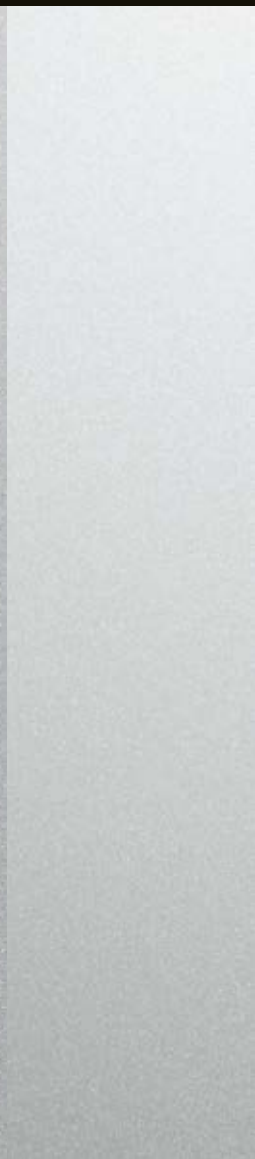

4 CHOOSE YOUR WHEELS & BRAKING SYSTEM

 Configure your vehicle at jaguar.com



18" 10 SPOKE
'STYLE 1036'



18" 10 SPOKE
'STYLE 1024'



19" 10 SPOKE
'STYLE 1023'



19" 7 SPLIT-SPOKE
'STYLE 7013'



19" 5 SPLIT-SPOKE
'STYLE 5058'

ALLOY WHEEL FINISH

FRONT ALLOY WHEELS

FRONT TYRES

REAR ALLOY WHEELS

REAR TYRES

CODE

Silver

Silver

Silver

Silver

Technical Grey and
Diamond Turned

8.5J x 18"

8.5J x 18"

8.5J x 19"

8.5J x 19"

8.5J x 19"

245/45 R18

245/45 R18

245/40 R19

245/40 R19

245/40 R19

9.5J x 18"

9.5J x 18"

9.5J x 19"

9.5J x 19"

9.5J x 19"

275/40 R18

275/40 R18

275/35 R19

275/35 R19

275/35 R19

031FK

029ZG

029ZF

029ZK

029ZA

F-TYPE 300PS

●

—

○

○

○

F-TYPE 340PS

—

●

○

○

○

F-TYPE 380PS

—

—

●

○

○

F-TYPE R-Dynamic 300PS and 340PS

—

—

—

●

○

F-TYPE R-Dynamic 380PS

—

—

—

—

—

F-TYPE R

—

—

—

—

—

F-TYPE SVR

—

—

—

—

—



355MM FRONT AND
325MM REAR BRAKES



380MM FRONT AND
325MM REAR BRAKES



380MM FRONT AND
376MM REAR BRAKES



398MM FRONT AND
380MM REAR CARBON
CERAMIC BRAKES

● Standard ○ Option — Not Applicable ■ Part of Pack

*Automatic transmission only.

Please consult your local Jaguar Retailer for details. For a complete list of optional features and Packs refer to the F-TYPE Specification and Price Guide or configure your vehicle at jaguar.com



20" 6 SPLIT-SPOKE
'STYLE 6003'

20" 5 SPOKE
'STYLE 5060'

20" 5 SPOKE
'STYLE 5042'

20" 5 SPLIT-SPOKE
'STYLE 5039'

20" 5 SPLIT-SPOKE
'STYLE 5061'

20" 5 SPLIT-SPOKE
'STYLE 5040'

FORGED 20"
10 SPOKE
'STYLE 1041'

Dark Grey and
Diamond Turned

Silver

Carbon Fibre, Satin Grey
and Diamond Turned

Gloss Black

Satin Grey

Metallic Black

Satin Black and
Diamond Turned

9.0J x 20"

9.0J x 20"

9.0J x 20"

9.0J x 20"

9.0J x 20"

9.0J x 20"

9.0J x 20"

255/35 R20

255/35 R20

255/35 R20

255/35 R20

265/35 R20

255/35 R20

265/35 R20

10.5J x 20"

10.5J x 20"

10.5J x 20"

10.5J x 20"

11.0J x 20"

10.5J x 20"

11.0J x 20"

295/30 R20

295/30 R20

295/30 R20

295/30 R20

305/30 R20

295/30 R20

305/30 R20

029ZI

031FL

029ZS

029ZL

031JT

031FN

031JR

○

○

○

○

—

—

—

○

○

○

○

—

—

—

○

○

○

○

—

■*

—

○

○

○

○

—

—

—

●

○

○

○

—

■*

—

○

●

○

○

—

■

—

—

—

—

—

●

—

■

BRAKING SYSTEMS	CODE	F-TYPE (300PS & 340PS)	F-TYPE (380PS)	F-TYPE R-DYNAMIC (300PS & 340PS)	F-TYPE R-DYNAMIC (380PS)	F-TYPE R (550PS)	F-TYPE SVR (575PS)	DESCRIPTION
355mm front and 325mm rear brakes	020DV	●	—	●	—	—	—	
380mm front and 325mm rear brakes	020JC	—	●	—	●	—	—	Only available with Red brake calipers or Black brake calipers. Not available with 18" wheels
380mm front and 376mm rear brakes	020JB	○	○	○	○	●	●	Only available with Red brake calipers or Black brake calipers. Not available with 18" wheels
398mm front and 380mm rear carbon ceramic brakes	020JD	—	■*	—	■*	■	■	Part of Carbon Ceramic Brake Pack with 20" alloy wheels and Carbon Ceramic Brake Pack with SVR forged alloy wheels

5 CHOOSE YOUR INTERIOR

 Configure your vehicle at jaguar.com

F-TYPE AND F-TYPE R-DYNAMIC						
	SEAT WITH STITCH	UPPER FACIA WITH STITCH	INTERIOR TRIM AND OPTION CODES	HEADLINING	CARPETS	SEAT BELTS
Standard						
Sport seats with leather and suedecloth facings	Ebony with Ebony	Ebony with Ebony	SDE	Ebony or Grey	Ebony	Ebony or Red
	Cirrus with Cirrus	Ebony with Ebony	SDH	Ebony or Grey	Ebony	Ebony
Optional						
Sport seats in Windsor leather and Windsor leather interior ¹	Ebony with Ebony	Ebony with Ebony	SDE + 017FD	Ebony, Grey or Ivory ³	Ebony	Ebony or Red
	Cirrus with Cirrus	Ebony with Ebony	SDH + 017FD	Ebony or Grey	Ebony	Ebony
Performance seats in Windsor leather and Windsor leather interior ¹	Ebony with Ebony	Ebony with Ebony	SDE + 033MT + 017FD	Ebony, Grey or Ivory ³	Ebony	Ebony or Red
	Ebony with Pimento	Ebony with Ebony	SDX + 033MT + 017FD	Ebony, Grey or Pimento ⁴	Ebony	Ebony or Red
	Ebony with Siena Tan	Ebony with Ebony	SDY + 033MT + 017FD	Ebony or Grey	Ebony	Ebony
	Ebony with Ivory	Ebony with Ebony	SDG + 033MT + 017FD	Ebony, Grey or Ivory ³	Ebony	Ebony
	Siena Tan with Cirrus	Ebony with Ebony	TJR + 033MT + 017FD	Ebony or Grey	Ebony	Ebony
	Brogue with Ivory	Ebony with Ebony	SDK + 033MT + 017FD	Ebony, Grey or Ivory ³	Ebony	Ebony
	Pimento with Ebony	Ebony with Ebony	SDL + 033MT + 017FD	Ebony, Grey or Pimento ⁴	Ebony	Ebony or Red
Ivory with Ebony	Ebony with Ebony	SDM + 033MT + 017FD	Ebony, Grey or Ivory ³	Ebony	Ebony	
Performance seats in Windsor leather and suedecloth and Windsor leather interior ¹	Ebony with Cirrus	Ebony with Cirrus	SDF	Ebony suedecloth	Ebony	Ebony
Performance seats in Windsor leather and extended coloured Windsor leather interior and contrast edged carpet mat ²	Pimento with Ebony	Pimento with Ebony	TSW + 033MT + 017FZ	Ebony or Pimento ⁴	Ebony	Ebony or Red
	Siena Tan with Cirrus ⁵	Siena Tan with Cirrus	SBH + 033MT + 017FZ	Ebony	Ebony	Ebony

¹Windsor leather interior adds Windsor leather to the upper facia, centre console and door casings.

²Includes coloured Windsor leather passenger side upper facia, upper door casings, centre console and Ebony carpet mats with coloured Nubuck edging and Ebony contrast stitching.

³Ivory leather headlining not available with panoramic glass roof.

⁴Pimento leather headlining available on Convertible only.

⁵Only available with automatic transmission.

Please consult your local Jaguar Retailer for details.

F-TYPE R						
	SEAT WITH STITCH	UPPER FACIA WITH STITCH	INTERIOR TRIM AND OPTION CODES	HEADLINING	CARPETS	SEAT BELTS
Standard						
Performance seats in Windsor leather with R embossed headrests and Windsor leather interior	Ebony with Ebony	Ebony with Ebony	SDE	Ebony, Grey or Ivory ³	Ebony	Ebony or Red
	Ebony with Ivory	Ebony with Ivory	SDR	Ebony, Grey or Ivory ³	Ebony	Ebony
	Ebony with Pimento	Ebony with Pimento	SDQ	Ebony, Grey or Pimento ⁴	Ebony	Ebony or Red
	Ebony with Siena Tan	Ebony with Siena Tan	SDS	Ebony or Grey	Ebony	Ebony
	Siena Tan and Ebony duo tone with Siena Tan	Ebony with Siena Tan	SDV	Ebony or Grey	Ebony	Ebony
	Ivory and Ebony duo tone with Ivory	Ebony with Ivory	SDU	Ebony, Grey or Ivory ³	Ebony	Ebony
	Pimento and Ebony duo tone with Pimento	Ebony with Pimento	SDT	Ebony, Grey or Pimento ⁴	Ebony	Ebony or Red
Optional						
Performance seats in Windsor leather and suedecloth and Windsor leather interior	Ebony with Cirrus	Ebony with Cirrus	SDF	Ebony Suedecloth	Ebony	Ebony
	Pimento with Ebony	Pimento with Ebony	TSW + 017FZ	Ebony or Pimento ⁴	Ebony	Ebony or Red
	Siena Tan with Cirrus	Siena Tan with Cirrus	SBH + 017FZ	Ebony	Ebony	Ebony
F-TYPE SVR						
	SEAT WITH STITCH	UPPER FACIA WITH STITCH	INTERIOR TRIM AND OPTION CODES	HEADLINING	CARPETS	SEAT BELTS
Standard						
Quilted Performance seats in Windsor leather with SVR embossed headrests and suedecloth driver's instrument panel area	Ebony with Cirrus	Ebony with Cirrus	SDP	Ebony	Ebony	Ebony
	Ebony with Pimento	Ebony with Pimento	SDQ	Ebony or Pimento ⁴	Ebony	Ebony or Red
	Ebony with Reims Blue	Ebony with Reims Blue	SDW	Ebony	Ebony	Ebony
Optional						
Performance seats in Quilted Windsor leather with SVR embossed headrests and extended coloured Windsor leather interior ²	Pimento with Ebony	Pimento with Ebony	TSW + 017FZ	Ebony or Pimento ⁴	Ebony	Red
	Siena Tan with Cirrus	Siena Tan with Cirrus	SBH + 017FZ	Ebony	Ebony	Ebony

5 CHOOSE YOUR INTERIOR

⚙️ Configure your vehicle at jaguar.com

Interior shown: F-TYPE R-Dynamic with optional Ebony Windsor leather Performance seats, Delta Aluminium finisher, Ebony Morzine headlining, Ebony upper facia and Ebony carpets.



F-TYPE AND F-TYPE R-DYNAMIC

INTERIOR COLOUR COMBINATIONS

STANDARD SPORT SEATS WITH LEATHER AND SUEDECLOTH FACINGS
 OPTIONAL SPORT SEATS IN WINDSOR LEATHER AND WINDSOR LEATHER INTERIOR

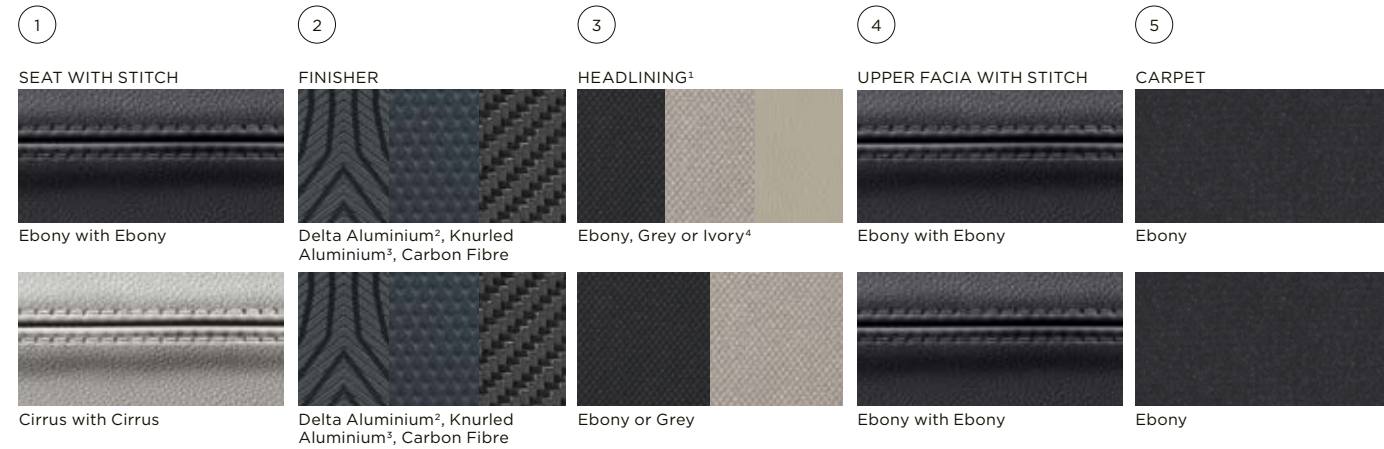

OPTIONAL PERFORMANCE SEATS IN WINDSOR LEATHER
 AND WINDSOR LEATHER INTERIOR



¹Ebony Morzine standard, Grey Morzine and Ebony suedecloth optional. Ebony, Pimento and Ivory leather optional.

²Delta Aluminium is standard on F-TYPE R-Dynamic and optional on F-TYPE.

³Knurled Aluminium is standard on F-TYPE and optional on F-TYPE R-Dynamic.













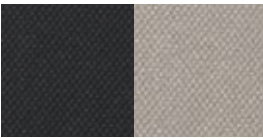



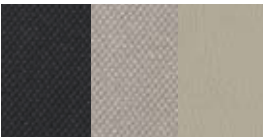

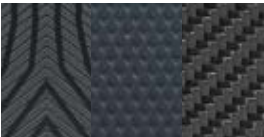
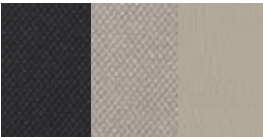

⁴Ivory leather headlining not available with panoramic glass roof.

⁵Pimento headlining available on Convertible only.

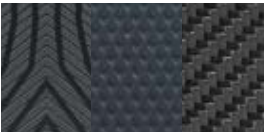
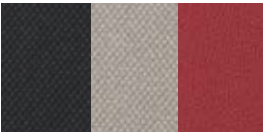
F-TYPE AND F-TYPE R-DYNAMIC

INTERIOR COLOUR COMBINATIONS

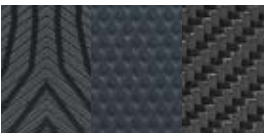
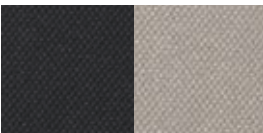
OPTIONAL PERFORMANCE SEATS IN WINDSOR LEATHER AND WINDSOR LEATHER INTERIOR [CONTINUED]

1	2	3	4	5
SEAT WITH STITCH	FINISHER	HEADLINING ¹	UPPER FACIA WITH STITCH	CARPET
				
Ebony with Siena Tan	Delta Aluminium ² , Knurled Aluminium ³ , Carbon Fibre	Ebony or Grey	Ebony with Ebony	Ebony
				
Ebony with Ivory	Delta Aluminium ² , Knurled Aluminium ³ , Carbon Fibre	Ebony, Grey or Ivory ⁴	Ebony with Ebony	Ebony
				
Brogue with Ivory	Delta Aluminium ² , Knurled Aluminium ³ , Carbon Fibre	Ebony, Grey or Ivory ⁴	Ebony with Ebony	Ebony
				
Pimento with Ebony	Delta Aluminium ² , Knurled Aluminium ³ , Carbon Fibre	Ebony, Grey or Pimento ⁵	Ebony with Ebony	Ebony
				
Siena Tan with Cirrus	Delta Aluminium ² , Knurled Aluminium ³ , Carbon Fibre	Ebony or Grey	Ebony with Ebony	Ebony

¹Ebony Morzine standard, Grey Morzine and Ebony suedecloth optional. Ebony, Pimento and Ivory leather optional.

²Delta Aluminium is standard on F-TYPE R-Dynamic and optional on F-TYPE.





³Knurled Aluminium is standard on F-TYPE and optional on F-TYPE R-Dynamic.

⁴Ivory leather headlining not available with panoramic glass roof.

⁵Pimento headlining available on Convertible only.

⁶Only available with automatic transmission.

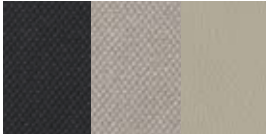



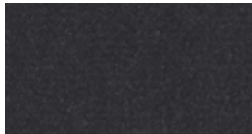

OPTIONAL PERFORMANCE SEATS IN WINDSOR LEATHER
AND WINDSOR LEATHER INTERIOR [CONTINUED]

①	②	③	④	⑤
SEAT WITH STITCH	FINISHER	HEADLINING ¹	UPPER FACIA WITH STITCH	CARPET
				
Ivory with Ebony	Delta Aluminium ² , Knurled Aluminium ³ , Carbon Fibre	Ebony, Grey or Ivory ⁴	Ebony with Ebony	Ebony

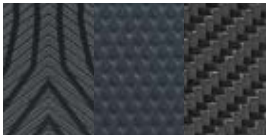
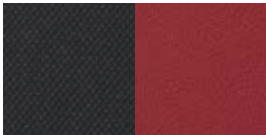
OPTIONAL PERFORMANCE SEATS IN WINDSOR LEATHER
AND SUEDECLOTH AND WINDSOR LEATHER INTERIOR

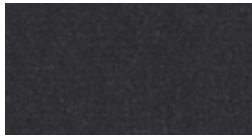
SEAT WITH STITCH	FINISHER	HEADLINING	UPPER FACIA WITH STITCH	CARPET
				
Ebony with Cirrus	Delta Aluminium ² , Knurled Aluminium ³ , Carbon Fibre	Ebony suedecloth	Ebony with Cirrus	Ebony

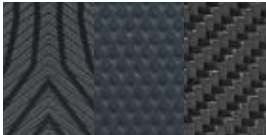
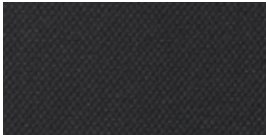
OPTIONAL PERFORMANCE SEATS IN WINDSOR LEATHER
AND EXTENDED WINDSOR LEATHER INTERIOR

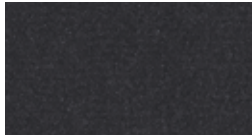
SEAT WITH STITCH	FINISHER	HEADLINING ¹	UPPER FACIA WITH STITCH	CARPET
				
Pimento with Ebony	Delta Aluminium ² , Knurled Aluminium ³ , Carbon Fibre	Ebony or Pimento ⁵	Pimento with Ebony	Ebony
				
Siena Tan with Cirrus ⁶	Delta Aluminium ² , Knurled Aluminium ³ , Carbon Fibre	Ebony	Siena Tan with Cirrus	Ebony

5 CHOOSE YOUR INTERIOR

⚙️ Configure your vehicle at jaguar.com













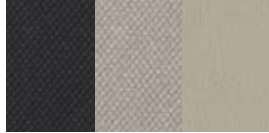

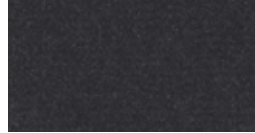

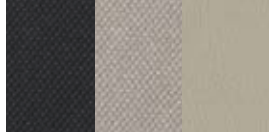
Interior shown: Optional Pimento Windsor leather Performance seats with Linear Vee Aluminium finisher, Ebony leather headlining, Pimento upper facia and Ebony carpets.

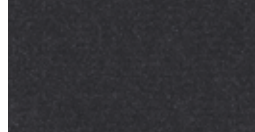

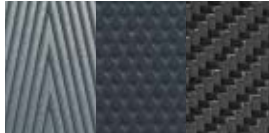
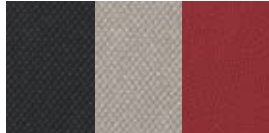
F-TYPE R

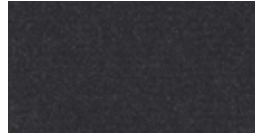
INTERIOR COLOUR COMBINATIONS

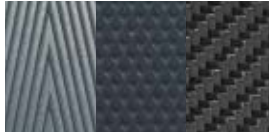
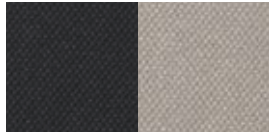
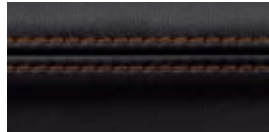
STANDARD R-PERFORMANCE SEATS IN WINDSOR LEATHER AND WINDSOR LEATHER INTERIOR

1	2	3	4	5
SEAT WITH STITCH	FINISHER	HEADLINING ¹	UPPER FACIA WITH STITCH	CARPET
				
Ebony with Ebony	Linear Vee Aluminium ² , Knurled Aluminium, Carbon Fibre	Ebony, Grey or Ivory ³	Ebony with Ebony	Ebony
				
Ebony with Ivory	Linear Vee Aluminium ² , Knurled Aluminium, Carbon Fibre	Ebony, Grey or Ivory ³	Ebony with Ivory	Ebony
				
Ebony with Pimento	Linear Vee Aluminium ² , Knurled Aluminium, Carbon Fibre	Ebony, Grey or Pimento ⁴	Ebony with Pimento	Ebony
				
Ebony with Siena Tan	Linear Vee Aluminium ² , Knurled Aluminium, Carbon Fibre	Ebony or Grey	Ebony with Siena Tan	Ebony

¹Ebony Morzine standard, Grey Morzine and Ebony suedecloth optional. Ebony, Pimento and Ivory leather optional.

²Linear Vee Aluminium is standard.







³Ivory leather headlining not available with panoramic glass roof.

⁴Pimento headlining available on Convertible only.

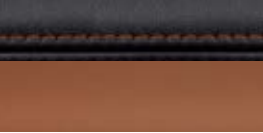
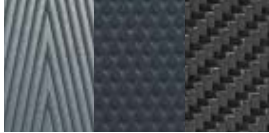
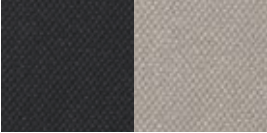
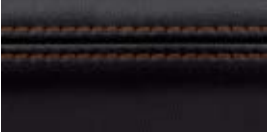
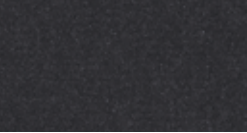
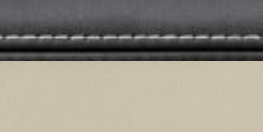
F-TYPE R

INTERIOR COLOUR COMBINATIONS

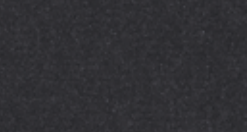
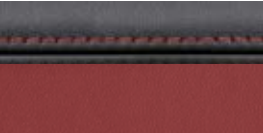
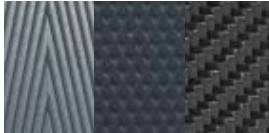
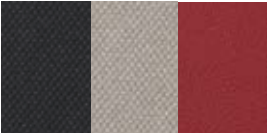
STANDARD R-PERFORMANCE SEATS IN WINDSOR LEATHER AND WINDSOR LEATHER INTERIOR [CONTINUED]

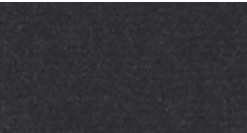
1	2	3	4	5
DUO TONE SEAT WITH STITCH	FINISHER	HEADLINING ¹	UPPER FACIA WITH STITCH	CARPET
				
Ebony with Siena Tan	Linear Vee Aluminium ² , Knurled Aluminium, Carbon Fibre	Ebony or Grey	Ebony with Siena Tan	Ebony
				
Ebony with Ivory	Linear Vee Aluminium ² , Knurled Aluminium, Carbon Fibre	Ebony, Grey or Ivory ³	Ebony with Ivory	Ebony
				
Ebony with Pimento	Linear Vee Aluminium ² , Knurled Aluminium, Carbon Fibre	Ebony, Grey or Pimento ⁴	Ebony with Pimento	Ebony

¹Ebony Morzine standard, Grey Morzine and Ebony suedecloth optional. Ebony, Pimento and Ivory leather optional.

²Linear Vee Aluminium is standard.







³Ivory leather headlining not available with panoramic glass roof.

⁴Pimento headlining available on Convertible only.

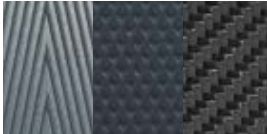
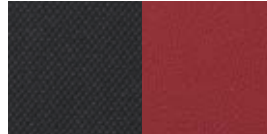
OPTIONAL R-PERFORMANCE SEATS IN WINDSOR LEATHER
AND SUEDECLOTH AND WINDSOR LEATHER INTERIOR

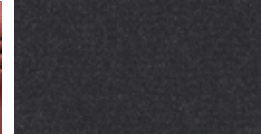
①	②	③	④	⑤
SEAT WITH STITCH	FINISHER	HEADLINING	UPPER FACIA WITH STITCH	CARPET
				
Ebony with Cirrus	Linear Vee Aluminium ² , Knurled Aluminium, Carbon Fibre	Ebony suedecloth	Ebony with Cirrus	Ebony

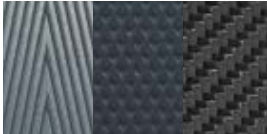
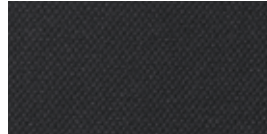
OPTIONAL R-PERFORMANCE SEATS IN WINDSOR LEATHER
AND EXTENDED WINDSOR LEATHER INTERIOR

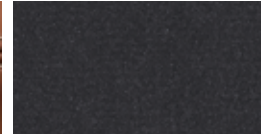
SEAT WITH STITCH	FINISHER	HEADLINING ¹	UPPER FACIA WITH STITCH	CARPET
				
Pimento with Ebony	Linear Vee Aluminium ² , Knurled Aluminium, Carbon Fibre	Ebony or Pimento ⁴	Pimento with Ebony	Ebony
				
Siena Tan with Cirrus	Linear Vee Aluminium ² , Knurled Aluminium ³ , Carbon Fibre	Ebony	Siena Tan with Cirrus	Ebony

5 CHOOSE YOUR INTERIOR

 Configure your vehicle at [jaguar.com](https://www.jaguar.com)











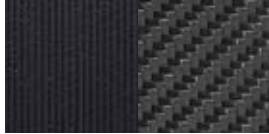

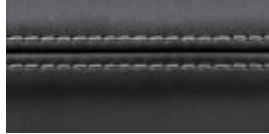
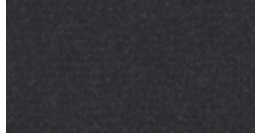
Interior shown: Ebony Windsor leather Performance seats with Cirrus stitch and micropiping, Dark Brushed Aluminium finisher, Ebony headlining, Ebony upper fascia and Ebony carpets.

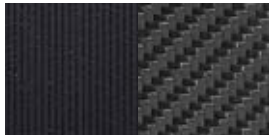



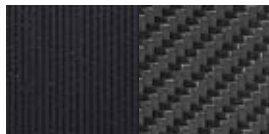



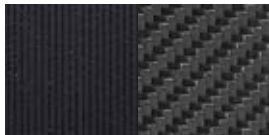

F-TYPE SVR

INTERIOR COLOUR COMBINATIONS

STANDARD SVR QUILTED WINDSOR LEATHER PERFORMANCE SEATS WITH WINDSOR LEATHER AND SUEDECLOTH INTERIOR

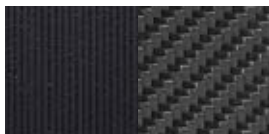
1	2	3	4	5
SEAT WITH STITCH	FINISHER	HEADLINING ¹	UPPER FACIA WITH STITCH	CARPET
				
Ebony with Cirrus	Dark Brushed Aluminium ² or Carbon Fibre	Ebony	Ebony with Cirrus	Ebony
				
Ebony with Pimento	Dark Brushed Aluminium ² or Carbon Fibre	Ebony or Pimento ³	Ebony with Pimento	Ebony
				
Ebony with Reims Blue	Dark Brushed Aluminium ² or Carbon Fibre	Ebony	Ebony with Reims Blue	Ebony

OPTIONAL SVR QUILTED WINDSOR LEATHER PERFORMANCE SEATS WITH WINDSOR LEATHER INTERIOR

SEAT WITH STITCH	FINISHER	HEADLINING ¹	UPPER FACIA WITH STITCH	CARPET
				
Pimento with Ebony	Dark Brushed Aluminium ² or Carbon Fibre	Ebony or Pimento ³	Pimento with Ebony	Ebony
				
Siena Tan with Cirrus	Dark Brushed Aluminium ² or Carbon Fibre	Ebony	Siena Tan with Cirrus	Ebony

¹Ebony suedecloth standard. Ebony and Pimento leather optional.

²Dark Brushed Aluminium is standard.

³Pimento leather headlining only available on Convertible.

5 CHOOSE YOUR INTERIOR

 Configure your vehicle at [jaguar.com](https://www.jaguar.com)

Knurled Aluminium Centre Console

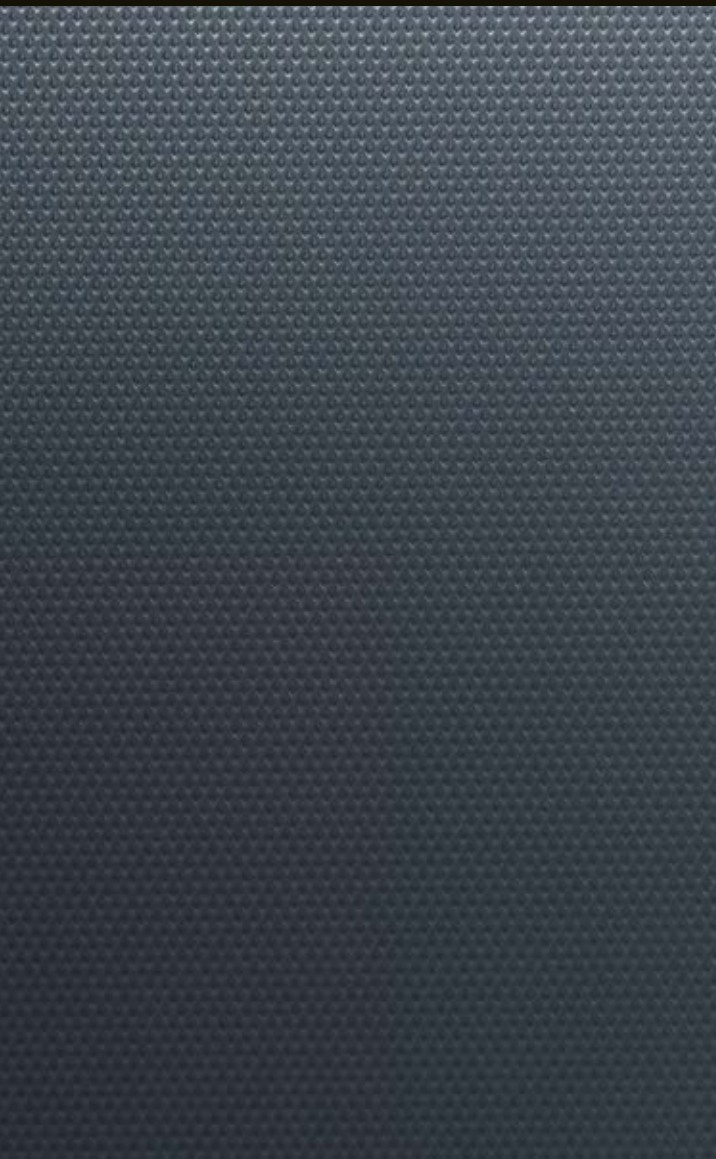

Delta Aluminium Centre Console

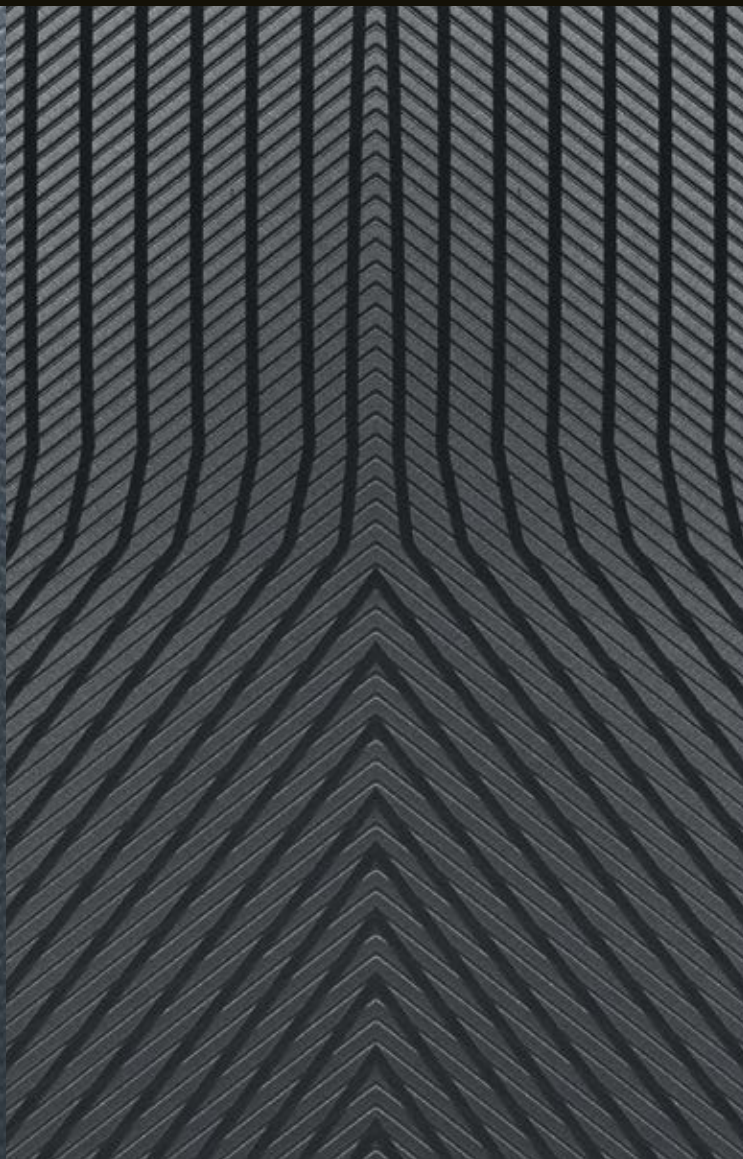

Linear Vee Aluminium Centre Console with R Branding



Carbon Fibre Centre Console

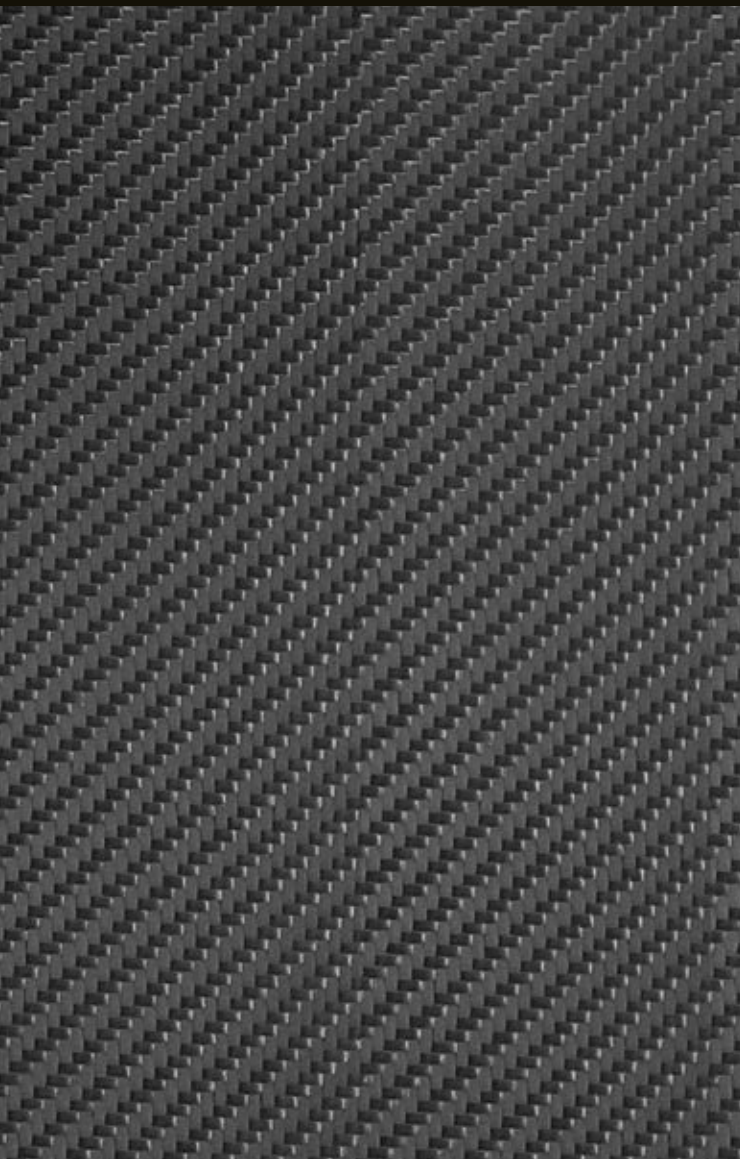

Dark Brushed Aluminium Centre Console with SVR Branding



Carbon Fibre Centre Console with SVR Branding



6 CHOOSE YOUR JAGUAR GEAR - ACCESSORIES

To find out more about the full range of retailer fit Jaguar Gear Accessories, please refer to your retailer or go to gear.jaguar.com



**VEHICLE SHOWN: F-TYPE R IN YULONG WHITE
WITH SILVER WEAVE CARBON FIBRE PACK**

¹Manual transmission only.
²Automatic transmission only.
³Coupé only.



Carbon Fibre Gear Selector¹
T2R24247

Enjoy the unique feel of this performance-inspired Carbon Fibre topped gear selector with a High Gloss lacquered finish.



Personalised Illuminated Sill Treadplates
T2R6091

Elegantly styled stainless steel sill treadplate finisher for driver or passenger doors. Illuminate when either the driver or passenger doors are opened. Highlighted by soft Phosphor Blue lighting. Allows you to specify a monochrome 'motif' in a choice of approved typefaces/scripts.



Aluminium Gearshift Paddles²
T2R6547MMU

Replacement steering wheel gearshift paddles offered in a premium aluminium material providing a high quality finish to a key contact point in the vehicle. Manufactured from billet machined aluminium, the paddles are hand brushed for a premium finish and anodised to ensure they will not deteriorate with wear.



Flexible Luggage Retainer
C2D49365

Provides a neat stowage solution to help secure luggage or other items within the luggage compartment.



Luxury Carpet Mats
T2R16570PVJ - Left Hand Drive

Luxurious, tailored 2,050g/m² pile front carpet mats with embossed Jaguar logo and Nubuck edge binding. The luxury mats provide a well appointed finishing touch to the interior.



Side Net³
T2R22934

Side net provides additional enclosed storage in the luggage compartment and helps to secure loose items such as bags or small parcels.

6 CHOOSE YOUR JAGUAR GEAR - ACCESSORIES

 Configure your vehicle at jaguar.com



Silver Weave Carbon Fibre Side Power Vents¹
T2R25198 - Left Side T2R25197 - Right Side

High-grade Silver Weave Carbon Fibre side power vents provide a performance-inspired styling enhancement. Featuring a 2x2 twill weave with an eye-catching aluminium thread and a High Gloss lacquered finish.



Silver Weave Carbon Fibre Bonnet Louvres
T2R25193 - Left Side RWD T2R25191 - Right Side RWD
T2R25194 - Left Side AWD T2R25192 - Right Side AWD

High-grade Silver Weave Carbon Fibre bonnet louvres featuring a 2x2 twill weave with aluminium thread and a High Gloss lacquered finish. Provides an eye-catching, performance-inspired styling enhancement coupled with the weight-saving benefits associated with carbon fibre.



Silver Weave Carbon Fibre Mirror Covers
T2R25196 - Left Side T2R25195 - Right Side

High-grade Silver Weave Carbon Fibre mirror covers provide a performance-inspired styling enhancement. Featuring a 2x2 twill weave with an eye-catching aluminium thread and a High Gloss lacquered finish.



Silver Weave Carbon Fibre Roll Hoops²
T2R23379 - Left Side T2R23378 - Right Side

High-grade Silver Weave Carbon Fibre roll hoops featuring a 2x2 twill weave with aluminium thread and a High Gloss lacquered finish. Provides an eye-catching, performance-inspired styling enhancement coupled with the weight-saving benefits associated with carbon fibre.



Wind Deflector³
T2R11321

Simple to fit and remove, the wind deflector reduces air draught and turbulence in the passenger compartment, even at high speeds. Supplied with a Jaguar branded stowage bag.



Gloss Black Side Power Vents¹
T2R15226 - Left Side T2R15225 - Right Side

Jaguar branded Gloss Black side power vents provide a dynamic exterior styling enhancement.



Chrome Bonnet Louvres⁴
T2R5277LML - Left Side T2R5276LML - Right Side

Bright finish accents highlight the F-TYPE exterior styling cues.



Chrome Mirror Covers
T2R5399 - Left Side T2R5400 - Right Side

Chrome mirror covers accentuate the stylish design of the exterior mirrors.



Chrome Roll Hoops²
T2R5402 - Left Side T2R5401 - Right Side

Bright finish accents highlight the F-TYPE exterior styling cues.



All-Weather Car Cover
T2R4364

All-weather tailored cover for the F-TYPE with the Jaguar logo. Protect your F-TYPE from the elements, including showers, frost and dust. Quick and easy to fit.



Rear Diffuser - Carbon Fibre
T2R5391

Statement exterior styling accessory to replace the standard rear valance with a performance diffuser featuring aero blades for optimised air flow. High grade Carbon Fibre featuring a 2x2 twill weave and a High Gloss lacquered finish. Provides weight benefits associated with carbon fibre. Applicable to V6 and i4 models only.



Gloss Black Grille
T2R13838 - Without Parking Aids
T2R13839 - With Parking Aids

Provides a High Gloss Black finish to the grille surround and bumper beam accentuating the F-TYPE's dynamic appearance.

¹N/A with F-TYPE SVR. ²Available for F-TYPE Convertible only.
³Standard on F-TYPE R and F-TYPE SVR. Also available as a line fit option.
⁴Not applicable for AWD models.

TECHNICAL SPECIFICATIONS

 Configure your vehicle at jaguar.com

ENGINES		JAGUAR 2.0 LITRE i4 300 TURBOCHARGED PETROL		JAGUAR 3.0 LITRE V6 340 SUPERCHARGED PETROL	
Cylinders/Valves per Cylinder		4/4		6/4	
Bore/Stroke	mm	83/92.3		84.5/89	
Capacity	cc	1,997		2,995	
Maximum power	EEC-PS (kW)	300 (221)		340 (250)	
@rev/min		5,500		6,500	
Maximum torque	EEC-Nm (lb.ft.)	400 (295)		450 (332)	
@rev/min		1,500 - 4,500		3,500 - 5,000	
Compression	ratio:1	9.5		10.5	

PERFORMANCE		COUPÉ Auto	CONVERTIBLE Auto	Manual	COUPÉ Auto	Manual	CONVERTIBLE Auto
0-100 km/h (0-60 mph)	seconds	5.7 (5.4)	5.7 (5.4)	5.7 (5.5)	5.3 (5.1)	5.7 (5.5)	5.3 (5.1)
80-120 km/h (50-75 mph) - manual in 5 th gear	seconds	3.7 (3.7)	3.7 (3.7)	7.2 (7.2)	3.3 (3.3)	7.2 (7.2)	3.3 (3.3)
Top speed	km/h (mph)	250 (155)	250 (155)	260 (161)	260 (161)	260 (161)	260 (161)

FUEL ECONOMY - NEDC EQUIVALENT [NEDC2] ¹			Class E	Class E	Class E	Class E	Class E	Class E
NEDC2 Consumption	Urban	l/100km (mpg)	10.0 (28.2)	10.0 (28.2)	14.0 (20.2)	13.4 (21.1)	14.0 (20.2)	13.4 (21.1)
	Extra Urban	l/100km (mpg)	6.6 (42.8)	6.6 (42.8)	8.1 (34.9)	7.8 (36.2)	8.1 (34.9)	7.8 (36.2)
	Combined	l/100km (mpg)	7.9 (35.8)	7.9 (35.8)	10.3 (27.4)	9.8 (28.8)	10.3 (27.4)	9.8 (28.8)
NEDC2 CO ₂ Emissions	Urban	g/km	229	229	319	305	319	305
	Extra Urban	g/km	151	151	185	178	185	178
	Combined	g/km	179	179	234	224	234	224

FUEL ECONOMY - WLTP ²			TEL - TEH ³	TEL - TEH ³	TEH ³	TEL - TEH ³	TEH ³	TEL - TEH ³
WLTP Consumption	Low	l/100km (mpg)	13.1-12.9 (21.5-22.0)	13.2-13.0 (21.4-21.8)	16.8 (16.8)	14.6-14.9 (19.3-19.0)	16.8 (16.8)	14.7-14.9 (19.2-18.9)
	Medium	l/100km (mpg)	9.0-9.3 (31.6-30.2)	8.9-9.2 (31.7-30.6)	11.8 (23.9)	10.1-10.4 (28.0-27.3)	11.8 (23.9)	10.2-10.4 (27.7-27.2)
	High	l/100km (mpg)	7.8-8.1 (36.3-35.0)	7.8-8.0 (36.1-35.2)	9.9 (28.6)	8.6-8.9 (32.8-31.9)	9.9 (28.6)	8.7-8.9 (32.3-31.7)
	Extra High	l/100km (mpg)	8.7-9.1 (32.6-31.2)	8.8-9.1 (32.0-31.1)	10.0 (28.3)	9.3-9.7 (30.2-29.3)	10.0 (28.3)	9.6-9.8 (29.5-28.9)
	Combined	l/100km (mpg)	9.1-9.3 (31.2-30.3)	9.1-9.3 (31.1-30.4)	11.2 (25.1)	10.0-10.2 (28.3-27.6)	11.2 (25.1)	10.1-10.3 (27.9-27.4)
WLTP CO ₂ Emissions	Low	g/km	297-291	298-293	380	331-337	380	332-337
	Medium	g/km	202-211	201-208	267	228-234	267	230-235
	High	g/km	176-182	177-181	225	194-200	225	197-202
	Extra High	g/km	196-205	199-205	226	211-218	226	216-221
	Combined	g/km	205-211	206-210	254	225-232	254	229-233

WEIGHT ⁴							
Weight from	kg	1,525	1,545	1,567	1,577	1,587	1,597
Gross vehicle weight	kg	1,925	1,925	2,000	2,000	2,000	2,000

ENGINE AVAILABILITY							
F-TYPE	●	●	●	●	●	●	●
F-TYPE R-DYNAMIC	●	●	●	●	●	●	●
F-TYPE CHEQUERED FLAG EDITION	●	●	—	●	—	—	●
F-TYPE R	—	—	—	—	—	—	—
F-TYPE SVR	—	—	—	—	—	—	—

● Standard — Not Available

¹The figures provided are NEDC2 calculated from official manufacturer's WLTP tests in accordance with EU legislation. For comparison purposes only. Real world figures may differ. CO₂ and fuel economy figures may vary according to wheel fitment and optional extras fitted. NEDC2 are figures calculated using a Government formula from WLTP figures equivalent to what they would have been under the old NEDC test. The correct tax treatment can then be applied.

²WLTP is the new official EU test used to calculate standardised fuel consumption and CO₂ figures for passenger cars. It measures fuel, energy consumption, range and emissions. This is designed to provide figures closer to real-world driving behaviour. It tests vehicles with optional equipment and with a more demanding test procedure and driving profile.

JAGUAR 3.0 LITRE V6 380 SUPERCHARGED PETROL				JAGUAR 3.0 LITRE V6 380 SUPERCHARGED PETROL AWD		JAGUAR 5.0 LITRE V8 550 SUPERCHARGED PETROL AWD		JAGUAR 5.0 LITRE V8 575 SUPERCHARGED PETROL AWD			
6/4				6/4		8/4		8/4			
84.5/89				84.5/89		92.5/93		92.5/93			
2,995				2,995		5,000		5,000			
380 (280)				380 (280)		550 (405)		575 (423)			
6,500				6,500		6,500		6,500			
460 (339)				460 (339)		680 (502)		700 (516)			
3,500 - 5,500				3,500 - 5,500		3,500		3,500			
10.5				10.5		9.5		9.5			
Manual	COUPÉ	Auto	Manual	CONVERTIBLE	Auto	COUPÉ	CONVERTIBLE	COUPÉ	CONVERTIBLE	COUPÉ	CONVERTIBLE
Auto	Auto	Auto	Auto	Auto	Auto	Auto	Auto	Auto	Auto	Auto	Auto
5.5 (5.3)	4.9 (4.8)	5.5 (5.3)	4.9 (4.8)	5.1 (4.9)	5.1 (4.9)	4.1 (3.9)	4.1 (3.9)	3.7 (3.5)	3.7 (3.5)	3.7 (3.5)	3.7 (3.5)
7.2 (7.2)	3.1 (3.1)	7.2 (7.2)	3.1 (3.1)	3.3 (3.3)	3.3 (3.3)	2.5 (2.5)	2.5 (2.5)	2.3 (2.3)	2.3 (2.3)	2.3 (2.3)	2.3 (2.3)
275 (171)	275 (171)	275 (171)	275 (171)	275 (171)	275 (171)	300 (186)	300 (186)	322 (200)	314 (195)	314 (195)	314 (195)
Class E	Class E	Class E	Class E	Class E	Class E	Class E	Class E	Class E	Class E	Class E	Class E
14.5 (19.5)	13.7 (20.6)	14.5 (19.5)	13.7 (20.6)	14.5 (19.5)	14.5 (19.5)	15.4 (18.3)	15.4 (18.3)	15.4 (18.3)	15.4 (18.3)	15.4 (18.3)	15.4 (18.3)
8.4 (33.6)	7.6 (37.2)	8.4 (33.6)	7.6 (37.2)	7.8 (36.2)	7.8 (36.2)	8.4 (33.6)	8.4 (33.6)	8.4 (33.6)	8.4 (33.6)	8.4 (33.6)	8.4 (33.6)
10.6 (26.6)	9.8 (28.8)	10.6 (26.6)	9.8 (28.8)	10.2 (27.7)	10.2 (27.7)	10.9 (25.9)	10.9 (25.9)	10.9 (25.9)	10.9 (25.9)	10.9 (25.9)	10.9 (25.9)
329	312	329	312	331	331	350	350	350	350	350	350
191	172	191	172	177	177	191	191	191	191	191	191
242	223	242	223	233	233	249	249	249	249	249	249
TEH ³	TEL - TEH ³	TEH ³	TEL - TEH ³	TEL - TEH ³	TEL - TEH ³	TEL - TEH ³	TEL - TEH ³	TEL - TEH ³	TEL - TEH ³	TEH ³	TEH ³
17.6 (16.1)	15.8-15.8 (17.8-17.9)	17.6 (16.1)	15.8-15.7 (17.9-17.9)	17.3-18.7 (16.3-15.1)	17.8-18.8 (15.9-15.0)	17.7-18.0 (16.0-15.7)	17.8-18.0 (15.8-15.7)	18.1 (15.6)	18.1 (15.6)	18.1 (15.6)	18.1 (15.6)
12.2 (23.1)	10.9-11.1 (25.9-25.4)	12.2 (23.1)	11.0-11.2 (25.7-25.3)	11.1-11.4 (25.3-24.9)	11.2-11.4 (25.2-24.9)	11.2-11.2 (25.1-25.2)	11.2-11.2 (25.1-25.2)	11.2 (25.2)	11.2 (25.2)	11.2 (25.2)	11.2 (25.2)
9.9 (28.5)	9.2-9.4 (30.7-30.2)	9.9 (28.5)	9.3-9.4 (30.3-30.0)	9.5-9.5 (29.8-29.7)	9.5-9.5 (29.8-29.7)	9.1-9.3 (30.9-30.3)	9.2-9.3 (30.8-30.4)	9.4 (30.2)	9.4 (30.2)	9.4 (30.2)	9.4 (30.2)
10.2 (27.6)	9.8-10.1 (28.9-27.9)	10.2 (27.6)	10.0-10.3 (28.1-27.5)	10.1-10.1 (28.1-28.1)	10.1-10.1 (28.1-28.1)	9.6-9.8 (29.5-28.8)	9.6-9.7 (29.5-29.1)	9.8 (28.8)	9.8 (28.8)	9.8 (28.8)	9.8 (28.8)
11.5 (24.6)	10.6-10.8 (26.6-26.0)	11.5 (24.6)	10.8-10.9 (26.2-25.9)	11.1-11.3 (25.3-25.0)	11.1-11.3 (25.4-25.0)	10.9-11.0 (25.9-25.7)	10.9-11.0 (26.0-25.7)	11.1 (25.5)	11.1 (25.5)	11.1 (25.5)	11.1 (25.5)
413	358-356	413	357-356	391-423	403-426	401-409	405-409	411	411	411	411
277	246-251	277	249-252	252-257	253-257	255-255	255-255	254	254	254	254
218	208-212	218	210-213	214-215	214-215	207-211	208-210	212	212	212	212
229	221-229	229	227-232	227-227	227-227	217-222	217-220	223	223	223	223
260	240-245	260	244-247	252-256	252-255	247-250	247-249	251	251	251	251
1,584	1,594	1,604	1,614	1,674	1,694	1,730	1,745	1,705	1,720	1,720	1,720
2,050	2,050	2,050	2,050	2,150	2,150	2,150	2,150	2,150	2,150	2,150	2,150
●	●	●	●	●	●	—	—	—	—	—	—
●	●	●	●	●	●	—	—	—	—	—	—
—	●	—	●	●	●	—	—	—	—	—	—
—	—	—	—	—	—	●	●	—	—	—	—
—	—	—	—	—	—	—	—	●	●	●	●

³TEL (Test Energy Low) and TEH (Test Energy High) figures are shown as a range under WLTP testing measures. TEL refers to the lowest/most economical figures (with the lightest set of options). TEH refers to the highest/least economical figures (with the heaviest set of options). WLTP legislation dictates that where there is <5g CO₂ variance between TEL and TEH, only the TEH is declared. ⁴Please consult your local Jaguar Retailer for details of charges associated with option fitment. Weights reflect vehicles to standard specifications. Optional extras increase weight.

DIMENSIONS

 Configure your vehicle at jaguar.com

COUPÉ		JAGUAR 2.0 LITRE i4 300 TURBOCHARGED PETROL	JAGUAR 3.0 LITRE V6 340 SUPERCHARGED PETROL	JAGUAR 3.0 LITRE V6 380 SUPERCHARGED PETROL	JAGUAR 3.0 LITRE V6 380 SUPERCHARGED PETROL AWD	JAGUAR 5.0 LITRE V8 550 SUPERCHARGED PETROL AWD	JAGUAR 5.0 LITRE V8 575 SUPERCHARGED PETROL AWD
Overall length	mm	4,482	4,482	4,482	4,482	4,482	4,475
Overall width (inc. mirrors)	mm	2,042	2,042	2,042	2,042	2,042	2,042
Overall width (with mirrors folded)	mm	1,923	1,923	1,923	1,923	1,923	1,923
Overall height	mm	1,311	1,311	1,311	1,311	1,311	1,311
Wheelbase	mm	2,622	2,622	2,622	2,622	2,622	2,622
Front track	mm	1,597*	1,597*	1,597*	1,597*	1,585	1,585
Rear track	mm	1,649**	1,649**	1,649**	1,649**	1,627	1,611
Ground clearance	mm	100	101	101	104	100	107
Turning circle diameter (kerb-to-kerb)	m (ft.in.)	10.7 (35.0)	10.7 (35.0)	10.7 (35.0)	11.3 (37.0)	11.3 (37.0)	11.3 (37.0)
Coupé boot volume with parcel tray	litres (cu.ft.)	310 (10.9)	310 (10.9)	310 (10.9)	310 (10.9)	310 (10.9)	310 (10.9)
Coupé boot volume without parcel tray	litres (cu.ft.)	408 (14.4)	408 (14.4)	408 (14.4)	408 (14.4)	408 (14.4)	408 (14.4)
CONVERTIBLE							
Overall length	mm	4,482	4,482	4,482	4,482	4,482	4,475
Overall width (inc. mirrors)	mm	2,042	2,042	2,042	2,042	2,042	2,042
Overall width (with mirrors folded)	mm	1,923	1,923	1,923	1,923	1,923	1,923
Overall height	mm	1,308	1,308	1,308	1,308	1,308	1,308
Wheelbase	mm	2,622	2,622	2,622	2,622	2,622	2,622
Front track	mm	1,597*	1,597*	1,597*	1,597*	1,585	1,585
Rear track	mm	1,649**	1,649**	1,649**	1,649**	1,627	1,611
Ground clearance	mm	100	101	101	104	100	107
Turning circle diameter (kerb-to-kerb)	m (ft.in.)	10.7 (35.0)	10.7 (35.0)	10.7 (35.0)	11.3 (37.0)	11.3 (37.0)	11.3 (37.0)
Convertible boot volume	litres (cu.ft.)	207 (7.3)	207 (7.3)	207 (7.3)	207 (7.3)	207 (7.3)	207 (7.3)

*1,585 on 20" wheels. **1,627 on 20" wheels.



Turning Circle
 Kerb-to-kerb
 10.7m (RWD)
 11.3m (AWD)



Overall Width (inc. mirrors) 2,042mm
Overall Width (mirrors folded) 1,923mm
Boot Volume 408 litres (Coupé) 207 litres (Convertible)



Dimensions were measured with vehicle at unladen weight. (Measured by VDA standard test method using 200 x 100 x 50mm blocks).
 Figures shown are for F-TYPE R. See pages 112-114 for full details on Technical Specifications.

VEHICLE SHOWN F-TYPE R IN YULONG WHITE WITH OPTIONAL FEATURES FITTED (MARKET DEPENDENT)

THE WORLD OF JAGUAR

Your Jaguar drives with an instinct for performance, refined through decades of innovative design and engineering. Power and agility are combined with elegance and grace to deliver a vehicle like no other. As a celebration of Jaguar, we've created a range of experiences, publications and the Jaguar Lifestyle Collection. To top it all, we've even returned to the track with Jaguar Racing. Welcome to a world where every aspect of performance is an art.

EXPERIENCE DRIVES



There's no better way of understanding the spirit of Jaguar than by getting behind the wheel. Jaguar Experience Drives are an opportunity to unleash the breathtaking performance of our incredible Jaguar range. Join us at one of our Experience centres, or take part in the Art of Performance Tour. New sensations await.

[jaguar.com/experience](https://www.jaguar.com/experience)

JAGUAR LAND ROVER ICE ACADEMY



Take your driving to the next level with Jaguar Land Rover Ice Academy. Located on one of the many frozen lakes in Arjeplog, Sweden, your driving skills will be tested through tackling some of the harshest, most challenging tracks on the planet. It's a rare chance to dance on ice and glide around awe-inspiring corners, all under the expert guidance of our instructors. Encounter the true exhilarating potential of the latest Jaguar and Land Rover vehicles in extreme conditions.

[jaguar.com/ice-academy](https://www.jaguar.com/ice-academy)

Follow us on:



MANUFACTURING TOURS



Witness at first-hand a Jaguar being brought to life. Behind our award-winning craftsmanship lies an unrivalled harmony of skilled technicians and cybernetic production robots. Our expert tour guides will accompany you as you make your way through the hi-tech manufacturing process, from sheet metal to the finished creation.

jaguar.com/tours

SPECIAL VEHICLE OPERATIONS



With outstanding performance, cutting-edge technology and incomparable luxury, Jaguar is a showcase for the finest in design and engineering. Special Vehicle Operations takes this even further. Adorned with the SV badge, halo models and limited-run collector's editions are the very pinnacle of the Jaguar range, offering a combination of the ultimate in power and dynamics.

jaguar.com/svo

ABB FIA FORMULA E



Jaguar's reputation for performance, technology and design was forged at the world's most challenging circuits and championships. From Le Mans to Formula 1, and now Formula E, the grid is our test bed. Formula E provides the perfect proving ground for electric vehicle technology in a high performance environment. The racing series accelerates the development of Jaguar's electric powertrains. With every race, Formula E helps Jaguar engineers to create better electric vehicles.

jaguar.com/jaguar-racing

JAGUAR I-PACE eTROPHY



We're making history. Again. Our latest development as leader in the global automotive race to electrification is I-PACE eTrophy - the world's first all-electric production-based international race series. Engineered and built by Special Vehicle Operations to compete on the zero emissions world stage; racers of the future will push electrification to thrilling heights.

jaguar.com/etrophy

Follow us on:



THE JAGUAR LIFESTYLE COLLECTION



Our latest range of apparel and lifestyle accessories is inspired by Jaguar's rich heritage, racing expertise, and iconic designs. This exclusive, impressively executed collection follows the performance-orientated style that is Jaguar.

jaguar.com/collection

THE JAGUAR MAGAZINE



This is our own vibrant, cosmopolitan and contemporary magazine. Go behind the scenes at Jaguar and explore our dedication to performance, design and innovation – as well as catching an insight into the world of luxury, style and travel. You can enjoy The Jaguar magazine twice a year, completely free of charge for the first three years of ownership. Ask your local Jaguar Retailer to ensure that you receive your copy.

jaguar.com/magazine



UCB 358

AT YOUR SERVICE

As well as providing a range of exclusive services and lifestyle products, the World of Jaguar makes owning and driving carefree and easy.

JAGUAR CARE*

F-TYPE is offered with a 100,000km limited mileage, three year warranty and three years' standard servicing programme. We call this programme Jaguar Care. It makes F-TYPE's overall cost of ownership one of the lowest in its class. To find out more about F-TYPE's Jaguar Care programme, please go to jaguar.com/jaguarcare

GENUINE PARTS

Jaguar Genuine Parts are designed, tested and manufactured to our uncompromising standards for quality, fit and durability. Each part is engineered specifically for your F-TYPE to contribute to optimum performance and to help maximise its lifespan.

FLEET & BUSINESS

Jaguars are dynamic and distinctive cars that help companies express the unique character and personality of their business. We are committed to providing customer-focused aftersales services, ensuring that every Jaguar performs to the highest standard and in the most cost-efficient way for businesses. Visit jaguar.com/fleet-and-business for more information.

JAGUAR ASSISTANCE

Jaguar Assistance provides assistance in motoring emergencies, from immobilisation due to breakdown or accident to minor problems such as punctures. You can rely on our roadside assistance, whatever the situation, wherever you happen to be.

JAGUAR FINANCIAL SERVICES

New or used, for personal or business use, we have a finance option that puts you in complete control. Please speak to your local Jaguar Retailer to find out more.

INSURANCE

F-TYPE's key components are easily accessible for time-efficient service and repair costs. With a focus on lower repair costs, F-TYPE delivers competitive insurance group ratings. To find out more about the compelling business case for F-TYPE, please contact your local Jaguar Retailer.

IMPORTANT NOTICE

Jaguar Land Rover Limited is constantly seeking ways to improve the specification, design and production of its vehicles, parts and accessories and alterations take place continually. Whilst every effort is made to produce up to date literature, this brochure should not be regarded as an infallible guide to current specifications or availability, nor does it constitute an offer for the sale of any particular vehicle, part or accessory. Distributors and retailers are not agents of Jaguar Land Rover Limited by any express or implied undertaking or representation.

COLOURS

The colours reproduced here are subject to the limitations of the printing process and may therefore vary slightly from the actual vehicle. The company reserves the right to alter or withdraw any colour finish without notice. Some of these colours may not be obtainable in your country. Please check availability of colours and current specifications with your Jaguar Retailer. Distributors and Retailers are not agents of Jaguar Land Rover Limited and have absolutely no authority to bind Jaguar Land Rover Limited to any express or implied undertaking or representation.

ENVIRONMENTAL INNOVATION AT JAGUAR

Jaguar is committed to reducing dependency on fossil fuels, using fewer natural resources and creating less waste as part of our approach to responsible and sustainable business development.

Search 'Jaguar Environmental Innovation' for more details.

*Selected European markets only

Castrol EDGE Professional exclusively recommended by Jaguar.

Meridian is the registered trademark of Meridian Audio Ltd.

HomeLink® is a registered trademark of Gentex Corporation.

The Bluetooth® word mark and logos are owned by the Bluetooth SIG, Inc. and any use of such marks by Jaguar Land Rover Limited is under license. iPhone is a trademark of Apple Inc., registered in the US and other countries. The navigation system must always be used in conditions that will not affect the driver's ability to drive safely or affect the safety of other road users.

**VEHICLE SHOWN LEFT: F-TYPE R-DYNAMIC AWD IN SILICON SILVER WITH OPTIONAL FEATURES FITTED (MARKET DEPENDENT)
VEHICLE SHOWN BACK COVER: F-TYPE SVR IN CALDERA RED (MARKET DEPENDENT)**

Jaguar Land Rover Limited
Registered Office: Abbey Road, Whitley,
Coventry, CV3 4LF, United Kingdom

Registered in England Number: 1672070

jaguar.com

©Copyright Jaguar Land Rover Limited 2018

1X1522020000BGBEN02P

