

DISCOVERY



ABOVE & BEYOND





BY APPOINTMENT TO
HM THE QUEEN
MANUFACTURERS OF
MOTOR VEHICLES
JAGUAR LAND ROVER LIMITED
COVENTRY



BY APPOINTMENT TO
HRH THE DUKE OF EDINBURGH
MANUFACTURERS OF
MOTOR VEHICLES
JAGUAR LAND ROVER LIMITED
COVENTRY



BY APPOINTMENT TO
HRH THE PRINCE OF WALES
MANUFACTURERS OF
MOTOR VEHICLES
JAGUAR LAND ROVER LIMITED
COVENTRY



ABOVE & BEYOND

Ever since the first Land Rover vehicle was conceived in 1947, we have built vehicles that challenge what is possible. These in turn have challenged their owners to explore new territories and conquer difficult terrains. Our vehicles epitomise the values of the designers and engineers who have created them. Each one instilled with iconic British design cues, delivering capability with composure. Which is how we continue to break new ground, defy conventions and encourage each other to go further. Land Rover truly enables you to make more of your world, to go above and beyond.









CONTENTS

INTRODUCTION

The Concept of Discovery	6
Discovery - The Facts	8

DESIGN

Exterior	11
Interior	15
Seven Full-Size Seats	19
Remote Intelligent Seat Fold	19
Space and Comfort	20
Stowage	21
Powered Inner Tailgate	22
Powered Gesture Tailgate	22
Loadspace Capacity	24

DRIVING CAPABILITY

Testing	26
All Terrain Technology	29
Terrain Response	29
All Terrain Progress Control	29
Hill Descent Control	30
Wade Sensing	31

Permanent All Wheel Drive Systems	33
Suspension	33
Efficient Technologies	35
On-Road Dynamics	36

TECHNOLOGY

Infotainment	39
Audio	40
Connectivity	42

DRIVING TECHNOLOGY

Driver Assistance	48
Driving Aids	54
Towing Aids	56

COMFORT FOR ALL

	61
--	----

ENGINES

8-Speed Automatic Transmission	67
--------------------------------	----

BODY AND CHASSIS

Strength and Stability	68
------------------------	----

SAFETY	70
---------------	----

ENVIRONMENTAL	
Sustainability	73

SPECIFICATIONS

Choose Your Engine	76
Choose Your Model and Options	78
Choose Your Colour	102
Choose Your Wheels	106
Choose Your Interior	108
Choose Your Land Rover Gear	116
- Accessories	

THE WORLD OF LAND ROVER	122
--------------------------------	-----

YOUR PEACE OF MIND	127
---------------------------	-----

Vehicle shown left is Landmark Edition in Eiger Grey with optional features fitted (market dependent).

Vehicles shown are from the Land Rover global range. Vehicles shown feature optional wheels and a number of optional features. Specifications, options and availability will vary between markets and should be verified with your nearest Land Rover Retailer.

INTRODUCTION

THE CONCEPT OF DISCOVERY

Ever since it first took to the streets, mud tracks and deserts in 1989, Discovery has blazed its own trail. From Alaska to Zambia, it has become synonymous with capability and versatility, whether off-road or in the city. Discovery takes those characteristics, together with several innovations pioneered by Land Rover, to uncharted territories.

Discovery is a quantum leap forward in SUV design. A radical and sharply focused approach to embodying Land Rover's vision of the most versatile and capable SUV.

Discovery combines the flexibility of a beautifully crafted full-size seven-seat interior, packed full of ingenious design details, with dramatic proportions, clean modern lines and a dynamic silhouette.

NEW DISCOVERY LANDMARK EDITION

Whether you're in the midst of city life or driving to a secluded Spanish retreat, Discovery Landmark Edition has been designed to suit every occasion.

Vehicle shown right is Landmark Edition in Eiger Grey with optional features fitted (market dependent).

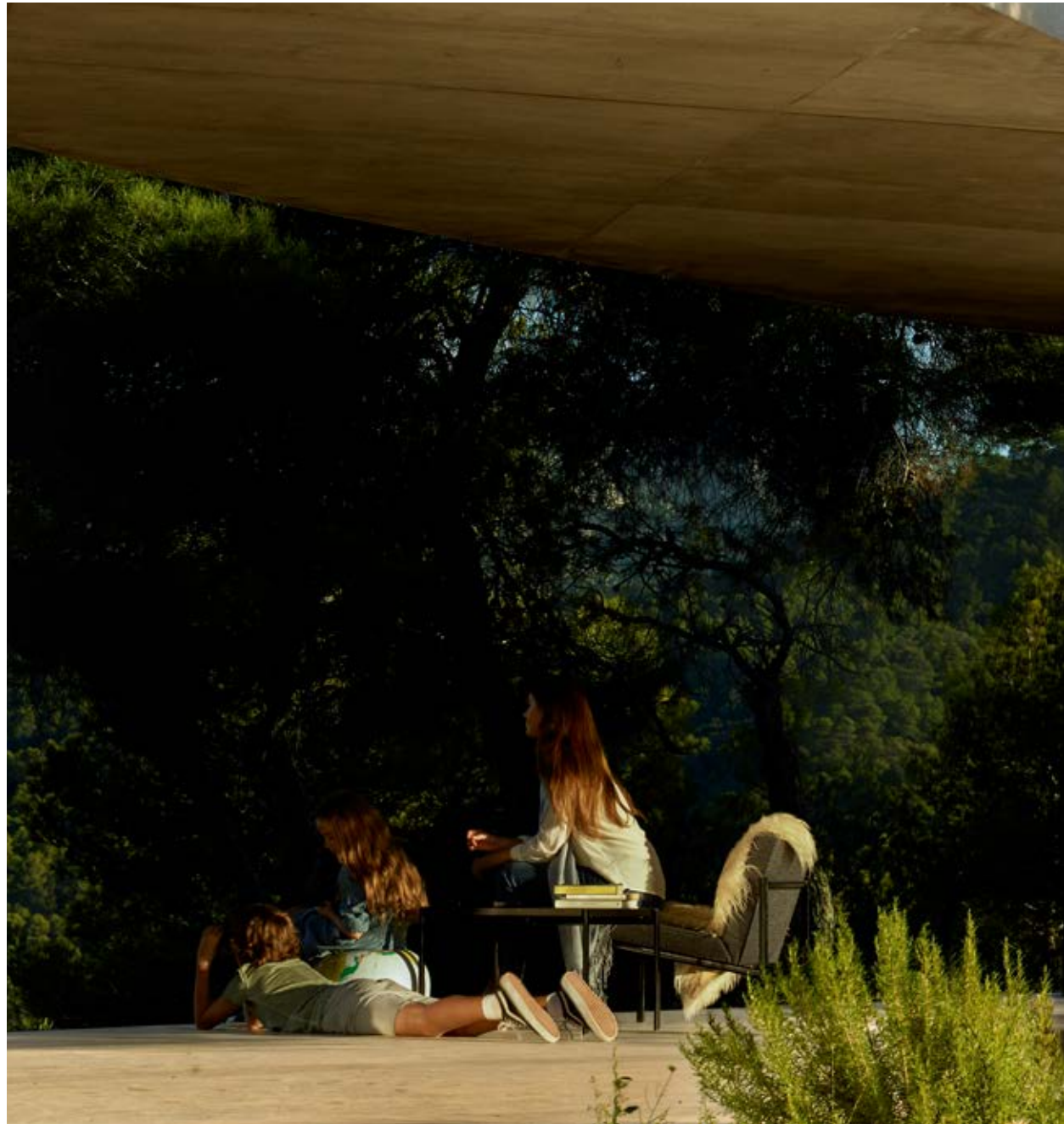



DISCOVERY – THE FACTS

Form, function and exemplary levels of finesse are brought together to help create one of Land Rover's most compelling vehicles to date. Its inherent strength and off-road capabilities are matched only by its bold contemporary looks and alluring touches of luxury. Inside, astute use of space coupled with high-quality design and use of premium materials enhance the vehicle's bold horizontal and vertical lines.

The versatility of the cabin is highlighted by the easily configurable optional seven-seat layout and plentiful stowage, with clever use of space and refined comfort.

NEW DISCOVERY LANDMARK EDITION

Wherever you go, and whatever you do, Discovery Landmark Edition has been designed with a distinctive look. This is complemented by key technology enhancements to enrich your driving experience. See page 81 for details.

SEVEN FULL-SIZE SEATS WITH INTELLIGENT SEAT FOLD

Discovery has the option of three rows of seats with Intelligent Seat Fold allowing you to configure the second and third row seating using switches located in the loadspace or on the main Touchscreen. Furthermore, using technology pioneered by Land Rover, Discovery allows you to remotely configure the seats when you're not in your vehicle, via an app on your smartphone. See page 19 for details.

ACTIVITY KEY

The Activity Key lets you live life to the full. Housed in a robust and fully waterproof wristband, it allows you to pursue a range of activities from sailing to skydiving, safe in the knowledge that your vehicle is always protected. See page 65 for details.

POWERED INNER TAILGATE

The first of its kind, this hands-free system provides a seating and loading platform and can also be used as a load retention barrier for when the tailgate is open. See page 22 for details.

UNRIVALLED TOWING

Over the years, Discovery has earned many accolades around the world for its towing capabilities, which is why so many would naturally expect this vehicle to live up to the most demanding expectations. It doesn't disappoint. Discovery takes it to a new level, delivering an impressive towing capacity of up to 3.500kg, ensuring it measures up to the vehicle's proud DNA. See page 56 for details.

SUPREME CAPABILITY

The vehicle's lineage and DNA are without question. Its all-terrain capability, wading ability and features such as Terrain Response 2 ensure Discovery is always ready to get out there and tackle whatever comes over the horizon, no matter where that happens to be. See page 29 for details.

For full feature and option availability please refer to the accompanying Specification and Price Guide or visit your nearest Land Rover Retailer.

Vehicle shown right is HSE Luxury in Namib Orange.

UNCOMPROMISED LOADSPACE CAPACITY

With over 2.400 litres of loadspace, ideal for wet or dirty gear, and the flexibility of seven seats, Discovery is every vehicle you'll ever need. See page 24 for details.

DRIVER ASSISTANCE FEATURES

Whether you're off-road or in the city our Driver Assistance technology, available on Discovery, will ensure a seamless driving experience. Driver Condition Monitor detects when you show signs of drowsiness, whilst Adaptive Cruise Control with Steering Assist automatically moderates the steering, braking and acceleration of your vehicle. Standard safety features include Rear Camera and Emergency Braking. See pages 48-53 for details.



INTERIOR COMFORT

Passengers enjoy optimum comfort, unparalleled views and benefit from Cabin Air Ionisation technology, helping improve the air quality within the vehicle cabin. See page 61 for details.

CLEVER STOWAGE

From the fold down stowage behind the climate controls, to the upper and lower glovebox and a comprehensive space below the centre console cupholders, Discovery has stowage in places you simply would not expect. See page 21 for details.

INTUITIVE CONNECTIVITY

Discovery features the very latest suite of technologies, including InControl, a raft of USB ports and the latest in infotainment to keep you and your passengers connected and entertained. See page 42 for details.





DESIGN

EXTERIOR

The vehicle's exterior design is a revolutionary re-imagining of Discovery for the next generation.

Discovery is beautifully proportioned for a full-size SUV, with sleek, wrap-around headlights and tail lights combining with short front and rear overhangs to reduce visual length. A fast windscreen angle, rising belt line and elegant, smoothly contoured shape, result in a streamlined and dynamic form which combines aerodynamic efficiency with class-leading interior space. The body-coloured c-pillar, stepped roof and asymmetric element on the rear number plate panel all refer to the rich lineage of previous Discovery design.



Clean flush elements, a dynamic rising waistline and wrap-around lights convey a strong sense of modernity. Cleverly designed LED lights have been developed to wrap around the side of the vehicle to enable the indicators to be more visible to improve safety. LED lights are fitted as standard on SE, HSE, HSE Luxury and Landmark Edition.





Discovery introduces a new level of refinement as demonstrated by its beautifully crafted and sculpted surfaces. The distinctive roof and feature lines rising towards the rear of the vehicle give it an assertive, recognisable stance that is further enhanced by the front and rear graphics.

Sophisticated and urbane, Discovery epitomises the most compelling contemporary British design.





INTERIOR

The highly desirable interior is a re-imagining of the classic Discovery design elements with the striking use of strong horizontal and vertical lines connecting through the main fascia beam. The use of materials such as premium leather, authentic wood and metal finishers, coupled with focussed craftsmanship and precision, create an air of cultured modern living.

The 10" Touch Pro infotainment Touchscreen helps you connect to the outside world and puts a wealth of entertainment and information at your fingertips. The clever use of both seating design and stowage space helps deliver class-leading capability for you, your family and friends.

The 12,3" Interactive Driver Display ensures you're always entertained, informed and connected. See page 39 for details.

All in-car features should be used by drivers only when safe for them to do so. Drivers must ensure they are in full control of the vehicle at all times. Interior shown is HSE Luxury in Light Oyster/Espresso.





UNCOMPROMISING ATTENTION TO DETAIL

An eye for the minutiae. The finest materials. These are the qualities that our designers have carefully considered to help shape Discovery's interior. Added to which, sumptuous leather, beautifully finished handcrafted wood veneers, Noble Chrome details, Brushed Aluminium finishers and crafted stitching can be incorporated throughout the interior for added luxury.



Interior shown is HSE Luxury in Light Oyster/Esspresso.





SEVEN FULL-SIZE SEATS

Discovery's optional seven full-size seats truly exemplify comfort and versatility. Divided across three rows and readily deployable, no other vehicle in its class is so well appointed. For instance, the second row enjoys a 60:40 slide and recline configuration, coupled with a load-through facility. Stadium seating ensures everyone can see the road ahead in the greatest comfort whilst the stepped roof allows for greater headroom in the second and third rows; such clever use of space ensures everyone travels first class. Added to which, there are a number of comfort features available including heated seats across all three rows and cooled seats on the first and second row: please refer to page 90 for a full list of available options.

REMOTE INTELLIGENT SEAT FOLD

On HSE and HSE Luxury, where third row seats are specified, there's a choice of ways you can easily deploy the seats with our optional Remote Intelligent Seat Fold: from the Touchscreen, switches located in the loadspace or via our innovative app from your smartphone. When you're standing well away from the vehicle, in a shopping queue for example, the vehicle can be ready for your return so you can utilise the space according to the size or shape of what you want to carry. You can reconfigure the seats without any fuss simply by using this feature.

The powered seat folding mechanism uses an intelligent control system which ensures the seats, including the headrests, fold away seamlessly, safely and conveniently. The system understands when seats are occupied or have heavy items on them and, when folding, automatically adjusts their position to prevent a conflict.

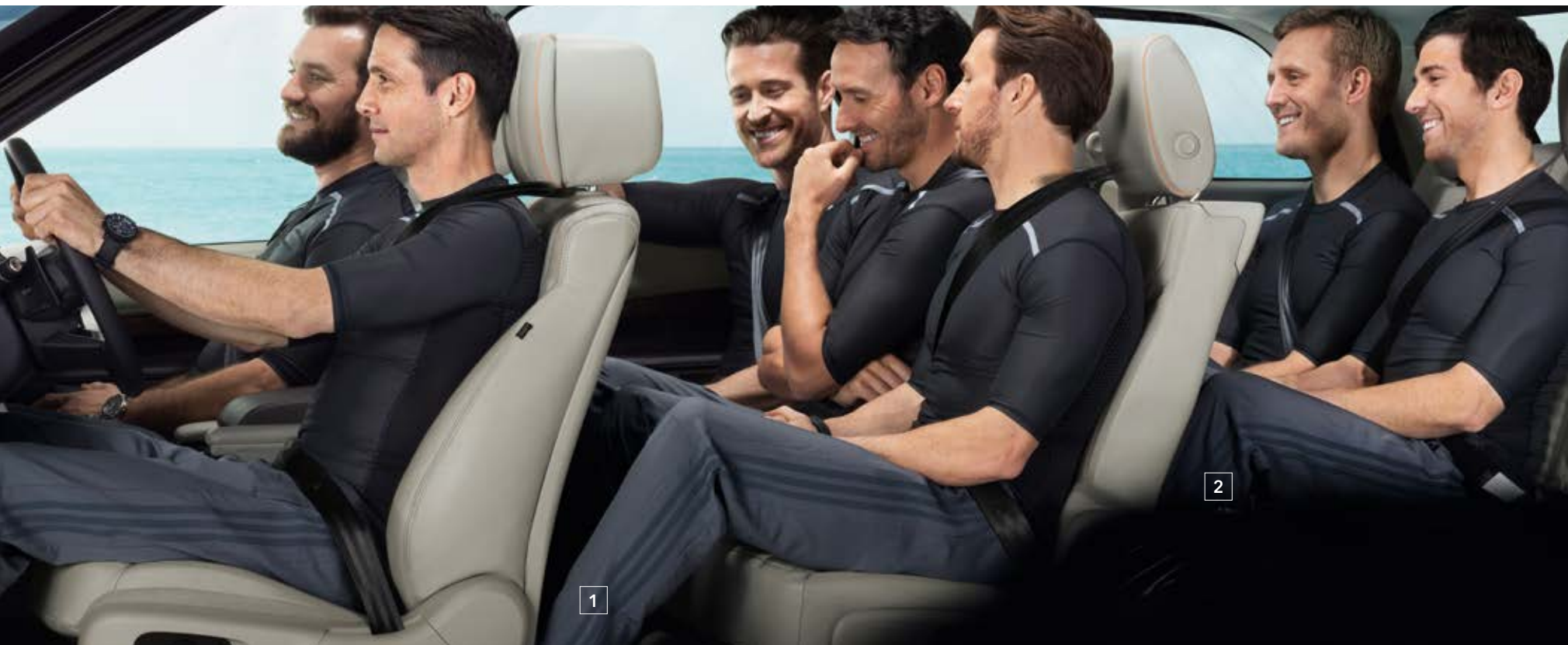

1 Second row legroom 954mm

2 Third row legroom 850mm

SPACE AND COMFORT

Each and every passenger in Discovery enjoys a truly comfortable ride, with a generous amount of legroom offered. Those in the second row will find they have 954mm, whilst in the optional third row, a plentiful 850mm is provided.

Even a team of seven adults can travel in comfort. Added to which, when slide and recline is specified, you can configure the second row to optimise the available room even further.



Cubby box storage with an optional chiller compartment



Centre console storage behind the climate controls¹



Cupholders with additional storage beneath¹



Upper and lower glovebox²



Push operated hook¹



Third row storage with lid

STOWAGE

Discovery is brimming with clever spaces in which to stow away all those electronic devices and travel guides. From the upper and lower glovebox on SE, HSE, HSE Luxury and Landmark Edition, to central armrest stowage with an optional chiller compartment and space for multiple tablets, you'll find space in places you simply wouldn't expect. The central armrest cubby box can hinge back 180° to create a flat tray, should second row passengers require more stowage, whilst the door bins can also accommodate 1 litre bottles in the front and 0,5 litre bottles in second row.

Standard on HSE and HSE Luxury, a neatly integrated push-operated hook to hang a small shopping bag sits flush in the front passenger footwell when not in use.

When optional third row seats are selected, third row passengers benefit from individual storage spaces including within the side panel. In fact, across all rows there's more than enough space for even the most demanding of families.

¹Only available on HSE and HSE Luxury. ²Not available on S.



POWERED INNER TAILGATE

Pioneered by Land Rover, Discovery features a powered inner tailgate, which when deployed can provide a platform for use at social and sporting events coupled with greater protection from the elements. This platform also allows for easier loading and acts as a retainer when the loadspace area is filled. Powered inner tailgate is fitted as standard on HSE and HSE Luxury, and available as an option on S, SE and Landmark Edition.



POWERED GESTURE TAILGATE

Powered gesture tailgate allows you to operate the tailgate (both to open and close) from outside the vehicle without needing to physically touch the vehicle or the smart key.

Provided that the smart key is detected, the tailgate may be operated by a kicking gesture underneath the rear of the vehicle.

Two sensors mounted on either side of the tailgate allow kerbside operation, rather than needing to be immediately behind the vehicle. And as the system is compatible with towing solutions, you can still open and close the tailgate with the least amount of fuss. Powered gesture tailgate is available as an option on SE, HSE, HSE Luxury and Landmark Edition.

Additionally, a button located inside the tailgate or on the smart key allows the tailgate to be closed automatically with powered tailgate.







LOADSPACE CAPACITY

With a luggage-devouring 2.500 litres of space behind the first row of seats, Discovery welcomes a greater load than any other SUV in its class. There's a generous 1.231 litres of space behind the second row of seats. Even when you utilise all seven seats you can still fit up to three cabin bags behind the optional third row. When it comes to carrying any load, having the option to fold all second and third row seats gives you more options, making life that bit easier.



7 SEATS

DRY
172 LITRES

WET
258 LITRES

6 SEATS

DRY
547 LITRES

WET
698 LITRES



5 SEATS*

DRY 986 LITRES
WET 1.231 LITRES

4 SEATS*

DRY 1.202 LITRES
WET 1.485 LITRES

4 SEATS*

DRY 1.419 LITRES
WET 1.739 LITRES

3 SEATS*

DRY 1.635 LITRES
WET 1.992 LITRES

2 SEATS*

DRY 2.068 LITRES
WET 2.500 LITRES

*Loadspace capacity figures are representative of a 5 seat vehicle.
Dry: Volume as measured with VDA-compliant solid blocks (200mm x 50mm x 100mm).
Wet: Volume as measured by simulating the loadspace filled with liquid.

DRIVING CAPABILITY

TESTING

Before any vehicle can carry the Land Rover badge, it must complete a series of rigorous tests to establish the very highest levels of luxury, performance and capability.



SUSPENSION

You're unlikely to push any Land Rover harder than we have. For an unrivalled breadth of dynamic capability, both on and off-road, the vehicles have been exposed to 10 years of the most extreme driving pressures in a fraction of the time using our state-of-the-art test rig.



WIND SPEED

Discovery was developed in state-of-the-art wind tunnels and a suite of climatic chambers to recreate some of the most challenging aerodynamic conditions it will face. Only by pushing all systems to their limits do we develop true reliability.



HOT AND COLD CLIMATE

In real world environments and our climate chambers, we freeze vehicles to -40°C and bake them to 50°C. Key functions and systems are then scrutinised to our exacting standards. So even in the most remote locations, comfort and peace of mind are never far away.



OFF-ROAD

From the icy proving grounds of Arjeplog, Sweden, to Dubai's unforgiving desert sands, we ensure our legendary all terrain performance is innate in every vehicle. Prototypes are developed across approximately 8.500km of the most demanding off-road routes.



SEMI-ANECHOIC CHAMBER

In the 'neutral sound' of our semi-anechoic chamber we precisely expose the cabin to a range of frequencies and vibrations, making certain that Discovery sounds refined at every speed and across every surface.



MONSOON

Our water testing facilities ensure each vehicle can enter and exit a body of water without a single droplet entering the cabin. In the monsoon simulator, each one is drenched with some 85.000 litres of specially dyed water, while tilting it by as much as 45°, checking for even the slightest leak with UV lights.







ALL TERRAIN TECHNOLOGY

Discovery not only looks truly at home in the city, but also drives impeccably off-road. Its optimised geometry coupled with unique Land Rover technologies ensure it delivers class-leading all-terrain capabilities.

TERRAIN RESPONSE

With 70 years of all terrain expertise, this vehicle has Land Rover capability at its heart. Our unique Terrain Response systems enable the driver to optimise the vehicle's engine, gearbox, centre differential and chassis systems to match the demands of the terrain, by selecting one of the easily identifiable driving modes. It also includes additional Rock Crawl Mode when your vehicle is specified with electronic air suspension and twin-speed transfer box.

TERRAIN RESPONSE 2

The optional Terrain Response 2* system enhances this even further by monitoring driving conditions and automatically selecting the driving modes to achieve the best possible chassis and powertrain set up for the conditions.

 General Driving

 Sand

 Grass, Gravel, Snow

 Rock Crawl

 Mud & Ruts

ALL TERRAIN PROGRESS CONTROL

All Terrain Progress Control* (ATPC) is a state-of-the-art optional system that enables drivers to set and maintain a steady speed in challenging conditions.

Operating like a cruise control system, it functions at very low speeds between 2km/h and 30km/h, enabling the driver to maintain full concentration on steering and finding a path through obstacles.

Developed by Land Rover's industry-leading all-terrain specialists, the system works seamlessly alongside the Terrain Response 2 and All Wheel Drive (AWD) traction and braking systems.

Once ATPC is activated, the standard steering wheel +/- cruise control buttons are used to set the speed. Brake and accelerator pedals can still override the chosen settings, with gentle braking achieving a reduction in speed.

*Not available on S models. Not available with Si4 engine.

Features and their availability may differ by vehicle specification and market. Please see pages 86-101, or contact your nearest Land Rover Retailer, for more information.

Vehicle shown left is HSE Luxury in Namib Orange.

HILL DESCENT CONTROL

Land Rover's patented Hill Descent Control (HDC) is a standard feature. It assists the driver with controlled descents of difficult slopes by maintaining a constant speed and applying braking separately to each wheel.

Hill Launch Assist ensures the vehicle doesn't roll backwards as it pulls away on an incline.

The vehicle also utilises **Gradient Release Control (GRC)** which is designed to prevent the vehicle accelerating too quickly on a steep incline when the driver releases the brake.





WADE SENSING



Discovery's improved geometry enables a significant improvement in wading capability when compared to its predecessor.

With a wading depth of up to 900mm, whether crossing streams, fords or flooded areas, the optional Wade Sensing feature can prove invaluable. Available as an option on HSE and HSE Luxury.

Unique to Land Rover, sensors located in the door mirrors give the driver pictorial real-time information about the water's depth in relation to the vehicle, as well as maximum wading capability via the Touchscreen.

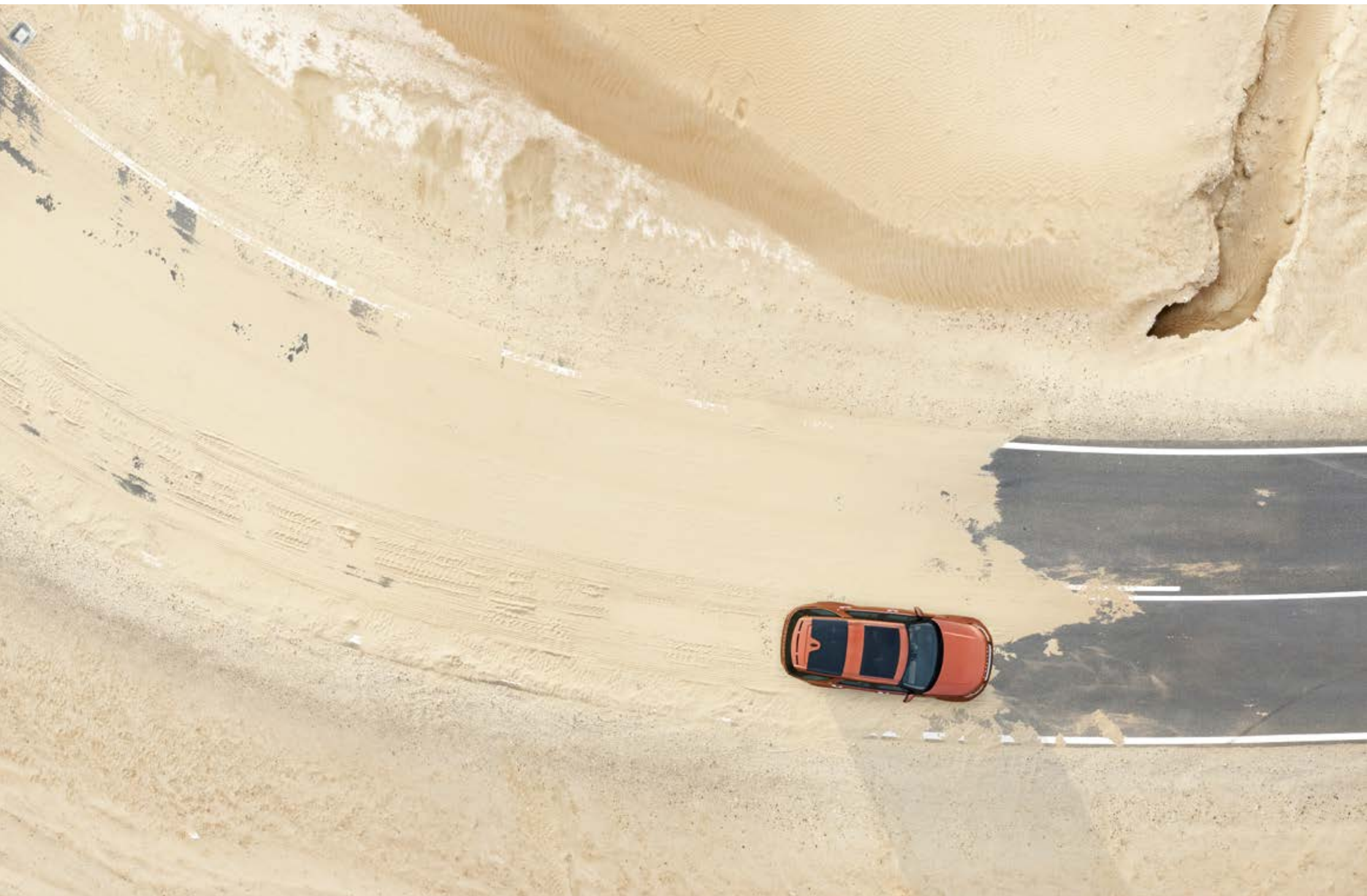

PERMANENT ALL WHEEL DRIVE SYSTEMS



Discovery features a choice of intelligent, permanent Land Rover All Wheel Drive (AWD) systems to deliver unrivalled, all-weather and all-surface capability. You can select from the following systems depending on capability requirements:

SINGLE-SPEED TRANSFER BOX (HIGH RANGE ONLY)

This system has a single set of high range, road biased gears with the intelligence to sense wheel slip and move torque to the other axle to provide additional traction. It normally delivers 42 percent drive to the front axle with 58 percent drive biased to the rear axle. The centre differential is reactive to wheel slip on one axle and can change the amount of bias to add more torque and traction to the other axle to support. This system is standard on Sd4 and Si4 Ingenium engines.

TWIN-SPEED TRANSFER BOX (HIGH/LOW RANGE)

An additional set of lower gears can prove invaluable in challenging conditions such as steep inclines or declines, off-road driving or when towing. This system gives you precise speed and control in such instances. The heart of the twin-speed system is the electronic centre differential that offers a 50:50 torque split between front and rear axles with the ability to pre-emptively lock the axles before slip commences. Available as a combined option on Sd4 Ingenium engines with air suspension and standard with Sd6 engines.

ACTIVE REAR LOCKING DIFFERENTIAL

The Active Rear Locking Differential - an option on Sd4¹ and Sd6 engines when the vehicle has air suspension and twin-speed transfer box - offers an additional benefit of controlling the slip between the left and right wheels on the rear axle. This can be especially useful in low-grip conditions such as on wet grass where the vehicle monitors the slip and torque between front and rear axles and also from one wheel to another on the rear axle to deliver effortless capability.

ADAPTIVE DYNAMICS

Adaptive Dynamics makes the miles go by virtually unnoticed. The system monitors vehicle movements up to 500 times a second, reacting to driver or road inputs almost instantaneously to give greater control and minimise body movement ensuring a composed, flat ride. The system even senses off-road conditions, and optimises damping accordingly so driver and passengers arrive at their destination refreshed and relaxed. Available as an option on Sd6² HSE and HSE Luxury and available as part of the Performance Pack on Sd4 HSE models.

SUSPENSION

COIL SUSPENSION

Standard with the Sd4 and Si4 Ingenium engines, Discovery has a fully independent coil sprung suspension system that combines double wishbones at the front with an advanced multi-link rear suspension design to create an agile and responsive chassis.

Ride comfort and stability when heavily laden are optimised through the use of additional secondary springs incorporated within the rear suspension.

ELECTRONIC AIR SUSPENSION

A sure-footed, composed drive is completed by the latest four-corner air suspension which provides exceptional wheel articulation and poise.

Capable of taking on tough situations, this system is designed to keep Discovery stable no matter how rough the terrain. For unprecedented ride quality, it switches heights seamlessly when necessary.

Air suspension also allows for innovative new access features to enhance versatility and ease of use.

Automatic Access Height is a feature which automatically lowers the ride height by 40mm when the vehicle is parked.

Rear Height Adjust allows the use of switches in the loadspace or on the key fob to lower the rear ride height. See page 56 for more information.

Available as an option on Si4 Ingenium engines, a combined option on Sd4 Ingenium engines and standard with Sd6 engines.

¹Not available on S models. ²Roof carrying load increased from 80kg to 100kg when Sd6 selected with Adaptive Dynamics.

Features and their availability may differ by vehicle specification and market. Please see pages 86-101, or contact your nearest Land Rover Retailer, for more information.

Vehicle shown left is HSE Luxury in Namib Orange.



EFFICIENT TECHNOLOGIES

SUSTAINABLE BY DESIGN

Land Rover are committed to producing vehicles that use more sustainable materials, produce less waste and use fewer natural resources as part of our approach to sustainable and responsible business. Land Rover's development process has included a full life cycle assessment and has been designed to be 85 percent recyclable/re-usable and 95 percent recoverable at the end of the vehicle's life.

Our innovative design enables the use of a unique alloy in the vehicle body, made from up to 50% recycled aluminium derived from our closed loop manufacturing process, retaining quality and performance but delivering lower life cycle CO₂ emissions. Closed loop manufacturing means taking the scrap from the body pressings process, segregating it and re-melting it back into quality sheet aluminium at our supplier, to be used again to press out body panels, thereby reducing the need to use primary aluminium.

STOP/START

Discovery engines are all available with Stop/Start¹. This system shuts down the engine when you come to a complete halt and restarts the engine immediately when required, helping to save fuel, especially during urban driving.

LIGHTWEIGHT MATERIALS

At every stage of the development process, the use of lightweight materials across all the vehicle's elements, has optimised the balance between best vehicle performance and weight saving for greater fuel and emissions efficiency. Discovery adopts an advanced all-aluminium body structure, delivering significantly reduced weight versus traditional materials, improved dynamic performance and enhanced sustainability. Its tailgate is made from a lightweight plastic composite material which is also very stiff and strong, whilst high precision light weight magnesium castings are used for some of the body and chassis components.

ADBLUE®¹

Discovery diesel models are fitted with AdBlue to help clean exhaust gases. AdBlue is a non-toxic, non-flammable, biodegradable additive that cleanses the gases in the vehicle's exhaust system to reduce harmful nitrogen oxide emissions by up to 98 percent.

LOW FRICTION TECHNOLOGIES

Discovery's petrol and diesel engine range uses smart coating technologies on pistons, needle roller bearings and other mechanical parts. This helps to reduce friction, especially at low engine temperatures, so the vehicle performs at its efficient best.

ADVANCED AERODYNAMICS

The modern streamlined design has been carefully optimised using advanced Computational Fluid Dynamics software and a state-of-the-art wind tunnel. This has led to an improvement of up to 15 percent drag reduction when compared to its predecessor whilst still maintaining stadium seating and two additional seats in the optional third row. An enhanced rear spoiler has been designed with slots to direct airflow over the tailgate to minimise rear screen soiling and produce a reduction in drag.

Discovery is the first Land Rover to optimise airflow past the front wheels, by creating an 'air curtain'² by feeding air to the inner wheelarch from ducts in the front bumper. The pressure change in the wheelarch helps to reduce drag and improve air flow down the vehicle's sides.

Vehicles equipped with electronic air suspension benefit from speed lowering where the vehicle automatically lowers by 13mm to reduce drag when cruising at motorway speeds.

¹Features and their availability may differ by vehicle specification and market. ²Only available with Sd4 Ingenium engine.

AdBlue® is a registered trademark of the Verband der Automobilindustrie e.V. (VDA).

Vehicle shown left is HSE Luxury in Silicon Silver.



ON-ROAD DYNAMICS

Discovery has been designed to deliver a confident, comfortable and engaging driving experience to make the miles go by virtually unnoticed.

With its wide-spaced double-wishbone design at the front and advanced multi-link layout at the rear, the suspension delivers more responsive handling without compromising Land Rover's hallmark all-terrain capability.

Dynamic Stability Control (DSC) monitors Discovery's dynamic behaviour, and intervenes if the system determines that the vehicle is not responding according to the driver's inputs.

The DSC system operates by reducing engine torque and/or applying the brakes on selected wheels to correct the vehicle's cornering attitude and in addition can counteract understeer or oversteer conditions effectively. This system is standard on all models.

Discovery's sublime ride quality is heightened further by such features as Electric Power Assisted Steering (EPAS), a variable ratio system and speed sensitive steering. Standard on all models, EPAS is integrated into driver and chassis systems, helping to reduce the engine load to aid efficiency and deliver a confident and intuitive drive.

The variable ratio system has been tuned by Land Rover engineers to provide ease of control, on or off-road, when driving in a straight line or when turning. Different gear ratios within the steering rack help to reduce steering sensitivity when driving straight, but compensate for less steering input when turning.

Speed sensitive steering increases the weight and feel of the steering as your speed increases to give stability and a greater feel of confidence. It also assists you at lower speeds to aid manoeuvrability by lightening the feel of steering. This system is standard on all models.





TECHNOLOGY

INFOTAINMENT

Unique to Land Rover, the InControl infotainment system, Touch Pro not only looks like no other, it performs like no other. Delivering a wealth of information and entertainment, it features the most intuitive and advanced integrated technologies to ensure everyone can make the most of their journey.

Search 'Discovery Infotainment System' for more details.



TOUCH PRO

Touch Pro is our state-of-the-art infotainment system that connects you to your world, delivers a raft of entertainment options and puts all the information in one place. The optional Touch Pro Dual View System¹ is also powered by the 10" high-resolution Touchscreen and allows the driver and passenger to view completely independent display content. For example, the driver can use the Satellite Navigation system, while the front seat passenger is able to watch a DVD or Digital TV², where fitted. One set of WhiteFire® digital wireless headphones is also included.



INTERACTIVE DRIVER DISPLAY

Discovery ensures you're always entertained, informed and connected. It features a 12,3" high-definition Interactive Driver Display³ that can receive and project a vast amount of driving information, entertainment and active safety data including navigation, phone and media. Its high resolution ensures the utmost clarity and its refined processing engine delivers smooth moving pin sharp graphics.



HEAD-UP DISPLAY⁴

Without distraction or the need for you to take your eyes off the road, our enhanced next generation Head-up Display is an option that presents key vehicle data such as your speed, gear position and navigation directions on the windscreen in the most innovative way. It features crystal clear full-colour graphics in high resolution, enabling you to see all driver inputs and information with ease. It can display important information from the Touch Pro Touchscreen including phone as well as information and guidance for off road driving via the All Terrain Info Centre. The feature can be turned on and off dependent on driver preference.



8" REAR SEAT ENTERTAINMENT

The optional Rear Seat Entertainment¹ System provides two 8" screens built into the rear of the front headrests. It includes 'Journey Status', a Navigation Summary screen which displays a pop-up for the rear occupant detailing the time and distance to destination. The system comes with a pair of WhiteFire® digital wireless headphones and HDMI, Mobile High-Definition Link (MHL) and USB connections. Passengers can also enjoy their favourite TV shows via the optional Digital TV feature. Digital TV channels can be watched on the 10" Touchscreen² in the front cabin and the Rear Seat Entertainment screens.

¹Optional on HSE and HSE Luxury. ²Digital TV can only be viewed on the 10" Touchscreen when the vehicle is stationary.

³Standard on HSE and HSE Luxury. Optional on S, SE and Landmark Edition with Navigation. ⁴Requires solar attenuating windscreen in some markets.

All in-car features should be used by drivers only when safe for them to do so. Drivers must ensure they are in full control of the vehicle at all times.

Interior shown is HSE Luxury in Light Oyster/Espresso.

AUDIO

A vehicle's cabin is the ideal place within which to experience your personal choice of music and Discovery has the option of four different audio systems to bring your music to life:

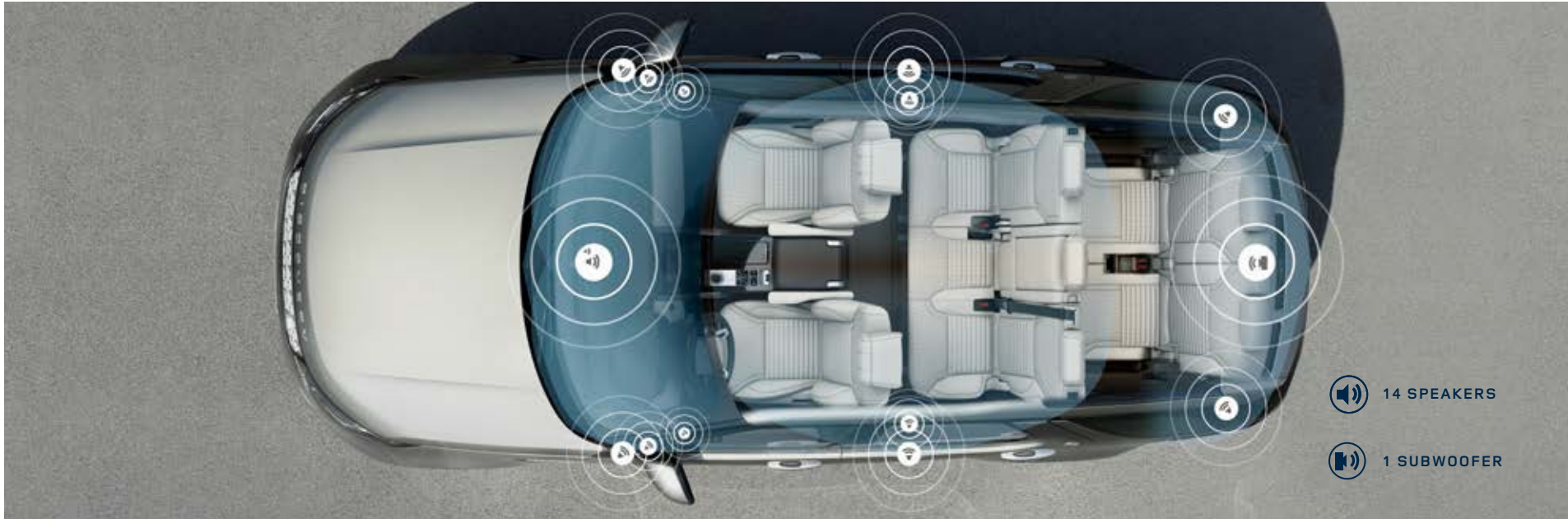

SOUND SYSTEM

Excellent acoustic range through six speakers and is standard on S models.

ENHANCED SOUND SYSTEM

The 250W Enhanced Sound System features 10 speakers and is standard on SE models and available as an optional upgrade on S models.

MERIDIAN™ SOUND SYSTEM

Great definition, crystal clear highs and full, deep bass - delivered through this 380W system's careful arrangement of 10 speakers and a dual channel subwoofer. It is standard on HSE and Landmark Edition and available as an optional upgrade on S and SE models.

MERIDIAN SURROUND SOUND SYSTEM

All the fullness and clarity of a live performance delivered through an arrangement of this 825W system's 14 front, side and rear speakers and a dual-channel subwoofer - seamlessly brought together using Trifield™ technology and exclusive to Meridian, Trifield perfectly blends the centre and surround channels with left and right channels ensuring an optimum, consistent sound experience for each passenger. It is standard on HSE Luxury models and available as an optional upgrade on HSE models.

DAB RADIO

DAB radio technology offers improved sound quality, a wide choice of stations and live text information about the station, show and song you are listening to. It is standard on all models.

MERIDIAN™

Formed in 1977 in Cambridgeshire, England, Land Rover's audio partner Meridian has pioneered many firsts including active speakers and the world's first digital surround sound processor.

Meridian's audio technology input has helped ensure that Discovery is the most superb space within which to experience sound. Meridian Cabin Correction technology was utilised to analyse cabin shape, acoustics and resonance characteristics in order to help remove unwanted sounds.

The advanced algorithm ensures that the rhythm, punch and timing of any piece of music are heard precisely how the artist intended, providing a consistently exceptional quality audio experience for all passengers in the vehicle.



DIGITAL SIGNAL PROCESSING

Brings all elements of the audio system together as one, for performance that would otherwise require significantly larger speakers.



MERIDIAN CABIN CORRECTION

The advanced algorithm of Meridian's Cabin Correction tailors the sound experience to the precise acoustics of Discovery's interior.









MERIDIAN DIGITAL DITHER SHAPING

To maintain the quality of musical recordings, they are converted into a common digital format. Meridian Digital Dither Shaping ensures that digital signal conversions are made smoothly and seamlessly, preserving the finest details of the audio performance. The result is authentic musical conversion, evoking the emotions of the original recording.



TRIFIELD™

Exclusive to Meridian, Trifield blends the centre and surround channels seamlessly with left and right channels, delivering a consistent, concert-like experience for all occupants.

	UNIQUE MERIDIAN TECHNOLOGY	SPEAKERS	DUAL-CHANNEL SUBWOOFER	WATTS
SOUND SYSTEM	N/A	6	N/A	125
ENHANCED SOUND SYSTEM	N/A	10	N/A	250
MERIDIAN™ SOUND SYSTEM	  	10	1	380
MERIDIAN™ SURROUND SOUND SYSTEM	   	14	1	825

Meridian is a registered trademark of Meridian Audio Ltd.
Trifield and the "three fields" device is a trademark of Trifield Productions Ltd.
Features and their availability may differ by vehicle specification and market.



CONNECTIVITY

InControl is Land Rover's suite of standard and optional features that connects you to your vehicle and links you seamlessly, and securely, with the outside world. Select from the available packs, that can be further enhanced by our individually offered feature, Secure Tracker. With a selection of apps, even when you're away from your vehicle, some of the InControl features stay with you, making sure the Land Rover experience is more enjoyable than ever.

Search 'Discovery Technology' for full details.

OPTIONAL FEATURES

VOICE RECOGNITION SYSTEM

Understands clear spoken instructions, so you can concentrate on the road ahead without any distractions. Voice Recognition is a standard feature with Navigation Pro.

NAVIGATION PRO

Available as an option on S and fitted as standard on SE, HSE, HSE Luxury and Landmark Edition, Navigation Pro allows you to save your favourite places, use pinch-to-zoom gestures for simple map exploration and can display a choice of either 2D or 3D crystal clear map graphics. Navigation Pro functionality is further enhanced by Connect Pro.

CONNECT PRO PACK*

Connect Pro consists of 4G Wi-Fi Hotspot, and Pro Services, and is designed to enhance your in-car and out-of-car experience, ensuring you and your passengers enjoy the journey whilst remaining connected to the world.

Pro Services include:

- **Real Time Traffic Information** - Uses live traffic data feeds to give you the most accurate picture of what the traffic is like on the way to your destination.
- **Online Search** - Wherever you are, you can search the surrounding area for places of interest. The system can access expert destination information, travel tips and inspiration as well as online travel reviews of the local area.
- **Planning Routes and Door-to-Door Routing** - Before setting off, use the optional Route Planner app or online portal to search, save locations or set your destination. The app uses the Cloud to send your destination automatically to your vehicle's navigation screen. Once you've parked, the Route Planner app will guide you to your destination - a true door-to-door experience which includes public transport options.
- **Share ETA** - You can share your estimated time of arrival so your selected contact(s) will know exactly when you will arrive, as calculated by the navigation guidance system. If you're running late, Share ETA can then send automatic updates via text messages or email, without any further action from you.
- **Satellite View** - There may be times when you want to get the context of your surroundings from overhead. With Connect Pro you can switch to satellite view with a single tap.

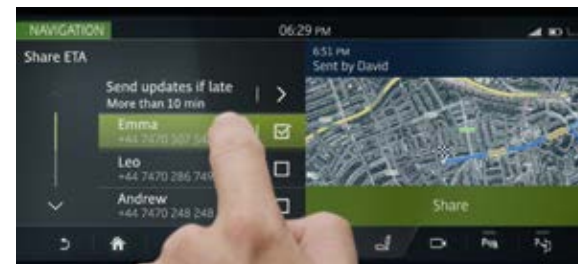
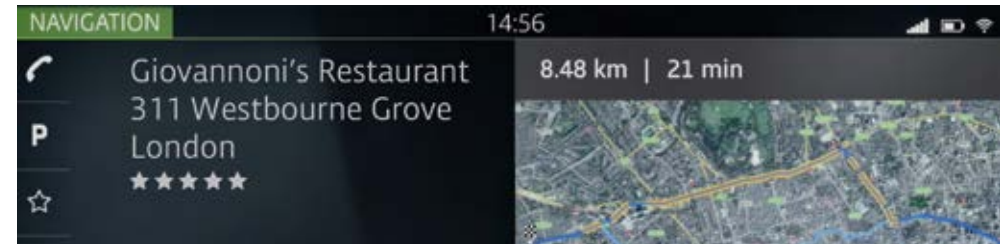

*Connect Pro requires a SIM with a suitable data contract. Online functionality and Wi-Fi connectivity is dependent on the installation of a micro SIM with a suitable data contract. Remote Premium contains subscription services that can be extended after the initial term advised by your Land Rover Retailer. InControl features, options and their availability remain market dependent - check with your Land Rover Retailer for local market availability and full terms. Information and images displayed in relation to the InControl technology, including screens or sequences, are subject to software updates, version control and other system/visual changes depending on options selected. Mobile network connectivity cannot be guaranteed in all locations.

All in-car features should be used by drivers only when safe for them to do so. Drivers must ensure they are in full control of the vehicle at all times.

OPTIONAL FEATURES CONTINUED

CONNECT PRO PACK CONTINUED

- **Commute Mode** - Allows the system to learn your commutes and automatically advises you of the expected journey time based on live and historical traffic movements without you having to input a destination. The system learns the routes you take for a given destination and then advises which of those is the quickest.
- **Parking Service** - As you approach your destination, you can see where parking is available. Simply tap on your preferred car park and the navigation system updates to direct you to it.
- **Online Media** - Allows for the aggregation of numerous content providers and their personalised content - such as Deezer and TuneIn - that gives access to more than 40 million music tracks and four million on-demand programmes and podcasts. For the first time, these can be directly streamed from the vehicle without the need for a smartphone - providing a seamless and integrated experience.

Remote Premium¹ app provides upgraded information on your vehicle and enables you to interact with it remotely. Compatible with most smartphones, Android Wear™ or the Apple Watch®, this service includes:

- **Remote Lock/Unlock** - Lock or unlock your doors remotely with the click of a button.
- **Remote Climate** - Prepare your Land Rover in advance by pre-heating or pre-cooling the cabin, so that you and your passengers are comfortable from the moment you step inside.
- **Beep/Flash** - This feature turns on your Land Rover's hazard lights, dipped headlights and sounds an audible alert to help you locate your vehicle in a crowded car park.
- **Journey Tracking** - This opt-in feature can automatically record your journey history including your route and mileage statistics. This information can be exported by email to use for expense reporting.
- **Vehicle Status Check** - Check current fuel level and range, and status of door and window position and locks. See the last parked location of the vehicle and find your way back to it with on-foot directions.

PROTECT

Land Rover Optimised Assistance² - If you break down you can make a direct call to the Land Rover Assistance team by pressing the button on the overhead console or from the Assistance screen within the InControl Remote smartphone app.

SOS Emergency Call - In a more serious incident, SOS Emergency Call will automatically connect you to the emergency response team who will notify the emergency services to your location. For peace of mind, this service is provided for the first ten years from date of registration.

SECURE TRACKER³

Uses tracking technology to alert you to an attempted theft, and signals your vehicle's location to the relevant authorities, for a timely recovery. Includes service subscription for warranty period.

¹Remote Premium contains subscription services that can be extended after the initial term advised by your Land Rover Retailer. ²Land Rover Optimised Assistance is a subscription service that can be extended after the initial term advised by your Land Rover Retailer. ³Secure Tracker will require further subscription after the initial term as advised by your Land Rover Retailer. Requires mobile network connectivity.

InControl features, options and their availability remain market dependent - check with your Land Rover Retailer for local market availability and full terms. Information and images displayed in relation to the InControl technology, including screens or sequences, are subject to software updates, version control and other system/visual changes depending on options selected. Mobile network connectivity cannot be guaranteed in all locations. Remote App will need to be downloaded from the Apple/Play Store.

SMARTPHONE PACK

By screen sharing with Land Rover Discovery's InControl infotainment system, the Smartphone Pack helps you stay safely connected to your smartphone even while in the car. Applications include:

- **Android Auto™** - was designed with safety in mind. With a simple and intuitive interface, it is designed to minimise distraction so that you can stay focused on the road. Simply connect your Android smartphone via a USB and control compatible apps on the in-car Touchscreen.
- **Apple CarPlay®** - is also designed for increased safety, enabling the use of apps while allowing the driver to concentrate on the road ahead. Connect your Apple smartphone to your car to use compatible apps such as maps, messages and music through the Touchscreen.





INTERIOR POWER POINTS

Discovery is packed with the latest innovative technologies and USB charging points are available for all three rows of seats. So no matter where they sit, every single passenger can stay entertained; whether on their tablets, mobile phones or other devices¹.

It includes a 12V port in the upper glovebox, one in the instrument panel, a USB port in the centre console, one 12V and two USB ports in the cubby box, up to two 12V or USB ports in rear centre console, two USB ports in the row three stowage, one 12V in the luggage compartment, and two additional USB ports when 8" Rear Seat Entertainment is fitted.

A Wi-Fi Hotspot system is also available as part of the Connect Pro Pack². It comes as standard on SE, HSE, HSE Luxury and Landmark Edition, and is available as an optional upgrade on S models.



¹Fitment of USB ports and 12V locations varies by trim level. ²Only available with Navigation Pro. Online functionality and Wi-Fi connectivity is dependent on the installation of a micro SIM with suitable data contract. 4G Wi-Fi Hotspot and Pro Services contain subscription services that can be extended after the initial term advised by your Land Rover Retailer.

Interior shown is HSE Luxury in Light Oyster/Espresso.

DRIVING TECHNOLOGY

DRIVER ASSISTANCE

EASIER AND SAFER

From negotiating city traffic or the motorway to providing additional safety for you and your passengers, you'll find a range of features designed and engineered to heighten your enjoyment of the vehicle.

Discovery offers the most advanced technologies to deliver intuitive and easy parking solutions. Whether reversing, parallel parking or getting into or out of tight spaces, these features make life easier.

Available as standard, optional or as part of an optional pack.

Search 'Discovery Driver Assistance' for more details.

STANDARD



Front and Rear Parking Aid

Front and Rear Parking Aid helps make manoeuvring even easier. When you select Reverse, or choose to activate them manually, sensors located in the front and rear bumpers are triggered. As you park, the Touchscreen display and audio feedback indicates how close you are to obstacles.

Rear Camera provides improved visibility when reversing. This valuable parking aid also helps when hitching a trailer. Static lines representing the vehicle's outer perimeter and predicted path are superimposed on the rearward image, to make parking in tight spots as easy as possible.

Cruise Control with Speed Limiter¹ allows the driver to maintain the current speed of the vehicle without the need for continued use of the accelerator pedal, helping to reduce driver fatigue. The Speed Limiter will also allow the driver to pre-set a maximum specified speed which the vehicle will not exceed. Both functions can be easily turned on or off by the driver as desired.

Driver Condition Monitor detects if you're starting to feel drowsy and gives you an early warning when you need to take a break.

¹Standard on S, SE and Landmark Edition.

All in-car features should be used by drivers only when safe for them to do so. Drivers must ensure they are in full control of the vehicle at all times.

STANDARD



Lane Keep Assist

Lane Keep Assist detects when your vehicle is unintentionally drifting out of your lane, and applies a corrective torque to the steering wheel, encouraging you to guide your vehicle back.

Adaptive Cruise Control² will keep your vehicle a safe distance from the one in front should it slow or stop when you're cruising on the motorway or travelling in slow-moving traffic. Should the vehicle in front stop completely, your vehicle will come to a smooth halt. In stop-start traffic, Adaptive Cruise Control will automatically resume following the car in front. The system can be activated from 20km/h and once activated will operate between 0-200km/h.

Emergency Braking can help to prevent collisions with other vehicles or pedestrians. If a potential frontal collision is detected, a warning is displayed giving you time to take action. A camera at the front of the vehicle monitors at speeds from 5km/h to 80km/h for frontal collisions and 5km/h to 60km/h for pedestrians. If a collision is still anticipated and you have taken no action, this system will apply the brakes to help reduce the severity of the possible impact.

OPTIONAL



360° Surround Camera

360° Surround Camera uses four digital cameras discretely placed around the vehicle, providing a 360° overhead view on the Touchscreen. With the capacity to display several different views at the same time, this helps with various manoeuvres from parking by a kerb, to getting in and out of tight spaces and junctions.

Blind Spot Assist³ can help you prevent collisions. If your vehicle detects another car in your blind spot when you begin to change lanes, a small warning light illuminates in the corresponding wing mirror. Corrective torque is also applied to the steering wheel, encouraging you to guide your vehicle away from the approaching vehicle.

²Standard on HSE and HSE Luxury models. ³Optional on S, SE and Landmark Edition. Standard on HSE and HSE Luxury models.

OPTIONAL PACKS

Optional packs are available featuring a range of technologies to enhance the driving experience. Park Pack enables you to park and manoeuvre safely and more easily in and out of tight spaces and into traffic that is obscured by buildings or other vehicles. While Drive Pack makes every journey safer and more relaxing. The Drive Assist Pack contains the most comprehensive suite of drive and park technologies.

PARK PACK¹



Park Assist

Park Assist makes parallel and perpendicular parking easier than ever by steering your vehicle into a suitable space. You just have to select the appropriate gear and control the vehicle's speed with the brake and accelerator pedals. Graphics and notifications guide you through the manoeuvres. Park Assist will also steer you out of a space, taking all of the stress out of parking.

Rear Traffic Monitor is particularly useful when reversing out of a parking bay. The system warns you of vehicles, pedestrians or other hazards, approaching from either side of your vehicle and will alert you with both audio and visual warnings so you know what's behind you even when the view is obstructed.



360° Parking Aid

360° Parking Aid gives you complete confidence when manoeuvring in tight spaces. Sensors located around the vehicle are automatically triggered when Reverse is selected, or can be manually activated, with a graphic appearing on the Touchscreen showing an overhead view of the vehicle. As you park, the Touchscreen display and audio feedback indicate how close you are to obstacles.

Clear Exit Monitor alerts passengers leaving the vehicle from the rear doors to any approaching cars, cyclists or other hazards. If an incoming obstacle is detected, a warning light will flash on the door.

DRIVE PACK²



Adaptive Cruise Control

Adaptive Cruise Control See page 49 for description.

High-Speed Emergency Braking detects when a potential frontal collision with another vehicle may occur and displays a forward alert to warn the driver to brake. If the driver doesn't react, the vehicle will deploy the brakes in order to reduce the severity of the possible impact. High-speed Emergency Braking is ready and active from 10km/h to 160km/h.



Blind Spot Assist

Blind Spot Assist See page 49 for description.

Traffic Sign Recognition and Adaptive Speed Limiter keeps you informed and aware on the road, by displaying speed limits and no overtaking signs in the instrument cluster, where they can easily be seen. When activated, Adaptive Speed Limiter uses Traffic Sign Recognition information to adjust your vehicle's speed accordingly.

²Only available on S, SE and Landmark Edition. Standard on HSE and HSE Luxury models.

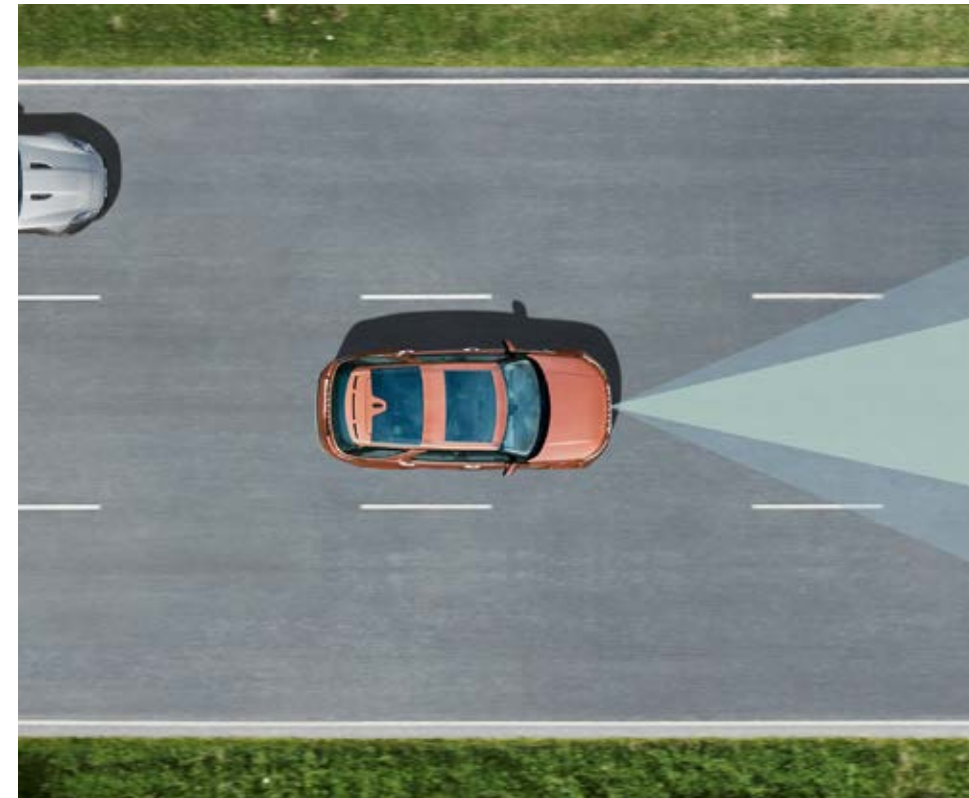

DRIVER ASSIST PACK

The optional Driver Assist Pack offers a wide range of driver aids including the features found in both the Park Pack and Drive Pack (see pages 50 and 51) together with 360° Surround Camera, Park Assist, 360° Parking Aid, Rear Traffic Monitor and High Speed Emergency Braking. It also includes Adaptive Cruise Control with Steering Assist which centres the vehicle in lane and maintains a set distance from vehicles ahead, making driving even easier and more comfortable.

FRONT CAMERA 120m

FRONT RADAR 160m

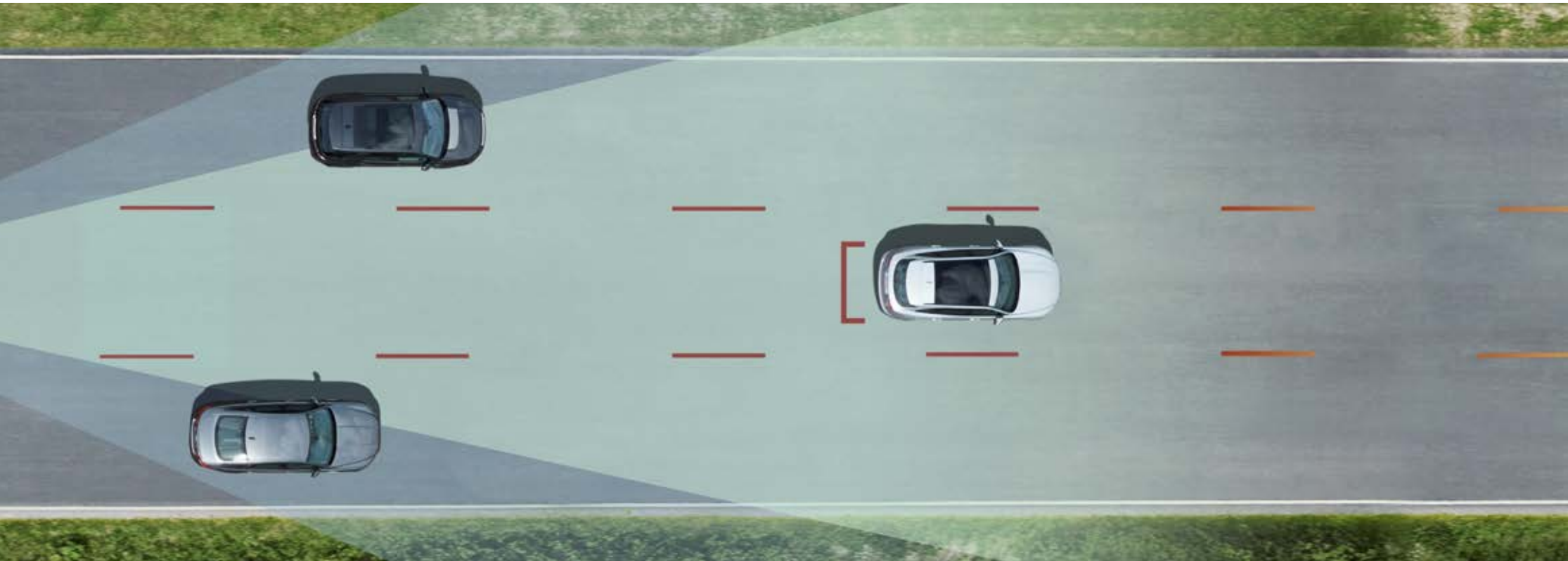

ADAPTIVE CRUISE CONTROL WITH STEERING ASSIST

Adaptive Cruise Control with Steering Assist works with you, assisting with steering, braking and acceleration as you keep your hands on the wheel and anticipate the road ahead. A camera and radar then work together to track lanes ahead to maintain a central position for your vehicle, and moderate its speed according to the behaviour of the traffic in front of you.

If the vehicle ahead slows, even to a standstill - the feature automatically slows your vehicle, bringing it to a stop where necessary to maintain a relaxed and composed drive in busy traffic situations. Should you remove your hands from the wheel, the vehicle will provide a warning. If the warning is not heeded then the Steering Assist is deactivated, but the Adaptive Cruise Control will remain active.

DRIVING AIDS



LOW TRACTION LAUNCH

Discovery features a dedicated launch function¹, which enables the vehicle to pull away smoothly and easily, even on tricky low-friction surfaces like ice, snow or wet grass. The software adapts the system's behaviour according to the current Terrain Response setting. When you pull away, you do so with certainty, composure and greater ease.

¹Low traction launch features as standard on SE, HSE, HSE Luxury and Landmark Edition. Standard on S models when specified with optional Navigation Pro. Vehicle shown is HSE Luxury in Namib Orange.



ALL TERRAIN INFO CENTRE



The All Terrain Info Centre² within your navigation system allows you to view and activate various features and provides access to All Wheel Drive (AWD) information and guidance features for off-road driving.

The Touchscreen displays information about the vehicle's wheels, suspension, transmission and driveline including suspension movements and articulation for vehicles with electronic air suspension.

The system can show the angle and pitch of the vehicle on slopes and inclines, advice on the vehicle's current and maximum wading depth and includes a useful compass together with current latitude, longitude and altitude details.

The Info Centre provides a host of other helpful guidance such as vehicle dimensions, useful for entering tighter spots and can be used to activate additional capability features, such as low traction launch.

Using the optional 360° Surround Camera, the Info Centre can also show the area directly ahead of the vehicle that may not be visible to the driver to help ensure the vehicle isn't damaged on unseen terrain.

²The number of features displayed on the All Terrain Info Centre is dependent upon the specification of the vehicle.
Interior shown above is the HSE Luxury in Light Oyster/Espresso.

TOWING AIDS

Discovery takes towing capability to a new level, with a capacity of up to 3.500kg* and a suite of features available to help make towing effortless and assured.

1 ELECTRICALLY DEPLOYABLE TOW BAR

Discovery has the option of an electrically deployable tow bar on SE, HSE, HSE Luxury and Landmark Edition. This is deployed using a convenient button in the loadspace compartment, or via the Touchscreen.

2 TOW HITCH ASSIST

Tow Hitch Assist makes coupling a trailer to the vehicle much easier by helping you visualise the hitching process; it displays the predicted path of the vehicle tow ball towards the trailer tow bar on the Touchscreen. Standard with 360° Surround Camera.

3 NOSE LOAD MEASUREMENT

HSE and HSE Luxury vehicles fitted with the electrically deployable tow bar feature Nose Load Measurement which allows you to quickly and easily measure the nose load of your trailer. This system can be operated via the Touchscreen.

4 REAR HEIGHT ADJUST

Rear Height Adjust allows the use of switches in the loadspace or on the key fob to lower the rear ride height - useful when loading or unloading cumbersome items, or when hitching, unhitching or loading a trailer. This feature is standard when electronic air suspension is specified.

5 TRAILER LIGHT TEST

This industry-first feature enables you to test your trailer lights without leaving your vehicle. When an optional electrically deployable tow bar is fitted, the automatic system is used to pulse the lights in a sequence, and is triggered via the Touchscreen or a button in the loadspace compartment.

6 TOW ASSIST

On the road, the Tow Assist feature helps with reversing by predicting the trailer's direction. You can even choose your trailer's width for precise guidelines displayed on the Touchscreen. Standard with 360° Surround Camera.

*Maximum towing capacity is limited to 2.500kg and nose weight to 100kg when the 20" aerodynamic wheel (031GJ) is fitted to 7-seat variants. Towing feature compatibility may be affected by trailers equipped with LED lights. Please consult your nearest Land Rover Retailer for more information. Towing features and regulations vary by market. Please ensure you comply with relevant legislation in your country. Features and their availability may differ by vehicle specification and market. Vehicle shown is HSE Luxury in Namib Orange.





1

2

4

3

6

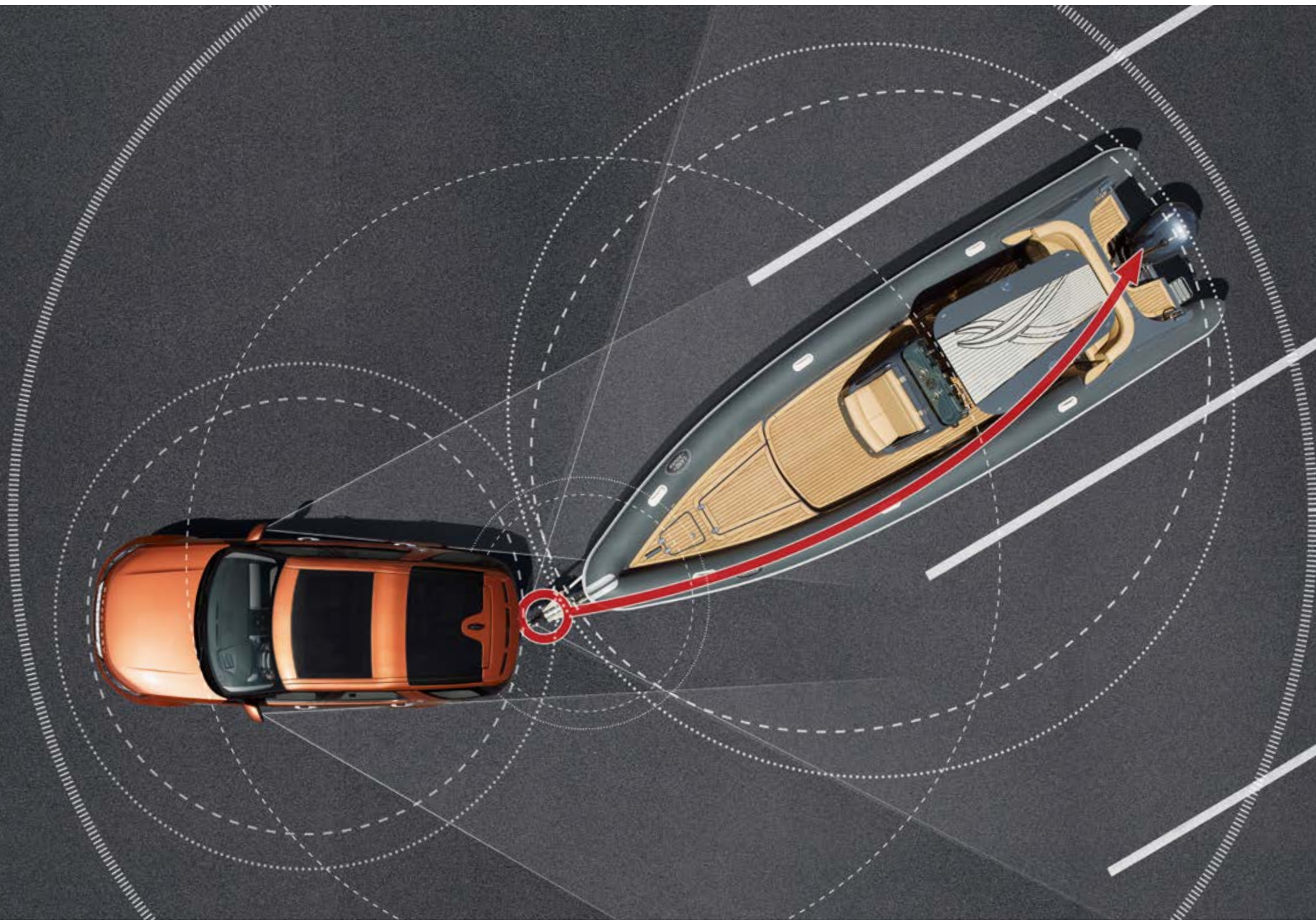



ADVANCED TOW ASSIST

Discovery features our most advanced trailer reversing aid to date. Advanced Tow Assist enables the driver to guide a trailer into position by simply following its trajectory on the main Touchscreen, and controlling its path using the rotary knob from the Terrain Response 2 system on the centre console. This is much more intuitive than using the steering wheel because within one field of vision it effectively steers the trailer along the desired path. This is rather than the opposing direction method which is what happens with conventional steering.

In addition to significantly reducing driver workload, the feature enhances manoeuvrability and safety when reversing, and will alert the driver when approaching a jack-knife situation.

Advanced Tow Assist is only available with electronic air suspension, twin-speed transfer box (high/low range), All Terrain Progress Control, 360° Surround Camera, 360° Parking Aid and Terrain Response 2. A Land Rover approved tow bar is required in order to enable this feature. Only available with Sd4 Ingenium engines and Sd6 engines. Not available with S models.



360° SURROUND CAMERA

For a complete, all-round view, the optional 360° Surround Camera incorporating T-Junction View helps to see everything clearly on the high-resolution full-colour Touchscreen. Using four digital cameras discreetly placed around the vehicle, the system provides an almost complete 360° view including a birds-eye overhead view. It is perfect for more complex driving assignments such as towing a yacht or a horsebox, as features such as Hitch and Load Assist work seamlessly through this system. Along with the ability to display several different views at the same time, this technology can also zoom and pan, ensuring objects and angles, normally below the line of sight, can be seen.

TRAILER STABILITY ASSIST

Trailer Stability Assist (TSA) is a standard feature that monitors the vehicle to detect movements in the trailer and then uses selective braking to help correct potentially hazardous situations.

Towing feature compatibility may be affected by trailers equipped with LED lights. Please consult your nearest Land Rover Retailer for more information. Towing features and regulations vary by market. Please ensure you comply with relevant legislation in your country. Vehicle shown is HSE Luxury in Namib Orange.



COMFORT FOR ALL

AUTOMATIC ACCESS HEIGHT

It's always good to arrive in style, so that's why we've introduced Automatic Access Height*. When you pull up at your chosen destination and the ignition is switched off or the seat belts are unclipped, the vehicle lowers by an initial 15mm. Then, as you open the door, it drops to its full access height of 40mm lower, making exit - and entry - that much more relaxed and elegant. The ride height automatically returns to its normal height as you pull away.

HOMELINK® SYSTEM

A universal transmitter fitted to the underside of the interior rear view mirror. This optional transmitter can be programmed to operate up to three home or office wireless controlled systems, such as garage doors, automatic gates, or security lighting. By replacing the individual remote control units normally required for each system, the driver no longer needs to search the car interior for the correct handset when needed.

CABIN AIR IONISATION

This optional nanoe™ technology enhances the well-being of both driver and passengers alike. It improves the air quality within the vehicle cabin by removing allergens, viruses, airborne bacteria and associated odours. It does so by ionising particles in the air, making them attract to and neutralise the air contaminants. It can be switched on or off.

*Standard with electronic air suspension.

HomeLink® is a registered trademark of Gentex Corporation.

Vehicle shown is HSE Luxury in Silicon Silver.





PANORAMIC ROOF

The fixed front and rear panoramic roof¹ or sliding front sunroof and fixed rear panoramic roof², enhances the sense of space in the vehicle's interior and floods it with natural light. This benefits all three rows where specified, as well as providing enhanced views of the surrounding environment.

Importantly, the toughened glass has a dark tint to maintain a comfortable temperature inside the cabin and protect occupants and the interior from the sun's rays. Powered interior blinds are also provided for added comfort when a panoramic roof is specified.

CONFIGURABLE AMBIENT INTERIOR LIGHTING

New levels of ambient refinement and personalisation have been reached with the option of Configurable Ambient Interior Lighting, featuring as standard on HSE Luxury.

This feature allows you to vary the shade, changing the ambience of the cabin to suit your mood. There are five colours in total, ranging from Ice White through to Moon Light and Racing Red.

CLIMATE CONTROL

To ensure that the interior is maintained at the perfect temperature, whatever the weather outside, Discovery features a highly efficient climate control system. The result of an incredibly rigorous development programme, the system has been tested in real-world conditions in temperatures ranging from -40 to +50°C.

Four versions are available, ranging from two-zone manual air conditioning or two-zone automatic systems to a three-zone automatic system, featuring separate temperature controls for driver, front passenger and rear seats. A premium four-zone system is available as an option on all models, which has separate climate controls for driver, front passenger and each side of the rear cabin.

With its independent heating and cooling capability, the four-zone system offers a significant improvement in rear seat luxury, with multiple outlets at face and foot level.

SEATING

Heated front and rear seats are available as an option on S and as part of a pack on SE, HSE, HSE Luxury and Landmark Edition. Optional first-in-class heated third row seats are also available on HSE and HSE Luxury.

No matter the temperature, heated and cooled front and second row outboard seats are also available as an option HSE and HSE Luxury. This enables both the driver and passenger to set their preferred temperature independently and is controlled via the Touchscreen.

For the ultimate comfort, optional massage front seats are available on HSE Luxury allowing both the driver and front passenger to select individual programmes via the Touchscreen. Varying in intensity, there are five settings to choose from; each one delivers a soothing massage to improve both the driver and passenger's comfort.



¹Standard on Landmark Edition. Optional on S, SE, HSE and HSE Luxury.

²Standard on HSE Luxury. Optional on S, SE, HSE and Landmark Edition.

Features and their availability may differ by vehicle specification and market.

Please see pages 86-101, or contact your nearest Land Rover Retailer, for more information.

Interior shown is HSE Luxury in Light Oyster/Espresso with Four-zone Climate Control.





ACTIVITY KEY

Activity Key makes living life to the full even easier. For extra convenience, you can wear the Activity Key if you prefer not to carry a key fob. The wristband is robust and fully waterproof, allowing you to enjoy a range of activities - from sailing to skydiving - and keep your car key with you. Activity Key has been tested in a number of extreme environments and is therefore capable in depths of up to 30m of water and in temperatures ranging from -40°C to +85°C.

You can use the Activity Key to lock and unlock your vehicle. When exiting, you can leave the conventional key fob in it and present the Activity Key to the tailgate to lock it. The conventional key fob is then automatically deactivated for security. Enjoy the Activity Key as an optional feature with SE, HSE, HSE Luxury and Landmark Edition, or as a Land Rover Retailer fit accessory.



Vehicle shown left is HSE Luxury in Silicon Silver.



ENGINES

8-SPEED AUTOMATIC TRANSMISSION

All petrol and diesel engines in Discovery are paired with the advanced electronically controlled 8-speed Automatic Transmission, which has been tuned by Land Rover engineers to combine silky-smooth shifting with exceptionally rapid response. With eight closely spaced ratios, gear changes are almost imperceptible, with each shift completed in just 200 milliseconds.

Controls include steering wheel-mounted paddle shift as standard, enabling the driver to take control of gear shifting manually.

The optimised lightweight 8-speed Automatic Transmission is the perfect partner to the torque-rich petrol and diesel engines, and contributes to their notable fuel efficiency.

The transmission is tuned to select torque converter lock-up as early as possible to reduce slip and energy loss. Transmission Idle Control disengages 70 percent of the drive when the vehicle is stationary and the engine is idling in Drive, significantly reducing fuel consumption in urban conditions.

In cold conditions, the transmission selects a lower gear to promote fast warm up and get the engine up to its efficient operating temperature as soon as possible. For engine availability see page 76.

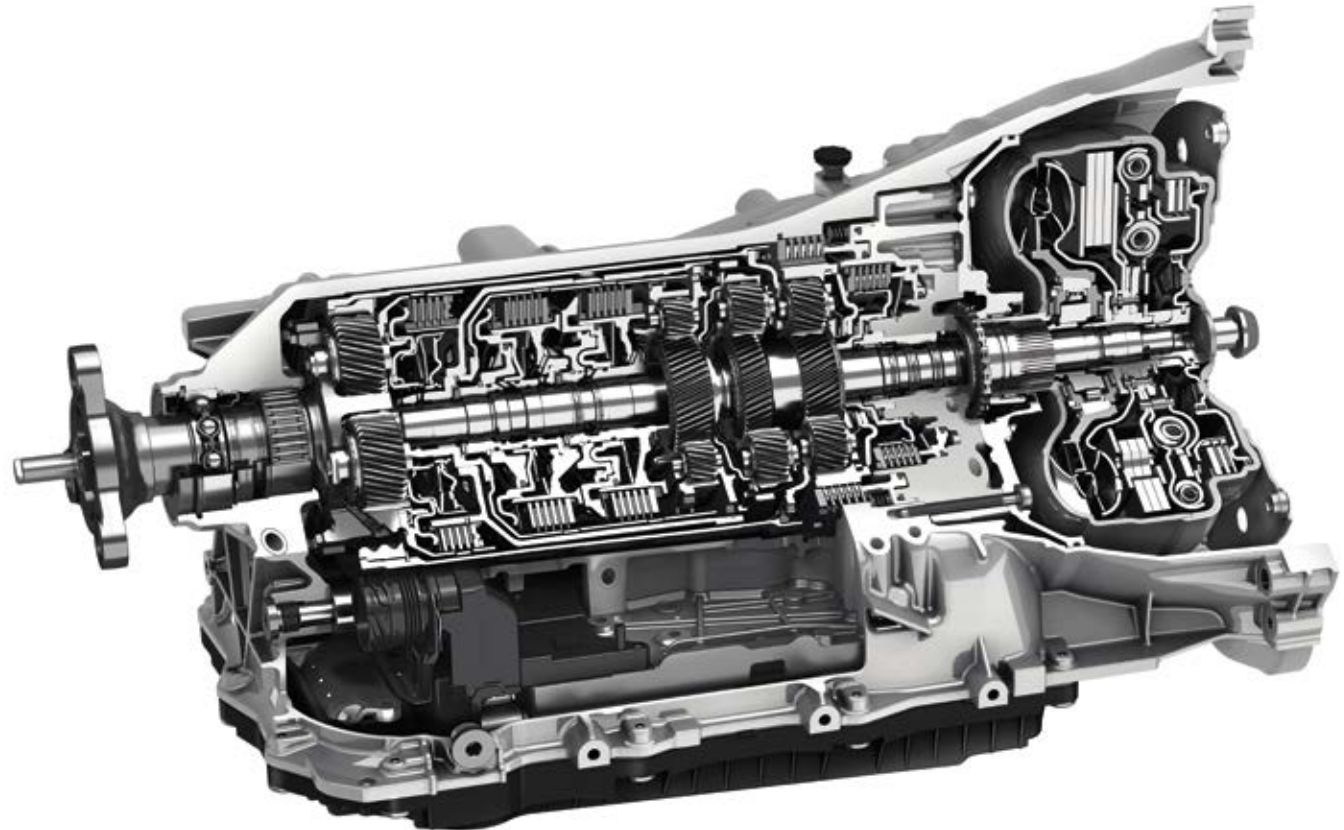

Vehicle shown left is HSE Luxury in Namib Orange.

BODY AND CHASSIS

STRENGTH AND STABILITY

LIGHTWEIGHT CONSTRUCTION

With a state-of-the-art aluminium monocoque body, Discovery enjoys greater levels of performance, together with improved strength, sustainability and efficiency. At up to 460kg lighter than its predecessor* - it also benefits from a 4-cylinder engine which delivers improved fuel economy. Added to which, thanks to utilising the latest in materials and build technologies, the vehicle can readily take the knocks and impacts associated with off-road driving.

STATE-OF-THE-ART LIGHTWEIGHT SUSPENSION ARCHITECTURE

Another key factor in the driving capability of Discovery is the lightweight suspension architecture.

Primarily constructed from lightweight aluminium components, the suspension is fully independent, with a wide-spaced double-wishbone design at the front and an advanced multi-link layout at the rear.

The suspension concept is specifically developed to maximise Discovery's unrivalled breadth of capability, offering responsive and agile handling together with supreme ride quality and refinement.

To see the available suspension options on Discovery please see page 33.

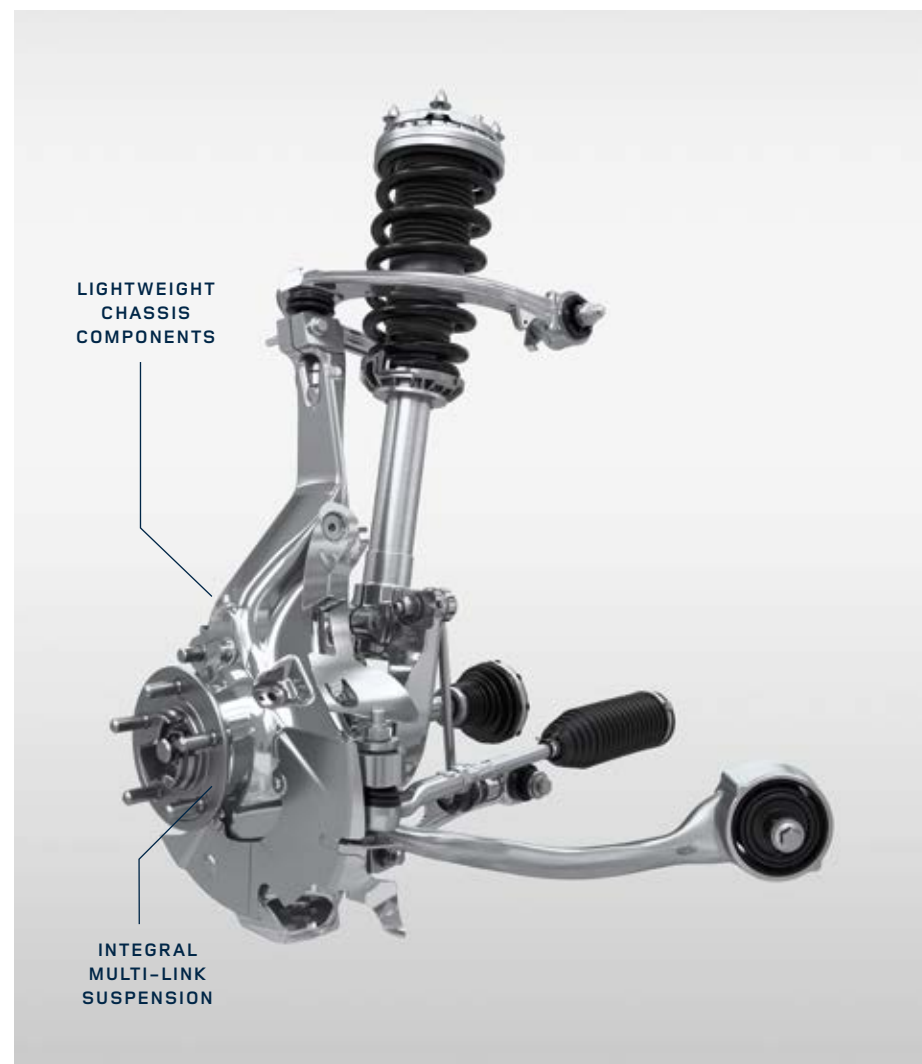



SAFETY

5* EURO NCAP RATING

Discovery has been awarded the maximum five star safety rating from Euro NCAP – the European New Car Assessment Programme. In all variants, including seven-seat models, all seating positions are assessed to ensure a high standard of occupant protection. Discovery also has a comprehensive occupant safety package including driver and passenger airbags, and side curtain and thorax airbags.

OCCUPANT SAFETY PROTECTION

Discovery's optimised aluminium body structure protects occupants using an incredibly strong and stable safety cell. The crash structure is extensively optimised using computer simulation tools which allows engineers to conduct a significant number of 'virtual' crash tests long before physical prototypes are available.

The occupant safety package includes a comprehensive system of airbags and restraint systems including driver and passenger airbags, side curtain and thorax airbags and seat belt pretensioners¹.

Discovery features six airbags as standard and eight airbags when seven seats are specified.

SEAT BELT PRETENSIONERS¹

Acting in conjunction with the airbags, they provide additional protection in the event of a front impact by reducing the forward movement of the occupant.

ISOFIX POINTS

Up to five¹ lower ISOFIX/i-Size mountings and associated top tether anchor points are featured on all three rows of seats². These provide optimum safety for the fixing of child restraints. Please check local market for availability as standard.

CURTAIN AIRBAGS WITH ROLLOVER SENSING

In the event of a side impact or rollover, these are deployed to provide greater protection against head injuries.

DRIVING AND PARKING SAFETY AIDS

Discovery has been designed with safety in mind. There are extensive driving and parking safety aids available including Emergency Braking, Blind Spot Assist, Park Assist and 360° Surround Camera. In addition, LED lights have been cleverly developed to wrap around the side of the vehicle to enable the indicators to be more visible to improve safety. Adaptive LED headlights with signature DRL, available as an option on SE, HSE, HSE Luxury and Landmark Edition, combine practicality with distinctive design. For more relaxed night-time driving, adaptive lighting varies the light cast ahead of the vehicle so that the beams follow the curve of the road.

To see the range of driving and parking safety aids available please see pages 48-53.

PASSENGER SEAT BELT CHECK SYSTEM



¹Front, outboard second row and third row seats only. Front row ISOFIX only available with leather seats.

²Where third row seats are specified.



SAFETY SYSTEMS

- 1** DRIVER AIRBAG
- 2** PASSENGER AIRBAG
- 3** CURTAIN AIRBAGS

- 4** SIDE THORAX AIRBAGS
- 5** AIRBAG DEACTIVATED SWITCH FOR FRONT PASSENGER
- 6** SEAT BELT PRETENSIONERS

- 7** SEAT BELT REMINDER
- 8** ISOFIX/I-SIZE POINTS

Vehicle shown is HSE Luxury in Namib Orange with optional third row seats.





ENVIRONMENTAL

SUSTAINABILITY

Discovery demonstrates Land Rover's continuing commitment to enhancing the sustainable performance of its products and operations and its determination to deliver vehicles that are both relevant and highly desirable. For example, as part of our commitment to reducing our environmental footprint, our Engine Manufacturing Centre in the UK features over 22,000 solar panels - one of the largest roof-mounted solar-arrays in the country.

Discovery has been designed with a life cycle approach, aiming to use fewer resources, more environmentally sustainable materials and minimise the CO₂ emissions over the entire vehicle's life cycle. Its lightweight aluminium structure and optimised powertrains have reduced the environmental impact from material production and development, through to customer use.

Discovery is built in state-of-the-art manufacturing facilities operating to some of the highest environmental standards anywhere in the world. By focusing on innovation and efficiency in every aspect of its processes, for each vehicle built versus 2007 levels the company has achieved a 38 percent* reduction in operational CO₂, water use reduced by 34 percent and achieves zero waste to landfill from manufacturing operations. Investment, commitment and focus in these areas continue to drive further efficiencies. Responsible resource management is integral to the company's long-term sustainability strategy, for example all UK operations are powered by 100 percent renewable, or zero carbon electricity.

*JLR Data 2014/15 vs. 2007.

Vehicle shown is HSE Luxury in Namib Orange.

DISCOVERY OFFERS YOU GREAT
OPTIONS AND FLEXIBILITY TO
PERSONALISE YOUR VEHICLE.

The following pages take you through a logical series of steps to make it suit your lifestyle. There are several choices: from selecting your engine and model to exterior and interior colours, wheels, finishes and those detailed touches to enable you to personalise your vehicle.

If you'd like to bring your options to life, go to our online configurator at landrover.com

76-77

1

**STEP 1
CHOOSE YOUR ENGINE**

You can select from a range of powerful petrol or diesel engines.

78-101

2

**STEP 2
CHOOSE YOUR MODEL
AND OPTIONS**

Compare the standard and optional features on each model. There's also a choice of pack options to personalise your vehicle.

102-105

3

**STEP 3
CHOOSE YOUR COLOUR**

There's a wide range on offer to enable you to express yourself.

106-107

4

**STEP 4
CHOOSE YOUR WHEELS**

There's a range of styles, each one designed to complement the bold exterior.

108-115

5

**STEP 5
CHOOSE YOUR INTERIOR**

When you choose your interior, you can personalise it by selecting your optimum seat configuration, the ideal colour combination of seats, materials and your preferred finisher. These three considerations help celebrate and enhance a sense of your own style.

116-121

6

**STEP 6
CHOOSE YOUR ACCESSORIES**

This range of stylish and practical accessories can be tailored to suit any lifestyle.

1

CHOOSE YOUR ENGINE

WHICH ENGINE IS RIGHT FOR YOU?

Petrol or diesel? Lots of people struggle with this. But the truth is there's no one correct answer. It really depends on what your priorities are and the type of driving you do. Diesel engines are more powerful than petrol engines. They have a higher torque and so give a smoother drive. And they're more fuel-efficient than petrol, particularly out of town on long journeys. On the other hand, the harshness, noise, and vibrations in diesel driven cars are higher than that of a petrol-driven car. Also, the maintenance cost of diesel cars is greater. Petrol cars are generally quieter and cheaper to run on shorter journeys. In a nutshell, if you intend to drive a lot of miles it's worth going for diesel. But if you don't see yourself using your car that much or driving too far, you'll probably be better off with petrol.

Configure your Land Rover Discovery at landrover.com

MODELS BY ENGINE

	S	SE	LANDMARK	HSE	HSE LUXURY
2,0L Sd4 Ingenium Diesel 240PS	■	■	■	■	■
3,0L Sd6 Diesel 306PS	-	■	■	■	■
2,0L Si4 Ingenium Petrol 300PS	■	■	■	■	■

■ Standard □ Optional - Not Available.

INGENIUM DIESEL ENGINE

Sd4 240PS

This is the 240PS high output version of the Ingenium diesel engine. The series sequential twin turbocharged engine delivers an ideal combination of class-leading performance and superior low-speed driveability. The engine features a unique piston design and optimised combustion bowls to support the increase in power and torque output. Solenoid injectors, operating at high pressures up to 2.200 bar with an increased injector flow rate of 32,5 percent, are utilised. These open and close at extremely high speeds with ultimate precision to inject fuel for an effortless and more economical drive

DIESEL ENGINE

Sd6 306PS

The 3,0 litre V6 Twin Turbocharged Diesel engine produces 306PS and 700Nm of torque and is ideal for higher power and torque demand usage with exceptional driveability. The innovative parallel sequential twin turbochargers - a concept pioneered by Jaguar Land Rover - features a ceramic ball bearing on the primary turbo to reduce friction for maximum throttle response. A switchable coolant pump and two-stage oil pump are used for optimal thermal energy management, improving operating efficiency. The piezo common rail fuel injection system enables precise control of the amount of fuel injected creating a uniform mixture for more efficient combustion and less emissions. The engine utilises these technologies to offer premium refinement and performance.

INGENIUM PETROL ENGINE

Si4 300PS

The 2,0 litre 4-cylinder Si4 Petrol engine utilises cutting-edge innovations to enhance every aspect of performance. Technologies such as Continuous Variable Valve Lift system in combination with variable cam timing delivers maximum efficiency, optimising both performance and fuel economy. The 300PS engine produces torque of up to 400Nm at 1.500-4.000 rpm and offers enhanced boosting technology through its turbocharger, featuring ceramic ball bearings and a high flow compressor wheel, an innovation ensuring the best possible launch performance and transient response while still delivering high peak power. The electronically controlled split flow cooling system improves engine warm up, resulting in lower fuel consumption and emissions.

2

EACH MODEL HAS A CHOICE OF UNIQUE FEATURES

This guide will help you to select your ideal Discovery. On the following pages you'll see the standard features for each model.

DISCOVERY S



- Brunel grille with Narvik Black surround
- Narvik Black fender vents
- Body-coloured door handles
- Brunel Discovery script (bonnet and tailgate)
- Anthracite tow eye covers
- Heated door mirrors
- Halogen headlights
- 19" 5 split-spoke 'Style 5021' alloy wheels
- 8-way manual fabric front seats
- Emergency Braking
- Lane Keep Assist
- Cruise Control and Speed Limiter
- Front and Rear Parking Aid
- Rear Camera
- Driver Condition Monitor
- Digital Audio Broadcast (DAB) radio
- Sound System 125W with six speakers
- 10" Touch Pro
- Air conditioning.

DISCOVERY SE



- Contents of S, plus:**
- Ambient Interior Lighting
 - Auto High Beam Assist (AHBA)
 - 360° Parking Aid
 - Park Assist
 - Clear Exit Monitor
 - Rear Traffic Monitor
 - Rain sensing windscreen wipers
 - Automatic headlights.
- Replaces S content:**
- Dark Atlas grille with Narvik Black surround
 - Dark Atlas fender vent ingots with Narvik Black surround
 - Dark Techno Silver tow eye covers
 - Two-zone Climate Control
 - Power fold, heated door mirrors with memory and approach lights
 - LED headlights with signature Daytime Running Lights
 - Enhanced Sound System 250W with 10 speakers.

DISCOVERY HSE



Contents of SE, plus:

- Signature Hi-Line tail lights
- Keyless Entry
- Powered inner tailgate
- Adaptive Cruise Control
- Blind Spot Assist
- High-speed Emergency Braking
- Traffic Sign Recognition and Adaptive Speed Limiter.

Replaces SE content:

- Atlas grille with Narvik Black surround
- Atlas fender vent ingots with Narvik Black surround
- White Silver tow eye covers
- Auto-dimming, power fold, heated door mirrors with memory and approach lights
- 20" 5 split-spoke 'Style 5011' alloy wheels
- Interactive Driver Display
- Meridian™ Sound System 380W with 10 speakers plus a dual-channel subwoofer
- 12-way (10-way electric) memory grained leather front seats.

DISCOVERY HSE LUXURY



Contents of HSE, plus:

- Front fog lights
- Solar attenuating windscreen
- Sliding front sunroof and fixed rear panoramic roof
- Premium carpet mats.

Replaces HSE content:

- Atlas Discovery script (bonnet and tailgate)
- Body-coloured door handles with Atlas surround
- 20" 10 split-spoke 'Style 1011' alloy wheels
- Three-zone Climate Control
- Meridian™ Surround Sound System 825W with 14 speakers plus a dual-channel subwoofer
- Configurable Ambient Interior Lighting
- 16-way (14-way electric) memory Windsor leather front seats.



PERSONALISING YOUR DISCOVERY

NEW DISCOVERY LANDMARK EDITION

Discovery Landmark Edition conveys a strong sense of modernity. From unique Landmark badging to the Dynamic Exterior Design Pack which features Narvik Black accents, each detail of the vehicle exemplifies compelling design. These features are perfectly complemented by 20" 5 split-spoke 'Style 5011' wheels with Gloss Black finish or the optional 21" 5 split-spoke 'Style 5085' Satin Dark Grey wheels with contrast Diamond Turned finish. A fixed front and rear panoramic roof, privacy glass and signature Hi-Line tail lights complete its sleek and contemporary appearance.

The vehicle's interior exudes versatility and sophistication. Features include fabric or optional Grained leather seats in Ebony or Acorn, and an exclusive Aluminium finisher to the fascia and doors - all accentuating its refined and purposeful look. Meridian™ Sound System comes as standard and provides authentic sound for every seat.



Technical Lozenge Aluminium finisher



Unique Landmark badging



Interior shown is Ebony/Ebony with optional Grained leather.



PERSONALISING YOUR DISCOVERY

DYNAMIC DESIGN PACK

Bold. Arresting. Available on HSE and HSE Luxury models, this option allows you to enhance Discovery's recognisable design cues even further.

A unique front bumper design gives the exterior a sportier feel. Narvik Black features include the unique mesh grille, fender vents, Discovery bonnet and tailgate script, tailgate appliqué, and mirror caps to further enhance the appearance.

Carefully selected interior touches add to the impact of the three colourway choices available in Windsor leather, with premium details including contrast stitching and micropiping.

Dark Brushed Aluminium centre stack side rails and the distinctive Titanium Mesh trim finisher complete the look. The interior is further enhanced with bespoke premium carpet mats, Bright finish paddle shift and aluminium sport pedals. Please refer to page 97 for Dynamic Design Pack options.

To complement the Dynamic Design Pack, choose from our optional Designer's Choice 21" Satin Dark Grey or 22" Satin Dark Grey with contrast Diamond Turned finish alloy wheels, with the option to add a contrast roof* (see image on the left for an example). Other optional wheels are also available. See pages 106-107 for details.



Tailgate appliqué



Ebony seat with Light Oyster contrast micropiping

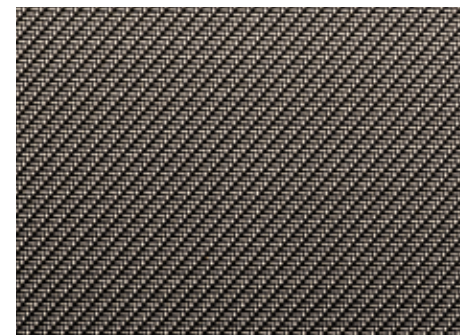

Titanium Mesh trim finisher



Optional alloy wheels in Satin Dark Grey with contrast Diamond Turned finish

*Contrast roof colour is dependent on exterior paint colour. Please refer to pages 102-105 for availability. Body-coloured roofs are also available.



PERSONALISING YOUR DISCOVERY

BLACK DESIGN PACK

For a striking effect Discovery can be personalised with the optional Black Design Pack on SE, HSE and HSE Luxury. The Black Design Pack is available with all exterior colour options and includes a Narvik Black grille, fender vents and mirror caps, with Black 'DISCOVERY' bonnet and tailgate script.

To complement the Black Design Pack, choose from our optional Designer's Choice 20", 21" and 22"* Gloss Black alloy wheels. Other optional wheels are also available. See pages 106-107 for details.



Narvik Black grille



Optional Gloss Black alloy wheels



Narvik Black mirror caps



Narvik Black fender vents

*22" wheels only available on HSE and HSE Luxury models.

STANDARD AND OPTIONAL FEATURES

Engine Transmission, Suspension and Driving Dynamics

	OPTION CODE	2,0L Sd4	3,0L Sd6	2,0L Si4	DESCRIPTION
8-speed Automatic Transmission		■	■	■	Please refer to page 67.
Single-speed transfer box (high range only)		■	-	■	
Twin-speed transfer box (high/low range)	043BF	□(1)	■	-	Please refer to page 33.
Coil suspension (five seat only)		■	-	■	Please refer to page 33.
Electronic air suspension	027BY	□(1)(2)	■	□	Please refer to page 33.
Active Rear Locking Differential (3) (4)	027DB	□	□	-	Please refer to page 33.
Manual centre differential		■	-	■	Standard fitment with single-speed transfer box (high range) only.
Electronic centre differential		□(1)	■	-	Standard fitment with twin-speed transfer box (high/low range) only.
Terrain Response 4-mode		■	-	■	Please refer to page 29.
Terrain Response 5-mode (including Rock Crawl mode)		□(3)	■	-	Please refer to page 29.
Terrain Response 2 (3) (4)	088IA	□(1)	□	-	Please refer to page 29.
All Terrain Progress Control (ATPC) (4) (5)	095CB	□	□	-	Please refer to page 29.
Adaptive Dynamics	027CW	□(6)	□(7)	-	Please refer to page 33.
Stop/Start technology		■	■	■	Please refer to page 35.
Emergency Braking		■	■	■	Please refer to page 49.
Hill Descent Control (HDC)		■	■	■	Please refer to page 30.
Anti-lock Braking System (ABS)		■	■	■	
Electric Power Assisted Steering (EPAS)		■	■	■	Please refer to page 36.
Electronic Traction Control (ETC)		■	■	■	
Hill Launch Assist		■	■	■	Please refer to page 30.
Dynamic Stability Control (DSC)		■	■	■	Please refer to page 36.
Roll Stability Control (RSC)		■	■	■	
Electric Parking Brake (EPB)		■	■	■	
Emergency Brake Assist (EBA)		■	■	■	
Electronic Brake-Force Distribution (EBD)		■	■	■	
Gradient Acceleration Control (GAC)		■	■	■	
Trip computer		■	■	■	
Emergency stop signal		■	■	■	

■ Standard □ Optional - Not Available.

Exterior Features and Finishers

	OPTION CODE	S	SE	LANDMARK	HSE	HSE LUXURY	DESCRIPTION
ROOF AND EXTERIOR DESIGN							
Body-coloured roof		■	■	■	■	■	Please refer to pages 102-105.
Black contrast roof	080AN	□	□	□	□	□	Please refer to pages 102-105.
Sliding front sunroof and fixed rear panoramic roof	041CR	□	□	□	□	■	Includes rear reading lights. Please refer to page 63.
Fixed front and rear panoramic roof	041CS	□	□	■	□	△	Includes rear reading lights. Please refer to page 63.
Black roof rails	060AW	□	□	□	□	□	
Silver painted roof rails	060BC	□	□	□	□	□	
Brunel grille with Narvik Black surround		■	-	-	-	-	
Narvik Black fender vents (8)		■	-	■	-	-	
Dark Atlas grille with Narvik Black surround		-	■	-	-	-	
Dark Atlas fender vent ingots with Narvik Black surround		-	■	-	-	-	
Narvik Black grille with Narvik Black surround		-	-	■	□	□	
Atlas grille with Narvik Black surround		-	-	-	■	■	
Atlas fender vent ingots with Narvik Black surround		-	-	-	■	■	
Body-coloured door handles		■	■	■	■	□ (9)	
Body-coloured door handles with Atlas surround		-	-	-	-	■	
Gloss Black tailgate finisher		■	■	■	■	■	
Brunel Discovery script (bonnet and tailgate)		■	■	-	■	-	
Narvik Black Discovery script (bonnet and tailgate)		-	-	■	□	□	
Atlas Discovery script (bonnet and tailgate)		-	-	-	-	■	
Anthracite tow eye covers		■	-	-	-	-	
Dark Techno Silver tow eye covers (8)		-	■	-	-	-	
Indus Silver tow eye covers		-	-	■	□	□	
White Silver tow eye covers		-	-	-	■	■	

■ Standard □ Optional △ No Cost Option - Not Available.

(8) Standard as part of Black Design Pack. (9) Standard as part of Dynamic Design Pack and Black Design Pack. Replaces body-coloured door handles with Atlas surround.

STANDARD AND OPTIONAL FEATURES

Exterior Features and Finishers (continued)

	OPTION CODE	S	SE	LANDMARK	HSE	HSE LUXURY	DESCRIPTION
GLASS AND EXTERIOR MIRRORS							
Acoustic laminated windscreen		■	■	■	■	■	
Heated rear window with rear wash wiper		■	■	■	■	■	
Door puddle lights		■	■	■	■	■	
Heated windscreen (1)	040AK	□	□	□	□	□	
Heated washer jets (1)	040AQ	□	□	□	□	□	
Solar attenuating windscreen	047EB	□	□	□	□	■	This is a fine metallic coating made up of several layers of titanium and silver to create an infrared reflective coating, keeping the vehicle cooler in hot conditions.
Privacy glass	047DB	□	□	■	□	□	Provides increased privacy for rear passengers by restricting vision into the cabin.
Rain sensing windscreen wipers	030CQ	□(2)	■	■	■	■	
Heated door mirrors		■	-	-	-	-	
Power fold, heated door mirrors with memory and approach lights	030NM	□	■	■	-	-	
Auto-dimming, power fold, heated door mirrors with approach lights	030NL	□	□	□	■	■	
TOWING							
Trailer Stability Assist (TSA) (3)		■	■	■	■	■	Please refer to page 59.
Front and rear recovery hooks		■	■	■	■	■	
Advanced Tow Assist (3) (4)	062CE	-	□	□	□	□	Please refer to page 59.
Detachable tow bar	028EM	□	□	□	□	□	
Electrically deployable tow bar	028EJ	-	□	□	□	□	Please refer to page 56.

■ Standard □ Optional - Not Available.

Exterior Features and Finishers (continued)

	OPTION CODE	S	SE	LANDMARK	HSE	HSE LUXURY	DESCRIPTION
WHEEL FEATURES							
Tyre Repair System		■	■	■	■	■	
Reduced section alloy spare wheel (5)	029VT	□	□	□	□	□	Includes toolkit.
19" full size spare wheel (6)	028MB	□	□	-	-	-	Includes toolkit.
20" full size spare wheel (6)	028MC	□	□	□	□	□	
21" full size spare wheel (6)	028MD	-	□	□	□	□	
22" full size spare wheel (6)	028ME	-	□	□	□	□	
Tyre Pressure Monitoring System (TPMS)		■	■	■	■	■	
Locking wheel nuts		■	■	■	■	■	
HEADLIGHTS AND LIGHTING							
Daytime Running Lights (DRL)		-	■	■	■	■	
Front fog lights	064AP	□	□	■	□	■	
Halogen headlights		■	-	-	-	-	
LED headlights with signature DRL		-	■	■	■	■	Signature design LED lights combine distinctive design with highly practical capabilities. Includes headlight power wash.
Adaptive LED headlights with signature DRL	064GJ	-	□(7)	□	□	□	Adaptive LED headlights swivel to follow the road, while static cornering lights illuminate the kerbside area in tight bends to give the driver a greater sense of confidence during night-time driving.
Signature Hi-Line tail lights	064HF	-	□(8)	■	■	■	
Automatic headlights	064CY	□(9)	■	■	■	■	
Auto High Beam Assist (AHBA)	030NT	-	■	■	■	■	Automatic High Beam Assist headlights automatically dip when traffic is detected, reverting when vehicles have passed.
PAINT							
Solid paint		■	■	■	■	■	Please refer to pages 102-105.
Metallic paint		□	□	□	□	□	Please refer to pages 102-105.
Premium metallic paint		□	□	□	□	□	Please refer to pages 102-105.

■ Standard □ Optional - Not Available.

(5) Not available with Performance Pack (6) The size of the spare wheel will correspond with the size of the road wheels fitted to the vehicle.
(7) Only available with signature Hi-Line tail lights. (8) Standard when fitted with Adaptive LED headlights with signature DRL.
(9) Only available with rain sensing windscreen wipers.

STANDARD AND OPTIONAL FEATURES

Seating, Interior Features and Finishers

	OPTION CODE	S	SE	LANDMARK	HSE	HSE LUXURY	DESCRIPTION
SEATS							
Five seats		■	■	■	■	■	
Third row seats (1)	033BI	□	□	□	□	□	Please refer to page 19.
Powered third row seats (2)	033QB	-	-	-	□	□	Please refer to page 19.
60:40 load through rear seats with manual slide and recline		■	■	■	■	■	Please refer to page 108.
Electrically reclining rear seats (2)	033IR	-	-	-	□	□	Please refer to page 108.
Winged front headrests	033QU	-	-	-	□(3)	■	
Seat Pack 1 - 8-way manual fabric front seats		■	■	■	-	-	
Seat Pack 2 - 12-way (10-way electric) grained leather front seats	033VJ	-	□	□	-	-	
Seat Pack 3 - 12-way (10-way electric) memory grained leather front seats		-	-	-	■	-	
Seat Pack 4 - 16-way (14-way electric) memory Windsor leather front seats	033VL	-	-	-	□	■	
Seat Pack 5 - 16-way (16-way electric) massage electric memory Windsor leather front seats (4)	033VN	-	-	-	-	□	
Heated front seats (5)	033BV	□	-	-	-	-	Please refer to page 63.
Heated front and rear seats (5) (6)	033EQ	□	□	□	□	□	Please refer to page 63.
Heated front, rear and third row seats (7)	033BH	-	-	-	□	□	Please refer to page 63.
Heated and cooled front seats (8)	033GP	-	-	-	□	-	Please refer to page 63.
Heated and cooled front and rear seats (9)	033IN	-	-	-	□(10)	□	Please refer to page 63.
Heated and cooled front and rear seats with heated third row seats (11)	033BL	-	-	-	□	□	Please refer to page 63.
Intelligent Seat Fold (12)	034BB	-	-	-	□	□	Please refer to page 19.

■ Standard □ Optional - Not Available.

Seating, Interior Features and Finishers (continued)

	OPTION CODE	S	SE	LANDMARK	HSE	HSE LUXURY	DESCRIPTION
STEERING WHEEL							
Manually adjustable steering column (4-way)		■	■	■	■	■	
Electrically adjustable steering column (4-way)	049AL	-	-	-	□	□	
Premium leather steering wheel with multi-functional controls and gearshift paddles		■	■	■	■	■	
Heated steering wheel	032DV	□	□(13)	□(13)	□(13)	□(13)	A heated leather steering wheel is available for the ultimate driver comfort.
INTERIOR FINISHERS							
Ebony finisher		■	-	-	-	-	Please refer to page 115.
Gloss Black finisher		-	■	-	-	-	Please refer to page 115.
Dark Satin Brushed Aluminium trim finisher	088HP	-	□	-	□	□	Please refer to page 115.
Natural Shadow Oak veneer	088JU	-	□	-	■	■	Please refer to page 115.
Natural Charcoal Oak veneer	088HY	-	-	-	□	□	Please refer to page 115.
Gloss Charcoal Oak veneer	088JO	-	-	-	□	□	Please refer to page 115.
Lozenge Aluminium finisher		-	-	■	-	-	
Titanium Mesh trim finisher (14)	088JV	-	-	-	□	□	Please refer to page 115.
Premium carpet mats	079BO	□	□	□	□	■	
HEADLINING							
Light Oyster Morzine headlining (15)		■	■	■	■	■	Please refer to pages 110-111.
Ebony Morzine headlining (16)	005BJ	□	□	□	□	□	Please refer to pages 110-111.

■ Standard □ Optional - Not Available.

(13) Only available as part of Cold and Climate option packs, please refer to pages 99-100. (14) Only available as part of Complete Dynamic Design Pack.
(15) Not available with Complete Dynamic Design Pack. (16) Standard as part of Complete Dynamic Design Pack. Not available with Light Oyster/Espresso interior colourway.

STANDARD AND OPTIONAL FEATURES

Seating, Interior Features and Finishers (continued)

	OPTION CODE	S	SE	LANDMARK	HSE	HSE LUXURY	DESCRIPTION
INTERIOR FEATURES							
Driver and passenger sunvisors with illuminated vanity mirrors		■	■	□	■	■	
Front and rear grab handles		■	■	□	■	■	
Illuminated glovebox, overhead console downlight, loadspace light and map light		■	■	□	■	■	
Smoker's Pack	094AA	□	□	□	□	□	Includes ashtray and cigar lighter in front row.
Auto-dimming interior rear view mirror	031CG	□	■	■	■	■	
Ambient Interior Lighting		-	■	■	■	-	
Configurable Ambient Interior Lighting		-	-	-	-	■	Please refer to page 63.
Rear reading lights		-	■	■	■	■	
Twin front cupholders		■	■	■	-	-	
Twin front cupholders with cover		-	-	-	■	■	Please refer to page 21.
Shopping bag hook (curry hook)		-	-	-	■	■	Please refer to page 21.
Upper secondary glovebox		-	■	■	■	■	Please refer to page 21. (4)
Front centre console cooler compartment	045CA	□	□	□	□	□	Please refer to page 21.
Air conditioning		■	-	-	-	-	Please refer to page 63.
Two-zone Climate Control	022AY	□	■	■	■	-	Please refer to page 63.
Three-zone Climate Control	022BG	-	-	-	□	■	Please refer to page 63.
Four-zone Climate Control (1)	022BC	□	□	□	□	□	Please refer to page 63. Row 3 vents are only available when 4-zone climate control is present.
STOWAGE							
Overhead stowage for sunglasses (2)		■	■	■	■	■	
Rear armrest with twin cupholders (3)		-	■(4)	■(4)	■	■	Please refer to page 21.
Cubby box with central hinged twin lidded stowage		■	■	■	■	■	Please refer to page 21.
Lower centre console stowage		■	■	■	■	■	Please refer to page 21.
Third row side stowage with lid and single 5V charging point		■	■	■	■	■	Please refer to page 21.
In-facia stowage		-	-	-	■	■	Please refer to page 21.

■ Standard □ Optional - Not Available.

Safety and Security

	OPTION CODE	S	SE	LANDMARK	HSE	HSE LUXURY	DESCRIPTION
Audible seat belt warning (including third row)		■	■	■	■	■	Please refer to page 70.
Front side impact airbags		■	■	■	■	■	Please refer to page 71.
Hazard lights under heavy braking		■	■	■	■	■	
Perimetric alarm		■	■	■	■	■	
Rollover deployment of restraints		■	■	■	■	■	Please refer to page 71.
Side curtain airbags		■	■	■	■	■	Please refer to page 70.
Front passenger seat ISOFIX (3)		-	■(4)	■(4)	■	■	Please refer to page 70.
Third row ISOFIX		■	■	■	■	■	Standard when third row seats are specified. Please refer to page 70.
Intrusion sensor	076EL	□	□	□	□	□	The Advanced Alarm System offers enhanced theft-protection, using ultrasonic sensors to detect any intrusion into the cabin area when the vehicle is locked. When the alarm is activated, the vehicle emits an acoustic warning and the hazard warning lights are automatically switched on.
First Aid Kit	056AZ	□	□	□	□	□	

■ Standard □ Optional - Not Available.

STANDARD AND OPTIONAL FEATURES

Driver Assistance, Convenience and Loadspace Features

	OPTION CODE	S	SE	LANDMARK	HSE	HSE LUXURY	DESCRIPTION
Push Button Start		■	■	■	■	■	
Cruise Control and Speed Limiter		■	■	■	-	-	
Adaptive Cruise Control	065AM	□(1)	□(1)	□(1)	■	■	
Adaptive Cruise Control with Steering Assist (2)	065AJ	□	□	□	□	□	Please refer to page 53.
Lane Keep Assist		■	■	■	■	■	
Driver Condition Monitor		■	■	■	■	■	Please refer to page 48.
Front and Rear Parking Aid		■	■	■	■	■	
360° Parking Aid	189AF	□(3)	■	■	■	■	Sensors located around the vehicle are automatically triggered when reverse is selected, or can be manually activated, with a graphic appearing on the Touchscreen showing an overhead view of the vehicle. As you park, the Touchscreen display and audio feedback indicates how close you are to obstacles. Includes Front and Rear Parking Aid.
Park Assist	086MB	□(3)	■	■	■	■	Please refer to page 50.
Rear Camera		■	■	■	■	■	Please refer to page 48.
360° Surround Camera	086GC	□(4)	□	□	□	□	Please refer to page 49.
Traffic Sign Recognition and Intelligent Speed Limiter	086DC	□(5)	□(5)	□(5)	■	■	Please refer to page 51.
Blind Spot Assist	086GM	□(4)	□(4)	□(4)	■	■	Please refer to page 51.
Clear Exit Monitor	074PZ	□(3)	■	■	■	■	
High-speed Emergency Braking	087CB	□(5)	□(5)	□(5)	■	■	
Rear Traffic Monitor	086KB	□(3)	■	■	■	■	

■ Standard □ Optional - Not Available.

Driver Assistance, Convenience and Loadspace Features (continued)

	OPTION CODE	S	SE	LANDMARK	HSE	HSE LUXURY	DESCRIPTION
Wade Sensing (6)	075ED	-	-	-	<input type="checkbox"/>	<input type="checkbox"/>	Please refer to page 31.
Keyless Entry	066AC	-	<input type="checkbox"/>	<input type="checkbox"/>	<input checked="" type="checkbox"/>	<input checked="" type="checkbox"/>	The driver is able to access the vehicle without the need to take the remote smart key out of a bag or pocket.
Activity Key	066CA	-	<input type="checkbox"/>	<input type="checkbox"/>	<input type="checkbox"/>	<input type="checkbox"/>	Please refer to page 65.
HomeLink®	025CT	<input type="checkbox"/> (7)	<input type="checkbox"/>	<input type="checkbox"/>	<input type="checkbox"/>	<input type="checkbox"/>	Please refer to page 61.
Park Heat with remote control	043BH	<input type="checkbox"/>	<input type="checkbox"/>	<input type="checkbox"/>	<input type="checkbox"/>	<input type="checkbox"/>	This pre-heats the engine, channelling residual heat into the cabin, so the vehicle is warm and comfortable by the time you leave the house.
Cabin Air Ionisation	022GB	<input type="checkbox"/>	<input type="checkbox"/>	<input type="checkbox"/>	<input type="checkbox"/>	<input type="checkbox"/>	
LOADSPACE FEATURES							
Luggage retention loops		<input checked="" type="checkbox"/>	<input checked="" type="checkbox"/>	<input checked="" type="checkbox"/>	<input checked="" type="checkbox"/>	<input checked="" type="checkbox"/>	
Loadspace cover		<input checked="" type="checkbox"/>	<input checked="" type="checkbox"/>	<input checked="" type="checkbox"/>	<input checked="" type="checkbox"/>	<input checked="" type="checkbox"/>	
Loadspace partition net	026EU	<input type="checkbox"/>	<input type="checkbox"/>	<input type="checkbox"/>	<input type="checkbox"/>	<input type="checkbox"/>	
Powered tailgate	070AV	<input type="checkbox"/>	<input type="checkbox"/>	<input type="checkbox"/>	<input checked="" type="checkbox"/>	<input checked="" type="checkbox"/>	
Powered gesture tailgate	070BA	-	<input type="checkbox"/> (8)	<input type="checkbox"/>	<input type="checkbox"/>	<input type="checkbox"/>	
Powered inner tailgate (9)	079EC	<input type="checkbox"/>	<input type="checkbox"/>	<input type="checkbox"/>	<input checked="" type="checkbox"/>	<input checked="" type="checkbox"/>	

■ Standard Optional - Not Available.

(6) Only available with 360° Surround Camera and Blind Spot Assist. (7) Only available with auto-dimming interior rear view mirror.
(8) Only available with Keyless Entry and includes powered tailgate. (9) Only available with powered tailgate or powered gesture tailgate on S, SE and Landmark Edition.

STANDARD AND OPTIONAL FEATURES

Information, Communication and Entertainment

	OPTION CODE	S	SE	LANDMARK	HSE	HSE LUXURY	DESCRIPTION
10" Touch Pro		■	■	■	■	■	
10" Touch Pro Dual View (1)	087AS	-	-	-	□	□	
Sound System 125W with six speakers		■	-	-	-	-	Please refer to page 40.
Enhanced Sound System 250W with 10 speakers	025KM	□	■	-	-	-	Please refer to page 40.
Meridian™ Sound System 380W with 10 speakers and a dual-channel subwoofer	025LM	□(2)	□	■	■	-	Please refer to page 40.
Meridian™ Surround Sound System 825W with 14 speakers and a dual-channel subwoofer	025LN	-	-	-	□	■	Please refer to page 40.
CD/DVD player	025AM	-	-	-	□	□	
Bluetooth® connectivity		■	■	■	■	■	
Digital Audio Broadcast (DAB) Radio		■	■	■	■	■	
8" Rear Seat Entertainment (1) (3)	129AH	-	-	-	□	□	Please refer to page 39.
Digital TV	129AA	-	-	-	□	□	
Protect		■	■	■	■	■	Please refer to page 45.
Navigation Pro	087AU	□	■	■	■	■	Please refer to page 43.
Remote Premium	011DA	□(4)	■	■	■	■	Please refer to page 44.
Pro Services and Wi-Fi Hotspot	025RC	□(4)	■	■	■	■	Please refer to page 43.
Secure Tracker	011AE	□	□	□	□	□	Please refer to page 45.
Android Auto™		■	■	■	■	■	
Apple CarPlay®		■	■	■	■	■	
Head-up Display (5)	039IB	-	□	□	□	□	Please refer to page 39.
Analogue Dials with Central TFT Display		■	■	■	-	-	
Interactive Driver Display	038ID	□(2)	□	□	■	■	
Single 12V auxiliary charging point (upper glovebox)		-	■	■	■	■	
Single 12V auxiliary charging point (second row)		■	-	-	-	-	
Twin 12V auxiliary charging points (second row)	054AM	-	■	■	□	□	
Twin USB sockets (second row)	054AN	-	□	□	■	■	Please refer to page 47.

■ Standard □ Optional - Not Available.

(1) Overhead stowage for sunglasses is not available with 10" Touch Pro Dual View Touchscreen and 8" Rear Seat Entertainment. (2) Only available with Navigation Pro. (3) Only available with winged headrests and CD/DVD player.

(4) Only available as part of Connect Pro Pack. (5) Requires solar attenuating windscreen in some markets.

The Bluetooth® word mark and logos are owned by the Bluetooth SIG, Inc. and any use of such marks by Land Rover is under licence. iPhone® and Apple CarPlay® are registered trademarks of Apple Inc., registered in the US and other countries. Please ensure iPhone compatibility is reviewed with your local Land Rover Retailer. Android™ is a trademark of Google Inc.

Option Packs

	OPTION CODE	S	SE	LANDMARK	HSE	HSE LUXURY
COMPLETE DYNAMIC DESIGN PACK (6)	032IN					
Dynamic exterior		-	-	-	□	□
Dynamic interior (7)		-	-	-	□	□
DYNAMIC EXTERIOR DESIGN PACK (6)	032IP					
Dynamic exterior		-	-	■	-	-
BLACK DESIGN PACK (8)	074LN					
Black exterior		-	□	-	□	□
CONNECT PRO PACK (2)	011CF					
Pro Services and Wi-Fi Hotspot		□	■	■	■	■
Remote Premium		□	■	■	■	■
SMARTPHONE PACK	186AB					
Android Auto™		■	■	■	■	■
Apple Car Play®		■	■	■	■	■

■ Standard □ Optional - Not Available.

STANDARD AND OPTIONAL FEATURES

Option Packs (continued)

	OPTION CODE	S	SE	LANDMARK	HSE	HSE LUXURY
DRIVE PACK (1)	017TA					
Blind Spot Assist		<input type="checkbox"/>	<input type="checkbox"/>	<input type="checkbox"/>	<input checked="" type="checkbox"/>	<input checked="" type="checkbox"/>
Adaptive Cruise Control		<input type="checkbox"/>	<input type="checkbox"/>	<input type="checkbox"/>	<input checked="" type="checkbox"/>	<input checked="" type="checkbox"/>
Traffic Sign Recognition and Adaptive Speed Limiter		<input type="checkbox"/>	<input type="checkbox"/>	<input type="checkbox"/>	<input checked="" type="checkbox"/>	<input checked="" type="checkbox"/>
High-speed Emergency Braking		<input type="checkbox"/>	<input type="checkbox"/>	<input type="checkbox"/>	<input checked="" type="checkbox"/>	<input checked="" type="checkbox"/>
DRIVER ASSIST PACK (1)	017AQ					
360° Surround Camera		<input type="checkbox"/>	<input type="checkbox"/>	<input type="checkbox"/>	<input type="checkbox"/>	<input type="checkbox"/>
Blind Spot Assist		<input type="checkbox"/>	<input type="checkbox"/>	<input type="checkbox"/>	<input checked="" type="checkbox"/>	<input checked="" type="checkbox"/>
Traffic Sign Recognition and Adaptive Speed Limiter		<input type="checkbox"/>	<input type="checkbox"/>	<input type="checkbox"/>	<input checked="" type="checkbox"/>	<input checked="" type="checkbox"/>
Adaptive Cruise Control with Steering Assist		<input type="checkbox"/>	<input type="checkbox"/>	<input type="checkbox"/>	<input type="checkbox"/>	<input type="checkbox"/>
Clear Exit Monitor		<input type="checkbox"/>	<input checked="" type="checkbox"/>	<input checked="" type="checkbox"/>	<input checked="" type="checkbox"/>	<input checked="" type="checkbox"/>
High-speed Emergency Braking		<input type="checkbox"/>	<input type="checkbox"/>	<input type="checkbox"/>	<input checked="" type="checkbox"/>	<input checked="" type="checkbox"/>
Park Assist		<input type="checkbox"/>	<input checked="" type="checkbox"/>	<input checked="" type="checkbox"/>	<input checked="" type="checkbox"/>	<input checked="" type="checkbox"/>
360° Parking Aid		<input type="checkbox"/>	<input checked="" type="checkbox"/>	<input checked="" type="checkbox"/>	<input checked="" type="checkbox"/>	<input checked="" type="checkbox"/>
Rear Traffic Monitor		<input type="checkbox"/>	<input checked="" type="checkbox"/>	<input checked="" type="checkbox"/>	<input checked="" type="checkbox"/>	<input checked="" type="checkbox"/>
PARK PACK	017UA					
Clear Exit Monitor		<input type="checkbox"/>	<input checked="" type="checkbox"/>	<input checked="" type="checkbox"/>	<input checked="" type="checkbox"/>	<input checked="" type="checkbox"/>
Park Assist		<input type="checkbox"/>	<input checked="" type="checkbox"/>	<input checked="" type="checkbox"/>	<input checked="" type="checkbox"/>	<input checked="" type="checkbox"/>
360° Parking Aid		<input type="checkbox"/>	<input checked="" type="checkbox"/>	<input checked="" type="checkbox"/>	<input checked="" type="checkbox"/>	<input checked="" type="checkbox"/>
Rear Traffic Monitor		<input type="checkbox"/>	<input checked="" type="checkbox"/>	<input checked="" type="checkbox"/>	<input checked="" type="checkbox"/>	<input checked="" type="checkbox"/>
7 SEAT PACK (2)	074SC					
Third row seats		<input type="checkbox"/>	<input type="checkbox"/>	<input type="checkbox"/>	<input type="checkbox"/>	<input type="checkbox"/>
Electronic air suspension		<input type="checkbox"/>	<input type="checkbox"/>	<input type="checkbox"/>	<input type="checkbox"/>	<input type="checkbox"/>
Powered tailgate		<input type="checkbox"/>	<input type="checkbox"/>	<input type="checkbox"/>	<input checked="" type="checkbox"/>	<input checked="" type="checkbox"/>
Twin-speed transfer box (high/low range)		<input type="checkbox"/>	<input type="checkbox"/>	<input type="checkbox"/>	<input type="checkbox"/>	<input type="checkbox"/>

■ Standard □ Optional - Not Available.

Option Packs (continued)

	OPTION CODE	S	SE	LANDMARK	HSE	HSE LUXURY
7 SEAT PLUS PACK (3)	074SE					
Twin-speed transfer box (high/low range)		-	<input type="checkbox"/>	<input type="checkbox"/>	<input type="checkbox"/>	<input type="checkbox"/>
Third row seats		-	<input type="checkbox"/>	<input type="checkbox"/>	<input type="checkbox"/>	<input type="checkbox"/>
Electronic air suspension		-	<input type="checkbox"/>	<input type="checkbox"/>	<input type="checkbox"/>	<input type="checkbox"/>
Powered gesture tailgate		-	<input type="checkbox"/>	<input type="checkbox"/>	<input type="checkbox"/>	<input type="checkbox"/>
Keyless Entry		-	<input type="checkbox"/>	<input type="checkbox"/>	<input checked="" type="checkbox"/>	<input checked="" type="checkbox"/>
CAPABILITY PACK (4)	074GU					
Twin-speed transfer box (high/low range)		-	<input type="checkbox"/>	<input type="checkbox"/>	<input type="checkbox"/>	<input type="checkbox"/>
Terrain Response 2		-	<input type="checkbox"/>	<input type="checkbox"/>	<input type="checkbox"/>	<input type="checkbox"/>
Electronic air suspension		-	<input type="checkbox"/>	<input type="checkbox"/>	<input type="checkbox"/>	<input type="checkbox"/>
ADVANCED OFF-ROAD CAPABILITY PACK (5)	074PM					
Twin-speed transfer box (high/low range)		-	<input type="checkbox"/> (6)	<input type="checkbox"/> (6)	<input type="checkbox"/> (6)	<input type="checkbox"/> (6)
Active rear locking differential		-	<input type="checkbox"/>	<input type="checkbox"/>	<input type="checkbox"/>	<input type="checkbox"/>
Electronic air suspension		-	<input type="checkbox"/> (6)	<input type="checkbox"/> (6)	<input type="checkbox"/> (6)	<input type="checkbox"/> (6)
Terrain Response 2		-	<input type="checkbox"/>	<input type="checkbox"/>	<input type="checkbox"/>	<input type="checkbox"/>
All Terrain Progress Control (ATPC)		-	<input type="checkbox"/>	<input type="checkbox"/>	<input type="checkbox"/>	<input type="checkbox"/>
COLD CLIMATE PACK (7) (8)	072AC					
Heated windscreen		<input type="checkbox"/>	<input type="checkbox"/>	<input type="checkbox"/>	<input type="checkbox"/>	<input type="checkbox"/>
Heated washer jets		<input type="checkbox"/>	<input type="checkbox"/>	<input type="checkbox"/>	<input type="checkbox"/>	<input type="checkbox"/>
Heated steering wheel		-	<input type="checkbox"/>	<input type="checkbox"/>	<input type="checkbox"/>	<input type="checkbox"/>
Heated front and rear seats		<input type="checkbox"/>	<input type="checkbox"/>	<input type="checkbox"/>	<input type="checkbox"/>	<input type="checkbox"/>
7 SEAT COLD CLIMATE PACK (7) (8) (9)	072BN					
Heated windscreen		-	<input type="checkbox"/>	<input type="checkbox"/>	<input type="checkbox"/>	<input type="checkbox"/>
Heated washer jets		-	<input type="checkbox"/>	<input type="checkbox"/>	<input type="checkbox"/>	<input type="checkbox"/>
Heated steering wheel		-	<input type="checkbox"/>	<input type="checkbox"/>	<input type="checkbox"/>	<input type="checkbox"/>
Heated front, rear and third row seats		-	-	-	<input type="checkbox"/>	<input type="checkbox"/>

■ Standard □ Optional - Not Available.

(3) Only available with Sd4 Ingenium engines. Not available with 7 Seat Pack, Capability Pack or Capability Plus Pack. (4) Only available with Sd4 Ingenium engine. Not available with Capability Plus Pack, 7 Seat Pack or 7 Seat Plus Pack. (5) Not available with Si4 Ingenium engine. Not available with Capability Pack, 7 Seat Plus Pack and 7 Seat Pack. Only available with twin-speed transfer box (high/low range) and electronic air suspension. (6) Standard fitment with Sd6 engine. (7) Not available with other Climate Pack options. (8) Not available with Seat Pack 5. (9) Only available with third row seats.

STANDARD AND OPTIONAL FEATURES

Option Packs (continued)

	OPTION CODE	S	SE	LANDMARK	HSE	HSE LUXURY
CLIMATE COMFORT PACK (1)	072BF					
Solar attenuating windscreen		-	-	-	□	-
Three-zone Climate Control		-	-	-	□	-
Heated and cooled front seats		-	-	-	□	-
Front centre console cooler compartment		-	-	-	□	-
VERSATILE CLIMATE COMFORT PACK (2)	072BM					
Solar attenuating windscreen		□	□	□	□	-
Three-zone Climate Control		-	-	-	□	-
Front centre console cooler compartment		□	□	□	□	-
Heated windscreen		□	□	□	□	-
Heated washer jets		□	□	□	□	-
Heated steering wheel		□	□	□	□	-
LUXURY CLIMATE COMFORT PACK (2)	072BL					
Heated and cooled front and rear seats		-	-	-	□	□
Four-zone Climate Control (3)		-	-	-	□	□
Seat Pack 4		-	-	-	□	-
Seat Pack 5		-	-	-	-	□
Solar attenuating windscreen		-	-	-	□	■
Heated windscreen		-	-	-	□	□
Heated washer jets		-	-	-	□	□
Heated steering wheel		-	-	-	□	□
7 SEAT LUXURY CLIMATE COMFORT PACK (2)	072BP					
Heated and cooled front and rear seats with heated third row seats		-	-	-	□	□
Four-zone Climate Control (3)		-	-	-	□	□
Seat Pack 4		-	-	-	□	□
Seat Pack 5		-	-	-	-	□
Solar attenuating windscreen		-	-	-	□	■
Heated windscreen		-	-	-	□	□
Heated washer jets		-	-	-	□	□
Heated steering wheel		-	-	-	□	□

■ Standard □ Optional - Not Available.

Option Packs (continued)

	OPTION CODE	S	SE	LANDMARK	HSE	HSE LUXURY
REMOTE INTELLIGENT SEAT FOLD PACK (4)	074VP					
Intelligent Seat Fold		-	-	-	<input type="checkbox"/>	<input type="checkbox"/>
Electrically reclining rear seats		-	-	-	<input type="checkbox"/>	<input type="checkbox"/>
Powered third row seats		-	-	-	<input type="checkbox"/>	<input type="checkbox"/>
TECHNOLOGY PACK	074KY					
Powered tailgate		<input type="checkbox"/>	-	-	-	-
Enhanced Sound System 250W with 10 speakers		<input type="checkbox"/>	-	-	-	-
Navigation Pro		<input type="checkbox"/>	-	-	-	-
TECHNOLOGY PLUS PACK (5)	074QM					
Adaptive LED headlights with signature DRL		-	-	-	<input type="checkbox"/>	-
Solar attenuating windscreen		-	-	-	<input type="checkbox"/>	-
Head-up Display		-	-	-	<input type="checkbox"/>	-
Powered gesture tailgate		-	-	-	<input type="checkbox"/>	-
VISION ASSIST PACK (6)	041CB					
Automatic headlights		<input type="checkbox"/>	-	-	-	-
Rain sensing windscreen wipers		<input type="checkbox"/>	-	-	-	-
Auto-dimming, power fold, heated door mirrors with approach lights		<input type="checkbox"/>	-	-	-	-
PERFORMANCE PACK (7)	187EA					
Electronic Air Suspension		-	-	-	<input type="checkbox"/>	-
Adaptive Dynamics		-	-	-	<input type="checkbox"/>	-

Optional - Not Available.

(4) Only available with third row seats. (5) Not available with Versatile Climate Comfort Pack, Luxury Climate Comfort Pack, Vision Assist Pack or 7 Seat Luxury Climate Comfort Pack. (6) Not available with Technology Plus Pack. (7) Only available with Sd4 240PS engine. Not available with third row seats, Capability Pack, Advanced Off-Road Capability Pack, 7 Seat Pack and 7 Seat Plus Pack.

3

CHOOSE YOUR COLOUR

Now you have chosen your Discovery model, you can select your exterior paint colour. From rich, deep lustres to incandescent metallic patinas, our paints incorporate the latest in pigment technologies. Our solid paints produce a deep flat colour. Our metallics deliver a sparkle finish that is sure to catch the eye. And our premium metallic paints enhance both the colour and the intensity of the sparkle, or sleek metallic finish to give your vehicle even more presence.

You can select either a body-coloured or contrast roof in Black to further enhance your vehicle's exterior. Metal and panoramic roofs available with all colour finishes.

Fuji White (solid)

Optional Contrast Roof Colour
Black



Narvik Black (solid)



Yulong White (metallic)

Optional Contrast Roof Colour
Black



Indus Silver (metallic)

Optional Contrast Roof Colour
Black



Eiger Grey (metallic)

Optional Contrast Roof Colour
Black



Portofino Blue (metallic)
Optional Contrast Roof Colour
Black



Santorini Black (metallic)



Byron Blue (metallic)
Optional Contrast Roof Colour
Black



Namib Orange (premium metallic)

Optional Contrast Roof Colour
Black



Farallon Black (premium metallic)



Silicon Silver (premium metallic)

Optional Contrast Roof Colour
Black



Carpathian Grey (premium metallic)

Optional Contrast Roof Colour
Black



4 CHOOSE YOUR WHEELS



19" 5 SPLIT-SPOKE
'STYLE 5021'



20" 5 SPLIT-SPOKE
'STYLE 5011'



20" 5 SPLIT-SPOKE
'STYLE 5011'
WITH GLOSS BLACK FINISH



20" 10 SPLIT-SPOKE
'STYLE 1011'



20" 10 SPOKE AERO
'STYLE 1035' (1)



21" 9 SPOKE
'STYLE 9002'

	OPTION CODE	S	SE	LANDMARK	HSE	HSE LUXURY
WHEELS						
19" 5 split-spoke 'Style 5021'		■	■	-	-	-
20" 5 split-spoke 'Style 5011'	031HG	□	□	□	■	□
20" 5 split-spoke 'Style 5011' with Gloss Black finish	031HJ	-	□	■	□	□
20" 10 split-spoke 'Style 1011'	031HH	□	□	□	□	■
20" 10 spoke Aero 'Style 1035' (1)	031GJ	□	□	-	□	□
21" 9 spoke 'Style 9002'	031HK	-	□	□	□	□

■ Standard □ Optional - Not Available.

STEP 4
CHOOSE YOUR WHEELS



21" 10 SPLIT-SPOKE
'STYLE 1012'
WITH GLOSS BLACK FINISH



21" 5 SPLIT-SPOKE
'STYLE 5025'
WITH SATIN DARK GREY FINISH



21" 5 SPLIT-SPOKE
'STYLE 5085'
SATIN DARK GREY
WITH CONTRAST DIAMOND
TURNED FINISH



22" 5 SPLIT-SPOKE
'STYLE 5011'



22" 5 SPLIT-SPOKE
'STYLE 5011'
WITH GLOSS BLACK FINISH



22" 5 SPLIT-SPOKE
'STYLE 5025'
SATIN DARK GREY
WITH CONTRAST DIAMOND
TURNED FINISH

	OPTION CODE	S	SE	LANDMARK	HSE	HSE LUXURY
WHEELS						
21" 10 split-spoke 'Style 1012' with Gloss Black finish	031HN	-	<input type="checkbox"/>	<input type="checkbox"/>	<input type="checkbox"/>	<input type="checkbox"/>
21" 5 split-spoke 'Style 5025' with Satin Dark Grey finish	031GD	-	-	-	<input type="checkbox"/>	<input type="checkbox"/>
21" 5 split-spoke 'Style 5085' Satin Dark Grey with contrast Diamond Turned finish	031NQ	-	-	<input type="checkbox"/>	-	-
22" 5 split-spoke 'Style 5011'	031GE	-	<input type="checkbox"/>	<input type="checkbox"/>	<input type="checkbox"/>	<input type="checkbox"/>
22" 5 split-spoke 'Style 5011' with Gloss Black finish	031GF	-	-	-	<input type="checkbox"/>	<input type="checkbox"/>
22" 5 split-spoke 'Style 5025' Satin Dark Grey with contrast Diamond Turned finish	031GH	-	-	-	<input type="checkbox"/>	<input type="checkbox"/>

5

CHOOSE YOUR INTERIOR – SEAT CONFIGURATION



Electrically Reclining Rear Seats

Available as an option on HSE and HSE Luxury with optional third row seats, these seats have forwards/backwards movement of 160mm allowing truly flexible use of space for luggage or to maximise passenger legroom. The seats also power recline up to 27° and allow for load-through to provide even greater comfort and convenience.

60:40 Manual Slide and Recline Seats (not shown)

The standard 60:40 five-seat configuration features three comfortable seating positions and load-through feature.























Seven Full-size Seats with Stadium Seating

A neatly integrated optional third row of seats gives you even more versatility, with the third row easily accessed at the touch of a button. On HSE and HSE Luxury models, the third row has the option of heating,

a first for the segment, as well as the capability of power folding. Discovery makes light work of carrying you and six other adults in the most comfortable and contemporary surroundings.

CHOOSE YOUR INTERIOR – COLOUR COMBINATIONS

Now you have chosen your model, you can use this table to select the perfect combination of interior colour, exterior colour and interior finishers.

	EXCLUSIVE TO COMPLETE DYNAMIC DESIGN PACK							
	(A)	(B)	(C)	(D)	(E)	(F)	(G)	(H)
COLOURWAYS	EBONY/ EBONY (page 112)	ACORN/ EBONY (page 113)	LIGHT OYSTER/ ESPRESSO (page 113)	VINTAGE TAN/ EBONY (page 112)	GLACIER/ EBONY (page 113)	EBONY/EBONY with Light Oyster detail (page 114)	EBONY/EBONY with Pimento detail (page 114)	LIGHT OYSTER/EBONY with Reims Blue detail (page 114)
INTERIOR COLOUR								
Seat colour	Ebony	Acorn	Light Oyster	Vintage Tan	Glacier	Ebony	Ebony	Light Oyster
Carpet	Ebony	Ebony	Espresso	Ebony	Ebony	Ebony	Ebony	Ebony
MODEL								
S (Fabric)	○	-	-	-	-	-	-	-
SE (Fabric)	○	-	-	-	-	-	-	-
SE (Grained leather)	○	○	-	-	-	-	-	-
Landmark (Fabric)	○	-	-	-	-	-	-	-
Landmark (Grained leather)	○	○	-	-	-	-	-	-
HSE (Grained leather)	○	○	○	-	-	-	-	-
HSE (Windsor leather)	○	-	○	○	-	○	○	○
HSE LUXURY (Windsor leather)	○	-	○	○	○	○	○	○
INTERIOR FINISHERS								
 Ebony finisher (1)	○	-	-	-	-	-	-	-
 Gloss Black finisher (2)	○	○	-	-	-	-	-	-
 Dark Satin Brushed Aluminium trim finisher	○	○	○	○	○	-	-	-
 Natural Shadow Oak veneer	○	○	○	○	○	-	-	-
 Natural Charcoal Oak veneer (3)	○	○	○	○	○	-	-	-
 Gloss Charcoal Oak veneer (3)	○	○	○	○	○	-	-	-
 Titanium Mesh trim finisher	-	-	-	-	-	○	○	○
 Technical Lozenge Aluminium finisher (4)	○	○	-	-	-	-	-	-
EXTERIOR COLOUR								
 Fuji White	○	○	○	▲	○	○	○	○
 Yulong White	▲	○	○	▲	○	▲	▲	○
 Indus Silver	▲	○	○	○	○	○	○	○
 Silicon Silver	○	▲	▲	○	▲	○	○	▲
 Eiger Grey	○	○	○	○	○	○	○	○
 Carpathian Grey	▲	○	○	▲	▲	▲	▲	○
 Namib Orange	▲	○	▲	○	○	▲	○	○
 Byron Blue	○	○	○	○	○	▲	○	▲
 Portofino Blue	○	○	○	○	○	○	○	○
 Narvik Black	○	○	○	○	○	○	○	○
 Santorini Black	○	▲	○	○	▲	▲	▲	○
 Farallon Black	○	○	○	▲	○	○	○	▲

▲ Combination is Designer's Choice ○ Combination is Available - Not Available.

110 (1) Available on S models only. (2) Available on SE models only. (3) Available on HSE and HSE Luxury models only. (4) Available on Landmark Edition only.

The above table is designed as a guide. Please contact your nearest Land Rover Retailer for more information.



	1	2	3	4	5	6
COLOURWAYS	DOOR LOWER AND ARMREST UPPER	DOOR ROLL TOP	INSTRUMENT PANEL UPPER	CENTRE STACK SIDE RAILS	CUBBY BOX	INSTRUMENT MID-SECTION
(A) Ebony/Ebony	Ebony	Ebony	Ebony	Gloss Black (1)	Ebony	Ebony
(B) Acorn/Ebony	Ebony	Acorn	Ebony	Gloss Black (2)	Ebony	Acorn
(C) Light Oyster/Esspresso	Esspresso	Light Oyster	Esspresso	Light Oyster Brushed Aluminium	Esspresso	Light Oyster
(D) Vintage Tan/Ebony	Ebony	Vintage Tan (3)	Ebony	Satin Brushed Aluminium	Ebony	Vintage Tan (3)
(E) Glacier/Ebony	Ebony	Glacier	Ebony	Light Oyster Brushed Aluminium	Ebony	Glacier
EXCLUSIVE TO DYNAMIC DESIGN PACK						
(F) Ebony/Ebony with Light Oyster detail	Ebony	Ebony	Ebony	Dark Brushed Aluminium	Ebony	Ebony
(G) Ebony/Ebony with Pimento detail	Ebony	Ebony	Ebony	Dark Brushed Aluminium	Ebony	Ebony
(H) Light Oyster/Ebony with Reims Blue detail	Ebony	Light Oyster	Ebony	Dark Brushed Aluminium	Ebony	Light Oyster

(1) Satin Brushed Aluminium on HSE and HSE Luxury models. (2) Satin Brushed Aluminium on HSE (grained leather). (3) Ebony on HSE (Windsor leather). Interior shown above is HSE Luxury in Light Oyster/Esspresso.

AVAILABLE INTERIOR COLOUR COMBINATIONS

The cabin in Discovery embodies the finest of contemporary living. Bold horizontal and vertical lines and superb levels of comfort create a space in which you and your family and friends will want to spend time. A wide range of colourway and seat material choices are available to suit all tastes.

- A** **Ebony/Ebony** (available on S, SE, Landmark Edition, HSE and HSE Luxury)



Interior shown: S interior in Ebony/Ebony* with Seat Pack 1 Ebony fabric seats, and Ebony finisher.

- D** **Vintage Tan/Ebony** (available on HSE and HSE Luxury)



Interior shown: HSE Luxury interior in Vintage Tan/Ebony* with Seat Pack 4 Vintage Tan Windsor leather seats with Ebony contrast micropiping, and Natural Charcoal Oak veneer.

*Please see page 111 for further clarification on interior colour combinations.

B Acorn/Ebony (available on SE, Landmark Edition and HSE)



Interior shown: HSE interior in Acorn/Ebony* with optional Seat Pack 3 Acorn grained leather seats, and Natural Shadow Oak veneer.

C Light Oyster/Espresso (available on HSE and HSE Luxury)



Interior shown: HSE interior in Light Oyster/Espresso with Seat Pack 3 Light Oyster grained leather seats, and Natural Shadow Oak veneer.

E Glacier/Ebony (available on HSE Luxury)



Interior shown: HSE Luxury interior in Glacier/Ebony with optional Seat Pack 5 Glacier Windsor leather seats with Ebony contrast micropiping, and Natural Shadow Oak veneer.

F **Ebony/Ebony with Light Oyster stitching and piping**
(available on Complete Dynamic Design Pack only)



Interior shown: Ebony/Ebony¹ Windsor leather interior, Ebony seats with Light Oyster stitching and piping and Titanium Mesh trim finisher.

G **Ebony/Ebony with Pimento stitching and piping**
(available on Complete Dynamic Design Pack only)



Interior shown: Ebony/Ebony¹ Windsor leather interior, Ebony seats with Pimento stitching and piping and Titanium Mesh trim finisher.

H **Light Oyster/Ebony with Reims Blue stitching and piping**
(available on Complete Dynamic Design Pack only)



Interior shown: Light Oyster/Ebony Windsor leather interior, Light Oyster seats with Reims Blue stitching and piping and Titanium Mesh trim finisher.

¹Please see page 111 for further clarification on interior colour combinations.

Interiors shown are for interior colour reference only and are not representative of model specification.

INTERIOR FINISHERS

Now you have chosen your interior colour combination, choose one of seven interior finishers. For full availability and designer's choices, please see the colour and trim matrix on pages 110 and 111.



Dark Satin Brushed Aluminium trim finisher



Titanium Mesh trim finisher²



Natural Charcoal Oak veneer



Gloss Charcoal Oak veneer



Gloss Black finisher



Ebony finisher

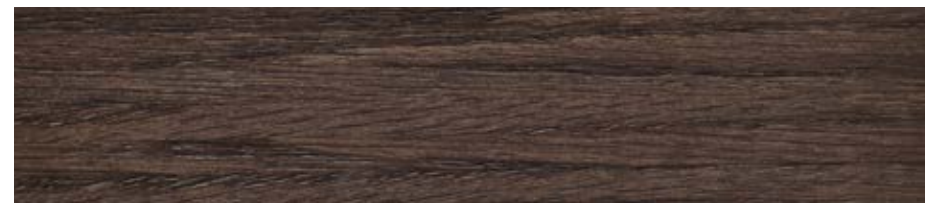

Natural Shadow Oak veneer

²Only available with Complete Dynamic Design Pack.

6

LAND ROVER GEAR – ACCESSORIES

Discovery is so capable and adaptable it can get straight to work across a huge variety of vastly differing conditions and roles. Even so, some owners want to add their own stamp of individuality by tailoring their Discovery to their specific needs with a range of stylish, practical accessories that are tough, versatile and bring an opportunity for personalisation.



Importantly, these accessories can be added by your Land Rover Retailer at any stage during the vehicle's life – not just when it's new. Naturally, Land Rover Accessories are designed, tested and manufactured to the same exacting standards as the original equipment fitted to your vehicle.

DESIGN



Loadspace Organiser

Convenient loadspace organiser provides segregated compartments to stow wet, dirty or delicate items or separate shopping/luggage. The front and rear compartments also have flexible dividers to create smaller compartments within them. Featuring two lockable lids, it is secured via loadspace 'D' loops¹.



Stainless Steel Undershield¹ - Front/Rear

The off-road designed undershield, manufactured from stainless steel, features a premium Bright Polished finish for the front and rear of the vehicle.



Sports Pedal Covers²

Stainless steel Bright finish sports pedal covers are easy to fit and feature hidden fixings for a clean finish.



Bright Side Tubes³

Highly polished stainless steel side tubes provide an off-road inspired appearance, designed to complement the vehicle's exterior design.



Deployable Side Steps³

These smart, practical steps make it easier to get in and out of the vehicle. Neatly stowed under the sills, the side steps automatically deploy as soon as the door is opened, or when activated by the key fob. They stow automatically when the door is closed. Please contact your nearest Land Rover Retailer for fitment options.



Fixed Side Steps³

The side step aids entry and exit to the vehicle, improves access to the roof and also provides a rugged, off-road style to the vehicle. Features embossed 'Discovery' branding and Bright metallic trim finish to complement the vehicle's exterior design cues.

¹Not available with Dynamic Design Pack. ²Standard as part of Complete Dynamic Design Pack with electronic air suspension.
³Fitting of side tubes and side steps may affect the off-road capability of the vehicle.

TOURING



Click and Go System

Click and Go Base required for all attachments. Click and Hook is a universal hook that creates extra storage space for items to be hung. Click and Work is a folding table especially useful on long journeys and offers the rear passengers a practical surface providing some office space and a cupholder.

Click and Go System

Click and Hang is a removable coat hanger allowing for shirts and jackets to be kept crease-free whilst transporting. Click and Play is a removable tablet holder attachment which is available for various tablets, and can be easily positioned in multiple angles for in cabin comfort and rear entertainment.

Centre Armrest Cooler/Warmer Box

Food and drinks chiller and warmer that acts as a rear centre armrest. With a leather-covered top, it is held in place by the centre seat belt and powered from the rear auxiliary socket. Ideal for long journeys with the family.



Sunshades

Easy to install or remove these sun blinds provide increased comfort helping to protect the interior from heat and glare of the sun.



Roof Rails¹

Roof rails facilitate easy fitment of cross bars for roof carrying. Pre-set positioning points ensure cross bars are fixed in optimum position for weight distribution and dynamics. Maximum payload 80kg².

Cross Bars¹

Easy to attach and remove lockable cross bars, in a durable bright finish aluminium. Aerodynamic profile minimises drag and wind noise. Incremental height of roof rails and cross bars when fitted is up to 110mm. Maximum load capacity 74kg².



Roof Box¹

Available in a range of sizes, all versions can be mounted either side for kerbside opening in any country and include integral locks for security and peace of mind. Carrying capacity ranges from 320 litres for the Sports Box to the 410 litre Luggage Box or the capacious 430 litre Large Sports Box. Maximum payload 57kg².

SPORTING



Detachable Tow Bar

Convenient and easy to use the detachable tow bar ensures a clean look when not in use. 50mm tow ball. Approved for up to 3.500kg³ maximum towing capacity and 195kg³ nose weight. Towing electrics are included.



Multi-Height Tow Bar

The multi-height tow bar contains a towing armature and slider plate. 50mm tow ball. Three different towing heights. Approved for up to 3.500kg³ maximum towing capacity and 350kg³ nose weight. Towing electrics are included.



Electrically Deployable Tow Bar

The electrically deployable tow bar is operated via a switch in the rear loadspace or by the infotainment system in the cabin. Stowed discreetly behind the rear bumper when not in use providing a clean attractive finish. The towing electrics are also hidden until deployed. Approved for up to 3.500kg³ maximum towing capacity and 350kg³ nose weight. Includes a unique trailer light test facility which allows the driver to check if the trailer lights are functioning correctly.



Tow Bar Mounted Bike Carrier⁴

Tow bar mounted bike carrier available for two or three bikes. A quick release design for ease of use and lockable for security. Maximum load capacity 51kg (on the 3 bike carrier).



Ski/Snowboard Carrier¹

Carries four pairs of skis or two snowboards and incorporates slider rails for easy loading, is also lockable for security. Maximum payload 36kg².



Protective Seat Covers

Helps protect seats from mud, dirt, wear and tear. Easily fitted and wipeable.



Body Side Mouldings

Enhances the side of your vehicle and provides protection for your door panels from accidental damage by adjacent vehicles.

³Towing capability varies by powertrain. Towing nose weight dependent upon powertrain and wheels fitted. A tow eye cover must also be ordered when fitting detachable tow bar. ⁴Heat shield is required for 2 and 3 tow bar mounted bike carrier.

ACTIVE



Tailgate Event Seating in Ebony Leather¹

The tailgate event seating is handcrafted from beautiful Windsor, Ebony leather with a highly durable aluminium frame. Stowed in the loadspace, these seats can be quickly and easily fitted to provide comfortable seating for two adults on the lower tailgate, when the vehicle is stationary. The seats come complete with a luxury storage bag with soft lining, which also acts as a useful protective mat to prevent the users' clothes coming into contact with the exterior vehicle surfaces when in use.



Loadspace Partition and Luggage Divider²

Designed to prevent luggage from entering the passenger compartment. The design of the luggage partition has been optimised to second row seating featuring tilt functionality. The luggage partition divider can be fitted to the luggage partition to separate the loadspace into two sections. Semi-rigid waterproof loadspace liner tray with a raised lip on three sides to protect loadspace floor and side wall carpets from dirt or wet equipment.



Loadspace Rubber Mat

The Land Rover branded waterproof rubber mat helps to protect the rear loadspace carpet from general dirt.



Passenger Footwell Net

The passenger footwell net provides additional storage space within the cabin. It is easily accessible and ideal for everyday small items such as maps and letters.



Mudflaps

Mudflaps are a popular upgrade for reducing spray and ensuring paintwork is protected from debris and dirt. Engineered to complement the vehicle exterior design.



Rubber Floor Mats

Rubber footwell mats help provide protection from general dirt.

LIFESTYLE



Pet Loadspace Protection Pack

Designed to provide water resistant protection and easy cleaning of the loadspace from wet and muddy paws. Combines the quilted loadspace liner, full height luggage partition and spill resistant water bowl.



Pet Transportation Pack

Convenient option to provide a comfortable environment for transporting pets, which can be fitted or removed quickly as and when required. Combines the foldable pet carrier, spill resistant water bowl and loadspace rubber mat.



Pet Care and Access Pack

Taking the effort out of transporting pets, this option ensures everything required is to hand to transport pets in comfort. Combines the full height luggage partition, quilted loadspace liner, pet access ramp and portable rinse system.



Wireless Phone Charging Cupholder

The wireless phone charging cupholder has been designed to charge utilising the cup holder space in the centre console. The holder will accommodate varying phone sizes securely in place. The charger displays an LED light to indicate when charging, and turns off when complete. Fits phones up to 72mm wide.



Aqua Sports Carrier³

Carries one sailboard, canoe or kayak (two Kayak Carrier carries two kayaks or canoes). Includes lockable multi-purpose holder to carry oars or paddles. Tilts to facilitate easy loading/unloading. Features lockable straps and rubber supports to maintain optimum weight distribution whilst protecting the kayak and vehicle from scratches/scuffs. Maximum load capacity 45kg⁴.

Aqua Sports Carrier - two Kayaks (not shown)³



Versatile Roof Rack³

The versatile roof rack has a lightweight and fully integrated design which provides a large volume carrying capacity. When fitted maximum load capacity 60kg⁴.

³Roof rails and cross bars are required for all Land Rover roof mounted accessories. Objects placed above the roof mounted satellite antenna may reduce the quality of the signal received by the vehicle and could have a detrimental effect on the navigation and satellite radio system, if fitted. ⁴Maximum payload equals the load capacity of the roof mounted accessory.

THE WORLD OF LAND ROVER

Your Land Rover has been designed and engineered to help you make more of your world. It can take you to places other vehicles simply can't reach in a style that cannot be matched. To celebrate the Land Rover lifestyle, we've put together a range of experiences, publications and the Land Rover Lifestyle Collection. There's a world to explore. Get out there and enjoy it.

EXPERIENCE DRIVES



Bring out your adventurous side and experience Land Rover's legendary capability for yourself. Under the expert guidance of a world-class instructor, head to the most exciting and challenging off-road terrains and take the vehicle to its limits.

landrover.com/experience

ADVENTURE TRAVEL



From the sheer exhilaration of the Arctic ice to the awe-inspiring dunes of Namibia, Land Rover Adventure Travel offers you once-in-a-lifetime experiences that bring the spirit and emotion of our vehicles to life.

landrover.com/adventure

Follow us on:



MANUFACTURING TOURS



This is a unique opportunity to step inside our state-of-the-art manufacturing facilities and see where the latest vehicles are born. Taking you behind the scenes, our expert tour guides will show you how Land Rover combines unrivalled craftsmanship with cutting-edge robotics.

landrover.com/tours

SPECIAL VEHICLE OPERATIONS



Whether it's class-leading luxury, thrilling performance or extreme all-terrain capability, Land Rover excels. Special Vehicle Operations takes this even further. Delivering the absolute pinnacle of Land Rover engineering and design, each vehicle combines peerless refinement with power and cutting-edge technology, which is why the SV badge represents so much.

landrover.com/svo

THE LAND ROVER LIFESTYLE COLLECTION



Our latest range of clothing and lifestyle accessories are crafted with the same design excellence and attention to detail, as our vehicles. Inspired by our unique heritage, there is something for the whole family.

landrover.com/collection

ONELIFE MAGAZINE



Free twice a year for your first three years as a Land Rover owner, this award-winning magazine features the best in photography, authoritative journalism and expert insights. Onelife takes you right into the heart of exclusive experiences and extraordinary adventures, whilst keeping you up to date with the latest innovations, design and lifestyle choices.

landrover.com/onelife

Follow us on:



BRAND PARTNERSHIPS



Integrity. Courage. Pride. These are the values that Land Rover shares with its partners. Whether it's the Invictus Games, Virgin Galactic, Rugby World Cup 2019™ or the British and Irish Lions, each one is driven by exceptional people. Those who push their capabilities to the very limits and champion the determination to go above and beyond.

landrover.com/partnerships

HUMANITARIAN PARTNERSHIPS



Since 1954, Land Rover is proud to have supported the incredible humanitarian work of the International Federation of Red Cross and Red Crescent Societies (IFRC). Through vehicles, funding and combined expertise, this ambitious global partnership has helped to transform the lives of over one million people, across four continents.

landrover.com/responsibility



YOUR PEACE OF MIND

CUSTOMER SERVICE

When you bring your Land Rover to us, we use cutting-edge diagnostic equipment to assess all your vehicle's mechanical and electronic systems. Our qualified Technicians use tools specifically designed for our vehicles and only fit genuine Land Rover parts and Gear accessories. A choice of service plans are available which, together with Roadside Assistance, ensures complete peace of mind.

For further details contact your local Land Rover Retailer or search 'Land Rover Ownership'.

LAND ROVER ROADSIDE ASSISTANCE

Land Rover Assistance provides assistance in motoring emergencies, from immobilisation due to breakdown or accident to minor problems such as punctures. You can rely on our roadside assistance, whatever the situation, wherever you happen to be.

For further details please consult your Warranty Benefits handbook, contact your nearest Land Rover Approved Service Centre or search 'Land Rover Roadside Assistance'.

IMPORTANT NOTICE: Jaguar Land Rover Limited is constantly seeking ways to improve the specification, design and production of its vehicles, parts and accessories and alterations take place continually. Whilst every effort is made to produce up-to-date literature, this brochure should not be regarded as an infallible guide to current specifications or availability, nor does it constitute an offer for the sale of any particular vehicle, part or accessory. Distributors and Retailers are not agents of Jaguar Land Rover Limited by any express or implied undertaking or representation.

TECHNICAL SPECIFICATION

If not enclosed, please contact your local Land Rover Retailer.

LAND ROVER FINANCIAL SERVICES

Getting the keys to your very own Land Rover has never been so simple. And it's more affordable than you might think. New or used, for personal or business use, we have an option that puts you in complete control.

For further details contact your local Land Rover Retailer or search 'Land Rover Finance'.

FLEET & BUSINESS

Land Rover is dedicated to being the premium manufacturer of choice for fleets and businesses, by providing a highly attractive range of vehicles and exemplary customer service. Distinctive, capable and versatile, all Land Rover vehicles deliver low Total Cost of Ownership through strong residual values, competitive service, maintenance and repair costs, and impressive fuel economy and CO₂ emissions.

We are also committed to providing a totally customer-focused aftersales service, which will ensure every Land Rover vehicle is kept on the road and in top condition, in the easiest and most cost-efficient way for businesses.

Search 'Land Rover Fleet and Business' for full details.

Images are for illustrative purposes only. Colours reproduced on-screen may vary compared to actual finish. The company reserves the right to alter or withdraw any colour finish without notice. Some of these colours may not be obtainable in your country. Please check availability of colours and current specifications with your Land Rover Retailer. Distributors and retailers are not agents of Jaguar Land Rover Limited and have absolutely no authority to bind Jaguar Land Rover Limited to any express or implied undertaking or representation.

Castrol EDGE Professional exclusively recommended by Land Rover.

Vehicle shown left is HSE Luxury in Silicon Silver with optional features fitted (market dependent).

Vehicle shown on front and back cover is Landmark Edition in Eiger Grey with optional features fitted (market dependent).

Jaguar Land Rover Limited

Registered Office: Abbey Road, Whitley,
Coventry CV3 4LF United Kingdom.

Registered in England: Number 1672070

landrover.com

© Copyright Jaguar Land Rover Limited 2019.

1L4622010000BXXEN01P



DISCOVERY

TECHNICAL SPECIFICATION
2019



ABOVE & BEYOND



ENGINES

You can select from a choice of 2,0 and 3,0 litre diesel or petrol engines. These engines are designed for clean and efficient combustion and are all equipped with Stop/Start technology.

Configure your Discovery at landrover.com

TECHNICAL SPECIFICATION

			DIESEL				PETROL				
POWERTRAIN			Sd4		Sd6		Si4				
Transmission			Automatic		Automatic		Automatic				
Driveline			All Wheel Drive (AWD)		All Wheel Drive (AWD)		All Wheel Drive (AWD)				
Maximum power (PS/rpm)			240 / 4.000		306 / 3.750		300 / 5.500				
Maximum torque (Nm/rpm)			430 / 1.400		700 / 1.500-1.750		400 / 1.500-4.000				
Capacity (cc)			1.999		2.993		1.997				
No. of cylinders/Valves per cylinder			4 / 4		6 / 4		4 / 4				
Cylinder layout			Longitudinal In-Line		Longitudinal V6		Longitudinal In-Line				
Bore/stroke (mm)			83,0 / 92,4		84,0 / 90,0		83,0 / 92,29				
Compression ratio (:1)			15,5+ / -0,5		16,1		9,5+ / -0,5				
FUEL ECONOMY - NEDC EQUIVALENT (NEDC2)*			Class A		Class B		Class A		Class B		
Seating			5 / 7		5 / 7		5 / 7		5 / 7		
NEDC2 Consumption	Urban	l/100km (mpg)	8,4 (33,6) / 8,6 (32,8)		8,5 (33,2) / 8,8 (32,1)		8,7 (32,5) / 8,7 (32,5)		8,8 (32,1) / 8,9 (31,7)		
	Extra Urban	l/100km (mpg)	6,6 (42,8) / 6,7 (42,2)		6,7 (42,2) / 6,8 (41,5)		6,8 (41,5) / 6,8 (41,5)		7,0 (40,4) / 7,0 (40,4)		
	Combined	l/100km (mpg)	7,2 (39,2) / 7,4 (38,2)		7,4 (38,2) / 7,5 (37,7)		7,5 (37,7) / 7,5 (37,7)		7,6 (37,2) / 7,7 (36,7)		
NEDC2 CO ₂ Emissions	Urban	(g/km)	220 / 227		225 / 231		228 / 229		233 / 233		
	Extra Urban	(g/km)	174 / 176		176 / 178		179 / 180		183 / 184		
	Combined	(g/km)	191 / 194		194 / 197		197 / 198		201 / 202		
FUEL ECONOMY - WLTP**			TEL-TEH [†]		TEL-TEH [†]		TEL-TEH [†]		TEL-TEH [†]		
Seating			5 / 7		5 / 7		5 / 7		5 / 7		
WLTP Consumption Test Energy	Low	l/100km (mpg)	11,3-11,9 (25,1-23,7) / 11,4-12,0 (24,8-23,5)			11,7-12,6 (24,2-22,5) / 11,8-12,7 (23,9-22,2)			15,3-15,9 (18,5-17,8) / 15,4-16,0 (18,3-17,7)		
	Medium	l/100km (mpg)	8,1-9,4 (34,7-30,1) / 8,3-9,5 (33,9-29,7)			8,7-10,0 (32,5-28,3) / 8,9-10,2 (31,8-27,8)			10,4-11,5 (27,1-24,6) / 10,6-11,7 (26,6-24,1)		
	High	l/100km (mpg)	7,2-8,2 (39,0-34,4) / 7,3-8,3 (38,5-34,1)			7,6-8,5 (37,1-33,3) / 7,7-8,6 (36,7-32,9)			9,0-10,0 (31,2-28,2) / 9,2-10,1 (30,8-27,8)		
	Extra High	l/100km (mpg)	8,1-9,4 (34,7-30,2) / 8,2-9,4 (34,3-30,0)			9,0-10,0 (31,4-28,3) / 9,1-10,1 (31,2-28,1)			10,8-12,1 (26,1-23,4) / 10,9-12,2 (25,8-23,1)		
	Combined	l/100km (mpg)	8,3-9,3 (34,1-30,2) / 8,4-9,4 (33,6-30,0)			8,9-9,9 (31,9-28,6) / 9,0-10,0 (31,5-28,3)			10,8-11,8 (26,2-23,9) / 10,9-12,0 (25,8-23,6)		
WLTP CO ₂ Emissions	Low	(g/km)	282-312 / 288-315			306-330 / 310-334			345-359 / 349-362		
	Medium	(g/km)	214-246 / 219-249			228-262 / 233-267			236-260 / 241-265		
	High	(g/km)	190-215 / 193-217			199-223 / 202-225			205-226 / 208-229		
	Extra High	(g/km)	218-245 / 220-247			236-262 / 238-264			245-273 / 248-276		
	Combined	(g/km)	217-245 / 220-247			232-259 / 235-262			244-267 / 247-271		

*The figures provided are NEDC2 calculated from official manufacturer's WLTP tests in accordance with EU legislation. For comparison purposes only. Real world figures may differ. CO₂ and fuel economy figures may vary according to wheel fitment and optional extras fitted. NEDC2 are figures calculated using a Government formula from WLTP figures equivalent to what they would have been under the old NEDC test. The correct tax treatment can then be applied. **WLTP is the new official EU test used to calculate standardised fuel consumption and CO₂ figures for passenger cars. It measures fuel, energy consumption, range and emissions. This is designed to provide figures closer to real-world driving behaviour. It tests vehicles with optional equipment and with a more demanding test procedure and driving profile. [†]TEL (Test Energy Low) and TEH (Test Energy High) figures are shown as a range under WLTP testing measures. TEL refers to the lowest/most economical figures (with the lightest set of options). TEH refers to the highest/least economical figures (with the heaviest set of options). WLTP legislation dictates that where there is <5g CO₂ variance between TEL and TEH, only the TEH is declared.

TECHNICAL SPECIFICATION

FUEL ECONOMY - CONTINUED	DIESEL		PETROL
	Sd4	Sd6	Si4
Fuel tank capacity - useable litres	77	85	90
Diesel Exhaust Fluid (DEF) - useable litres	18	18	-
Diesel Particulate Filter (DPF)	■	■	-
PERFORMANCE			
Acceleration (secs) 0-100km/h (0-60 mph)	8,7 (8,3)	7,5 (7,0)	7,7 (7,3)
Maximum speed km/h (mph)	207 (128)	209 (130)	201 (125)
BRAKES			
Front type	2 x 48mm sliding fist caliper	2 x 48mm sliding fist caliper	2 x 48mm sliding fist caliper
Front diameter (mm)	349	363	349
Rear type	45mm sliding fist caliper	45mm sliding fist caliper	45mm sliding fist caliper
Rear diameter (mm)	325	350	325
Park Brake	Integrated motor-on caliper	Integrated motor-on caliper	Integrated motor-on caliper
WEIGHTS (kg)^{††}			
Seating	5 / 7	5 / 7	5 / 7
Unladen weight (EU) [‡]	2.184	2.311	2.161
Unladen weight (DIN) ^{‡‡}	2.109	2.236	2.086
Gross Vehicle Weight (GVW)	2.940 / 3.130	3.050 / 3.200	2.900 / 3.070
TOWING (kg)			
Seating	5 / 7	5 / 7	5 / 7
Unbraked trailer	750	750	750
Maximum towing ^Δ	3.500	3.500	3.000
Maximum coupling point/nose weight [∅]	350	350	350
Maximum vehicle and trailer combination	6.440 / 6.630	6.550 / 6.700	5.900 / 6.070
ROOF CARRYING (kg)			
Maximum roof load (including cross bars)	80	80 ▲	80

■ Standard - Not Available.

Class A (20-22" wheels) Class B (19" wheels)

^{††}Weights reflect vehicles to standard specifications. Optional extras increase weight. [‡]Includes a 75kg driver, full fluids and 90% fuel. ^{‡‡}Includes full fluids and 90% fuel. ^ΔMaximum towing capacity is limited to 2,500kg when the 20" aerodynamic wheel (031GJ) is fitted to 7-seat variants. [∅]When fitted with Electrically Deployable Tow Bar. 195kg with Detachable Tow Bar. ▲Roof carrying load increased from 80kg to 100kg when SD6 selected with Adaptive Dynamics.

DIMENSIONS AND CAPABILITIES

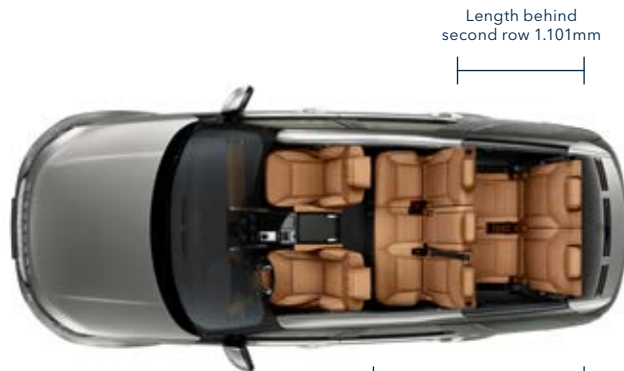

Length behind second row 1.101mm

Loadspace width 1.411mm*

Length behind first row 1.954mm

Standard Ride Height

Air suspension 1.888mm
Coil suspension 1.909mm

Headroom

Maximum front/rear headroom with standard roof 1.001mm/991mm
Maximum front/rear headroom with panoramic roof 1.016mm/991mm

Legroom

Maximum front legroom 993mm
Maximum rear legroom second row 954mm
Maximum rear legroom third row 850mm

Loadspace Capacity

Height 854mm, Width 1.411mm
Loadspace width between arches 1.200mm

Maximum loadspace volume behind first row
Dry 2.068 litres**, Wet 2.500 litres†

Maximum loadspace volume behind second row
Dry 986 litres**, Wet 1.231 litres†

Maximum loadspace volume behind third row
Dry 172 litres**, Wet 258 litres†

Obstacle Clearance

Air suspension 207mm
Coil suspension 215mm

Turning Circle

Kerb-to-kerb 12,4m
Wall-to-wall 12,4m
Turns lock-to-lock 2,7

Wading Depth††

Maximum wading depth
Air suspension 900mm
Coil suspension 850mm

Overall length 4.956mm



Width 2.073mm mirrors folded
Width 2.220mm mirrors out



Front wheel track†
Air suspension 1.692mm
Coil suspension 1.689mm

Height
Air suspension 1.888mm
Coil suspension 1.909mm



Rear wheel track†
Air suspension 1.687mm
Coil suspension 1.685mm



	A	B	C
Ride Height			
Approach Angle	34,0°	27,5°	30,0°
Ramp Angle		22,2°	
Departure Angle			25,9°
Coil suspension	26,3°		



*Loadspace width will be 1.273 when 4-zone climate control is fitted. **Dry: Volume as measured with VDA-compliant solid blocks (200mm x 50mm x 100mm). †Wet: Volume as measured by simulating the loadspace filled with liquid. ††Wading depth (25 deg entry and exit) 750mm, deep fording depth (9 deg entry and exit) 900mm. †When fitted with 21" wheels.