

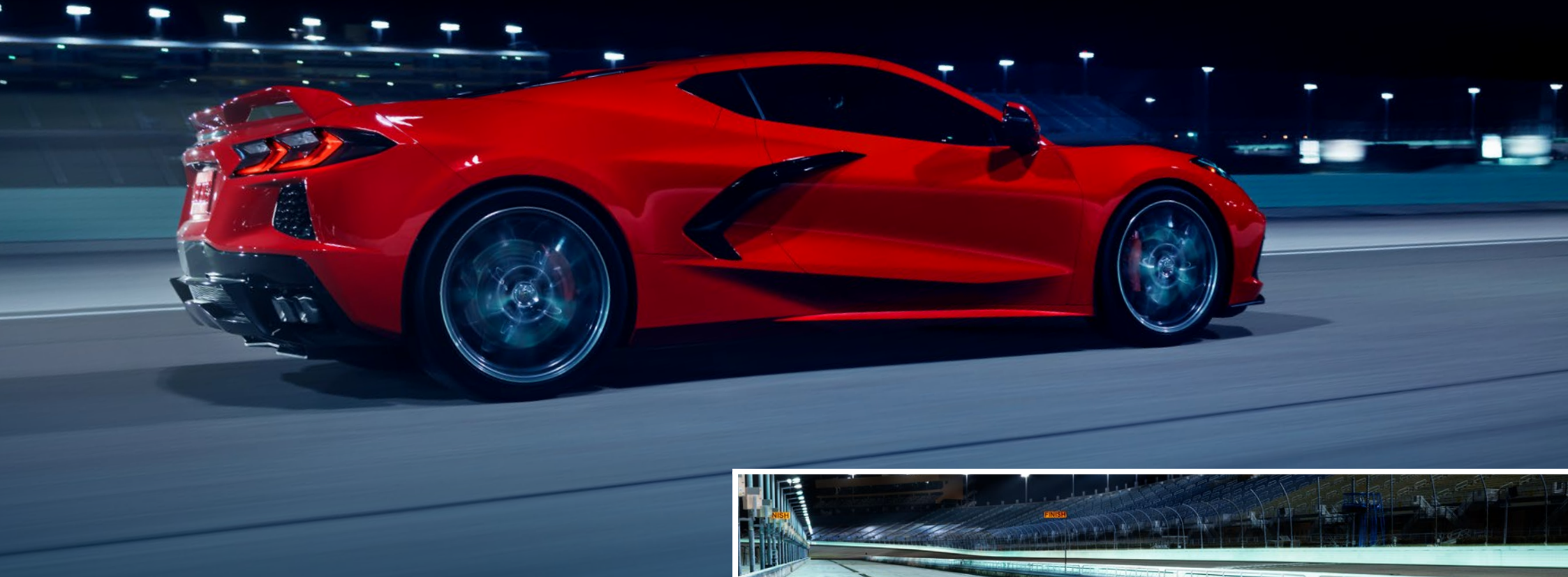

**CHEVROLET CORVETTE STINGRAY  
EQUIPMENT & PRICES**

**MODEL YEAR 2023**

CHEVROLET CORVETTE STINGRAY



CHEVROLET CORVETTE STINGRAY



# Z51 PERFORMANCE PACKAGE

## THE PINNACLE OF PERFORMANCE

The architecture, structure, suspension, calibrations and software of Stingray are all ready to deliver a driving experience beyond your imagination. To reach the pinnacle, all European Corvette Stingray come standard with the Z51 Performance Package, which provides a group of performance enhancements, including:

- Z51 performance suspension
- Z51 performance Brembo® brakes
- Michelin® Pilot® Sport 4S, 245/35ZR19 front and 305/30ZR20 rear, high performance, run-flat, summer-only tires<sup>1</sup>
- Electronic Limited Slip Differential (eLSD)
- Performance exhaust
- Performance rear axle ratio
- Heavy-duty cooling system
- Z51 rear spoiler in body color
- Z51 front splitter



<sup>1</sup> Do not use summer-only tires in winter conditions, as it would adversely affect vehicle safety, performance and durability. Use only GM-approved tire and wheel combinations. Unapproved combinations may change the vehicle's performance characteristics. For important tire and wheel information, please contact your Chevrolet Partner. Low-profile tires wear faster, and wheel and tire damage may occur on rough or damaged roads from surfaces or kerbs, debris or obstacles. This damage is not covered by the GM New Vehicle Limited Warranty.

## PRICE TABLE

	PRICE (INCL. VAT) <sup>1</sup>	1ST YEAR VED	VAT 20%	TRANSPORT (EXCL. VAT)	NET CONSUMER PRICE (EXCL. VAT)
Corvette Stingray Coupe 2LT	79'320 £	2'420 £	12'817 £	700 £	63'383 £
Corvette Stingray Coupe 3LT	82'270 £	2'420 £	13'308 £	700 £	65'842 £
Corvette Stingray Convertible 2LT	84'320 £	2'420 £	13'650 £	700 £	67'550 £
Corvette Stingray Convertible 3LT	87'270 £	2'420 £	14'142 £	700 £	70'008 £

Chevrolet Corvette Stingray 6.2L V8 - Fuel consumption, combined (mpg): 23.3. CO<sub>2</sub> emissions, combined (g/km): 277. Energy efficiency category: M.

The WLTP figures shown have been measured as per the Worldwide Harmonised Light Vehicle Test Procedure (WLTP) according to Regulation (EC) No 715/2007 in the version valid for type-approval of the vehicle model concerned.

## ENGINE

## CORVETTE STINGRAY

Engine	6,2 L V8 direct-injection petrol engine with variable valve timing and Active Fuel Management (cylinder deactivation technology)
Transmission	8-speed, dual-clutch transmission
Fuel type	Petrol
Displacement	6162 cm <sup>3</sup>
Bore	103.25 mm
Stroke	92.0 mm
Compression ratio	11.5 : 1
Power output	354 kW/482 hp @ 6450 rpm
Torque	613 Nm @ 4500 rpm
Top speed	184 mph
Acceleration, 0-62 mph	3.5 sec
Valvetrain	Overhead valve, two valves per cylinder; dual-equal variable valve timing
Oiling system	Dry sump-type, includes oil-spray piston cooling

## FUEL CONSUMPTION & CO<sub>2</sub> EMISSIONS(WLTP)<sup>2</sup>

## CORVETTE STINGRAY

Emission class	Euro 6d
Energy efficiency category	M
Fuel consumption, combined	23.3 mpg
Fuel consumption, low	11.6 mpg
Fuel consumption, mid	23.6 mpg
Fuel consumption, high	29.4 mpg
Fuel consumption, extra-high	28.8 mpg
CO <sub>2</sub> emissions, combined	277 g/km
CO <sub>2</sub> emissions, low	555 g/km
CO <sub>2</sub> emissions, mid	274 g/km

<sup>1</sup> Total on-the-road recommended retail prices include number plates and delivery to retailer, 12 months' Vehicle Excise Duty and new vehicle first registration fee of £55.00. All prices are suggested retail prices for model year 2023, including 20% VAT.

<sup>2</sup> The WLTP figures shown have been measured as per the Worldwide Harmonised Light Vehicle Test Procedure (WLTP) according to Regulation (EC) No 715/2007 in the version valid for type-approval of the vehicle model concerned.

Figures shown are for comparability purposes; only compare fuel consumption and CO<sub>2</sub>-emissions figures with other vehicles tested to the same technical procedures. These figures may not reflect real life driving results, which will depend upon a number of factors including the accessories fitted (post-registration), variations in weather conditions, driving styles and vehicle load. The figures do not relate to a specific vehicle and are not part of an offer.

• Standard ○ Available – Not available

CO <sub>2</sub> emissions, high	220 g/km
CO <sub>2</sub> emissions, extra-high	224 g/km

CHASSIS & SUSPENSION	CODE	CORVETTE STINGRAY
Drive Axle		Rear-wheel drive
Steering		Variable-ratio rack-and-pinion with electric power assist; includes Active Steer Stops with available Magnetic Selective Ride Control
Suspension		Short / long arm (SLA) double wishbone, forged aluminum upper and cast aluminum L shape lower control arms; monotube shock absorbers (46mm)
Brakes		Front and rear e-boost-assisted discs with Brembo four-piston monobloc caliper
Launch Control		•
Driver Mode Selector		•
Active handling stability control with traction control		•
Magnetic Selective Ride Control™ suspension with Performance Traction Management	FE4	1'940 £

EQUIPMENT	CODE	COUPE		CONVERTIBLE	
		2LT	3LT	2LT	3LT
<b>CONVENIENCE</b>					
Dual-zone automatic climate control with individual climate settings for driver and passenger		•	•	•	•
Air filtration system with pollen filter		•	•	•	•
Power rake and telescopic steering column		•	•	•	•
Automatic heated steering wheel		•	•	•	•
Steering-wheel-mounted paddle shift controls		•	•	•	•
Steering wheel controls for audio, phone, Cruise Control and Driver Information Center		•	•	•	•
Memory Package - Steering wheel, outside mirrors and seat memory for driver and passenger		•	•	•	•
Rear Camera Mirror		•	•	•	•
HD front and rear vision cameras, front camera with curb view		•	•	•	•
Ultrasonic Rear Parking Assist <sup>3</sup>		•	•	•	•
Front lift with memory <sup>4</sup>	E60	1'580 £	1'580 £	1'580 £	1'580 £
Cruise Control		•	•	•	•
Full-color Head-Up Display, configurable		•	•	•	•
Driver and passenger power windows with express-up and -down		•	•	•	•
Headlamps, automatic on/off with tunnel detection		•	•	•	•
Automatic headlamp leveling system		•	•	•	•
Performance Data Recorder <sup>5</sup>		•	•	•	•
Keyless access, push-button start		•	•	•	•
Valet Mode		•	•	•	•
Battery protection package <sup>6</sup>	ERI	80 £	80 £	80 £	80 £
Cargo nets		•	•	•	•

<sup>3</sup> Availability of this feature may be limited and only given at a later stage. <sup>4</sup> The front lift raises the front of the vehicle approximately 50 mm in less than 3 seconds at lower speeds (up to 24 mph) and remembers up to 1'000 GPS locations.

<sup>5</sup> The driver has to ensure compliance with privacy law and other applicable laws when using the PDR System. Such laws may in particular restrict or exclude the use of the PDR-System on public streets.

<sup>6</sup> Includes a device to charge and condition the car battery, helping maintain optimum functionality when parked for long periods.

• Standard ○ Available – Not available

EQUIPMENT	CODE	COUPE		CONVERTIBLE	
		2LT	3LT	2LT	3LT

### SEATING COMFORT

GT1 bucket seats		•	–	•	–
GT2 bucket seats	AH2	1'780 £	•	1'780 £	•
Competition Sport bucket seats	AE4	2'590 £	810 £	2'590 £	810 £
Heated and ventilated driver and passenger seats		•	•	•	•
8-way power-adjustable driver seat		•	•	•	•
8-way power-adjustable passenger seat		•	•	•	•
2-way power lumbar adjuster, driver seat		•	•	•	•
2-way power lumbar adjuster, passenger seat		•	•	•	•
Driver seat with power-adjustable seatback side bolsters		•	•	•	•
Passenger seat with power-adjustable seatback side bolsters		•	•	•	•
Two-tone seats	TU7	320 £	320 £	320 £	320 £

### AUDIO & COMMUNICATION

Driver Information Center with configurable high-resolution 12" color display		•	•	•	•
Chevrolet Premium Infotainment System with navigation, 8" HD color touchscreen, voice recognition, USB ports, auxiliary audio port and SD card reader <sup>7</sup>		•	•	•	•
Bose® Performance Series Sound System with 14 speakers and Active Noise Cancellation technology		•	•	•	•
Digital Audio Broadcast, DAB/DAB+/DMB-R		•	•	•	•
Wireless mobile phone charging <sup>8</sup>		•	•	•	•
Smartphone integration via Apple CarPlay™ and Android Auto™ <sup>9</sup>		•	•	•	•
Near Field Communication		•	•	•	•

### SAFETY & SECURITY

Side Blind Zone Alert		•	•	•	•
Rear Cross-Traffic Alert		•	•	•	•
Theft deterrent system, unauthorized entry		•	•	•	•
Theft deterrent sensor, body security content		•	•	•	•
Theft deterrent sensor, vehicle inclination		•	•	•	•
Theft deterrent sensor, vehicle interior movement		•	•	•	•
Self-powered theft deterrent alarm system		•	•	•	•
Steering column lock		•	•	•	•
Airbags: driver and passenger, frontal and side impact with Passenger Sensing System		•	•	•	•
Automatic emergency call		•	•	•	•
Thatcham approved locking wheel nuts		•	•	•	•

<sup>7</sup> Voice recognition is available in the following languages: English, French, German, Dutch, Italian, Polish, Danish, Portuguese, Spanish, Turkish and Russian. <sup>8</sup> The system wirelessly charges one PMA- or Qi- compatible mobile device. Mobile phone must support wireless charging for functionality. <sup>9</sup> Vehicle user interfaces are products of Apple and Google and their terms and privacy statements apply. Requires compatible smartphone and data plan rates apply. Android Auto™ requires a smartphone running Android Lollipop 5.0 OS or above; Apple CarPlay™ requires an iPhone 5 or later. Full lists of supported apps are available at [Apple.com/ios/carplay](http://Apple.com/ios/carplay) and [Android.com/auto](http://Android.com/auto). Please note that availability of apps may vary by market.

• Standard ○ Available – Not available

EQUIPMENT	CODE	COUPE		CONVERTIBLE	
		2LT	3LT	2LT	3LT

## EXTERIOR

Heated, power-adjustable, power-folding, driver-side auto-dimming outside mirrors in body color, with integrated turn signal indicators		•	•	•	•
LED headlamps with daytime running functionality		•	•	•	•
Rear fog lamps		•	•	•	•
Solar-Ray® light-tinted glass		•	•	•	•
Hatch release, push button open		•	•	-	-
Trunk release, push button open		-	-	•	•
Tailpipe, bright		•	•	•	•
Capless fueling system		•	•	•	•
Carbon Flash accents package - Rear spoiler and outside mirrors	ZYC	1'220 £	1'220 £	1'220 £	1'220 £
Carbon Flash exterior trim - Side vents, front/rear grille (and tonneau grille on convertible)		•	•	•	•
Body-color exterior trim - Side vents, front/rear grille (and tonneau grille on convertible) <sup>10</sup>	EFY	410 £	410 £	410 £	410 £
Shadow Gray exterior trim - Side vents, front/rear grille (and tonneau grille on convertible)	EFA	410 £	410 £	410 £	410 £
Exterior badges in Carbon Flash		•	•	•	•
Exterior badges in chrome	EYK	240 £	240 £	240 £	240 £
Body-color roof panel <sup>11</sup>		•	•	-	-
Transparent roof panel <sup>11</sup>	CC3	770 £	770 £	-	-
Visible carbon fiber roof panel with body-color surround <sup>11</sup>	C2Z	1'500 £	1'500 £	-	-
Dual roof panel package: one body-color and one transparent <sup>11</sup>	C2Q	1'500 £	1'500 £	-	-
Dual roof panel package: one transparent and one visible carbon fiber with body-color surround <sup>11</sup>	C2M	2'270 £	2'270 £	-	-



Body-color roof panel (standard)



Transparent roof panel (CC3)



Visible carbon fiber roof panel with body-color surround (C2Z)



Dual roof panel package: one body-color and one transparent (C2Q)



Dual roof panel package: one transparent and one visible carbon fiber with body-color surround (C2M)

<sup>10</sup> Not available with exterior color Black.

<sup>11</sup> Removable, stores securely in the rear trunk.  
 • Standard ○ Available - Not available



EQUIPMENT	CODE	COUPE		CONVERTIBLE	
		2LT	3LT	2LT	3LT
Power-retractable convertible hardtop <sup>12</sup>		-	-	•	•
Carbon Flash nacelles and body-color roof <sup>13</sup>	D86	-	-	490 £	490 £
Carbon Flash nacelles and roof <sup>13</sup>	D84	-	-	1'220 £	1'220 £



standard



Carbon Flash nacelles and body-color roof (D86)



Carbon Flash nacelles and roof (D84)

5-open-spoke Bright Silver-painted aluminum wheels: 19 X 8.5 J front and 20 X 11.0 J rear		•	•	•	•
5-open-spoke Carbon Flash-painted aluminum wheels with machined edge: 19 X 8.5 J front and 20 X 11.0 J rear	Q8Q	770 £	770 £	770 £	770 £
5-trident-spoke machined-face Sterling Silver-painted aluminum wheels: 19 X 8.5 J front and 20 X 11.0 J rear	Q8S	1'170 £	1'170 £	1'170 £	1'170 £
5-trident-spoke machined-face Spectra Gray-painted aluminum wheels: 19 X 8.5 J front and 20 X 11.0 J rear	Q8T	1'170 £	1'170 £	1'170 £	1'170 £
20-spoke gloss Black-painted forged aluminum wheels: 19 X 8.5 J front and 20 X 11.0 J rear	Q9I	1'170 £	1'170 £	1'170 £	1'170 £
20-spoke bright machined-face After Midnight-painted forged aluminum wheels: 19 X 8.5 J front and 20 X 11.0 J rear	Q99	1'540 £	1'540 £	1'540 £	1'540 £



5-open-spoke Bright Silver-painted aluminum wheels: 19 X 8.5 J front and 20 X 11.0 J rear (standard)



5-open-spoke Carbon Flash-painted aluminum wheels with machined edge: 19 X 8.5 J front and 20 X 11.0 J rear (Q8Q)



5-trident-spoke machined-face Sterling Silver-painted aluminum wheels: 19 X 8.5 J front and 20 X 11.0 J rear (Q8S)



5-trident-spoke machined-face Spectra Gray-painted aluminum wheels: 19 X 8.5 J front and 20 X 11.0 J rear (Q8T)



20-spoke gloss Black-painted forged aluminum wheels: 19 X 8.5 J front and 20 X 11.0 J rear (Q9I)



20-spoke bright machined-face After Midnight-painted forged aluminum wheels: 19 X 8.5 J front and 20 X 11.0 J rear (Q99)

Black-painted brake calipers		•	•	•	•
Bright Red-painted brake calipers	J6F	490 £	490 £	490 £	490 £
Edge Red-painted brake calipers	J6N	490 £	490 £	490 £	490 £
Edge Yellow-painted brake calipers	J6E	490 £	490 £	490 £	490 £



Black-painted brake calipers (standard)



Bright Red-painted brake calipers (J6F)



Edge Red-painted brake calipers (J6N)



Edge Yellow-painted brake calipers (J6E)

<sup>12</sup> Convertible hardtop can be raised or lowered while driving at speeds up to 31 mph. Operates with the press of a button (up or down) or remotely using the key fob (down only). <sup>13</sup> Not available with exterior color Black

• Standard ○ Available - Not available

EQUIPMENT	CODE	COUPE		CONVERTIBLE	
		2LT	3LT	2LT	3LT
		Carbon Flash full length dual racing stripes	DTH	650 £	650 £
Midnight Gray full length dual racing stripes	DX0	650 £	650 £	650 £	650 £
Sterling Silver full length dual racing stripes	DUB	650 £	650 £	650 £	650 £
Edge Red full length dual racing stripes <sup>14</sup>	DSZ	650 £	650 £	650 £	650 £
Edge Yellow full length dual racing stripes <sup>15</sup>	DT0	650 £	650 £	650 £	650 £
Edge Orange full length dual racing stripes <sup>16</sup>	DSY	650 £	650 £	650 £	650 £
Edge Blue full length dual racing stripes <sup>17</sup>	DUW	650 £	650 £	650 £	650 £
Midnight Silver/Carbon Flash stinger hood stripe	DZV	325 £	325 £	325 £	325 £
Edge Red/Carbon Flash stinger hood stripe <sup>14</sup>	DZX	325 £	325 £	325 £	325 £
Edge Yellow/Carbon Flash stinger hood stripe <sup>15</sup>	DZU	325 £	325 £	325 £	325 £



Carbon Flash full length dual racing stripes (DTH)



Midnight Gray full length dual racing stripes (DX0)



Sterling Silver full length dual racing stripes (DUB)



Edge Red full length dual racing stripes (DSZ)



Edge Yellow full length dual racing stripes (DT0)



Edge Orange full length dual racing stripes (DSY)



Edge Blue full length dual racing stripes (DUW)



Midnight Silver/Carbon Flash stinger hood stripe (DZV)



Edge Red/Carbon Flash stinger hood stripe (DZX)



Edge Yellow/Carbon Flash stinger hood stripe (DZU)

<sup>14</sup> Not available with exterior colors Torch Red and Tactical Red Tintcoat.

<sup>15</sup> Not available with exterior color Accelerate Yellow Metallic.

<sup>16</sup> Not available with exterior color Amplify Orange Tintcoat.

<sup>17</sup> Not available with exterior colors Elkhart Lake Blue Metallic and Rapid Blue.

• Standard ○ Available – Not available

EQUIPMENT	CODE	COUPE		CONVERTIBLE	
		2LT	3LT	2LT	3LT

**INTERIOR**

Leather-wrapped steering wheel, flat top and bottom		•	•	•	•
Sueded microfiber-wrapped steering wheel, flat top and bottom		○	○	○	○
Leather-wrapped interior package - Upper instrument panel, door panels and console cover		-	•	-	•
Sueded microfiber-wrapped upper interior trim - Headliner, visors and A-pillar trim		-	•	-	•
Carbon fiber interior trim- Cluster-surround and console/door switch plates	FA5	1'220 £	1'220 £	1'220 £	1'220 £
Stealth aluminum interior trim, dark finish	BAZ	490 £	490 £	490 £	490 £
Carpeted floor mats		•	•	•	•
Power outlets		•	•	•	•
Black seat belts	719	0 £	0 £	0 £	0 £
Tan seat belts	3N9	320 £	320 £	320 £	320 £
Torch Red seat belts	3F9	320 £	320 £	320 £	320 £
Yellow seat belts	3M9	320 £	320 £	320 £	320 £
Orange seat belts	379	320 £	320 £	320 £	320 £
Tension Blue seat belts	3A9	320 £	320 £	320 £	320 £



Black seat belts (719)



Tan seat belts (3N9)

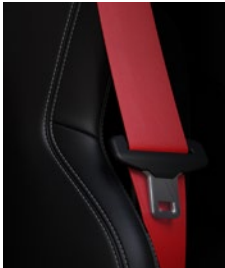

Torch Red seat belts (3F9)

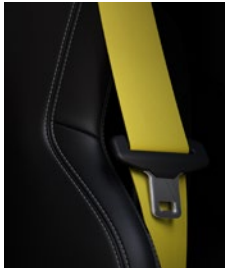

Yellow seat belts (3M9)



Orange seat belts (379)



Tension Blue seat belts (3A9)

• Standard   ○ Available   - Not available

EXTERIOR COLORS	CODE	COUPE		CONVERTIBLE	
		2LT	3LT	2LT	3LT
		Black	GBA	0 £	0 £
Arctic White	G8G	0 £	0 £	0 £	0 £
Torch Red	GKZ	0 £	0 £	0 £	0 £
Flare Silver Metallic	GSJ	970 £	970 £	970 £	970 £
Hypersonic Gray Metallic	GA7	970 £	970 £	970 £	970 £
Caffeine Brown Metallic	G48	970 £	970 £	970 £	970 £
Accelerate Yellow Metallic	GDO	970 £	970 £	970 £	970 £
Elkhart Lake Blue Metallic	GS7	970 £	970 £	970 £	970 £
Rapid Blue	GM0	970 £	970 £	970 £	970 £
Ceramic Matrix Gray Metallic	G9F	970 £	970 £	970 £	970 £
Amplify Orange Tintcoat	GC5	1'780 £	1'780 £	1'780 £	1'780 £
Tactical Red Tintcoat	GPH	1'780 £	1'780 £	1'780 £	1'780 £



Black (GBA)



Arctic White (G8G)



Torch Red (GKZ)



Flare Silver Metallic (GSJ)



Hypersonic Gray Metallic (GA7)



Caffeine Brown Metallic (G48)



Accelerate Yellow Metallic (GDO)



Elkhart Lake Blue Metallic (GS7)



Rapid Blue (GM0)



Ceramic Matrix Gray Metallic (G9F)



Amplify Orange Tintcoat (GC5)



Tactical Red Tintcoat (GPH)

• Standard ○ Available – Not available

INTERIOR COLORS	CODE	COUPE		CONVERTIBLE	
		2LT	3LT	2LT	3LT
		Jet Black Mulan leather with perforated leather seating surfaces	HTA	0 £	-
Sky Cool Gray Mulan leather with perforated leather seating surfaces	HUN	0 £	-	0 £	-
Adrenaline Red Mulan leather with perforated leather seating surfaces	HUR	0 £	-	0 £	-
Natural Mulan leather with perforated leather seating surfaces	HUV	0 £	-	0 £	-
Jet Black Nappa leather with perforated leather seating surfaces	HTM	0 £	-	0 £	-
Jet Black Nappa leather with seating surfaces and steering wheel in perforated sueded microfiber	HTP	810 £	-	810 £	-
Sky Cool Gray Nappa leather with perforated leather seating surfaces	HUK	0 £	-	0 £	-
Sky Cool Gray Nappa leather with perforated leather seating surfaces (two-tone)	HUK+TU7	320 £	-	320 £	-
Sky Cool Gray Nappa leather with seating surfaces and steering wheel in perforated sueded microfiber	HU6	810 £	-	810 £	-
Sky Cool Gray Nappa leather with seating surfaces and steering wheel in perforated sueded microfiber (two-tone)	HU6+TU7	1'130 £	-	1'130 £	-
Adrenaline Red Nappa leather with perforated leather seating surfaces	HUL	0 £	-	0 £	-
Adrenaline Red Nappa leather with perforated leather seating surfaces (two-tone)	HUL+TU7	320 £	-	320 £	-
Adrenaline Red leather with seating surfaces and steering wheel in perforated sueded microfiber	HU7	810 £	-	810 £	-
Adrenaline Red leather with seating surfaces and steering wheel in perforated sueded microfiber (two-tone)	HU7+TU7	1'130 £	-	1'130 £	-
Natural Nappa leather with perforated leather seating surfaces	HTN	0 £	-	0 £	-
Natural Nappa leather with perforated leather seating surfaces (two-tone)	HTN+TU7	320 £	-	320 £	-
Natural Nappa leather with seating surfaces and steering wheel in perforated sueded microfiber	HTQ	810 £	-	810 £	-
Natural Nappa leather with seating surfaces and steering wheel in perforated sueded microfiber (two-tone)	HTQ+TU7	1'130 £	-	1'130 £	-
Jet Black Nappa leather with perforated leather seating surfaces	HTE	-	0 £	-	0 £
Jet Black Nappa leather with seating surfaces and steering wheel in perforated sueded microfiber	HTT	-	810 £	-	810 £
Sky Cool Gray Nappa leather with perforated leather seating surfaces	HU1	-	0 £	-	0 £
Sky Cool Gray Nappa leather with perforated leather seating surfaces (two-tone)	HU1+TU7	-	320 £	-	320 £
Sky Cool Gray Nappa leather with seating surfaces and steering wheel in perforated sueded microfiber	HU9	-	810 £	-	810 £
Sky Cool Gray Nappa leather with seating surfaces and steering wheel in perforated sueded microfiber (two-tone)	HU9+TU7	-	1'130 £	-	1'130 £
Adrenaline Red Nappa leather with perforated leather seating surfaces	HU2	-	0 £	-	0 £
Adrenaline Red Nappa leather with perforated leather seating surfaces (two-tone)	HU2+TU7	-	320 £	-	320 £
Adrenaline Red leather with seating surfaces and steering wheel in perforated sueded microfiber	HUA	-	810 £	-	810 £
Adrenaline Red leather with seating surfaces and steering wheel in perforated sueded microfiber (two-tone)	HUA+TU7	-	1'130 £	-	1'130 £
Natural Nappa leather with perforated leather seating surfaces	HUE	-	0 £	-	0 £
Natural Nappa leather with perforated leather seating surfaces (two-tone)	HUE+TU7	-	320 £	-	320 £
Natural Nappa leather with seating surfaces and steering wheel in perforated sueded microfiber	HTG	-	810 £	-	810 £
Natural Nappa leather with seating surfaces and steering wheel in perforated sueded microfiber (two-tone)	HTG+TU7	-	1'130 £	-	1'130 £
Natural Dipped Nappa leather with perforated leather seating surfaces <sup>18</sup>	HZN	-	0 £	-	0 £
Natural Dipped Nappa leather with seating surfaces and steering wheel in perforated sueded microfiber <sup>18</sup>	HUF	-	810 £	-	810 £
Adrenaline Red Dipped Nappa leather with perforated leather seating surfaces <sup>19</sup>	HNK	-	0 £	-	0 £
Tension/Twilight Blue Dipped Nappa leather with perforated leather seating surfaces <sup>20</sup>	HTO	-	0 £	-	0 £

<sup>18</sup> Full color interior: instrument panel, doors, carpet and seat belts in Natural. Console and door panel are in sueded microfiber.

<sup>19</sup> Full color interior: instrument panel, doors and carpet in Adrenaline Red. Seat belts are in Torch Red.

<sup>20</sup> Full color interior: instrument panel, doors and carpet in Tension/Twilight Blue. Seat belts are in Tension Blue.

• Standard ○ Available – Not available

# INTERIOR / EXTERIOR COLOR AVAILABILITY

EXTERIOR COLORS		Black (GBA)	Arctic White (G8G)	Torch Red (GKZ)	Flare Silver Metallic (GSJ)	Hypersonic Gray Metallic (GA7)	Caffeine Brown Metallic (G48)	Accelerate Yellow Metallic (GD0)	Elkhart Lake Blue Metallic (GS7)	Rapid Blue (GMO)	Ceramic Matrix Gray Metallic (G9F)	Amplify Orange Tintcoat (GC5)	Tactical Red Tintcoat (GPH)
INTERIOR COLORS													
	Jet Black	○	○	○	○	○	○	○	○	○	○	○	○
	Sky Cool Gray	○	○	○	○	○	○	○	○	○	○	○	○
	Adrenaline Red	○	○	○	○	○	-	-	-	-	○	-	-
	Natural	○	○	○	○	○	○	○	○	○	○	○	○
	Tension/Twilight Blue	○	○	-	○	○	-	-	○	○	○	-	-

● Standard ○ Available - Not available

## 2LT INTERIORS

### GT1 SEATS A Q9

Mulan leather with perforated leather seating surfaces

## 2LT AVAILABLE SEAT BELTS AVAILABLE EXTERIOR COLORS

### JET BLACK



HTA 0 £	2LT LEATHER			2LT SUEDE			AVAILABLE SEAT BELTS			AVAILABLE EXTERIOR COLORS					
	Black (719, strd.)	Tan (3N9)	Torch Red (3F9)	Black (GBA)	Hypersonic Gray Metallic (GA7)	Arctic White (G8G)	Ceramic Matrix Gray Metallic (G9F)	Flare Silver Metallic (GSJ)	Accelerate Yellow Metallic (GDD)	Amplify Orange Tintcoat (GC5)	Torch Red (GKZ)	Tactical Red Tintcoat (GPH)	Caffeine Brown Metallic (G48)	Rapid Blue (GMO)	Elkhart Lake Blue Metallic (GS7)
	Yellow (3M9)	Orange (379)	Tension Blue (3A9)												

### SKY COOL GRAY



HUN 0 £	2LT LEATHER			2LT SUEDE			AVAILABLE SEAT BELTS			AVAILABLE EXTERIOR COLORS					
	Black (719, strd.)		Torch Red (3F9)	Black (GBA)	Hypersonic Gray Metallic (GA7)	Arctic White (G8G)	Ceramic Matrix Gray Metallic (G9F)	Flare Silver Metallic (GSJ)	Accelerate Yellow Metallic (GDD)	Amplify Orange Tintcoat (GC5)	Torch Red (GKZ)	Tactical Red Tintcoat (GPH)	Caffeine Brown Metallic (G48)	Rapid Blue (GMO)	Elkhart Lake Blue Metallic (GS7)
	Yellow (3M9)	Orange (379)	Tension Blue (3A9)												

### ADRENALINE RED



HUR 0 £	2LT LEATHER			2LT SUEDE			AVAILABLE SEAT BELTS			AVAILABLE EXTERIOR COLORS					
	Black (719, strd.)		Torch Red (3F9)	Black (GBA)	Hypersonic Gray Metallic (GA7)	Arctic White (G8G)	Ceramic Matrix Gray Metallic (G9F)	Flare Silver Metallic (GSJ)							
									Torch Red (GKZ)						

### NATURAL



HUV 0 £	2LT LEATHER			2LT SUEDE			AVAILABLE SEAT BELTS			AVAILABLE EXTERIOR COLORS					
	Black (719, strd.)	Tan (3N9)	Torch Red (3F9)	Black (GBA)	Hypersonic Gray Metallic (GA7)	Arctic White (G8G)	Ceramic Matrix Gray Metallic (G9F)	Flare Silver Metallic (GSJ)	Accelerate Yellow Metallic (GDD)	Amplify Orange Tintcoat (GC5)	Torch Red (GKZ)	Tactical Red Tintcoat (GPH)	Caffeine Brown Metallic (G48)	Rapid Blue (GMO)	Elkhart Lake Blue Metallic (GS7)
	Yellow (3M9)	Orange (379)	Tension Blue (3A9)												

• Standard ○ Available - Not available

## 2LT INTERIORS

















### GT2 SEATS AH2

Nappa leather with perforated leather seating surfaces /  
Nappa leather with seating surfaces and steering wheel in perforated sueded microfiber

## 2LT AVAILABLE SEAT BELTS AVAILABLE EXTERIOR COLORS

### JET BLACK



LEATHER	SUEDE	AVAILABLE SEAT BELTS			AVAILABLE EXTERIOR COLORS					
HTM	HTP	 Black (719, strd.)	 Tan (3N9)	 Torch Red (3F9)	 Black (GBA)	 Hypersonic Gray Metallic (GA7)	 Arctic White (G8G)	 Ceramic Matrix Gray Metallic (G9F)	 Flare Silver Metallic (GSJ)	 Accelerate Yellow Metallic (GDD)
0 £	810 £	 Yellow (3M9)	 Orange (379)	 Tension Blue (3A9)	 Amplify Orange Tintcoat (GC5)	 Torch Red (GKZ)	 Tactical Red Tintcoat (GPH)	 Caffeine Brown Metallic (G48)	 Rapid Blue (GMO)	 Elkhart Lake Blue Metallic (GS7)









### SKY COOL GRAY



LEATHER	SUEDE	AVAILABLE SEAT BELTS			AVAILABLE EXTERIOR COLORS					
HUK	HU6	 Black (719, strd.)		 Torch Red (3F9)	 Black (GBA)	 Hypersonic Gray Metallic (GA7)	 Arctic White (G8G)	 Ceramic Matrix Gray Metallic (G9F)	 Flare Silver Metallic (GSJ)	 Accelerate Yellow Metallic (GDD)
0 £	810 £	 Yellow (3M9)	 Orange (379)	 Tension Blue (3A9)	 Amplify Orange Tintcoat (GC5)	 Torch Red (GKZ)	 Tactical Red Tintcoat (GPH)	 Caffeine Brown Metallic (G48)	 Rapid Blue (GMO)	 Elkhart Lake Blue Metallic (GS7)



















### ADRENALINE RED



LEATHER	SUEDE	AVAILABLE SEAT BELTS			AVAILABLE EXTERIOR COLORS					
HUL	-	 Black (719, strd.)		 Torch Red (3F9)	 Black (GBA)	 Hypersonic Gray Metallic (GA7)	 Arctic White (G8G)	 Ceramic Matrix Gray Metallic (G9F)	 Flare Silver Metallic (GSJ)	
0 £						 Torch Red (GKZ)				

### NATURAL



LEATHER	SUEDE	AVAILABLE SEAT BELTS			AVAILABLE EXTERIOR COLORS					
HTN	HTQ	 Black (719, strd.)	 Tan (3N9)	 Torch Red (3F9)	 Black (GBA)	 Hypersonic Gray Metallic (GA7)	 Arctic White (G8G)	 Ceramic Matrix Gray Metallic (G9F)	 Flare Silver Metallic (GSJ)	 Accelerate Yellow Metallic (GDD)
0 £	810 £	 Yellow (3M9)	 Orange (379)	 Tension Blue (3A9)	 Amplify Orange Tintcoat (GC5)	 Torch Red (GKZ)	 Tactical Red Tintcoat (GPH)	 Caffeine Brown Metallic (G48)	 Rapid Blue (GMO)	 Elkhart Lake Blue Metallic (GS7)

• Standard ○ Available - Not available



## 2LT INTERIORS

### GT2 SEATS AH2+TU7 (TWO-TONE)

Nappa leather with perforated leather seating surfaces /  
Nappa leather with seating surfaces and steering wheel in perforated sueded microfiber

## 2LT AVAILABLE SEAT BELTS AVAILABLE EXTERIOR COLORS

### SKY COOL GRAY



HUK + TU7

320 £

HU6 + TU7

1'130 £



Black (719, strd.)



Torch Red (3F9)



Yellow (3M9)



Orange (379)



Tension Blue (3A9)



Black (GBA)



Hypersonic Gray Metallic (GA7)



Arctic White (G8G)



Ceramic Matrix Gray Metallic (G9F)



Flare Silver Metallic (GSJ)



Accelerate Yellow Metallic (GDO)



Amplify Orange Tintcoat (GC5)



Torch Red (GKZ)



Tactical Red Tintcoat (GPH)



Caffeine Brown Metallic (G48)



Rapid Blue (GMO)



Elkhart Lake Blue Metallic (GS7)

### ADRENALINE RED



HUL + TU7

320 £

HU7 + TU7

1'130 £



Black (719, strd.)



Torch Red (3F9)



Black (GBA)



Hypersonic Gray Metallic (GA7)



Arctic White (G8G)



Ceramic Matrix Gray Metallic (G9F)



Flare Silver Metallic (GSJ)



Torch Red (GKZ)

### NATURAL



HTN + TU7

320 £

HTQ + TU7

1'130 £



Black (719, strd.)



Tan (3N9)



Torch Red (3F9)



Yellow (3M9)



Orange (379)



Tension Blue (3A9)



Black (GBA)



Hypersonic Gray Metallic (GA7)



Arctic White (G8G)



Ceramic Matrix Gray Metallic (G9F)



Flare Silver Metallic (GSJ)



Accelerate Yellow Metallic (GDO)



Amplify Orange Tintcoat (GC5)



Torch Red (GKZ)



Tactical Red Tintcoat (GPH)



Caffeine Brown Metallic (G48)



Rapid Blue (GMO)



Elkhart Lake Blue Metallic (GS7)

## 2LT INTERIORS

### COMPETITION SPORT SEATS AE4

Nappa leather with perforated leather seating surfaces /  
Nappa leather with seating surfaces and steering wheel in perforated sueded microfiber

## 2LT AVAILABLE SEAT BELTS AVAILABLE EXTERIOR COLORS

### JET BLACK



HTM

HTP

0 £

810 £



Black (719, strd.)



Tan (3N9)



Torch Red (3F9)



Yellow (3M9)



Orange (379)



Tension Blue (3A9)



Black (GBA)



Hypersonic Gray Metallic (GA7)



Arctic White (G8G)



Ceramic Matrix Gray Metallic (G9F)



Flare Silver Metallic (GSJ)



Accelerate Yellow Metallic (GDO)



Amplify Orange Tintcoat (GC5)



Torch Red (GKZ)



Tactical Red Tintcoat (GPH)



Caffeine Brown Metallic (G48)



Rapid Blue (GMO)



Elkhart Lake Blue Metallic (GS7)

### ADRENALINE RED



HUL

HU7

0 £

810 £



Black (719, strd.)



Torch Red (3F9)



Black (GBA)



Hypersonic Gray Metallic (GA7)



Arctic White (G8G)



Ceramic Matrix Gray Metallic (G9F)



Flare Silver Metallic (GSJ)



Torch Red (GKZ)

### NATURAL



HTN

HTQ

0 £

810 £



Black (719, strd.)



Tan (3N9)



Torch Red (3F9)



Yellow (3M9)



Orange (379)



Tension Blue (3A9)



Black (GBA)



Hypersonic Gray Metallic (GA7)



Arctic White (G8G)



Ceramic Matrix Gray Metallic (G9F)



Flare Silver Metallic (GSJ)



Accelerate Yellow Metallic (GDO)



Amplify Orange Tintcoat (GC5)



Torch Red (GKZ)



Tactical Red Tintcoat (GPH)



Caffeine Brown Metallic (G48)



Rapid Blue (GMO)



Elkhart Lake Blue Metallic (GS7)

• Standard ○ Available – Not available

## 3LT INTERIORS

### GT2 SEATS AH2

Nappa leather with perforated leather seating surfaces /  
Nappa leather with seating surfaces and steering wheel in perforated sueded microfiber

## 3LT AVAILABLE SEAT BELTS AVAILABLE EXTERIOR COLORS

### JET BLACK



LEATHER	SUEDE	AVAILABLE SEAT BELTS			AVAILABLE EXTERIOR COLORS					
HTE	HTT	Black (719, strd.)	Tan (3N9)	Torch Red (3F9)	Black (GBA)	Hypersonic Gray Metallic (GA7)	Arctic White (G8G)	Ceramic Matrix Gray Metallic (G9F)	Flare Silver Metallic (GSJ)	Accelerate Yellow Metallic (GDO)
0 £	810 £	Yellow (3M9)	Orange (379)	Tension Blue (3A9)	Amplify Orange Tintcoat (GC5)	Torch Red (GKZ)	Tactical Red Tintcoat (GPH)	Caffeine Brown Metallic (G48)	Rapid Blue (GMO)	Elkhart Lake Blue Metallic (GS7)

### SKY COOL GRAY



LEATHER	SUEDE	AVAILABLE SEAT BELTS			AVAILABLE EXTERIOR COLORS					
HU1	HU9	Black (719, strd.)	Torch Red (3F9)		Black (GBA)	Hypersonic Gray Metallic (GA7)	Arctic White (G8G)	Ceramic Matrix Gray Metallic (G9F)	Flare Silver Metallic (GSJ)	Accelerate Yellow Metallic (GDO)
0 £	810 £	Yellow (3M9)	Orange (379)	Tension Blue (3A9)	Amplify Orange Tintcoat (GC5)	Torch Red (GKZ)	Tactical Red Tintcoat (GPH)	Caffeine Brown Metallic (G48)	Rapid Blue (GMO)	Elkhart Lake Blue Metallic (GS7)

### ADRENALINE RED

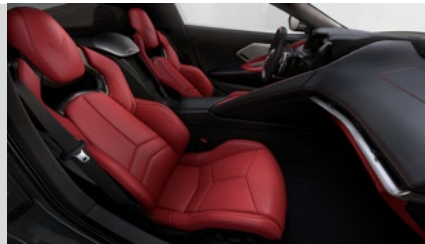

LEATHER	SUEDE	AVAILABLE SEAT BELTS			AVAILABLE EXTERIOR COLORS					
HU2	-	Black (719, strd.)	Torch Red (3F9)		Black (GBA)	Hypersonic Gray Metallic (GA7)	Arctic White (G8G)	Ceramic Matrix Gray Metallic (G9F)	Flare Silver Metallic (GSJ)	
0 £						Torch Red (GKZ)				

### NATURAL



LEATHER	SUEDE	AVAILABLE SEAT BELTS			AVAILABLE EXTERIOR COLORS					
HUE	HTG	Black (719, strd.)	Tan (3N9)	Torch Red (3F9)	Black (GBA)	Hypersonic Gray Metallic (GA7)	Arctic White (G8G)	Ceramic Matrix Gray Metallic (G9F)	Flare Silver Metallic (GSJ)	Accelerate Yellow Metallic (GDO)
0 £	810 £	Yellow (3M9)	Orange (379)	Tension Blue (3A9)	Amplify Orange Tintcoat (GC5)	Torch Red (GKZ)	Tactical Red Tintcoat (GPH)	Caffeine Brown Metallic (G48)	Rapid Blue (GMO)	Elkhart Lake Blue Metallic (GS7)

• Standard ○ Available - Not available

## 3LT INTERIORS

### GT2 SEATS AH2

Nappa leather with perforated leather seating surfaces /  
Nappa leather with seating surfaces and steering wheel in perforated sueded microfiber

3LT		AVAILABLE SEAT BELTS			AVAILABLE EXTERIOR COLORS					
LEATHER	SUEDE									

### NATURAL DIPPED <sup>21</sup>



HZN	HUF									
0 £	810 £									

### ADRENALINE RED DIPPED <sup>22</sup>



HNK	-									
0 £										

### TENSION/TWILIGHT BLUE DIPPED <sup>23</sup>



HTO	-									
0 £										

<sup>21</sup> Full color interior: instrument panel, doors, carpet and seat belts in Natural. Console and door panel are in sueded microfiber.

<sup>22</sup> Full color interior: instrument panel, doors and carpet in Adrenaline Red. Seat belts are in Torch Red.

<sup>23</sup> Full color interior: instrument panel, doors and carpet in Tension/Twilight Blue. Seat belts are in Tension Blue.

• Standard ○ Available - Not available

## 3LT INTERIORS

### GT2 SEATS AH2+TU7 (TWO-TONE)

Nappa leather with perforated leather seating surfaces /  
Nappa leather with seating surfaces and steering wheel in perforated sueded microfiber

## 3LT LEATHER SUEDE AVAILABLE SEAT BELTS AVAILABLE EXTERIOR COLORS

### SKY COOL GRAY



HU1 + TU7  
320 £

HU9 + TU7  
1'130 £



Black  
(719, strd.)



Torch Red  
(3F9)



Yellow  
(3M9)



Orange  
(379)



Tension Blue  
(3A9)



Black (GBA)



Hypersonic  
Gray Metallic  
(GA7)



Arctic White  
(G8G)



Ceramic  
Matrix Gray  
Metallic(G9F)



Flare Silver  
Metallic (GSJ)



Accelerate  
Yellow Metal-  
lic (GDO)



Amplify  
Orange Tint-  
coat (GC5)



Torch Red  
(GKZ)



Tactical Red  
Tintcoat  
(GPH)



Caffeine  
Brown Metal-  
lic (G48)



Rapid Blue  
(GMO)



Elkhart Lake  
Blue Metallic  
(GS7)

### ADRENALINE RED



HU2 + TU7  
320 £

HUA + TU7  
1'130 £



Black  
(719, strd.)



Torch Red  
(3F9)



Black (GBA)



Hypersonic  
Gray Metallic  
(GA7)



Arctic White  
(G8G)



Ceramic  
Matrix Gray  
Metallic(G9F)



Flare Silver  
Metallic (GSJ)



Torch Red  
(GKZ)

### NATURAL



HUE + TU7  
320 £

HTG + TU7  
1'130 £



Black  
(719, strd.)



Tan  
(3N9)



Torch Red  
(3F9)



Yellow  
(3M9)



Orange  
(379)



Tension Blue  
(3A9)



Black (GBA)



Hypersonic  
Gray Metallic  
(GA7)



Arctic White  
(G8G)



Ceramic  
Matrix Gray  
Metallic(G9F)



Flare Silver  
Metallic (GSJ)



Accelerate  
Yellow Metal-  
lic (GDO)



Amplify  
Orange Tint-  
coat (GC5)



Torch Red  
(GKZ)



Tactical Red  
Tintcoat  
(GPH)



Caffeine  
Brown Metal-  
lic (G48)



Rapid Blue  
(GMO)



Elkhart Lake  
Blue Metallic  
(GS7)

## 3LT INTERIORS

### COMPETITION SPORT SEATS AE4

Nappa leather with perforated leather seating surfaces /  
Nappa leather with seating surfaces and steering wheel in perforated sueded microfiber

3LT  
LEATHER

3LT  
SUEDE

AVAILABLE  
SEAT BELTS

AVAILABLE EXTERIOR COLORS

### JET BLACK



HTE

HTT

0 £

810 £



Black (719, strd.)

Tan (3N9)

Torch Red (3F9)



Yellow (3M9)

Orange (379)

Tension Blue (3A9)



Black (GBA)

Hypersonic Gray Metallic (GA7)

Arctic White (G8G)

Ceramic Matrix Gray Metallic (G9F)

Flare Silver Metallic (GSJ)

Accelerate Yellow Metallic (GDO)



Amplify Orange Tintcoat (GC5)

Torch Red (GKZ)

Tactical Red Tintcoat (GPH)

Caffeine Brown Metallic (G48)

Rapid Blue (GMO)

Elkhart Lake Blue Metallic (GS7)

### ADRENALINE RED



HU2

HUA

0 £

810 £



Black (719, strd.)

Torch Red (3F9)



Black (GBA)

Hypersonic Gray Metallic (GA7)

Arctic White (G8G)

Ceramic Matrix Gray Metallic (G9F)

Flare Silver Metallic (GSJ)



Torch Red (GKZ)

### NATURAL



HUE

HTG

0 £

810 £



Black (719, strd.)

Tan (3N9)

Torch Red (3F9)



Yellow (3M9)

Orange (379)

Tension Blue (3A9)



Black (GBA)

Hypersonic Gray Metallic (GA7)

Arctic White (G8G)

Ceramic Matrix Gray Metallic (G9F)

Flare Silver Metallic (GSJ)

Accelerate Yellow Metallic (GDO)



Amplify Orange Tintcoat (GC5)

Torch Red (GKZ)

Tactical Red Tintcoat (GPH)

Caffeine Brown Metallic (G48)

Rapid Blue (GMO)

Elkhart Lake Blue Metallic (GS7)

### NATURAL DIPPED<sup>24</sup>



HZN

HUF

0 £

810 £



Black (719)

Tan (3N9, strd.)

Torch Red (3F9)



Yellow (3M9)

Orange (379)

Tension Blue (3A9)



Black (GBA)

Hypersonic Gray Metallic (GA7)

Arctic White (G8G)

Ceramic Matrix Gray Metallic (G9F)

Flare Silver Metallic (GSJ)

Accelerate Yellow Metallic (GDO)



Amplify Orange Tintcoat (GC5)

Torch Red (GKZ)

Tactical Red Tintcoat (GPH)

Caffeine Brown Metallic (G48)

Rapid Blue (GMO)

Elkhart Lake Blue Metallic (GS7)

<sup>24</sup> Full color interior: instrument panel, doors, carpet and seat belts in Natural. Console and door panel are in sueded microfiber.

- Standard
- Available
- Not available

## 3LT INTERIORS









### COMPETITION SPORT SEATS AE4

Nappa leather with perforated leather seating surfaces /  
Nappa leather with seating surfaces and steering wheel in perforated sueded microfiber

3LT		AVAILABLE SEAT BELTS		AVAILABLE EXTERIOR COLORS				
LEATHER	SUEDE							





### ADRENALINE RED DIPPED <sup>25</sup>



HNK	-	 Black (719)	 Torch Red (3F9, strd.)	 Black (GBA)	 Hypersonic Gray Metallic (GA7)	 Arctic White (G8G)	 Ceramic Matrix Gray Metallic (G9F)	 Flare Silver Metallic (GSJ)
0 £					 Torch Red (GKZ)			

### TENSION/TWILIGHT BLUE DIPPED <sup>26</sup>



HTO	-	 Black (719)		 Black (GBA)	 Hypersonic Gray Metallic (GA7)	 Arctic White (G8G)	 Ceramic Matrix Gray Metallic (G9F)	 Flare Silver Metallic (GSJ)
0 £			 Tension Blue (3A9, strd.)					 Rapid Blue (GM0)
								 Elkhart Lake Blue Metallic (GS7)

<sup>25</sup> Full color interior: instrument panel, doors and carpet in Adrenaline Red. Seat belts are in Torch Red.

<sup>26</sup> Full color interior: instrument panel, doors and carpet in Tension/Twilight Blue. Seat belts are in Tension Blue.

• Standard ○ Available - Not available

# TIRE PRODUCT INFORMATION SHEET

DELEGATED REGULATION (EU) 2020/740

## SUMMER TIRES 245/35 ZR19

Supplier name or trademark	MICHELIN
Commercial name or trade designation	PILOT SPORT 4 S
Tire type identifier	343084
Tire size designation	245/35ZR19
Load-capacity index	89
Speed category symbol	(Y)
Fuel efficiency class	D
Wet grip class	C
External rolling noise class	B
External rolling noise value	70
Severe snow tire	No
Ice tire	No
Date of start of production	21/14
Date of end of production	-
Load version	SL
Additional information	245/35 ZR19 (89Y) TL PILOT SPORT 4 S ZP MI

# TIRE PRODUCT INFORMATION SHEET

DELEGATED REGULATION (EU) 2020/740

## SUMMER TIRES 305/30 ZR20

Supplier name or trademark	MICHELIN
Commercial name or trade designation	PILOT SPORT 4 S
Tire type identifier	633769
Tire size designation	305/30ZR20
Load-capacity index	99
Speed category symbol	(Y)
Fuel efficiency class	D
Wet grip class	D
External rolling noise class	B
External rolling noise value	73
Severe snow tire	No
Ice tire	No
Date of start of production	21/14
Date of end of production	-
Load version	SL
Additional information	305/30 ZR20 (99Y) TL PILOT SPORT 4 S ZP MI



MICHELIN 343084

245/35ZR19 (89Y) C1

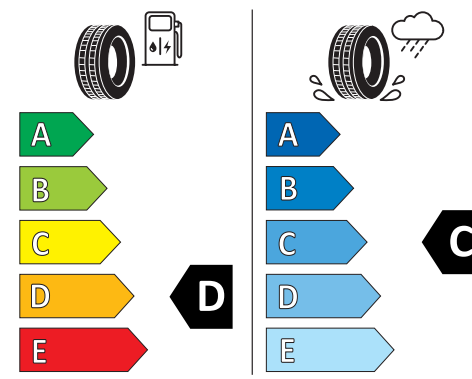

2020/740



MICHELIN 633769

305/30ZR20 (99Y) C1

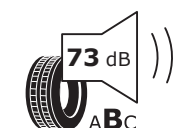
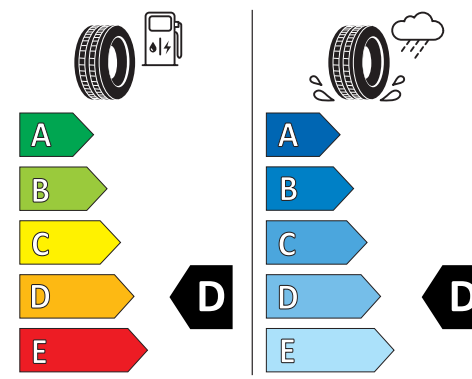

2020/740





**DIMENSIONS & MASSES <sup>27</sup>**

**COUPE**

**CONVERTIBLE**

Mass in running order	1730–1740 kg	1767–1775 kg
Length	4634 mm	4634 mm
Width	1934 mm	1934 mm
Height	1235 mm	1234 mm
Wheelbase	2722 mm	2722 mm
Track front/rear	1647 / 1590 mm	1647 / 1590 mm

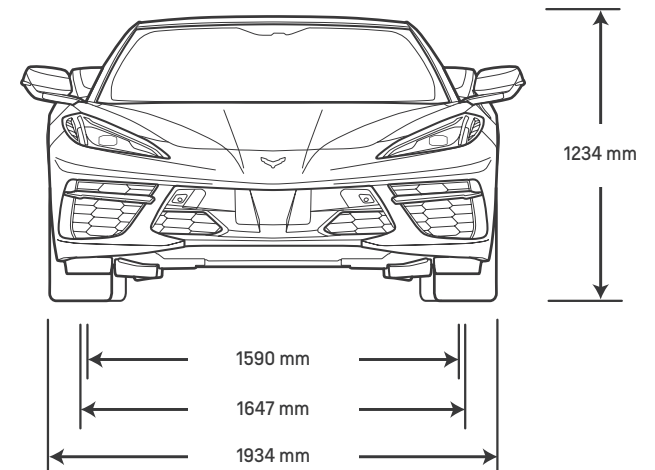
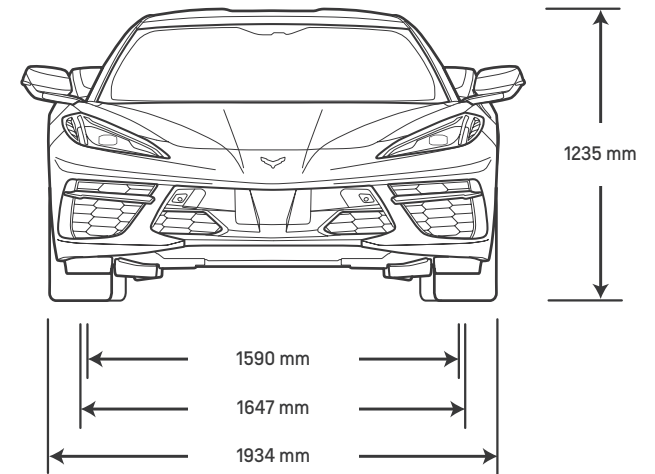
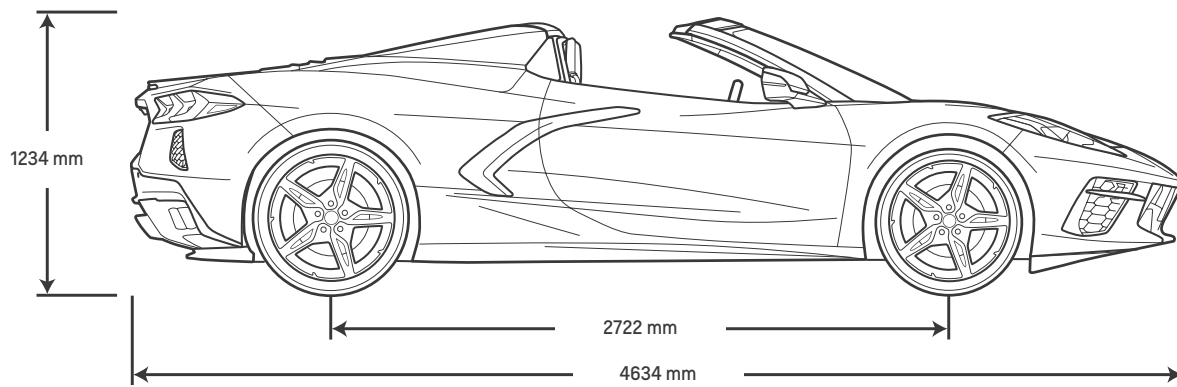
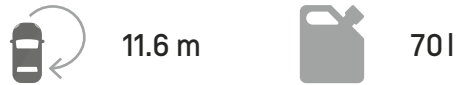
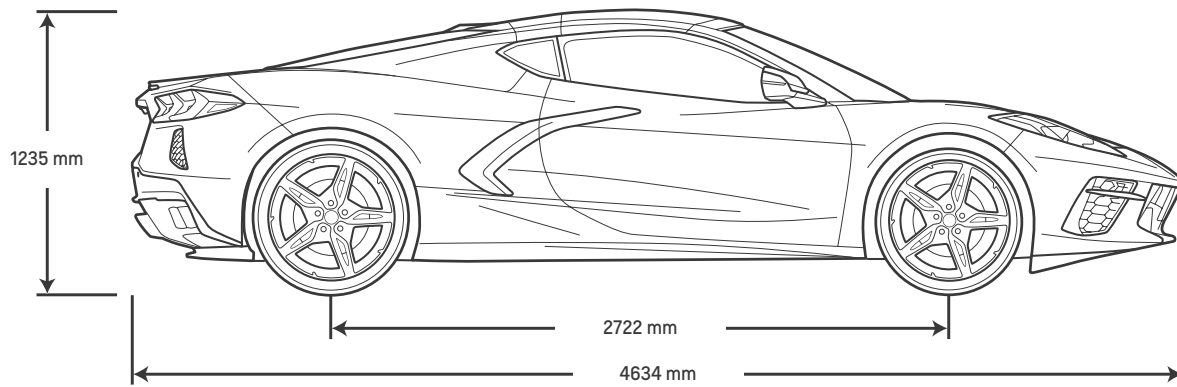

Images show US configuration which might differ from the European version.

<sup>27</sup> Masses and dimensions measured in accordance with the current version of regulation (EU) No 1230/2012.



## CHEVROLET SERVICE

Whether you are at home or on the road, our Chevrolet Partner is there to offer you truly personal assistance. Count on us to arrange service appointments, answer questions about your new Chevrolet and ensure you are always satisfied with your ownership experience. To find your nearest Chevrolet Partner, visit [www.chevrolet-europe.com](http://www.chevrolet-europe.com).



## WARRANTY

Every Chevrolet is built to the highest standards and is manufactured with the utmost care. As a Chevrolet owner, you can expect nothing less than premium service and protection. Should you experience defects in materials or through deficient workmanship your entire vehicle is backed by our no excess, Bumper-to-Bumper, Limited Chevrolet Warranty for three years or 60.000 miles - whichever comes first, plus a 6-year anti-perforation corrosion warranty. Should the vehicle change owner, the warranty transfers automatically during the warranty period.



## CHEVROLET ROADSIDE ASSISTANCE

In the event of an emergency, help is only a phone call away. Contact Chevrolet Roadside Assistance, and we'll come to you as quickly as possible – 24 hours a day, 365 days a year. If we can't return you to the road straight away, we'll take you to the nearest Chevrolet Partner. Chevrolet Roadside Assistance is yours free of charge for a period of 36 months from the date of first registration. Ask your local Chevrolet Partner for details.

## PLEASE NOTE:

The information contained in this brochure was accurate at the time of going to press (June 2022). Images show left-hand-drive version. Availability, technical features and equipment provided on our vehicles can vary from one market to another and may change without prior notice. The vehicles shown in this brochure are for illustration purposes only. European specifications may vary. Some illustrations feature equipment that is not included in every model. The colors printed in the brochure only approximate actual colors. Specifications, dimensions, measurements, ratings and other numbers in this catalogue and other printed materials provided at the dealership or affixed to vehicles are approximates based upon design and engineering drawings and prototypes and laboratory tests. Your vehicle may differ due to variations in manufacture and equipment.

For precise information on the equipment provided on our vehicles, please contact your local Chevrolet Partner. This material shall not be reprinted, in whole or in part, without the express written permission of General Motors. We reserve the right to make changes at any time, without notice, to prices, colors, materials, equipment, specifications, models and availability.



JUNE 2022 (UK)

[www.chevrolet.co.uk](http://www.chevrolet.co.uk)