

# VIVARO

2014 Models Edition 1



Proud Sponsor of Home Nations Football



# The Wheels of Business. Helping you deliver.

Whatever your line of business, Vauxhall Commercial Vehicles can help you deliver. With four different models – including Combo and the award-winning Corsavan – we offer a massive choice of almost 300 variants including panel vans, chassis cabs,

crew cabs, platform cabs, tippers, dropsides, box vans and passenger carriers. We're also committed to keeping your business moving. That means reliable, fuel-efficient vehicles – including our new ecoFLEX range – supported by a dedicated network of over



450 retailers offering the expert support and back-up you need. We build more commercial vehicles at our British production facilities than any other UK manufacturer. We've also won over 30 industry awards since 2001 – major awards, presented by

some of the toughest judges in the business. Introduce the in-built reassurance of the Vauxhall brand and it's easy to see why Vauxhall Commercial Vehicles really are 'The Wheels of Business'.





06 Access  
08 Loadspace  
10 Payloads  
12 Interior, safety and security

14 Cabin comfort  
16 Power and efficiency  
18 ecoFLEX range  
20 Sportive models

22 Doublecab models  
24 Combi models  
26 Options and accessories  
28 Colours and trims

30 Customer testimonials  
32 Equipment and Technical Data

# Vivaro. Spends more time on the road.

Big on style, big on performance and big on the kind of features that take the hard graft out of everyday working life, Vivaro continues to define the standard by which all medium vans are judged.

Visually, the UK-built Vivaro makes a clear statement of professional intent, our Sportive models, in particular, benefitting from front fog lights, 16-inch alloy wheels, body-colour rear light mouldings and door mirror housings.

Inside, Vivaro is as functional as ever, with a stylish yet practical fascia, superb ergonomics and a host of intelligent storage facilities.

Under the bonnet, the fuel-efficient common rail turbo diesel line-up comprises cost-effective 90PS and 115PS 2.0CDTI 16v units and a choice of specially developed ecoFLEX models that boast some of the lowest CO<sub>2</sub> emissions in their class.

Add 25,000 mile/two-year service intervals, a choice of wheelbases and standard or high roof panel van models, a versatile 9-seat Combi derivative plus our Doublecab version – and here's a range that continues to build on a remarkable track record.

Some of the vehicles shown in this brochure include options and accessories available at extra cost. And not all of the features described are available on every model. So please check the equipment and technical data section for further details. From time to time, we also offer alternative models such as Special Editions which are featured in separate literature or can be found on the Vauxhall website: [www.vauxhall.co.uk/vans](http://www.vauxhall.co.uk/vans)

Short wheelbase Sportive model illustrated.

# Access

Making multiple drops and deliveries in tight spaces can make access a problem. Fortunately this is where Vivaro really does excel. The twin rear doors can be swung clear to 165° and locked in place at 90° to provide safe, convenient loading, even where space is at a premium. For unhindered access when reversing back to a doorway, long wheelbase, standard roof models can also be specified with optional 250° opening rear doors (glazed or unglazed). Or specify an optional high lift tailgate with heated rear window complete with wash/wipe facility, available on all standard roof models, thereby offering some protection from the elements when working at the back of the vehicle.

Vivaro comes with a one-metre wide nearside sliding side-access door as standard, with an offside sliding side-access door available at extra cost. Both doors can easily accommodate a standard Euro pallet, the flat load floor ensuring easy forklift access.

## Features include:\*

- › Nearside sliding side-access door
- › Offside sliding side-access door (optional)
- › Full-height steel bulkhead
- › Unglazed rear doors
- › Glazed rear doors (optional)
- › Tailgate with heated window and wash/wipe facility (optional)
- › Load restraint lashing eyes
- › Illuminated load area



Access and loading is easy through the nearside, and optional offside, sliding side-access doors.





*Long wheelbase standard roof model illustrated features optional offside sliding side-access door and glazed rear doors with heated rear windows and wash/wipe facility.*



*Short wheelbase model illustrated features optional offside sliding side-access door and glazed rear doors.*





## Loadspace

With its two wheelbase and two roof height permutations, Vivaro makes it easy for you to get the right van for the job. With a maximum load floor length of 2815mm, the Vivaro long wheelbase high roof model offers a substantial 8.4 cubic metres of loadspace volume and 526mm of extra height compared to the standard roof model. All models feature full-height unglazed rear doors – plus a full-height steel bulkhead to further enhance safety and security. Alternatively, a driver's full-height steel load restraint mesh guard can be specified at no extra cost in lieu of the bulkhead.

Loadspace dimensions	mm	inches
Maximum load floor lengths	2415-2815	95.1-110.8
Maximum load area width	1663	65.5
Maximum load area heights	1387-1913	54.6-75.3
Width between wheel arches	1268	49.9
Maximum rear door aperture heights	1320-1818	52.0-71.6
Rear door aperture width (at floor)	1390	54.7
Loading heights (unladen)	542-549	21.3-21.6
Sliding side-access door aperture height	1285	50.6
Sliding side-access door aperture width	1000	39.4
<b>Loadspace volume</b>	<b>cu.m</b>	<b>cu.ft</b>
Maximum loadspace volumes (VDA method)	5.0-8.4	177-297







## Payloads

Vivaro offers a choice of loadspace volumes. But sometimes it's payload, not dimensions, that counts – that's why Vivaro boasts a range of payloads from 1053kg to 1254kg. The rear suspension set-up uses progressive-rate springs and gas-pressure dampers which adapt to the vehicle load, resulting in superb roadholding and a smooth, reassuring ride. All Vivaro engines and transmissions are up to the task of shifting even the heaviest of loads.



Optional FlexxCargo anchorage system makes light work of securing loads.

Payloads	kg
<b>Model</b>	
2700 SWB standard roof	1053-1100
2900 SWB standard roof	1252-1254
2900 LWB standard roof	1201-1243
2900 SWB high roof	1168-1170
2900 LWB high roof	1208-1211

# Cabin

As existing drivers will testify, Vivaro's interior raises the bar for vans in this class. The stylishly appointed fascia and centre console – creating the perfect driving environment – is matched with hard-wearing cloth or grey vinyl seat trim. In addition, all infotainment systems now feature a stereo radio with Bluetooth® and USB connectivity as standard.

Safety and security levels are high too, thanks to the fitment of a full-height steel bulkhead as standard\*. Not to mention plenty of storage space for all your drinks, bags, CDs and other stuff.



## CD/MP3 player

All Vivaro audio systems feature Bluetooth® and USB connectivity and an aux-in socket.



## Steering column audio controls

Standard on all Vivaro models, enabling you to operate audio functions.



## Intelligent storage

Moulded recesses above the glovebox and centre console create useful additional storage space.



## Features include:\*\*

- › CD/MP3 CD player/stereo radio
- › Bluetooth® and USB connectivity
- › Steering column mounted audio controls
- › Aux-in socket
- › Electrically operated front windows
- › 12-volt electrical accessory socket
- › Driver's airbag
- › ABS with Emergency Brake Assist
- › Remote control central deadlocking
- › Electronic engine deadlock immobiliser

## Options include:\*\*

- › Front passengers' twin airbag
- › Electronic Stability Programme-plus with traction control
- › Selective door locking
- › Remote control ultrasonic security alarm system

\*Bulkhead can be replaced with full-height steel load mesh restraint guard behind driver at no extra cost.

\*\*Not all features and options are available on every model. Please see pages 32-36 for details.





## Comfort

Vivaro models are seriously well equipped. But the real beauty of Vauxhall's Luton-built range is the way in which it allows you to upgrade your own particular model to create a workspace that is 100% in tune with the needs of your company – and your drivers. Vivaro options, for example, cover a broad spectrum of features that span sophisticated audio upgrades and improved cabin ergonomics. We also offer a range of high value option packs. The equipment and technical data section (see page 32 onwards) has all the details.



### USB facility

All models feature USB facility allowing MP3 functionality via the audio display.



### Optional cruise control

Helps you keep to prevailing speed limits and can also help improve fuel economy.



### Satellite navigation

Optional TomTom-based system features a useful fascia-mounted/hand-held remote control unit.



### Single front passenger seat option

Includes lumbar adjustment and armrests for both driver and passenger.

### Features include:\*

- > Dual front passengers' bench seat
- > Six-way adjustable driver's seat
- > Steering column adjustable for reach
- > Illuminated glovebox
- > Facia-mounted gear lever
- > USB facility

### Options include:\*

- > Driver's seat and single front passenger's seat with lumbar adjustment and armrest
- > Air conditioning
- > CD/MP3 CD player/stereo radio/Bluetooth®/USB (CD 30 BT USB)
- > NAVI
- > Cruise control
- > Driver's seat armrest

*\*Not all features and options are available on every model. Please see pages 32-36 for details.*





## Power and efficiency

With a choice of highly efficient, common rail turbo diesel engines and a 90-litre fuel tank, Vivaro is designed to spend more time on the road. Both engines – 2.0CDTI 90PS and 2.0CDTI 115PS combine strong power output with high flexibility and impressive fuel economy.



### Hard working

25,000 mile/two-year service intervals, a 'long-lasting' stainless steel exhaust system and a three-year warranty mean more earning time – and less downtime.

Matched with a smooth-shifting six-speed manual gearbox or our innovative six-speed Tecshift transmission, Vivaro is well up to the tasks faced by a modern commercial vehicle.



### Tecshift

Combines the main features and flexibility of a regular automatic gearbox with the performance and control of manual gear selection.

### Choice of engines:

- > 2.0CDTI 16v (90PS)
- > 2.0CDTI 16v (115PS)

### Features include:\*

- > Six-speed manual gearbox or Tecshift transmission
- > 90-litre fuel tank

### Options include:\*

- > Engine-driven power take-off
- > Speed limiter

*\*Not all features and options are available on every model. Please see pages 32-36 for details.*



The ecoFLEX range of Vivaro models has been specifically developed to reduce CO<sub>2</sub> emissions and increase average fuel economy without having to compromise on performance and durability. Indeed, as recently as October 2012, Vivaro scooped top spot for commercial vehicles in the *Fleet World* MPG Marathon. Averaging an incredible 65.16mpg over a 350 mile trip which included a mixture of A and B roads and motorway driving, the Vivaro 2.0CDTI ecoFLEX powered

model recorded a stunning 59.31% improvement on the combined fuel economy figure. Panel Van models are now available with a Euro 5 compliant 2.0CDTI ecoFLEX unit in two power outputs – 90PS and 115PS. Vauxhall was the first CV manufacturer to offer ‘eco’ versions across the entire line-up reinforcing our commitment to environmental awareness in the commercial vehicle sector.



Available on both short and long wheelbase standard roof models and the 9-seat Combi, the Vivaro ecoFLEX variants embody all the benefits of Vauxhall's ecoFLEX philosophy.

Add the overall improvement in fuel economy and it's easy to see the fiscal benefits too.

With subtle changes to the vehicles' specification CO<sub>2</sub> emissions have been reduced to a highly competitive 174g/km, over 10% lower than the standard model.



**Powerful engines**  
ecoFLEX models are available with two powerful 2.0CDTI engines delivering 90PS or 115PS, combining strong power with high flexibility and impressive torque.



**Fuel efficient**  
Specifically designed to improve fuel economy the 2.0CDTI ecoFLEX engine delivers an average of over 40mpg for the combined figure.

### ecoFLEX model line-up:

#### Panel Van

- › Short wheelbase, standard roof, 2700kg – 90PS/115PS
- › Short wheelbase, standard roof, 2900kg – 90PS/115PS
- › Long wheelbase, standard roof, 2900kg – 90PS/115PS

*The above models are also available with a hardcoded speed limiter – 62mph (100km/h)*

#### 9-Seat Combi

- › Short wheelbase, standard roof, 2900kg – 90PS
- › Long wheelbase, standard roof, 2900kg – 115PS

#### Features include:\*

- › Exhaust gas recirculation cooling
- › Optimised gear ratios
- › Thermal management
- › Acoustic kit
- › Low resistance tyres
- › Aerodynamic kit

#### Options include:\*

- › Engine-driven power take-off
- › Digital tachograph
- › Speed limiter

*\*Not all features and options are available on every model. Please see pages 32-36 for details.*

# Sportive

Vivaro Sportive models combine added driver comfort with a uniquely sporty style, set off by a host of exterior enhancements that include front fog lights, smart 16-inch alloy wheels, body-colour rear light mouldings and door mirror housings. Sportive scores top marks on the equipment front, too – most notably the brilliant CD 30 BT USB audio unit with Bluetooth® functionality, MP3 playback and stereo radio, complete with remote display, USB and aux-in socket.



**Satin chrome-effect detailing**  
Smart, satin chrome-effect detailing for gear lever and door handles.



**Bluetooth® connectivity**  
Makes mobile phone communication hands-free and safe.



**Optional cruise control**  
Also includes leather-covered steering wheel.



**Alloy wheels**  
Distinctive 16-inch alloy wheels provide an additional style accent.

## Additional features over standard model include:

- › CD/MP3 CD player/stereo radio/Bluetooth®/USB (CD 30 BT USB)
- › Air conditioning
- › Electrically operated windows
- › Electrically adjustable/heated door mirrors
- › Remote control ultrasonic security alarm system
- › 16-inch five-spoke alloy wheels
- › Front fog lights
- › Metallic or pearlescent paint
- › Body-colour lower front, rear and rear quarter bumpers
- › Body-colour side-protection mouldings
- › Driver's seat with lumbar adjustment and armrest
- › Satin chrome-effect gear lever insert and door release
- › Instruments with chrome-effect edging



*Short wheelbase standard roof Sportive model illustrated.*





# Doublecab

Providing practical and comfortable crew transport, the Vivaro Doublecab models match serious six-seat accommodation with excellent loadspace (up to 4.2 cu.m) and particularly generous payloads (up to 1131kg).

For added versatility, the latest Vivaro Doublecab models are available in either short or long wheelbase versions – each styled to enhance the image of your business. Sportive versions take things a whole stage further with front fog lights, 16-inch alloy wheels and body-colour rear light mouldings/door mirror housings as standard.



## Sliding side-access doors

Access to Doublecab models is easy through the nearside and offside sliding side-access doors. Both doors feature sliding windows for optimum passenger comfort.

Contributing to comfort, all Doublecab models feature a contoured rear bench seat for three passengers. The travelling environment is enhanced by audio equipment that includes the CD/MP3 CD player and stereo radio.

Twin sliding side-access doors ensure easy passenger access, while the high-strength ABS plastic bulkhead – standard on all versions – features an integral window. Rear seat passengers also benefit from excellent leg room and seat backs that are raked for comfort.



## Rear seats

Individually contoured rear bench seat accommodates up to three passengers in comfort.



## Room in the rear

Additional loadspace under the rear bulkhead extends the load floor length.

## Features include:\*

- › Dual front passengers bench seat
- › CD/MP3 CD player/stereo radio/Bluetooth®/USB (CD 15 BT USB)

## Options include:\*

- › Rear parking distance sensors
- › NAVI

## Additional Sportive features include:\*

- › CD/MP3 CD player/stereo radio/Bluetooth®/USB (CD 30 BT USB)
- › Air conditioning
- › Remote control security alarm system
- › 16-inch alloy wheels

*\*Not all features and options are available on every model. Please see pages 32-36 for details.*

## Combi models

Perfect for hotels, businesses, airports and hire companies, the Vivaro 9-seat Combi is one of the most versatile vehicles around. It combines stylish good looks with the ability to carry up to eight passengers plus driver, in a high degree of safety and comfort.

Available in a choice of short or long wheelbase models, Combi provides generous accommodation allied to massive luggage space, thanks to an ingenious fold-and-stow facility on the third row of seats. This creates additional storage space – without removing the seats.



### 9-seater comfort

With all seats in place, Combi offers comfortable transport for nine, plus the added reassurance of inertia-reel lap and diagonal seatbelts for every occupant.



### Second-row split-folding rear seat

The easy-to-operate 60/40 split-folding seat back allows convenient access for third-row passengers.

Further ensuring long-distance comfort for every rear passenger, Combi features full-length soft-trimmed headlining and half-height panelling as standard, plus optional sliding side door windows.

The 60/40 split-folding second-row seat back, passenger assist grab handles and twin sliding doors – also standard – make entry and exit a simple proposition. While for maximum ease of use, both models feature a high-lift tailgate, the long wheelbase version adding a removable luggage cover for optimum security.

### Additional features include:\*

- › Tailgate with heated window and wash/wipe facility
- › Electrically operated front windows
- › Electrically adjustable/heated door mirrors
- › Rubber floor covering
- › Tinted glass

### Options include:\*

- › Rear parking distance sensors
- › Remote control ultrasonic security alarm system
- › Selective door locking



\*Not all features and options are available on every model. Please see pages 32-36 for details.





*Vivaro Combi SWB model illustrated features Vision Pack, 16-inch alloy wheels and two-coat metallic paint, optional at extra cost.*

# Options

Vauxhall options and accessories are all about choice – selecting your Vivaro model then personalising it to suit the way you work. There's a range of factory-fitted options and option packs. We also offer a huge selection of Genuine Vauxhall Accessories – all designed to the same exacting standards as the vehicle itself. For further information please speak to your Vauxhall Commercial Vehicle retailer. See pages 32 onwards for option availability.



## Cruise control\*

Also includes leather-covered steering wheel on Sportive models.



## Rear parking distance sensors

Provide an audible warning to help prevent accidental damage when reversing.



## High lift tailgate with heated window and wash/wipe facility

Optional on standard roof models.



## Air conditioning\*\*

Helps provide all-year round interior comfort.

## Option packs:

### Vision Pack

- › Rain-sensitive windscreen wipers
- › Automatic Lighting Control (ALC)
- › Front fog lights\*\*
- › Selective door locking
- › Electric Pack\*\* (see below)

### Electric Pack\*\*

- (standard on Combi and Tecshift models)
- › Electrically operated front windows
  - › Electrically adjustable/heated door mirrors

### Smoker Pack

- › Cigar lighter and ashtray

## Individual options include:

- › CD/MP3 CD player/stereo radio/Bluetooth® (CD 30 BT USB)\*\*
- › Air conditioning\*\*
- › Remote control security alarm
- › Single passenger seat
- › Front passenger airbag\*
- › FlexxCargo anchorage
- › Offside sliding door
- › Tow bar with seven-pin electrics
- › Power take-off
- › Tailgate
- › All-season tyres

\*Mandates Electric Pack.

\*\*Standard on Sportive.

# Accessories

Genuine Vauxhall Accessories are the right choice for your Vivaro, allowing you to tailor your van to your individual needs; all fitted by trained Vauxhall professionals. The list below is just a small sample of the range available. For a full list, please refer to the Vauxhall Commercial Vehicle Price Guide or check out our website at [www.vauxhall.co.uk/accessories](http://www.vauxhall.co.uk/accessories)



## Carrier system

The base roof carrier system can be fitted with a steel roof rack complete with loading roller. A steel loading ladder and roof rack walkway are also available.

## Other accessories include:

### Towing

- › Flange tow bar with 12N electrics
- › Jaw and pin coupling – for use with flange tow bar
- › Detachable tow bar

### Interior – Load Area

- › Cargo liner<sup>†</sup>
- › Anti-slip mat (915mm x 915mm)
- › Load-restraining floor net
- › Interior lining plywood panels

### Interior – Cabin Area

- › Rubber floor mats
- › Seat covers
- › Underseat storage tray<sup>††</sup>

### Exterior

- › Protective rear door mouldings
- › Protective wheel arch mouldings
- › Door wind deflectors

### Safety

- › Fire extinguisher
- › Temporary tyre inflation kit

### Safety Pack

- › First aid kit with warning triangle and hi-visibility vest

### Security

- › MetaSystem alarm
- › Steering wheel security bar
- › Rear door window grilles<sup>‡</sup>
- › One-way visibility microline security window film (pair)<sup>‡</sup>

<sup>†</sup>SWB with nearside sliding side-access door only.  
<sup>††</sup>Single passenger seat options only.  
<sup>‡</sup>Twin rear door models only.

# Colours and trims

Vivaro's business-like appearance is exemplified by the impressive choice of colours available. The cloth or vinyl trims have been chosen as much for their hard-wearing properties as they have for their visual appeal.

Flame Red – solid



Glacier White – solid



Ink Blue – solid



Sage – metallic



Star Silver – metallic



Steel Grey – metallic



Midnight Black – pearlescent



Panorama Blue – pearlescent



Winterwind – pearlescent





### Dark Grey Punch cloth

Hard-wearing Dark Grey Punch cloth trim is fitted as standard across the range.

### Grey vinyl\*

Alternatively, Grey vinyl trim can be specified at no extra cost for customers requiring a more workmanlike, wipe-clean option.

	Vivaro	Vivaro Sportive
<b>Exterior colours</b>	Dark Grey Punch cloth trim*	Dark Grey Punch cloth trim
<b>Solid</b>		
Flame Red	●	–
Glacier White	●	●
Ink Blue	●	–
<b>Two-coat metallic</b>		
Sage	○	–
Star Silver	○	●
Steel Grey	○	●
<b>Two-coat pearlescent</b>		
Midnight Black	○	●
Panorama Blue	○	–
Winterwind	○	●

● = Available at no cost.

○ = Available at extra cost.

– = Not available on this model.

\* = Vinyl seat trim is optional at no extra cost on panel van only.

*Due to the limitations of the printing process, the colours reproduced may vary from the actual colour. As a result they should be used as a guide only. All Vauxhall Commercial Vehicle retailers have a comprehensive showroom colour display, with actual exterior paint samples available for inspection. Please note: Certain alternative colours are available for special order on Vivaro. Restrictions apply so please consult your Commercial Vehicle retailer for more details.*

# Vauxhall Commercial Vehicles

## The wheels of your business.

Whatever your load, Vauxhall Commercial Vehicles are designed to help you deliver a top quality job. Our award-winning line-up can actively enhance the operating efficiency of your business by delivering outstanding load-carrying potential, low running costs and day-long driver comfort. Whichever Vauxhall Commercial Vehicle you choose, you can also rest assured that Vauxhall's nationwide network of retailers will go the extra mile to meet all your servicing and maintenance needs.

But why take our word for it? Vauxhall's commitment to keeping your business moving is recognised by van operators of all sizes across the length and breadth of the country...



**Russell Lelliot, Managing Director, RSL Transport said...**

*'We've been running Movanos for years. Our two New Movanos save around 4mpg when full, compared to the old models. Which over almost 3,000 miles per week per van, is a big saving!'*



**Richard Fox, Managing Director of ITE Projects said...**

*'We rely totally on our vehicles to ensure we are available 24/7 to service our customers' critical requirements. The Combo van is proving to be as reliable as we are.'*

**Mike Sinclair, Senior Property Partner, Aberdeen Considine said...**

*'Our fleet of 23 Corsavan Sportives is a reflection on our business, reinforcing our professional image. Not only that, we've found them economical, reliable and fun to drive.'*





*Andrew Cook, Rail Structures Examiner, Amey PLC said...*

*'The reasons I drive Vivaro? Simple. It's comfortable, the driving position and visibility are great and it's surprisingly compact. This makes it ideal for some of the limited access situations we encounter.'*

## Contents

### Equipment

Safety	32
Seating	
Facia, instruments and controls	
Interior features	33
Mechanical	
Security	34
Load area	
Wheels and tyres	35
Exterior features	
Option packs	36
Audio, communication and navigation	37

### Technical data

Power and torque curves	38
Engines	
Transmission ratios	
Vauxhall Assistance and warranties, transmissions, steering, suspension, brakes, electrics, body, fuel tank capacity, insurance groups and tyre rating	39

### Dimensions and weights

Panel van: Exterior/interior dimensions, loadspace volumes and ground clearance	40
Panel van: Weights and towing data	41
Doublecab: Exterior dimensions and seating layout	42
Doublecab: Interior dimensions, weights and towing data, specific features	43
Combi: Exterior dimensions, seating layouts	44
Combi: Interior dimensions, weights and towing data, specific features	45

### Additional information

Fuel economy and emissions	46
Glossary of terms	47

## Safety

**Standard features** • Driver's airbag • Anti-lock Braking System (ABS) with Electronic Brakeforce Distribution (EBD) • Emergency Brake Assist (EBA) – Increases applied brake force in emergency braking situations • Height-adjustable padded head restraints • Three inertia-reel lap and diagonal seatbelts (Doublecab – six/Combi–nine) • Height-adjustable outer front seatbelts • Pyrotechnic body-lock front seatbelt pretensioner system – Tightens the seatbelt during the early stages of a frontal impact • Front seatbelt force limiters – Reduces potential upper body injuries during a frontal impact • Anti-submarining ramps in front seats – Help prevent occupants sliding underneath the lap belt during a collision • Side-impact protection beams • Laminated windscreen

### Additional features

	ecoFLEX	Panel van	Sportive	Doublecab	Sportive Doublecab	Combi
Front passengers' twin airbag	○ <sup>1</sup>	○ <sup>1</sup>	○	○ <sup>1</sup>	○	○
Electronic Stability Programme-plus (ESP-plus) with traction control <sup>2</sup>	○ <sup>1</sup>	○ <sup>1</sup>	○	○ <sup>1</sup>	○	○

## Security

**Standard features** • Remote control central deadlocking (doors, tailgate – when specified, and fuel flap) with internal switch • Electronic theft protection for audio equipment • Electronic engine deadlock immobiliser • 'Key left in ignition' audible warning • Visible Vehicle Identification Number (VIN) • Steering column lock • Freewheeling door and steering lock cylinders

### Additional features

	ecoFLEX	Panel van	Sportive	Doublecab	Sportive Doublecab	Combi
Remote control ultrasonic security alarm system	○	○	●	○	●	○
Selective door locking	□	□	□	□	□	□

## Facia, instruments and controls

**Standard features** • Facia-mounted gear lever • Steering column adjustable for reach • Matt chrome-effect instrument rings • Trip odometer • Rev counter • Fuel gauge with low fuel level warning light • Engine oil level indicator • Service-due indicator • Digital clock with automatic RDS time adjustment • 12-volt electrical accessory socket • Illuminated glovebox • Open storage compartment above glovebox (deleted if optional front passengers' twin airbag is fitted) • Extensive facia storage • Facia-mounted drinks holders • Facia-mounted bag-carrying hook

### Additional features

	ecoFLEX	Panel van	Sportive	Doublecab	Sportive Doublecab	Combi
Multi-function trip computer (provides information on fuel used, overall distance, average and instantaneous fuel consumption, remaining range, distance before service and average speed. Plus additional driver information messages as detailed in the owner's manual)			●		●	
Digital tachograph (must be specified at time of ordering) <sup>3</sup>	○ <sup>1</sup>	○ <sup>1</sup>	○	○ <sup>1</sup>	○	○
Cruise control <sup>4</sup>	○ <sup>1</sup>	○ <sup>1</sup>		○ <sup>1</sup>		○
Leather-covered steering wheel with cruise control <sup>4</sup>			○		○	



## Seating

**Standard features** • Punch cloth seat trim • Driver's seat height adjuster • Driver's seat adjustable for reach and rake  
• Dual front passengers' bench seat

### Additional features

	ecoFLEX	Panel van	Sportive	Doublecab	Sportive Doublecab	Combi
Vinyl seat trim	N/C	N/C		N/C		
Driver's seat with lumbar adjustment and armrest	○ <sup>5</sup>	○ <sup>5</sup>	●	○ <sup>5</sup>	●	○
Driver's seat and single front passenger's seat with lumbar adjustment and armrest	○ <sup>5</sup>	○ <sup>5</sup>	○	○ <sup>5</sup>	○	○
Three-passenger rear bench seat				●	●	●
Second-row nearside seat foldable for access to third-row seating						●
Fold and stow facility for rear bench seat						●

## Interior features

**Standard features** • Vinyl floor covering in cabin area • Twin sunvisors • Air blend heater with four-speed fan • Four adjustable face-level heating and ventilation outlets • Windscreen and front side-window demist vents • Air recirculation system • Overhead storage shelf (high roof only) • Two bulkhead-mounted coat hooks • Fade down cabin area courtesy light • Door armrests  
• Front door pockets with bottle holder • Full-length, soft-trimmed headlining (Combi) • Half-height interior panelling (Combi)  
• Rubber floor covering (Combi)

### Additional features

	ecoFLEX	Panel van	Sportive	Doublecab	Sportive Doublecab	Combi
Air conditioning (Cab only – Combi)	○ <sup>6</sup>	○ <sup>6</sup>	●	○ <sup>6</sup>	●	○
Front and rear air conditioning						○
Rear heating (only available with front and rear air conditioning on LWB models)						○
Satin chrome-effect gear lever insert and interior release for front doors			●		●	
Cigar lighter and front ashtray	□	□	□	□	□	□

## Mechanical

**Standard features** • Six-speed manual gearbox • Power-assisted steering

### Additional features

	ecoFLEX	Panel van	Sportive	Doublecab	Sportive Doublecab	Combi
Tecshift six-speed transmission with sequential manual gearshift and automatic mode (2.0CDTI 16v (115PS) only) <sup>2,6</sup>		○	○	○	○	○
Engine-driven power take-off provision (2.0CDTI 16v (115PS) only)	○ <sup>6</sup>	○ <sup>6</sup>		○ <sup>6</sup>		
Speed limiter – choice of three: 56mph (90km/h), 62mph (100km/h) or 68mph (110km/h) <sup>7</sup>	○	○	○	○	○	○
Tow bar with seven-pin electrics <sup>8</sup>	○	○	○	○	○	○



Satin chrome-effect instrument rings.

- = Standard equipment.
- = Optional at extra cost.
- N/C = No-cost option.
- = Only available as part of an extra-cost option pack – see page 36 for more details.

- 1 = Mandates Electric Pack (at extra cost).
- 2 = ESP-plus not available with Tecshift models.
- 3 = Mandates CD 15 BT USB audio unit on Sportive models when the tachograph option is specified. Digital tachograph is not available with optional audio units. The digital tachograph option must be specified at time of ordering as it cannot be fitted retrospectively. Vehicles fitted with tachograph include odometer display, in kilometres, replacing standard odometer display on instrument cluster. Option price for digital tachograph does not include calibration which must be carried out at an approved tachograph centre within 14 days of the vehicle's registration.  
**Please note:** The legislation regarding the use of tachographs is complex and operators should seek independent advice or speak to the CV specialist within a Vauxhall Commercial Vehicle retailer to ensure compliance. Alternatively your local DVLA office will also be able to provide clarification of the relevant legislation.
- 4 = Not available in conjunction with speed limiter.
- 5 = Not available in conjunction with vinyl seat trim.
- 6 = Engine-driven power take-off option not available in conjunction with air conditioning or Tecshift.
- 7 = Not available in conjunction with cruise control or on models with hardcoded speed limiters.
- 8 = Unless the user qualifies for a specific exemption, vehicles operated with a trailer, where the combined weight of the vehicle, trailer and payload exceeds 3500kg, will need a digital tachograph.



Tailgate with heated window and wash/wipe facility (optional) on std. roof panel van/doublecab.



FlexxCargo anchorage, optional on panel van models.

## Load area

**Standard features** • Nearside sliding side-access door • Illuminated load area • Load restraint lashing eyes  
 • Unglazed rear doors (90°/165° opening)

<b>Additional features</b>	ecoFLEX	Panel van	Sportive	Doublecab	Sportive Doublecab	Combi
Full-height steel bulkhead without window	●	●	●			
Full-height steel bulkhead with window	○	○	○			
Full-height steel load restraint guard behind driver (in lieu of standard bulkhead)	N/C	N/C	N/C			
Full-height ABS plastic bulkhead with window				●	●	
Resin-coated wooden load floor covering	○	○	○			
FlexxCargo anchorage	○	○	○			
Delete standard nearside sliding side-access door <sup>9</sup>	N/C	N/C				
Offside sliding side-access door	○	○	○			
Fixed window in nearside sliding side-access door <sup>10</sup>	○	○	○			
Sliding window in nearside sliding side-access door <sup>10</sup>	○	○	○			
Offside sliding side-access door with fixed windows to both nearside and offside doors <sup>10</sup>	○	○	○			●
Offside sliding side-access door with sliding windows to both nearside and offside doors <sup>10</sup>	○	○	○	●	●	
Sliding windows to nearside and offside sliding side-access doors						○
Glazed rear doors (90°/165° opening) <sup>11</sup>	○	○				
Glazed rear doors with heated windows and wash/wipe facility (not with 250° opening glazed rear door option)	○ <sup>11</sup>	○ <sup>11</sup>	○ <sup>11</sup>	○	○	○
250° opening unglazed rear doors (LWB standard roof only)	○ <sup>11</sup>	○ <sup>11</sup>	○ <sup>11</sup>	○	○	
250° opening glazed rear doors (LWB standard roof only)	○ <sup>11</sup>	○ <sup>11</sup>	○ <sup>11</sup>	○	○	
Tailgate with heated window and wash/wipe facility (standard roof only)	○ <sup>11</sup>	○ <sup>11</sup>	○ <sup>11</sup>	○	○	●

## Wheels and tyres (for tyre ratings see page 39)

Features	ecoFLEX	Panel van	Sportive	Doublecab	Sportive Doublecab	Combi
Tyre: 205/65 R 16 tyres (excluding 2900 ecoFLEX models)	●	●	●	●	●	
Tyre: 215/65 R 16 tyres (2900 models)	●					●
16-inch steel wheels with centre covers (full-diameter wheel trims on ecoFLEX Panel van models)	●	●		●		●
16-inch five-spoke alloy wheels	○	○	●	○	●	○
All-season tyres (Goodyear Cargo Vector) 205/65 R 16 (2700 models)		○	○			
All-season tyres (Goodyear Cargo Vector) 215/65 R 16 (2900 models)		○	○			
Full-size steel spare wheel	●	●	●	●	●	● <sup>12</sup>
Tyre inflation kit in lieu of spare wheel	N/C	N/C	N/C	N/C	N/C	N/C <sup>12</sup>

## Exterior features

**Standard features** • Tinted glass • Two-speed windscreen wipers with variable intermittent wipe and electric screenwash • Lights-on audible warning • Electric headlight beam levelling • Twin adjustable and foldable door mirrors (wide-angle on driver's side) • High-level tail lights • High-level brake light • Twin reversing lights • Rear fog light • Body side-protection mouldings • Side repeat indicators

Additional features	ecoFLEX	Panel van	Sportive	Doublecab	Sportive Doublecab	Combi
Rear parking distance sensors	○	○	○	○	○	○
Solar Reflect® windscreen	○	○	○	○	○	○
Rain-sensitive windscreen wipers	□	□	□	□	□	□
Automatic Lighting Control (ALC)	□	□	□	□	□	□
Front fog lights	□	□	●	□	●	□
Electrically operated front windows (standard on Tecshift models)	□	□	●	□	●	●
Electrically adjustable/heated door mirrors (standard on Tecshift models)	□	□	●	□	●	●
Body-colour door mirrors			●		●	
Body-colour side-protection mouldings			●		●	
Part body-colour front bumper			●		●	
Body-colour rear bumper, quarter bumpers and rear light cluster surrounds			●		●	
Two-coat metallic or pearlescent paint	○	○	● <sup>13</sup>	○	● <sup>13</sup>	○
Special paint <sup>14</sup>	○	○		○		○



16-inch five-spoke alloy wheels.



Rear parking distance sensors (optional).

- = Standard equipment.
- = Optional at extra cost.
- N/C = No-cost option.
- = Only available as part of an extra-cost option pack.
- 9 = Not available with full-height bulkhead (with or without window).
- 10 = Fixed or sliding window options for sliding side-access door(s) also mandates (at extra cost) glazed rear doors.
- 11 = Only available with optional full-height steel bulkhead with window or no-cost option full-height steel load restraint guard behind driver on panel vans.
- 12 = LWB Combi ecoFLEX models are supplied with the tyre inflation kit as standard.
- 13 = Star Silver two-coat metallic paint is standard. Glacier White, Midnight Black, Winterwind and Steel Grey are available as no-cost options.
- 14 = Special paint available at extra cost. Please consult your retailer for details. Restrictions apply and minimum quantity may be required.



Electric Pack (standard on Sportive, Combi and Tecshift models).

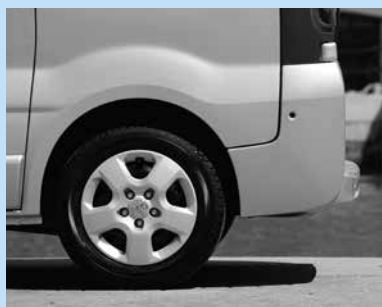

Edition Pack, body-colour front/rear-quarter bumpers and full-diameter wheel covers.

## Option packs

Features	ecoFLEX	Panel van	Sportive	Doublecab	Sportive Doublecab	Combi
<b>Electric Pack</b> (standard on Tecshift models) • Electrically operated front windows • Electrically adjustable/heated door mirrors	○	○	●	○	●	●
<b>Vision Pack</b> • Rain-sensitive windscreen wipers • Automatic Lighting Control (ALC) • Front fog lights • Selective door locking • Electric Pack	○	○		○		
<b>Vision Pack (Sportive)</b> • Rain-sensitive windscreen wipers • Automatic Lighting Control (ALC) • Selective door locking			○		○	
<b>Vision Pack (Combi)</b> • Rain-sensitive windscreen wipers • Automatic Lighting Control (ALC) • Front fog lights • Selective door locking						○
<b>Edition Pack</b> • Body-colour lower front, rear/rear-quarter bumpers • Body-colour side-protection mouldings • Full-diameter wheel covers						○
<b>Smoker Pack</b> • Cigar lighter • Front ashtray	○	○	○	○	○	

## Audio, communication and navigation

Features	ecoFLEX	Panel van	Sportive	Doublecab	Sportive Doublecab	Combi
<b>CD/MP3 CD player/stereo radio (CD 15 BT USB)</b> • CD/MP3 CD player • Bluetooth® connectivity for compatible mobile phones • USB connection • AM/FM stereo radio • Aux-in socket • Integrated display • Steering column mounted audio controls • Two 15-Watt speakers	●	●		●		●
<b>CD/MP3 CD player/stereo radio/Bluetooth® (CD 30 BT USB)<sup>14</sup></b> • CD/MP3 CD player • AM/FM stereo radio • Aux-in socket • Bluetooth® connectivity for compatible mobile phones • USB connection • Remote monochromatic display • Steering column mounted audio controls • Two 20-Watt speakers	○	○	●	○	●	○
<b>NAVI</b> • Satellite navigation with remote colour monitor <sup>15</sup> Roof-mounted flexible aerial	○	○	○	○	○	○

### Satellite navigation

Vivaro's navigation system features clear, enhanced graphics and shows a full range of routing information in either day or night modes, including distance, current speed limit, RDS EON route delay information, and estimated arrival time. Maps cover Western European countries and the system is easy to operate and can be updated over the internet. Additionally this NAVI system also includes a three-month free subscription to TomTom LIVE.

### TomTom LIVE features:

- More detailed incident reports regarding travel disruptions
- More accurate information about delays and arrival times
- Alternative route suggestions
- Speed camera warning
- Allows users to search Google for addresses or services
- Also provides telephone numbers and addresses
- Google database provides a much greater range of options than the built-in database
- Provides local daily and five-day weather forecasts, as well as road conditions

### Bluetooth® connectivity

Easy to operate, virtually universal in compatibility and included with all audio units – Bluetooth® makes mobile phone communication hands-free and safe.

### USB connection

All audio units feature a USB facility and 3.5mm stereo jack plug. This allows iPod and memory stick functionality.



Satellite navigation.



USB facility.

- = Standard equipment.
- = Optional at extra cost.

<sup>14</sup> = Not available in conjunction with optional digital tachograph.

<sup>15</sup> = Mandates CD 30 BT USB and includes a three-month free subscription to TomTom LIVE.



**90PS/  
115PS**  
2.0CDTI 16v  
common rail  
diesel engine

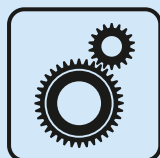

**Tecshift**  
Six-speed  
transmission  
optional on the  
2.0CDTI 16v (115PS)  
engine (excluding  
ecoFLEX models)

### Power and torque curves

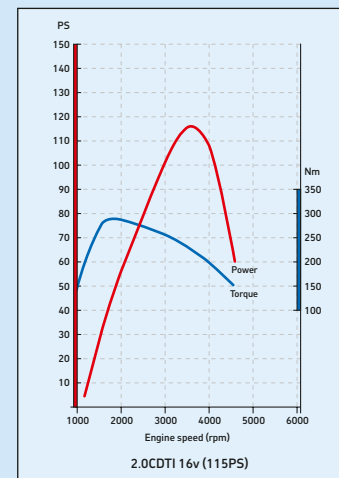
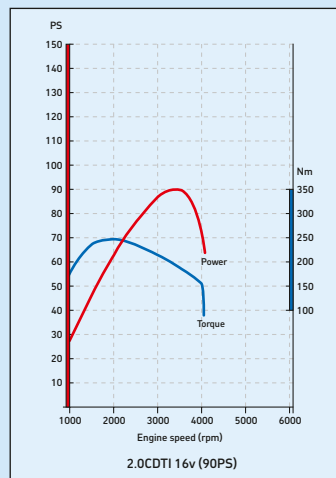

### Engines

	2.0CDTI 16v (90PS)	2.0CDTI 16v (115PS)
Fuel type	Diesel	
Capacity	1995cc	1995cc
Maximum power	90PS (66kW) @ 3500rpm	115PS (84kW) @ 3500rpm
Maximum torque	240Nm (177 lb.ft.) @ 1500rpm	290Nm (214 lb.ft.) @ 1600rpm
Configuration	4 cylinders, 4 valves per cylinder, double overhead camshafts	
Emission compliance	Euro 5	
Fuel/induction system	Fixed geometry turbocharger and intercooler. Common rail fuel injection.	
Service interval	25.000 miles or two years (whichever occurs sooner)	

### Transmission ratios

	Gear ratios (mph/1000rpm)						Final drive ratio
	1	2	3	4	5	6	
Panel van 2700	3.91:1 (4.7)	2.11:1 (8.7)	1.39:1 (13.3)	0.98:1 (18.9)	0.76:1 (24.3)	0.60:1 (30.8)	4.19:1
ecoFLEX 2700	3.91:1 (4.7)	2.11:1 (8.7)	1.29:1 (14.3)	0.89:1 (20.8)	0.69:1 (26.8)	0.60:1 (30.8)	4.19:1
Panel van/Combi 2900 standard roof	3.91:1 (4.8)	2.11:1 (9.0)	1.39:1 (13.6)	0.98:1 (19.3)	0.76:1 (24.9)	0.60:1 (31.5)	4.19:1
Panel van 2900 high roof, ecoFLEX 2900, Doublecab	3.91:1 (4.8)	2.11:1 (9.0)	1.29:1 (14.7)	0.89:1 (21.3)	0.69:1 (27.4)	0.60:1 (31.5)	4.19:1
Sportive	3.91:1 (4.9)	2.11:1 (9.1)	1.39:1 (13.8)	0.98:1 (19.6)	0.76:1 (25.3)	0.60:1 (32.1)	4.19:1

## Vauxhall Assistance and warranties\*

- All new Vivaros qualify for a three-year vehicle warranty consisting of a one-year/unlimited mileage manufacturer's warranty and a second and third year manufacturer's warranty with a 100,000 miles limitation
- Vauxhall Assistance for 12 months from first registration
- Six years' body panel anti-perforation warranty

\* = Warranty is only available on vehicles sourced from General Motors UK Limited. Terms and conditions apply – please see your Vauxhall retailer for details.

## Transmissions

- Front-wheel drive
- Six-speed manual gearbox
- Six-speed Tecshift transmission – available at extra cost on 2.0CDTI 16v (115PS) models (excluding ecoFLEX). Tecshift hydraulic transmission offers all the main features and flexibility of a regular automatic, plus the performance and control of a 'one-touch' manual gearbox. Drivers may switch between modes on the move using the gearshift selector

## Steering

- Power-assisted rack and pinion system
- Turning circles (kerb-to-kerb/wall-to-wall):  
SWB – 11.84m (38.8ft)/12.40m (40.7ft)  
LWB – 13.17m (43.2ft)/13.73m (45.1ft)
- Turns lock-to-lock: 3.3

## Suspension

- Front:** Independent wishbones with MacPherson spring struts, control arms and separate galvanised, double isolated, vibration reducing subframe.
- Rear:** Semi-independent with trailing links, progressive-rate mini-block coil springs with rubber bump-stops and telescopic, load-adaptable gas-pressure dampers.

## Brakes

- Anti-lock Braking System (ABS) with Electronic Brakeforce Distribution (EBD)
  - Emergency Brake Assist (EBA)
  - Vacuum servo-assisted system
  - Dual circuit hydraulic system
  - Floor-mounted parking brake lever
- Front ventilated disc brakes:** 305mm diameter.
- Rear disc brakes:** 280mm diameter.

## Electrics

- Maintenance-free battery:** 85Ah. Tecshift models and models with alarm, or tachograph fitted: 95Ah.
- Alternator:** 125A.

## Body

- Six-year body panel anti-perforation warranty
- Galvanised body panels
- Anti stone-chip mastic coating on sills
- Anti-corrosion wax pumped into sills and other underbody cavities
- Flush-fitted windscreen and rear door glass (when specified)
- Detachable front towing eye
- Rear towing eye

## Fuel tank capacity

90 litres (19.8 gallons).

## Insurance groups

Range from 4E – 5E dependent on model specified.



Six-speed manual gearbox.



Six-speed Tecshift transmission (optional).

## Tyre rating

Tyre size	Fuel efficiency group	Wet grip performance	External noise	
			Measured (dB)	Group
195/65 R 16	E-F	B-E	72-74	
205/65 R 16	C-E	B-E	71-72	
215/65 R 16	C-F	B-C	71-74	

Tyre rating according to EU Regulation 1222/2009

**Panel van**

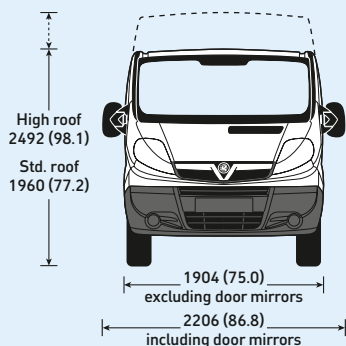

**SWB**

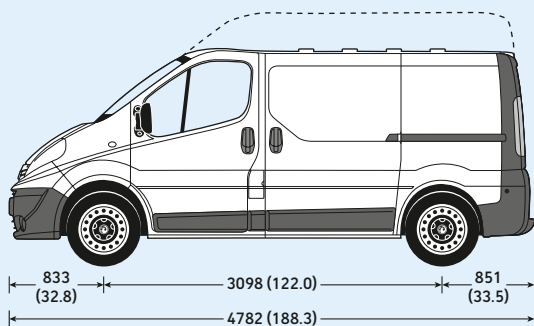

**LWB**

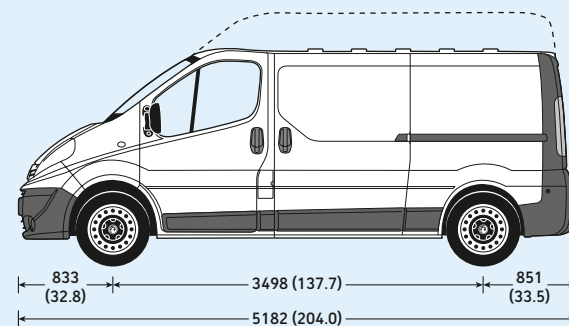

Measurements are shown in millimetres (inches). All heights are shown unladen.

**Panel van**

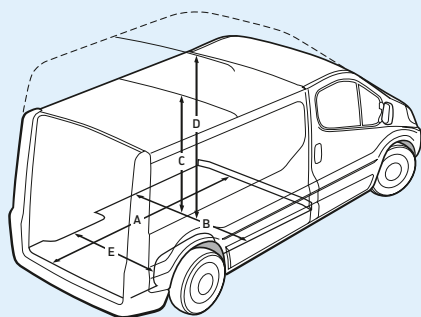

**Loadspace volumes** cu.m (cu.ft.)

SAE method	SWB	LWB
Standard roof	5.3 (187)	6.2 (219)
High roof	7.4 (261)	8.7 (307)
VDA method		
Standard roof	5.0 (177)	5.9 (208)
High roof	7.1 (251)	8.4 (297)

**Ground clearance** mm (inches)

SWB	Laden	Unladen
2700 std. roof	162 (6.4)	185 (7.3)
2900 std. roof	164 (6.5)	192 (7.5)
2900 high roof	159 (6.3)	193 (7.6)
LWB		
2900 std. roof	158 (6.2)	188 (7.4)
2900 high roof	149 (5.9)	187 (7.4)

**Interior dimensions** mm (inches)

Loadspace	SWB	LWB
<b>A</b> Maximum length	2415 (95.1)	2815 (110.8)
<b>B</b> Maximum width	1663 (65.5)	1663 (65.5)
<b>C</b> Maximum height – standard roof	1387 (54.6)	1387 (54.6)
<b>D</b> Maximum height – high roof	1913 (75.3)	1913 (75.3)
<b>E</b> Width between wheel arches	1268 (49.9)	1268 (49.9)
Side door(s)		
Aperture height	1285 (50.6)	1285 (50.6)
Aperture width	1000 (39.4)	1000 (39.4)
Rear doors		
Aperture height – standard roof	1320 (52.0)	1320 (52.0)
Aperture height – high roof	1818 (71.6)	1818 (71.6)
Aperture width (at floor)	1390 (54.7)	1390 (54.7)
Loading height – standard roof	549 (21.6)	542 (21.3)
Loading height – high roof	549 (21.6)	547 (21.5)



## Weights and towing data

<i>SWB panel van models</i>	Transmission	UK plated weights and kerbweights kg				Payload kg	Plated Gross Combination Weights (GCW) kg
		Front axle Plated	Rear axle Plated	GVW Total	Kerb		
2700 2.0CDTI (90/115PS) std. roof	manual	1450	1550	2790	1690	1100	4790
2700 2.0CDTI (90/115PS) std. roof ecoFLEX	manual	1580	1550	2790	1690	1100	4790
2700 2.0CDTI (115PS) std. roof	Tecshift	1580	1650	2790	1737	1053	4790
2900 2.0CDTI (90/115PS) std. roof	manual	1580	1650	2950	1696	1254	4950
2900 2.0CDTI (90/115PS) std. roof ecoFLEX	manual	1580	1650	2950	1696	1254	4950
2900 2.0CDTI (115PS) std. roof	Tecshift	1580	1650	2950	1698	1252	4950
2900 2.0CDTI (90/115PS) high roof	manual	1580	1650	2940	1772	1168	4940
2900 2.0CDTI (115PS) high roof	Tecshift	1580	1650	2940	1770	1170	4940
<i>LWB panel van models</i>							
2900 2.0CDTI (90/115PS) std. roof	manual	1620	1650	3030	1787	1243	5030
2900 2.0CDTI (90/115PS) std. roof ecoFLEX	manual	1620	1650	3030	1787	1243	5030
2900 2.0CDTI (115PS) std. roof	Tecshift	1620	1650	3030	1829	1201	5030
2900 2.0CDTI (90/115PS) high roof	manual	1620	1650	3030	1822	1208	5030
2900 2.0CDTI (115PS) high roof	Tecshift	1620	1650	3030	1819	1211	5030

**Note: Kerbweights** for standard vehicles include coolant, oil, 90% full fuel tank and spare wheel. They will vary according to the vehicle specification (including options and accessories) with a corresponding variation in payload. **Payload** figures do not allow for the weight of the driver, or any passengers, which should therefore be deducted from the figures shown and are also subject to correct weight distribution. **Gross plated weights** (including axle weights) quoted on the vehicle plate must never be exceeded. **Roof load** maximum 200kg (includes weight of roof carrier) when Vauxhall approved carrier system used. **Towing weights** should not exceed 750kg (unbraked trailer) or 2000kg (braked trailer). Sportive models have additional standard features and greater kerbweight which reduces payload.

Doublecab

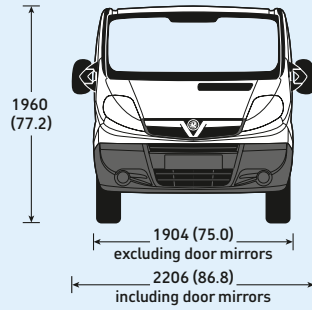

SWB

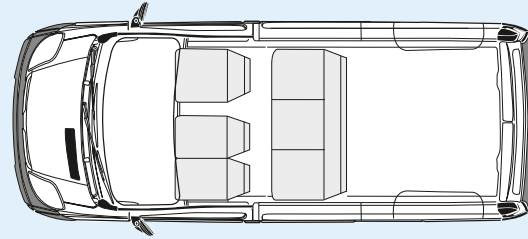
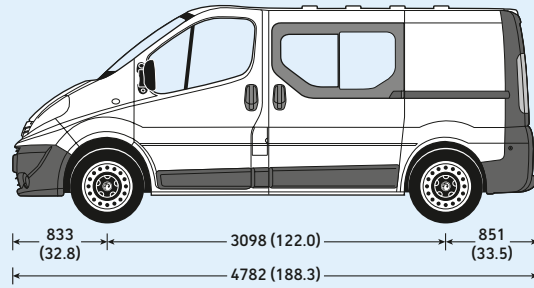

LWB

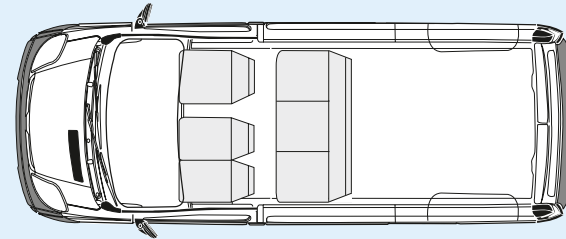
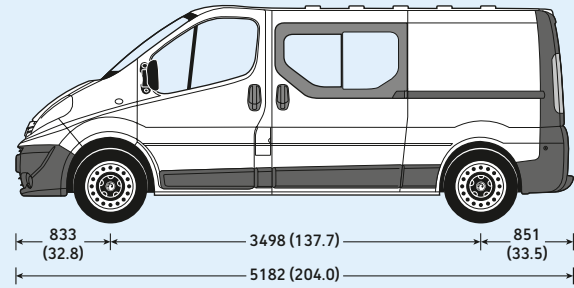

Measurements are shown in millimetres (inches). Height shown unladen.

## Doublecab

### Loadspace volumes cu.m (cu.ft.)

SAE method	SWB	LWB
Standard roof	3.3 (116)	4.2 (148)

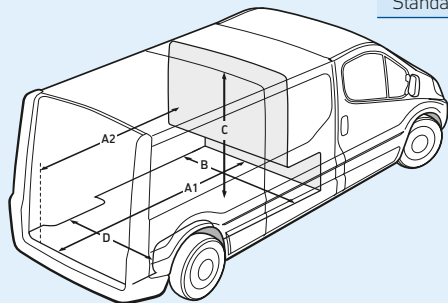

### Interior dimensions mm (inches)

Loadspace	SWB	LWB
<b>A1</b> Maximum length at load floor	1900 (74.8)	2300 (90.5)
<b>A2</b> Maximum length behind rear seats (EU Definition)	1260 (49.6)	1660 (65.3)
<b>B</b> Maximum width	1663 (65.5)	1663 (65.5)
<b>C</b> Maximum height	1387 (54.6)	1387 (54.6)
<b>D</b> Width between wheel arches	1268 (49.9)	1268 (49.9)
<b>Side doors</b>		
Aperture height	1285 (50.6)	1285 (50.6)
Aperture width	1000 (39.4)	1000 (39.4)
<b>Rear doors</b>		
Aperture height – standard roof	1320 (52.0)	1320 (52.0)
Aperture width (at floor)	1390 (54.7)	1390 (54.7)
Loading height – standard roof	549 (21.6)	542 (21.3)

## Weights and towing data

SWB Doublecab models	Transmission	UK plated weights and kerbweights kg				Payload kg	Plated Gross Combination Weights (GCW) kg
		Front axle Plated	Rear axle Plated	GVW Total	Kerb		
2900 2.0CDTI (90/115PS)	manual	1580	1650	2950	1819	1131	4950
2900 2.0CDTI (115PS)	Tecshift	1580	1650	2950	1821	1129	4950
<b>LWB Doublecab models</b>							
2900 2.0CDTI (90/115PS)	manual	1620	1650	3030	1910	1120	5030
2900 2.0CDTI (115PS)	Tecshift	1620	1650	3030	1952	1078	5030

**Note:** Kerbweights for standard vehicles include coolant, oil, 90% full fuel tank and spare wheel. They will vary according to the vehicle specification (including options and accessories) with a corresponding variation in payload. Payload figures do not allow for the weight of the driver, or any passengers, which should therefore be deducted from the figures shown and are also subject to correct weight distribution. Gross plated weights (including axle weights) quoted on the vehicle plate must never be exceeded. Roof load maximum 200kg (includes weight of roof carrier) when Vauxhall approved carrier system used. Towing weights should not exceed 750kg (unbraked trailer) or 2000kg (braked trailer). Sportive models have additional standard features and greater kerbweight which reduces payload.

### Doublecab specific features:

- Three-passenger individually contoured rear bench seat
- Full-height ABS plastic bulkhead with window
- Twin sliding side-access doors with sliding windows
- Additional loadspace under the bulkhead

## Combi

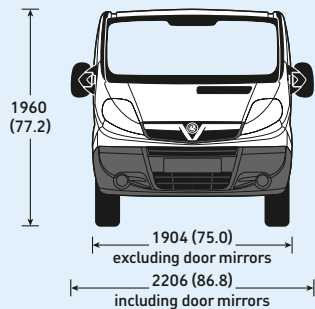

## 9-seat SWB

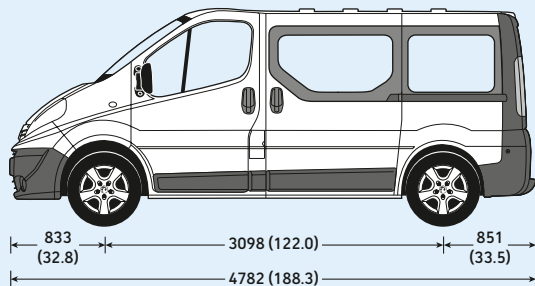

## 9-seat LWB

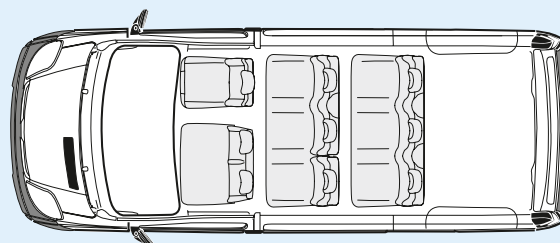
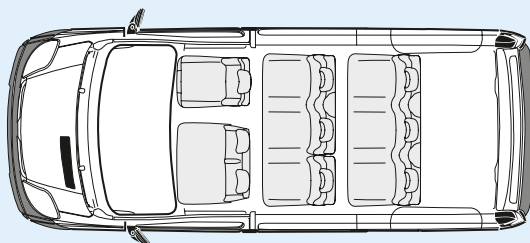
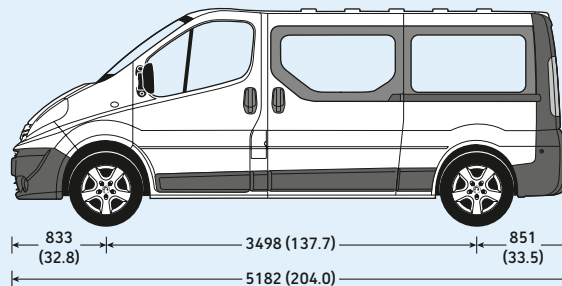

Measurements are shown in millimetres (inches). Height shown unladen.

## Combi folding third-row seat

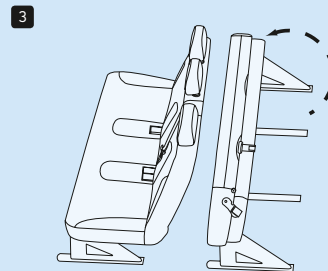
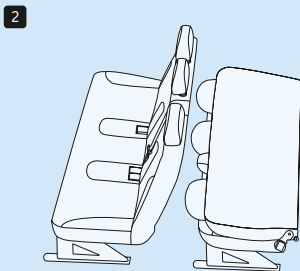
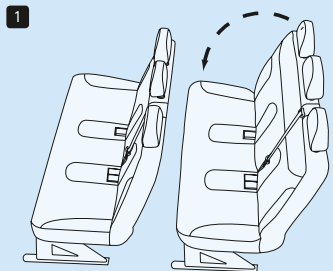

Combi's 'stow and fold' third-row seats (1-3) convert the 9-seat Combi into a six seater with additional luggage space, without having to remove any seats from the vehicle.

## Interior dimensions mm (inches)

Loadspace	SWB	LWB
Maximum length at load floor	1548 (60.9)	1948 (76.7)
Maximum length behind rear seats	744 (29.3)	1144 (45.0)
Maximum width	1663 (65.5)	1663 (65.5)
Maximum height	1387 (54.6)	1387 (54.6)
Width between wheel arches	1268 (49.9)	1268 (49.9)
<b>Side doors</b>		
Aperture height	1285 (50.6)	1285 (50.6)
Aperture width	1000 (39.4)	1000 (39.4)
<b>Rear doors</b>		
Aperture height – standard roof	1320 (52.0)	1320 (52.0)
Aperture width (at floor)	1390 (54.7)	1390 (54.7)
Loading height – standard roof	549 (21.6)	542 (21.3)

## Weights kg

<b>Combi SWB</b>	<b>Kerbweight</b>	<b>GVW</b>
2.0CDTI 16v (90PS)	1893	2920
<b>Combi LWB</b>		
2.0CDTI 16v (115PS)	1954	3040
2.0CDTI 16v (115PS) Tecshift	1968	3050

**Please note:** Kerbweights for standard vehicles include coolant, oil, 90% full fuel tank and spare wheel (where applicable). They will vary according to the vehicle specification (including options and accessories) with a corresponding variation in payload. **Gross plated weights** (including axle weights) quoted on the vehicle plate must never be exceeded. **Roof load** maximum 200kg (includes weight of roof carrier) when Vauxhall approved carrier system used. **Towing weights** (where applicable) should not exceed 750kg (unbraked trailer) or 2000kg (braked trailer).

## Loadspace volumes cu.m (cu.ft.)

	SWB	LWB
Combi (with luggage cover)	N/A	1.1 (38.8)
Combi (without luggage cover)	1.2 (42.4)	2.1 (74.2)
Combi (folded rear bench)	2.5 (88.3)	3.5 (123.6)
Doublecab	3.3 (116)	4.2 (148)

### Combi specific features:

- Electric Pack comprising electrically operated front windows and electrically adjustable/heated door mirrors
- Second-row nearside seat foldable for access to third-row seating
- Third-row, three-passenger 'stow and fold' bench seat
- Full-length, soft-trimmed headlining
- Half-height interior side panelling
- Rubber floor covering
- Passenger assist handles
- Luggage cover (LWB models)
- Nearside and offside glazed sliding side-access doors
- Tinted glass
- Tailgate with heated window and wash/wipe facility

## Fuel economy and emissions

	Fuel economy mpg (litres/100km) <sup>#</sup>			CO <sub>2</sub> emissions (g/km) <sup>#</sup>
	Urban driving	Extra-urban driving	Combined figure	
<b>SWB standard roof panel van</b>				
2700/2900 2.0CDTI (90/115PS) ecoFLEX with speed limiter	34.0 (8.3)	49.5 (5.7)	42.7 (6.6)	174
2700/2900 2.0CDTI (90/115PS) ecoFLEX	32.8 (8.6)	47.9 (5.9)	40.9 (6.9)	180
2700/2900 2.0CDTI (90/115PS) (inc. Sportive)	31.0 (9.1)	43.5 (6.5)	37.7 (7.5)	198
2700/2900 2.0CDTI (115PS) Tecshift (inc. Sportive)	35.8 (7.9)	38.2 (7.4)	37.2 (7.6)	199
<b>SWB high roof panel van</b>				
2900 2.0CDTI (90/115PS)	30.7 (9.2)	39.8 (7.1)	35.8 (7.9)	207
2900 2.0CDTI (115PS) Tecshift	34.9 (8.1)	38.2 (7.4)	36.7 (7.7)	202
<b>LWB standard roof panel van</b>				
2900 2.0CDTI (90/115PS) ecoFLEX with speed limiter	34.0 (8.3)	49.5 (5.7)	42.7 (6.6)	174
2900 2.0CDTI (90/115PS) ecoFLEX	32.8 (8.6)	47.9 (5.9)	40.9 (6.9)	180
2900 2.0CDTI (90/115PS) (inc. Sportive)	31.0 (9.1)	43.5 (6.5)	37.7 (7.5)	198
2900 2.0CDTI (115PS) Tecshift (inc. Sportive)	34.9 (8.1)	38.2 (7.4)	36.7 (7.7)	202
<b>LWB high roof panel van</b>				
2900 2.0CDTI (90/115PS)	30.7 (9.2)	39.8 (7.1)	35.8 (7.9)	207
2900 2.0CDTI (115PS) Tecshift	34.9 (8.1)	38.2 (7.4)	36.7 (7.7)	202

## Fuel economy and emissions

	Fuel economy mpg (litres/100km) <sup>#</sup>			CO <sub>2</sub> emissions (g/km) <sup>#</sup>
	Urban driving	Extra-urban driving	Combined figure	
<b>SWB standard roof doublecab</b>				
2900 2.0CDTI (90/115PS) (inc. Sportive)	30.7 (9.2)	39.8 (7.1)	35.8 (7.9)	207
2900 2.0CDTI (115PS) Tecshift (inc. Sportive)	34.9 (8.1)	38.2 (7.4)	36.7 (7.7)	202
<b>LWB standard roof doublecab</b>				
2900 2.0CDTI (90/115PS) (inc. Sportive)	30.1 (9.4)	39.2 (7.2)	35.3 (8.0)	210
2900 2.0CDTI (115PS) Tecshift (inc. Sportive)	34.4 (8.2)	37.2 (7.6)	36.2 (7.8)	205
<b>SWB/LWB standard roof combi</b>				
2.0CDTI 16v (90PS)	30.4 (9.3)	42.2 (6.7)	37.2 (7.6)	202
2.0CDTI 16v (115PS)	32.1 (8.8)	43.5 (6.5)	38.7 (7.3)	190
2.0CDTI 16v (90/115PS) ecoFLEX	34.9 (8.1)	48.7 (5.8)	42.1 (6.7)	175
2.0CDTI 16v (115PS) Tecshift	34.9 (8.1)	42.2 (6.7)	39.2 (7.2)	188

# = Official Government Test Environmental Data. Official EU-regulated test data is provided for comparison purposes and actual performance will depend on driving style, road conditions and other non-technical factors.

## Glossary of terms

### Plated weight

The maximum weight to which a vehicle or an axle may be loaded, determined either by the design of the components or by legislation. All commercial vehicles must carry a manufacturer's 'plate' showing the vehicle and axle gross 'plated weights'. It is an offence to drive a vehicle in a condition where any of these weights are exceeded.

### Kerbweight

The weight of the complete vehicle in standard form, excluding payload and driver but including coolant, oil, 90% full fuel tank and spare wheel where appropriate. Kerbweights quoted in Vauxhall brochures are subject to manufacturing tolerances and to the fitment of optional equipment and accessories. Where load capacity is critical the actual kerbweight should be obtained by weighing the vehicle on a calibrated public weighbridge.

### Gross Vehicle Weight (GVW)

The total permissible weight of a vehicle including payload and passengers, as shown on the manufacturer's plate.

### Gross Combination Weight (GCW)

The maximum permissible weight of a vehicle, including payload and passengers, combined with the total weight of any trailer it is towing. The maximum GCW weight limit is quoted on the vehicle plate and must not be exceeded.

### Payload

The total permissible weight that can be carried without exceeding the vehicle's plated weight. This can be obtained by deducting the kerbweight from the plated Gross Vehicle Weight (GVW).

**Please note:** the payload figure does not allow for the weight of the driver or any passengers which should therefore be deducted from the figures shown and are also subject to correct weight distribution.

### Maximum towing weight

The maximum weight of any trailer and its load which may be towed within the limit of the vehicle's plated Gross Combination Weight (GCW). It is based on the ability of the vehicle – at full GCW – to restart on a 12% gradient, which is approximately 1 in 8.3, at sea level. At altitudes above 1500 metres, the engine output may drop with a corresponding reduction in towing capability. It is the operator's responsibility to ensure that the trailer noseweight does not cause the rear axle plated weight of the towing vehicle to be exceeded.

*Always fit Vauxhall towing attachments and accessories available from your Vauxhall Commercial Vehicle retailer. They are designed specifically for Vauxhall models and carry a 12-month warranty.*

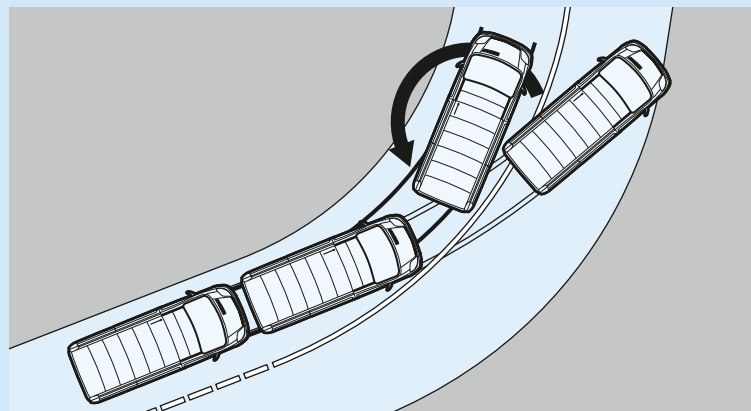

### Electronic Stability Programme-plus (ESP-plus)

Vivaro's optional ESP-plus system goes one step further than the system usually found on Vauxhall's passenger cars. In understeer situations, the system automatically applies corrective braking to the appropriate rear wheel to correct the tendency; in oversteer situations, it automatically applies the brake to the appropriate front wheel. Because a commercial vehicle is also faced with significant weight and load issues which can influence this tendency to understeer or oversteer by affecting the centre of gravity, Vivaro's ESP system also incorporates a load sensor that adjusts the intensity of the braking effort to suit the demands of the payload. The system is available on all Vivaro models not fitted with the Tecshift transmission.

# Trust Vauxhall

## Protecting the environment

Vauxhall's commitment to the environment is demonstrated by our products' many environmental awards, won both through the use of more recycled materials and by becoming cleaner and more efficient. For information on Vauxhall's efforts to achieve an environmentally sustainable future, see [www.vauxhall.co.uk/recycling](http://www.vauxhall.co.uk/recycling)

## Fleet Customer Services

Our dedicated support services for fleet decision makers include factory demonstrators and information on whole life costs, company car and van taxation and finance. For further information please call **0870 010 0651**.

## Vauxhall Extended Warranty

For complete peace of mind Vauxhall offers an extended warranty that can be purchased on an annual basis following the expiry of the original new vehicle warranty. It covers most mechanical and electrical components. Terms and conditions apply. For further details please contact your local Vauxhall Commercial Vehicle retailer.



When you have finished with this brochure please recycle it

## Business Lease

Business Lease, from GMAC, offers the versatility of a purchase-based finance plan, while making the most efficient use of tax and cash-flow benefits for VAT-registered business users. It's available for all Vauxhall Commercial Vehicles up to 12 months old and offers highly flexible term lengths, variable deposits and a choice of payment profiles. Ask your retailer for full details.

## Business First

Available to business users only, Business First enables you to drive a new vehicle without a large, initial financial outlay. You pay to use the vehicle, not to own it. The vehicle is provided over a predetermined period, and when that period comes to an end the vehicle is returned. Ask your retailer for full details.

## Servicing and maintenance

The best way to maximise the performance and reliability of your Vauxhall is to have all routine servicing and maintenance carried out at a Vauxhall Commercial Vehicle retailer. Nationwide there are over 250 light commercial vehicle retailers and a further 195 heavy commercial vehicle retailers.

## In the event of an accident...

Vauxhall Accident Support helps keep you mobile following an accident. Benefits include scene-of-accident advice, message service, assistance with claims and vehicle recovery. For further details call **0800 010 304**.

## Premier Service Centres

Our Premier Service Centres feature a guaranteed same day repair service (provided the parts are in stock) and an appointment-free service for diagnosis and repairs taking less than 90 minutes. All repairs are carried out within 24 hours of the diagnosis.

## For more information...

For a brochure on any Vauxhall model (up to a maximum of three per caller) or location of your nearest retailer, call **0845 600 1500**.

Alternatively, details can be found on our website at: [www.vauxhall.co.uk/vans](http://www.vauxhall.co.uk/vans)

Proud Sponsor of Home Nations Football



Every effort has been made to ensure that the contents of this publication were accurate and up-to-date at the time of going to press (July 2013). Vauxhall vehicles are equipped with components manufactured by various General Motors operating units and outside suppliers. The Company reserves the right to alter specifications and withdraw products from sale without notice. Any such alterations will be notified to Vauxhall retailers at the earliest opportunity, please consult your local retailer for the latest information. The specifications detailed within this brochure are not necessarily applicable to alternative models such as Special Editions. Details of any such models will be contained in specific literature or found on the Vauxhall website. Please note that Vauxhall retailers are not the agents of General Motors UK Limited and are not authorised to bind the Company by any specific or implied undertaking or representation. It is advisable to ensure that your motor insurance policy provides adequate cover for additional fitted options and accessories. Please note accessories shown are for illustrative purposes only. As part of Vauxhall's policy of environmental care, this brochure is printed on paper manufactured using Elemental Chlorine Free pulps from specially farmed, sustainable timber resources. All rights reserved. No part of this publication may be reproduced in any form or by any means, without the prior written permission of General Motors UK Limited.

VM1310678 ©2013 General Motors UK Limited Published July 2013 General Motors UK Limited, Luton LU1 3YT

**COMMERCIAL VEHICLES**  
*The Wheels of Business*



**VAUXHALL**