

# NEW VIVARO

2015 Models Edition 1



Proud Sponsor of Home Nations Football



# The Wheels of Business. Helping you deliver.

Whatever your line of business, Vauxhall Commercial Vehicles can help you deliver. With four different award-winning models – Corsavan, Combo, Movano and New Vivaro – we offer a massive choice of over 350 variants including panel vans, chassis cabs, crew

cabs, platform cabs, tippers, dropsides, box vans and passenger carriers. We're also committed to keeping your business moving. That means reliable, fuel-efficient vehicles – including our new ecoFLEX range – supported by a dedicated network of over 400 retailers



offering the expert support and back-up you need. We build more commercial vehicles at our British production facilities than any other UK manufacturer – indeed, 44,000 vans were built in the UK in 2013 alone. We've also won over 25 industry awards since 2010 –

major awards, presented by some of the toughest judges in the business. Introduce the in-built reassurance of the Vauxhall brand and it's easy to see why Vauxhall Commercial Vehicles really are 'The Wheels of Business'.



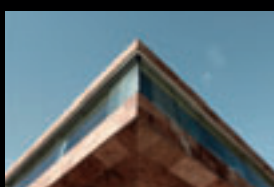
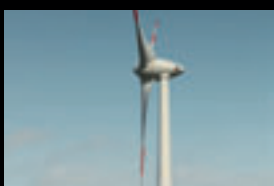

# NEW VIVARO. BUILT TO TAKE IT ALL.

As the proud successor to a model that clocked up more than 950,000 units in over 13 years' continuous production at our Luton plant, New Vivaro seizes the mantle of its illustrious predecessor and moves the game on – big time! With bold new styling, ultra-efficient engines and all-new in-cab connectivity that turns the working environment into a mobile office – New Vivaro is truly built to take it all.

## Siberia Challenge

Underlining its inbuilt reliability, durability and sheer dependability, the all-new, British-built Vivaro recently undertook a 12,000 mile road trip across Europe and Asia. Starting out from the Luton factory the journey – from Europe's most westerly road to Asia's most easterly – took in two continents and 17 countries on route to Siberia. Please see page 50 for the full story.



Some of the vehicles shown include options and accessories available at extra cost. And not all of the features, options or accessories described are available on every model. So please check the Equipment and Technical Data section for further details. From time to time we may also offer alternative models such as Special Editions which are featured in separate literature or can be found on the Vauxhall website: [www.vauxhall.co.uk/vans](http://www.vauxhall.co.uk/vans)

## CONTENTS

## NEW VIVARO

Design and engineering	8
Functionality	10
Interior design	12
Practicality	14
Efficiency	16
ecoFLEX technologies	18
Engines and transmissions	20
Vivaro bodystyles	22
Panel Van features	24
Doublecab features	26
Combi features	28
Cabin features	32
Infotainment	34
Safety and security	36
Vivaro model line-up	38
Options	42
Accessories	44
Colours and trims	46
Siberia Challenge	50
Equipment	52
Technical data	58

**BUILT TO BE VERSATILE.**





New Vivaro

# BUILT TO PERFORM

New Vivaro looks tough because it is tough.

It's been completely redesigned to improve performance in every way. In Panel Van, Doublecab, Combi and Platform Cab variants. And remember, it's built in Britain to the toughest standards so it's robust enough to take everything you can throw at it – and in it.



**Designed to perform with a tough new look**



**Engineered to last**



**Built in Britain to the highest standards**





New Vivaro

# BUILT TO WORK HARDER

Well-equipped with a host of convenience features, New Vivaro is built to work harder with intelligent cab design and is loaded with clever but practical ideas that help get the job done.



**Practical ideas for maximum ease of use**



**Innovative cab design creates a virtual mobile office**



**Enhanced storage features assist your daily working routine**





# BUILT FOR THE LONG HAUL

The all-new interior is exactly that. New.

We've improved the driving environment so you sit more comfortably, with everything you need right at your fingertips. Then there's an improved infotainment system, which means you're well connected and have all your entertainment at hand. On top of all that, the New Vivaro is better to drive than ever.



**Enhanced cab design for total comfort and control**



**Great place to be, great to drive however long the journey**



**Stay in touch with high levels of infotainment and communication**





# BUILT TO BE MORE FLEXIBLE

The efficient New Vivaro doesn't only strike the perfect balance between performance and running costs. It also takes a more flexible approach to load carrying.

Combining a bigger cargo area volume and superb payload capacity with two wheelbase options and the availability of the FlexCargo bulkhead option, the New Vivaro panel van can carry even challenging loads with ease.



**FlexCargo bulkhead available for loads of up to 4150mm in length**



**Improved loadspace dimensions enable L1 models to hold 8ft x 4ft sheets**



**Payload capacity up to 1281kg**





# BUILT TO TAKE YOU FURTHER

The robust New Vivaro isn't just more efficient. It makes your whole business more efficient.

With its superb new range of flexible and efficient turbo-diesel engines and our innovative ECO mode system, this is an altogether more cost-effective Vivaro with smooth power delivery allied to improved economy and reassuringly low CO<sub>2</sub> emissions.



**Impressive fuel economy of up to 47.9mpg (combined figure)**



**CO<sub>2</sub> emissions as low as 155g/km**



**New turbo diesel engines deliver up to 140PS and 340Nm**







# BIG STEPS. SMALL FOOTPRINT

New Vivaro maintains Vauxhall's commitment to reducing the impact of its vehicles, both in terms of operating efficiency and the effect that manufacturing has on the wider environment.

## **ecoFLEX technology**

- Help reduce fuel consumption to cut operating costs
- Achieve higher mileage with a lower carbon footprint
- BiTurbo models include ECO mode for maximum efficiency

## **ECO mode**

- Optimises key system settings
- Prompts more efficient driving

## **Start/Stop**

- Saves fuel and reduces emissions
- Cuts/restarts the engine when appropriate

## **Brake energy regeneration**

- Re-uses energy recovered from vehicle braking
- Helps reduce overall fuel consumption



**ecoFLEX**



New Vivaro

# ENGINES AND TRANSMISSIONS

Delivering more power combined with lower emissions and impressive fuel economy, New Vivaro's smaller displacement – but no less efficient – Turbo and BiTurbo diesel engines deliver the perfect mix of day-to-day performance and competitive fuel consumption. At the same time, our latest ECO system technology – allied to our proven Start/Stop functionality – ensures operating costs are held firmly in check.

## New BiTurbo engines

- Frugal, sequential twin-turbo system
- Lag-free acceleration at any speed
- 1.6 BiTurbo 120PS/140PS available with Start/Stop technology

## Quiet, clean and efficient diesel engines

- Variable-displacement oil pumps reduce fuel consumption
- Low-maintenance chain-driven camshafts
- Multi-point fuel injection for low emissions and high performance
- Optimised thermal management increases efficiency



## Award-winning technology

With its superb new range of flexible and highly economical turbo-diesel engines, this is an altogether more cost-effective Vivaro, with engines delivering up to 140PS and 340Nm, CO<sub>2</sub> emissions as low as 155g/km and impressive fuel economy of up to 47.9mpg (combined figure). Indeed, its sophisticated 1.6 litre BiTurbo CDTI with sequential turbocharging and twin-cooler system has already been presented with the prestigious Innovation Award in the *Van Fleet World Honours* 2014.

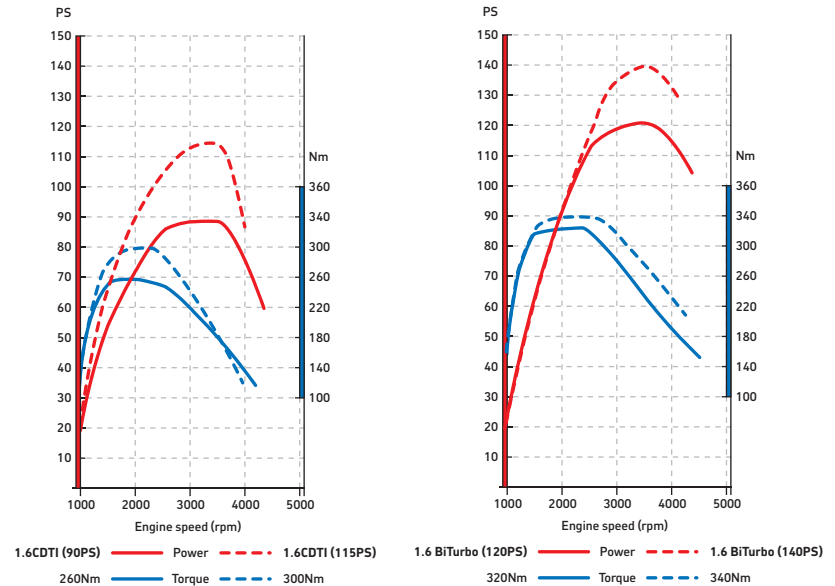

## ENGINES AND TRANSMISSIONS

	Maximum power	Maximum torque	Fuel economy mpg (litres/100km)*			CO <sub>2</sub> emissions (g/km)*
			Urban driving	Extra-urban driving	Combined figure	
<b>Diesel</b>						
<b>1.6CDTI 16v (90PS)</b>	90PS (66kW) @ 3500rpm	260Nm (192 lb.ft) @ 1500rpm	35.8 (7.9) – 36.2 (7.8)	47.9 (5.9) – 49.5 (5.7)	42.8 (6.6) – 43.5 (6.5)	170 – 174
<b>1.6CDTI 16v (90PS) Start/Stop ecoFLEX</b>	90PS (66kW) @ 3500rpm	260Nm (192 lb.ft) @ 1500rpm	39.2 (7.2) – 39.8 (7.1)	49.5 (5.7) – 51.4 (5.5)	45.6 (6.2) – 46.3 (6.1)	160 – 164
<b>1.6CDTI 16v (115PS)</b>	115PS (84kW) @ 3500rpm	300Nm (221 lb.ft) @ 1750rpm	35.8 (7.9) – 36.2 (7.8)	47.9 (5.9) – 49.5 (5.7)	42.8 (6.6) – 43.5 (6.5)	170 – 174
<b>1.6CDTI 16v (120PS) BiTurbo Start/Stop ecoFLEX</b>	120PS (88kW) @ 3500rpm	320Nm (236 lb.ft) @ 1500rpm	34.9 (8.1) – 42.8 (6.6)	44.1 (6.4) – 51.4 (5.5)	40.3 (7.0) – 47.9 (5.9)	155 – 185
<b>1.6CDTI 16v (140PS) BiTurbo Start/Stop ecoFLEX</b>	140PS (103kW) @ 3500rpm	340Nm (250 lb.ft) @ 1750rpm	39.2 (7.2) – 40.3 (7.0)	49.5 (5.7) – 50.4 (5.6)	45.6 (6.2) – 46.3 (6.1)	160 – 164

\*Figures relate to Panel Van, Doublecab and Combi models only.



# VERSATILITY IN ACTION

With a choice of four bodystyles, New Vivaro offers an option to suit every van operator.

The new model is available in the following variants:

- Panel Van – two lengths, two heights
- Doublecab – two lengths
- Combi – two lengths
- Platform Cab



## LOADSPACE DIMENSIONS

Vivaro body versions	Maximum GVW (kg)	Maximum payload (kg)	Maximum loadspace volumes (VDA method)	Maximum load floor lengths (mm)	Maximum load area width (mm)	Width between wheel arches (mm)	Maximum load area heights (mm)	Maximum rear door aperture heights (mm)	Rear door aperture width at floor (mm)	Loading height (unladen) (mm)	Sliding side-access door aperture height (mm)	Sliding side-access door aperture width (mm)
<b>Panel Van</b>												
L1 H1 2700	2760	1080	5.2	2537	1662	1268	1387	1320	1391	552	1284	1030
L1 H1 2900	2920	1240	5.2	2537	1662	1268	1387	1320	1391	552	1284	1030
L1 H2 2900	2920	1160	7.2	2537	1662	1268	1898	1820	1391	552	1284	1030
L2 H1 2900	3010	1281	6.0	2937	1662	1268	1387	1320	1391	552	1284	1030
L2 H2 2900	3020	1200	8.6	2937	1662	1268	1898	1820	1391	552	1284	1030
<b>Doublecab</b>												
L1 H1 2900	2830	1007	3.2	2023	1662	1268	1387	1320	1391	552	1284	1030
L2 H1 2900	2940	1061	4.0	2423	1662	1268	1387	1320	1391	552	1284	1030
<b>Combi</b>												
L1 H1 2900	2800	899	1.0-3.2	736	1662	1268	1387	1320	1391	552	1284	1030
L2 H1 2900	2845	944	1.8-4.0	1136	1662	1268	1387	1320	1391	552	1284	1030

## VARIANTS

### Panel Van



L1 H1

L1 H2\*

L2 H1\*\*

L2 H2\*

### Doublecab



L1 H1

L2 H1\*\*

### Combi\*\*



L1 H1

L2 H1

### Platform Cab†



L2 H1

\*Available from April 2015. \*\*Available from February 2015. †Available from March 2015.



New Vivaro



# PANEL VAN

Versatility and flexibility in equal measure. Whatever you need, the New Vivaro has it all.

## Access and loadspace features include:

- Choice of two wheelbases
- Easy-access, 1m-wide nearside sliding side-loading door
- Full-height steel bulkhead
- Unglazed rear doors (90/165° opening)
- Illuminated load area
- 12-volt electrical accessory socket in load area
- Side and rear doors take a Euro pallet with ease
- Up to 8.6cu.m (303.7cu.ft.) max. loadspace volume
- 2023mm or 2423mm standard load floor lengths
- FlexCargo bulkhead extends loadspace length to up to 4150mm (standard on Sportive models only)
- Floor-mounted, load-securing eyes
- Payload capacity up to 1281kg

Not all features and options are available on every model. Please refer to the Equipment section on pages 52-57.



**1. Euro-pallet friendly.** Specifically designed to carry Euro-pallets, New Vivaro can accommodate up to three pallets, even on L1 models. Assisted by easy side access, the generous 1.2m width between the rear wheel arches also makes the new van suitable for carrying wide loads such as 8ft. x 4ft. plywood sheets.

**2. Flexible loadspace.** Standard on Sportive and optional on Panel Van models, the FlexCargo bulkhead allows loads of up to 4150mm in length to be accommodated with ease.



# DOUBLECAB

The Doublecab matches practical and comfortable crew transport to excellent loadspace and payload.

## Access and loadspace features include:

- Choice of two wheelbases
- Twin sliding side-access doors with fixed windows
- Up to 4.0cu.m (141.3cu.ft.) max. loadspace volume
- High-strength ABS plastic bulkhead with window
- Half-height sidewall trim with storage pocket
- Three-passenger rear bench seat
- Bench seat with additional storage, armrests, ISOFIX child seat restraint system on outer seats and 12-volt electrical accessory socket (Sportive models only)
- Unglazed rear doors (90/165° opening)
- Glazed rear doors or glazed tailgate (optional)
- Heated rear window and wash/wipe (optional)
- Rear doors take a Euro pallet with ease
- 1354mm or 1754mm standard load floor lengths
- Additional loadspace under rear bulkhead extends loadspace length to up to 2439mm (L2 models)
- Floor-mounted load restraint lashing eyes
- Payload up to 1061kg

Not all features and options are available on every model. Please refer to the Equipment section on pages 52-57.



**1. Twin sliding side-access doors.** The extra-wide door opening ensures easy passenger access while the individually-contoured rear bench seat accommodates up to three passengers in complete comfort with excellent leg room and raked rear seat backs .

**2. and 3. Loads of loadspace.** There's instant access to underseat storage in the passenger section, plus up to 4.0cu.m of usable loadspace.



# COMBI

The Combi\* provides generous accommodation allied to generous luggage space and is ideally suited to hotel and airport shuttle bus work and private-hire companies.

## Combi standard features include:

- Nine-seat configuration with choice of two wheelbases
- Twin sliding side-access doors with fixed windows
- Three-passenger second and third-row bench seats
- 60/40 split-folding seat back for second-row bench seat
- Fold and tumble facility for third-row bench seat
- Removable second and third-row bench seats
- Inertia-reel lap and diagonal seatbelts for all seats
- Glazed tailgate with heated rear window and wash/wipe facility
- Rubber floor covering
- Half-height sidewall trim
- Load restraint lashing eyes for load area
- Appearance Pack option available (see page 43 for full details).

Not all features and options are available on every model. Please refer to the Equipment section on pages 52-57.

\*Available from February 2015.



**1. Second-row split-folding rear seat.** The easy-to-operate split-folding seat back allows convenient access for third-row passengers.

**2. Nine-seater comfort.** Combi offers comfortable seating for up to eight passengers.

**3. and 4. Additional comfort.** Optional rear air conditioning controls and a separate rear heater are also available for Combi.

**MORE VERSATILE**



Available in a choice of short and long wheelbase models, New Combi delivers the perfect blend of passenger carrying ability and load carrying potential. The dynamic new look and improved interior can be further enhanced with the addition of the Appearance Pack, see page 43.



**1. Transport for up to eight passengers.**

With maximum versatility assured through its mix of foldable/removable seating configurations, Combi provides transport for up to eight passengers, making it ideal for transporting work crew. Generously proportioned rear sliding doors make Combi easy to enter and exit, heightening the model's potential as a courtesy vehicle.

**2. and 3. Rear seat combinations.** With its tumble and fold or removable third-row seating, Combi can accommodate the required mix of passengers and luggage with ease.

**4. Versatile and adaptable.** With the second and third row seats removed, the vehicle can even double as a conventional Panel Van, should the need arise.

# WELCOME TO YOUR OFFICE

New Vivaro's interior reflects Vauxhall's understanding of the challenges faced by van operators in their daily working lives. Comfort and control levels are optimised right across the cab, along with enhanced infotainment connectivity. Premium quality materials are used throughout for improved appearance, durability and owner appeal. Finally we've improved the interior ergonomics across the van, further enhancing the interface between driver and vehicle.

**Fold-flat centre front passenger seat.** The centre section of the fold-flat front passenger seat features a handy clipboard holder which can also be removed when necessary, leaving a handy, solid and flat surface. The unit also flips forward to create a lidded work surface, with hidden, secure storage for work paraphernalia – eg. maps, handbooks, general documentation – along with an additional drinks holder. The folding process takes just seconds. Standard on Sportive and optional on standard Panel Van models.







**1. Aux-in and USB.** Most audio units feature integrated aux-in and USB ports within the fascia, enabling drivers to connect their mobile devices and access a wide range of multi-media files. An additional USB port is fitted in the upper fascia to enable the charging of mobile phones and MP3 devices.

**2. The Vivaro fascia** features nine storage spaces, providing more than 24 litres of storage volume in total. Highlights include a large, usable glovebox, upper fascia storage, three drinks holders and a handy driver's storage pocket.

**3. The clipboard itself** can be securely fastened in two positions, easily visible to either the driver or passenger. It's suitable for documents up to A4 in size, including contracts, invoices and general day-to-day paperwork.

**4. Generous door pockets** provide useful stowage space for maps, documents and other essential workday items.

# ENHANCED CONNECTIVITY

With enhanced infotainment connectivity, New Vivaro is, quite simply, one of the best-connected vans on the market!

All New Vivaro models offer:

- Bluetooth® connectivity and USB for smart phones and MP3 players
- Digital radio
- Steering column-mounted audio and telephone controls
- Aux-in socket
- Optional satellite navigation system with integrated IntelliLink technology

**1. NAVI 80 IntelliLink.\*** Features 7-inch colour touchscreen, Bluetooth® connectivity, audio streaming and advanced navigation functions – with maps that can be simply updated by USB download and data transfer. Better still, the IntelliLink system integrates the most important functions of your smartphone. The system also features voice commands for navigation.

\*Available from January 2015.





**2. R 16 BT USB.** The entry-level system offers exceptional functionality featuring Bluetooth® and USB connectivity as well as digital radio as standard.

**3. CD 18 BT USB.** The CD 18 BT USB features the same specifications as the R 16 BT USB but adds a CD player and is configured in the double-DIN format.

**4. Tablet docking station.** Compatible with the R 16 BT USB, this facility allows tablets between 4.8 and 10.6 inches to be securely fixed in place for ease of use.

**5. Smartphone docking station.** This feature allows smartphones of up to a 4.7-inch screen size to be securely mounted within easy sight and perfect reach. Power is taken from the upper USB socket on the fascia.

**NAVI 50.** Specifically tailored to the new model's cab environment, the NAVI 50 unit provides drivers with an accurate and affordable navigation option. Key features include a 7-inch colour touchscreen, Bluetooth® connectivity, steering wheel mounted controls and MP3/WMA playback from CD or USB and Bluetooth® audio streaming.

# SAFETY AT WORK



Safety and security in the workplace and out on the road are key concerns for any business and New Vivaro is no exception. While many of its advanced active and passive protection features will be reassuringly familiar to Vauxhall drivers, the new model is more safe and secure than

ever. Standard safety equipment includes the very latest Electronic Stability Programme (ESP-plus) with integrated traction control, roll-over mitigation and hill-start assist, anti-lock braking system with electronic brakeforce distribution and emergency brake assist.

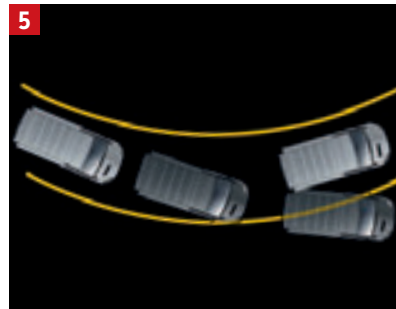

**1. Optional rear-view camera.** Activated automatically when reverse gear is selected, the system provides clear rearward vision by displaying in the rear view mirror. When fitted in conjunction with the optional NAVI 80 IntelliLink system (illustrated) the 7-inch screen is utilised.

**2. Wide-angle blind spot mirror.** Located in the passenger sunvisor, it provides additional visibility on unglazed Panel Vans.

**3. Selective door locking** allows the cab area to be unlocked independently of the load compartment, and vice versa, reducing the opportunities for theft. Standard on Sportive, optional on other models.

**4. Keyless entry and start.** Operated via a key card that slots into the fascia. Doors can be opened remotely via the key card and the engine is stopped and started via a button on the centre console. Optional on Sportive models only from January 2015.

**5. ESP-plus with integrated roll-over mitigation.** This system senses when the vehicle departs from the driver's chosen path. The roll-over mitigation feature constantly monitors the vehicle's behaviour and intervenes when it threatens to lean to one side, to help stabilise the vehicle.

# VIVARO

Vivaro models open their account with a generous level of equipment that puts many rival models to shame.

## Standard features include:

- Electric stability programme with traction control
- Electrically operated front windows
- Electrically adjustable/heated door mirrors
- Remote control central deadlocking
- ABS with electronic brake force distribution
- ECO mode
- Electronic engine deadlock immobiliser
- Full-height steel bulkhead (Panel Van only)
- Wide-angle blind spot mirror
- Six-way adjustable driver's seat with height adjustable armrest and lumbar adjustment
- Steering column adjustable for reach and rake
- Multi-function trip computer
- R 16 BT USB digital radio/AM/FM stereo radio
- Bluetooth® connectivity – USB and aux-in facility
- Steering wheel mounted audio and phone controls
- Illuminated glovebox
- Facia-mounted drinks holders
- Blue Tricess cloth seat trim
- Driver's airbag
- Dual front passengers bench seat
- 16-inch wheels



MODEL AVAILABILITY	L1 H1		L1 H2**		L2 H1*		L2 H2**	
	2700	2900	2700	2900	2700	2900	2700	2900
Panel Van	•	•	–	•	–	•	–	•
Doublecab	–	•	–	–	–	•	–	–
Combi*	–	•	–	–	–	•	–	–
Platform Cab**	–	–	–	–	–	•	–	–

\*Available from February 2015.

\*\*Available from March 2015.



L1 H1 2700 model illustrated features Flame Red paint.

# VIVARO SPORTIVE

Sportive models build on the generous specification of the standard van with many added features, enhanced style accents and even greater levels of comfort.

## Additional features over and above standard models:

- Body-colour front and rear bumpers, side mouldings, exterior mirror housings and rear light cluster surrounds
- Air conditioning with air recirculation (cab only)
- FlexCargo bulkhead
- Dual passenger bench seat with dump latch centre section featuring storage, tray and dual position clipboard facility
- Cruise control with speed limiter
- Selective door locking
- Three-button key
- Rear parking distance sensors
- CD 18 BT USB CD/MP3 CD player/digital radio/ stereo radio
- Black Connect embossed cloth seat trim
- Leather-covered steering wheel and gear knob
- LED daytime running lights
- Front fog lights with chrome surround
- Full-diameter wheel trims



MODEL AVAILABILITY	L1 H1		L2 H1	
	2700	2900	2700	2900
Panel Van	•	•	-	•
Doublecab	-	•	-	•





L1 H1 Sportive 2900 model illustrated features Flame Red paint. NAVI 80 IntelliLink sat nav system, Sight and Light Pack and 17-inch alloy wheels, optional at extra cost.

# OPTIONS

New Vivaro offers a wide range of options and option packs to suit every individual need. For more information and pricing please speak to your Vauxhall Commercial Vehicle retailer.

## Safety and security

- Front passengers' airbag with deactivation switch

## Interior

- Single front passenger's seat adjustable for height, reach and rake with armrest and lumbar adjustment
- Air conditioning with air recirculation facility (cab and rear passenger area), with auxiliary heater – Combi models

## Exterior

- Front fog lights
- Rear parking distance sensors
- Rear parking distance sensors with rear-view camera
- Tow bar with 13-pin electrics (includes trailer stability programme)
- Dark-tinted rear windows – Combi models

## Load area

- Vertical luggage restraint – half-height solid with black upper mesh – Combi models
- Luggage cover – Combi models
- Offside sliding side-access door
- Nearside and offside glazed sliding side-access doors
- Nearside and offside glazed sliding side-access doors with sliding windows

Please refer to the Equipment section on pages 52-57 for complete option availability.





**4. Appearance Pack.** LED daytime running lights, front fog lights, full-diameter wheel trims, body-colour front bumper, body-colour rear quarter bumpers, Black Connect cloth seat trim, leather-covered steering wheel and gearknob. Alloy wheels illustrated are also optional at extra cost.

**2. and 3. Rear door options:**

- Glazed rear doors, 90/165° opening
- Unglazed rear doors, 270° opening (L2 H1 models only)
- Glazed rear doors, 270° opening (L2 H1 models only)
- Glazed tailgate (not available H2 models)
- Glazed tailgate with wash/wipe facility (not available H2 models)

*Glazed rear doors mandate glazed bulkhead.*

**4. Load area protection.** A range of options are available to help protect loads and safeguard the interior:

- Rubber-coated reinforced wooden load floor covering
- Resin-coated laminate plywood load floor covering
- Half-height plastic load lining panels
- Full-height lightweight plastic honeycomb load lining panels
- Resin-coated laminate plywood wheel arch protection.



**5. Comfort Pack.** Air conditioning with air recirculation facility (cab only), front fog lights, automatic lighting control, rain-sensitive windscreen wipers.

**6. Safety Pack.** Front seat passengers' airbag with deactivation switch, driver's side-impact and curtain airbags, cruise control with speed limiter

**7. Bulkheads.** New Vivaro can be specified with a full steel or glazed bulkhead.

# ACCESSORIES

Vauxhall options and accessories are all about choice – selecting your New Vivaro then personalising it to suit the way you work.

There's a comprehensive range of Genuine Vauxhall Accessories all designed and manufactured to the same exacting standards as the van itself.

We've only shown a selection of what's available here; for the complete range please contact your local retailer for further information.





**1. Roof carrier system.** The base accessory roof carrier system can be fitted with a steel roof rack complete with loading roller. A steel loading ladder and roof walk way are also available.

**2. Roof carrier with rollers.** Manoeuvre and secure goods on the roof easily and safely. And reduce the risk of chipping your van.

**3. Base carrier.** The sure-fire way to fasten long or awkward loads to the roof. The base carrier works best with a roof rack, ladder clamp, loading bars and load stop.

**4. Rear mudflaps.** The essential accessory designed to protect the lower bodywork against stone chips, grit and other road material.



**5. Tow bars.** Available in a choice of fixed or detachable, ball, jaw or pin design, New Vivaro's tow bars are available to suit the needs of customers looking for a trailer load of up to 2000kg.

**6. Interior roof rack.** Utilises the normally unused space under the vehicle roof to enable the loading of bulky items safely inside the load area.

**7. Load area entry guard.** Covers and protects the rear bumper when loading and unloading.



# EXTERIOR COLOURS

Stylish hard-working vans deserve a striking paint scheme to match.

## SOLID



Glacier White



Flame Red



Iron Grey



Spring Green



Ink Blue\*

Due to the limitations of the printing process, the colours reproduced may vary from the actual colour. As a result they should be used as a guide only. Please note: Certain alternative colours are available for special order on New Vivaro. Restrictions apply so please consult your Commercial Vehicle retailer for more details.

**TWO-COAT METALLIC\*\***



Panorama Blue



Midnight Black



Cassiopeia Silver



Copper Brown



Jasper Brown



Platinum Silver

\*Not available on Sportive models or in conjunction with Appearance Packs.  
\*\*Optional at extra cost. No-cost option on Sportive.

# INTERIOR TRIMS

A smart van interior says a lot about your business.

## BLUE TRICESS - STANDARD MODELS



Blue Tricess cloth seat insert.



**BLACK CONNECT – SPORTIVE MODELS\***

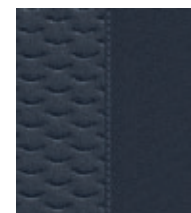

Black Connect embossed cloth seat insert.

\*Also available as part of Appearance Pack 2 on Combi models.

# SIBERIA CHALLENGE

Underlining the model's inherent reliability and durability, the all-new Vivaro recently completed a 12,000 mile road trip across Europe and Asia – the longest possible journey overland without crossing an ocean. The journey began at the Luton factory where the new model is produced.

The route tested the team across a challenging mix of high-speed autobahns, broken tarmac, tracks across Mongolia's vast Steppe and 2,000 miles of graded dirt in Siberia – a massive achievement for a standard front-wheel drive van. It included a stretch of the notorious M56 Kolyma Highway through the Russian Far East – often referred to as 'The Road of Bones'. The expedition, designed as a fundraiser for the charity Help for Heroes, saw a team including ex-soldiers, a mechanic and a medic embark on the journey of a lifetime in three Vivaro vans.

The route from Europe's most westerly road to Asia's most Easterly took in two continents and 17 countries. Final destination was the remote city of Magadan in Siberia. Needless to say, New Vivaro passed the test with flying colours.

For more details about the New Vivaro's incredible trek, log on to [www.vauxhall.co.uk/siberiachallenge](http://www.vauxhall.co.uk/siberiachallenge).

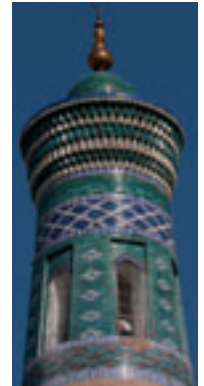



*“This was the opportunity of a lifetime for the ex-servicemen and women to take part in a memorable two-month journey to help them re-adjust to civilian life. It was also the perfect opportunity to demonstrate that the all-new Vivaro is built to take it all.”*

**Steve Bryant,  
Brand Manager  
Vauxhall Commercial Vehicles**



## SAFETY AND SECURITY

**Standard features** • Electronic Stability Programme-plus (ESP-plus) with traction control • Anti-lock Braking System (ABS) with electronic brakeforce distribution • Emergency brake assist • All-round disc brakes • Driver's airbag • Driver's active-safety head restraint • Height-adjustable padded head restraints • Three inertia-reel lap and diagonal seatbelts (Doublecab-six/Combi-nine) • Height-adjustable outer front seatbelts • Pyrotechnic body-lock front seatbelt pretensioner system • Front seatbelt force limiters • Anti-submarining ramps in front seats • Side-impact protection beams • Laminated windscreen • Remote control central deadlocking with internal switch • Electronic theft protection for audio equipment • 'Key left in ignition' audible warning • Visible Vehicle Identification Number (VIN) • Alarm pre-installation kit • ISOFIX child seat restraint system on outer second-row seats (Doublecab)

<b>Additional features</b>	Panel Van	Doublecab	Sportive Panel Van	Sportive Doublecab	Platform Cab	Combi
<b>Safety Pack</b> • Front passengers' airbag with deactivation switch • Driver's side-impact and curtain airbags • Cruise control with speed limiter	○	○			○	○
Front passengers' airbag with deactivation switch	○	○	○	○	○	●
Driver's and front passengers' curtain airbags • Driver's side-impact airbag	○ <sup>1</sup>		○			○
Driver and single front passenger's curtain airbags • Driver and front passenger side-impact airbags <sup>2</sup>	○	○	○	○	○	○
Selective door locking	○ <sup>3</sup>	○ <sup>3</sup>	●	●		
Keyless entry and start with electronic climate control (available from 2015) <sup>4</sup>			○	○		
Third key (available from 2015)	○	○	○	○		
Tyre pressure monitoring system	○	○	○	○	○	●

## FACIA, INSTRUMENTS AND CONTROLS

**Standard features** • Facia-mounted gear lever • Steering column adjustable for reach and rake • Trip odometer • Rev counter • Fuel gauge with low fuel level warning light • Engine oil level indicator • Service-due indicator • Exterior temperature display • Multi-function trip computer (provides information on fuel used, overall distance, average and instantaneous fuel consumption, remaining range, distance before service and average speed. Plus additional driver information messages as detailed in the owner's manual) • Digital clock with automatic RDS time adjustment • 12-volt electrical accessory socket • Illuminated glovebox • Open storage compartment above glovebox, lidded on Sportive models • Extensive facia storage • Facia-mounted drinks holders • Steering wheel mounted audio and phone controls • Twin sunvisors, front passengers' with wide-angle blind spot mirror • Air blend heater with four-speed fan • Four adjustable face-level heating and ventilation outlets • Windscreen and front side-window demist vents • Air recirculation system

<b>Additional features</b>	Panel Van	Doublecab	Sportive Panel Van	Sportive Doublecab	Platform Cab	Combi
<b>Comfort Pack</b> • Air conditioning with air recirculation facility (cab only) • Front fog lights • Automatic lighting control • Rain-sensitive windscreen wipers	○	○			○	○
<b>Smoker Pack</b> • Cigar lighter • Removable ashtray	○	○	○	○	○	○
Air conditioning with air recirculation facility (cab only)	○	○	●	●	○	○
Electronic climate control incorporating air conditioning (available from 2015) <sup>5</sup>	○	○	○	○	○	
Digital tachograph <sup>6</sup>	○	○			○	○
Cruise control with speed limiter	○	○	●	●	○	●
Leather-covered steering wheel			●	●		□
Chrome-effect instrument surrounds			●	●		□
Chrome-effect gear lever insert and interior door release			●	●		
Rear saloon heating (fuel-fired)						○



NAVI 80 IntelliLink satellite navigation.



R 16 BT USB with digital radio.



Steering mounted audio controls.



USB connectivity and coin holder.

## AUDIO, COMMUNICATION AND NAVIGATION

Features	Panel Van	Doublecab	Sportive Panel Van	Sportive Doublecab	Platform Cab	Combi
<b>Navigation Pack</b> <sup>5,7</sup> • Satellite navigation • Rear parking distance sensors • Rear-view camera • One-touch facility for electrically operated front windows • Three-button key • Selective door locking	○	○	○	○		○
<b>R 16 BT USB</b> • Digital radio • AM/FM stereo radio with 6-station presets • Aux-in socket • Bluetooth® connectivity • USB connection • 20 watts per channel output • 2 speakers <sup>8</sup>	●	●	N/C <sup>9</sup>	N/C <sup>9</sup>	●	●
<b>CD 18 BT USB</b> • CD/MP3 CD player • Digital radio • AM/FM stereo radio with 6-station presets • Aux-in socket • Bluetooth® connectivity • USB connection • 20 watts per channel output • 2 speakers <sup>8</sup>	○	○	●	●	○	○
<b>NAVI 50</b> • Satellite navigation • 7-inch colour touch-screen • Street level mapping for UK and Ireland • CD/MP3 CD player • AM/FM stereo radio with 12-station presets • Aux-in socket • Bluetooth® connectivity • USB connection • 20 watts per channel output • 2 speakers <sup>8</sup>	○	○	○	○	○	○
<b>NAVI 80 IntelliLink</b> (available from 2015) <sup>10</sup> • Satellite navigation • 7-inch colour touch-screen • Major route mapping for Western Europe • IntelliLink • Digital radio • CD/MP3 CD player • AM/FM stereo radio with 12-station presets • SD card reader • Aux-in socket • Bluetooth® connectivity • USB connection • 20 watts per channel output • 2 speakers <sup>8</sup>	○	○	○	○	○	○
FLEXDOCK – universal smartphone docking station (up to 4.7-inch)	○	○	○	○	○	○
FLEXDOCK – tablet docking station (4.8–10.6-inch)	○	○	N/C <sup>9</sup>	N/C <sup>9</sup>	○	○

## INTERIOR FEATURES

**Standard features** • Vinyl floor covering in cabin area • Two bulkhead-mounted coat hooks • Fade down cabin area courtesy light • Door armrests • Front door pockets with bottle holder • Full-length, soft-trimmed saloon headlining (Combi) • Half-height interior saloon panelling (Combi) • Rubber floor covering (Combi)

● = Standard equipment. ○ = Optional at extra cost. □ = Only available as part of an extra-cost option pack. N/C = No-cost option.

1 = Only available in conjunction with dual front passengers' seat with storage, rotating clipboard, fold-flat centre and FlexCargo load-through bulkhead. 2 = Mandates single passenger seat and one-touch facility for electrically operated front windows. 3 = Mandates one-touch electrically operated windows. 4 = Start/Stop models only. Only available in conjunction with Sight and Light Pack. 5 = Only available in conjunction with Lighting Pack (standard models) or Sight and Light Pack (Sportive models). 6 = Only with R 16 audio unit, not available on Start/Stop models. Digital tachograph is not available with optional audio units. The digital tachograph option must be specified at time of ordering as it cannot be fitted retrospectively. Vehicles fitted with tachograph include odometer display, in kilometres, replacing standard odometer display on instrument cluster. Option price for digital tachograph does not include calibration which must be carried out at an approved tachograph centre within 14 days of the vehicle's registration. **Please note:** The legislation regarding the use of tachographs is complex and operators should seek independent advice or speak to the CV specialist within a Vauxhall Commercial Vehicle retailer to ensure compliance. Alternatively your local DVLA office will also be able to provide clarification of the relevant legislation. 7 = Only available on H1 models. 8 = Combi models are fitted with four speakers. 9 = R 16 BT USB audio unit with FLEXDOCK tablet docking station available at no extra cost in lieu of standard CD 18 BT USB audio unit. 10 = Requires cruise control on non-Sportive models.

## SEATING

**Standard features** • Six-way adjustable driver's seat with height adjustment, armrest and lumbar adjustment • Rear seat 12-volt accessory socket (Doublecab)

<b>Additional features</b>	<b>Panel Van</b>	<b>Doublecab</b>	<b>Sportive Panel Van</b>	<b>Sportive Doublecab</b>	<b>Platform Cab</b>	<b>Combi</b>
Blue Tricess cloth seat trim	●	●			●	●
Black Connect embossed cloth seat trim			●	●		□
Dual front passengers' seat	●	●		●	●	●
Dual front passengers' seat with storage, rotating clipboard, fold-flat centre • FlexCargo load-through bulkhead	○		●			
Dual front passengers' seat with storage, rotating clipboard, fold-flat centre • Glazed FlexCargo load-through bulkhead	○		○			
Single front passenger's seat adjustable for height, reach and rake with armrest and lumbar adjustment						○
Single front passenger's seat adjustable for height, reach and rake with armrest and lumbar adjustment • Front passenger's airbag	○	○	○	○	○	
Single front passenger's seat adjustable for height, reach and rake with armrest and lumbar adjustment • Front passenger's airbag • Driver and front passenger's side-impact airbags • Driver and front passenger's curtain airbags	○	○	○	○	○	○
<b>Heated seats – Driver and single passenger's</b> • Electrically heated front seats • Single front passenger's seat adjustable for height, reach and rake with armrest and lumbar adjustment • Driver and front passenger's side-impact airbags • Driver and front passenger's curtain airbags • One-touch electrically operated windows	○	○				○
<b>Heated seats – Driver and dual front passengers'</b> • Electrically heated front seats • Dual front passengers' seat with storage, rotating clipboard, fold-flat centre and FlexCargo load-through bulkhead • Driver's side-impact airbag • Driver and front passengers' curtain airbags	○					
<b>Heated seats – Driver and single passenger's</b> • Electrically heated front seats • Single front passenger's seat adjustable for height, reach and rake with armrest and lumbar adjustment • Driver and front passenger's side-impact airbags • Driver and front passenger's curtain airbags			○	○		
<b>Heated seats – Driver and dual front passengers'</b> • Electrically heated front seats • Driver's side-impact airbag • Driver and front passengers' curtain airbags			○			
Three-passenger rear bench seat with underseat storage		●		●		
Second-row nearside seat foldable for access to third-row seating						●
Fold and stow facility for rear bench seat						●

● = Standard equipment. ○ = Optional at extra cost. □ = Only available as part of an extra-cost option pack.

7 = Only available on H1 models. 11 = Only available in conjunction with resin-coated laminate plywood load floor covering and full-height side load lining panels. 12 = Only available with glazed bulkhead options.



Glazed tailgate with heated window and wash/wipe facility.



FlexCargo load-through facility.



Dual front passenger seat with storage.



Fold-flat centre front passenger seat storage.

## LOAD AREA

**Standard features** • Nearside sliding side-access door • Illuminated load area • Side load restraint lashing eyes (L1/L2 - 10) • Floor load restraint lashing eyes (L1 - 6/L2 - 8)  
**• Unglazed rear doors (90°/165° opening)**

<b>Additional features</b>	<b>Panel Van</b>	<b>Doublecab</b>	<b>Sportive Panel Van</b>	<b>Sportive Doublecab</b>	<b>Platform Cab</b>	<b>Combi</b>
<b>Loading Pack with cargo lining</b> • Unglazed steel bulkhead with FlexCargo load-through facility • Dual front passenger seat with storage, rotating clipboard, fold-flat centre and load through compatibility • Resin-coated plywood load floor covering • Half-height plastic load lining panels	○					
Full-height unglazed steel bulkhead	●					
Full-height unglazed steel bulkhead with FlexCargo load-through facility			●			
Full-height steel glazed bulkhead	○		○		●	
Full-height ABS plastic bulkhead with window		●		●		
Offside sliding side-access door	○		○			
Offside sliding side-access door • Fixed windows to both nearside and offside doors	○	●	○	●		●
Offside sliding side-access door • Sliding windows to both nearside and offside doors	○	○	○	○		○
Rubber-coated reinforced wooden load floor covering <sup>7</sup>	○	○	○	○		
Resin-coated laminate plywood load floor covering	○	○	○	○		
Half-height plastic side load lining panels	○	○	○	○		●
Full-height lightweight plastic honeycomb side load lining panels <sup>7</sup>	○	○	○	○		
Full-height coated wooden side load lining panels <sup>7</sup>	○	○	○	○		
Resin-coated laminate plywood wheel arch protection <sup>7,11</sup>	○	○	○	○		
Vertical luggage restraint – half-height solid with black upper mesh						○
Luggage cover						○
Glazed rear doors (90°/165° opening)	○ <sup>12</sup>	○	○ <sup>12</sup>	○		○
270° opening unglazed rear doors (L2 H1 only)	○	○	○	○		
270° opening glazed rear doors (L2 H1 only)	○ <sup>12</sup>	○	○ <sup>12</sup>	○		
Glazed tailgate with heated window and wash/wipe facility (H1 only)	○ <sup>12</sup>	○	○ <sup>12</sup>	○		●

## EXTERIOR FEATURES

**Standard features** • Electrically operated front windows • Electrically adjustable/heated door mirrors • Daytime running lights • Tinted glass • Two-speed windscreen wipers with variable intermittent wipe and electric screenwash • Lights-on audible warning • Electric headlight beam levelling • Twin adjustable and foldable door mirrors (wide-angle on driver's side) • High-level tail lights • High-level brake light • Twin reversing lights • Rear fog light • Body side-protection mouldings • Side repeat indicators

<i>Additional features</i>	Panel Van	Doublecab	Sportive Panel Van	Sportive Doublecab	Platform Cab	Combi
<b>Lighting Pack</b> • Front fog lights • Automatic lighting control • Rain-sensitive windscreen wipers	○	○			○	○
<b>Sight and Light Pack</b> • Automatic lighting control • Rain-sensitive windscreen wipers			○	○		
<b>Appearance Pack One</b> <sup>13</sup> • Body-colour front bumper • Body-colour rear quarter bumpers	○	○				○
<b>Appearance Pack Two</b> <sup>13</sup> • Leather-covered steering wheel • Black Connect embossed cloth seat trim • Chrome-effect instrument surrounds • Lidded storage compartment above glovebox • LED daytime running lights • Front fog lights • Full-diameter wheel trims • Body-colour front bumper • Body-colour rear quarter bumpers						○
Front fog lights	○	○	●	●	○	○
Rain-sensitive windscreen wipers	□	□	□	□	□	□
Automatic Lighting Control (ALC)	□	□	□	□	□	□
One-touch facility for electrically operated front windows	○	○	●	●		
Rear parking distance sensors	○	○	●	●		○
Rear parking distance sensors with rear-view camera <sup>5,7</sup>	○	○	○	○		○
Tow bar with 13-pin electrics (includes trailer stability programme) <sup>14</sup>	○	○	○	○		○
Body-colour door mirrors			●	●		
Body-colour side-protection mouldings			●	●		
Body-colour front bumper			●	●		□
Body-colour rear bumper, quarter bumpers and rear light cluster surrounds			●	●		
Dark-tinted rear passenger windows						○
Long arm exterior mirrors – for conversions with an overall width of 2.17 to 2.35 metres					○	
Two-coat metallic paint	○	○	●	●		○

● = Standard equipment. ○ = Optional at extra cost. □ = Only available as part of an extra-cost option pack. N/C = No-cost option.

5 = Only available in conjunction with Lighting Pack (standard models) or Sight and Light Pack (Sportive models). 7 = Only available on H1 models. 13 = Not available when Ink Blue paint is specified. 14 = Unless the user qualifies for a specific exemption, vehicles operated with a trailer, where the combined weight of the vehicle, trailer and payload exceeds 3500kg, will need a digital tachograph. 15 = BiTurbo models only.





16-inch full-diameter wheel trims.



17-inch five-spoke alloy wheels.



Front fog lights.



LED daytime running lights.

## MECHANICAL

**Standard features** • Six-speed manual gearbox • Power-assisted steering • ECO engine mode including switchable engine mapping for improved fuel economy and reduced power drain from heater and air conditioning (when fitted)

<b>Additional features</b>	Panel Van	Doublecab	Sportive Panel Van	Sportive Doublecab	Platform Cab	Combi
Engine-driven power take-off with CANbus	○	○	○	○	○	
CANbus interface	○	○	○	○	○	○
Six-pin/two-pin connector for conversions	○	○	○	○	○	○
Speed limiter – choice of three: 56mph (90km/h), 62mph (100km/h) or 68mph (110km/h)	○	○	○	○	○	○

## WHEELS AND TYRES

<b>Features</b>	Panel Van	Doublecab	Sportive Panel Van	Sportive Doublecab	Platform Cab	Combi
205/65 R 16 tyres	●	●	●	●	●	●
215/65 R 16 tyres (140PS models only)	●		●			●
16-inch steel wheels with centre covers	●	●			●	●
16-inch steel wheels with full-diameter wheel trims			●	●		□
17-inch five-spoke alloy wheels	○ <sup>15</sup>	○ <sup>15</sup>	○ <sup>15</sup>	○ <sup>15</sup>		○
All-season tyres (205/65 R 16 Goodyear Cargo Vector)	○	○	○	○	○	○
Full-size steel spare wheel	●	●	●	●	●	●
Tyre inflation kit in lieu of spare wheel	N/C	N/C	N/C	N/C	N/C	N/C

## TYRE RATINGS

Tyre size	Fuel efficiency group	Wet grip performance	External noise	
			Measured (dB)	Group
205/65 R 16	C	B	71	
215/65 R 16	C	B	70	
215/60 R 17	C	B	70	

Tyre rating according to EU Regulation 1222/2009

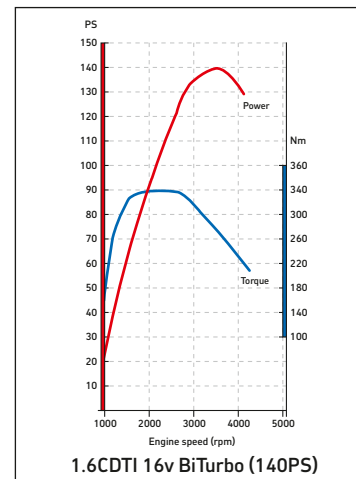
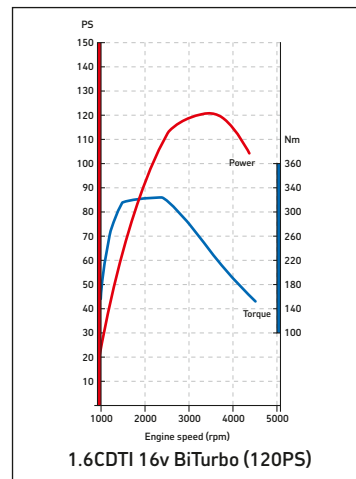
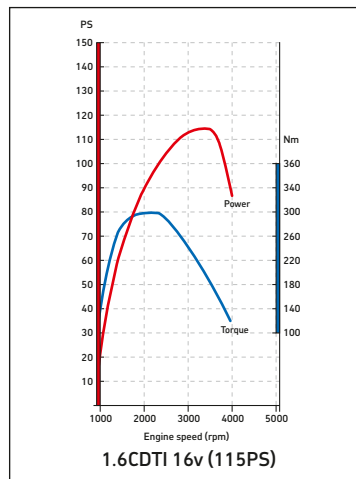
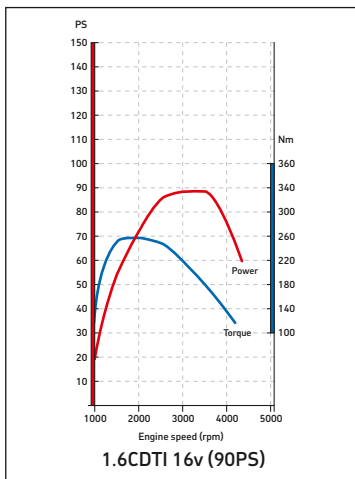

**DIESEL ENGINES**

	1.6CDTI 16v (90PS)	1.6CDTI 16v (90PS) Start/Stop ecoFLEX	1.6CDTI 16v (115PS)
Capacity	1598cc	1598cc	1598cc
Maximum power	90PS (66kW) @ 3500rpm	90PS (66kW) @ 3500rpm	115PS (84kW) @ 3500rpm
Maximum torque	260Nm (192 lb.ft.) @ 1500rpm	260Nm (192 lb.ft.) @ 1500rpm	300Nm (221 lb.ft.) @ 1750rpm
Configuration	4 cylinders, 4 valves per cylinder, double overhead camshafts		
Fuel/induction system	Variable geometry turbocharger with intercooler. Common rail fuel injection		
Emissions compliance	Euro 5		
Service interval	25,000 miles or two-years (whichever occurs sooner)		
	1.6CDTI 16v (120PS) BiTurbo Start/Stop ecoFLEX	1.6CDTI 16v (140PS) BiTurbo Start/Stop ecoFLEX	
Capacity	1598cc	1598cc	
Maximum power	120PS (88kW) @ 3500rpm	140PS (103kW) @ 3500rpm	
Maximum torque	320Nm (236 lb.ft.) @ 1500rpm	340Nm (250 lb.ft.) @ 1750rpm	
Configuration	4 cylinders, 4 valves per cylinder, double overhead camshafts		
Fuel/induction system	Twin variable geometry turbochargers with intercoolers. Common rail fuel injection		
Emissions compliance	Euro 5		
Service interval	25,000 miles or two-years (whichever occurs sooner)		



*New BiTurbo engines.*



*Six-speed manual gearbox.*



*Electronic Stability Programme (ESP-plus)*



*16-inch steel wheels with centre caps.*

## Vauxhall Assistance and warranties\*

Every New Vivaro comes with:

- A three-year vehicle warranty consisting of a one-year/unlimited mileage manufacturer's warranty and a second and third year manufacturer's warranty with a 100,000 miles limitation
- Vauxhall Assistance for 12 months from first registration
- Six years' body panel anti-perforation warranty

\* = Warranty is only available on vehicles sourced from General Motors UK Limited. Terms and conditions apply – please see your Vauxhall retailer for details.

## Transmission

- Front-wheel drive
- Six-speed manual

## Steering

- Hydraulic power-assisted rack and pinion system
- Energy-absorbing steering column
- Maximum turning circles (kerb-to-kerb):  
L1 – 11.8m (38.7ft.)  
L2 – 13.2m (43.3ft.)

## Suspension

### Front:

- Independent MacPherson strut with gas-pressure dampers

### Rear:

- Independent four-link, progressive-rate, mini-block springs with gas-pressure dampers

## Electronic stability

- Electronic Stability Programme (ESP-plus)
- Trailer stability programme (fitted when the optional tow bar is specified)
- Traction control

## Brakes

- Anti-lock Braking System (ABS) with electronic brakeforce distribution
- Hill start assist
- Emergency brake assist

### Front ventilated disc brakes:

296mm x 28mm

### Rear disc brakes:

280mm x 12mm

## Electrics

**Maintenance-free battery:** 80Ah

(Air conditioned models: 70Ah)

**Alternator:** 185A

(Air conditioned models: 150A)

## Body

- Aerodynamic drag co-efficient: Cd 0.352 (ecoFLEX models Cd 0.34)

## Fuel tank capacity

- 80 litres (17.0 gallons)

## Wheels and tyres

**Panel Van 90/115/120PS, Doublecab and Platform Cab models:**

205/65 R 16 tyres

**Panel Van 140PS and Combi models:**

215/65 R 16 tyres

- 16-inch steel wheels with centre caps

- 16-inch steel wheels with full-diameter wheel trims (Sportive models)

- Full-size spare wheel

- Anti-theft spare wheel cradle

**EXTERIOR DIMENSIONS** mm (inches)

Heights shown unladen.

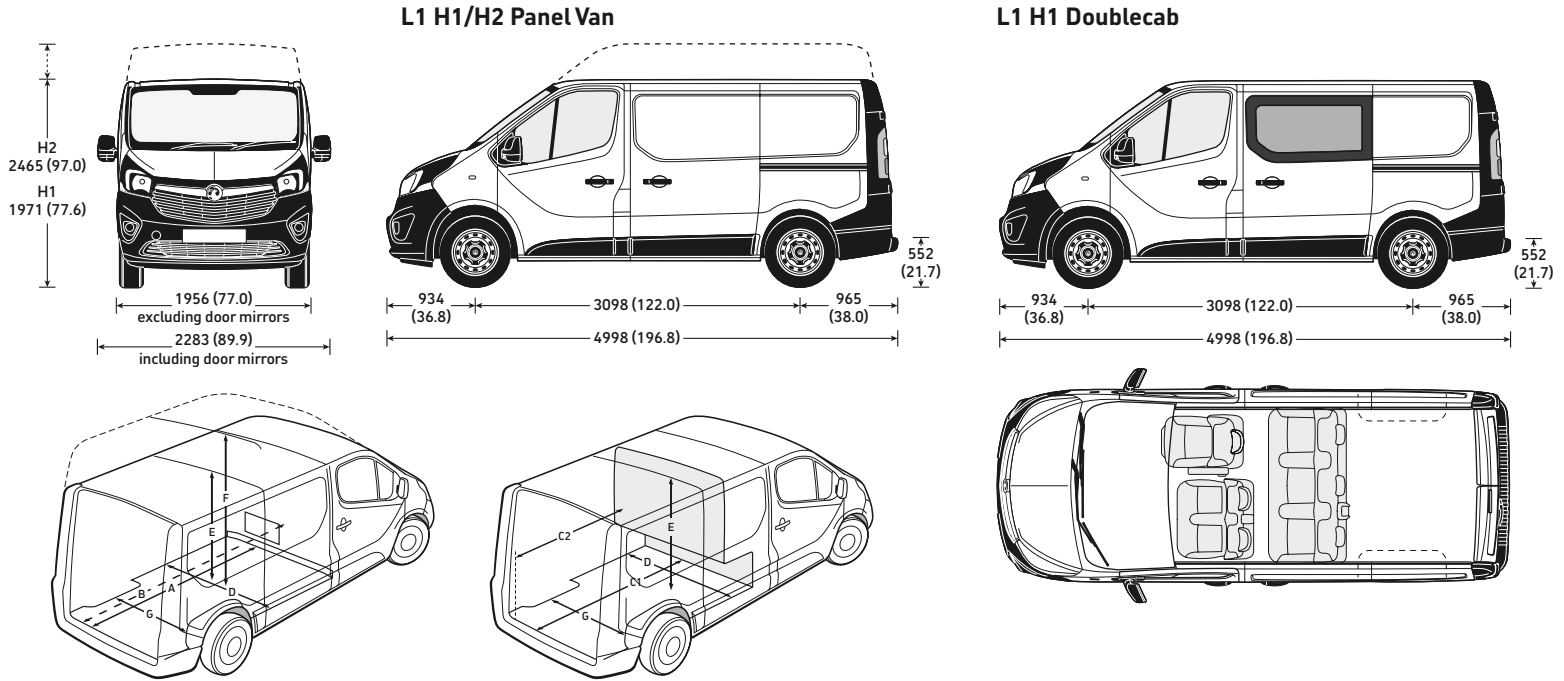

**INTERIOR DIMENSIONS** mm (inches)

Loadspace	L1
A Panel van maximum length at load floor	2537 (99.9)
B Panel van with load-through facility maximum length to seat*	2967 (116.8)
B Panel van with load-through facility maximum length to front footwell*	3750 (147.6)
C1 Doublecab maximum length at load floor	2023 (79.6)
C2 Doublecab maximum length behind rear seats	1340 (42.7)
D Maximum width	1662 (65.5)
E Maximum height – H1	1387 (54.6)
F Maximum height – H2	1898 (74.7)
G Width between wheel arches	1268 (49.9)

Side door(s)	L1
Aperture height	1284 (50.5)
Aperture width	1030 (40.5)
<b>Rear doors</b>	
Aperture height – H1	1320 (52.0)
Aperture height – H2	1820 (71.6)
Aperture width (at floor)	1391 (54.8)
Loading height	552 (21.7)

**LOADSPACE VOLUMES** VDA method cu.m (cu.ft.)

H1 Panel Van	5.2 (183.6)	H2 Panel Van	7.2 (254.3)	H1 Doublecab	3.2 (113.0)
--------------	-------------	--------------	-------------	--------------	-------------

\* = Approximate. Front passenger outer seat cannot be used when the FlexCargo load-through facility to footwell is in operation.

**WEIGHTS AND TOWING DATA\***

Model	Plated weights and kerbweights kg				Payload kg	Towing weights Trailer with brakes (without brakes) kg	Plated Gross Combination Weights (GCW) kg
	Front axle	Rear axle	Total				
	Plated	Plated	GVW	Kerb			
<b>L1 H1 Panel Van</b>							
2700 1.6CDTI 16v (90/115PS)	1585	1650	2740	1661	1079	2000 (750)	4740
2700 1.6CDTI 16v (120PS) BiTurbo Start/Stop ecoFLEX	1585	1650	2760	1680	1080	2000 (750)	4760
2900 1.6CDTI 16v (90/115PS)	1585	1650	2900	1661	1239	2000 (750)	4900
2900 1.6CDTI 16v (120/140PS) BiTurbo Start/Stop ecoFLEX	1585	1650	2920	1680	1240	2000 (750)	4920
<b>L1 H2 Panel Van</b>							
2900 1.6CDTI 16v (120PS) BiTurbo Start/Stop ecoFLEX	1585	1650	2920	1760	1160	2000 (750)	4920
<b>L1 H1 Doublecab</b>							
2900 1.6CDTI 16v (90/115PS)	1585	1650	2810	1805	1005	2000 (750)	4810
2900 1.6CDTI 16v (120/140PS) BiTurbo Start/Stop ecoFLEX	1585	1650	2830	1823	1007	2000 (750)	4830

**Note:** Kerbweights for standard vehicles include coolant, oil, 90% full fuel tank and spare wheel. They will vary according to the vehicle specification (including options and accessories) with a corresponding variation in payload. **Payload** figures do not allow for the weight of the driver, or any passengers, which should therefore be deducted from the figures shown. **Gross plated weights** (including axle weights) quoted on the vehicle plate are to UK plated weight specification and must never be exceeded. **Roof load** should not exceed 200kg including the weight of the roof rack/carrier. **Sportive models:** Kerbweights are increased by 45kg on Sportive Panel van and 55kg on Sportive Doublecab models with a corresponding decrease in payload. \* = Provisional data.

**FUEL ECONOMY AND EMISSIONS**

	Fuel economy mpg (litres/100km)#			CO <sub>2</sub> (g/km)#
	Urban driving	Extra-urban driving	Combined figure	
<b>L1 H1 Panel Van</b>				
2700 1.6CDTI 16v (90/115PS)	36.2 (7.8)	49.5 (5.7)	43.5 (6.5)	170
2700 1.6CDTI 16v (90PS) Start/Stop ecoFLEX	39.8 (7.1)	51.4 (5.5)	46.3 (6.1)	160
2700 1.6CDTI 16v (120PS) BiTurbo Start/Stop ecoFLEX	42.8 (6.6)	51.4 (5.5)	47.9 (5.9)	155
2900 1.6CDTI 16v (90/115PS)	36.2 (7.8)	49.5 (5.7)	43.5 (6.5)	170
2900 1.6CDTI 16v (90PS) Start/Stop ecoFLEX	39.8 (7.1)	51.4 (5.5)	46.3 (6.1)	160
2900 1.6CDTI 16v (120PS) BiTurbo Start/Stop ecoFLEX	42.8 (6.6)	51.4 (5.5)	47.9 (5.9)	155
2900 1.6CDTI 16v (140PS) BiTurbo Start/Stop ecoFLEX	40.3 (7.0)	50.4 (5.6)	46.3 (6.1)	160
<b>L1 H2 Panel Van</b>				
2900 1.6CDTI 16v (120PS) BiTurbo Start/Stop ecoFLEX	34.9 (8.1)	44.1 (6.4)	40.3 (7.0)	185
<b>L1 H1 Doublecab</b>				
2900 1.6CDTI 16v (90/115PS)	36.2 (7.8)	49.5 (5.7)	43.5 (6.5)	170
2900 1.6CDTI 16v (90PS) Start/Stop ecoFLEX	39.8 (7.1)	51.4 (5.5)	46.3 (6.1)	160
2900 1.6CDTI 16v (120PS) BiTurbo Start/Stop ecoFLEX	42.8 (6.6)	51.4 (5.5)	47.9 (5.9)	155
2900 1.6CDTI 16v (140PS) BiTurbo Start/Stop ecoFLEX	40.3 (7.0)	50.4 (5.6)	46.3 (6.1)	160

# = Official Government Test Environmental Data. Official EU-regulated test data is provided for comparison purposes and actual performance will depend on driving style, road conditions and other non-technical factors.

**EXTERIOR DIMENSIONS** mm (inches)

Heights shown unladen.

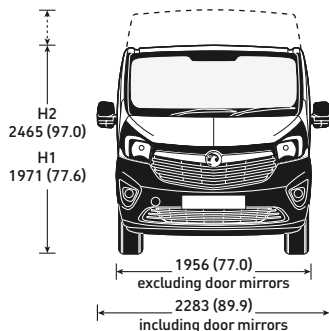

**L2 H1/H2 Panel Van**

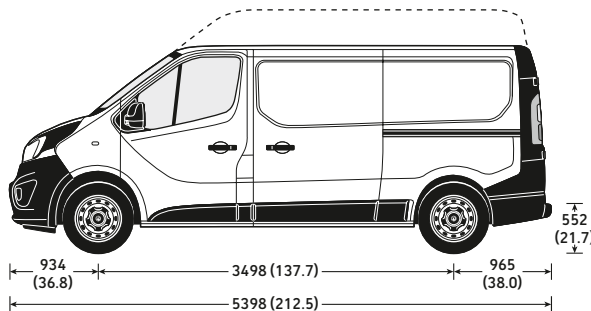

**L2 H1 Doublecab**

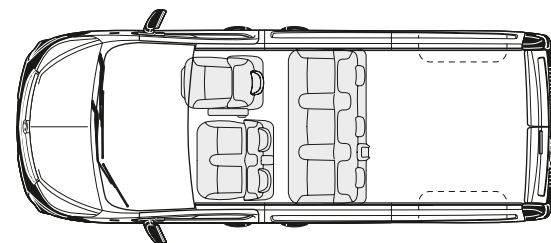
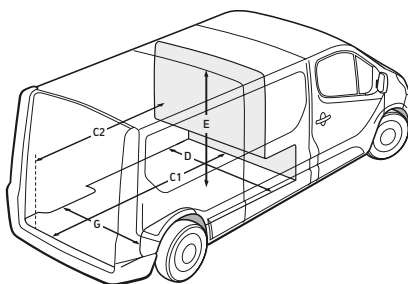
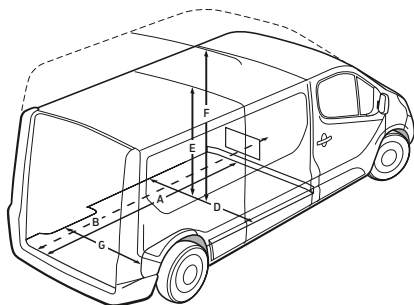
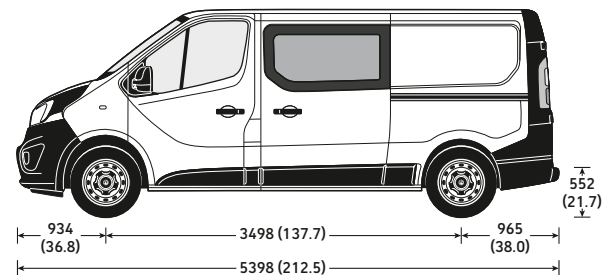

**INTERIOR DIMENSIONS** mm (inches)

Loadspace	L2
A Panel van maximum length at load floor	2937 (115.6)
B Panel van with load-through facility maximum length to seat*	3367 (132.5)
B Panel van with load-through facility maximum length to front footwell*	4150 (163.4)
C1 Doublecab maximum length at load floor	2423 (95.4)
C2 Doublecab maximum length behind rear seats	1740 (68.5)
D Maximum width	1662 (65.5)
E Maximum height – H1	1387 (54.6)
F Maximum height – H2	1898 (74.7)
G Width between wheel arches	1268 (49.9)

Side door(s)	L2
Aperture height	1284 (50.5)
Aperture width	1030 (40.5)
<b>Rear doors</b>	
Aperture height – H1	1320 (52.0)
Aperture height – H2	1820 (71.6)
Aperture width (at floor)	1391 (54.8)
Loading height	552 (21.7)

**LOADSPACE VOLUMES** VDA method cu.m (cu.ft.)

H1 Panel Van	6.0 (211.9)	H2 Panel Van	8.6 (303.7)	H1 Doublecab	4.0 (141.3)
--------------	-------------	--------------	-------------	--------------	-------------

\* = Approximate. Front passenger outer seat cannot be used when the FlexCargo load-through facility to footwell is in operation.

## WEIGHTS AND TOWING DATA\*

Model	Plated weights and kerbweights kg				Payload kg	Towing weights Trailer with brakes (without brakes) kg	Plated Gross Combination Weights (GCW) kg
	Front axle Plated	Rear axle Plated	Total GVW	Kerb			
<b>L2 H1 Panel Van</b>							
2900 1.6CDTI 16v (90/115PS)	1585	1650	2990	1710	1280	2000 (750)	4990
2900 1.6CDTI 16v (90PS) Start/Stop ecoFLEX	1585	1650	2990	1710	1280	2000 (750)	4990
2900 1.6CDTI 16v (120/140PS) BiTurbo Start/Stop ecoFLEX	1585	1650	3010	1729	1281	2000 (750)	5010
<b>L2 H2 Panel Van</b>							
2900 1.6CDTI 16v (120PS) BiTurbo Start/Stop ecoFLEX	1585	1650	3020	1820	1200	2000 (750)	5020
<b>L2 H1 Doublecab</b>							
2900 1.6CDTI 16v (90/115PS)	1585	1650	2920	1860	1060	2000 (750)	4920
2900 1.6CDTI 16v (120/140PS) BiTurbo Start/Stop ecoFLEX	1585	1650	2940	1879	1061	2000 (750)	4940

**Note:** Kerbweights for standard vehicles include coolant, oil, 90% full fuel tank and spare wheel. They will vary according to the vehicle specification (including options and accessories) with a corresponding variation in payload. **Payload** figures do not allow for the weight of the driver, or any passengers, which should therefore be deducted from the figures shown. **Gross plated weights** (including axle weights) quoted on the vehicle plate are to UK plated weight specification and must never be exceeded. **Roof load** should not exceed 200kg including the weight of the roof rack/carrier. **Sportive models:** Kerbweights are increased by 45kg on Sportive Panel van and 55kg on Sportive Doublecab models with a corresponding decrease in payload. \* = Provisional data.

## FUEL ECONOMY AND EMISSIONS

	Fuel economy mpg (litres/100km)#			CO <sub>2</sub> (g/km)#
	Urban driving	Extra-urban driving	Combined figure	
<b>L2 H1 Panel Van</b>				
2900 1.6CDTI 16v (90/115PS)	36.2 (7.8)	49.5 (5.7)	43.5 (6.5)	170
2900 1.6CDTI 16v (90PS) Start/Stop ecoFLEX	39.8 (7.1)	51.4 (5.5)	46.3 (6.1)	160
2900 1.6CDTI 16v (120PS) BiTurbo Start/Stop ecoFLEX	42.8 (6.6)	51.4 (5.5)	47.9 (5.9)	155
2900 1.6CDTI 16v (140PS) BiTurbo Start/Stop ecoFLEX	40.3 (7.0)	50.4 (5.6)	46.3 (6.1)	160
<b>L2 H2 Panel Van</b>				
2900 1.6CDTI 16v (120PS) BiTurbo Start/Stop ecoFLEX	34.9 (8.1)	44.1 (6.4)	40.3 (7.0)	185
<b>L2 H1 Doublecab</b>				
2900 1.6CDTI 16v (90/115PS)	35.8 (7.9)	47.9 (5.9)	42.8 (6.6)	174
2900 1.6CDTI 16v (90PS) Start/Stop ecoFLEX	39.2 (7.2)	49.5 (5.7)	45.6 (6.2)	164
2900 1.6CDTI 16v (120PS) BiTurbo Start/Stop ecoFLEX	42.8 (6.6)	49.5 (5.7)	46.3 (6.1)	160
2900 1.6CDTI 16v (140PS) BiTurbo Start/Stop ecoFLEX	39.2 (7.2)	49.5 (5.7)	45.6 (6.2)	164

# = Official Government Test Environmental Data. Official EU-regulated test data is provided for comparison purposes and actual performance will depend on driving style, road conditions and other non-technical factors.

**EXTERIOR DIMENSIONS** mm (inches)

Heights shown unladen.

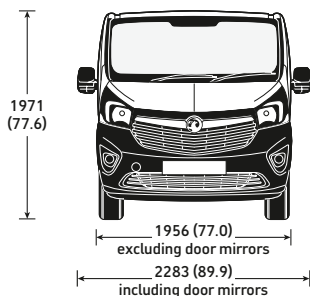

**L1 Combi 9-seat**

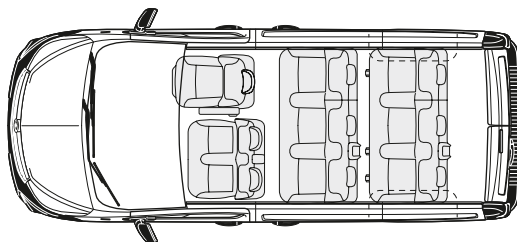
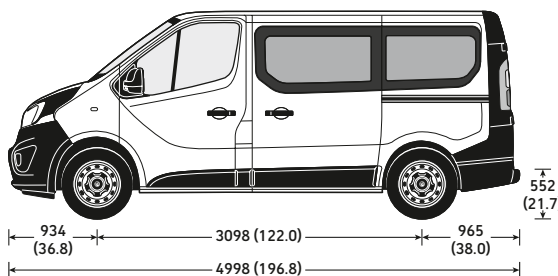

**L2 Combi 9-seat**

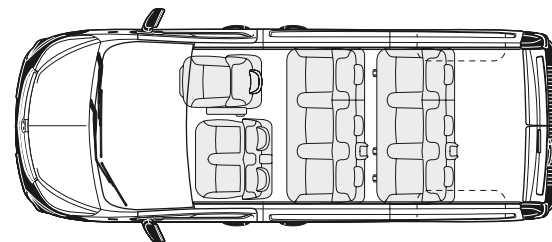
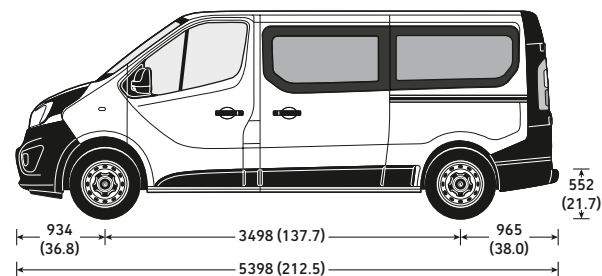

**INTERIOR DIMENSIONS** mm (inches)

Loadspace	L1	L2
Maximum length behind rear seats	736 (30.0)	1136 (44.7)
Maximum width	1662 (65.5)	1662 (65.5)
Maximum height	1369 (53.9)	1369 (53.9)
Width between wheel arches	1268 (49.9)	1268 (49.9)
<b>Side doors</b>		
Aperture height	1284 (50.5)	1284 (50.5)
Aperture width	1030 (40.5)	1030 (40.5)
<b>Rear doors</b>		
Aperture height	1320 (52.0)	1320 (52.0)
Aperture width (at floor)	1391 (54.8)	1391 (54.8)
Loading height – standard roof	552 (21.7)	552 (21.7)

**LOADSPACE VOLUMES** cu.m (cu.ft.)

	L1	L2
Combi	1.0 (35.3)	1.8 (63.6)
Combi – third-row seats folded and stowed	2.1 (74.2)	2.9 (102.4)
Combi – third-row seats removed	3.2 (113.0)	4.0 (141.3)



## WEIGHTS AND TOWING DATA\*

Model	Plated weights and kerbweights kg				Payload kg	Towing weights Trailer with brakes (without brakes) kg	Plated Gross Combination Weights (GCW) kg
	Front axle Plated	Rear axle Plated	Total GVW	Kerb			
<b>L1 H1 Combi 9-seat</b>							
2900 1.6CDTI 16v (90/115PS)	1585	1650	2740	1901	839	2000 (750)	4740
2900 1.6CDTI 16v (120/140PS) BiTurbo Start/Stop ecoFLEX	1585	1650	2800	1901	899	2000 (750)	4800
<b>L2 H1 Combi 9-seat</b>							
2900 1.6CDTI 16v (90/115PS)	1585	1650	2845	1901	944	2000 (750)	4845
2900 1.6CDTI 16v (120PS) BiTurbo Start/Stop ecoFLEX	1585	1650	2895	1901	994	2000 (750)	4895

**Please note:** Kerbweights for standard vehicles include coolant, oil, 90% full fuel tank and spare wheel (where applicable). They will vary according to the vehicle specification (including options and accessories) with a corresponding variation in payload. **Gross plated weights** (including axle weights) quoted on the vehicle plate must never be exceeded. **Roof load** maximum 200kg (includes weight of roof carrier) when Vauxhall approved carrier system used.

**Towing weights** (where applicable) should not exceed 750kg (unbraked trailer) or 2000kg (braked trailer). \* = Provisional data.

## FUEL ECONOMY AND EMISSIONS

	Fuel economy mpg (litres/100km)#			
	Urban driving	Extra-urban driving	Combined figure	CO <sub>2</sub> (g/km)#
<b>L1 H1 Combi</b>				
2900 1.6CDTI 16v (90/115PS)	35.8 (7.9)	47.9 (5.9)	42.8 (6.6)	174
2900 1.6CDTI 16v (90PS) Start/Stop ecoFLEX	39.2 (7.2)	49.5 (5.7)	45.6 (6.2)	164
2900 1.6CDTI 16v (120PS) BiTurbo Start/Stop ecoFLEX	41.5 (6.8)	49.5 (5.7)	46.3 (6.1)	160
<b>L2 H1 Combi</b>				
2900 1.6CDTI 16v (90/115PS)	35.8 (7.9)	47.9 (5.9)	42.8 (6.6)	174
2900 1.6CDTI 16v (90PS) Start/Stop ecoFLEX	39.2 (7.2)	49.5 (5.7)	45.6 (6.2)	164
2900 1.6CDTI 16v (120PS) BiTurbo Start/Stop ecoFLEX	41.5 (6.8)	49.5 (5.7)	46.3 (6.1)	160

# = Official Government Test Environmental Data. Official EU-regulated test data is provided for comparison purposes and actual performance will depend on driving style, road conditions and other non-technical factors.

## FOLDING THIRD-ROW SEAT

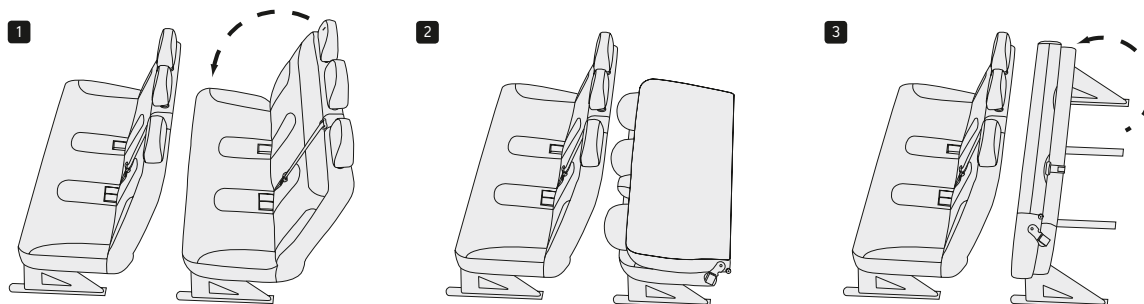

Combi's 'stow and fold' third-row seats (1-3) convert the 9-seat Combi into a six seater with additional luggage space, without having to remove any seats from the vehicle.

**EXTERIOR DIMENSIONS** mm (inches)

Heights shown unladen.

**L2 H1 Platform Cab**

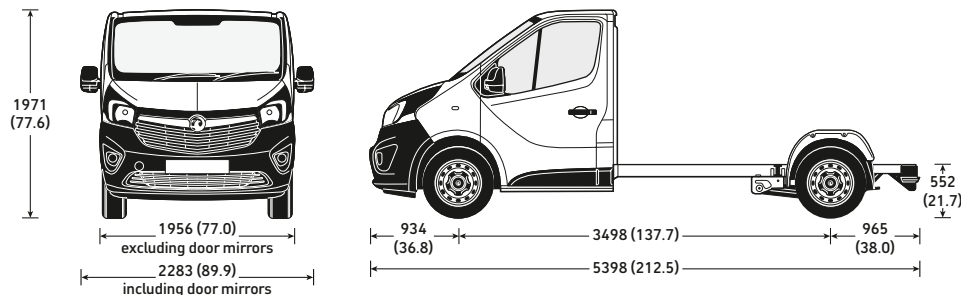

**Platform cabs**

Platform cabs are ideal for those conversions requiring a low floor and walk-through access from the cab. The interface panel makes for easy integration of the cab with the conversion body, while an extended-length wiring loom is available to power the rear lights or extended conversions.

All conversions must follow 'Conversion Requirements' guidelines available on: [www.vauxhall.co.uk/conversiondata](http://www.vauxhall.co.uk/conversiondata)

**FUEL ECONOMY AND EMISSIONS\***

	Fuel economy mpg (litres/100km)#			CO <sub>2</sub> (g/km)#
	Urban driving	Extra-urban driving	Combined figure	
<b>L2 H1 Platform Cab</b>				
2900 1.6CDTI 16v (115PS)	36.2 (7.8)	49.5 (5.7)	43.5 (6.5)	170
2900 1.6CDTI 16v (120/140PS) BiTurbo Start/Stop ecoFLEX	34.9 (8.1)	44.1 (6.4)	40.3 (7.0)	185

\* = Provisional data.

# = Official Government Test Environmental Data. Official EU-regulated test data is provided for comparison purposes and actual performance will depend on driving style, road conditions and other non-technical factors.

### Plated weight

The maximum weight to which a vehicle or an axle may be loaded, determined either by the design of the components or by legislation. All commercial vehicles must carry a manufacturer's 'plate' showing the vehicle and axle gross 'plated weights'. It is an offence to drive a vehicle in a condition where any of these weights are exceeded.

### Kerbweight

The weight of the complete vehicle in standard form, excluding payload and driver but including coolant, oil, 90% full fuel tank and spare wheel where appropriate. Kerbweights quoted in Vauxhall brochures are subject to manufacturing tolerances and to the fitment of optional equipment and accessories. Where load capacity is critical the actual kerbweight should be obtained by weighing the vehicle on a calibrated public weighbridge.

### Gross Vehicle Weight (GVW)

The total permissible weight of a vehicle including payload and passengers, as shown on the manufacturer's plate.

### Gross Combination Weight (GCW)

The maximum permissible weight of a vehicle, including payload and passengers, combined with the total weight of any trailer it is towing. The maximum GCW weight limit is quoted on the vehicle plate and must not be exceeded.

### Payload

The total permissible weight that can be carried without exceeding the vehicle's plated weight. This can be obtained by deducting the kerbweight from the plated GVW.

**Please note:** the payload figure does not allow for the weight of the driver or any passengers which should therefore be deducted from the figures shown and are also subject to correct weight distribution.

### Maximum towing weight

The maximum weight of any trailer and its load which may be towed within the limit of the vehicle's plated GCW. It is based on the ability of the vehicle – at full GCW – to restart on a 12% gradient, which is approximately 1 in 8.3, at sea level. At altitudes above 1500 metres, the engine output may drop with a corresponding reduction in towing capability. It is the operator's responsibility to ensure that the trailer noseweight does not cause the rear axle plated weight of the towing vehicle to be exceeded.

*Always fit Vauxhall towing attachments and accessories available from your Vauxhall Commercial Vehicle retailer. They are designed specifically for Vauxhall models and carry a 12-month warranty.*

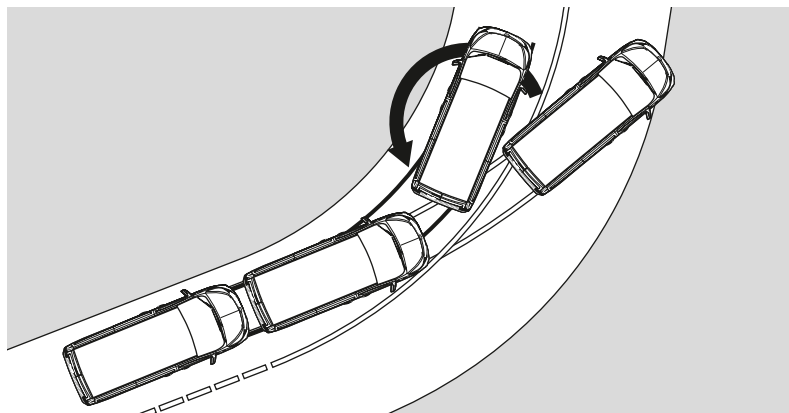

### Electronic Stability Programme-plus (ESP-plus)

New Vivaro's ESP-plus, incorporating traction control and hill start assist, goes one step further than the system usually found on Vauxhall's passenger cars. In understeer situations, the system automatically applies corrective braking to the appropriate rear wheel to correct the tendency; in oversteer situations, it automatically applies the brake to the appropriate front wheel. Because a commercial vehicle is also faced with significant weight and load issues which can influence this tendency to understeer or oversteer by affecting the centre of gravity, New Vivaro's ESP system also incorporates a load sensor that adjusts the intensity of the braking effort to suit the demands of the payload.

# Trust Vauxhall

## Protecting the environment

Vauxhall's commitment to the environment is demonstrated by our products' many environmental awards, won both through the use of more recycled materials and by becoming cleaner and more efficient. For information on Vauxhall's efforts to achieve an environmentally sustainable future, see [www.vauxhall.co.uk/recycling](http://www.vauxhall.co.uk/recycling)

## Fleet Customer Services

Our dedicated support services for fleet managers include factory demonstrators and information on whole life costs, company car and van taxation and finance. For further information please call **0870 010 0651**.

## Vauxhall Extended Warranty

For complete peace of mind Vauxhall offers an extended warranty that can be purchased on an annual basis following the expiry of the original new vehicle warranty. It covers most mechanical and electrical components. Terms and conditions apply. For further details please contact your local Vauxhall Commercial Vehicle retailer.



When you have finished with this brochure please recycle it

## Business Lease

Business Lease, from GMAC, offers the versatility of a purchase-based finance plan, while making the most efficient use of tax and cash-flow benefits for VAT-registered business users. It's available for all Vauxhall Commercial Vehicles up to 12 months old and offers highly flexible term lengths, variable deposits and a choice of payment profiles. Ask your retailer for full details.

## Business First

Available to business users only, Business First enables you to drive a new vehicle without a large, initial financial outlay. You pay to use the vehicle, not to own it. The vehicle is provided over a predetermined period, and when that period comes to an end the vehicle is returned. Ask your retailer for full details.

## Servicing and maintenance

The best way to maximise the performance and reliability of your Vauxhall is to have all routine servicing and maintenance carried out at a Vauxhall Commercial Vehicle retailer. Nationwide there are over 250 light commercial vehicle retailers and a further 195 heavy commercial vehicle retailers.

## In the event of an accident...

Vauxhall Accident Support helps keep you mobile following an accident. Benefits include scene-of-accident advice, message service, assistance with claims and vehicle recovery. For further details call **0800 010 304**.

## Premier Van Centres

Our 100-strong network offers convenience, expertise and value. Enjoy while-you-wait repairs (if the parts are in stock), appointment-free service for diagnosis and transparent pricing. What's more, our Vauxhall-trained technicians will use genuine Vauxhall parts.

## For more information...

For a brochure on any Vauxhall model (up to a maximum of three per caller) or location of your nearest retailer, call **0845 600 1500**.

Alternatively, details can be found on our website at: [www.vauxhall.co.uk/vans](http://www.vauxhall.co.uk/vans)

Proud Sponsor of Home Nations Football



Every effort has been made to ensure that the contents of this publication were accurate and up-to-date at the time of going to press (August 2014). Vauxhall vehicles are equipped with components manufactured by various General Motors operating units and outside suppliers. The Company reserves the right to alter specifications and withdraw products from sale without notice. Any such alterations will be notified to Vauxhall retailers at the earliest opportunity. Please consult your local retailer for the latest information. The specifications detailed within this brochure are not necessarily applicable to alternative models such as Special Editions. Details of any such models will be contained in specific literature or found on the Vauxhall website. Please note that Vauxhall retailers are not the agents of General Motors UK Limited and are not authorised to bind the Company by any specific or implied undertaking or representation. It is advisable to ensure that your motor insurance policy provides adequate cover for additional fitted options and accessories. Please note accessories shown are for illustrative purposes only. As part of Vauxhall's policy of environmental care, this brochure is printed on paper manufactured using Elemental Chlorine Free pulps from specially farmed, sustainable timber resources. All rights reserved. No part of this publication may be reproduced in any form or by any means, without the prior written permission of General Motors UK Limited.

VM1400019

©2014 General Motors UK Limited

Published September 2014

General Motors UK Limited, Luton LU1 3YT

**COMMERCIAL VEHICLES**  
*The Wheels of Business*



**VAUXHALL**