

Safety **MG** *fast!*

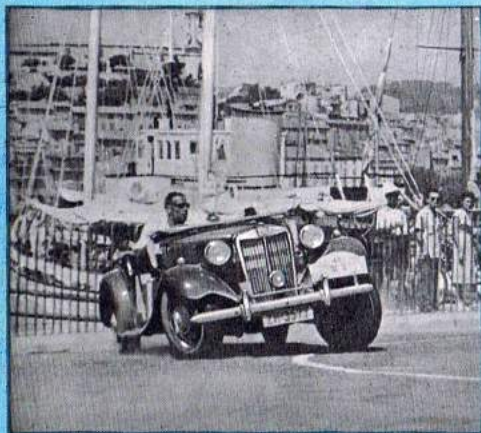



Safety **MG** *Just!*

*America... Switzerland...
Britain... Australia...
the world acclaim
this "TD" Midget*

as the best ever 

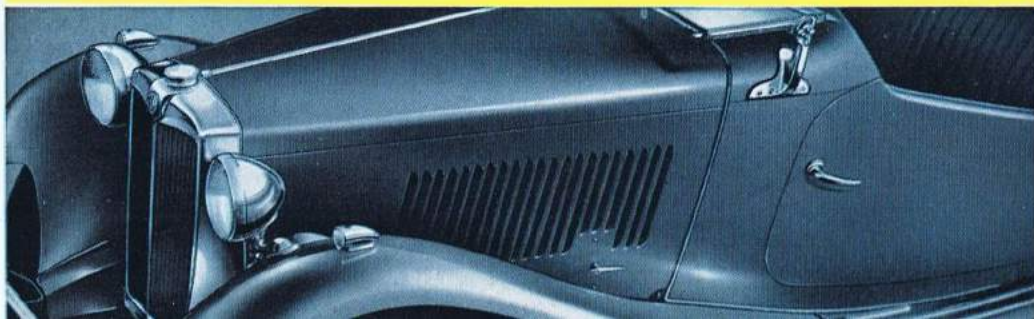

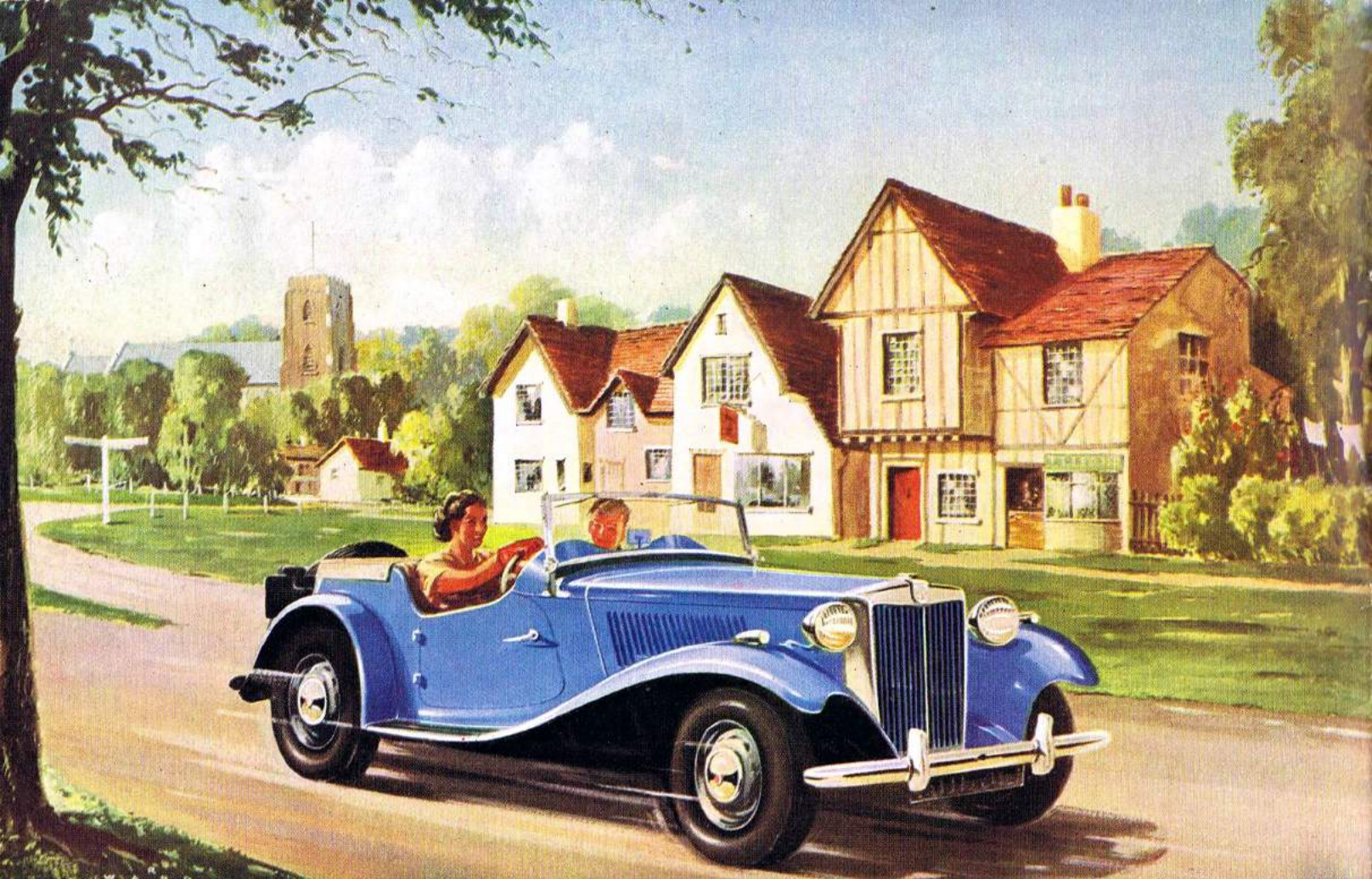

The one car *you've always wanted to drive*

Sit in the driving seat. The wheel fits comfortably into your lap and you're at ease and ready for the most exhilarating drive you've ever had.

Find a fast road and you're up to "fast cruising" in no time at all — with power to spare for more. Overtaking's easy! This car gets you past in "safety-fast." Here comes a corner and round you go with hardly a roll and much faster than you thought.

This road surface doesn't look so good, but you don't feel it, neither does your passenger. The independent front suspension has smoothed all that away. Driving in traffic's a joy too! Away first at traffic lights and you're out in front to stay.

And when you return refreshed — see your dealer about owning the "one car you've always wanted to drive."



Midget Series 'T.D.



Left- or right-hand drive available
according to markets.

Enjoy the sun . . . and the fun



WHEN THE WEATHER'S RIGHT drive with the screen flat. Two wing nuts hold the safety glass screen firmly flat to the scuttle.

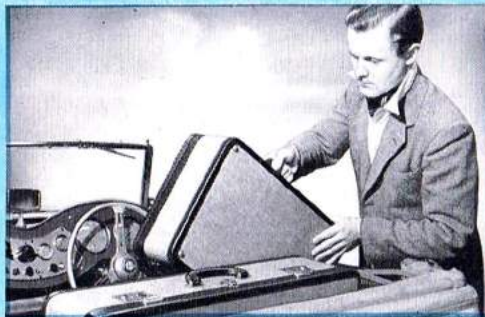

LUGGAGE FOR TWO is easily stowed in the special compartment behind the seats. Spare wheel is fitted at the rear.



ONE FILL of the fuel tank takes you more than 350 miles. The "snap on" filler tank cap is a special M.G. feature.

Safety **MG** *fast!*

Left- or right-hand drive available according to markets.

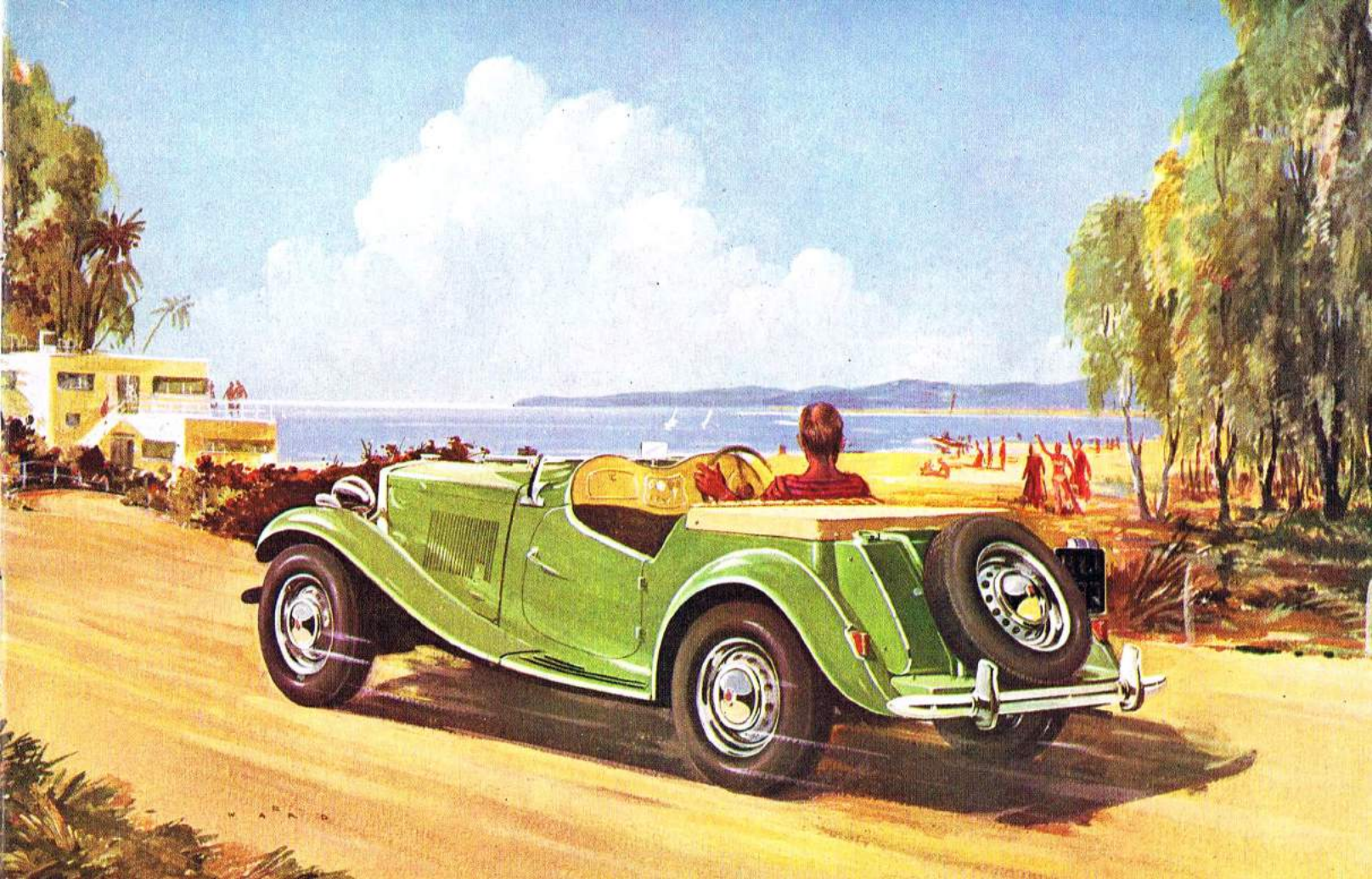



Goes like a flash...grips the road like a limpet

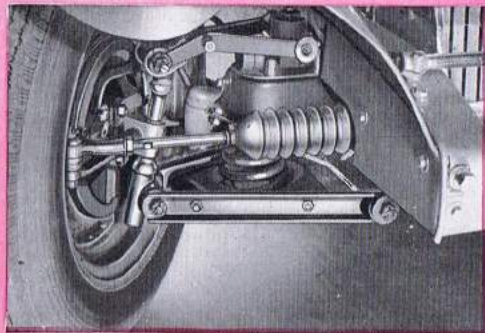

CORNER FAST IN SAFETY with the M.G. independent coil spring front suspension. It gives a smooth ride and superlative road-holding.

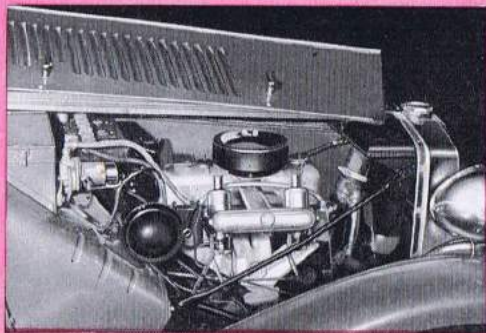

YOU GET PERFORMANCE plus economy with the high efficiency O H.V. 1,250 c.c. engine. Twin SU carburetters add punch to performance.



SPORTS CAR STYLE FACIA panel includes a 5 in. speedometer and a 5 in. "rev." counter. Steering column is adjustable for individual reach.

Left- or right-hand drive available according to markets.

Safety  *Just!*



The story of

The first M.G. was built in 1923. It differed from anything then available *because it was designed by enthusiasts for enthusiasts* and was accordingly an immediate success.

In 1929 the first of the long line of M.G. MIDGETS was designed — the M. type, the first car with a sporting appeal at a price many could afford.

A succession of MIDGETS followed, the D., the J., the P.A. and P.B. ; each an improvement on the last. These M.G.s won International races, hill climbs, stiff reliability trials and took premier awards in rallies.

1936 saw an entirely new type of MIDGET — the T.A. with an engine more powerful than its predecessors. Then followed the types T.B. and T.C. which added fresh lustre to the marque M.G. and to-day there is hardly a cup, prize or trophy that an M.G. has not carried off — not only in England but all over the world. Thus the latest T.D. MIDGET is the result of logical development ; it retains all the proved features of its forbears and incorporates unobtrusively but effectively much of the knowledge and experience gained from successful racing on road and track — plus many improvements which make it the *finest Midget ever*, giving a new significance to the words “Safety Fast.”



*Left- or right-hand drive available
according to markets.*



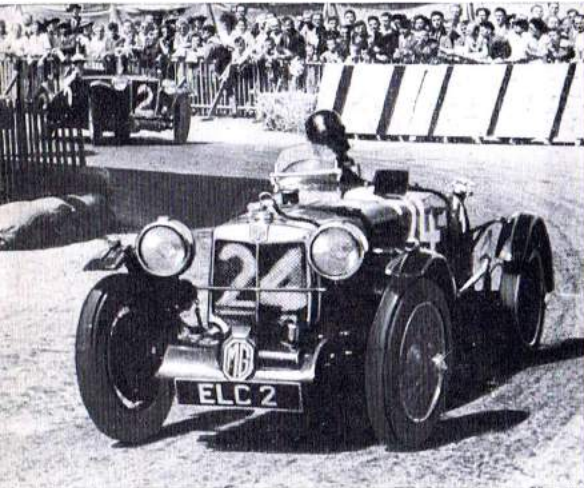





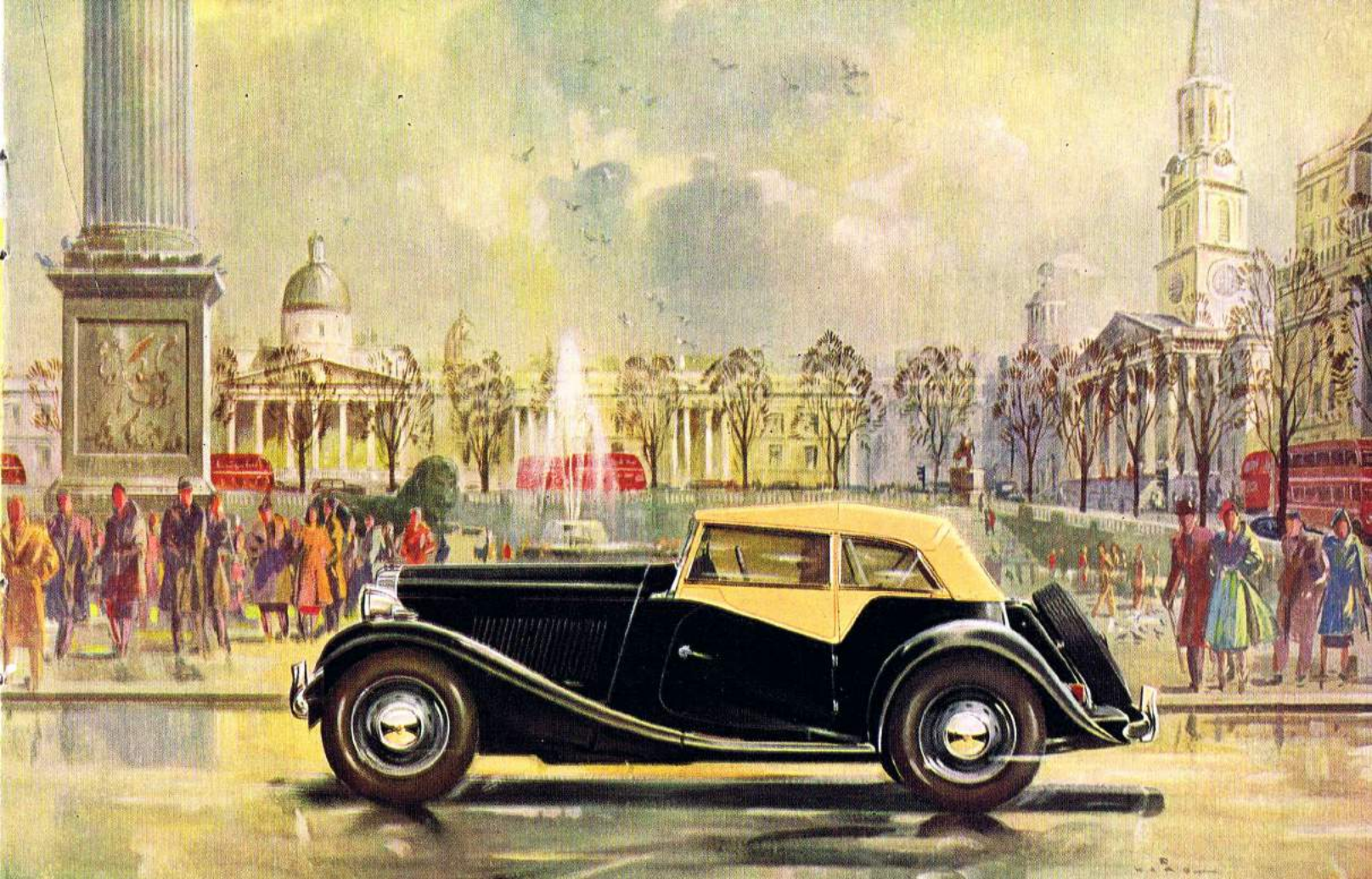



SOME SPORTS SUCCESSES



- AUSTRALIA.** N.S.W. Grand Prix, 1946. 1st, 2nd, 3rd.
 N.S.W. (under 1,500 c.c.), 25 miles Handicap. 1st, 2nd, 3rd.
NORWAY. Scandinavian Grand Prix, 1947 (1,500 c.c. class). 1st, 3rd.
GERMANY. Schottenring Race, 1947. 1st.
AUSTRALIA. N.S.W. Grand Prix, 1947. 1st, 2nd, 3rd, 4th.
 N.S.W. (under 1,500 c.c.) Championship Race, 1947. 1st, 2nd, 3rd.
IRELAND. Eire Road Race, 1948. 1st, 2nd, 3rd, 4th, 5th.
HOLLAND. Zeeland Speed Trials, 1948. 1st.
AUSTRALIA. N.S.W. 100 miles Grand Prix, 1948. 1st, 3rd, 4th, 5th, 6th, 7th.
SWITZERLAND. Maloja Hill Climb, 1948.
 Sports car class (up to 1,100 c.c. — Amateur). 1st.
 (1,100 — 1,500 c.c. — Amateur). 1st, 2nd, 3rd, 4th, 5th.
 (1,100 — 1,500 c.c. — Experts). 1st, 3rd, 5th.
BRAZIL. Tijuca Hill Climb, Rio de Janeiro, 1948. 1st (in record time).
U.S.A. Bridgehampton, Long Island, New York. Sports Meeting, 1949.
 1st, 3rd, 4th.
DENMARK. Scandinavian Race, Copenhagen (1½ litre class). 1st.
AUSTRALIA. Australian Grand Prix, 1949. 2nd, 3rd, 4th.
CEYLON. Ceylon Grand Prix. 1st.
AUSTRALIA. Great Southern 50 mile Road Race, 1949. 1st.
 South Australian Grand Prix (1,500 c.c. class). 1st, 2nd, 3rd.
KENYA. 1,500 c.c. Race, 1950. 1st.
AUSTRIA. Lower Austrian Voralpen Race, 1950. Best time and gold plaque.
ENGLAND. Prescott Hill Climb, 1950 (1,500 c.c. class). 1st, 2nd.
ENGLAND. Brighton Speed Trials, 1950 (1,100 c.c. class). 2nd. (1,100–1,500 c.c. class). 3rd.
AUSTRALIA. Leyburn Formula Race, Queensland, 1950. 2nd, 3rd, 4th.
SWITZERLAND. International Alpine Rally, 1950 (1,100–1,500 c.c. class). 1st, 2nd, 6th, 7th, 9th, 10th, 13th, and Foreign Team prize.
ENGLAND. Silverstone Production Car Race, 1950 (up to 1,500 c.c.). 2nd, 3rd, 4th.
HOLLAND. National Sports Car Races, 1950. 1st, 2nd, 3rd, 4th (in class).
IRELAND. Ulster T.T., 1950 (1,500 c.c. class). 1st, 2nd, 3rd.
SOUTH AMERICA. Quito to Caracas International Automobile Race, 1950. Only European car to finish.

Left- or right-hand drive available according to markets.



-  Overhead valve 1,250 c.c. engine developing 54 brake horse-power.
-  Twin SU semi-downdraught carburettors with oil-bath air cleaner.
-  Semi-floating rear axle with hypoid gears.
-  Direct acting rack and pinion steering.
-  Facia covered in leathercloth with separate speedometer and revolution counter.
-  Disc type wheels with 5.50 — 15 tyres.
-  Lockheed hydraulic brakes with large area drums.
-  Coil spring independent front suspension.
-  Piston-type hydraulic shock absorbers.
-  Full-width bumpers and over-riders.
-  Twin stop and tail lights.
-  Twin wind-tone horns.
-  Glove box in facia.



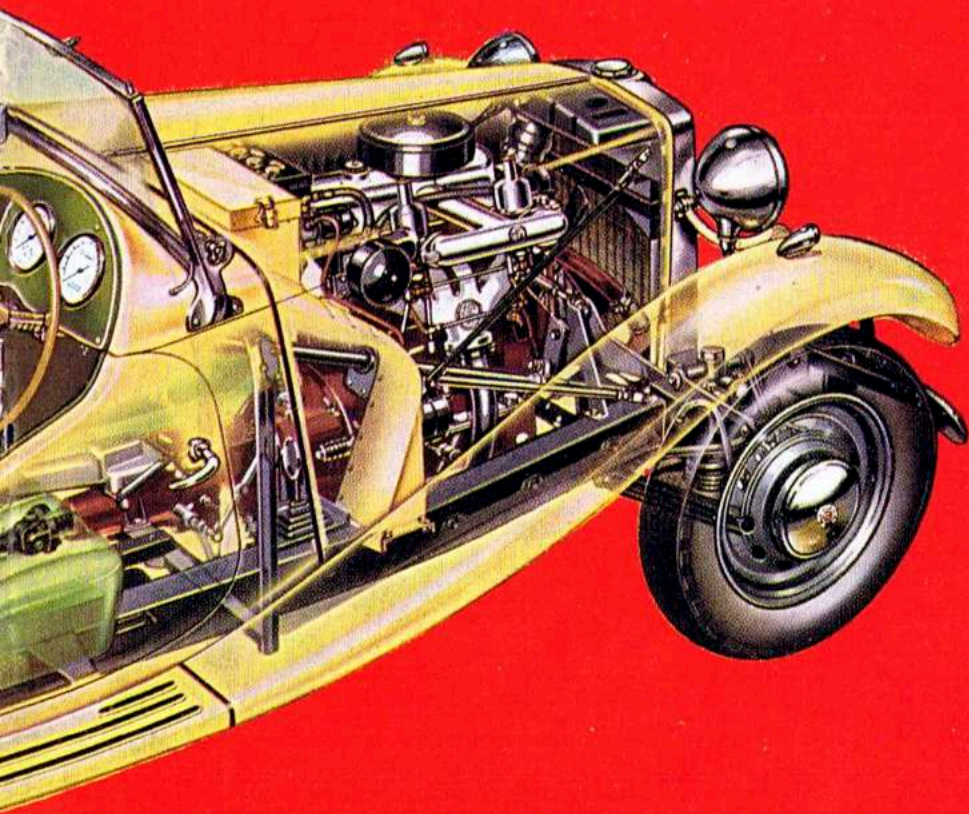

Ample space for luggage behind the seat squab with separate felt lined locker for the side screens.



Spare wheel mounted on chassis on strong tubular bracket.



Provision for two spares for competition drivers.



Spring spoked steering wheel with column adjustable for length.



"Safety glass" windscreen can be folded flat on the scuttle.



Twin electric screen wipers.



Quick release filler cap is fitted to 12½ gallons (57 litres) petrol tank.



Remote gear control with short lever for positive changes.



Compensated voltage control ensures a fully charged battery.



Best English leather upholstery.



Snugly fitting hood and side-screens afford complete protection from the weather.



Left- or right-hand steering.



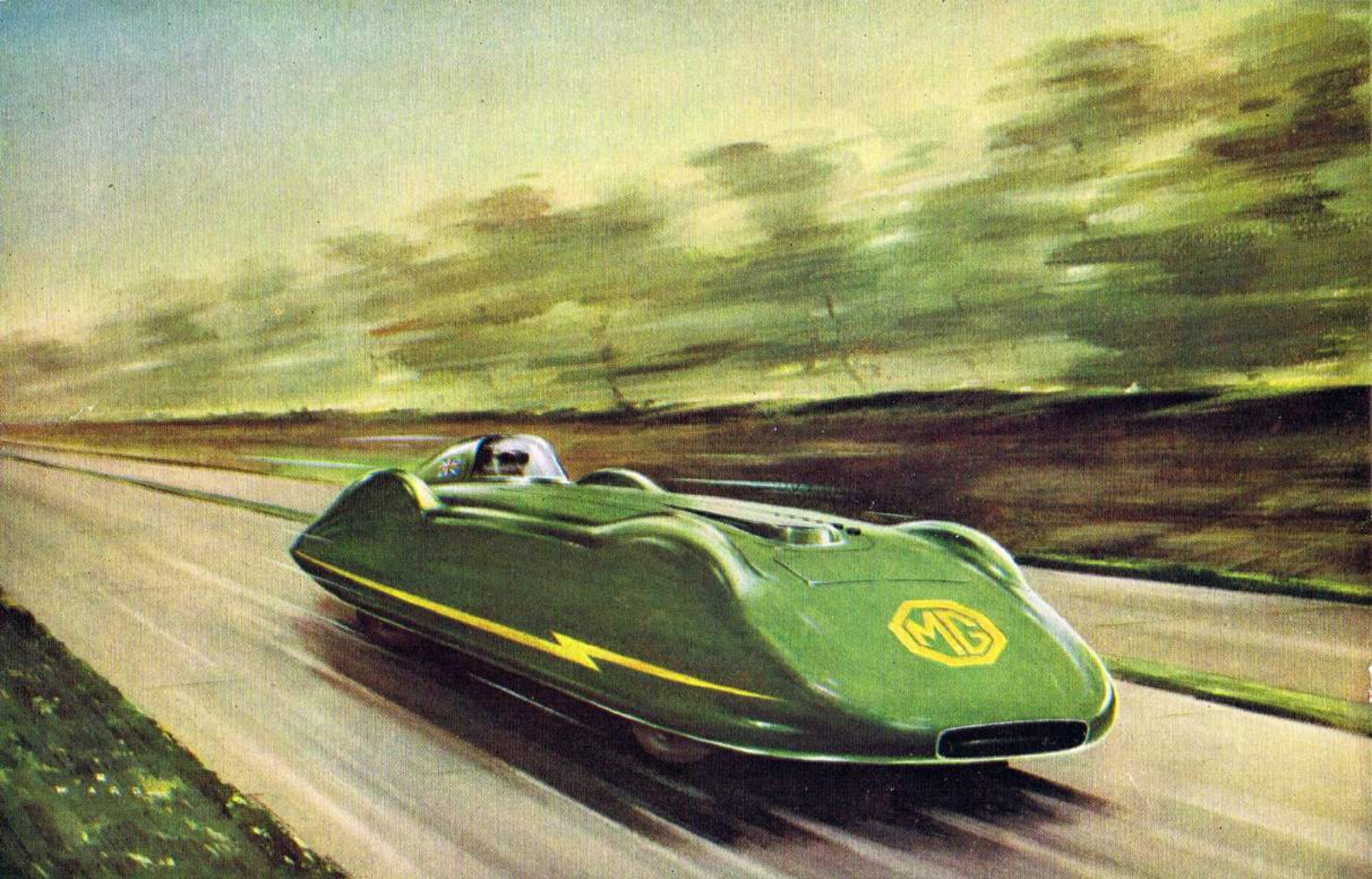

The world's fastest small car

INTERNATIONAL CLASS RECORDS HELD BY M.G. at 1st March, 1951.

Class F (over 1,100 c.c. and not exceeding 1,500 c.c.)				Class H (over 500 c.c. and not exceeding 750 c.c.)				m.p.h.	
1 kilometre	Flying start	204.3	1 kilometre	Flying start	159.1		
1 mile	" "	203.9	1 mile	" "	159.2		
5 kilometres	" "	200.6	5 kilometres	" "	150.5		
Class G (over 750 c.c. and not exceeding 1,100 c.c.)				Class I (over 350 c.c. and not exceeding 500 c.c.)				m.p.h.	
1 kilometre	Flying start	203.5	1 kilometre	Flying start	154.85		
1 mile	" "	203.5	1 mile	" "	153.55		
5 kilometres	" "	197.5	5 kilometres	" "	150.51		
5 miles	" "	144.6	200 kilometres	Standing start	111.04		
10 kilometres	" "	129.8	500 kilometres	" "	91.77		
10 miles	" "	129.4	1000 kilometres	" "	91.77		
50 kilometres	Standing start	123.22	2000 kilometres	" "	76.18		
100 kilometres	" "	121.65	200 miles	" "	95.02		
200 kilometres	" "	120.82	500 miles	" "	92.50		
500 kilometres	" "	108.89	1000 miles	" "	88.36		
50 miles	" "	120.72	3 hours	" "	94.59		
100 miles	" "	121.13	6 hours	" "	92.79		
200 miles	" "	109.74	12 hours	" "	86.67		
1 hour	" "	120.88	24 hours	" "	76.30		
3 hours	" "	108.49	Class J (up to 350 c.c.)				m.p.h.	
				1 kilometre	Flying start	119.93		
				1 mile	" "	121.04		
				5 kilometres	" "	117.51		

(Subject to official confirmation)

Lt. Col. Goldie Gardner's record-breaking



Safety **MG** *fast!*
in the making

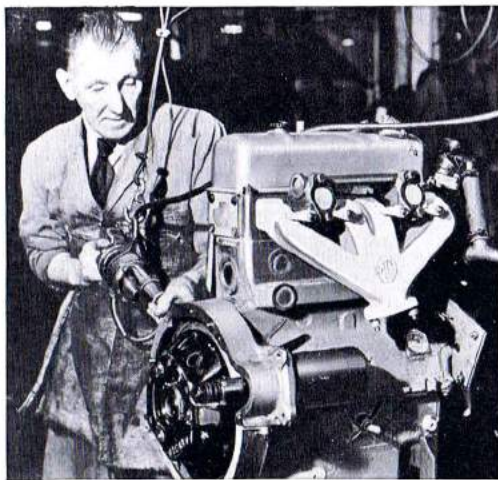

Clutch assembly.

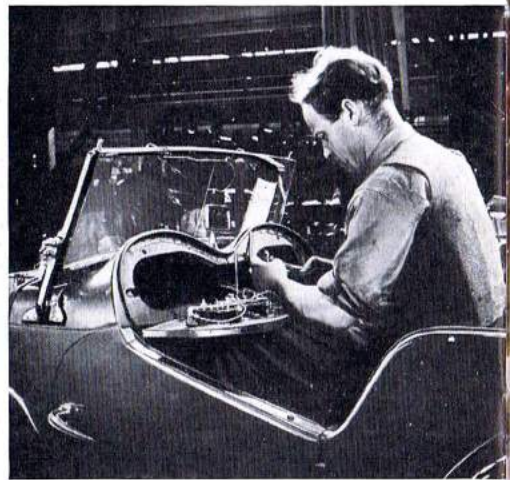

Wiring.

(Left) Panel beating.

The greatest single M.G. asset is the backing of the NUFFIELD ORGANIZATION. Only by the selected use of these vast manufacturing facilities can M.G. cars be built by individual assembly to such a high standard and at such a modest cost.



Making upholstery.

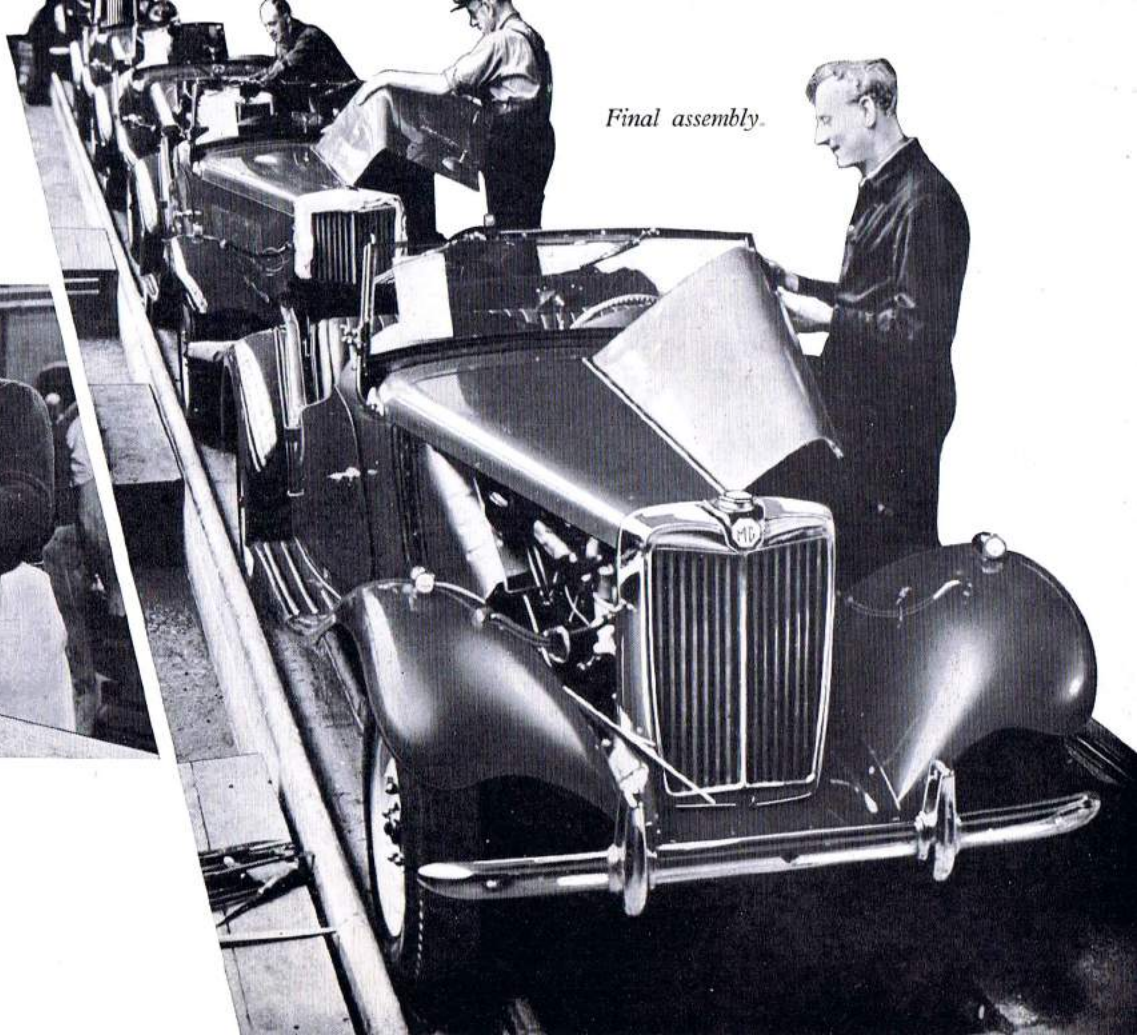

Final assembly.

Dimensions

A	B	C	D	E		F	G	H	I	J	K	L	M	N	O	P	Q	FRONT TRACK	REAR TRACK
54 in.	36 in.	3 in.	26 $\frac{1}{2}$ in.	Max. 52 in.	Min. 47 in.	30 $\frac{1}{4}$ in.	21 in.	28 in.	15 $\frac{1}{8}$ in.	40 in.	94 in.	148 in.	57 $\frac{1}{2}$ in.	44 $\frac{1}{2}$ in.	48 $\frac{1}{2}$ in.	59 in.	36 $\frac{1}{4}$ in.	47 $\frac{1}{8}$ in.	50 in.
1.37 m.	91.4 cm.	7.62 cm.	66.59 cm.	1.32 m.	1.19 m.	78.42 cm.	53.34 cm.	71.1 cm.	40.3 cm.	1.01 m.	2.38 m.	3.76 m.	1.46 m.	1.13 m.	1.23 m.	1.5 m.	92.07 cm.	1.2 m.	1.27 m.

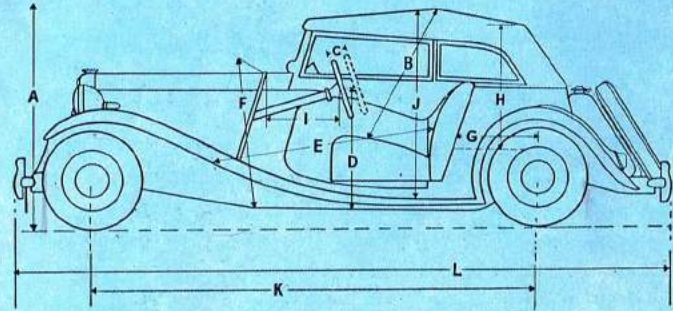
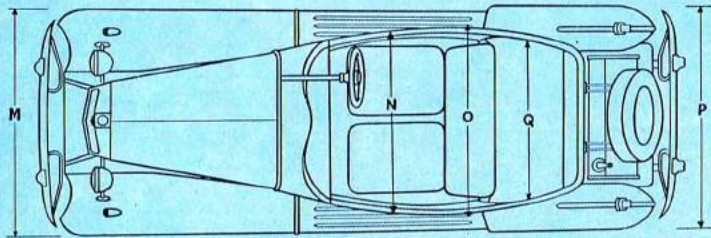

Performance Data

Reprinted by courtesy of "The Autocar."

ACCELERATION

Overall gear ratios	From steady m.p.h. of		
	10-30	20-40	30-50
5.125 to 1	12.5 secs.	12.2 secs.	12.9 secs.
7.098 to 1	8.2 secs.	8.2 secs.	9.2 secs.
10.609 to 1	5.5 secs.	—	—
17.938 to 1	—	—	—

WEATHER
*Dry, cold;
wind fresh to light.*

Acceleration figures are the means of several runs in opposite directions.

*From rest
through gears to*

30 m.p.h.	50 m.p.h.	60 m.p.h.	70 m.p.h.
6.2 secs.	15.3 secs.	23.5 secs.	44.4 secs.

SPEEDS ON GEARS (by Electric Speedometer)

	1st	2nd	3rd	Top
M.P.H. (normal and max.)	18-22	33-39	50-60	80-83
K.P.H. (normal and max.)	29-35.4	53.1-62.8	80.5-96.6	128.8-133.6



Specification

ENGINE: Four-cylinder; 66.5 mm. by 90 mm., capacity 1,250 c.c., O.H.V. push-rod; two valves per cylinder; three-bearing counter-balanced crankshaft; compression ratio 7.25 to 1; cooling by water pump and fan with thermostatic control; forced-feed engine lubrication by gear-type pump with 100 per cent. filtration; oil capacity 9 pints (5 litres); filler on valve cover; controlled expansion aluminium alloy pistons, with one scraper and two compression rings; 14 mm. sparking plugs; aluminium alloy sump.

FUEL SYSTEM: Twin SU carburettors with oilbath air cleaner; SU electric fuel pump; tank capacity 12½ gallons (57 litres). Fuel warning light on dash, indicating 2½ gallons (11 litres) reserve.

ELECTRICAL EQUIPMENT: Ignition by 12-volt coil and distributor with centrifugal automatic advance; belt-driven dynamo, compensated voltage control; single-pole positive earth wiring system with two fuses; twin windtone horns; dash control starter switch; twin-blade windscreen wiper, electric drive motor on screen rail. Both headlamps with dipping beams; twin stop/tail-lamps.

CHASSIS: Electrically welded throughout with boxed side frames and tubular cross-members; rear end of chassis is carried over the axle; chassis lubrication by grease gun with nipples at necessary points; manual jack system.

TRANSMISSION: Gearbox: four speeds and reverse; synchromesh second, third and fourth. Overall gear ratios: Top—5.125 to 1; Third—7.098 to 1; Second—10.609 to 1; First and Reverse—17.938 to 1. Central gear change.

Road speeds at 1,000 r.p.m.:

Top	14.42 m.p.h. (23.5 k.p.h.)
Third	10.41 m.p.h. (16.77 k.p.h.)
Second	6.97 m.p.h. (11.2 k.p.h.)
First	} 4.12 m.p.h. (6.6 k.p.h.)
Reverse	

Engine revs. peak—5,500 r.p.m.

AXLES: Semi-floating rear axle with hypoid gears, ratio 5.125 to 1. Independent front suspension, wish-bone-type links with coil spring; semi-elliptic rear springs mounted on flexing rubber bushes; Luvax Girling hydraulic piston-type dampers.

STEERING: Direct-acting rack-and-pinion type; 16½ in. (42 cm.) diameter spring-spoke steering wheel with plastic rim; steering column has 3 in. (7.6 cm.) adjustment for length. Left- or right-hand steering.

BRAKES: Lockheed hydraulic on all four wheels; 9 in. (23 cm.) diameter brake-drums; foot brake adjustment at each brake-drum. Hand brake lever with press-button ratchet control centrally situated between seats, automatically adjusted at same time as foot brake.

TYRES AND WHEELS: Dunlop 5.50 — 15 E.L.P. fitted to 4.00 × 15 well-base disc-type wheels with five-stud fixing.

INSTRUMENTS: 5 in. diameter speedometer with dead-beat reading, 5 in. diameter revolution counter with clock combined; central panel with ammeter, oil gauge, light switch, ignition switch, dip switch, horn button, warning lights and controls.

BODY DETAILS: Open two-seater, steel-panelled bodywork; all-leather upholstery; facia covered in leathercloth; glove box with lid; folding windscreen; fold-flat hood in waterproofed duck; separate cover for hood and luggage compartment; celluloid detachable side-screens; single-piece back squab with rack adjustment; individual seat cushions on sliding adjusters; driving mirror centrally mounted on scuttle; spare wheel mounted at rear of petrol tank; tool kit in box under bonnet; quick-release petrol tank cap.

COLOURS:

<i>Body</i>			<i>Leather upholstery</i>
Black	Red, Beige or Green
M.G. Red	Red or Beige
Almond Green	Beige
Ivory	Red or Green
Clipper Blue	Beige

Nuffield Exports Limited reserve the right to change prices, specifications and equipment at any time without notice, and vehicles are offered subject to the Company's usual terms of business.

Extra equipment

Prices and supply through your dealer

1. Chromium-plated external luggage rack.
2. Chromium badge-bar and two mounting brackets with spot light if required.
3. Radio concealed in glove box with aerial fitted to scuttle.
4. Twin spare-wheel carrier and 6 in. rear tyres and wheels for competition purposes.



The chromium-plated luggage rack in position.

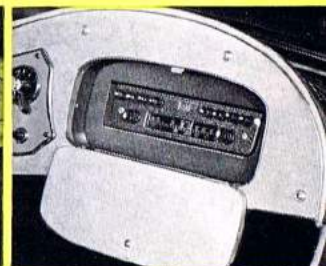

A radio set can be concealed in the glove box.

Service

M.G. SERVICE is as thoroughly specialised as the car production. Nuffield Exports Limited retain their interest in their cars after they are sold and want to know that you are obtaining the utmost satisfaction and pleasure from their products. The vast M.G. Dealer organisation is always at your service. During the early life of the car, soon after it has completed 500 miles, you are entitled to have it inspected, free of charge, by the M.G. Dealer from whom you purchased it. This attention given during the critical period in the life of the car makes all the difference to its subsequent life and performance. This service includes :

- (a) Drain sump, gearbox and back axle, and refill with one of the approved oils.
- (b) Oil and grease vehicle throughout.
NOTE.—New lubricants chargeable to customers.

- (c) Check and, if necessary, adjust :
 - (1) Ignition timing.
 - (2) Tappet clearances.
 - (3) Carburetter control gear, mixture setting and slow-running.
 - (4) Dynamo drive belt.
 - (5) Correct clearance for clutch pedal.
 - (6) Alignment of front wheels.
 - (7) All steering controls.
 - (8) Tyre pressures.
- (d) Adjust brakes and check level of Lockheed fluid in supply tank.
- (e) Look over and tighten all nuts, particularly cylinder head, wheels, spring clips and body bolts.
- (f) Top up battery and check working of all electrical equipment.

All this first service is free, only material being charged for.

Guarantee

1. For a period of SIX MONTHS from the date on which a new M.G. car or chassis is delivered to the first owner-user thereof Nuffield Exports Limited will exchange or repair any part or parts thereof which needs or need replacement or repair by reason of defective workmanship or defective material. The Company will not be responsible for any expense which the Purchaser may incur in removing or having removed or in replacing or having replaced any part or parts to be sent for inspection or in fitting or having fitted any new parts supplied in lieu thereof.

2. No claim for exchange or repair can be considered hereunder unless the person claiming—

- (a) Returns the part or parts complained of carriage paid to the Company's nearest Authorised Distributor or Dealer.
- (b) Sends therewith particulars of the chassis number and engine number of the car or chassis in question as shown on the manufacturer's identification plate.
- (c) Sends also particulars, stating date of the purchase and the name and address of the person or firm from whom the car or chassis was bought.

(d) Refers to this guarantee.

3. This Guarantee shall not apply to—

- (a) Any accessories or proprietary fittings whatsoever.
- (b) Any car or chassis used:
 - (i) As a Hackney Carriage.
 - (ii) For hiring out.
 - (iii) For any purpose other than the private or genuine commercial use of the owner-user.
 - (iv) For racing and/or record attempts.
- (c) Any part or parts which in the opinion of Nuffield Exports Limited has or have been injured by wear and tear or by any form whatsoever of improper use of or from any alteration whatsoever to the car or chassis.
- (d) Any second-hand car or part or parts thereof.

- (e) Anything whatsoever not both manufactured by The Nuffield Organisation and sold by the Company.
- (f) Any part or parts of a chassis to which a body which in the opinion of the Company is unsuitable has been fitted.
- (g) Any car or chassis in or to which part not manufactured or sold or approved by The Nuffield Organisation has been affixed.
- (h) Any car or chassis which is not bought direct from the Company or from one of their authorised Distributors or Dealers or through a bona fide motor dealer who has been supplied by the Company's authorised Distributor or Dealer in his territory.
- (i) Any component part supplied by the Company to the order of the purchaser which differs from the standard specification of the complete car or chassis.
- (j) Any car or chassis which has been repaired or altered in any way if in the opinion of the Company such repair or alteration affects the stability or reliability of any such vehicle.
- (k) Any car or chassis from which the maker's identification plate has been removed or otherwise tampered with.

4. In the event of a major accident necessitating a complete stripping down of the car or chassis the unexpired portion of the Guarantee is only valid if such work is undertaken by one of the Company's Authorised Distributors.

5. The liability of Nuffield Exports Limited is limited to exchange or repair under Clause 1 hereof. Every form of liability for every form of consequential loss or damage is hereby expressly excluded.

6. This Guarantee is given in lieu of and excludes every condition or warranty, whether statutory or otherwise, whatsoever not herein expressly set out.

Safety  *fast!*

Prices on application.

Nuffield Exports Limited reserve the right to change prices, specifications and equipment at any time without notice, and vehicles are offered subject to the Company's usual terms of business.

**NUFFIELD EXPORTS LIMITED
COWLEY · OXFORD · ENGLAND**

Proprietors Morris Motors Ltd.

Viscount Nuffield, G.B.E., *Chairman*
Telephone Oxford 77733

Telegrams and Cables Morex, Oxford

R. F. Hanks, *Vice-Chairman*
Telex Oxford Telex 7168

Codes Bentley's, Bentley's Second Phrase, A.B.C. (Fifth and Sixth Editions) Western Union and Private

Printed in Great Britain by Buckler & Webb Ltd., Birmingham.

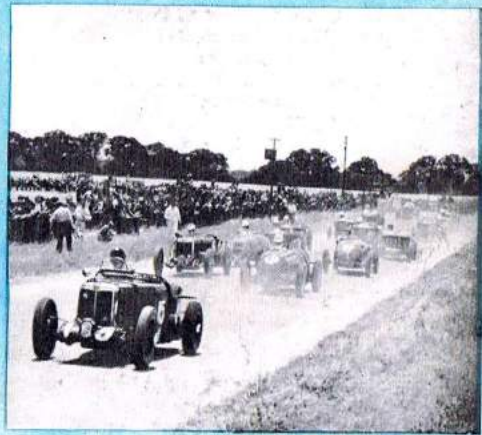

Safety  Just!

EUROPEAN BRIDGEHEAD

Smedestraat 22 - Haarlem
Telefoon 11025 - 11200

