

The Volkswagen Transporter. The Volkswagen Caravelle.



210  529

Stanwell Boston Ltd.
45 Main Ridge East
Boston, Lincs.
Tel: (0205) 62857



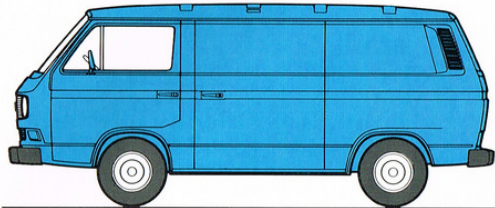

Delivery van.
The all-purpose Transporter for all branches of trade, business and industry.

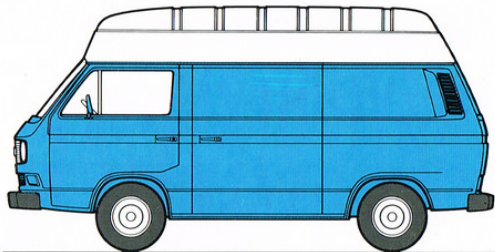

High-roof delivery van.
Plenty of loading space for carrying goods practically and economically. Easy loading and standing room inside.

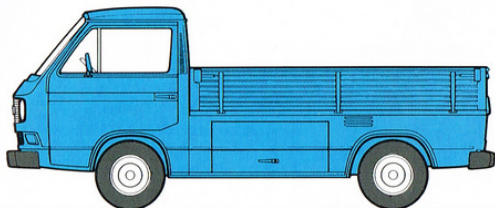

Pick-up.
There is hardly a job the Pick-up can't tackle: a vehicle for every conceivable task.

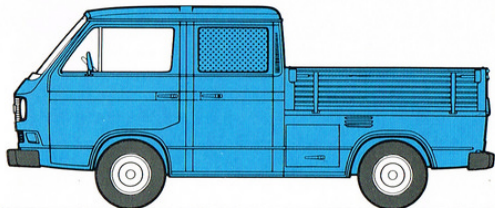

Double-cab.
The Transporter version for carrying tools, materials and up to six passengers at the same time.

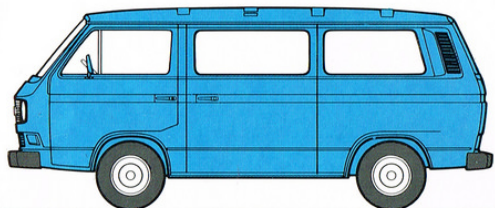

Caravelle C.
An economical 12-seater bus. With a whole range of useful equipment.

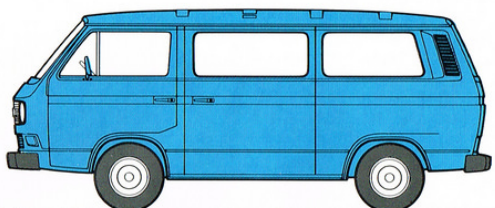

Caravelle CL.
A comfortable and practical 8-seater.

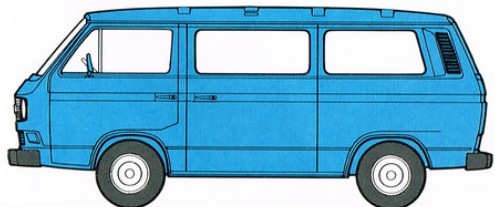

Caravelle GL.
An extremely comfortable bus. A 7-seater, with a high level of interior equipment.

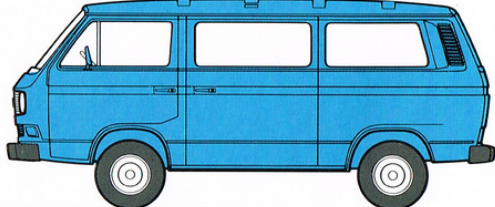

syncro
The thinking four wheel drive system. Available in all versions of Transporter and Caravelle.

**Volkswagen Transporters and Caravelles:
A supreme choice.**

Volkswagen Transporters and Caravelles have long been synonymous with safety, reliability and economy. The unparalleled standard model range, wide number of body versions for various trades and individual special equipment features combine in forming a unique transport concept.

Whether as a large luxury saloon for business travel or as a comfortable means of bringing personnel to the factory, office or construction site, whether used as a versatile form of family transport and accommodation or for conveying all manner of goods and equipment from A to B, this vehicle has long since been a familiar sight on the roads in a large number of countries.

Its range of uses is as great as the range of model versions. As far as the Caravelle or Transporter's equipment features and engines are concerned, it is genuinely possible to obtain a vehicle tailored exactly to your needs.

One feature common to all versions is their advanced technical design. They are distinctly manoeuvrable and easy to handle in traffic, safe to drive and comfortable to use.

Its road behaviour is outstanding, even with a full payload, as a result of the equal distribution of axle loads and the complex independent suspension design. The safe, manoeuvrable, comfortable and reliable way to travel.

The new "syncro" four-wheel drive technology complements these properties, keeping the vehicle moving even on very difficult surfaces.

On the inside, the emphasis is clearly on travel comfort and space. From the anatomically-correct seats, with ample leg-room and elbow space, to the convenient entrances and access for loading or the wide range of practical equipment features, this is at the heart of what has made the Volkswagen Transporter and Caravelle a great success with its users 6 million times and more.

And naturally, they offer standards of value retention, reliability and safety which do the name of Volkswagen proud.

Because high-performance, advanced technology coupled with supreme quality standards mean that the new generation of Volkswagen Transporters and Caravelles are not only more powerful and faster but also even more reliable and economical.

For 36 years we have constantly been improving and developing this concept.

A task which we will pursue with the same dedication in the future. To ensure that Volkswagen Transporters and Caravelles continue to enjoy unparalleled worldwide success.



The Delivery van and High-roof delivery van: Easy to load, economical to use.

Every conceivable type of day-to-day transport task can crop up in business, trade, industry and the service industries.

The Volkswagen Delivery van and High-roof delivery van represent the most suitable solution for tasks of this nature.

Alongside their well-known good road behaviour, they offer several advantages both for loading and unloading, as well as on the move.

One of these advantages is a large load space of 5.7 m³, the Delivery van can carry an effective payload of up to 1070 kg – loaded either from the side or the rear.

With an extra 415 mm on top, the High-roof delivery van is especially suited to carrying large or bulky items.

The load space is 1.9 m³ larger than on the Delivery van, with a total volume of 7.6 m³.



And the higher roof also offers another advantage: with a floor-to-roof height of 188 cm, there is room to work inside the vehicle.

With the wide standard sliding door on the right-hand side, large rear tailgate and low load platform height, loading or unloading goods is made as straightforward as possible. The

load platform height at the side is only 45 cm.

The Delivery van and High-roof delivery van can also be supplied with a second sliding door on the driver's side as an optional extra.



There is a through passage from the cab to the load space as standard on the Delivery van and High-roof delivery van, for access to whatever you are carrying without needing to get out of the cab. We recommend the full roof-height partition as an optional extra when transporting small items of equipment.

This feature makes stacking easier and prevents goods from sliding around if the brakes have to be applied abruptly. There is a window to provide the driver and front passenger with a view of the load space.

And for special transporting tasks there is also a split partition option.



There is an additional storage compartment above the cab in the High-roof delivery van – a highly practical way to store small goods or materials. A shelf lip is provided to prevent objects from falling out while in transit.

The Delivery van's principal technical data.

The Delivery van has an overall length of 4,570 mm, overall width of 1,845 mm and overall height of 1,965 mm. The load space is 2,780 mm long, 1,590 mm wide and 1,465 mm high. The payload ranges from 1,035 to 1,070 kg, depending on engine version. Maximum permitted trailer towing load: 600 kg, unbraked; 1,200–1,500 kg, braked, depending on engine. A tachograph may be required when GTW exceeds 3,500 kg.

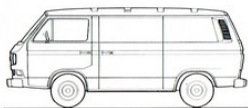

The High-roof delivery van's principal technical data.

The High-roof delivery van has an overall length of 4,570 mm, overall width of 1,845 mm and overall height of 2,365 mm. The load space is 2,780 mm long, 1,590 mm wide and 1,880 mm high. The payload ranges from 985 to 1,020 kg, depending on engine version. Maximum permitted trailer towing load: 600 kg, unbraked; 1,200–1,500 kg, braked, depending on engine. A tachograph may be required when GTW exceeds 3,500 kg.

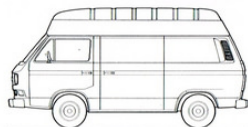

Please note: Bulkhead partitions and radio aeriels shown in these pictures are optional at extra cost.



The Pick-up and Double Cab Pick-up: Large platform, compact overall dimensions.

Cement, a concrete mixer, window frames, fittings, furniture, garden materials and equipment — whatever you have to transport, the Pick-up is the supreme solution. With a load platform up to 2,730 mm long and 1,735 mm wide. Yet despite this generous platform size, the Pick-up occupies very little road space — a vital plus when in busy road conditions.

The standard cab on both Pick-up versions has three seats, with an individual driver's seat and a double bench seat for the front passengers. With plenty of elbow room and leg-room, travelling is always comfortable and relaxed.



The flat platform is made of steel with hardwood strakes. The drop sides and tailboard, which fold down on all three sides, are of strong steel profile sheeting and fitted with special safety clasps. There is an access step on the tailboard for climbing up onto the platform, to facilitate loading and unloading.



An optional extra available for both Pick-up versions, to ensure your goods are transported not only safely but also protected from wind and weather, is the plastic tilt and bows.

The load platform of the Double Cab Pick-up is 1,880 mm long and 1,735 mm wide, making a total area of 3.24 m². With no wheel arches protruding into it, every corner can be used to the full.

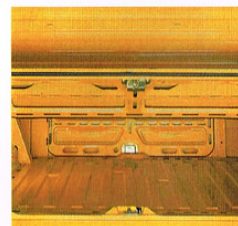

Beneath the platform on both the Pick-up and Double Cab Pick-up there is an additional, lockable storage compartment accessible from both sides, with plenty of room for numerous tools and utensils.

The Pick-up's principal technical data.
Overall length/width/height: 4,570/1,870/1,930 mm. Load space: 2,730/1,735/365 mm. Payload from 1,035 to 1,070 kg depending on engine version. Maximum permitted trailer towing load: 600 kg, unbraked; 1,200–1,500 kg, braked depending on engine. A tachograph may be required when GTW exceeds 3,500 kg.

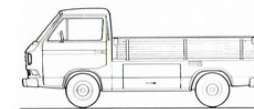

Principal technical data of the Double Cab Pick-up.

Overall length/width/height: 4,570/1,870/1,925 mm. Load space: 1,880/1,735/365 mm. Payload from 980 to 1,015 kg depending on engine version. Maximum permitted trailer towing load: 600 kg unbraked; 1,200–1,500 kg braked, depending on engine. A tachograph may be required when GTW exceeds 3,500 kg.

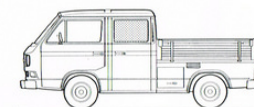

Please note: Rear side windows of the Double Cab are usually blanked with steel panels. The cab can be converted in the UK to include seats and windows, but Car Tax is payable if rear windows and/or seats are fitted. The radio aerials shown in these pictures are optional at extra cost.

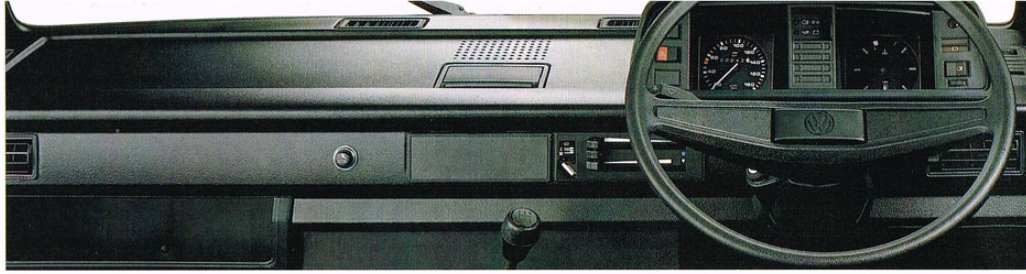

**The cab:
A workplace you can feel
at ease in.**

The cab of the Volkswagen Transporter successfully combines the luxury of a passenger car with the ruggedness of a commercial vehicle.

Our designers have created a workplace which relaxes the driver, whether in town traffic, on cross-country routes or on minor roads.

The anatomically-shaped seats permit comfortable, relaxed driving, with plenty of room to prevent the legs and arms from becoming cramped.



All controls and instruments are conveniently arranged so that they are within easy reach of the driver or immediately within the field of vision.

From the speedometer to the battery charge telltale and dynamic oil pressure indicator, all important aids to help you keep a check on the vehicle are present.

But an ergonomically-designed workplace entails more than just this. The easy-action steering and precise gear shift, for example.

Or the quiet, powerful, easily-controlled heating system with three-stage blower and electric windscreen wipers with two-speed setting. Not forgetting the adjustable seat backs, automatic seat belts and hollow-outline head restraints for the driver and front passenger.

It's easy to see how much importance was attached to both safety and comfort in the design of this workplace. The cab of the Volkswagen Transporter not only makes your work a lot less tiring; it also ensures that you feel entirely relaxed.

The cab has two cloth-covered seats as standard. Leatherette-upholstered seats and a wide double bench seat for front passengers (illustrated), are available as optional extras.





The Caravelle GL: The executive bus.

Whether for long-distance travel or for town driving, every journey is a pleasure. Because the GL equipment specification satisfies even the highest of standards.

The Caravelle GL is the solution wherever a deluxe, spacious vehicle is required.

You will find it in service as a mobile visiting card for large hotels and tour operators, on shuttle services to airports and of course as an elegant large-sized saloon with plenty of space for all the family, to name only a few examples.

Distinguishing features of the Caravelle GL include its special metallic paintwork, with bright window surrounds and chrome-finish bumpers with rubbing strips.

With 1.7 m³ of luggage space, this vehicle offers ample space for cases and bags. And if you should need more space, with the rear seat back folded forward the luggage space immediately grows to an immense 2.93 m³.

The heated rear window is included in the standard specification, together with the rear wiper with automatic wash-wipe.

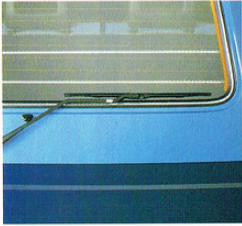

Now for the seats. The driver and front passenger feel instantly at home in the anatomically-shaped individual seats with adjustable armrests. The special velour upholstery is as comfortable as it is hard-wearing.

The Caravelle GL has seven seats. The centre and rear bench seats are also fitted with armrests and upholstered in velour fabric, so that all your passengers can travel in comfort all the time.

The interior need fear no comparison with a deluxe passenger car. All features are tastefully colour-coordinated. The door and side panels have a fabric insert and bright trim strips. The vehicle floor and luggage compartment are lined with high-quality, hard-wearing velour carpeting.



Finally, take a glance at the fascia. All instruments and controls are arranged clearly and practically, within the driver's field of vision.

All-round deluxe equipment, included in the standard specification.

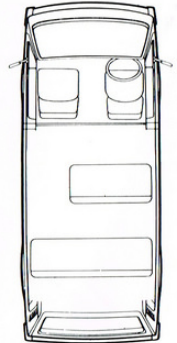
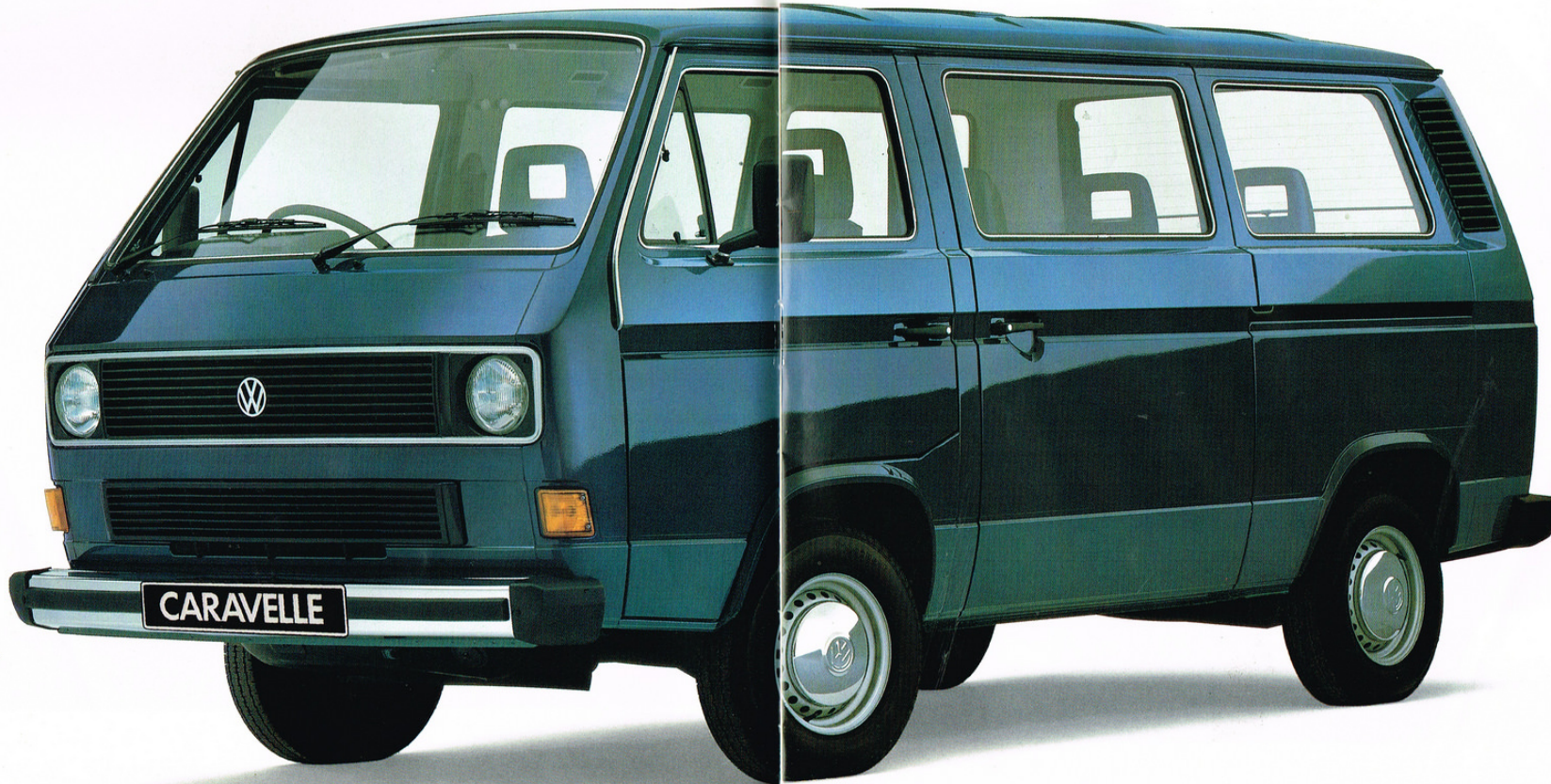
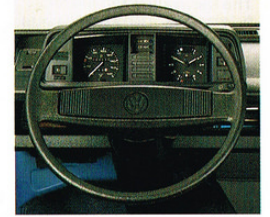

7 seats

The Caravelle GL's principal technical data.

The Caravelle GL has an overall length of 4,600 mm, overall width of 1,845 mm and overall height of 1,950 mm. Seats 7. Maximum permitted trailer towing load: 600 kg, unbraked; 1,500-2,000 kg, braked, depending on engine. A tachograph may be required when the GTW exceeds 3,500 kg.



Please note: Caravelle GL is now available with metallic paint finish only. See end of brochure for details.



**The Caravelle CL:
Practical to use, comfortable
to ride in.**

Here is a bus that is a genuine all-rounder, offering a degree of luxury to go with the reliable Volkswagen technology that lies beneath the surface. In keeping with this model's concept, the Caravelle CL is ideally suited to such tasks as passenger transport or bulk shopping trips. Not forgetting the family's holiday travel plans.

Just the ticket for all who might not necessarily want a deluxe vehicle but who still prefer one which offers something more than a basic specification. And who are always willing to listen to practical commonsense.

Let's start on the outside. The two-colour paintwork, chrome-finish bumpers with rubbing strips and the bright window surrounds are all standard.

And its generously-dimensioned interior includes such practical details as a trip recorder, lockable glovebox on the front passenger's side, clock and 12-Volt power socket.

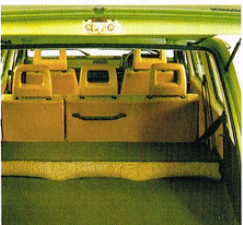

Not forgetting the carpet-lined luggage space measuring 1.7 m³, which can be enlarged by a further 1.23 m³ by folding the rear seat back forward.

Which leaves plenty of room for such diverse items as shopping bags, packing cases and camping accessories.

Let's have a look inside the cab, with its anatomically-shaped seats in high-quality, hard-wearing cloth upholstery.

There are two opening quarterlights — a particularly popular feature for ensuring an adequate supply of fresh air in the cab. Included as standard, like the reversing lights.

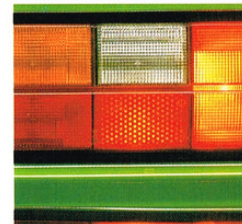

Last but not least, a few details of the seats. All seats are in hard-wearing cloth, and of exceptionally comfortable design. The cloth gives a particularly elegant look which will last for many years to come.

Not for nothing do Volkswagen buses enjoy a reputation for maintaining their value.

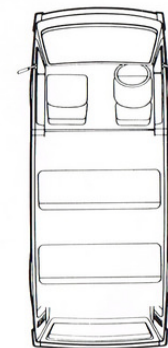

8 seats

The Caravelle CL's principal technical data.

The Caravelle CL has an overall length of 4,600 mm, overall width of 1,845 mm and overall height of 1,950 mm. Seats 8. Maximum permitted trailer towing load: 600 kg, unbraked; 1,500 kg, braked. A tachograph may be required when the GTW exceeds 3,500 kg.



Please note: The fog lights and radio aerials shown in these pictures are optional at extra cost.



**The Caravelle C:
Economical in every respect.**

A familiar sight as a means of passenger transport for companies and authorities, a practical form of transport for all the family . . . The list goes on and on.

The most economical option from our Caravelle range holds a great attraction for quite a number of people nowadays. Because the Caravelle C offers everything you need for satisfying bus travel, at a more than attractive price.

A spacious, roomy vehicle with plenty of space for 12 people, convenient access and good luggage space.

Then there is the very modest turning circle of 10.7 m. What's more, your bus does not need outside parking spaces, and will fit into most standard-size garages.

The luggage compartment and cab floor are covered with practical rubber mats. The passenger compartment floor is covered with equally practical and hard wearing vinyl board.

The seats, in high-quality, hard-wearing leatherette, are practical and comfortable.

The Caravelle C is a 12-seater, with a double front-passenger bench seat and two sliding doors for easy access to the rear compartment.

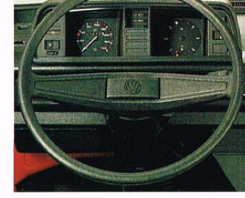
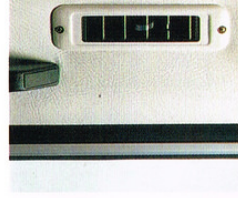

The combined heating and ventilation system with three-speed blower ensures a constant, agreeable temperature inside the bus. With the ventilation ducts and four outlets in the roof frame, every passenger can enjoy as much or as little fresh air as desired.

Finally, just take a glance at the fascia, with variable-intensity lighting.

Everything is clearly laid out, to make driving this Volkswagen the easiest of tasks.

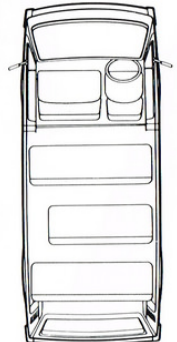

12 seats

The Caravelle C's principal technical data.

The Caravelle C has an overall length of 4,570 mm, overall width of 1,845 mm and overall height of 1,950 mm. Seats 12. Maximum permitted trailer towing load: 600 kg, unbraked; 1,500 kg, braked. A tachograph may be required when the GTW exceeds 3,500 kg or if the vehicle is used on the continent.



Please note: The 12 seat Caravelle C does not have head restraints in the rear compartment. The model pictured is not available in the UK. The radio speakers and aerial shown above are optional at extra cost.



**Syncro:
The superior four-wheel drive system.**

Exceptional driving pleasure coupled with ultimate safety standards. With the new four-wheel drive technology of the Volkswagen syncro, even the most extreme road or weather conditions can be overcome effortlessly.

Whether on snow, ice, slush or sand, nothing can hold up the syncro.

All four wheels power you safely to your destination, without even needing to operate so much as a switch.

It copes with fast motorway travel, heavy urban traffic, unmetalled roads, off-road driving, snow-bound slopes and steep, difficult mountain tracks with equal ease. All thanks to syncro's technological design.

Its floor pan is specially designed to withstand the extreme conditions likely to be encountered. An undertray device in front

of the front wheels and another for the engine and gearbox provide a necessary degree of safety. The same applies to the protective rails on either side of the propeller shaft. The 70 litre fuel tank is located directly ahead of the rear wheels.



There are various engines for the syncro to match operating conditions and requirements, from the 57 kW (78 bhp) water-cooled horizontally-opposed version through the 51 kW (70 bhp) turbo-diesel to the fuel-injection engine developing

82 kW (112 bhp).

Unlike conventional four-wheel drive vehicles, the syncro's technology automatically regulates the additional drive to the front wheels as necessary. Even a minor difference

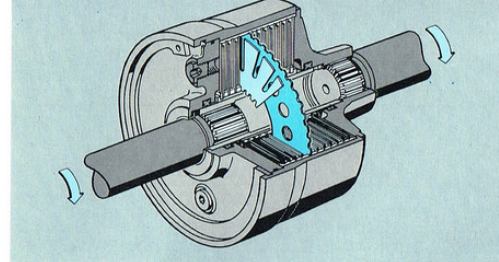

in the speeds of the front and rear wheels is monitored by a viscous coupling.

Traction is transferred continuously to the front wheels in such a smooth, jolt-free manner that you feel only the effect, not the procedure. The result: reliable, stable driving in every

situation.

In off-road driving, critical conditions close to the handling limits, for everyday use and on snow-covered or icy roads.

The new syncro technology is available for every Volkswagen Caravelle and Transporter version. With a standard 4+G gearbox (4-speed gearbox with additional off-road gear).

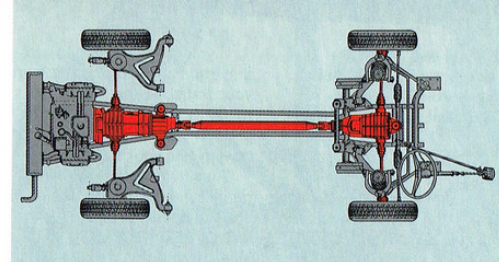

For operation on particularly extreme conditions, syncro models are supplied with differential locks at both front and rear, for independent operation as and when required.

The advantage of this feature is that each pair of wheels becomes rigidly locked so that the entire tractive force is utilised to the full. The differential lock switches are located on the fascia, for easy access.

syncro.
The following Volkswagen models are available with syncro technology: Caravelle GL, Caravelle CL, Caravelle C, Delivery van, High-roof delivery van, Pick-up and Double cab. Vehicle height and payload depend on the individual model. Maximum permitted trailer towing load: 600 kg, unbraked; 1,500-2,000 kg, braked, depending on engine. A tachograph may be required when the GTW exceeds 3,500 kg or when bus versions are used on the continent.

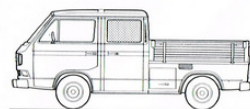
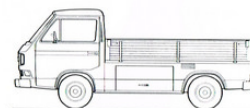
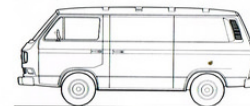

Please note: The vehicles pictured on these pages illustrate the features and capabilities of syncro. The versions and accessories shown may not be available in the UK.

Optional extras for the Transporter and Caravelle: a made-to-measure equipment specification.

With such a wide range of models and engine options, you will have no problem finding exactly the Volkswagen Caravelle or Transporter to suit your individual requirements. And if you should still have any particular wishes, you are sure to find the answer in the wide range of factory fitted equipment options.

Light-alloy wheels not only lend your bus an individual character; they also create a distinctive sporting flair.

The rev. counter is particularly useful as a guide to the correct moment to change gear. The ideal way to protect the engine, minimise the load it has to withstand and reduce fuel consumption.

Halogen fog lights help you see more clearly, for safer driving in mist and fog.

Many drivers have also come to appreciate the advantages of a headlight cleaning system. Clean away any dirt or grime while in transit simply at the push of a button, to keep a clear view of the road ahead.

When the sun is shining, the tilt glass sunroof keeps the vehicle interior fresh and light. For even more fresh air, why not consider front vent windows on both sides?

A highly practical feature is the electrically heated, remote-control mirror: especially useful in cold weather or whenever a different driver takes to the wheel. Simply operate the lever to set the mirror to the best position for an ideal view.

For those who prefer extra flexibility as far as the seats are concerned, there is a rotating driver's and/or front passenger's seat and a folding and reclining rear bench seat.

Power steering simplifies manoeuvring and reduces the amount of effort required, including when driving with a full load. As a result, drivers can still concentrate on their work, even at the end of a long working day.

If you have so much to carry that there is not enough room in your Transporter or Caravelle towing a trailer presents no problems: a factory-fitted trailer towing coupling can be supplied.

And if you or your passengers prefer travelling in a constant, agreeable climate, an air conditioning system will be ideal. It runs sufficiently quietly not to interfere with music on the radio.

For extra driving convenience, automatic transmission makes driving your Volkswagen Transporter or Caravelle an even more relaxing experience. This is one option that increasing numbers of drivers are finding a "must". Or take for instance the tried-and-tested 5-speed gearbox, for even more powerful, economical driving.

An additional fuel-burning heater will keep the inside pleasantly warm during cold weather.

For operation in dry, dusty climates or dusty regions, there is an engine air intake opening located in the roof. In conjunction with the roof-mounted luggage tray, this creates an additional load area.

Differential locks at both the front and rear for the Transporter and Caravelle syncro can be engaged as required, whenever the going gets particularly tough.

If we have not mentioned your favourite equipment option, ask your local V.A.G. dealer for details of individual equipment options. The range is simply too extensive to list here in its entirety.



Light-alloy wheels.



Rev. counter and clock.

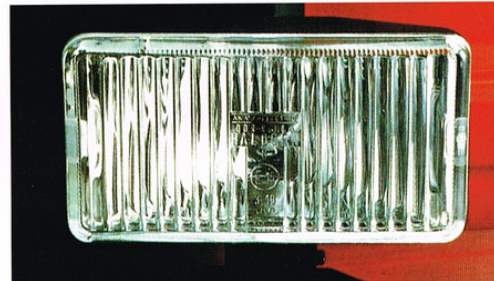

Halogen fog lights.



Headlight cleaning system.

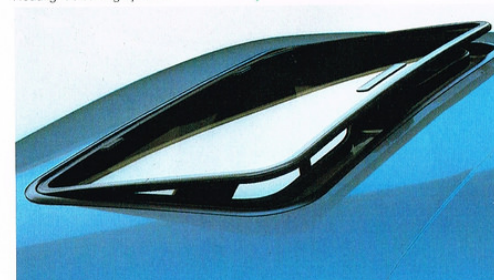

Tilt glass sunroof.



Electrically heated, remote-control door mirror.



Reclining bench seat.

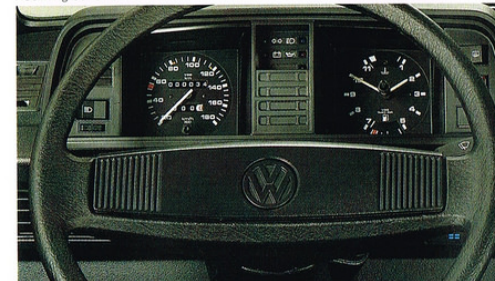

Power steering.

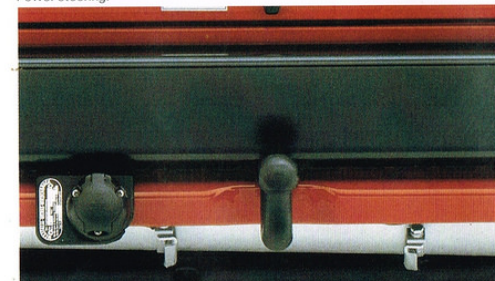

Trailer towing coupling.



Air conditioning system.



Vent window.

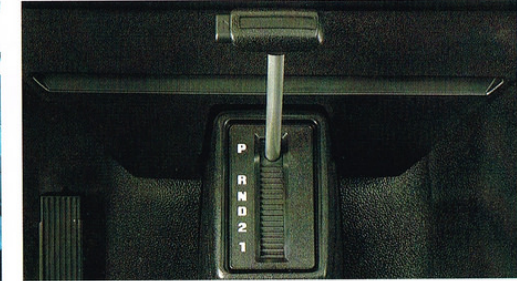

Automatic transmission.

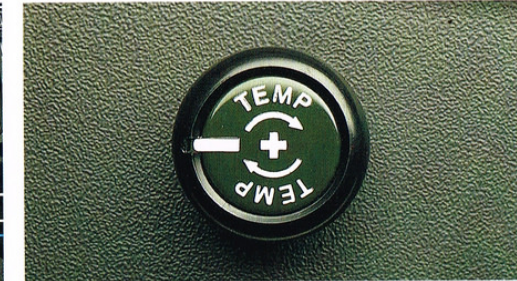

Additional fuel-burning heater.



Fresh-air intake opening with additional roof-mounted luggage tray.

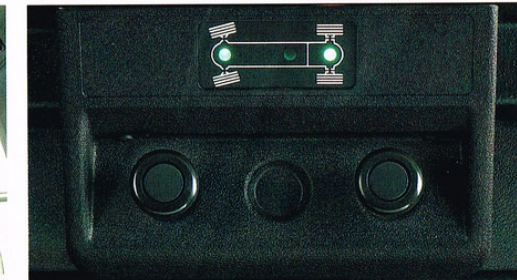

Differential locks on syncro versions (standard).

**Technical design:
Success is built on it.**

For many years, Volkswagen Transporters and Caravelles have epitomised safety, reliability and economy. Not for nothing are they world-beaters.

But success is no hit-and-miss affair. We have steadily improved this technical concept and continued to develop it in order to make our vehicles even stronger, comfortable, efficient and safe.

Such an ambitious approach depends on a modern, reliable technical design. Something which is of a particularly high standard on the Volkswagen Transporter and Caravelle, thanks to our wealth of experience and a constant stream of improvements.

For instance, an outstanding suspension design permits superior road behaviour.

Or there is the front axle layout, which permits a high degree of manoeuvrability in conjunction with a highly favourable distribution of axle loads.

And despite the complex nature of this safety-oriented design, maintenance requirements are kept to a minimum.

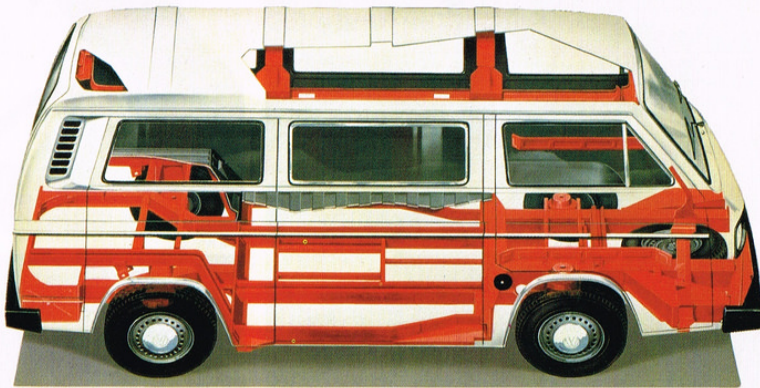

The various features included in this safety system range from the torsionally-rigid floor pan to the forked frame beneath the cab, made of strong profile sections for a high level of passive safety. In the event of a collision, impact energy is largely absorbed by the bumper

and dissipated via the deforming element which stretches across the whole width of the vehicle.

Cross members with vertical webs, longitudinal members, door profiles and a safety steering column with breakaway

element and deforming members all combine in providing maximum protection should the worst come to the worst.

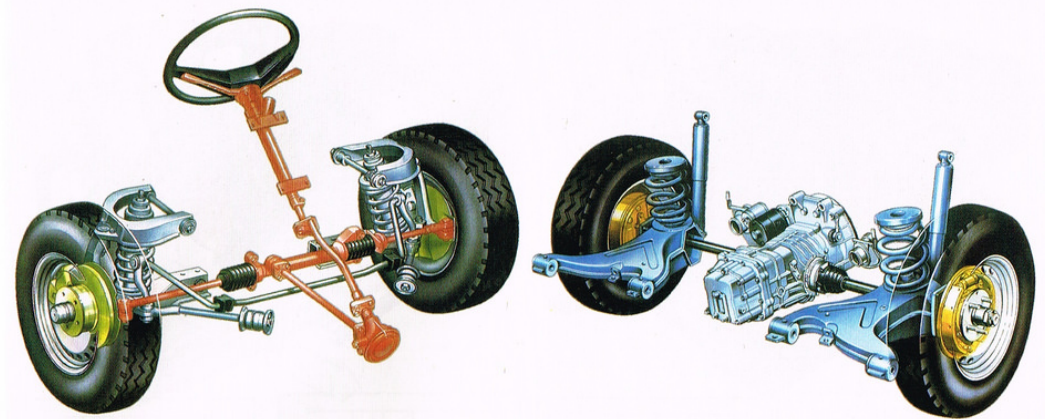

A further example of the technical superiority represented by Transporter and Caravelle models is the double-wishbone front axle layout with self-stabilising steering.

This design largely prevents the vehicle from running out of line when braking or when the wheels on one side of the vehicle are on a loose surface.

Volkswagen Transporters and Caravelles have a semi-trailing arm rear axle, a design which is also used on high-performance sports cars and passenger cars.

With its powerful minibloc springs and telescopic dampers, this important running-gear element makes a vital contribution towards the vehicle's superior road behaviour.

This is what we mean in stating that a mature technical design is the best basis for safety, reliability and economy.

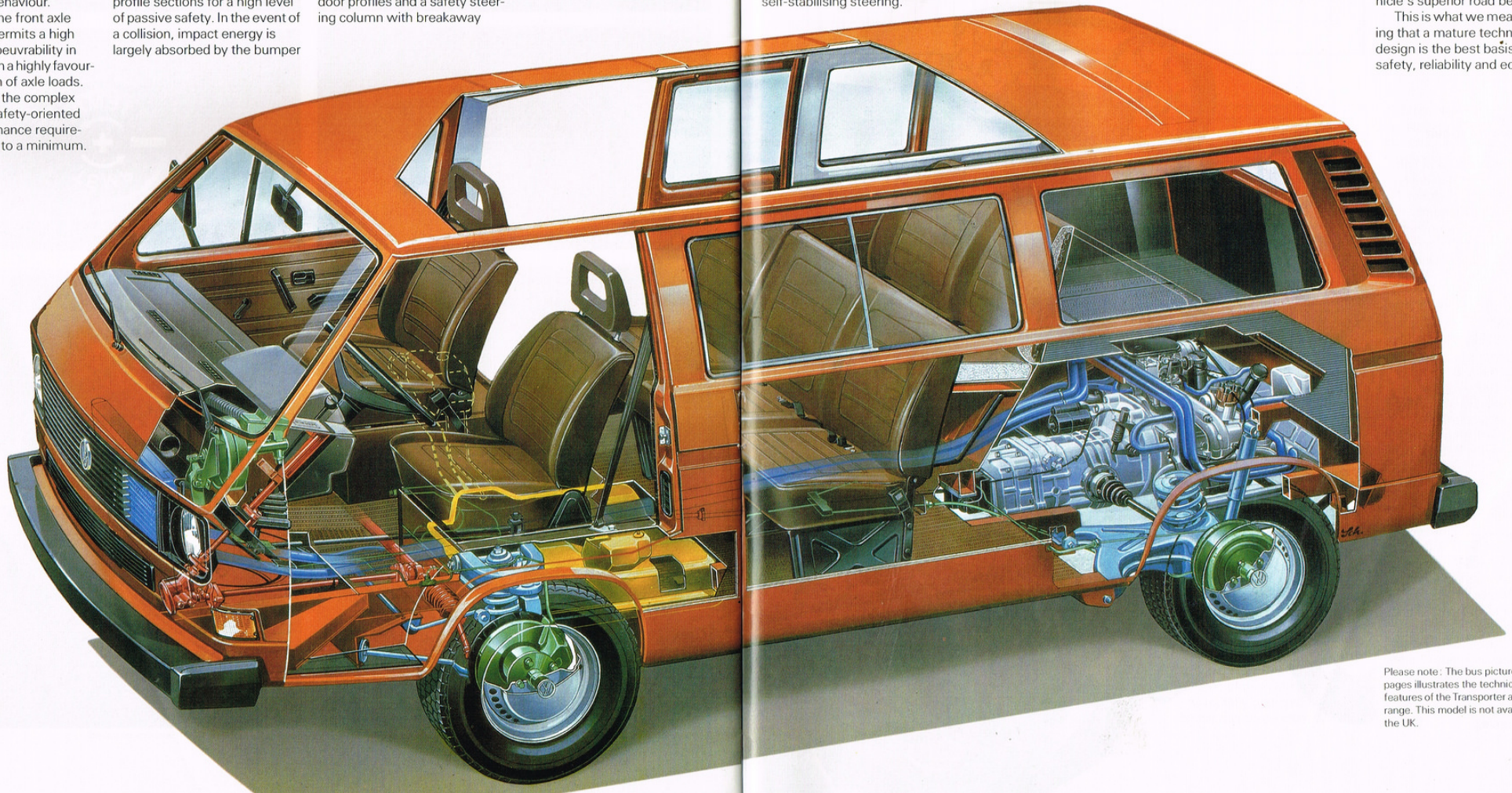

Please note: The bus pictured on these pages illustrates the technical design features of the Transporter and Caravelle range. This model is not available in the UK.

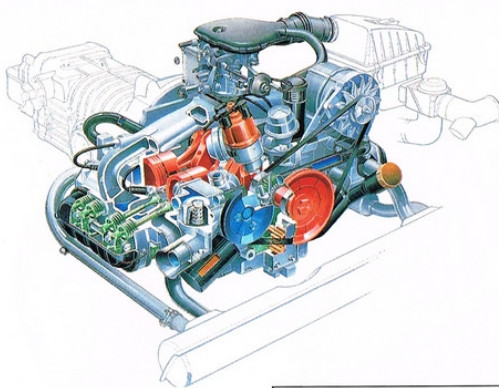

4-cylinder spark ignition engine (watercooled, horizontally-opposed), displacement: 1,913 cm³, compression ratio: 8.6 : 1, output: 44 kW (60 bhp) at 3,700 rpm. Maximum torque: 140 Nm at 2,200 rpm.

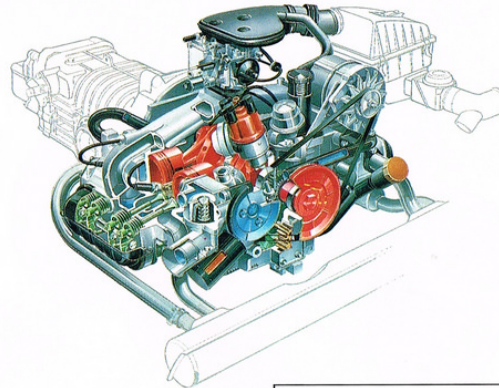
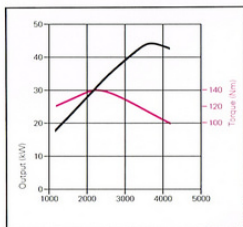

4-cylinder spark ignition engine (watercooled, horizontally-opposed), displacement: 1,913 cm³, compression ratio: 8.6 : 1, output: 57 kW (78 bhp) at 4,400 rpm. Maximum torque: 150 Nm at 2,600 rpm.

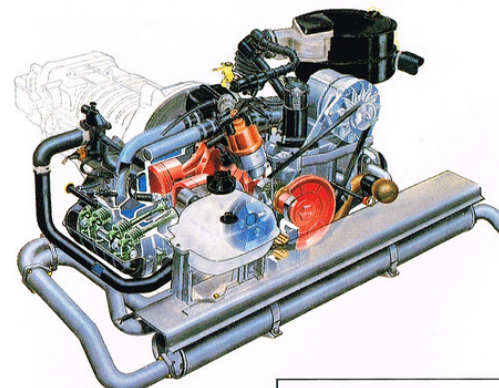
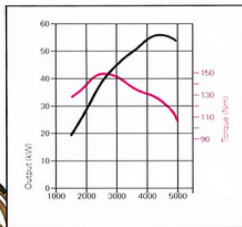

4-cylinder spark ignition engine (watercooled, horizontally-opposed), displacement: 2,109 cm³, compression ratio: 10.5 : 1, output: 82 kW (112 bhp) at 4,800 rpm. Maximum torque: 174 Nm at 2,800 rpm.

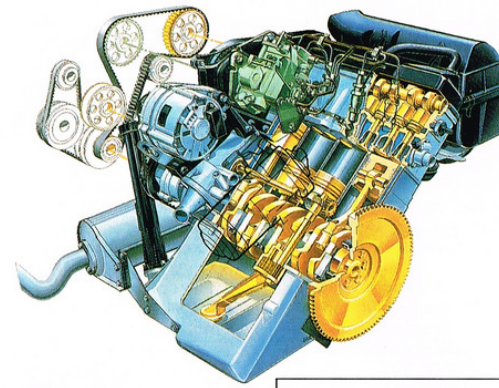
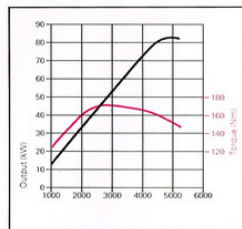

4-cylinder diesel engine, displacement: 1,588 cm³, compression ratio: 23.0 : 1, output: 37 kW (50 bhp) at 4,200 rpm. Maximum torque: 103 Nm at 2,000 rpm.

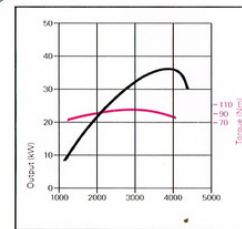

**The engines:
A drive concept to suit every need.**

This section will be of particular interest to all those who seek a Volkswagen tailored exactly to their own needs. Because at Volkswagen, not only the equipment options but the engines too are designed to cover a full range of operating conditions.

Take for instance the 1.6 litre turbocharged diesel engine, developing 51 kW (70 bhp). This unit represents a technical advance on the successful normally-aspirated diesel engine, combining two apparently incompatible properties:

It produces high performance but remains scrupulously economical. Because even at low engine speeds, it offers surprisingly good traction (for instance when towing a trailer), while its noise level remains very low. The combination of these factors makes the turbo-diesel ideal for almost every set of requirements.

Now for the 44 kW (60 bhp) spark ignition engine. A 4-cylinder unit which is quite content to run on regular-grade (2-star) fuel. This economical, quiet engine is the most attractively-priced version for these Volkswagen models.

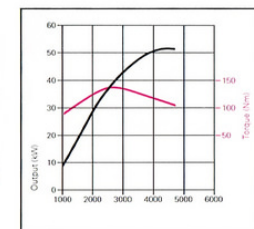
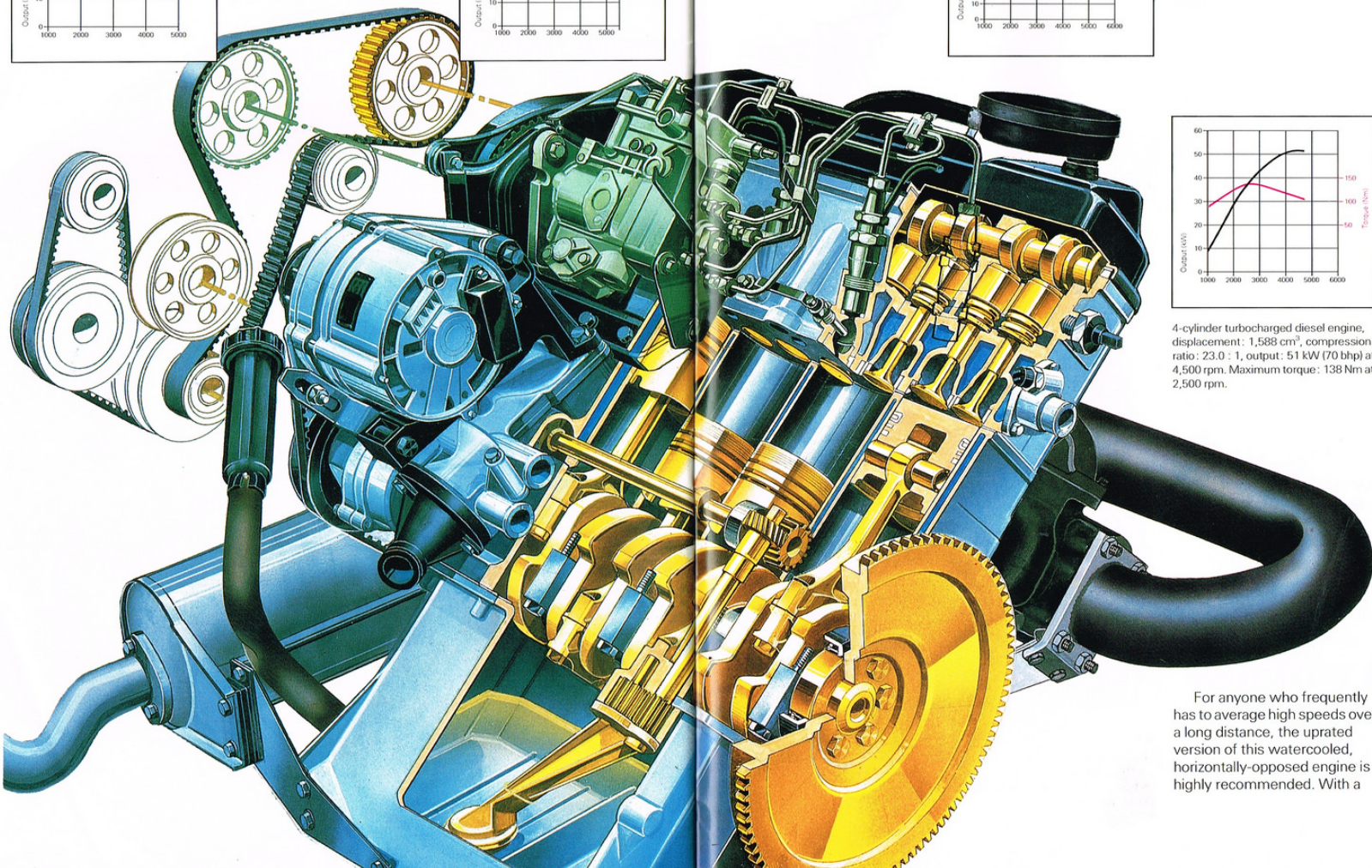

4-cylinder turbocharged diesel engine, displacement: 1,588 cm³, compression ratio: 23.0 : 1, output: 51 kW (70 bhp) at 4,500 rpm. Maximum torque: 138 Nm at 2,500 rpm.

displacement of 1.9 litres and developing 57 kW (78 bhp), it can attain high speeds while remaining quiet and economical.

Those who set very high standards where performance and traction are concerned will find the 2.1 litre fuel injection engine developing 82 kW (112 bhp) (premium-grade/4-star fuel) the most interesting option. It has a digitally-controlled fuel injection system (Digijet), is immensely free-revving and is fitted with a 5-speed gearbox as standard.

Last but not least, the trusty 1.6 litre diesel engine, with an output of 37 kW (50 bhp) and distributor-type fuel injection pump. This highly economical version has proved its worth a million times and more. It is an established favourite for short-distance operation since its very low fuel consumption minimises operating costs.

Whichever engine you choose for your Caravelle or Transporter, you can rest assured that these thoroughly-tested, economical units represent the latest in technological design. For many miles of reliable driving.

For anyone who frequently has to average high speeds over a long distance, the uprated version of this watercooled, horizontally-opposed engine is highly recommended. With a

Corrosion protection treatment:

Quality in detail.
For Volkswagen, the notion of quality standards means more than just advanced technology geared towards achieving safe handling. It means providing optimum corrosion protection for maximum durability. A challenge which we have met right down to the tiniest of details.

The first step consists of a careful selection of materials. All bodysheath sections which are particularly exposed to corrosion, especially doors and covers which have to withstand extremely severe conditions, are always manufactured of sheet steel which is galvanised on one or both sides.

Once assembled, the whole bodysheath is passed through the cathodic dip primer coating to protect it against rusting under the paintwork.

As a result of this electrolytic process, all sections, including body cavities and interior surfaces, receive a fine protective coating.

Particularly exposed areas such as edges and corners automatically receive a much thicker protective coating.

The next step involves protecting the bodywork against damage from flying stones.

The whole floor pan, interior doors and front panel – in other words, all exposed areas

– are given a particularly resilient intermediate coating to protect them against chipping, before receiving a PVC coating or special paint finish to resist stone chips.

A plastic sealant is applied to all joint seams.

Cavity protection treatment using the airless spray method is only carried out once the paintwork is finished, to ensure that all parts of the body cavities are evenly coated.

As a final step, the whole floor pan, including wheel arches and suspension elements, is protected against damp by a wax and PVC coating.

The result: a level of quality which provides a guarantee of reliability, high value retention and a lengthy operating life.

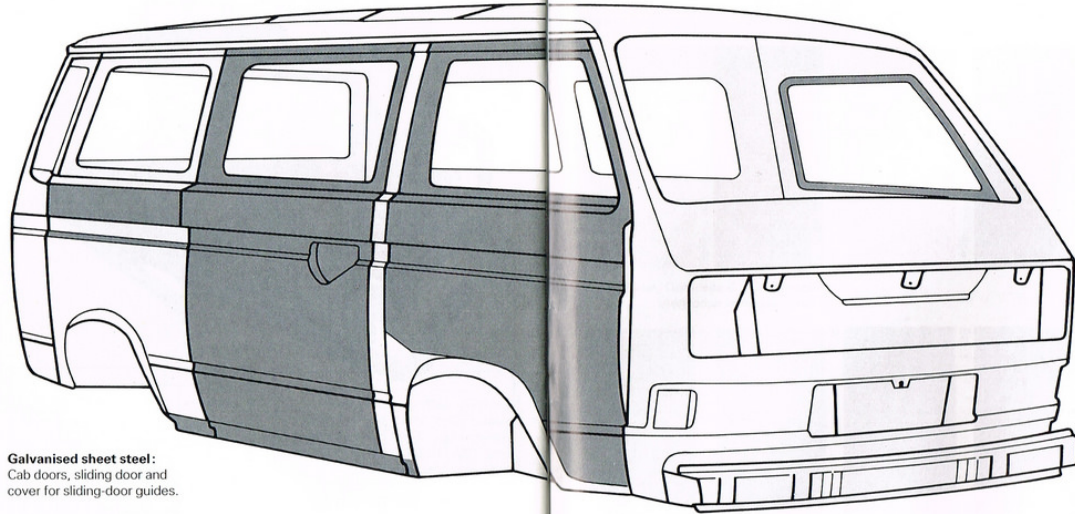

Galvanised sheet steel:
Cab doors, sliding door and cover for sliding-door guides.

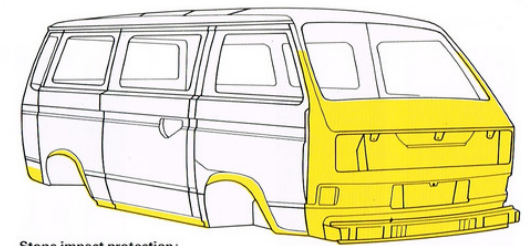

Stone impact protection:
Front section and wheel arches.

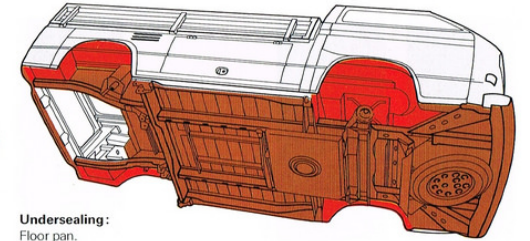

Undersealing:
Floor pan.

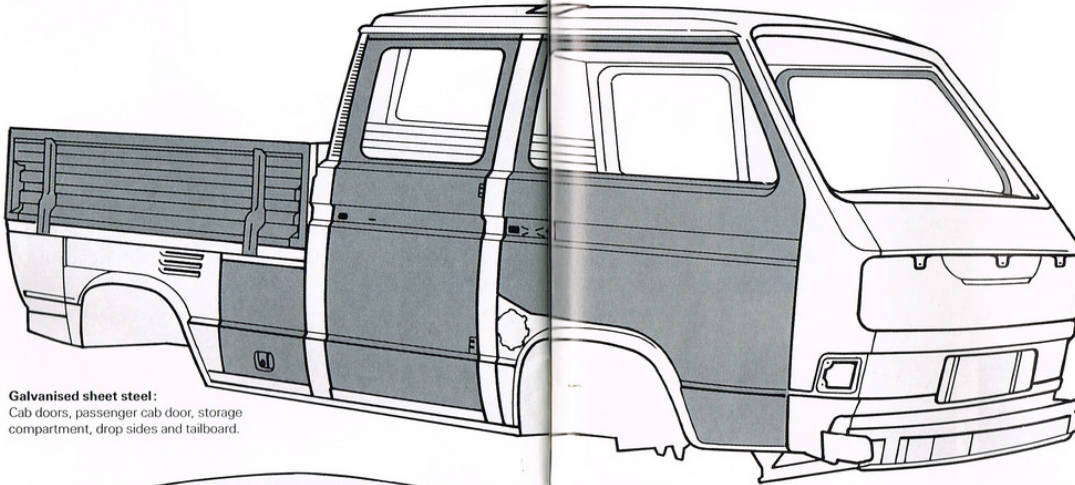

Galvanised sheet steel:
Cab doors, passenger cab door, storage compartment, drop sides and tailboard.

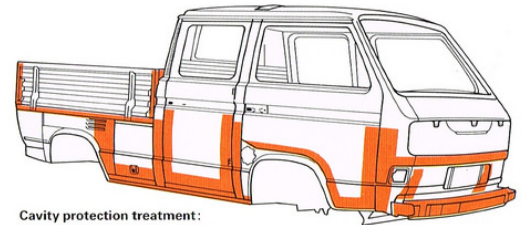

Cavity protection treatment:
Doors and flaps, lower body section on inside.

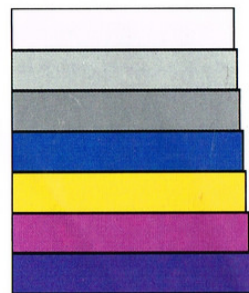

Paintwork buildup: body

- Sheet metal
- Dip degreasing
- Zinc phosphating
- Cathodic primer
- Stone impact protection (partial)
- Filler coat
- Top coat

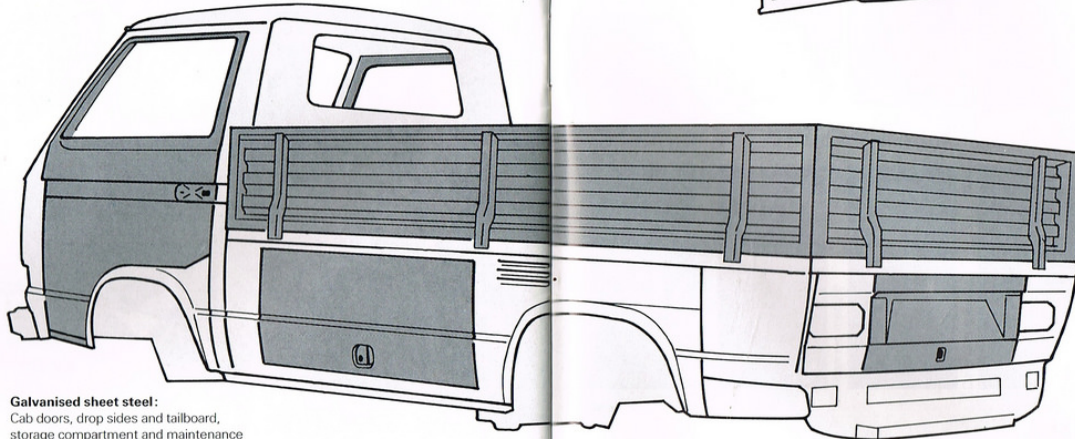

Galvanised sheet steel:
Cab doors, drop sides and tailboard, storage compartment and maintenance access cover.

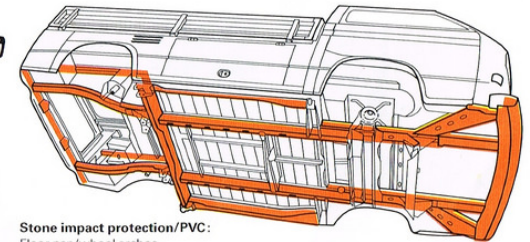

Stone impact protection/PVC:
Floor pan/wheel arches.



Paintwork buildup: floor pan

- Sheet metal
- Dip degreasing
- Zinc phosphating
- Cathodic primer
- Stone impact protection (partial)

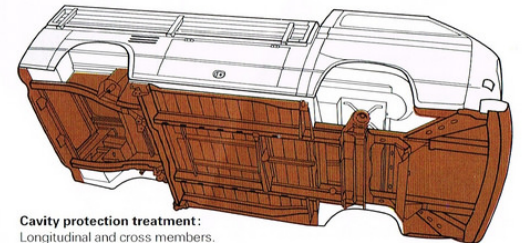

Cavity protection treatment:
Longitudinal and cross members.

Upholstery fabrics

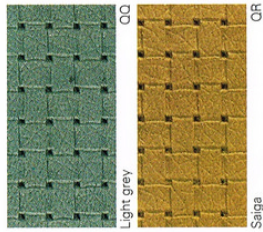

Transporter
Leatherette seat upholstery

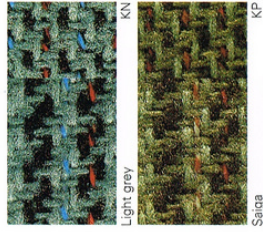

Caravelle CL
Cloth seat upholstery

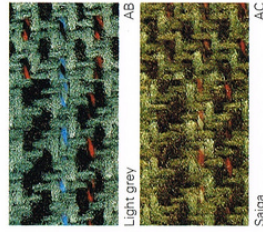

Transporter
Cloth seat upholstery

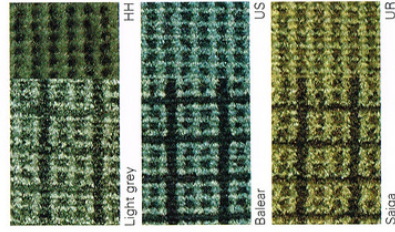

Caravelle GL
Velour seat upholstery



Caravelle C
Leatherette seat upholstery

Paint finishes

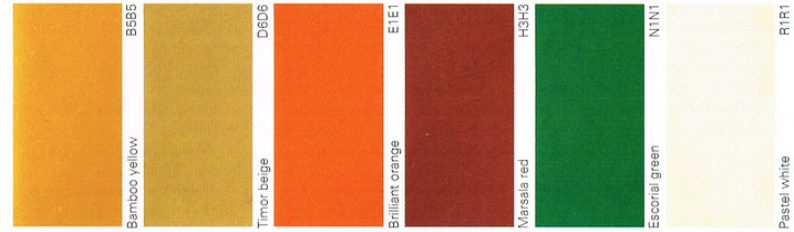

Transporter, Caravelle C

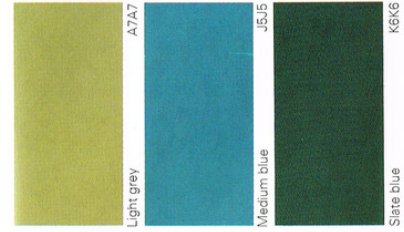

Transporter

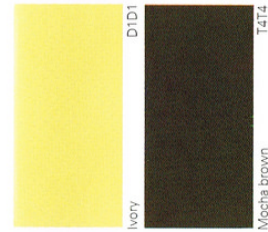

Caravelle C

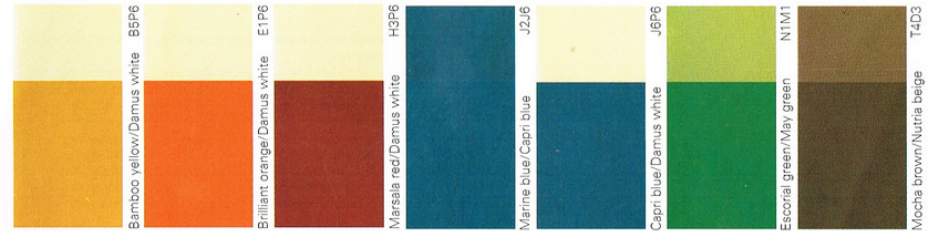

Caravelle CL



Caravelle GL

Possible colour combinations		Leatherette seat upholstery		Cloth seat upholstery		Leatherette seat upholstery		Cloth seat upholstery		Velour seat upholstery	
		OO	QR	OO	QR	OO	QR	OO	QR	HH	US
● Standard											
○ Special Order											
Paintwork colours											
A7A7	Light grey										
B5B5	Bamboo yellow										
D1D1	Ivory										
D6D6	Timor beige										
E1E1	Brilliant orange										
H3H3	Marsala red										
J5J5	Medium blue										
K6K6	Slate blue										
N1N1	Escorial green										
R1R1	Pastel white										
T4T4	Mocha brown										
B5P6	Bamboo yellow/Damus white										
E1P6	Brilliant orange/Damus white										
H3P6	Marsala red/Damus white										
J2J6	Marine blue/Capri blue										
J6P6	Capri blue/Damus white										
N1M5	Escorial green/May green										
T4D3	Mocha brown/Nutria beige										
S8S8	Savannah beige metallic										
W4W4	Titan red metallic										
X2X2	Dove grey metallic										
X4X4	Bronze beige metallic										
X9X9	Flash silver metallic										
Transporter											
Transporter											
Caravelle C											
Caravelle CL											
Caravelle GL											

Note on paint finishes:
The illustrations on these pages are only intended as a general indication, since the printing process cannot reproduce the full intensity and brilliance of the paint finishes or the textures of the upholstery fabrics.

Volkswagen dealers for commercial vehicles can help you choose and purchase the right vehicle and provide comprehensive, reliable after-sales support too.

Information before buying:

Your Volkswagen commercial vehicle dealer will be glad to advise you of the different methods of purchasing or leasing a vehicle. He can also offer a competitive contract hire package.

After-sales support:

Volkswagen commercial vehicle service points offer the following advantages:

- An extensive network of workshops all over the world. The nearest service depot is never far away, saving you both time and money.
- Specially-equipped workshops with experienced, well-trained specialist personnel.
- Comprehensive stocks of genuine Volkswagen new and exchange parts.

Just a selection from a wide range of services aimed at keeping your commercial vehicle operational at all times, in order to reduce periods when it is out of action to a minimum.

Servicing and Warranty.

All Transporter and Caravelle models require lubrication services as follows:

- Every 5000 miles for diesel vehicles.
- Every 10,000 miles for petrol vehicles.

A major service is required every 20,000 miles.

If vehicle does not cover 20,000 miles annually there is an additional inspection every twelve months.

Diesel vehicles also require an initial inspection at 1000 miles.

All new Transporter and Caravelle models carry a 12 month unlimited mileage warranty.



**Volkswagen —
quality you can rely on.**

This brochure is intended to show the general appearance of the Volkswagen Transporter and Caravelle range.

During the origination of this brochure, the manufacturer's illustrations depicted left hand drive vehicles. However, to facilitate the brochure's application within the United Kingdom, the illustrations have undergone a process that makes possible the presentation of right hand drive vehicles. The process involves the "reversing" of negatives and as a result some minor items of specification have become slightly mispositioned. Due to a continuous process of modification by the manufacturer, some changes in specification may occur after the publication of this brochure. Kindly confirm specification with your authorised Volkswagen dealer at the time of placing your order. The details given in this brochure relate to models of the 1987 model year.

V.A.G (United Kingdom) Limited, Commercial Vehicle Division,
Frankland Road, Blagrove, Swindon SN5 8YU Tel: (0793) 40231 Telex: 444417