

MG

ZT | ZT-T

Demand more from life







PRESENCE. One powerful word that captures the essence of the new MG ZT and MG ZT-Ts.

BORN TO PERFORM. For MG engineers, a combination of engineering skill, dynamic set up and the right components are part of every MG they create. It's a concept that's just as familiar to MG drivers. Something that's instinctive. A feeling that's pure MG.





The first hundred metres in the new-look MG ZT or MG ZT-T shows you exactly what high-performance living – and driving – is all about. Everything from those redesigned sleek bumpers to the brand new alloy wheels, imposing mesh grille and distinctive new headlamps have a bold and confident stance that perfectly matches the driving experience.

The MG ZT and MG ZT-T seamlessly combine sophistication with the kind of unadulterated pleasure that is drawn directly from MG's racing and engineering heritage. A heritage that, in 2004, celebrates 80 glorious years of uncompromisingly high performance.

You don't park an MG, you simply allow it to rest until next time. You see, for an MG driver, the enjoyment, power and affordability make MG a choice from the heart just as much as the head. Because, for an MG ZT owner, it's about high-performance living.



DYNAMIC HANDLING.

There's more to MG than just sheer road presence. These are cars born of passion, developed by people who understand that to create an MG is to mould not just a car, but a lifestyle that's built around high performance.





And that means that the new style MG ZT and MG ZT-T have been created by integrating exceptional engines with extraordinary chassis and suspension systems to deliver cars of outstanding dynamic ability; MG simply would not accept anything less. Feed an MG ZT through a

tightening radius and the combination of balance and grip will demonstrate that MG can be both a rewarding cruiser and a sporting thoroughbred. You don't just take to the road in an MG ZT, you dominate it, from its most challenging curves to its most bruising bends.

MG offers an alternative, the antidote to the anodyne life so many people lead; the new style MG ZTs allow individuals to express their individuality and stand out from the crowd. Settle behind the wheel and drive; delight in balance and weighting you didn't think possible from a car with power steering; marvel at the car's limpet-like grip and micro-adjustable handling balance. High-performance road-car dynamics at their best.





Responsive and instantly available acceleration make an ideal partner to such a capable chassis system, but being MGs, performance is tamed by extraordinarily efficient braking. And the foundation for such excellence – an exceptionally rigid body structure – essential for a car designed to be driven.





888 OHA

TRUE MG POWER. All MG Power units combine quick-witted response with a velvety smooth punch and a classic multi-cylinder harmonic soundtrack – to deliver a true MG drive.



790

Any memorable performance is as much about delivery as it is about the underlying script. MG knows true lovers of the art of high-performance living will have their own preferred style of delivery. That's why the MG ZT and MG ZT-T provide a range of engine formats and transmissions, each of which says 'urgent' with a different nuance.

Step into the awesome V8 rear wheel drive 260, and 60mph flies by in a mere 6.2 seconds; the front wheel drive versions are equally impressive, with the 190 V6 despatching the same milestone in only 7.7 seconds. Four camshafts, 24 valves and an aluminium-alloy construction showcase MG's mastery of V6 engine technology. These units combine quick-witted response with a symphonic multi-cylinder soundtrack to ensure MG ZTs are cars that can truly satisfy all your senses.

For efficient power, little matches the 160. The low emission 1.8 Turbo serves up heavyweight overtaking punch whenever you need it and featherweight fuel economy when you don't.

The naturally aspirated 1.8i 16V 120Ps offers the optimum blend of power and practicality, providing affordable access to the MG ZT family. And to stretch a tank still further, try the renowned CDTi powerunits – engines that will redefine your diesel paradigm. With double overhead camshafts, four valves per cylinder and an intercooled turbocharger, the units are based around a high-tech common rail injection system complemented with pilot injection. These power units offer exceptional fuel consumption for serious long distance stamina, fewer emissions and a quiet refinement you surely weren't expecting. The auto alternatives are just as driver focused with auto availability on the 180 Sports Auto and the CDTi.

MG ZT 190

Torque (Nm)

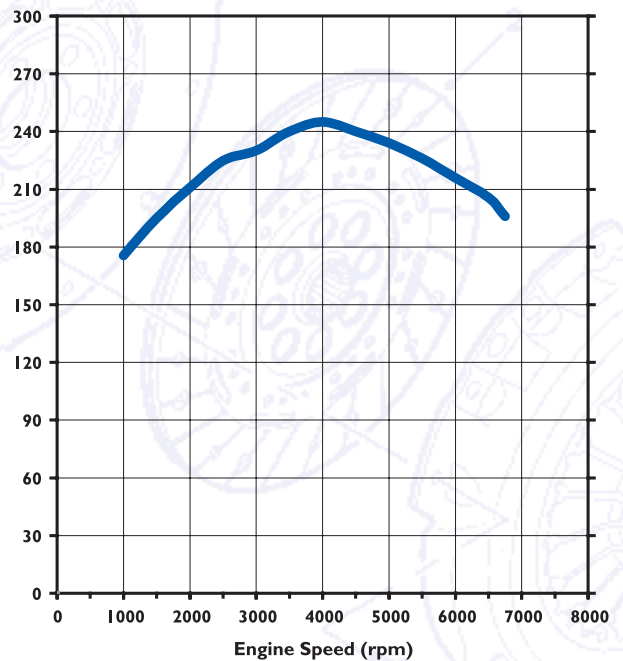

Max Torque: 245 Nm @ 4000 rpm
(corrected to EC test standard)

MG ZT 190

Power (Ps)

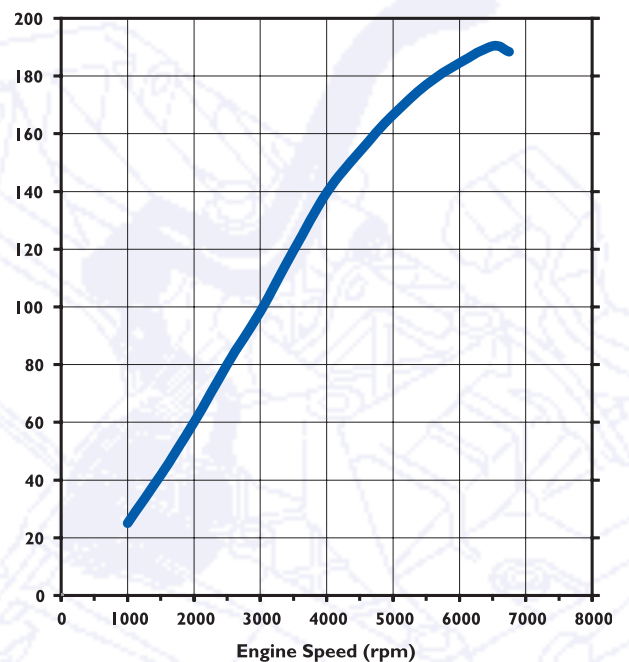

Max Power: 190 Ps (140 kW) @ 6500 rpm
(corrected to EC test standard)

POWER RANGE. Understanding the needs of a customer is something very close to the hearts of the people at MG.

That's why the choice of power options available is as broad as it is. The extraordinarily affordable MG ZT and MG ZT-T 120, with their low emission 120Ps twin-cam engines; the Jekyll and Hyde 160 1.8 Turbo; and the CDTi models – available with a choice of power outputs including a high power 131Ps version – are purposely designed to be as adept at minimising both environmental impact and tax burdens alike. For all its muscle, the



1.8 Turbo is one the most fuel-efficient in its class and produces one of the lowest CO₂ outputs. Similarly, the MG ZT's CDTi diesel engines deliver great dollops of torque to provide a thrilling drive, and punch well above their weight when it comes to the fuel pumps. These cars exude all the ability and sporting nature of their higher-powered brothers, adding to the MG ZT and MG ZT-T range without diluting it. Need any more persuasion?



V8

A PASSION TO PERFORM.

This is not for the faint-hearted. Revel in the seamless response of the finely balanced chassis to the enormous torque of the 4.6 litre V8.





V8

**POWER
MG HANDLING.**



The whopping 4.6 litre V8 engine in the MG ZT 260 and MG ZT-T 260, developed with the help of the V8 performance experts at Roush Industries, provides these cars with their full title and delivers a uniquely mature, muscular interpretation of true high performance.

You'll need to be on an Autobahn to appreciate the top speed – electronically limited to an awesome 155mph. Elsewhere, you'll love the fact that you're just 6.2 seconds away from reaching 60mph from

rest. But then, what else would you expect from a monster that can deliver 260Ps at 5000 revs and 410 Nm?

Remember opposite lock? Still want to live life to the absolute max? You'll love the new-look **MG ZT** and **MG ZT-T V8**. Two rear-wheel drive cars designed and engineered to fulfil the desires of true driving obsessives.



MG ZT 260 POWER CHART

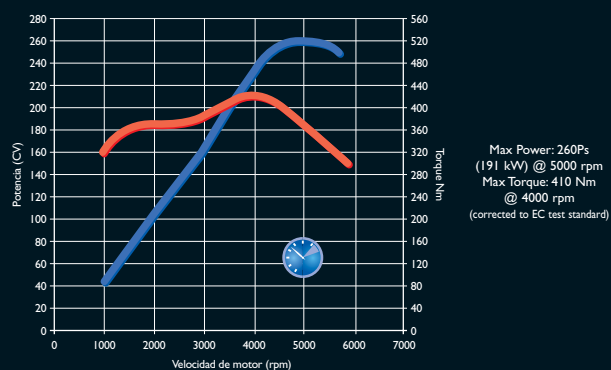

The muscular engine is only half the story. The chassis has been completely re-engineered to provide optimum performance. The all-new multi-link rear axle has been designed to work seamlessly with the Hydratrak limited slip differential, ensuring perfect balance at all times. Whilst up-front, the inverted monotube McPherson strut suspension and a new steering system provide the ultimate in cornering feedback to the pilot.

Four tailpipes, discreetly shrouded by race-inspired bumper heatshields, provide a strong hint of the car's potential. They're also

evidence of a low-loss stainless steel exhaust system. With reassuringly fast-acting 4-channel ABS as standard, 18" alloys, a 5-speed manual gearbox and the usual MG interior refinements, this car pulls no punches in any department.

Move up to the MG ZT SE or ZT-T SE models and you'll also be treated to leather electric seats, a rain-sensing wipe system, Highline satellite navigation, extra protection from head airbags, a rear view mirror that automatically dims when it senses headlights behind, a CD autochanger and a teletext-equipped TV.



COMFORT WITHOUT COMPROMISE.

There's a very fine line drawn between what makes a car perform well and what makes a car comfortable after long hours in the driving seat.

Usually the trade-off is a simple one; if you want a car to handle it has to be stiff, and stiff generally means uncomfortable and uncouth.

Not so for the MG ZT and MG ZT-T. You know in the first mile that the MG ZT and MG ZT-T are heavily into performance, but the damping exactly complements the rates of the springs, which are themselves precisely matched to the kinematics and compliance of the car's exceptional suspension systems to deliver a superbly controlled ride. ZT drivers are privileged with a subtle but faithful report of the road's surface without assaulting you with it. This tactile map ensures the pleasure of making progress in a ZT never becomes a task.

All ZTs and ZT-Ts share the same dynamic assets; flat cornering with exceptionally low body-roll; class-leading body control that simply leaves the suspension to do what it was designed for – cornering with eye-widening velocity – without having to worry about the car lurching in response to spurious inputs. They are cars which revel in communication with the driver at all levels; communication about how the tyres are working with the road surface to deliver maximum control; about the right balance of steering and throttle input to refine the car's attitude and trajectory; about the stopping power of the Bosch equipped ABS brakes. These are cars that embody the natural flair of MG's obsessive engineers; cars created to meet the demands of high-performance living.





GET A GRIP.

Start with highly sophisticated front and rear suspension systems; refine these through advanced computer modelling and highly skilled race-bred development insight. Mate these to the incredibly rigid platform of the MG ZT and MG ZT-T bodysells and you've got the foundations for these cars' leading-edge roadholding, ride control, handling balance and precision and safety.

MG obsesses on precision and purpose. The front suspension uses rear-facing L-shaped lower arms with special bushes for critically accurate toe control. And with the option to uprate to sports settings, you can really tune the MG ZT to complement your needs; the entire front suspension and steering rack rides on a hugely stiff peripheral subframe that's rigidly mounted to the body to eliminate unwanted compliance.

Translation: sharp, accurate steering right through the working range. And to keep the car flowing down the road without a trace of float or heave, the McPherson struts use gas-filled dampers and auxiliary rebound springs, tuned in conjunction with the unusually high rate roll bars for excellent body control.

Factor in MG's motorsport-backed experience and sheer passion for sporting driving and then you've unlocked the secret of the MG ZT's and MG ZT-T's leading-edge handling.



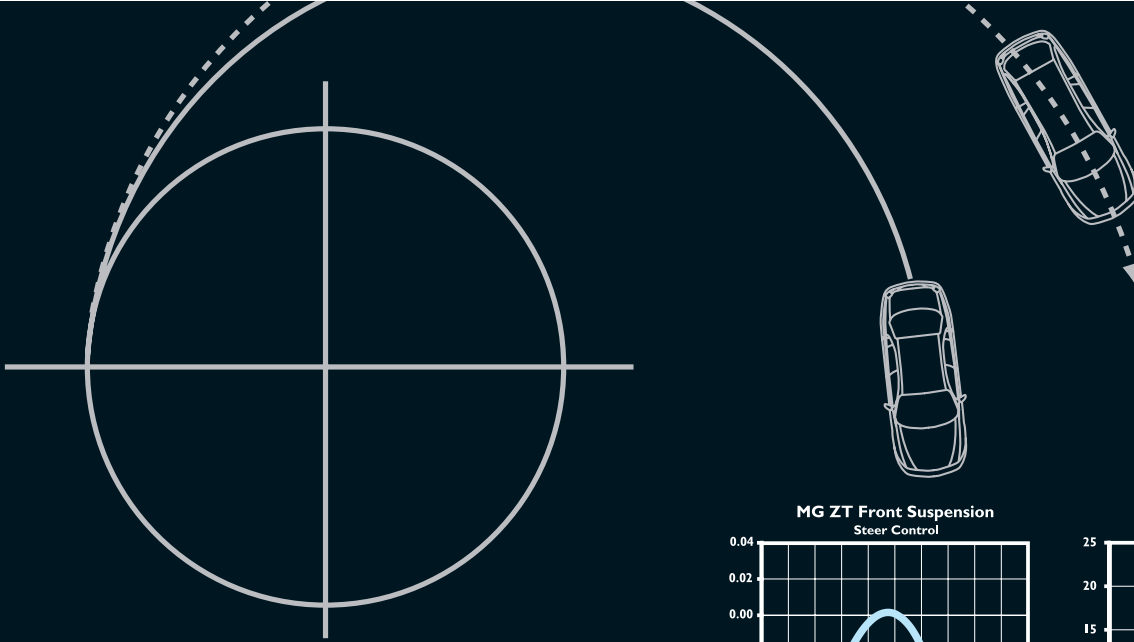

The front wheel drive MG ZT and ZT-Ts use the renowned Z-axle multi-link system to assure huge grip, superbly consistent handling and a controlled ride.

The rear-wheel drive V8s, the ingenious Hydratrak limited slip differential works with the all-new multi-link axle to manage the huge torque on offer from the 4.6 litre engine and provide perfect balance at all times.

On all models, the fast ratio power-assisted rack-and-pinion steering has sports calibration, giving it the superb feedback to inspire driver confidence right up to the limits. There can be no room for doubt in the brakes either. Every car gets a brake specification that ensures stopping power. Stop after stop stays supremely confident, capable of bringing, for example, the MG ZT 190 safely from 60 to 0mph in just 2.5 seconds.

On the MG ZT 260, 190, 180 Sports Auto and CDTi models the optional traction control ensures that there is always grip, no matter what the conditions. Standard 18-inch[†] alloy wheels run 225/45 ultra-low profile tyres. Their look speaks of serious grip and security. On the MG ZT and MG ZT-T, they speak the truth.

[†] optional on the 120

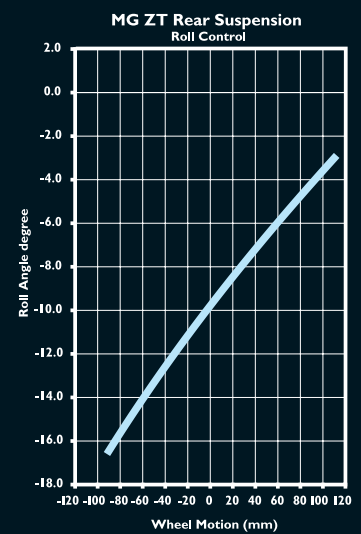
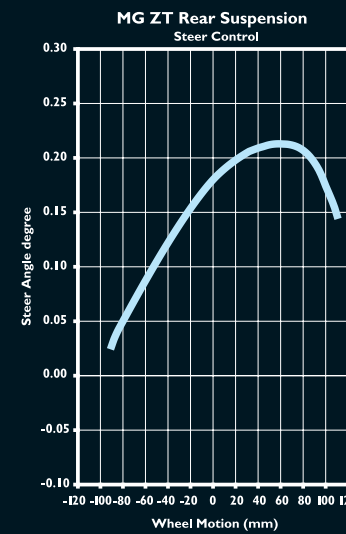
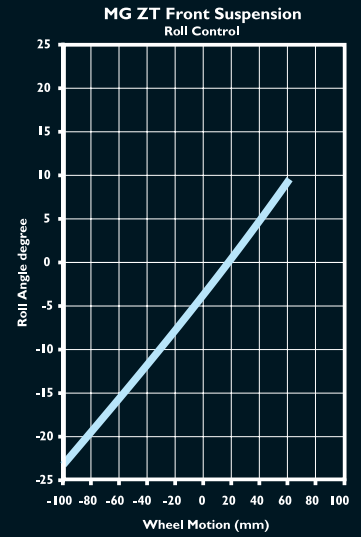
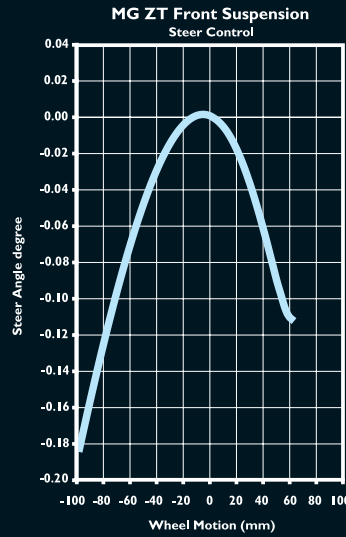



BEHIND THE WHEEL.

Sitting behind the wheel of an MG ZT feels intimate. Like it's been waiting for you to arrive.

There's a definite sense of driving exhilaration in here. The all-new, subtly textured metallic, 'Technical' style of the fascia finish. The bolstered steering wheel, the well-spaced pedal box and the gear lever that seeks out your palm. It all says one thing: MG.

Optional leather-bolstered seats grip the ribs, securing your body. The driver-focused but simple, crisp and distinctive backlit dials are clear and easy to read.



Choose the 180 Sports Auto SE or 190 SE and your investment will be rewarded with a stunningly comprehensive array of standard features. From map-display satellite navigation to the rain sensing wipers, auto-dimming rear view mirror and ultrasonic rear parking aids; or the new Trafficmaster® integrated trunk route congestion warning system. Perhaps the teletext equipped TV, or the message centre instruments and cruise control systems. Even the standard Xenon headlights feature dynamic range control. Not to mention the standard electric sports seats – trimmed discretely in black leather – of course. Equipment which conspires to make each drive as rewarding as possible.

Cast your eyes around the cabin and you'll see plenty to keep you happy, even if you choose not to raid the options list. There's a superbly bespoke feeling in the cabin, especially if you make use of the Monogram programme. Don't forget to ask your dealer about the range of MG accessories including Hands Free Units to suit your needs. Execution is all, everything from the feel of the controls to the touch and appearance of the cabin has been designed to reflect the principles of High-Performance Living.





A combination of ergonomic design and high technology provides all the support the MG ZT and MG ZT-T driver deserves.

Think those seats have exaggerated side bolsters? You're forgetting the cornering force this car can generate. But they're also soundly designed for long-distance comfort.

A few seconds with the driving position adjustments will have you completely sorted; seat height and rake, lumbar support, the steering column's reach and rake, the lot. Leather-rimmed steering wheel, handbrake and gear lever take care of the palms of your hands. Whilst in the back, your passengers will be enjoying the improved access and extra freedom provided by the new, sculpted seats.





The airbagged steering wheel has buttons for fingertip audio control. Air conditioning is standard, or you can upgrade it to MG's set-and-forget Automatic Temperature Control climate system* that keeps your head cool whatever the weather's brewing outside. It regulates temperature, humidity and distribution of cabin air to the preferences you dial in.

The optional navigation system feeds from GPS satellites, providing you with pinpoint routing directions. The Highline Navigation system even complements its concise voice guidance with a crystal clear, colour screen display which offers variable scale road mapping or detailed instructions and turn-by-turn junction diagrams.

The MG ZT and MG ZT-T also make ample provision for five adults, providing head restraints and three-point seat belts for all. And they

back it up with a cabin punctuated with details: a fold-out cup holder, big door pockets, a storage box under the centre console armrest, reading lights and vents to the rear seats.

As a measure of integrity in a car your fingers are a valid instrument. So try the damped action of the ashtray and glovebox lids, the rattle-quelling liners for the storage compartments, the soft-feel fascia materials and smooth switch gear.

And style? Check the sculpted fascia and doors. Feel the depth and quality of upholstery. This is cut-above stuff, a level of visual and tactile sophistication signalling the engineering depth of the car beneath.

* Standard on the '+' and SE models.





VERSATILE SPACE.

Your life has many purposes; you play different roles.

You demand high performance every time. The MG ZT-T delivers the performance you need in all your different lifestyles. At the sharp end, a sophisticated sporting car. At the back, well, just how do you want to play it? Even before you fold a rear seat, there's a cavern back there. For lightweight objects, or when the floor is already cluttered, just pop open the rear window and drop things in. Otherwise, the whole tailgate arcs upward for an aperture 1110mm wide and 675mm high. For security, a roller blind covers the contents.

In the underfloor storage area you'll find the spare or puncture repair equipment, with a little more space for odds and ends, housed under a self-supporting lid with its own light. Bedding down behind other lids are optional accessories like the warning triangle, first-aid kit and other travel essentials including the CD autochanger if fitted. An optional (standard on MG ZT-T+ and SE) roll-up net clips to the roof lining, keeping loose luggage out of passengers' hair.

On the floor, eyelets provide secure lash-down points. They're spring loaded and flush fitting, by the way; it's nice to be reminded, everywhere you see and you touch it, that this car comes from engineers and designers who just can't help themselves. The load bay will swallow a box up to 1500 x 900 x 600mm, or 1500 x 700 x 670mm. And when the whole seat's forward, the load area stretches to a staggering 2060mm long. There's even provision to load longer items with the rear armrest load-through feature. With split-fold

flexibility, any likely proportion of passengers and luggage can be accommodated. Up top, optional low-drag roof rails are the foundation for a system of optional carriers that'll match pretty well any pursuit you have in mind: a range of ski and snowboard mounts, aerodynamic boxes, bike carriers, boat and windsurfer racks.

So the MG ZT-T's a car that matches every one of your lives and with a styling personality that's equally forceful. But it knows full well the driver in you never quietens whatever role you're playing. That's why the rear suspension's spring rates are re-calculated for load carrying, and mated to special digressive dual-rate dampers. It all keeps the MG ZT-T stable, responsive and level-riding whatever your mission.









SAFE AND SURE.

With a 4-star Euro NCAP safety rating, the MG ZT and ZT-T invite favourable comparison with many others in their class. The high rating is a result of careful design.

A fundamentally strong body shell, stemming from world-class calculation and testing methods, ensures energy-absorbing crush zones around the rigid, critical passenger cell in impacts of every type. Sophisticated welding techniques and high-strength steels are integral to the concept. And so is MG ZT and ZT-T's renowned body stiffness, ensuring leading-edge handling, roadholding, safety, cornering and a long life free from rattles.

Five three-point seat belts and head restraints are standard, with pre-tensioners in the front. The seats have anti-submarine bases. Frontal airbags for the driver and front passenger are given. So are side-impact thorax bags in each front seat. Finally, optional ITS airbags protect front occupants' heads in a side impact. But impact avoidance is an MG speciality.





The sheer grip and progressive response of the chassis is a perfect base. Wide tyres and untiring brakes, with ABS, play their part.

A plethora of details ensure fine visibility: high-output demisting, 'intelligent' wipers that vary their speed according to the car's velocity and optionally according to rainfall. An optional parking distance sensor system reassures mightily in cramped manoeuvres. The standard halogen projector headlamps pierce the night, but MG provides the option of superb high efficiency Xenon lamps with dynamic headlamp levelling to ensure their aim remains true, whatever the load and road conditions.

An immobiliser and leading-edge deadlocking system mount a secure guard on your MG ZT and MG ZT-T, and a volumetric alarm can be added as further deterrent.



MG ZT & ZT-T KEY STANDARD FEATURES



120 / 160 / 180 / 190 / CDTi

Interior trim and equipment

- Sports seats with Summit centre fabric
- Sports leather rimmed steering wheel
- Leather and alloy finish gearknob
- Perforated leather handbrake grip
- Technical Grey fascia and console finish
- Rear centre armrest
- Driver's seat height and lumbar adjustment
- Centre armrest with storage
- Rear seat load-through flap
- Bright door sill tread strips
- Passenger's fold-out cupholder

Exterior features

- Alloy wheels
- Sports suspension
- Halogen projector headlamps
- Parking lights
- Twin reversing lamps
- Heated door mirrors with powered adjustment
- Tinted glass
- Solar control rear window glazing

Safety equipment

- Four-channel ABS
- Electronic brakeforce distribution
- Laminated windscreen
- Two-part collapsible steering column
- Door side intrusion beams

- Four front airbags
- Adjustable front head restraints
- Three adjustable rear head restraints
- Automatic front seat belt height adjustment
- Front seat belt pretensioners and load limiters
- Three rear inertia reel lap and diagonal seat belts
- Front fog lamps
- Childproof rear door locks

Heating and Ventilation

- Air conditioning
- Rear compartment heating ducts
- Timed heated rear window with auto switch-on
- Pollen filter
- Side window demist
- Recirculation facility

Audio

- 4 x 20W CD-Tuner
- Six speakers
- RDS text
- Steering wheel volume and mode controls
- Screen-mounted aerial

Electrical features

- Halogen projector headlamps
- Electric front windows
- Front central dome interior lamp
- Twin directional front and rear interior lamps
- Courtesy light 'wake up' at unlock
- Courtesy light auto-on with engine off

MG ZT & ZT-T KEY STANDARD FEATURES



So what do you get for your money on a standard MG ZT or MG ZT-T? Well, let's just say that if you fancied a kitchen sink, there might not be room. The list is literally too long to make comfortable reading, but if you peruse the specification pages included here at your leisure you'll find that every need is catered for in the MG ZT range. As standard you find your MG with a leather and alloy gearknob, a centre armrest with central storage, pollen filter, front fog lamps, air conditioning and Summit trim and much else besides. After all, if you're going to spend as much time in your MG ZT as we think you'll want to, you need to make yourself comfortable.

- Courtesy light off delay
- Headlamp auto-return to dip beam
- Pathway illumination facility
- Lights-on warning chime
- Heated rear window with auto-on and timer
- Accessory socket provision
- Low fuel warning light
- Panel and switch illumination rheostat

Security

- Central door locking
- Plip controlled superlocking
- Single point entry facility
- Interior master locking switch
- Locking fuel filler flap
- Steering column lock
- Shielded door locks
- Perimetric alarm system
- Passive arming/disarming
- Visible second VIN label
- Interior bonnet release

Features unique to 120

- 17" '5-Spoke' alloy wheels
- Concealed rear exhaust

Features unique to CDTi / 160 / 180 / 190

- Exhaust cutout in bumper with heatshield finisher
- Twin exhaust with bright tailpipe finishers

Features unique to CDTi / 160 / 180

- 18" 'Grid Spoke' alloy wheels

Features unique to 180 / 190

- Ventilated rear disc brakes

Features unique to 190 / 260

- 18" '11-Spoke' alloy wheels
- Further updated braking and chassis specification

Additional features unique to 260

- Twin exhaust cutouts in bumper with heatshield finishers
- Quad exhaust with bright tailpipe finishers
- V8 badging
- Automatic temperature control air conditioning
- Instant Tyre Repair system
- Volumetric alarm
- Battery back-up for alarm sounder

Features unique to ZT

- One-piece folding rear seat backrest
- Storage compartment in rear centre armrest
- Double-hinged boot lid for wide opening and easy access
- Internal electric boot release button
- Rear lip spoiler

Features unique to ZT-T

- 60/40 split folding rear seat backrest
- Retractable carrying hooks in loadspace sidewall
- Loadspace floor lashing points
- Roller blind loadspace cover
- Plip unlock of tailgate and tailgate glass
- Opening tailgate glass
- Rear wash-wipe with auto-on in reverse
- Illuminated underfloor loadspace compartment

'+' models – additional features

- ATC (automatic temperature control) air conditioning (full climate control with individual front temperature controls and adjustable rear vents)
- CD autochanger and radio cassette player (instead of CD-Tuner)
- Electric rear windows
- Loadspace safety net (ZT-T only)

SE (Special Equipment) models – additional features

- ATC (automatic temperature control) air conditioning (full climate control with individual front temperature controls)
- CD autochanger and radio cassette player (instead of CD-Tuner)
- Electric rear windows
- Loadspace safety net (ZT-T only)
- Cruise control
- Traction control (260 only)
- Front side head airbags
- 'Apex' (18") alloy wheels with shadow finish
- Space-saver spare wheel (except 260)
- Highline satellite navigation
- Rear tweeters
- Powered glass slide/tilt sunroof with blind and one-shot function
- Black leather seat facings
- Heated front seats
- Powered front seat adjustment including driver's height adjustment
- Front seatback map pockets
- Message centre instruments with trip computer
- Auto-dimming rear view mirror
- Rain sensing wiper system
- Rear parking distance sensors
- Trafficmaster® Traffic Alert
- Xenon gas discharge headlamps
- Dynamic headlamp levelling
- Headlamp powerwash
- Heated screen washer jets
- Battery back-up for alarm

MG ZT VITAL STATISTICS

ENGINES

	MG ZT 120	MG ZT 160	MG ZT 180 Sports Auto	MG ZT 190	MG ZT CDTi	MG ZT 131 CDTi	MG ZT 260
Engine type	1.8	1.8T	2.5V6	2.5V6	2.0 CDTi	2.0 CDTi	4.6V8
Transmission	Man	Man	Auto	Man	Man Auto	Man Auto	Man
cc	1796	1796	2497	2497	1951	1951	4601
Maximum power Ps	120	160	177	190	116	116	260
@ rpm	5500	5500	6500	6500	4000	4000	3500
Maximum torque Nm	160	215	240	245	260	260	300
@ rpm	4000	2100	4000	4000	2000	2000	1900
Max. engine speed rpm	6750	6750	6750	6750	4900	4900	4900

PERFORMANCE

	MG ZT 120 1.8	MG ZT 160 1.8T	MG ZT 180 Sports Auto	MG ZT 190 Man	MG ZT CDTi Man	MG ZT CDTi Auto	MG ZT 131 CDTi Man	MG ZT 131 CDTi Auto	MG ZT 260 Man
0-60mph (secs)	10.9	8.5	8.9	7.7	11.0	12.2	10.3	11.0	6.2
30-50mph in 4th (secs)	8.7	7.0	-	6.5	8.1	-	7.3	-	5.5
50-70mph in 4th (secs)	9.7	7.3	-	6.4	8.0	-	6.8	-	5.5
Top speed (mph)	121	132	134	140	120	118	120	118	155

FUEL ECONOMY

	MG ZT 120 1.8	MG ZT 160 1.8T	MG ZT 180 Sports Auto	MG ZT 190 Man	MG ZT CDTi Man	MG ZT CDTi Auto	MG ZT 131 CDTi Man	MG ZT 131 CDTi Auto	MG ZT 260 Man
Urban cycle (mpg)	26.6	24.8	17.7	19.6	36.5	28.3	35.0	28.3	15.8
Urban cycle (l/100km)	10.6	11.4	16.0	14.4	7.7	10.0	8.1	10.0	17.9
Extra-urban (mpg)	46.3	45.6	35.9	38.4	60.7	54.7	63.6	54.7	27.2
Extra-urban (l/100km)	6.1	6.2	7.9	7.4	4.7	5.2	4.4	5.2	10.4
Combined (mpg)	36.2	34.9	26.0	28.4	48.8	40.9	48.8	40.9	21.5
Combined (l/100km)	7.8	8.1	10.9	9.9	5.8	6.9	5.8	6.9	13.2
CO ₂ (g/km)	184	194	259	239	163	190	163	190	314

GEAR RATIOS

	MG ZT 120 1.8	MG ZT 160 1.8T	MG ZT 180 Sports Auto	MG ZT 190 Man	MG ZT CDTi Man	MG ZT CDTi Auto	MG ZT 131 CDTi Man	MG ZT 131 CDTi Auto	MG ZT 260 Man
Gearbox type	Man	Man	Auto	Man	Man	Auto	Man	Auto	Man
5th	0.809	0.809	0.685	0.809	0.686	0.685	0.686	0.685	0.730
4th	1.029	1.029	0.854	1.029	0.919	0.935	0.919	0.935	1.000
3rd	1.348	1.348	1.247	1.348	1.292	1.364	1.292	1.364	1.330
2nd	2.022	2.022	1.948	2.022	2.022	2.131	2.022	2.131	1.990
1st	3.577	3.577	3.474	3.577	3.577	3.801	3.577	3.801	3.370
Reverse	3.308	3.308	2.714	3.308	3.308	2.970	3.308	2.970	3.615
Final drive ratio	4.412	4.167	3.89	4.412	3.737	3.450	3.737	3.450	3.460
mph per 1000 rpm in 5th	20.7	22.2	28.1	21.0	29.2	31.7	29.2	31.7	29.7

MG ZT 190 POWER CHART

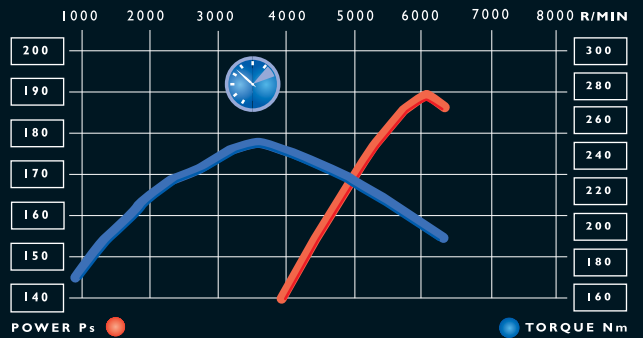

MG ZT 190 GEARING CHART

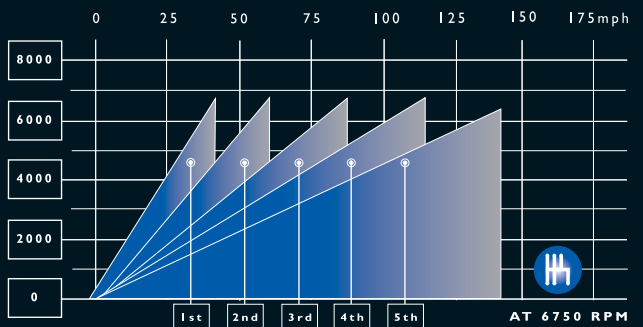

MG ZT 190 FUEL CHART

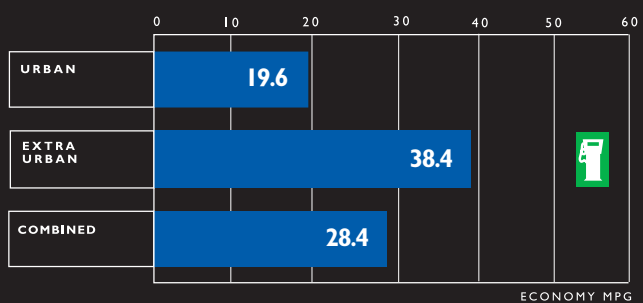

All fuel economy figures are in accordance with Directive 99/100/EC. They have been calculated using the same test cycle as used for official exhaust emission classification. They cannot be compared with the previous steady speed/urban figures and are more representative of actual on-road fuel consumption. Under normal use a car's actual fuel consumption figures may differ from those achieved through the test procedure, depending on driving technique, road and traffic conditions, environmental factors, and vehicle condition.



MG ZT-T VITAL STATISTICS

ENGINES

	MG ZT-TMG 120 1.8	ZT-TMG 160 1.8T	MG ZT-TMG 180 Sports Auto	MG ZT-TMG 190 Auto	MG ZT-T CDTi	MG ZT-T 131 CDTi	MG ZT-T 131 CDTi	MG ZT-T 260
Engine type	1.8	1.8T	2.5V6	2.5V6	2.0 CDTi	2.0 CDTi	2.0 CDTi	4.6 V8
Transmission	Man	Man	Auto	Man	Man	Auto	Man	Auto
cc	1796	1796	2497	2497	1951	1951	1951	4601
Maximum power Ps	120	160	177	190	116	116	131	131
@ rpm	5500	5500	6500	6500	4000	4000	3500	3500
Maximum torque Nm	160	215	240	245	260	260	300	300
@ rpm	4000	2100	4000	4000	2000	2000	1900	1900
Max. engine speed rpm	6750	6750	6750	6750	4900	4900	4900	4900

PERFORMANCE

	MG ZT-TMG 120 1.8	ZT-TMG 160 1.8T	MG ZT-TMG 180 Sports Auto	MG ZT-TMG 190 Auto	MG ZT-T CDTi	MG ZT-T 131 CDTi	MG ZT-T 131 CDTi	MG ZT-T 260
0-60mph (secs)	11.3	8.9	9.3	8.2	11.5	12.6	10.6	11.4
30-50mph in 4th (secs)	9.1	7.3	-	6.8	8.2	-	7.5	-
50-70mph in 4th (secs)	10.2	7.6	-	6.7	8.3	-	7.1	-
Top speed (mph)	119	130	132	137	115	112	119	117

FUEL ECONOMY

	MG ZT-TMG 120 1.8	ZT-TMG 160 1.8T	MG ZT-TMG 180 Sports Auto	MG ZT-TMG 190 Auto	MG ZT-T CDTi	MG ZT-T 131 CDTi	MG ZT-T 131 CDTi	MG ZT-T 260
Urban cycle (mpg)	26.6	24.8	17.5	19.6	36.5	28.3	35.0	28.3
Urban cycle (l/100km)	10.6	11.4	16.2	14.4	7.7	10.0	8.1	10.0
Extra-urban (mpg)	46.3	45.6	35.0	38.4	60.7	54.7	63.6	54.7
Extra-urban (l/100km)	6.1	6.2	8.1	7.4	4.7	5.2	4.4	5.2
Combined (mpg)	36.2	34.9	25.5	28.4	48.8	40.9	48.8	40.9
Combined (l/100km)	7.8	8.1	11.1	9.9	5.8	6.9	5.8	6.9
CO ₂ (g/km)	184	194	264	239	163	190	163	190

GEAR RATIOS

	MG ZT-TMG 120 1.8	ZT-TMG 160 1.8T	MG ZT-TMG 180 Sports Auto	MG ZT-TMG 190 Auto	MG ZT-T CDTi	MG ZT-T 131 CDTi	MG ZT-T 131 CDTi	MG ZT-T 260
Gearbox type	Man	Man	Auto	Man	Man	Auto	Man	Auto
5th	0.809	0.809	0.685	0.809	0.686	0.685	0.686	0.685
4th	1.029	1.029	0.854	1.029	0.919	0.935	0.919	0.935
3rd	1.348	1.348	1.247	1.348	1.292	1.364	1.292	1.364
2nd	2.022	2.022	1.948	2.022	2.022	2.131	2.022	2.131
1st	3.577	3.577	3.474	3.577	3.577	3.801	3.577	3.801
Reverse	3.308	3.308	2.714	3.308	3.308	2.970	3.308	2.970
Final drive ratio	4.412	4.167	3.89	4.412	3.737	3.450	3.737	3.450
mph per 1000 rpm in 5th	20.7	22.2	28.1	21.0	29.2	31.7	29.2	31.7

MG ZT-T 190 POWER CHART

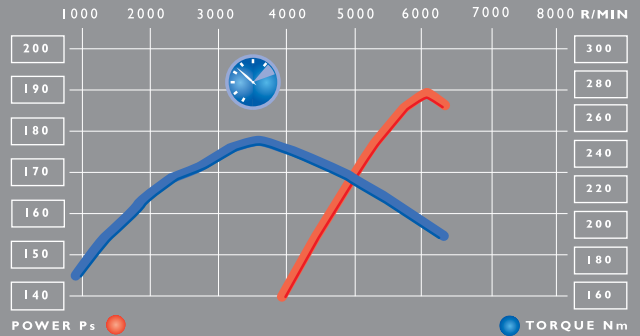

MG ZT-T 190 GEARING CHART

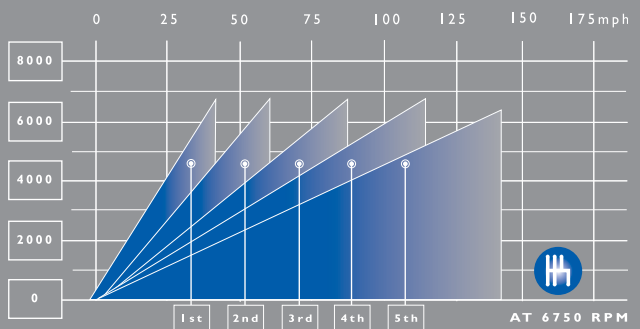

MG ZT-T 190 FUEL CHART

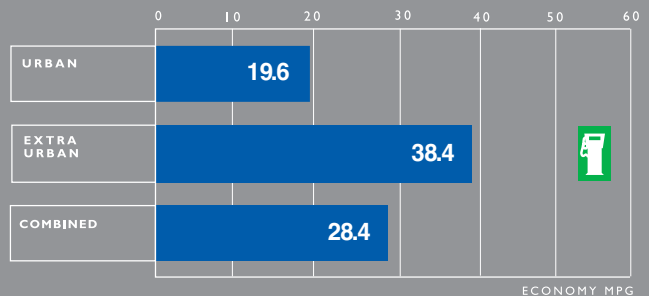

All fuel economy figures are in accordance with Directive 99/100/EC. They have been calculated using the same test cycle as used for official exhaust emission classification. They cannot be compared with the previous steady speed/urban figures and are more representative of actual on-road fuel consumption. Under normal use a car's actual fuel consumption figures may differ from those achieved through the test procedure, depending on driving technique, road and traffic conditions, environmental factors, and vehicle condition.



MG ZT & ZT-T VITAL STATISTICS

	CDTi	131 CDTi	120	160 1.8T	180 Sports Auto	190	260
Insurance Groups							
All models are Thatcham Category 2 security rated	tba	tba	tba	tba	tba	tba	tba
Specification levels available							
ZT and ZT-T			■	■			■
ZT+ and ZT-T+	■	■	■	■	■	■	■
ZT and ZT-T Special Equipment (SE) models					■	■	■
Engines and Transmissions							
2.0, 16-valve, dohc common rail turbo diesel 85kW	■						
2.0, 16-valve, dohc common rail turbo diesel 96kW		■					
1.8, 16-valve, dohc, 88kW			■				
1.8, 16-valve, dohc, intercooled turbo 118kW				■			
2.5 V6, 24-valve, dohc per bank, 130kW					■		
2.5 V6, 24-valve, dohc per bank, 140kW						■	
4.6 V8, 16-valve, sohc per bank, 191kW							■
Five-speed manual gearbox	■	■	■	■	■	■	■
Five-speed automatic gearbox	□	□			■		
Transverse engine, front wheel drive	■	■	■	■	■	■	
Longitudinal engine, rear wheel drive							■
Traction control							†
Limited slip differential							■
Cruise control	*	*			*†	*†	†
Brakes							
Upated brakes including front and rear discs, pads, callipers and master cylinder	■	■	■	■	■	■	■
Unique, large rear discs & opposed piston calliper							■
Electronic pad wear warning	■	■	■	■	■	■	■#
Bosch 5.7 four-channel ABS	■	■	■	■	■	■	■
Suspension							
McPherson strut front suspension	■	■	■	■	■	■	■
Z-axle rear suspension	■	■	■	■	■	■	■
Unique multi-link rear suspension							■
MG dampers, spring rates, bushes, subframe mounts and upated anti-roll bars	■	■	■	■	■	■	■
MG Sports suspension with upated springs and dampers	□	□	□	□	□	□	
Steering							
Power assisted linear ratio rack and pinion	■	■	■	■	■	■	■
Quick ratio steering rack	■	■	■	■	■	■	■

■ Standard □ Optional * available through the Plus option pack † standard equipment on SE models # front pads only



MG ZT & ZT-T VITAL STATISTICS

	MG ZT Models	MG ZT+ Models	MG ZT SE Models	MG ZT-T Models	MG ZT-T+ Models	MG ZT-T SE Models
Engines available						
1.8 88kW	■	■		■	■	
1.8T 118kW	■	■		■	■	
2.0 CDTi 85kW (Manual and Sports Auto)		■			■	
2.0 CDTi 96kW (Manual and Sports Auto)		■			■	
2.5V6 130kW (Sports Auto)		■	■		■	■
2.5V6 140kW		■	■		■	■
4.6 V8 191kW	■		■	■		■
Safety						
Laminated windscreen	■	■	■	■	■	■
Two-part collapsible steering column	■	■	■	■	■	■
Driver's and front passenger's airbags	■	■	■	■	■	■
Front seat mounted side (thorax) airbags	■	■	■	■	■	■
Front side head impact protection (ITS)	□	*	■	□	*	■
Two front and three rear height adjustable head restraints	■	■	■	■	■	■
Door side intrusion beams	■	■	■	■	■	■
Automatic front seat belt upper anchorage height adjustment	■	■	■	■	■	■
Front seat belt load limiters and pretensioners	■	■	■	■	■	■
Three-point inertia reel rear seat belts, including centre position	■	■	■	■	■	■
Rear door safety locks	■	■	■	■	■	■
Locks and Security						
Two flip keys	■	■	■	■	■	■
Remote controlled central door locking with superlocking	■	■	■	■	■	■
Internal master central locking switch	■	■	■	■	■	■
Central locking controlled fuel filler flap	■	■	■	■	■	■
Electric boot lid release interior button	■	■	■			
Electric external tailgate release				■	■	■
Passive engine immobilisation with transponder in key	■	■	■	■	■	■
Locking wheel bolts (one per wheel)	■	■	■	■	■	■
Perimetric alarm system (volumetric alarm and battery backed-up alarm sounder also standard on 260 models)	■	■	■	■	■	■
Visible second VIN label	■	■	■	■	■	■
Heating and Ventilation						
'On/Off' air conditioning with pollen filter, two centre and two outboard dashboard vents, front side window demister ducts in doors, and rear compartment heating ducts	■**			■**		
ATC air conditioning (full climate control, includes individual front temperature controls and adjustable rear compartment vents)		■	■**		■	■**
ATC air conditioning (full climate control including individual front temperature controls). ZT 260 and ZT-T 260 only	■		■	■		■
Auxiliary fuel-burning heater (CDTi models only)	□	□		□	□	
Interior Trim and Fittings						
Sports styled and shaped seats	■	■	■	■	■	■
'Summit' upholstery	■	■		■	■	
'Axis' upholstery with leather bolsters and front seatback map pockets	□	□		□	□	
Alcantara® upholstery with leather bolsters with Alcantara® inserts and front seatback map pockets	□	□	□	□	□	□
Black leather seat facings with front seatback map pockets			■			■
Ash leather sports steering wheel with MG badge	■	■	■	■	■	■
Leather/alloy gearknob	■	■	■	■	■	■
Perforated leather handbrake grip	■	■	■	■	■	■
Technical Grey fascia and console finish	■	■	■	■	■	■
Chrome interior door release handles	■	■	■	■	■	■
Driver's heel mat	■	■	■	■	■	■
Driver's left footrest (except 260 models)	■	■	■	■	■	■
Driver's sunvisor pocket, passenger's sunvisor vanity mirror	■	■	■	■	■	■
Cloth headlining with three damped grab handles	■	■	■	■	■	■
Auto-dimming rear view mirror		*	■		*	■
Front door bins	■	■	■	■	■	■
Front passenger's and driver's shelves with non-slip mats	■	■	■	■	■	■
Front centre storage compartment with padded PVC lid	■	■	■	■	■	■
Front passenger's cupholder	■	■	■	■	■	■
Cigar lighter and ashtray (except 260 models)	■	■	■	■	■	■
Power socket in lieu of lighter and ashtray (260 models)	■	■	■	■	■	■
Manual driver's seat height and lumbar adjustment	■	■		■	■	
Electric heated front seats (8-way driver's, 4-way passenger's adjustment)			■			■
Folding rear centre armrest	■	■	■	■	■	■
Storage compartment in rear centre armrest	■	■	■			■
One-piece folding rear seat with through-load facility	■	■	■			■
Split folding rear seat with through-load facility				■	■	■
Carpeted loadspace	■	■	■	■	■	■
Illuminated underfloor loadspace compartment				■	■	■
Integral roller blind loadspace cover				■	■	■
Moveable load restraint net					■	■

■ Standard □ Optional * available through the Plus option pack ** except ZT 260 and ZT-T 260



MG ZT & ZT-T VITAL STATISTICS

	MG ZT Models	MG ZT+ Models	MG ZT SE Models	MG ZT-T Models	MG ZT-T+ Models	MG ZT-T SE Models
Electrical features						
Electric front windows	■	■	■	■	■	■
Electric rear windows		■	■		■	■
Electric and heated door mirrors	■	■	■	■	■	■
Front centre dome lamp and twin directional lights	■	■	■	■	■	■
Rear twin directional lights	■	■	■	■	■	■
Courtesy light 'wake-up' with unlocking	■	■	■	■	■	■
Courtesy light switch-off delay with fade-out	■	■	■	■	■	■
Glove compartment and loadspace lamps	■	■	■	■	■	■
Twin headlamps with return-to-dip on engine restart	■	■	■	■	■	■
Headlamp switch-off courtesy delay	■	■	■	■	■	■
Halogen projector headlamps	■	■	■	■	■	■
Xenon gas discharge headlamps		*	■		*	■
Headlamp powerwash		*	■		*	■
Heated screen washer jets		*	■		*	■
Front fog lamps and twin rear fog guard lamps	■	■	■	■	■	■
High centrally mounted rear brake lamp	■	■	■	■	■	■
Parking lights	■	■	■	■	■	■
Lights-on warning chime	■	■	■	■	■	■
Heated rear window with timed switch-off and auto switch-on	■	■	■	■	■	■
Two-speed wipers with variable delay intermittent wipe	■	■	■	■	■	■
Programmed wash-wipe and flick wipe	■	■	■	■	■	■
Rain-sensing wipe system		*	■		*	■
Rear wash-wipe with intermittent and auto operation				■	■	■
Instruments and controls						
Tilt and telescopic steering column adjustment	■	■	■	■	■	■
Speedometer incorporating water temperature gauge	■	■	■	■	■	■
Rev counter incorporating fuel gauge	■	■	■	■	■	■
LCD display providing trip and total odometers, outside temperature and service interval indicator	■	■	■	■	■	■
Centrally mounted analogue clock	■	■	■	■	■	■
Panel light and switch illumination rheostat	■	■	■	■	■	■
Message centre instruments incorporating trip computer		*	■		*	■
Rear parking distance audible warning system		*	■		*	■
Trafficmaster® Traffic Alert congestion warning system		*	■		*	■

■ Standard □ Optional * available through the Plus option pack

MG ZT & ZT-T VITAL STATISTICS

	MG ZT Models	MG ZT+ Models	MG ZT SE Models	MG ZT-T Models	MG ZT-T+ Models	MG ZT-T SE Models
Body and Exterior Trim features						
Body-colour grille surround and MG badge	■	■	■	■	■	■
Aerodynamic deep front bumper incorporating grilles, fog lamps and indicator lamps	■	■	■	■	■	■
Body-colour waist and sill finishers and rear number plate surround	■	■	■	■	■	■
Black side window surrounds	■	■	■	■	■	■
Rear lip spoiler	■	■	■	■	■	■
Front 'Z panel' bib spoiler (260 only)	■	■	■	■	■	■
Green-tinted glass	■	■	■	■	■	■
Body-colour door mirrors	■	■	■	■	■	■
Power operated glass sunroof with blind	■	■	■	■	■	■
Integral roof rack attachment points	■	■	■	■	■	■
Twin gas bonnet struts	■	■	■	■	■	■
Fuel flap controlled by central locking, with cap rest	■	■	■	■	■	■
Gas-assisted boot/tailgate lift struts	■	■	■	■	■	■
Opening rear tailgate glass	■	■	■	■	■	■
Twin bright tailpipes with bright heatshield (all except 120 and 260)	■	■	■	■	■	■
Two sets of twin bright tailpipes with matching heatshields (260 only)	■	■	■	■	■	■
Front and rear door sill bright tread strips	■	■	■	■	■	■
MG build commission plate	■	■	■	■	■	■
Chequered and Union Flag badges	■	■	■	■	■	■
Full MG body-colour range	■	■	■	■	■	■

Option Packs

Plus model pack: Front side head impact protection (ITS), Xenon gas discharge headlamps, dynamic headlamp levelling, headlamp powerwash, heated screen washer jets, battery backed-up alarm sounder, message centre instruments with trip computer, auto-dimming rear view mirror, rain-sensing wipe system, rear parking distance sensors, Trafficmaster® Traffic Alert system and cruise control (except 1.8 and 1.8T)

SE pack: Driver's seat position memory, powerfolding door mirrors, harman/kardon premium hi-fi system (featuring a 180W 6-channel amplifier and ten branded speakers including a boot mounted sub-woofer), and electric rear sunblind (MG ZT) or integral roof rails (MG ZT-T)

□

□

□

■ Standard □ Optional



MG ZT & ZT-T EXTERIOR COLOURS

Colour. One of the most emotional decisions you can make for your car and one of the most difficult.

Should you clothe your chosen MG ZT or MG ZT-T in shining Starlight Silver? Or attract a little more attention with Black Pearl, Firefrost, Ignition Blue or Trophy Yellow? Still not enough choice? Then try Rio Red, Goodwood Green or XPower Grey for size. Decisions have never been so delicious.



FIREFROST



IGNITION BLUE



BLACK PEARL



STARLIGHT SILVER



ROYAL BLUE



BRITISH RACING GREEN



RIO RED



XPOWER GREY



TROPHY YELLOW



GOODWOOD GREEN

MG ZT & ZT-T INTERIOR



The interior of your car is the place you see the most of, the driving seat the place you'll be finding it hard to leave, so MG makes you as comfortable as possible. From practical and durable cloth seats, to fragrant part-leather and even sporty Alcantara® or stylish black leather. Whatever finish or colour you choose, you can be sure your MG is exactly how you want it to be.



MG ZT & ZT-T INTERIOR

Fabric type	SUMMIT woven twill			AXIS flat woven fluted			ALCANTARA®	BLACK LEATHER
ZT, ZT-T, ZT+, ZT-T+ models	standard			optional			optional	
ZT & ZT-T Special Equipment models							optional	standard
Fabric colour	Black	Black	Black	Grey	Blue	Green	Gunsmoke	Black
Bolsters	Black	Black	Black	Black leather	Black leather	Black leather	Black leather with Alcantara® inserts	Black leather
Stitching	Gunsmoke	Blue	Green	Grey	Blue	Green	Gunsmoke	Black
Door inserts	Black	Blue	Green	Black	Blue	Green	Smokestone	Black
EXTERIOR COLOURS								
Rio Red	■			■			■	■
Trophy Yellow	■			■			■	■
Goodwood Green pearlescent			■			■	■	■
Ignition Blue pearlescent		■			■		■	■
Black Pearl pearlescent	■			■			■	■
Starlight Silver metallic	■			■			■	■
Royal Blue pearlescent		■			■		■	■
British Racing Green pearlescent			■			■	■	■
Firefrost pearlescent	■			■			■	■
XPower Grey metallic	■			■			■	■

■ Recommended combination



SUMMIT
Grey (Black)
twill with Black bolsters



Gunsmoke stitching



Blue stitching



Green stitching



AXIS Grey
with Black leather bolsters



AXIS Blue
with Black leather bolsters



AXIS Green
with Black leather bolsters



ALCANTARA®
Gunsmoke Alcantara®,
inserts & gunsmoke bolsters



BLACK LEATHER

MG ZT & ZT-T ALLOYS

	120	160/180/CDTi	190	180/190 SE Models	260	260 SE Models
Wheel availability						
17" x 7.5 5-Spoke alloy	■					
18" x 7.5 Grid Spoke alloy		■				
18" x 7.5 11-Spoke alloy			■		■	
18" x 7.5 Apex alloy				■		■
Spare wheel						
4J x 16 wheel with T125/90 R16 tyre for temporary use	□	□	□	■		
Instant Tyre Repair system (ITR)	■	■	■		■	■

■ Standard □ Optional

Tyre sizes

17" 5-Spoke 215/50 R17 radial tyres

18" Grid Spoke 225/45 R18 radial tyres

18" 11-Spoke 225/45 R18 radial tyres

18" Apex 225/45 R18 radial tyres



17" 5-Spoke



18" Grid Spoke



18" 11-Spoke



18" Apex

MG ZT & ZT-T OPTIONS

Your every need is catered for with a wide range of options. If however, you cannot find the combination of colour, trim or features to suit you, please talk to your MG dealer about our Monogram Bespoke Build programme. Monogram offers an additional range of exclusive paint colours and duotone schemes together with a wide range of premium interior finishes and features.



MG ZT & ZT-T IN CAR ENTERTAINMENT

	Radio/Cassette CR 80	Single Slot CD-Tuner CD 80	Single Slot CD/MP3/Tuner M3 100	6-Disc CD Autochanger CDC 6
Power Output (max)	4 x 20w	4 x 20w	4 x 25w	
Full logic auto-reverse cassette deck	■			
Track search	■			
Flip down front	■	■	■	
30 Radio station pre-sets	■	■	■	
Large LCD dot matrix display	■	■	■	
Autochanger compatible	■	■	■	
4 digit security code	■	■	■	
RDS Radio text	■	■	■	
RDS with EON	■	■	■	
Traffic/News information	■	■	■	
Compatible with remote steering wheel controls	■	■	■	
Telephone mute capability	■	■	■	
CD-R / CD-RW compatible		■	■	CD-R only
Speed dependent volume			■	
ID3 name tag display			■	
Auxiliary IN (for connection of DVD eg)			■	
Pre-outs (for connection of Amplifier)			■	
Electronic shock protection (ESP)			■	

RADIO CASSETTE CR 80



CD-TUNER CD 80



CD/MP3 TUNER M3 100



Dealer fit Kenwood ICE (optional)

A range of Kenwood headunits are available instead of the standard ICE units described above (except SE models). Please consult your local dealer for details.

	MG ZT Models	MG ZT+ Models	MG ZT SE Models	MG ZT-T Models	MG ZT-T+ Models	MG ZT-T SE Models
CR 80 radio cassette		■			■	
CD 80 CD-Tuner	■			■		
M3-100 high spec CD-Tuner	□	□		□	□	
CDC-6 CD autochanger (boot mounted)		■			■	
Dealer fit Kenwood ICE	□	□		□	□	
Six speaker system – 2 front, 2 rear and 2 front tweeters	■	■		■	■	
Eight speaker system – as above with 2 rear tweeters			■			■
Volume and mode controls on steering wheel	■	■	■	■	■	■
Alpine 6-disc CD autochanger (glovebox mounted)		■*	■**		■*	■**
SmartNav® (dynamic voice guided satellite navigation system)†	□	□		□	□	
Highline Navigation (highline satellite navigation system including voiced instructions and colour map display). Features also include Alpine audio with eight speakers and colour television		□	■		□	■

* replaces CDC-6 autochanger when optional satellite navigation specified.

** autochanger is boot mounted on 260 models.

■ standard □ option †not available on the 260, requires subscription

MG ZT & ZT-T DIMENSIONS

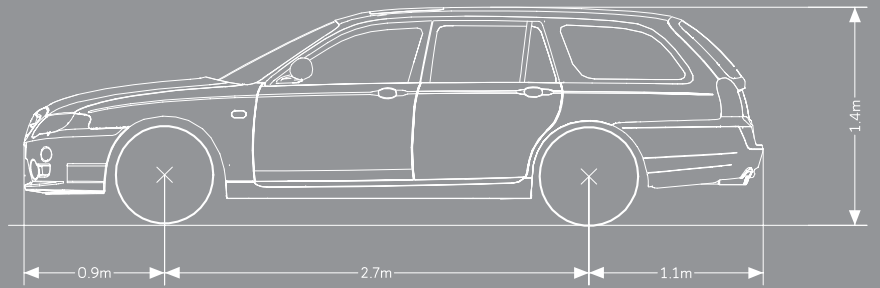
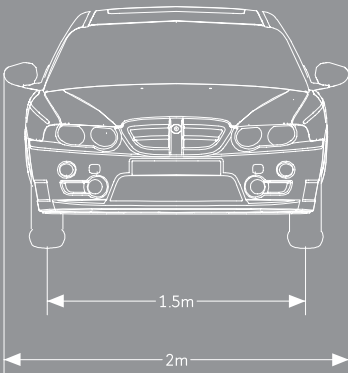
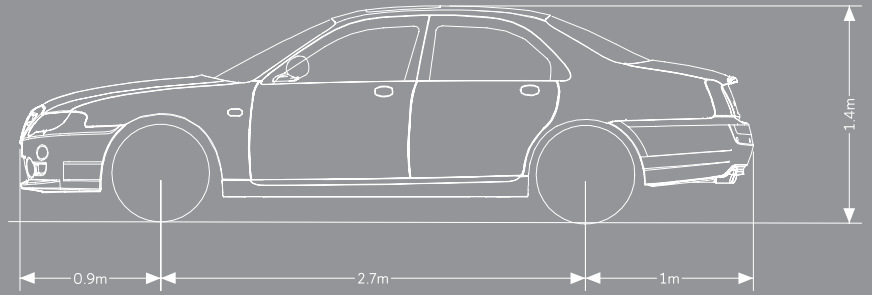
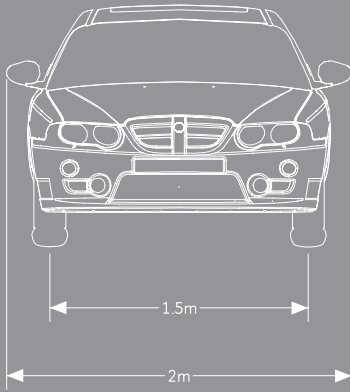

MG ZT Internal Dimensions: Front legroom 1.06m max. Rear legroom 0.92m min. Front headroom 0.99m. Rear headroom 0.95m. Front shoulder room 1.40m. Rear shoulder room 1.38m. **Luggage capacity:** 432 litres.

MG ZT-T Internal Dimensions: Front legroom 1.06m max. Rear legroom 0.92m min. Front headroom 0.99m. Rear headroom 0.95m. Front shoulder room 1.40m. Rear shoulder room 1.38m. **Luggage capacity:** 1222 litres.





MG ZT

	120 1.8		160 1.8T Man		190		180 Sports		260		CDTi		CDTi		CDTi 135		CDTi 135	
	kg	lb	kg	lb	kg	lb	kg	lb	kg	lb	kg	lb	kg	lb	kg	lb	kg	lb
unladen minimum, see note 1	1420	3130	1440	3175	1485	3270	1520	3350	1680	3700	1535	3380	1570	3460	1535	3380	1570	3460
unladen maximum, see note 1	1565	3450	1580	3480	1625	3580	1660	3660	1770	3900	1620	3570	1655	3645	1620	3570	1655	3645
max laden weight, see note 2	1940	4275	1940	4275	2030	4475	2030	4475	2170	4780	2030	4475	2030	4475	2030	4475	2030	4475
max axle load, front	1010	2225	1010	2225	1100	2425	1100	2425	1120	2465	1100	2425	1100	2425	1100	2425	1100	2425
max axle load, rear, see note 2	1000	2205	1000	2205	1000	2205	1000	2205	1120	2465	1000	2205	1000	2205	1000	2205	1000	2205
max roof load	80	175	80	175	80	175	80	175	80	175	80	175	80	175	80	175	80	175
max trailer weight, unbraked	750	1650	750	1650	750	1650	750	1650	750	1650	750	1650	750	1650	750	1650	750	1650
max trailer weight, braked, see note 3	1200	2645	1450	3195	1600	3525	1600	3525	1600	3525	1600	3525	1600	3525	1600	3525	1600	3525
max tow hitch download	100	220	100	220	100	220	100	220	100	220	100	220	100	220	100	220	100	220

MG ZT-T

	120 1.8		160 1.8T Man		190		180 Sports		260		CDTi		CDTi		CDTi 135		CDTi 135	
	kg	lb	kg	lb	kg	lb	kg	lb	kg	lb	kg	lb	kg	lb	kg	lb	kg	lb
unladen minimum, see note 1	1480	3260	1505	3315	1550	3415	1585	3490	1740	3835	1585	3490	1620	3570	1585	3490	1620	3570
unladen maximum, see note 1	1620	3570	1635	3605	1680	3700	1715	3780	1835	4045	1670	3680	1705	3755	1670	3680	1705	3755
max laden weight, see note 2	1980	4365	2010	4430	2090	4605	2090	4605	2250	4960	2090	4605	2120	4670	2090	4605	2120	4670
max axle load, front	990	2180	1030	2270	1100	2425	1100	2425	1120	2465	1100	2425	1100	2425	1100	2425	1100	2425
max axle load, rear, see note 2	1060	2335	1060	2335	1060	2335	1060	2335	1190	2620	1060	2335	1060	2335	1060	2335	1060	2335
max roof load	100	220	100	220	100	220	100	220	100	220	100	220	100	220	100	220	100	220
max trailer weight, unbraked	750	1650	750	1650	750	1650	750	1650	750	1650	750	1650	750	1650	750	1650	750	1650
max trailer weight, braked, see note 3	1200	2645	1450	3195	1600	3525	1600	3525	1600	3525	1600	3525	1600	3525	1600	3525	1600	3525
max tow hitch download	100	220	100	220	100	220	100	220	100	220	100	220	100	220	100	220	100	220

Note

- 1) Unladen weight is with no occupants and 90% fuel tank filling.
- 2) When towing, the vehicle max laden weight can be increased by up to 100kg (221lbs) and the maximum rear axle load can be increased by 15%, provided road speed is limited to a maximum of 62mph(100km/h).
- 3) The maximum towing weights shown above are to an industry defined standard and represent the maximum weight that can be towed by the vehicle, allowing it to restart efficiently on a 12% gradient (1in 8.3 approx.) at sea level.
Always fit MG officially approved towing attachments and accessories, available from your dealer.
These are the only ones approved for use on MG cars.



**If you want your MG to reflect your tastes.
If you want it to take on a little of your personality.
If you want it to be bespoke.
Take a close look at our Monogram programme.**



monogram





monogram

A suit will always fit you better if it's bespoke rather than off-the-peg, a house will always feel more like home if you design it yourself. So why take a chance with the car you drive? With the Monogram programme from MG you get the chance to make the car that suits you, not somebody else. Twenty-four body-colours, comprising Chromescent, Chromactive, Kinetic and Supertallic finishes and interior trim options mean that if you really want to push the boundaries of taste, well, that's up

to you. But it also means that you can make your car bespoke, fitted to your personal requirements. Choose your level of technology to go with your lifestyle, too. There is a range of options from alternative fascia finishes to electric seats. There are even navigation systems and incredible Alpine roof-mounted DVD screens worthy of any home cinema, because the Monogram range lets you decide where the line is drawn.



Optional roof rails

All MG authorised repairers in the UK have factory trained technicians and immediate access to over 70,000 approved parts. They're fully equipped to deal with today's sophisticated MG cars, and offer competitively priced servicing with a guarantee of workmanship on every job they do. With 280 Dealers UK wide, there is extensive coverage never too far away.

Buying an MG isn't just about satisfying your heart's desire – there are plenty of reassuring features that your head will appreciate too.

● WARRANTY

During the first three years of ownership you'll enjoy the protection of one of the most comprehensive extended warranties in the industry.

All MG models purchased from MG Rover Dealers in the UK are covered by a three year/60,000 mile warranty.* Included within this extended three year warranty is an array of guarantees and services designed to offer complete peace of mind motoring.

Roadside Assistance is provided in the UK for the first year by the Automobile Association whose fleet of 3,500 patrol vehicles provide a service of roadside repair or Homestart. In the event that the vehicle cannot be repaired at the roadside it will be taken to the nearest MG Rover Repairer or to a destination of the customer's choice.

MG Rover customers can purchase AA 5 Star European Services at preferential rates from the Automobile Association and 2nd and 3rd year Roadside Assistance options can be purchased from your supplying Dealer.

● SERVICE INTERVALS

12 months/15,000 miles, then every 12 months/15,000 miles thereafter.

MG ZT 260: 5,000 miles/12 months whichever occurs first, then every 5,000 miles/12 months thereafter.

* made up of 12 month unlimited mileage warranty plus MG's 2nd and 3rd year 60,000 mile extended warranty, subject to terms and conditions. The extended warranty is provided by MG as a no cost option to purchasers of an MG ZT/ZT-T from approved UK MG Rover Dealers. The extended warranty will only apply to the extent that the 12 month unlimited mileage warranty has not exceeded 60,000 miles.

ENVIRONMENTAL STATUS

MG Rover Group Ltd is environmentally accredited to ISO14001 (Environmental Management Systems); meets all necessary vehicle exhaust gas emissions limits for the EU and other relevant markets; and is complying with developing national regulations to meet the waste prevention objectives of the European Directive on End of Life Vehicles (ELVs). For more details on MG Rover's efforts to improve product/site environmental performance, including vehicle recyclability, free take-back networks for ELVs, and other environmental issues, please click on the 'Environment' link in the 'About Us' section of the MG Rover website www.mg-rover.com, or ask your local dealer for information.

Call MG now on 08459 251 251. Alternatively, visit www.mgcars.co.uk to book a test drive or contact your nearest Dealer



BY APPOINTMENT
TO HER MAJESTY
THE QUEEN
MANUFACTURERS OF
POWER AND MG MOTOR CARS
MG ROVER GROUP LTD, LONGBRIDGE



BY APPOINTMENT
TO HER MAJESTY THE PRINCE OF WALES
MANUFACTURERS OF
POWER AND MG MOTOR CARS
MG ROVER GROUP LTD, LONGBRIDGE

MG Rover Group
PO Box 41
Longbridge
Birmingham
B31 2TB
www.mgcars.co.uk

© MG Rover Group Ltd 2004.

Important Notice: MG Rover Group is constantly seeking ways to improve the specification, design and production of its vehicles and alterations take place continually. Whilst every effort is made to produce up to date literature, this UK market brochure should not be regarded as an infallible guide to current specifications, nor does it constitute an offer for the sale of any particular vehicle. Dealers are not agents of MG Rover Group and have absolutely no authority to bind MG Rover Group by any express or implied undertaking or representation. Any reference in this brochure to speed or performance should not be taken as an encouragement to drive either dangerously or at speeds in excess of the national limit. If you require any further information regarding MG products or services, please contact your MG Dealer, who will be pleased to assist you.

Publication number: 6271

YOUR LOCAL DEALER IS

