

The New Peugeot | **407 SW**



Création: bd-rtwk - Automobles Peugeot RC Paris B 552 144 503 - Edition: Gutenberg On Line (5) - Imprimé en U.E. - GB - 07/04

The information and images in this brochure are based on the current technical data when going to print. The equipment shown is factory fitted or available as an option at extra cost, depending on the model. Where a feature is described as an option it should be assumed that it is at extra cost unless specifically stated otherwise. There may be some feature combinations that are not available in the UK and some photography may feature left hand drive vehicles. As part of a policy of continuous specification improvement, Peugeot reserve the right to modify the technical equipment, options and colours at any time. For full specification ask your local Peugeot Dealer or click on www.peugeot.co.uk. Note that current print and photographic techniques do not allow us to faithfully reproduce the full depth and tone of the colours in this brochure. This brochure is designed to provide general product information and is not a contractual document or offer of sale. For current information please contact your authorised Peugeot Dealer. The details in this catalogue cannot be reproduced without the express authorisation of Peugeot.

Issued by: Sales and Marketing, Peugeot Motor Company plc,
Aldermoor House, PO Box 227, Aldermoor Lane, Coventry CV3 1LT.

For details of HM Forces tax-free military sales contact:
Peugeot Export, 454-490 Mile End Road, London E1 4PE.
Telephone: 020 7791 9050
Email: peugeot.export@peugeotmail.co.uk

For all other enquiries please call 0845 200 1234
(calls will be charged at local rate, and may be
recorded for training or quality purposes).

www.peugeot.co.uk

July 2004
MCP 2219



You'll be taken by it





Where would you like to go?

4/ design 16/ ergonomics and comfort 24/ accessibility 30/ on the road 43/ road holding
44/ active safety 47/ passive safety 50/ dynamism 54/ interior equipment 58/ storage 60/ trims
64/ dimensions - wheels - colours 66/ accessories 67/ Peugeot customer promise



It's time to get going

It's time to decide what you want

Forget about compromise, that's just setting one particular requirement off against some other need; think perfect world. What would be your ideal car – one that breaks new ground but has more than a hundred years of heritage behind it? That's the new 407 SW, a car with sculpted lines

and a refined silhouette that carefully balances sophisticated technology with a refreshing user-friendliness.

It's teeming with practical ideas to help you enjoy your daily commute, but getting from A to B is only part of the story. It's when you feel like

heading off to C that the 407 SW's touring credentials come into play. You can watch the road disappear under its aerodynamic nose as it eats up mile after mile, and relax in an interior that is spacious but, at the same time, puts all the control at your fingertips. As for its performance,

that's something you'll be able to judge from the second you get behind the wheel. You'll feel a sense of excitement that is almost tangible – it's the feeling you get when you realise that you've arrived somewhere.





407

The headlights and foglamps, which add so much to the distinctive silhouette are an integral part of the car's unmistakably sleek, sporty lines. And the optional xenon headlights won't dazzle even though they're almost as bright as daylight, and can be set to switch on automatically when the light fades.

To make parking simpler, the door mirrors are electrically adjustable so that you can see behind you more easily and sensors on the rear bumper activate a buzzer to warn you if you're too close to any unseen obstacle. When you've arrived safely home, 'follow-me-home' lighting keeps the car's lights on for a few moments to help you to your front door.



If anything's going to change the way you see things, it's the panoramic glass roof. It extends from the expansive windscreen almost seamlessly and emphasises the airy spaciousness of the 407 SW to such a degree that you'll never look at an interior in the same way again.





— — — — —





Although this is a car that incorporates the most innovative systems to assist you, it also provides the reassurance of being completely in control at all times. The panoramic windscreen, for instance, gives you unparalleled view of the road and adds to the

impression of space and light. In front of you, the main instrument panel tells you everything you need to know whilst the steering column controls, and the equipment grouped on the centre console, are always to hand.

The dashboard display even tells you which of your tyres might need air and the electrochrome rear view mirror* darkens automatically to prevent glare. The windscreen wipers activate automatically* when they detect the first drops of rain and adapt their speed

if it gets heavier. The wipers themselves are of a new design; extra flat so that they clear the windscreen more efficiently, improving your visibility in bad weather.

* Depending on model

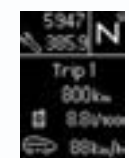

Trip computer



Auto control

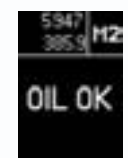

Engine oil level indicator



Tyre pressure sensor

All the vital information you need is right there in front of you. Chrome-edged dials and comprehensive instrumentation tell you all you need to know.



When you open the driver's door, the steering wheel automatically moves* so that you can get into the car more easily. Once inside, you can adjust its rake and reach, change the door mirror settings and manoeuvre your seat with the electronic controls, ensuring that however long your journey,

you'll always arrive in great shape. Your front passenger hasn't been overlooked either – their seat can be electronically adjusted too**.

*Optional extra on Executive models only
**Depending on model

A capacious passenger compartment ensures that everyone travels in complete comfort – the floorspace is virtually flat, so your three rear passengers can relax in seats equipped with comfortable curved head restraints, enjoying unrestricted views through the side windows.





Getting into the boot when you're parked in a tight space or close to another car can be tricky. But it's simple when the rear tailgate window opens independently of the whole door.



When we designed the interior, we like to think that we considered every eventuality. It's not just the rear seats that fold down, for instance. You can lay the front passenger seat flat as well, opening up a virtually flat loadspace that runs the length of the entire car.





— — — — —







Genuine pleasures are those that are shared. Like the first proper chance you get to put your new 407 SW through its paces, heading for the coast with the family on board. The excitement at the moment of departure, the happy faces, the anticipation.

Some people don't realise how easy it is to miss the moment, it passes them by and they have to rely on half-remembered memories. Other choose to experience it. On a daily basis. Every second.







Stability

Innovation in the art of roadholding

To maintain optimum grip on the road, the 407 SW possesses a suspension system which is as innovative as it is effective:

- The front double wishbone suspension sets new standards in performance and steering, while at the same time providing a comfortable ride.

- The multi-arm rear suspension, with horizontal dampers, provides enhanced guidance and stability.

- A variable damping system (AMVAR)* independently controls each wheel's suspension and adapts the shock absorbers to your driving style.

The result is a car that sets new standards in its class for road-holding and manoeuvrability.

* V6 versions only



Active safety

Inspiring confidence

Active safety is always a major consideration and the 407 SW works hard to put your mind at rest. Its road-holding is impeccable, thanks to ESP. Our Electronic Stability Programme maintains your car's balance in difficult situations by combining five functions:

- ABS (Anti-lock braking system) allows the trajectory to be controlled by preventing the wheels locking during emergency braking
- EBA (Emergency Brake Assist) gives your braking maximum power
- ASR traction control prevents the wheels skidding in the event of loss of grip
- Electronic Brake Force Distributor controls the braking of each individual wheel for more efficiency
- Dynamic Stability Control returns your vehicle to its trajectory if the ECU detects any understeer or oversteer.

Other features, such as electronic warning messages and hazard lights that automatically activate if you decelerate too sharply, also help to maintain your peace of mind.

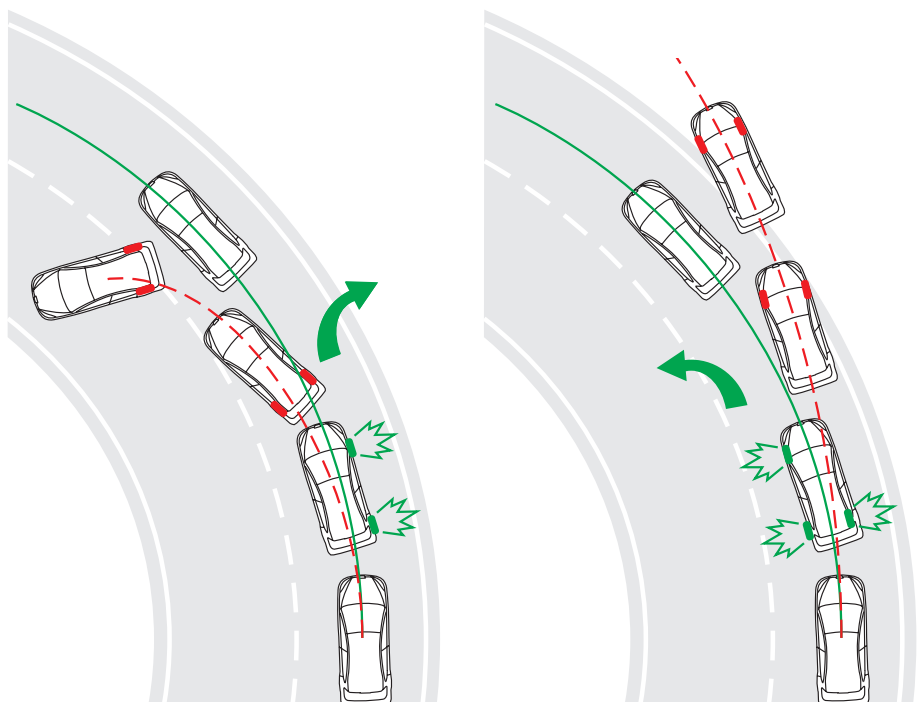



Security

- Laminated side windows give you more protection and reduce outside noise levels*
- Interior and exterior protection
- Deadlocks
- Ultrasonic alarm
- Automatic door locking
- Automatic boot locking
- Locking wheel bolts for alloy wheels

* Part of security pack option

Rest assured

Passive Safety and Protection



Reinforced body structure

By basing the design of the 407 SW around a predominantly aluminium sub-frame, the chassis has an integral strength, and its comparative lightness also means that performance isn't compromised.

- A built-in crumple zone is designed to absorb impact so that the passenger compartment remains intact.
- This has been achieved by extending the sub-frame forwards with a lower front crossmember.
- Each of the doors is strengthened with padding and side impact protection beams.
- The engine is anchored to the sub-frame so any intrusion into the passenger compartment is limited, if there's a head-on collision.

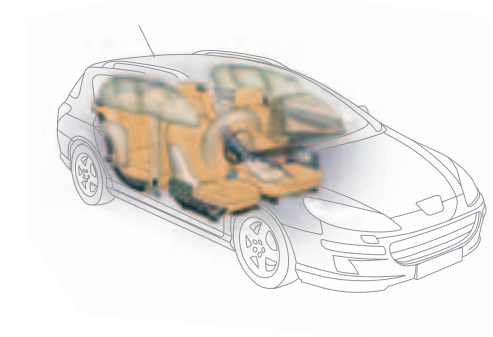

Airbags

Passive safety is of paramount importance, that's why the protection of you and your passengers is ensured by up to nine air bags.

- At the front, the driver and passenger have 2 front air bags protecting their heads and chests.
- 2 side air bags also protect their pelvis and abdomen.
- 2 further curtain air bags give specific protection to the heads of those in the front of the car.
- The driver also has a steering column airbag to protect his lower limbs.
- At the rear, the curtain and side air bags specifically protect the head and chest of the passengers. (part of the security pack option).



Other safety equipment

The front seats are fitted with active 'anti-whiplash' head restraints; if there's a crash, your momentum instantaneously activates them, to prevent injury to your neck. In the rear, the three passengers each have a comma-shaped head restraint. This is in addition to the pre-tensioning seat belts with force limiter, fitted to the front and rear side seats*. The rear side seats also have Isofix fixings designed to accommodate 2 child seats if required.

* Pre-tensioning rear side seat belts are model dependant.



Driving Force

Set your pulse racing

A wide choice of engines is available on the new 407 SW. Whatever your preference, you can be sure of an immediate and intense driving experience.

HDi 110 bhp

Equipped with the latest technology, this engine has an air/air intercooler, a variable geometry turbocharger and a new-generation Common Rail system. As a result both the 110 and 136 bhp HDi diesel engines comply with Euro 4 emission regulations.

HDi 136 bhp

Also equipped with state-of-the-art Diesel engine technology, including an 'overboost' function, this engine, coupled with a six-speed gearbox exemplifies the 407 SW's dynamic performance.

Particulate emission filter (FAP)

1. Filter assembly 'precatlyst and particulate filter'
2. Sensors
3. Electronic engine management unit
4. Injection of additive into the fuel tank
5. Information sent to the injector head when post-combustion is needed for self-regeneration
6. Precatlyst
7. Particulate filter (FAP)

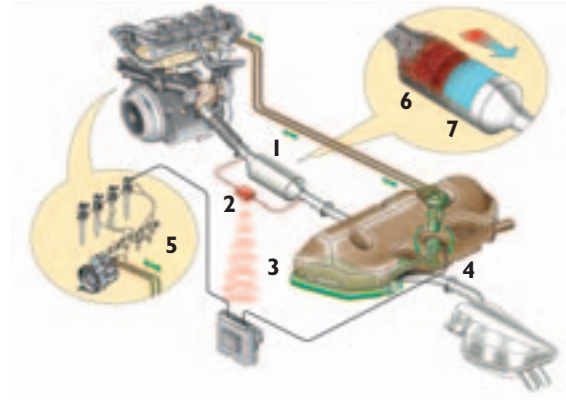

Petrol 1.8 litre 16v 117 bhp

Combining outstanding performance with excellent fuel consumption this engine provides a rewarding driving experience. It comes with a 5-speed manual gearbox.

Petrol 2.0 litre 16v 138 bhp

Comfortable and economical, this engine comes with either a 5-speed manual gearbox, or a 4-speed automatic, auto adaptive gearbox with Porsche Tiptronic System control.

Petrol 2.2 litre 16v 160 bhp

The adoption of a variable timing control (VTC) system on the intake camshaft provides power and high torque, ensuring brisk acceleration at all engine speeds. It comes with a 6-speed manual gearbox or a 4-speed automatic auto adaptive gearbox with Porsche Tiptronic System control.

Petrol 3.0 litre 24v 211 bhp

This engine incorporates a variable valve timing system (VVT) that allows more linear acceleration and a new exhaust with an active dual-mode system offering superior performance at high engine speeds and improved noise insulation. It is combined with an all-new 6-speed automatic gearbox as standard, equipped with the Porsche Tiptronic System to enhance overall performance.

Dynamism

Control at your fingertips

Whatever your driving style, the 407 SW comes with a choice of gearbox that will match it perfectly; manual or automatic, it's your choice.

5-speed manual gearbox

A transversely mounted gearbox with a proven track record that provides a thoroughly enjoyable experience through fluid gear changes.

6-speed manual gearbox

This new six speed gearbox gives the 407 SW more responsiveness when starting off, and a surprising briskness through the mid-range.

Sequential 4-speed automatic gearbox

This gearbox has an auto adaptive mode, so it can adapt to your driving style as well as taking things like the road surface and gradient into consideration. The Porsche Tiptronic System also gives you sequential control of the gears.

Sequential 6-speed automatic gearbox

The ultimate in gearbox technology, allowing you to make the most of the 407 SW's dynamism, especially with the complete control afforded by the Porsche Tiptronic System. Nothing else combines all the fuel economy and performance advantages of a 6-speed gearbox with an integral electronic management system. This management system takes your driving style, and the road conditions, into account so you'll really know what your engine's capable of.





Interior equipment

1. Multifunction display You'll find the information about your car radio, air conditioning, on-board computer, date, time and temperature, all from one centrally mounted display.

2. RD4 car radio The CD radio incorporates dual tuner/antenna technology – this means that any interference is reduced to an absolute minimum. And you'll have fantastic audio reproduction from the 4 x 15watt output and a Digital Signal Processor; able to adapt to five different musical ambiances.

Air conditioning Where passenger comfort is concerned, air conditioning is one the most important elements. In the 407 SW, air is gently diffused around the inside of the car; always at the selected temperature with no air currents from blowers. A humidity sensor stops any condensation forming and an active charcoal filter traps pollen, dust and exhaust fumes. It's efficient as well; an externally controlled compressor adjusts the temperature, so fuel consumption is significantly reduced.

Automatic air conditioning - single zone All you have to do is press the auto button and the system adjusts the temperature to the selected level.



3. Automatic air conditioning - dual zone This function allows the driver and front passenger to each enjoy separate temperatures and air distribution.

4. Direct access controls The 407 SW might be teeming with innovative features but they're all simple to use and easy to find. Within easy reach, you'll find controls for central locking, hazard warning lights, the ESP system, your rear parking aid, electric child safety rear door locks and the variable damping system*.

* Depending on version



1. 16/9 7" colour screen A colour screen that gives you the time, date, outside temperature and lets you know everything about the car's major systems – telematics, on-board computer, air conditioning, car radio and satellite navigation.



Satellite navigation Slide the satellite navigation CDROM into the RT3 and you'll know exactly where you're going. The colour screen gives you visual directions, while audio instructions tell you which way to turn.



2. GPS RT3 radio telephone In addition to the features of the RD4 on the previous page, the RT3 also includes a GSM phone, satellite navigation and a 6 CD autochanger.



3. GSM phone The phone is built in to the RT3 system with full voice control, so you never have to take your hands off the wheel. Even the satellite navigation is voice activated, which means you can just tell it where you want to go. It has a Peugeot call button that puts you straight through to Peugeot Assistance or your Customer Contact Centre and an SOS button (which is triggered automatically if your airbags deploy)



CD autochanger The 6 CD autochanger is compatible with the RD4 and, when it's combined with the RT3 system, you can listen to audio navigation at the same time as your CDs.

JBL hi-fi system Specially designed for the 407 SW by JBL, one of the great names in audio entertainment, the speaker system delivers an output of 240 Watts.

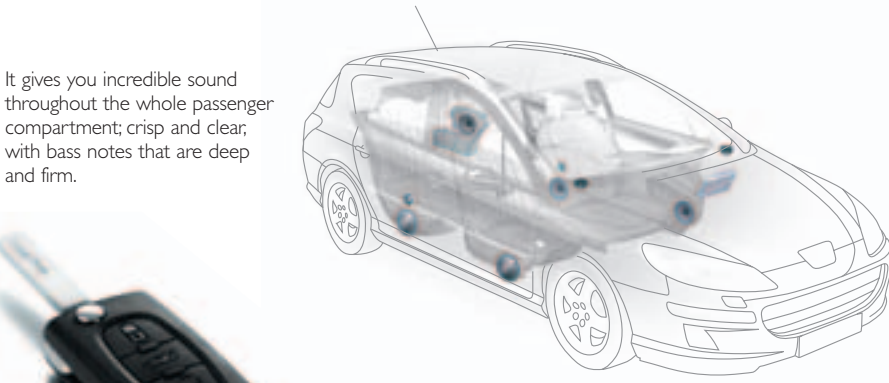

It gives you incredible sound throughout the whole passenger compartment; crisp and clear, with bass notes that are deep and firm.

High frequency remote control You can lock and unlock your 407 SW from a distance, and find it at night when the indicators flash.



1/2

3

Storage

Good ideas, simple solutions

With the 407 SW, you don't have to wonder whether your luggage is going to fit – you just know it will. With no wheelarch intrusion the boot space is huge, especially if you drop the rear seats. There are other smaller storage areas too, of course, discreetly tucked away at the front and rear of the car, but always within reach.

Ski flap

You can open an ingenious gap between the rear seats if you need to carry any extra long items – they just slide through and rest on the central armrest.



1. Air conditioned glove box

As well as being air conditioned, the glove box is lockable and illuminated.

2. Rear centre armrest

Two compartments and two cup holders provide practical and discreet space (depending on version).

3. Front centre armrest

This armrest has a coin holder to stop loose change rolling around and a retractable cup holder, just behind the gearstick.

4. Driver's storage compartment

The best place for your miscellaneous objects.

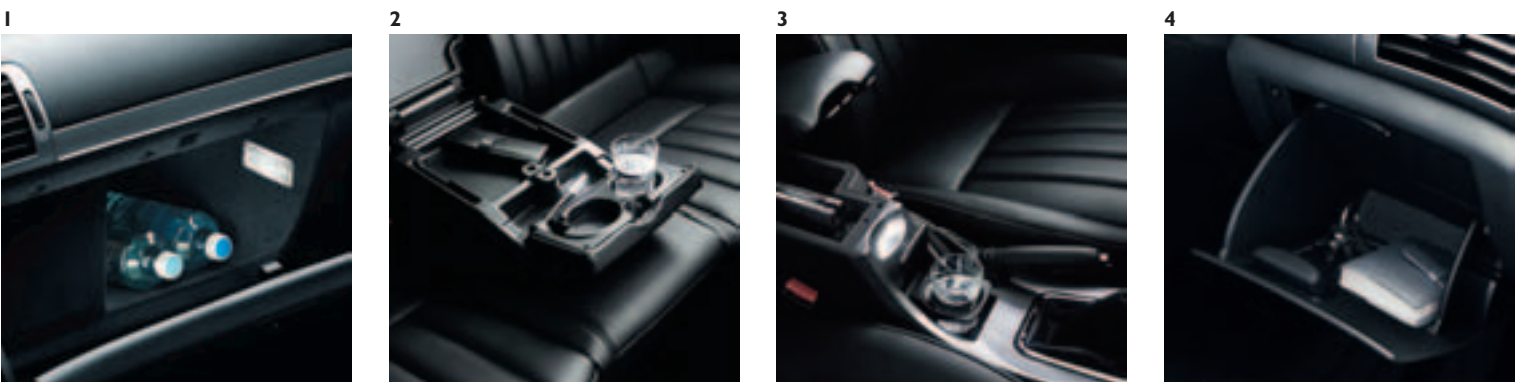

Interiors

New levels of comfort

The care and attention that we've lavished on the 407 SW also extends, of course, to the interior. Whichever you choose, you'll appreciate a degree of luxury every time you get behind the wheel.

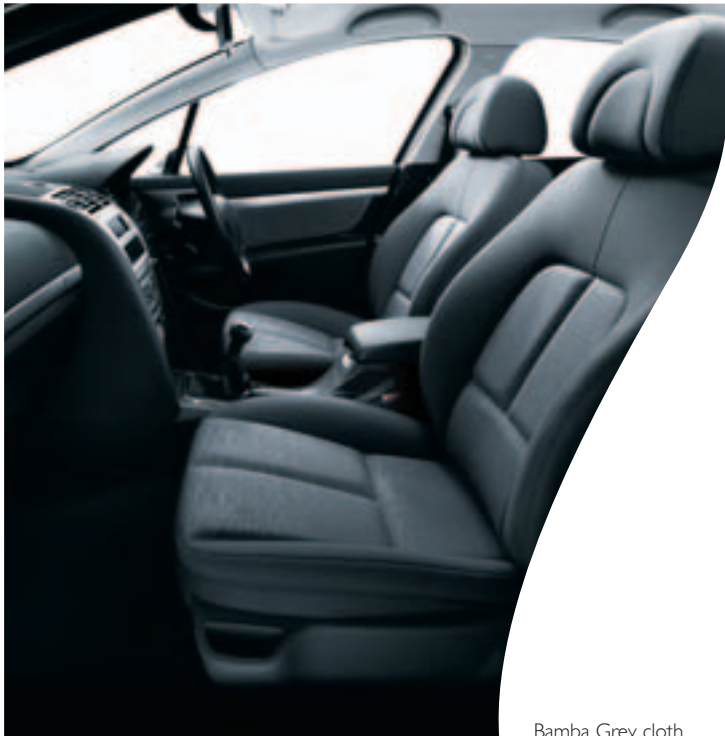

Bamba Grey cloth

S level

The classic grey tones of the woven fabric are colour co-ordinated with the door panels, central console and dashboard.

SE level

Behind the three spoke steering wheel, the white dials contrast with the black dashboard and the chrome detailing is carried through to the door panel inserts.



Mistral Black leather
(full leather interior available as an option on SE Luxury Pack versions only)



Zagros Black cloth

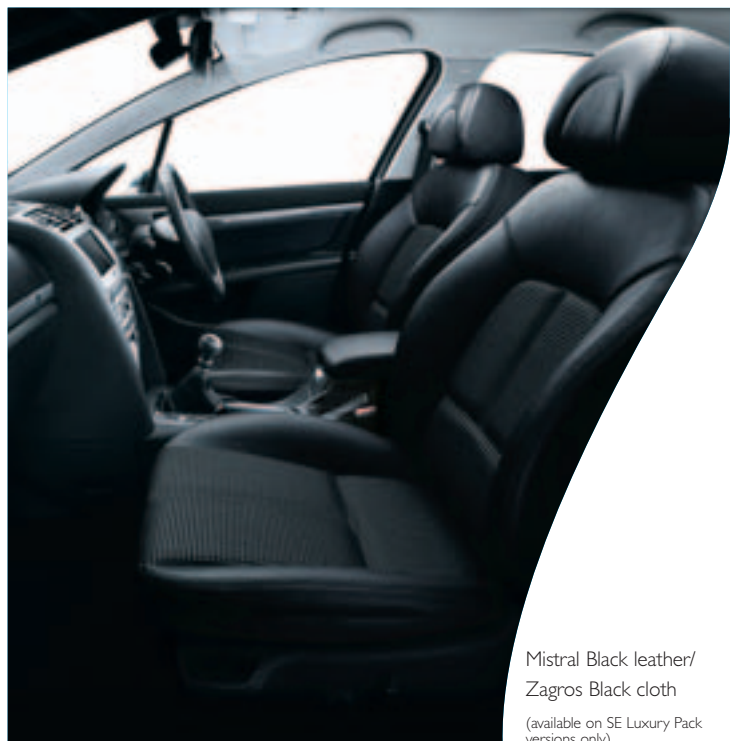

Mistral Black leather/
Zagros Black cloth
(available on SE Luxury Pack versions only)

SV level

The SV is available with Fangorn velour, either in grey or beige, with matching carpets and a corresponding black or oyster dashboard. The door trim panels are finished in Tabre velour, and both interiors have walnut burr effect dashboard and door panel inserts.

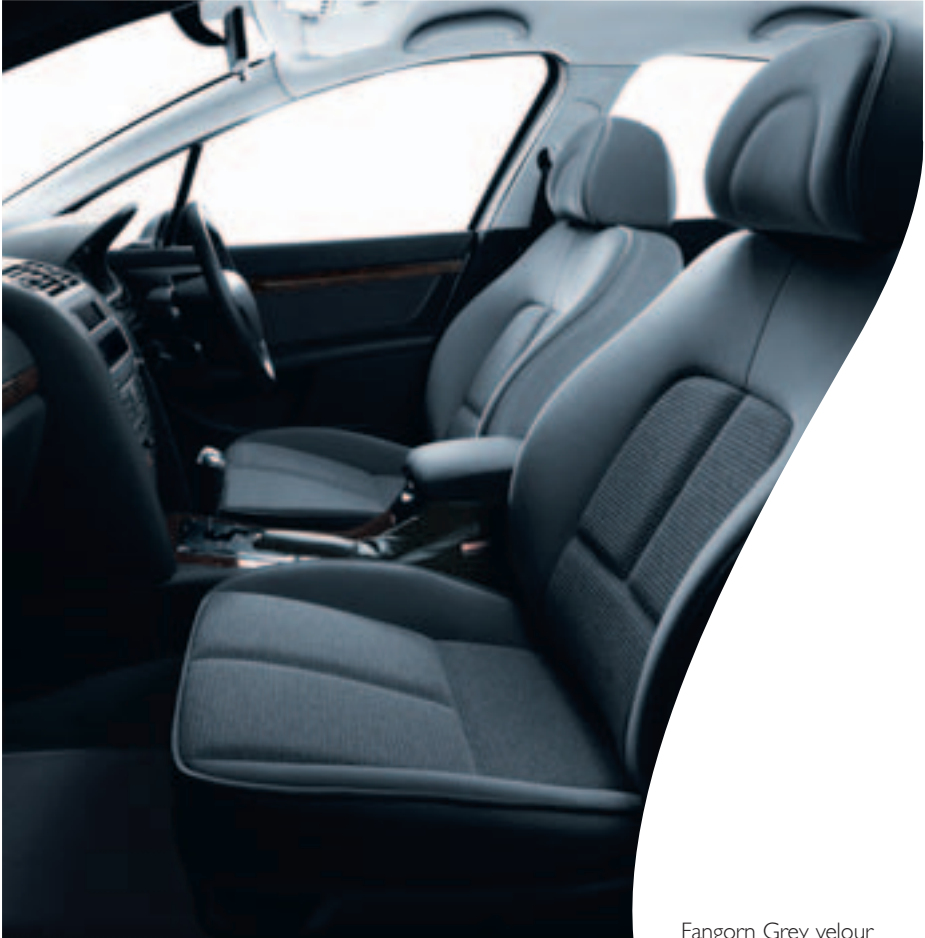

Fangorn Grey velour

Executive level

The Executive is available with black Mistral or cream Oyster leather. Whichever interior you choose, you'll have leather door panels with walnut burr effect inserts and colour co-ordinated dashboard and carpets.



Mistral Black leather



Fangorn Beige velour



Oyster leather

The well-balanced proportions and dimensions of the 407 SW are self-evident. You can decide what sort of visual impact you want to make, though, when you choose any one of the twelve body colours available.

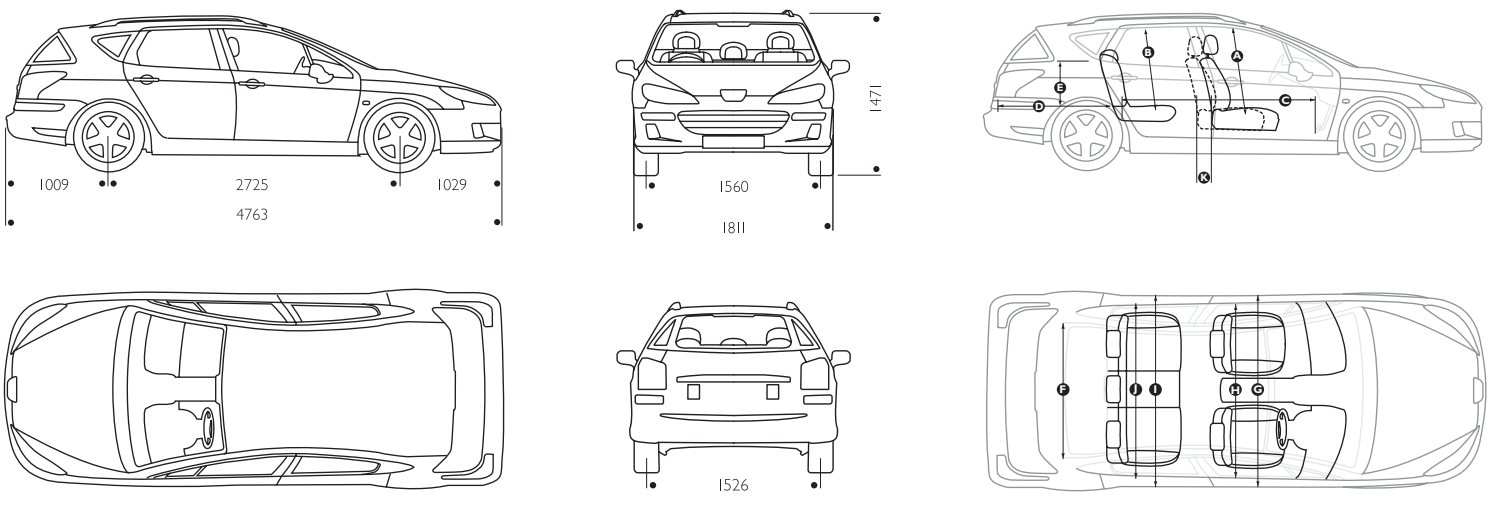

Bianca White



Moonstone



Aluminium



Iron Grey



White Gold



Dolomites Bronze



Diablo Red
(Will be replaced by Ruby Red during the year)



Halcyon Blue



China Blue



Cypress Green



Mulberry



Onyx Black



1. Andante 16" wheel trim (available on S only).
2. Cosmos 17" alloy wheels (available on SE only – except SE HDi 110).
3. Quasar 16" or 17" alloy wheels - 16" available on SE HDi 110 only - 17" available on SV and Executive only).



The Peugeot Customer Promise

When you buy a new Peugeot vehicle from a Peugeot Dealer in the UK and entrust your vehicle to one of them for servicing or repair, they promise:

to give you the best people, with the best training and diagnostic tools, original equipment Peugeot parts and the best aftersales backup,

all at a competitive price.

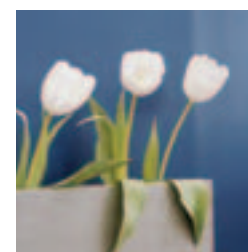

This additional Warranty carries a mileage limit of 60,000 miles (100,000 miles for Boxer models excluding Motorhomes and other converted vehicles) from first registration. The conditions of the additional 1 year Warranty are identical to those of the 2 year manufacturer's Warranty. (For full terms and conditions, please consult your Peugeot Dealer. NB: This 3 years of Warranty is automatically transferable on the sale of the vehicle.) At the end of the 3 years of Warranty (or 60,000 miles) you have the option to purchase a Peugeot Platinum Extended Warranty. This offers an almost identical level of peace of mind warranty cover for up to a maximum of a further 48 months (unlimited mileage). Contact your Peugeot Dealer for details.

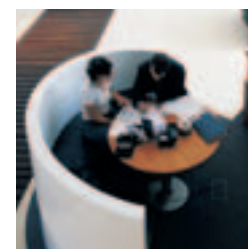

Peugeot Peace of Mind

Peugeot vehicles are designed and manufactured to give you worry-free motoring and peace of mind. As a Peugeot owner you are entitled to a comprehensive range of customer care services from your Peugeot Dealer who has the expertise to maintain your Peugeot to its peak performance.

Peugeot Warranties

• 3 Years of Warranty
In addition to the 2 year unlimited mileage manufacturer's Warranty, all vehicles first registered in the UK and purchased from a UK Peugeot Dealer benefit from a free optional additional 1 year of Warranty provided by the Peugeot Dealer network in the UK.

12 Year Anti-Perforation and 3 Year Paint Warranty

Also automatically transferable on sale of the vehicle, this will maintain and enhance the resale value of your vehicle. (The Anti-Perforation Warranty is limited to 6 years and the Paint Warranty to 2 years on 206 Van, Partner, Expert and Boxer vans.)

Peugeot Assistance

For the first year of ownership you will automatically receive Peugeot Assistance cover for complete peace of mind.

Additional Peugeot Assistance may be purchased for the second and third years. Operated by the RAC, it includes roadside assistance, vehicle recovery, free replacement vehicle or hotel accommodation and chauffeur provision in case of certain medical disabilities. Peugeot Assistance is available within the UK and Europe.

Your local Peugeot Dealer has full details of terms and conditions.

Peugeot Service Care

Peugeot petrol engine vehicles need servicing every 20,000 miles (12,000 2.0 litre 180 bhp engines) or every 2 years. Drivers of HDi diesel versions also benefit from extended servicing with 12,000 miles (20,000 2.0 litre hdi 407 & Expert) or 2 year intervals. With less time spent in the maintenance bay and fewer service visits, Peugeot have passed on the benefits of technology in engine design and lubrication. In between scheduled services your Peugeot Dealer offers you a complementary intermediate

visit (level check/top up) provided the appropriate, previous full service has been carried out at an authorised Peugeot Dealership.

In order to minimise the inconvenience associated with normal servicing, Peugeot UK Dealers promise to offer you the choice of:

- while you wait servicing with a timed appointment;
- or local vehicle collection from your home or place of work;
- or alternative transport to the railway station, home or place of work;
- or by arrangement, a hire vehicle at a concessionary rate.

In addition they will aim to ensure that your vehicle is washed before it is returned.

Peugeot Insurance Centre

Peugeot Insurance has been specifically arranged for Peugeot owners. Offering discounted premiums and a fast and efficient claims service, it is another benefit of owning a Peugeot. Your Dealer can provide a proposal form for a free quotation or you can call the Peugeot Insurance Centre direct on 0870 024 0206 for a free quotation.

Alternatively, contact:

Peugeot Insurance Centre
The Wharf
Neville Street
Leeds
LS1 4AZ

Whatever Peugeot you drive, we guarantee you a competitive premium for your Motor Insurance. As a valued customer of Peugeot we'll make sure you get the very best premium quotation possible from Peugeot Insurance.



1. Roof rail cross bars

The roof bars are an integral part of the 407 SW design and these cross bars, which can carry up to 100kg, let you use them without risking any damage to the car's paintwork.

2. Styled mud flaps

Designed to complement the sleek lines of the 407 SW and protect the bodywork at the same time, these mud flaps supplied in matt black plastic ready for fitting and can be painted to match the body colour.

3. Dog guard

You can carry your pets more safely with this easy to fit and removable dog guard.



4. In-car portable DVD player with an 8" integrated screen.

The player is supplied in its own case, which you can mount on the back of either front seat, or centrally between them. It has built-in speakers, or you can use the 2 sets of headphones.

5. DVD player with integrated screen.

This ultra-flat and ultra-light DVD player has a large 7" screen. It comes with a 12V lead, a 240V adaptor for home use and a protective pouch.

6. Armrest for DVD player

This easy to fit centre armrest is the perfect place for your DVD player. Slide it open and the screen is in the optimum position for rear passengers. In the closed position, everything is discreetly out of sight, away from prying eyes.

