

Peugeot | **Partner Van**  
**Expert Van and Combi**  
**Boxer**

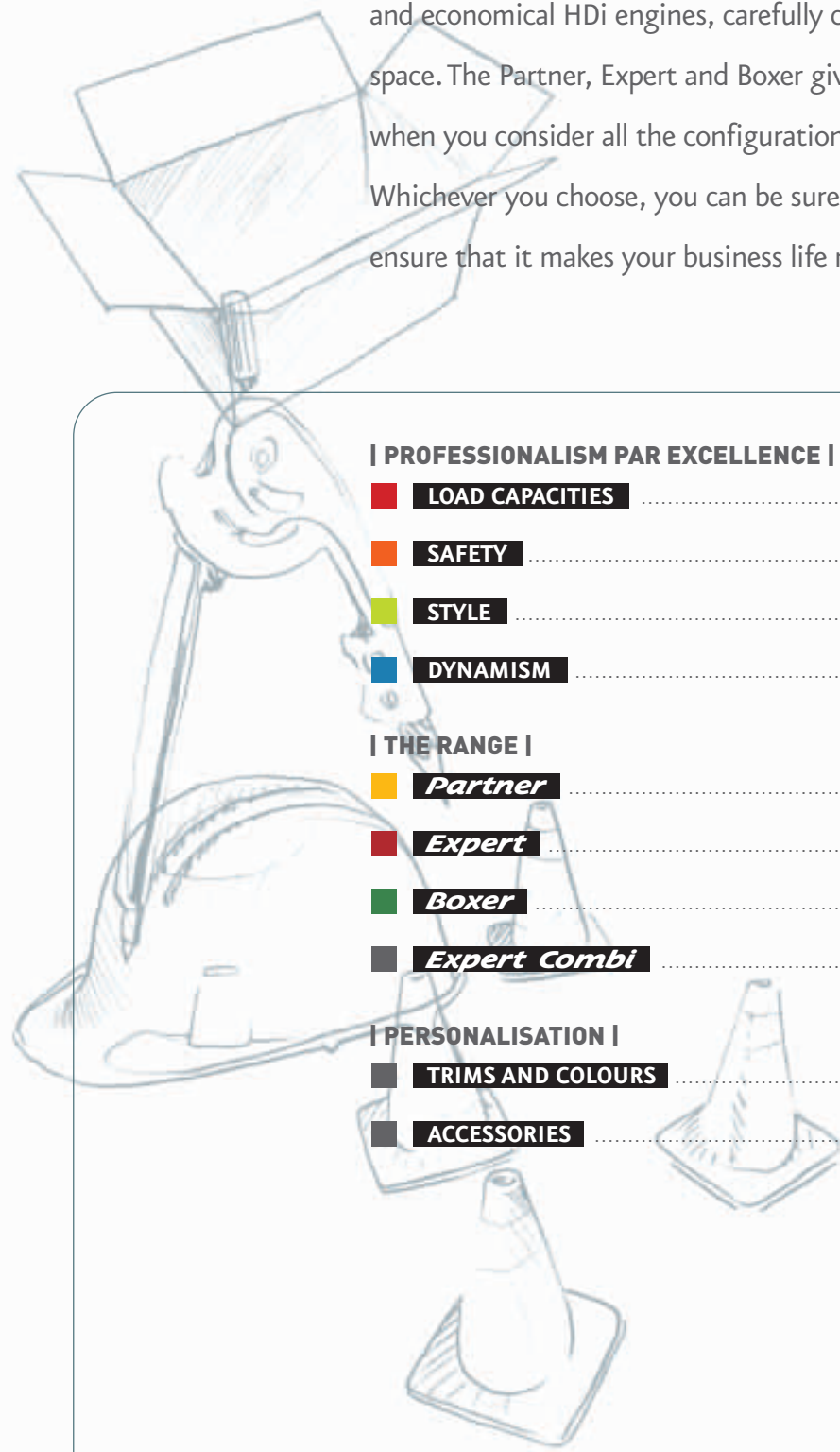

Whatever your job, there's a van in our professional range that can add a bit of individuality to your business. There's substance behind the style as well - they're all as practical and reliable as you could want, with powerful and economical HDi engines, carefully considered ergonomics and loads of space. The Partner, Expert and Boxer give you a huge choice, especially when you consider all the configurations and options that are available. Whichever you choose, you can be sure that we've done all we can to ensure that it makes your business life more of a pleasure.



**| PROFESSIONALISM PAR EXCELLENCE |**

<b>LOAD CAPACITIES</b>	p. 4
<b>SAFETY</b>	p. 6
<b>STYLE</b>	p. 8
<b>DYNAMISM</b>	p. 10

**| THE RANGE |**

<b>Partner</b>	p. 12
<b>Expert</b>	p. 20
<b>Boxer</b>	p. 30
<b>Expert Combi</b>	p. 44

**| PERSONALISATION |**

<b>TRIMS AND COLOURS</b>	p. 46
<b>ACCESSORIES</b>	p. 48



# | LOAD | CAPACITIES

## 01: optimise volume and reduce effort.

THE PARTNER, EXPERT AND BOXER HAVE BEEN CAREFULLY REDESIGNED SO THAT YOU CAN MAKE THE MOST OF THEIR CAPABILITIES. INTERIORS ARE AS CAPACIOUS AS WE CAN MAKE THEM, WITH LOW LOADING SILLS AND WIDE REAR AND SIDE DOORS. THE RESULT IS A RANGE OF VANS THAT MAKE YOUR JOB SEEM LESS LIKE HARD WORK BY SAVING YOU TIME AND EFFORT.

**DESIGN**  
The sliding side doors available on the Partner, Expert and Boxer provide easier access.

**ADAPTABILITY**  
The rear loadspaces of our vans have been designed to be as versatile as possible so any of them can be adapted to meet your needs.

**LOADING**  
You can choose to have rear doors on your Boxer that open 250° - they're a great example of the care we've taken to make sure that you can always load and unload your van safely and easily.



Model shown: Expert with a single passenger seat.

# | SAFETY |

## 02: protect the driver, passengers and load.

SAFETY IS TOP OF OUR LIST, WHICH IS WHY THE PARTNER, EXPERT AND BOXER ARE CONSIDERED TO BE AMONG THE BEST IN THEIR CATEGORIES. ALL THREE HAVE THE LATEST ACTIVE SAFETY EQUIPMENT, SUCH AS ABS\*, AND THE MOST UP TO DATE PASSIVE SAFETY FEATURES, SUCH AS DRIVER, PASSENGER AND SIDE FRONT AIRBAGS\*, AS WELL.

\* OPTIONS AT EXTRA COST.



### PROTECTION

With 3-point seat belts for all occupants, a reversing camera\* to make parking easier and front side air bags\*, the passenger compartment features the full range of active and passive safety equipment.

### ASSISTANCE

ABS\* helps to keep you going in a straight line if you have to stop suddenly and makes sure that your brakes are as effective as possible, whatever you're carrying.

\* Option at extra cost.

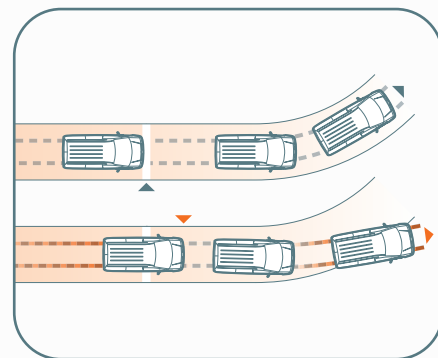

Model shown: Partner Van with an optional radio/CD player



# | STYLE |

## 03: enhance the image of the business.

THE ALL-TERRAIN CHARACTER OF THE PARTNER, THE TAUT LINES OF THE EXPERT AND THE ROBUST SILHOUETTE OF THE BOXER WILL SHOW YOU IN THE BEST POSSIBLE LIGHT TO YOUR CUSTOMERS. ALL THREE WILL REFLECT YOUR RELIABILITY AND PROFESSIONALISM - QUALITIES THAT ANY BUSINESS WOULD WANT TO CONVEY.



### STYLING

Our vans are proof that practicality, good looks, utility and convenience are not mutually exclusive.

Model shown: Expert with optional body coloured bumper and front fog lights.



### HARMONY

These vans are really robust because their protective features are an integral part of their original design.



### PROFESSIONALISM

Our range of light commercial vans offers several body types with different wheelbases, and numerous floor and chassis configurations that can be mixed and matched to meet your needs.

Model shown: Boxer with optional front fog lights



# | DYNAMISM |

## 04: making it easier to get around and improving efficiency.

PEUGEOT SETS THE STANDARD WHEN IT COMES TO ROADHOLDING, AND OUR LIGHT COMMERCIAL VANS ARE NO EXCEPTION TO THE RULE. HDi ENGINES AND FRONT AXLE WITH INDEPENDENT FRONT SUSPENSION - OUR PROFESSIONAL VEHICLES WILL MAKE YOUR LIFE A LITTLE EASIER, HOWEVER YOU EARN A LIVING.



### POWER AND ECONOMY

The engines are a unique combination of power, drivability and economy, especially our HDi engines which increase efficiency, reduce fuel consumption and cut down pollution.

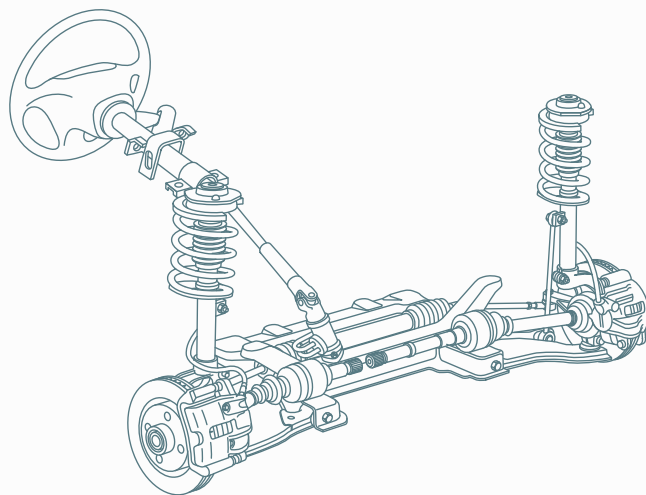

### ROADHOLDING

We made sure that every element, from the dynamic engine and independent front suspension to the ventilated disc brakes, improves its roadholding.



## | PARTNER |

**Partner,  
the professional spirit.**

You can rely on the Partner to add a bit of individuality to your business – it's a real multi-purpose commercial vehicle; practical, reliable and versatile enough to be equally at home around town or out on the open road. It's time to stop looking for a new van and start looking at a new Partner.



# | PARTNER |

Although we've given the Partner a distinctive style, we haven't forgotten that its main job is a load carrier. That's why the interior is as spacious as possible and we've given you the choice of a 600 or 800kg payload.



Model shown: LX with optional heated rear windows with 2 rear wipers.

INTERIOR DIMENSIONS	
Load area width between wheel arches	1.190 m
Maximum load area width	1.600 m
Maximum load area height	1.250 m

### REAR DOORS

Open 180° to reveal a volume of 3 m<sup>3</sup>.

### SLIDING SIDE DOORS

Make loading and unloading easy. You can choose an optional kerbside sliding door or, if you order the LX, you can opt for twin sliding side doors.



### REAR ROOF FLAP

Lets you carry long objects securely (available as an option).

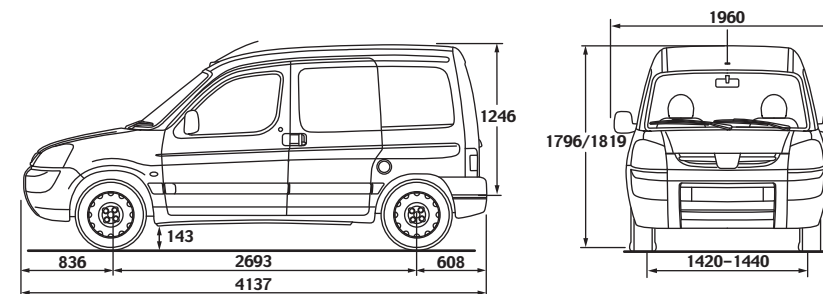

**3 m<sup>3</sup>** **600 or 800 kg**

### VOLUME AND PAYLOAD

According to versions.

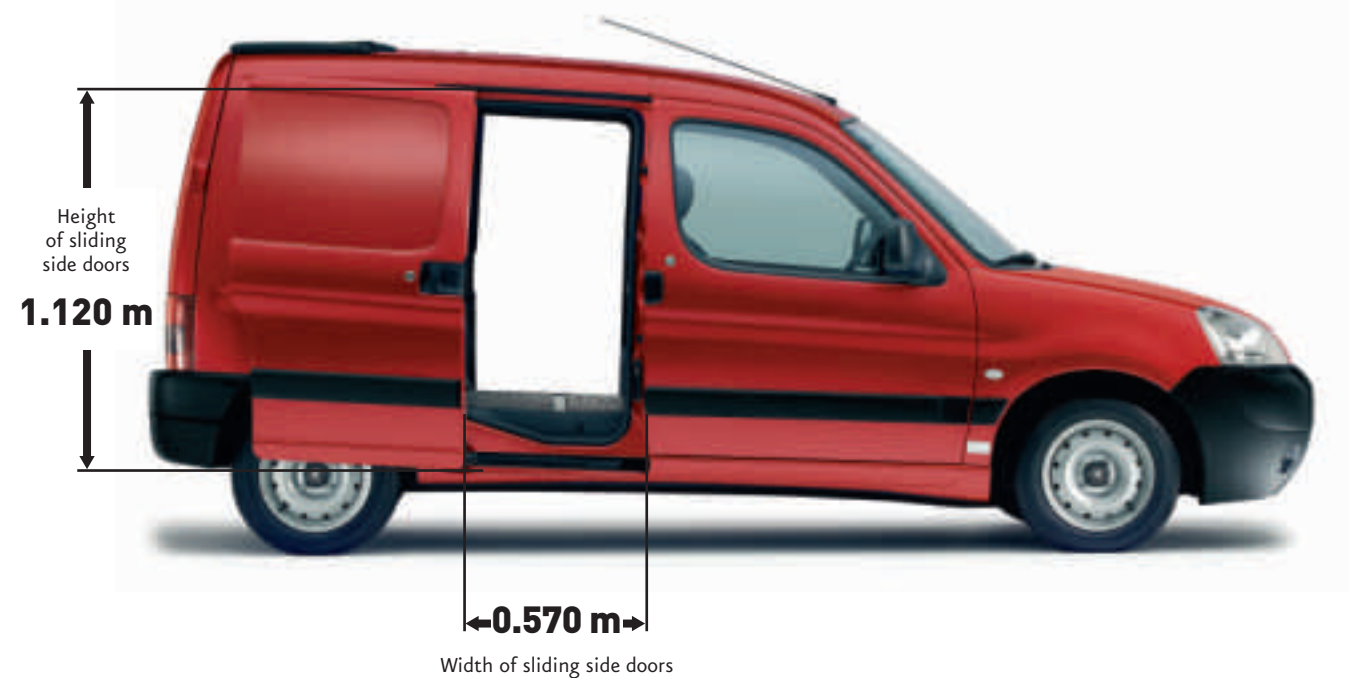



## | DRIVING AND SAFETY |

The Partner features the most recent innovations and unrivalled equipment, so you'll always feel comfortable and, above all, safe.

### 4-DIAL INSTRUMENT PANEL

All the essential information is clearly visible.

### FOLLOW-ME-HOME LIGHTING

Keeps the headlamps on for 45 seconds when you leave the vehicle.

### STEERING WHEEL CONTROLS

These include, in addition to the usual functions, controls for the stereo equipment.



### HDi DIESEL ENGINE

Equipped with the Common Rail high-pressure fuel injection system; HDi technology reduces fuel consumption and emissions, but gives you more power.



### BULKHEAD

The optional half-height steel partition and upper grille mesh will protect you and your passenger if you have to brake suddenly.



### AIR BAGS

The driver's airbag is a standard safety feature of all models, the passenger and side airbags are an option that you can choose for added safety.

- 3RD BRAKE LIGHT
- ELECTRONIC IMMOBILISER
- ABS\*
- BRAKES WITH VENTILATED DISCS AT THE FRONT
- 3-POINT SEAT BELTS

\* Option at extra cost



## | COMFORT AND PRACTICALITY |

The passenger compartment is really versatile – storage compartments for any amount of equipment, cup holders and a passenger seat that folds into a desk. We call it variable geometry, you'll call it practical.

### ↘ MULTIFUNCTION PASSENGER SEAT\*

\* LX model.

The passenger seat folds down quickly and easily to make a useful desk or create more cabin space, and has a hidden storage compartment underneath.



### ↗ CENTRAL CONSOLE

Features a storage space that can accommodate your drinks and/or a removable ashtray.

### ↗ OVERHEAD STORAGE

The full width overhead shelf gives you more storage space for day-to-day objects and has a map light to help you read in the dark.

- 3 CUP HOLDERS
- 1 COAT HOOK
- CLOSED GLOVE BOX
- REMOVABLE ASHTRAY
- 12V ACCESSORY POINT ON THE PASSENGER SIDE (ON LX VERSION)
- DOOR POCKETS IN THE FRONT DOORS
- BOTTLE HOLDER

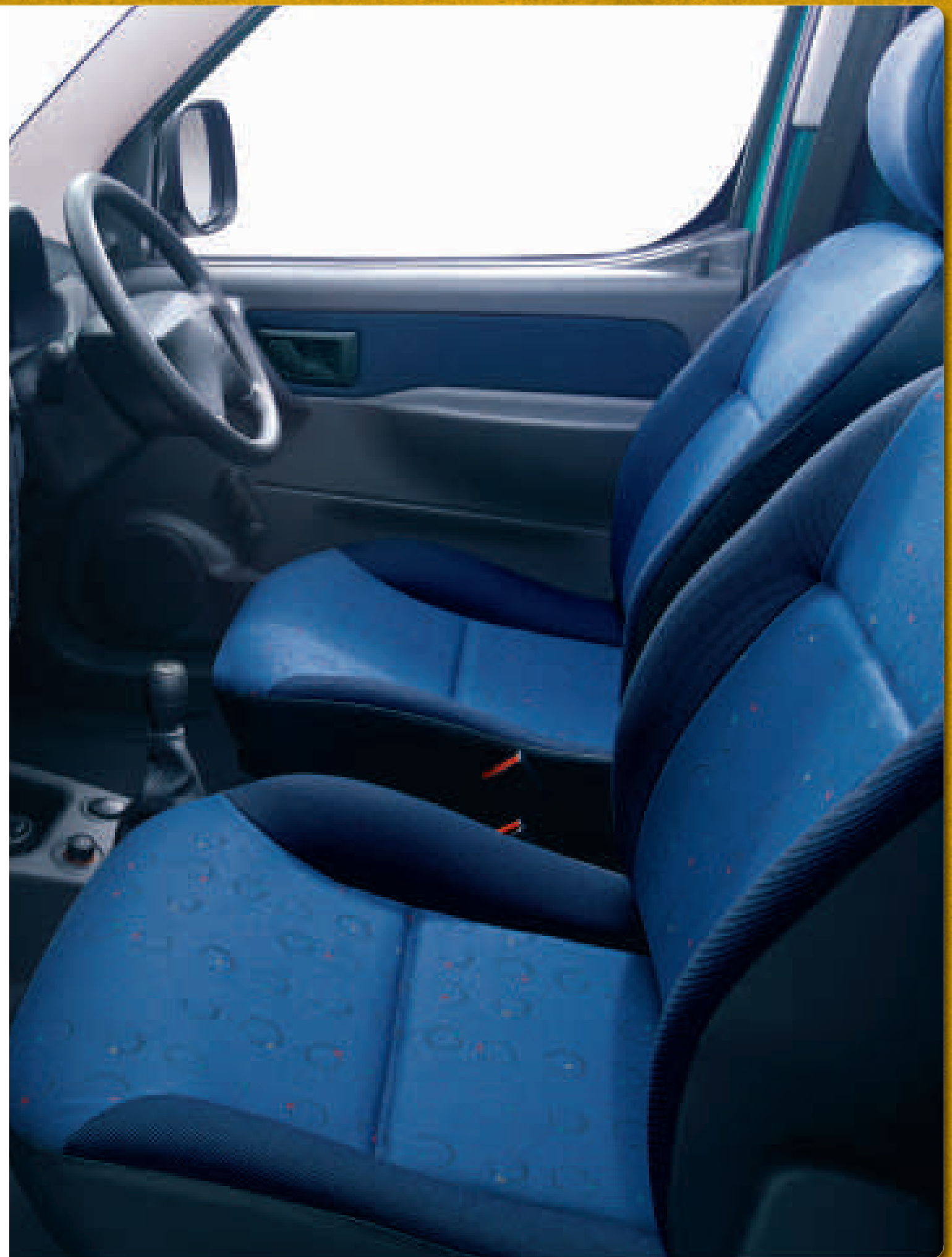

## | EXPERT |

**Expert,  
rich interior design.**

The Expert combines the ease of handling that you usually associate with a small van, and the capacity of a larger van. Its excellent versatility means that it can go wherever you want it to and do whatever you ask of it.



# | LOAD CAPACITY |

Small on the outside, big on the inside - the Expert is the solution to all your needs.



INTERIOR DIMENSIONS	
Load area width between wheel arches	1.200 m
Maximum load area width	1.430 m
Maximum load area height	1.420 m

### REAR DOORS

The rear doors incorporate a 90° retention system, but they can also open to 180° so that you can get to every square centimetre of the interior space.

### SLIDING SIDE DOORS

These doors are impressively wide for loading bulky goods, and can be combined with a second sliding door on the driver's side for even easier access.



### PROTECTION LADDER

Offers you protection if your load moves while you're driving.

4 m<sup>3</sup> 815 to 900 kg\*

### VOLUME AND PAYLOAD

According to versions.

\* Including the driver

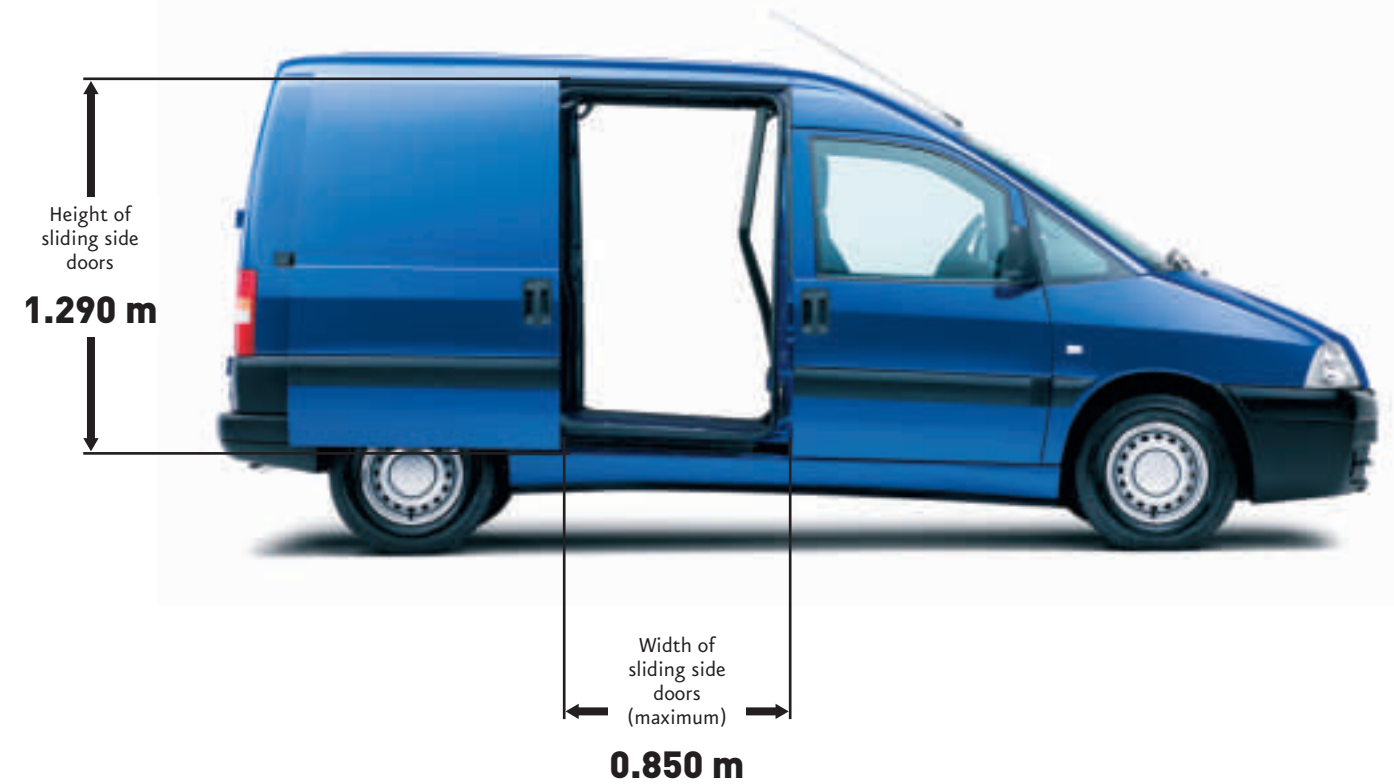

# | CONFIGURATIONS |

## GOODS TRANSPORT

# 4m<sup>3</sup>

Panel van



Wheelbase	<b>2.824 m</b>
Load floor length	<b>2.050 m</b>
Load height	<b>1.420 m</b>
Load area width	<b>1.430 m</b>
Payload	<b>815 kg</b> (1.9 l diesel) <b>900 kg</b> (HDi 110)

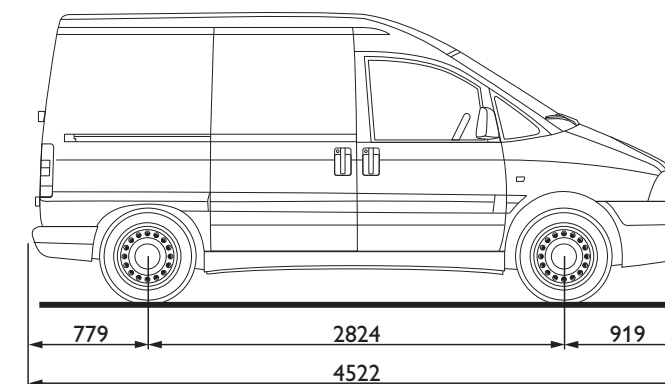
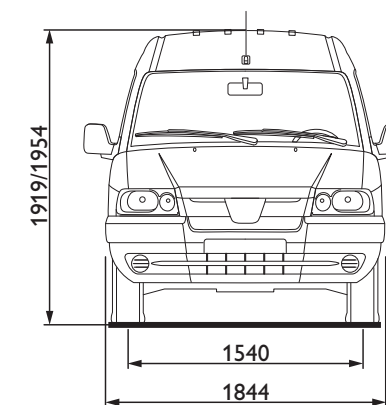

## | DRIVING AND SAFETY |

When you're driving every day, efficiency and safety aren't luxuries, they're necessities that we think you should take for granted.

### ERGONOMIC 4-SPOKE STEERING WHEEL

Height-adjustable, comfortable and precise.

### RADIO CONTROLS ON THE STEERING WHEEL

Lets you concentrate on driving.

### FASCIA PANEL

Everything's clearly laid out and easy to read.



### PANORAMIC REAR-VIEW MIRROR

Adjustable from the inside, reduces blind spots and ensures good visibility.



### FRONT AND SIDE FRONT AIR BAGS

Protect the head and chest.  
\*Option at extra cost.



### 3-POINT SEAT BELTS

Pretensioning seat belts with force limiter for the driver and front passengers.

- 3RD BRAKE LIGHT
- ELECTRONIC IMMOBILISER
- ABS\*
- BRAKES WITH VENTILATED DISCS AT THE FRONT

\*Option at extra cost.



## | COMFORT AND PRACTICALITY |

During the past year we've made specific improvements to the soundproofing and seating of our Expert van so that we can continue to promise that you're more likely to find these levels of comfort in a car rather than another van.



### OVERHEAD STORAGE

To keep the essentials within hand's reach.



### FRONT SEATS

The driver's seat is height-adjustable with longer seat cushions, raised seat back and reinforced lateral support.

### ARMREST

On the driver's seat, for a more relaxed driving position.

\* Not available if dual passenger seat specified.



Model shown: Expert with individual passenger seat.

## | BOXER |

### Perfectionism in five letters

Every single detail of each item of equipment on all the Boxer configurations, has been carefully studied so we can be sure that helps you work more efficiently. That's also the reason why we've made it available in a wide range of models and versions. Take a look and you're sure to find the Boxer that's right for your business.





# | LOAD CAPACITY |

With its 3 length specifications, its 2 height specifications and its multiple configurations, the Boxer redefines the concept of goods transport.



INTERIOR DIMENSIONS	
Width between wheel arches	1.388 m
Load width above wheel arches	1.808 m
Load height centre	
<b>Standard roof</b>	1.562 m
<b>High roof</b>	1.881 m



**DOUBLE SLIDING SIDE DOORS\***

You can park on either side of the road and still load/unload Boxer easily.  
\* Optional according to model.



**REAR DOORS**

Loading and accessibility are simple because the rear doors fold right back\*.  
\* Optional on all models except 250.

**7.5 to 12 m<sup>3</sup>** **735 to 1575 kg**

**VOLUME AND PAYLOAD**  
According to versions.



# | CONFIGURATIONS |

## SHORT WHEELBASE

# 7.5m<sup>3</sup>

Standard roof van

	250	290	330
Load floor length	<b>2.510 m</b>		
Load height centre	<b>1.562 m</b>		
Load width above wheel arches	<b>1.808 m</b>		
Payload	<b>735 kg</b> (2.0 l HDi)	<b>1205 kg</b> (2.8 l petrol) <b>1145 kg</b> (2.0 l HDi) <b>1075 kg</b> (2.2 l HDi)	<b>1545 kg</b> (2.0 l HDi) <b>1475 kg</b> (2.2 l HDi) <b>1450 kg</b> (2.8 l HDi)

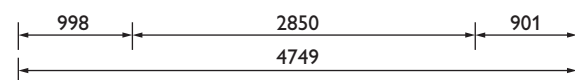
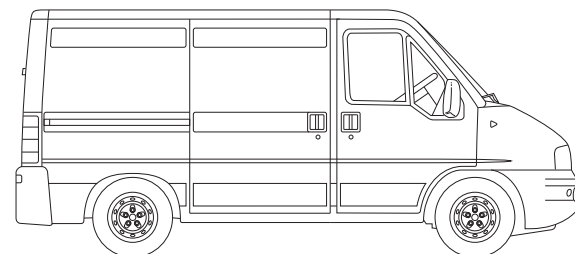

Height side door	<b>1.449 m</b>
Width side door	<b>1.090 m</b>
Height rear doors	<b>1.441 m</b>
Width rear doors	<b>1.562 m</b>

# 9m<sup>3</sup>

High roof van

	290
Load floor length	<b>2.510 m</b>
Load height centre	<b>1.881 m</b>
Load width above arches	<b>1.808 m</b>
Payload	<b>1110 kg</b> (2.0 l HDi)

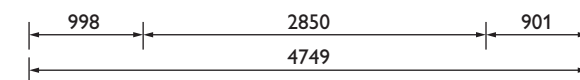
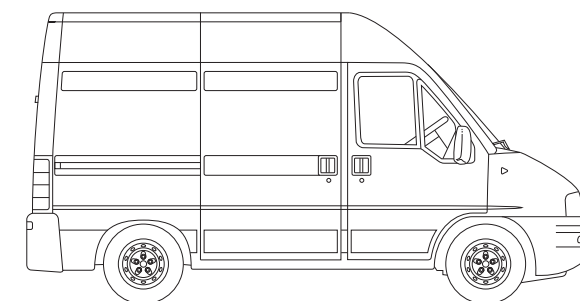

Height side door	<b>1.449 m</b>
Width side door	<b>1.090 m</b>
Height rear doors	<b>1.760 m</b>
Width rear doors	<b>1.562 m</b>

# | CONFIGURATIONS |

## MEDIUM WHEELBASE

### 9m<sup>3</sup>

#### Standard roof

	290	330
Load floor length	<b>2.860 m</b>	
Load height centre	<b>1.562 m</b>	
Load width above arches	<b>1.808 m</b>	
Payload	<b>1105 kg</b> <small>(2.0 l HDi)</small>	<b>1505 kg</b> <small>(2.0 l HDi)</small>
	<b>1035 kg</b> <small>(2.2 l HDi)</small>	<b>1435 kg</b> <small>(2.2 l HDi)</small>
		<b>1415 kg</b> <small>(2.8 l HDi)</small>



### 10m<sup>3</sup>

#### High roof van

Exists in panel and glazed versions

	330	350
Load floor length	<b>2.860 m</b>	
Load height centre	<b>1.881 m</b>	
Load width above arches	<b>1.808 m</b>	
Payload	<b>1495 kg</b> <small>(2.0 l HDi)</small>	<b>1575 kg</b> <small>(2.2 l HDi)</small>
	<b>1425 kg</b> <small>(2.2 l HDi)</small>	<b>1525 kg</b> <small>(2.8 l HDi)</small>
	<b>1375 kg</b> <small>(2.8 l HDi)</small>	

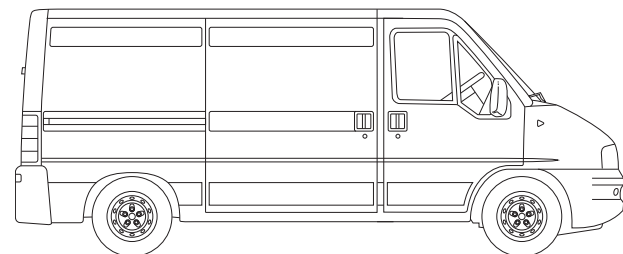

Height side door	<b>1.449 m</b>
Width side door	<b>1.265 m</b>
Height rear doors	<b>1.441 m</b>
Width rear doors	<b>1.562 m</b>

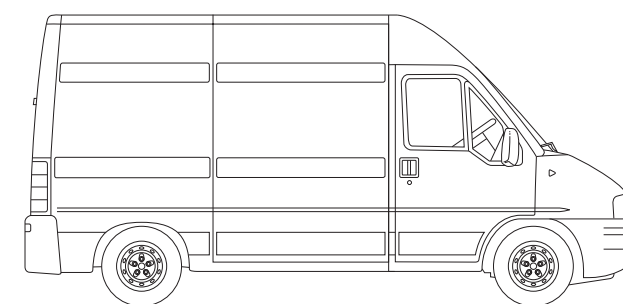
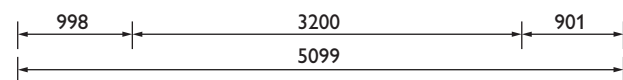

Height side door	<b>1.769 m</b>
Width side door	<b>1.265 m</b>
Height rear doors	<b>1.760 m</b>
Width rear doors	<b>1.562 m</b>

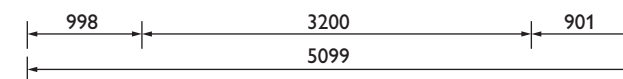

# | CONFIGURATIONS |

## LONG WHEELBASE

# 12m<sup>3</sup>

### High roof van

Exists in panel and glazed versions



	330	350
Load floor length	<b>3.360 m</b>	
Load height centre	<b>1.881 m</b>	
Load width above arches	<b>1.808 m</b>	
Payload	<b>1355 kg</b> <small>(2.2 l HDi)</small>	<b>1505 kg</b> <small>(2.2 l HDi)</small>
	<b>1330 kg</b> <small>(2.8 l HDi)</small>	<b>1480 kg</b> <small>(2.8 l HDi)</small>

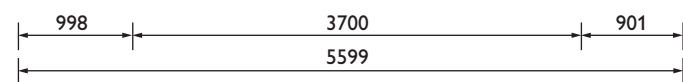
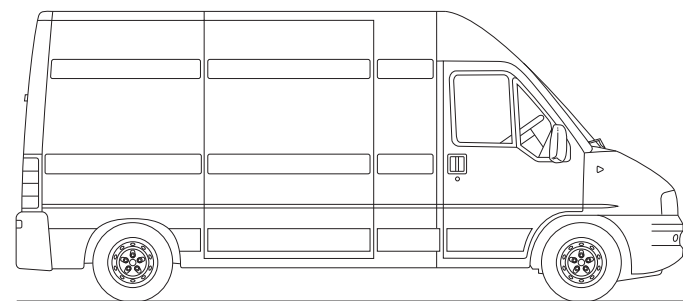

Height side door	<b>1.769 m</b>
Width side door	<b>1.265 m</b>
Height rear doors	<b>1.760 m</b>
Width rear doors	<b>1.562 m</b>

# | CHASSIS |

### Chassis cabs

	290 S	330 S	290 M	330 M	350 M	330 L	350 L	350 EL
Wheelbase	<b>2.85 m</b>	<b>2.85 m</b>	<b>3.2 m</b>	<b>3.2 m</b>	<b>3.2 m</b>	<b>3.7 m</b>	<b>3.7 m</b>	<b>4.05 m</b>
Payload before conversion	<b>1300 kg</b> <small>(2.0 l HDi)</small>	<b>1700 kg</b> <small>(2.0 l HDi)</small>	<b>1290 kg</b> <small>(2.0 l HDi)</small>	<b>1690 kg</b> <small>(2.0 l HDi)</small>	<b>1770 kg</b> <small>(2.2 l HDi)</small>	<b>1605 kg</b> <small>(2.2 l HDi)</small>	<b>1755 kg</b> <small>(2.2 l HDi)</small>	<b>1690 kg</b> <small>(2.8 l HDi)</small>
		<b>1630 kg</b> <small>(2.2 l HDi)</small>		<b>1620 kg</b> <small>(2.2 l HDi)</small>	<b>1745 kg</b> <small>(2.8 l HDi)</small>	<b>1580 kg</b> <small>(2.8 l HDi)</small>	<b>1730 kg</b> <small>(2.8 l HDi)</small>	
				<b>1595 kg</b> <small>(2.8 l HDi)</small>				



### Chassis crewcab

Wheelbase	<b>3.7 m</b>
Payload before conversion	<b>1575 kg</b> <small>(2.8 l HDi)</small>

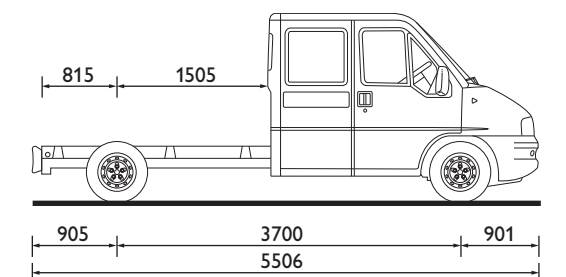
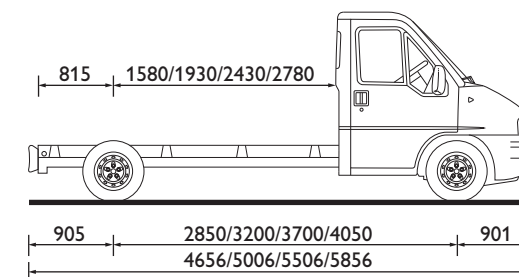

## | DRIVING AND SAFETY |

Power and safety are equally important to us; we couldn't develop one without considering the other. That's why we've made sure that every aspect, from the HDi engines and independent front suspension to the ventilated disc brakes, all work together to give you complete peace of mind.

### CRUISE CONTROL\*

To maintain a constant, controlled speed.

\*Available with 2.8 HDi engine only.

### CENTRALISED CONTROLS

In particular the electric windows\* and electric de-icing rear-view mirrors.

\*Standard on all models except 250.



### TELEMATICS EQUIPMENT\*

Includes the radio, CD player, emergency call button, GSM phone, trip computer, overspeed alarm and satellite navigation.

\*Optional on all models except 250.



- VIDEO CAMERA PARKING ASSISTANCE\*
- FRONT AND SIDE AIR BAGS\*
- ABS\*
- ASR TRACTION CONTROL\*\*
- 3RD BRAKE LIGHT
- ELECTRONIC IMMOBILISER

\* Option at extra cost (not available on 250).

\*\* Combined option with ABS, available on 350 LWB High roof 2.8 HDi only.



## | COMFORT AND PRACTICALITY |

With its multiple storage spaces and ingeniously designed interior, the Boxer isn't just practical, it's comfortable to drive as well.

### WRITING TABLE

The writing table saves space by folding into the back of the dual front seats.



### DOOR PANELS

The door panels of the Boxer have large armrests and spacious storage units.

- AIR CONDITIONING\*
- GLOVE BOX WITH KEY LOCK

\* Option at extra cost

### FOLDING DESKTOP

An office area carefully set out for making notes or holding directions.

\* Not fitted where passenger airbag specified



# | COMBI |

Safety is as important as comfort. That's why the driver and all the passengers have 3-point seat belts and head restraints. The second row of passenger head restraints are retractable as well, so it's easier to see where you're going when you reverse.



COMBI 5 SEATER



COMBI 6 SEATER

### SAFETY

For everyone's protection, all places benefit from 3-point seat belts.



### PRACTICAL

New attachments make it easier to install and remove the 3-seater bench seats.

- 1 Lower the back of the rear seat
- 2 Turn the handle and tilt the seat
- 3 Lift up the seat and remove it (two people are needed for this).

### COMFORT

Meticulous attention has been paid to the design of the seats to improve your comfort and that of your passengers.



# | TRIMS AND COLOURS |

All our light commercial vehicles have seats that are as hard wearing as they are good looking. And durable cloth or vinyl trim means that they'll stay that way for a long, long time.

## Boxer



**TRIMS**  
 - Chequer Blue Cloth  
 - Storm Grey vinyl

**SOLID COLOURS**  
 1 - Horizon Yellow  
 2 - Volcano Red  
 3 - Clipper Blue  
 4 - Bianca White  
 5 - Lagoon Blue  
 6 - Silverstone Green

**METALLIC COLOUR**  
 7 - Aluminium

**PEARLESCENT COLOURS**  
 8 - China Blue  
 9 - Iron Grey  
 10 - Ruby Red

Metallic or pearlescent paint is available as an option at extra cost on all models.

## Expert



**TRIM**  
 - Blue Volea cloth

**SOLID COLOURS**  
 1 - Clipper Blue  
 2 - Horizon Yellow  
 3 - Bianca White  
 4 - Ardent Red  
 5 - Onyx Black\*

**METALLIC COLOUR**  
 6 - Aluminium

**PEARLESCENT COLOURS**  
 7 - Iron Grey  
 8 - China Blue  
 9 - Ruby Red

\*Black paint is available on Special Order only as an extra cost option.

## Partner



**TRIM**  
 - Blue Westmorland cloth

**SOLID COLOURS**  
 1 - Bianca White  
 2 - Onyx Black  
 3 - Clipper Blue  
 4 - Ardent Red  
 5 - Silverstone Green

**METALLIC COLOURS**  
 6 - Kingfisher Blue  
 7 - Aluminium  
 8 - Moonstone

**PEARLESCENT COLOUR**  
 9 - Diablo Red



## | PARTNER ACCESSORIES |



### NAVIGATING YOU AROUND THE JAMS

Smartnav combines live, forecast, incident and historical traffic information to give you the best possible route from A to B. The powerful computer that calculates your route is housed outside your car, which means that the mapping information is always up to date. What's more, Smartnav will automatically react to any unforeseen changes in traffic conditions and where possible offer you an alternative route.



### DOG GUARD

Finished in matt black, the dog guard is simple to remove and replace. The installation does not require any drilling.



### DOOR MOUNTED WIND DEFLECTORS

They increase interior ventilation and minimise buffeting.



### TOWBAR

Engineered and extensively tested to the highest standards. Available with single or double electrics.



### ROOF BARS - 100 KG CAPACITY

The longitudinal roof rails can be simply transposed to create roof bars.

## | EXPERT ACCESSORIES |



### ROOF BARS

Capacity: 100 kg.



### LADDER

Allows easier access to items carried on the roof.



### ROOF RACK

Increase your carrying capacity with a roof length rack (capacity: 100 kg)



### RUBBER MAT

For effective protection of the original carpet.



### TOWBAR

Engineered and extensively tested to the highest standards. Available with single or double electrics.

## | BOXER ACCESSORIES |



### ROOF RACK

Increase your carrying capacity with a roof length rack. Sizes available fit all Boxer models. A loading roller can be added (200 kg capacity).



### CARGO MAT

Protects your load area.



### SECURITY GRILLES

Protect the contents of your vehicle by installing tailored window security grilles (set of 2 for rear window).



### CARPET MAT

Hard wearing anthracite carpet mat.

### LADDER

Allows easier access to items carried on the vehicle roof.



### TOWBAR

Engineered and extensively tested to the highest standards. Available with single or double electrics.

## The Peugeot Customer Promise

When you buy a new Peugeot vehicle from a Peugeot Dealer in the UK and entrust your vehicle to one of them for servicing or repair, they promise: to give you the best people, with the best training and diagnostic tools, original equipment Peugeot parts and the best aftersales backup, all at a competitive price.



### Peugeot Peace of Mind

Peugeot vehicles are designed and manufactured to give you worry-free motoring and peace of mind. As a Peugeot owner you are entitled to a comprehensive range of customer care services from your Peugeot Dealer who has the expertise to maintain your Peugeot to its peak performance.

### Peugeot Warranties

#### • 3 Years of Warranty

In addition to the 2 year unlimited mileage manufacturer's Warranty, all vehicles first registered in the UK and purchased from a UK Peugeot Dealer benefit from a free optional additional 1 year of Warranty provided by the Peugeot Dealer network in the UK. This additional Warranty carries a mileage limit of 60,000 miles (100,000 miles for Boxer models excluding Motorhomes and other

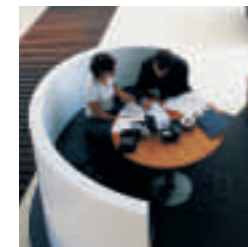

### Peugeot Assistance

converted vehicles) from first registration. The conditions of the additional 1 year Warranty are identical to those of the 2 year manufacturer's Warranty. (For full terms and conditions, please consult your Peugeot Dealer. NB: This 3 years of Warranty is automatically transferable on the sale of the vehicle.) At the end of the 3 years of Warranty (or 60,000 miles) you have the option to purchase a Peugeot Platinum Extended Warranty. This offers an almost identical level of peace of mind warranty cover for up to a maximum of a further 48 months (unlimited mileage). Contact your Peugeot Dealer for details.

#### • 12 Year Anti-Perforation and 3 Year Paint Warranty

Also automatically transferable on sale of the vehicle, this will maintain

and enhance the resale value of your vehicle. (The Anti-Perforation Warranty is limited to 6 years and the Paint Warranty to 2 years on 206 Van, Partner, Expert and Boxer vans.)

### Peugeot Assistance

For the first year of ownership you will automatically receive Peugeot Assistance cover for complete peace of mind. Additional Peugeot Assistance may be purchased for the second and third years. Operated by the RAC, it includes roadside assistance, vehicle recovery, free replacement vehicle or hotel accommodation and chauffeur provision in case of certain medical disabilities. Peugeot Assistance is available within the UK and Europe. Your local Peugeot Dealer has full details of terms and conditions.

### Peugeot Service Care

Peugeot petrol engine vehicles need servicing every 20,000 miles (12,000 2.0 litre 180 bhp engines) or every 2 years. Drivers of HDi diesel versions also benefit from extended servicing

with 12,000 miles (20,000 2.0 litre HDi 407, Expert & Boxer) or 2 year intervals. With less time spent in the maintenance bay and fewer service visits, Peugeot have passed on the benefits of technology in engine design and lubrication. In between scheduled services your Peugeot Dealer offers you a complementary intermediate visit (level check/top up) provided the appropriate, previous full service has been carried out at an authorised Peugeot Dealership.

In order to minimise the inconvenience associated with normal servicing, Peugeot UK Dealers promise to offer you the choice of:

- while you wait servicing with a timed appointment;
- or local vehicle collection from your home or place of work;
- or alternative transport to the railway station, home or place of work;
- or by arrangement, a hire vehicle at a concessionary rate.

In addition they will aim to ensure that your vehicle is washed before it is returned.

### Peugeot Insurance Centre

Peugeot Insurance has been specifically arranged for Peugeot owners. Offering discounted premiums and a fast and efficient claims service, it is another benefit of owning a Peugeot. Your Dealer can provide a proposal form for a free quotation or you can call the Peugeot Insurance Centre direct on **0870 024 0206** for a free quotation. Alternatively, contact: **Peugeot Insurance Centre The Wharf Neville Street Leeds LS1 4AZ**

Whatever Peugeot you drive, we guarantee you a competitive premium for your Motor Insurance. As a valued customer of Peugeot we'll make sure you get the very best premium quotation possible from Peugeot Insurance.

The information and images in this brochure are based on the current technical data when going to print. The equipment shown is factory fitted or available as an option at extra cost, depending on the model. Where a feature is described as an option it should be assumed that it is at extra cost unless specifically stated otherwise. There may be some feature combinations that are not available in the UK and some photography may feature left hand drive vehicles. As part of a policy of continuous specification improvement, Peugeot reserve the right to modify the technical equipment, options and colours at any time. For full specification ask your local Peugeot Dealer or click on [www.peugeot.co.uk](http://www.peugeot.co.uk). Note that current print and photographic techniques do not allow us to faithfully reproduce the full depth and tone of the colours in this brochure. This brochure is designed to provide general product information and is not a contractual document or offer of sale. For current information please contact your authorised Peugeot Dealer. The details in this catalogue cannot be reproduced without the express authorisation of Peugeot.



Issued by: Sales and Marketing, Peugeot Motor Company plc,  
Aldermoor House, PO Box 227, Aldermoor Lane, Coventry CV3 1LT.

For details of HM Forces tax-free military sales contact:  
Peugeot Export, 454-490 Mile End Road, London E1 4PE.  
Telephone: 020 7791 9050  
Email: [peugeot.export@peugeotmail.co.uk](mailto:peugeot.export@peugeotmail.co.uk)

For all other enquiries please call 0845 200 1234  
(calls will be charged at local rate, and may be  
recorded for training or quality purposes).

**[www.peugeot.co.uk](http://www.peugeot.co.uk)**

July 2004  
MCP 2240

