



The new Golf GT

Some illustrations in this brochure do not necessarily reflect UK specifications and may not be available. In particular, controls and some items of equipment are positioned differently for the UK. The specifications contained in this brochure are for information purposes only and are subject to change. If you require any specific feature, you must consult your authorised Volkswagen retailer who is regularly updated with any change in specification. Please check model availability and full specification details with your authorised Volkswagen retailer prior to ordering.



The new Golf GT. Now you can have the best of both worlds.

The Golf has always set the benchmark for economy and exhilaration, now with the new Golf GT you can drive a car which offers both.

Like every responsible motoring manufacturer, we've agreed to do our bit to lower carbon dioxide emissions and minimise fuel consumption. However, we don't want to do it at the expense of your driving pleasure. So we haven't.

The new GT comes equipped with ground-breaking TSI or TDI engines which produce phenomenal torque and power, while maintaining impressive fuel economy and low CO₂ emissions. This combination results in a car with dynamic performance, outstanding efficiency and is kinder to the environment, so you really can enjoy the best of both worlds.



Model shown is new Golf GT 1.4 litre TSI 170 PS with optional metallic paint.

Better to drive. Better for the planet.

The Golf has always been a pioneer in its class, setting new standards in power, performance and sheer driving enjoyment. Now comes another spine-tingling innovation, designed to get your pulse racing as never before, as TSI technology makes its debut in the new Golf GT. Representing a world first, this ground-breaking technology utilises FSI direct petrol injection, twin-charged by both a supercharger and turbocharger. The result is phenomenal – an engine that combines all the benefits of diesel with those of petrol, delivering outstanding responsiveness, economy and low emissions.

In addition, the new Golf GT is also available with cutting edge TDI technology. There is a choice of two engines, including a new 170 PS unit, which is the most powerful diesel engine ever in a Golf and capable of propelling it from 0 - 62 mph in just 8.2 seconds while returning excellent fuel economy. Never before have enjoyment and economy been so close.



Model shown is new Golf GT 2.0 litre TDI 140 PS with optional Bi-Xenon headlights and metallic paint.



01

Raising levels of safety.

As with engine technology, so with safety. Volkswagen sets the standards that others follow. Which is why the new Golf GT is not only equipped with six airbags – two in the front, two front seat side airbags and curtain airbag system for front and rear passengers – but also offers two optional side airbags in the rear should you choose a five door model. A number of active safety features are

also fitted to help defuse critical situations before they arise. These include an Electronic Stabilisation Programme (ESP) including Electronic Differential Lock (EDL) and Traction Control (ASR), plus an Anti-lock Braking System (ABS) with Hydraulic Brake Assist (HBA). These systems detect critical situations at an early stage and take action, for example, by specifically adjusting the engine's power output and braking individual wheels helping to bring the vehicle under control.

Setting standards in technology.

With the new 1.4 litre TSI 170 PS engine, Volkswagen has pushed technology to new limits, developing the world's first ever twin-charged FSI direct injection petrol engine. Achieving 0 - 62 mph in just 7.9 seconds, with high torque delivering maximum power at both low revs and high speeds, it delivers dramatic performance. Yet returning 38.2 mpg on the Combined cycle, it also delivers exceptional fuel economy and low CO₂ emissions of 178 g/km. This innovative technology was recognised by motoring experts when it was named 'Best New Engine 2006' at the International Engine of the Year awards.

The first diesel variant available in the new Golf GT is the powerful 2.0 litre 170 PS TDI engine with DPF (Diesel Particulate Filter). Like the TSI, it ensures low fuel consumption, allied with Volkswagen's renowned long-life, low maintenance engine technology. It boasts 350 Nm of torque at 2,000 rpm while still returning 46.3 mpg on the Combined cycle with a six speed manual gearbox. The second variant is a 2.0 TDI unit which delivers an impressive 140 PS and returns 49.6 mpg on the Combined cycle*.

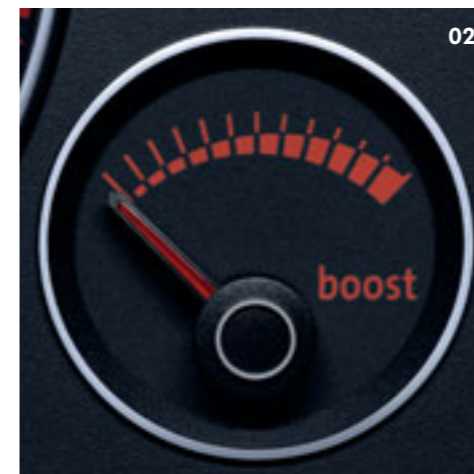

02



03

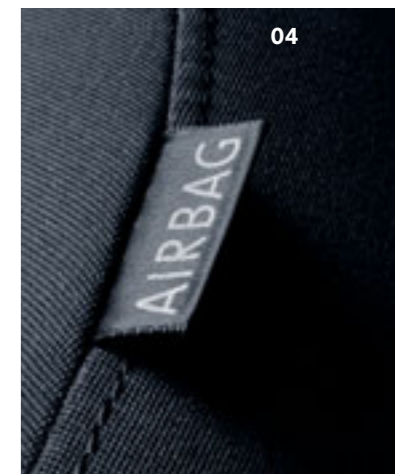

04

- 01** The twin-charged engine – comprising a mechanically-driven supercharger and exhaust-driven turbocharger – which work in tandem to eliminate turbo lag enabling the TSI engine to achieve maximum torque at both low revs and high speed.
- 02** The boost pressure dial within the instrument panel in the dashboard assembly informs you how much power the TSI engine is generating.

- 03** ESP, the sensor-controlled Electronic Stabilisation Programme, recognises critical driving situations and reacts in milliseconds by reducing the engine's output and controlling the speed of individual wheels.
- 04** The front seat side impact airbags provide protection for the driver and front seat passenger in the event of a side collision. Optional side airbags for rear seat passengers can also be specified on five door models.

* Please see Environmental information sections for fuel consumption and CO₂ emissions figures.



01

A sensory experience.

As you'd expect from a true sports performer, the GT's exterior hints at the promise of what is to come. Sports suspension lowered by approximately 15 mm and 17 inch 'ClassiXs' alloy wheels with wide 225/45 R17 tyres set the scene, while twin exhaust tailpipes (170 PS engines only) and the GT styling pack carry on the theme.

Inside the aesthetics exude comfort and control. The front sports seats with lumbar and height adjustment in 'Brick' upholstery give you comfortable support when taking tight corners, while the 'Smooth Black' decorative inserts enhance the sports appeal. The three-spoke leather trimmed steering wheel with GT logo leaves you in no doubt as to what you're driving, and the multifunction dashboard display with integral boost pressure dial (TSI engine only) provides you with essential information at a glance. This is a car that not only performs – it looks good too.

01 The interior of the new Golf GT exudes a feeling of comfort, control and pure sports appeal. The DVD satellite navigation system including front centre armrest, 2Zone electronic climate control and metallic paint are optional at extra cost.

02 The multifunction display provides a wealth of information such as current and average fuel consumption, range, distance driven, average speed and driving time.

03 The three-spoke leather steering wheel is ergonomically designed for comfort and is aesthetically pleasing with its unique GT logo.

04 The badge on the front grille places the GT in distinguished company and identifies the new Golf GT as a true sports performer.



02



03



04

Taking dynamics in a new direction.

If your curiosity has been aroused and your senses stimulated by the thought of a car that combines the Golf's sporting pedigree with Volkswagen's revolutionary technology, there is only one course of action to take. Sit behind the wheel and try it for yourself. Only then will you understand how Volkswagen is taking sporting dynamics in a new direction, to a level others can only emulate. As ever, the Volkswagen Golf leads the field.



Model shown is new Golf GT 1.4 litre TSI 170 PS with optional Bi-Xenon headlights and metallic paint.

Paint and upholstery.

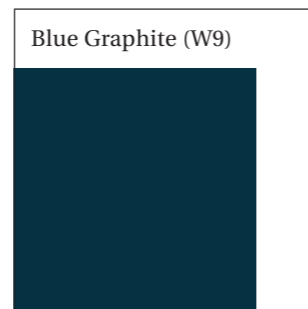
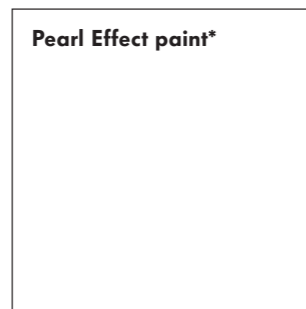
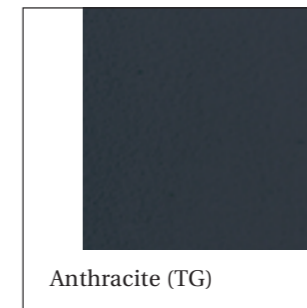
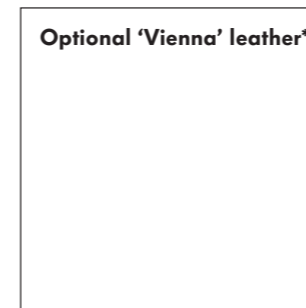
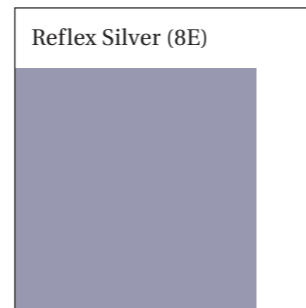
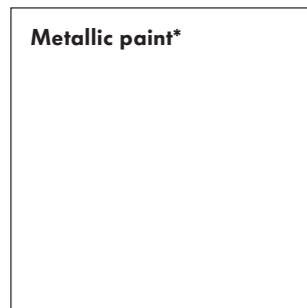
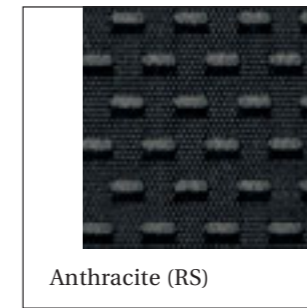
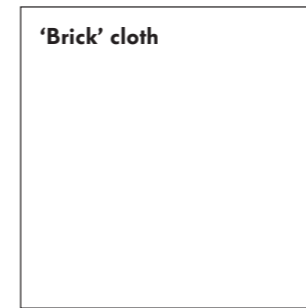
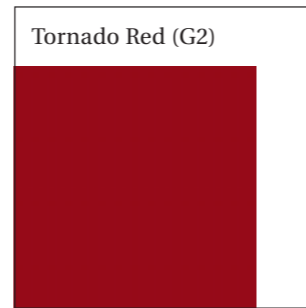
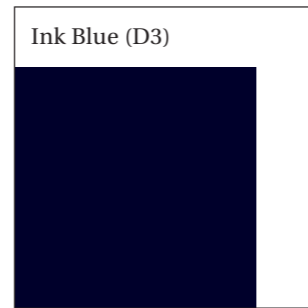
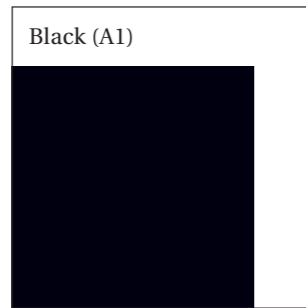
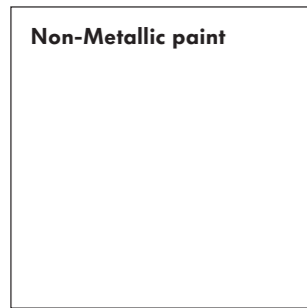

* Metallic, pearl effect paints and leather upholstery are optional at extra cost.
Some parts of leather interior will contain artificial leather.

Please note: Screen technology does not allow exact reproduction of the paint and upholstery colours.

Colour combinations.

	Seat upholstery	Carpets	Dashboard	Black (A1)	Ink Blue (D3)	Tornado Red (G2)	Shadow Blue metallic* (P6)	Steel Grey metallic* (X6)	Reflex Silver metallic* (8E)	Blue Graphite pearl effect* (W9)	Diamond Black pearl effect* (Z4)
'Brick' cloth upholstery	Anthracite (RS)	Black	Anthracite	●	●	●	●	●	●	●	●
Optional 'Vienna' leather*	Anthracite (TG)	Black	Anthracite	○	○	○	○	○	○	○	○

● Standard ○ Optional

* Metallic, pearl effect paints and leather upholstery are optional at extra cost. Some parts of leather interior will contain artificial leather.

Standard equipment.

Volkswagen service

- 3-year/60,000 miles warranty (whichever is soonest)
- 3-year paintwork warranty
- 12-year body protection warranty
- Volkswagen Assistance

Please see Service section for more details

Exterior

- Alloy wheels, four 7J x 17 'ClassiXs' with 225/45 R17 tyres and anti-theft wheel bolts
- Body-coloured bumper strips
- Body-coloured door mirrors with integrated indicators
- Body-coloured front grille
- Body-coloured side bump strips and door handles
- Exterior temperature gauge
- GT styling pack – including uniquely shaped front bumper
- Halogen clear headlights, range adjustable
- Heat insulating tinted glass
- Twin exhaust tailpipe (170 PS engines only)

Interior

- Leather trimmed three-spoke steering wheel with GT logo
- 'Smooth Black' decorative inserts in dash and centre console
- Upholstery – 'Brick' cloth

Safety

- ABS (Anti-lock Braking System) with HBA (Hydraulic Brake Assist)
- Automatic hazard lights activation under emergency braking
- Curtain airbag system, for front and rear passengers
- Disc brakes, front and rear (front ventilated)
- Driver's and front passenger's airbags with passenger's airbag deactivation switch
- Driver's and front passenger's whiplash-optimised head restraints
- Electronic engine immobiliser
- ESP (Electronic Stabilisation Programme) including EDL (Electronic Differential Lock) and ASR (Traction Control)
- Front seat side impact airbags
- Height-adjustable front three-point seat belts with tensioners
- Isofix child seat preparation (for 2 rear child seats)
- Reflectors in front and rear doors
- Warning buzzer and light for front seat belts if unfastened
- 3 rear head restraints
- 3 rear three-point seat belts

Function

- Additional storage compartment in roof console
- Air conditioning, 'Climatic' semi-automatic control
- Alarm with interior protection
- Automatic coming/leaving home lighting function
- Bag hooks in luggage compartment, x 2
- Coat hooks, rear x 2
- Cup holders, front x 2, rear x 1 (for up to 1.0 litre bottle)
- Dusk sensor, automatic driving lights
- Dust and pollen filter
- Easy entry sliding seats (for access to rear seats – 3 door only)
- Electrically heated and adjustable door mirrors
- Electric windows, front and rear (rear 5 door only)
- Front fog lights
- Front footwell illumination
- Front seat back storage pockets
- Front sport seats with height and lumbar adjustment
- Glovebox, cooled
- Grab handles, front x 2, rear x 2 with integrated coat hooks
- Height and reach adjustable steering wheel
- Instrument lighting, blue adjustable panel illumination
- Interior light delay
- Luggage compartment cover
- Luggage compartment light

Function (continued)

- Multifunction computer (Midline)
- Non-smoking pack
- Power-assisted steering, speed-sensitive
- Radio/CD player with 8 speakers and roof aerial
- Rain sensor and automatic dimming interior rear-view mirror
- Reading lights, chrome surrounds, independent front and rear
- Rear screen wash/wipe with intermittent wipe
- Remote central locking with 2 remote folding keys
- Remote interior fuel flap opener
- Speedo and rev counter, electronic odometer, trip, service interval display and fuel gauge
- Sports suspension, lowered by approx. 15 mm
- Split folding rear seats
- Steel space saver spare wheel
- Storage compartments in front doors (for 1.0 litre bottles)
- Storage compartment in rear doors
- Two-tone horn
- Vanity mirrors, illuminated
- Warning 'lights on' buzzer
- Windscreen wiper with intermittent wipe and 4 position delay
- 12V socket in luggage compartment

The above specifications are for information purposes only as our products are continually updated and changes may be made to the specifications at any time. If you require any specific feature, you must consult your authorised Volkswagen retailer who is regularly updated with any change in specification. Specifications are subject to change without notice.

1.4 litre TSI 170 PS.

Technical specification.

		Manual	Automatic
Engine	Engine type	Four cylinder petrol	Four cylinder petrol
	Cubic capacity, ltrs/cc	1.4/1390	1.4/1390
	Bore/stroke, mm	76.5/75.6	76.5/75.6
	Max. output, PS ⁽⁰¹⁾ /kW at rpm	170/125 6000	170/125 6000
	Max. torque, lbs.ft/Nm at rpm	177/240 1750	177/240 1750
	Compression ratio	10.0 : 1	10.0 : 1
	Gearbox	Six speed manual	Six speed auto DSG
	Alternator, A	110	110
	Battery, A (Ah)	220 (44)	220 (44)
Weights, kgs	Unladen weight ⁽⁰²⁾	1429	1451
	Gross vehicle weight	1850	1870
	Payload ⁽⁰²⁾	421	419
	Axle load limit: Front	1020	1030
	Rear	900	910
Trailer load limits, kgs ⁽⁰³⁾	Braked 12% incline	1400	1400
	Unbraked	650	680
Performance	Top speed (where law permits), mph (km/h)	137 (220)	135 (218)
	Acceleration, secs 0 - 62 mph	7.9	7.7
	ABI insurance group	16	16
Environmental information	Fuel grade, minimum	Unleaded, 95 RON ⁽⁰⁴⁾	Unleaded, 95 RON ⁽⁰⁴⁾
	Fuel tank capacity, galls/ltrs	12.1/55	12.1/55
	Official fuel consumption, mpg/ltr per 100 km ⁽⁰⁶⁾		
	Urban	28.8/9.8	28.2/10.0
	Extra-urban	46.3/6.1	47.9/5.9
	Combined	38.2/7.4	38.2/7.4
	Official CO ₂ emission, g/km ⁽⁰⁷⁾	178	178
	Emission class	EURO 4	EURO 4
Noise, dB	74.0	73.0	

Notes.

- 01) The maximum power output figures are quoted in PS (or Pferdestärke, which is the metric equivalent of horsepower). To convert from metric to imperial horsepower, divide the PS figure by 1.0139.
- 02) Figures are calculated in accordance with manufacturer's criteria. Vehicle unladen weight ranges with 90% tank capacity without driver. The individual unladen weight depends on the specification of the vehicle, this then reduces the possible payload accordingly.
- 03) With increasing altitude the engine performance diminishes. From 1,000 m above sea level and for every 1,000 m thereafter 10% of the vehicle/trailer weight (trailer weight + gross vehicle weight) must be deducted.
- 04) Thanks to the knock control, unleaded four star (at least 95 RON) can be used instead of unleaded Super plus. In order to achieve maximum fuel consumption benefits on the FSI engine, Ultra Low Sulphur Petrol (ULSP) must be used.
- 05) The use of RME and FAME (bio diesel) is not possible.
- 06) Official fuel consumption according to EU Directive 99/94. The consumption calculation according to 1999/100/EC is based on the actual unladen weight of the vehicle. Additional specifications can lead to a higher weight class and hence to consumption figures of this higher weight class. The driving style, road and traffic conditions, environmental influences and vehicle condition can in practice lead to consumption figures, which may differ from those calculated with this standard.
- 07) The weight of a vehicle will influence the level of CO₂ emission it produces; as a result, vehicles with higher levels of specification and factory-fitted options may emit higher levels of CO₂. The CO₂ figure quoted for each vehicle is the maximum possible. The unladen weight of the vehicle is calculated by range at the time of manufacture and the maximum possible CO₂ emission for that weight range is applied according to the Council Directive 80/1268EEC as amended by Commission Directive 1999/100/EC on the approximation of the laws of the member states relating to the carbon dioxide emissions and the fuel consumption of motor vehicles.

2.0 litre TDI 140 PS.

Technical specification.

		Manual	Automatic
Engine	Engine type	Four cylinder diesel	Four cylinder diesel
	Cubic capacity, ltrs/cc	2.0/1968	2.0/1968
	Bore/stroke, mm	81.0/95.5	81.0/95.5
	Max. output, PS ⁽⁰¹⁾ /kW at rpm	140/103 4000	140/103 4000
	Max. torque, lbs.ft/Nm at rpm	236/320 1750	236/320 1750
	Compression ratio	18.5 : 1	18.5 : 1
	Gearbox	Six speed manual	Six speed auto DSG
	Alternator, A	140	140
	Battery, A (Ah)	340 (70)	340 (70)
Weights, kgs	Unladen weight ⁽⁰²⁾	1451	1486
	Gross vehicle weight	1870	1900
	Payload ⁽⁰²⁾	419	414
	Axle load limit: Front Rear	1070 870	1100 870
Trailer load limits, kgs ⁽⁰³⁾	Braked 12% incline	1400	1400
	Unbraked	670	690
Performance	Top speed (where law permits), mph (km/h)	127 (205)	126 (203)
	Acceleration, secs 0 - 62 mph	9.3	9.3
	ABI insurance group	13	13
Environmental information	Fuel grade, minimum	Diesel ⁽⁰⁵⁾	Diesel ⁽⁰⁵⁾
	Fuel tank capacity, galls/ltrs	12.1/55	12.1/55
	Official fuel consumption, mpg/ltr per 100 km ⁽⁰⁶⁾		
	Urban	39.8/7.1	35.3/8.0
	Extra-urban	58.9/4.8	56.5/5.0
	Combined	49.6/5.7	46.3/6.1
	Official CO ₂ emission, g/km ⁽⁰⁷⁾	154	160
Emission class	EURO 4	EURO 4	
Noise, dB	72.0	71.0	

Notes.

- 01) The maximum power output figures are quoted in PS (or Pferdestärke, which is the metric equivalent of horsepower). To convert from metric to imperial horsepower, divide the PS figure by 1.0139.
- 02) Figures are calculated in accordance with manufacturer's criteria. Vehicle unladen weight ranges with 90% tank capacity without driver. The individual unladen weight depends on the specification of the vehicle, this then reduces the possible payload accordingly.
- 03) With increasing altitude the engine performance diminishes. From 1,000 m above sea level and for every 1,000 m thereafter 10% of the vehicle/trailer weight (trailer weight + gross vehicle weight) must be deducted.
- 04) Thanks to the knock control, unleaded four star (at least 95 RON) can be used instead of unleaded Super plus. In order to achieve maximum fuel consumption benefits on the FSI engine, Ultra Low Sulphur Petrol (ULSP) must be used.
- 05) The use of RME and FAME (bio diesel) is not possible.
- 06) Official fuel consumption according to EU Directive 99/94. The consumption calculation according to 1999/100/EC is based on the actual unladen weight of the vehicle. Additional specifications can lead to a higher weight class and hence to consumption figures of this higher weight class. The driving style, road and traffic conditions, environmental influences and vehicle condition can in practice lead to consumption figures, which may differ from those calculated with this standard.
- 07) The weight of a vehicle will influence the level of CO₂ emission it produces; as a result, vehicles with higher levels of specification and factory-fitted options may emit higher levels of CO₂. The CO₂ figure quoted for each vehicle is the maximum possible. The unladen weight of the vehicle is calculated by range at the time of manufacture and the maximum possible CO₂ emission for that weight range is applied according to the Council Directive 80/1268EEC as amended by Commission Directive 1999/100/EC on the approximation of the laws of the member states relating to the carbon dioxide emissions and the fuel consumption of motor vehicles.

2.0 litre TDI DPF 170 PS.

Technical specification.

		Manual	Automatic
Engine	Engine type	Four cylinder diesel	Four cylinder diesel
	Cubic capacity, ltrs/cc	2.0/1968	2.0/1968
	Bore/stroke, mm	81.0/95.5	81.0/95.5
	Max. output, PS ⁽⁰¹⁾ /kW at rpm	170/125 4200	170/125 4200
	Max. torque, lbs.ft/Nm at rpm	258/350 2000	258/350 2000
	Compression ratio	18.5 : 1	18.5 : 1
	Gearbox	Six speed manual	Six speed auto DSG
	Alternator, A	140	140
	Battery, A (Ah)	330 (61)	330 (61)
Weights, kgs	Unladen weight ⁽⁰²⁾	1445	1480
	Gross vehicle weight	1870	1900
	Payload ⁽⁰²⁾	425	420
	Axle load limit: Front	1060	1090
	Rear	880	880
Trailer load limits, kgs ⁽⁰³⁾	Braked 12% incline	1500	1500
	Unbraked	680	700
Performance	Top speed (where law permits), mph (km/h)	137 (220)	135 (218)
	Acceleration, secs 0 - 62 mph	8.2	8.2
	ABI insurance group	16	16
Environmental information	Fuel grade, minimum	Diesel ⁽⁰⁵⁾	Diesel ⁽⁰⁵⁾
	Fuel tank capacity, galls/ltrs	12.1/55	12.1/55
	Official fuel consumption, mpg/ltr per 100 km ⁽⁰⁶⁾		
	Urban	35.8/7.9	34.4/8.2
	Extra-urban	56.5/5.0	51.4/5.5
	Combined	46.3/6.1	43.5/6.5
	Official CO ₂ emission, g/km ⁽⁰⁷⁾	160	176
	Emission class	EURO 4	EURO 4
Noise, dB	73.0	71.0	

Notes.

- 01) The maximum power output figures are quoted in PS (or Pferdestärke, which is the metric equivalent of horsepower). To convert from metric to imperial horsepower, divide the PS figure by 1.0139.
- 02) Figures are calculated in accordance with manufacturer's criteria. Vehicle unladen weight ranges with 90% tank capacity without driver. The individual unladen weight depends on the specification of the vehicle, this then reduces the possible payload accordingly.
- 03) With increasing altitude the engine performance diminishes. From 1,000 m above sea level and for every 1,000 m thereafter 10% of the vehicle/trailer weight (trailer weight + gross vehicle weight) must be deducted.
- 04) Thanks to the knock control, unleaded four star (at least 95 RON) can be used instead of unleaded Super plus. In order to achieve maximum fuel consumption benefits on the FSI engine, Ultra Low Sulphur Petrol (ULSP) must be used.
- 05) The use of RME and FAME (bio diesel) is not possible.
- 06) Official fuel consumption according to EU Directive 99/94. The consumption calculation according to 1999/100/EC is based on the actual unladen weight of the vehicle. Additional specifications can lead to a higher weight class and hence to consumption figures of this higher weight class. The driving style, road and traffic conditions, environmental influences and vehicle condition can in practice lead to consumption figures, which may differ from those calculated with this standard.
- 07) The weight of a vehicle will influence the level of CO₂ emission it produces; as a result, vehicles with higher levels of specification and factory-fitted options may emit higher levels of CO₂. The CO₂ figure quoted for each vehicle is the maximum possible. The unladen weight of the vehicle is calculated by range at the time of manufacture and the maximum possible CO₂ emission for that weight range is applied according to the Council Directive 80/1268EEC as amended by Commission Directive 1999/100/EC on the approximation of the laws of the member states relating to the carbon dioxide emissions and the fuel consumption of motor vehicles.

The technology.

Transmission

- Front wheel drive through asbestos-free single-plate dry clutch. Hydraulic clutch-mechanism. Six speed manual gearbox with double joint half axles
- Six speed manual: 1.4 litre 170 PS TSI, 2.0 litre 140 PS TDI, 2.0 litre 170 PS TDI DPF
- Six speed automatic DSG: 1.4 litre 170 PS TSI, 2.0 litre 140 PS TDI, 2.0 litre 170 PS TDI DPF

Steering

- Electro-mechanical steering rack, height and lengthways adjustable
- Collapsible safety steering column

Running gear

- Electronic Stabilisation Programme (ESP) including Electronic Differential Lock (EDL) and Traction Control (ASR)
- Front suspension through coil springs with telescopic shock absorbers, all elements integrated in chassis legs
- Rear suspension with gas pressure shock absorbers and separate springs
- Wheel control: front through chassis legs and (lower) triangular wishbones (directionally stabilising steering roll radius)
- Wheel control: rear through four-link suspension with independent wheel suspension
- Front and rear anti-roll bar

Brakes

- Electronically controlled Anti-lock Braking System (ABS) with Electronic Brake-pressure Distribution (EBD)
- Diagonal twin-circuit brake system with inner-ventilated front disc brakes and rear disc brakes
- Asbestos-free brake pads

Engines

- Front transverse-installed engine
- 1.4 litre/170 PS¹ (125 kW) petrol engine: TBA
- 2.0 litre/140 PS¹ (103 kW) diesel engine: four cylinder in-line engine, four valves per cylinder, electronically controlled direct injection with pump injector unit, oil cooler, intercooler, exhaust gas recirculation, oxidation catalyst, turbocharger with variable turbine geometry
- 2.0 litre/170 PS¹ (125 kW) diesel engine: TBA

Dimensions.

Maximum luggage capacity, cu.ft (litres) VDA measuring method using 200 x 100 x 50 mm blocks

With rear seat upright*	12.4 (350)
With rear seat folded*	46.1 (1305)

* With standard steel space saver spare wheel.

Exterior dimensions

Length, mm	4204
Width – excluding door mirrors, mm	1759
Width – opened front doors (3 door/5 door), mm	4050/3630
Height, mm	1479
Height – opened bonnet/floor, mm	1764
Height – opened tailgate/floor, mm	2055
Wheelbase, mm	2578

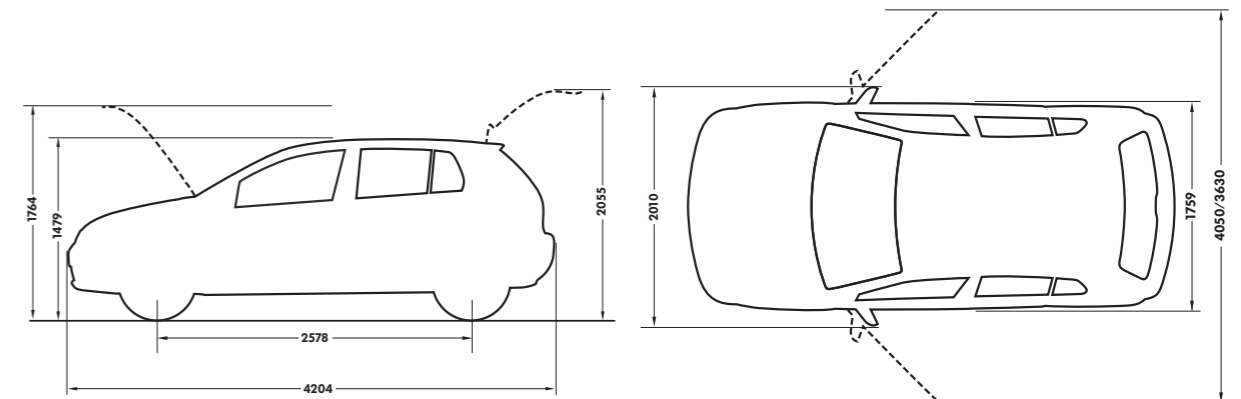

¹ The maximum power output figures are quoted in PS (or Pferdestärke, which is the metric equivalent of horsepower). To convert from metric to imperial horsepower, divide the PS figure by 1.0139.

Volkswagen service for your peace of mind.

The Volkswagen Warranty.

Three-year Warranty.

All Volkswagen new Golf GTs come with a three-year/60,000 miles warranty, which protects your car against the failure of most mechanical and electrical components due to manufacturing defects. This comprises a two-year manufacturer's warranty with unlimited mileage plus a further one-year/60,000 miles (whichever is soonest) Retailer Warranty. Should the mileage exceed 60,000 miles within the first two years, the manufacturer's two-year warranty will still be valid. If an additional warranty for subsequent years or higher mileage is desired, it may be purchased from an authorised Volkswagen retailer or repairer; however, this additional warranty must be purchased before the mileage reaches 60,000. Full details of the three-year warranty are available from your authorised Volkswagen retailer or repairer.

Three-year Paint Warranty.

The paintwork of the new Golf GT is covered against manufacturing defects for a period of three years. Naturally, the new Golf GT must be cared for in compliance with the operating instructions which will be found in your vehicle handbook. Please consult your authorised Volkswagen retailer or repairer for full warranty details.

12-year Body Protection Warranty.

The internal body sections and panels of the new Golf GTs are covered against rusting through from the inside for 12 years. Naturally, the new Golf GT must be cared for in compliance with the operating instructions. Please consult your authorised Volkswagen retailer or repairer for full warranty details.

Service Intervals.

Volkswagen are pleased to offer you a choice on how your new Golf GT is serviced. The appropriate selection is entirely dependent on how the car is likely to be driven and its general use. To help you identify which type of service would be most suitable, please refer to the following guide.

The Time and Distance Service is recommended for vehicles that will cover less than 10,000 miles in 12 months and if the vehicle is likely to be used in the following way:

- Predominantly urban driving, short journeys with frequent cold starts.
- Activities regularly producing high engine loading, e.g. frequent hill climbs, driving with vehicle fully loaded and towing.
- Uneconomical driving style using high rpms with heavy acceleration and heavy braking.

The service intervals for the Time and Distance Service are as follows:

- Oil change service
Every 10,000 miles/1 year (whichever is soonest).
- Interval service
Every 20,000 miles/2 years (whichever is soonest).
- Interval service inspection
Every 40,000 miles/4 years (whichever is soonest).

The LongLife Service is recommended for vehicles with a daily mileage of more than 25 miles where the vehicle is driven regularly mainly on longer distance journeys. The vehicle is driven mainly at a constant speed with minimum vehicle and engine loading, minimal towing and driven in an economical manner.

With the LongLife Service the vehicle can cover anywhere between 10,000* and a maximum of 20,000* miles or 24 months (whichever is soonest).

* Please note that mileages are approximate as the service indicator system uses kilometres as the distance measurement. Please consult your authorised Volkswagen retailer or repairer for advice and full details.

Approved Accessories.

A comprehensive range of accessories from alloy wheels to carpet mats is available to complement the factory-fitted option list. Volkswagen approved accessories purchased from and fitted by your authorised Volkswagen retailer at the point of vehicle sale will also benefit from the three-year vehicle warranty.

Volkswagen Insurance.

Competitive insurance premiums are available to Volkswagen owners through Volkswagen Insurance Service (Great Britain) Limited. Volkswagen Insurance guarantees that all repair work is undertaken by an authorised Volkswagen retailer or repairer. For a quotation, telephone Linkline on 0845 600 8006.

Extended Warranty.

You may purchase additional protection from your authorised Volkswagen retailer or repairer, or contact 0870 9000 115.

Volkswagen Finance†.

Volkswagen Finance specialises in providing funding solutions for Volkswagen drivers. Whether your Volkswagen is for private or business use, you can choose from a range of funding options.

- Solutions – a personal contract plan
- Hire purchase
- Lease purchase
- Finance lease
- Contract hire

With all Volkswagen Finance products you can choose a fixed-cost maintenance plan to help you budget for your servicing and maintenance costs.

No matter what finance product you choose, your local Volkswagen retailer will be able to provide you with a personalised quote that could meet your budget and vehicle needs.

Volkswagen Assistance.

Every new car is registered for Volkswagen Assistance for one year. This provides vehicle recovery in the unlikely event of a breakdown (subject to conditions). Volkswagen Assistance can also be purchased for subsequent years. For full details, please contact your authorised Volkswagen retailer.

Tax Free Sales.

For full details, please contact your authorised Volkswagen retailer.

CO₂ Emission.

The weight of a vehicle will influence the level of CO₂ emission it produces; as a result, vehicles with higher levels of specification and factory-fitted options may emit higher levels of CO₂.

The CO₂ figure quoted for each vehicle is the maximum possible. The unladen weight of the vehicle is calculated by range at the time of manufacture and the maximum possible CO₂ emission for that weight range is applied according to the Council Directive 80/1268EEC as amended by Commission Directive 1999/100/EC on the approximation of the laws of the member states relating to the carbon dioxide emissions and the fuel consumption of motor vehicles.

Please Note:

Some illustrations in this brochure do not necessarily reflect UK specifications and may not be available. In particular, controls and some items of equipment are positioned differently for the UK.

The specifications contained in this brochure are for information purposes only and are subject to change. If you require any specific feature, you must consult your authorised Volkswagen retailer who is regularly updated with any change in specification. Please check model availability and full specification details with your authorised Volkswagen retailer prior to ordering.

Note: We would like to advise you that telephone calls to Volkswagen Customer Care may be monitored and recorded as part of our training and quality assurance processes. All our monitoring and recording processes meet Ofcom regulations.

† Volkswagen Finance is a trading name of Volkswagen Financial Services (UK) Limited. An offer of finance depends on certain conditions. Available to people over 18 in the UK only.