



The New Beetle and New Beetle Cabriolet





01

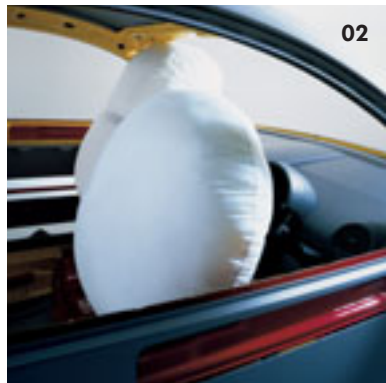

02

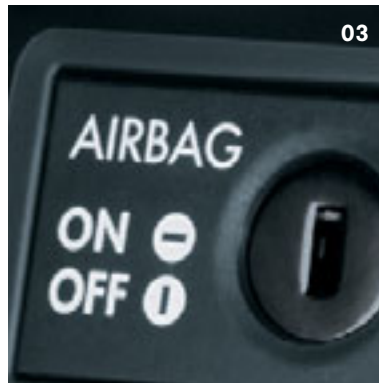

03



04

01 The standard side airbags help protect the driver and front seat passenger in the event of a side impact.

02 Driver and front passenger airbags are standard to help protect the front seat occupants.

03 The front passenger airbag can be deactivated, to allow the use of a rear facing child seat, by the simple turn of a key.

04 ABS helps you to steer around potential hazards, under hard braking, by preventing the wheels from locking.



05

05 In a potentially dangerous situation, the Electronic Stabilisation Programme (ESP) will intervene to diffuse the problem. Through the brake and engine management systems, it will specifically slow down individual wheels for greater stability. However, this enhanced system should not lead to carelessness, because ESP cannot defy the laws of physics. In conjunction with ESP, two other systems are in force to provide improved roadholding and safety. They are Electronic Differential Lock (EDL) and Traction Control (ASR) – a formidable combination to help the vehicle’s stability and grip on poor or wet surfaces.

06 The New Beetle Cabriolet’s rollover protection system is hidden behind the rear backrests. Through intelligent electronic sensors, the possibility of a rollover or impact will be detected and immediate action taken. Within milliseconds the rollover bars will eject and, together with the reinforced windscreen frame, provide protection to passengers.

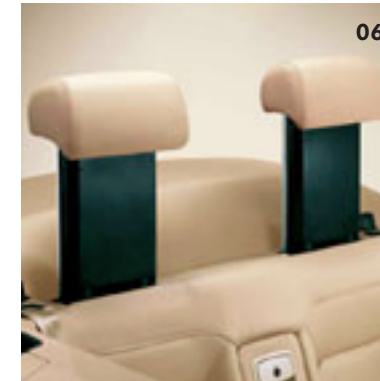

06

The epitome of modern day safety.

We know you’ll enjoy driving the New Beetle, but we want you to feel totally safe and secure as well. The chassis, for example, is strengthened at important points across the bodywork. Such joints absorb energy, and help to keep the inner protective safety cell intact following a collision. You’ll also notice that in the New Beetle Cabriolet there’s no rollover bar to obstruct the view of the clear blue sky. You can be assured however that it’s there if you need it. At the slightest hint of a roll or impact, rollover bars eject from the rear backrests and together with a reinforced windscreen frame provide exceptional protection to passengers.

In addition to front airbags (passenger’s front airbag can be deactivated if required), the driver and front passenger have the reassurance of side airbags, an Electronic Stabilisation Programme (ESP) for exceptional roadholding on poor or wet surfaces and front active head restraints which help lower the risk of whiplash injuries in the event of an accident. The two rear passengers are protected by three-point seat belts and head restraints.

In fact, there are numerous electronic features that are constantly monitoring and assessing the driving situation and they are ready to react in milliseconds should the need arise. We believe that prevention is the safest form of protection. And when you feel safe, you can enjoy the touring experience of the New Beetle and New Beetle Cabriolet even more.

In addition, there is the innovative Isofix child seat mounting system. This allows children’s seats, equipped with the Isofix system, to be fitted securely to the New Beetle and New Beetle Cabriolet’s body via eyes between the rear seat backrest and seat base. Child seats with the Isofix system can be purchased from your Volkswagen retailer.



A galvanised body can be admired for years to come.

With the Volkswagen New Beetle and New Beetle Cabriolet, quality takes on a new importance. Because with a car that looks so good, you'll want to enjoy its classic design for as long as possible. The complete body of both models is therefore galvanised to protect against corrosion. Moreover, your Volkswagen retailer even gives you a 12-year warranty against rusting through.

The excellent build quality of the New Beetle and New Beetle Cabriolet is evident in many other ways, for example, the narrow and uniform gaps between the body panels. Such precision build is possible because of its great body rigidity achieved through special bonding techniques on areas of particular strain. Close fit panels have numerous benefits including reduced wind noise and improved aerodynamics which in turn lead to reduced fuel consumption. Not only is body strength an important safety measure, it's also key to great roadholding.

Impressive build quality is not only seen, it can be heard and felt as well. Like the sound the door makes as it closes or how the refined interior surfaces are pleasant to touch.

The excellent quality also shows in another, crucial field: repair friendliness. The wings and bumpers are made of resilient plastic and bolted to the body. Consequently, some panels can be exchanged in minutes, for example after parking damage.

- 01** The narrow tolerances between the panels highlight the exceptional build quality.
- 02** The use of computerised construction techniques helps ensure the precise fit of every panel.
- 03** Perfect workmanship provides a perfect finish.





Model shown is 2.0 litre with optional Sunflower paint.

Performance-enhanced beauty.



A unique exterior and interior.

New Beetle driving is about enjoyment. So to maximise your enjoyment we thought you'd appreciate loads of great features. Like ESP, power steering, central locking, front electric windows and body-coloured door mirrors with integrated indicators which are also electrically heated and adjustable. The driver's side door mirror is also fitted with wide angle glass to make overtaking safer.

You'll also find a powerful 'Gamma' radio/CD player with six loudspeakers in the New Beetle, and 10 in the New Beetle Cabriolet. It not only provides terrific stereo sound – it also blends perfectly with the New Beetle's dashboard design.

01 The unique interior of the New Beetle is trimmed with 'Eclipse' cloth upholstery, and features a useful front centre armrest with storage compartment.

02 An extensive list of interior features includes a digital clock and exterior temperature gauge.

03 The remote switches for the boot and petrol cover are positioned in the driver's door for easy reach.

04 A glance at the clear and easy to read dashboard will provide you with important data.

05 Sporty 16" 'Houston' alloy wheels with 205/55 tyres are standard on the Luna 1.4 litre and Luna 1.6 litre models for both the New Beetle and New Beetle Cabriolet.

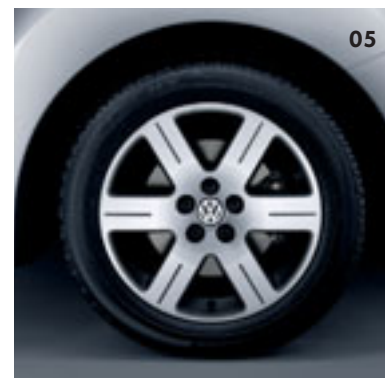
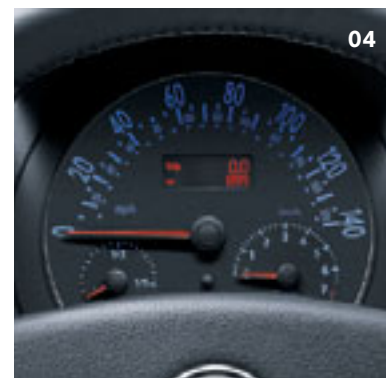
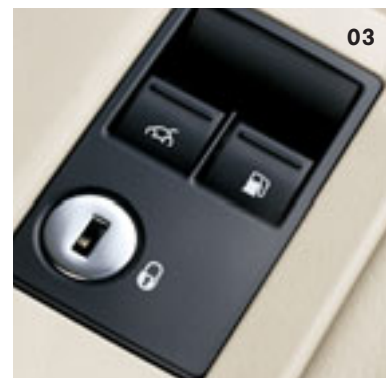

Wherever you sit in the New Beetle Cabriolet you'll always enjoy a comfortable place in the sun. It's all down to ergonomic design – the way that comfort and space are both achieved to maximum effect, ensuring the New Beetle Cabriolet is a fully accomplished four seater. The harmonious blend of design and function is also evident in the dashboard area, where the driver enjoys a clear view of the instruments and will find all controls within easy reach. In fact, all around you'll find proof of the New Beetle Cabriolet's high quality workmanship and attention to detail – even down to the unique vase for your favourite flower.

01 The attractive and durable seat upholstery in 'Eclipse' design comes in a range of appealing colours. Interior shown is New Beetle Cabriolet 1.9 TDI.

02 All models in the New Beetle Cabriolet range have electric front and rear windows as standard. Located in the driver's door, the controls can operate the windows individually or all at once. So it's easy to remove the last barrier between you and the feeling of pure freedom that only a cabriolet can deliver. For comfort and safety the front electric windows feature a one-touch open and close facility and anti-trapping protection, should anything be in the way.

03 To improve all-round vision, the body-coloured door mirrors are both heated and electrically adjustable. Their simple operation makes adjustment for individual drivers a fast and easy process. These door mirrors also feature integrated indicators to make your intentions totally clear.

04 The height and reach adjustable steering wheel ensures the optimum driving position.

05 Manual air conditioning provides year round comfort. Standard on 1.9 TDI, 2.0 litre and 1.8T models.

06 Amongst its extensive list of features, the 'Gamma' radio boasts a single CD player, 30 station presets, a scan facility and Traffic Information Memory (TIM).





01



05



02



03



04



06



07

01 'Easy entry' seats make it easier for rear passengers to get in and out. As you unlock the backrest, the front seats automatically slide forwards. Carpet mats help protect the interior and are standard on 1.9 TDI models and above, and optional on all other models.

02 For night-time use, the vanity mirror is illuminated.

03 The cup holders keep your drinks safe and within easy reach.

04 Driver's and front passenger's seat height adjustment will help you achieve the most comfortable seating position.

05 The standard front centre armrest doubles as a handy storage compartment and houses the optional six CD autochanger. Interior shown features optional leather* upholstery.

06 Always close to hand. The New Beetle Cabriolet's door pockets provide plenty of room for maps, books, CDs, suncream or sunglasses.

07 With the first drop, the New Beetle Cabriolet's rain sensor activates the windscreen wipers and adjusts their speed to the intensity of the rainfall. With similar ingenuity, the anti-dazzle rear-view mirror automatically darkens if lights from a following car are too bright. Optional on all New Beetle models.

We hope you'll agree that the New Beetle and New Beetle Cabriolet are somewhat special when you compare them with other cars on the road today. Their individuality and practical solutions are part of their appeal. For example, as a two door, we designed some special front seats that lift up and away, so it's easy to get into the back. This simple task is almost effortless due to the design detail.

We've also included numerous features for your convenience, such as the two removable cup holders incorporated into the centre console. We allowed plenty of storage space, hence the net pockets on the front doors of the New Beetle, the door pockets in the front of the New Beetle Cabriolet, the document pockets on the rear of the front seats, the glove compartment and the front centre armrest (front centre armrest storage area is reduced if the optional front armrest-mounted six CD autochanger is fitted).

*Some parts of leather interior will contain artificial leather.



Why have all the fun, when you can share the exhilaration?

Model shown is 2.0 litre with optional leather upholstery.



Model shown is 1.9 TDI with optional 17" 'Sarasota' alloy wheels and front fog lights.

The sun is rising.

Simply unlock the New Beetle Cabriolet's hood and then hold the operating button as the electrically operated hood glides down.* As it concertinas and folds flat, it comes to rest on the tail end. From start to finish, this elegant operation has taken just 13 seconds. For neatness, it can then be tucked under the tailored hood cover that is colour co-ordinated to the chosen upholstery colour of your New Beetle Cabriolet. Beauty needn't affect functionality.

- 01 – 04** The multilayered textile hood of the New Beetle Cabriolet can be opened and closed both quickly and easily. When closed, its taut fit is a particularly impressive element of the car's design, creating an atmosphere where outside noises can barely be heard. It even features a glass, heated rear screen. The choice of fine quality materials and the highest standards of workmanship help ensure the hood's exceptional durability – against abrasion, the weather and even the brushes of a car wash.
- 05** Releasing the hood is simple. Just push and twist the handle to unlock, then leave the rest to the electric assistance.*
- 06** If you are travelling briskly, wind buffeting can be reduced by a wind deflector. Available as an optional extra, it can be fitted in seconds to reduce air turbulence.
- 07** Fitted in the centre console, the control for the power hood can be easily reached.*

As a precautionary measure, a hood warning light near the release handle will inform you if the hood is not securely locked.

* Manual hood on Luna 1.4 litre models.

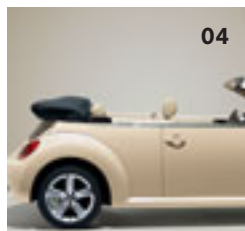
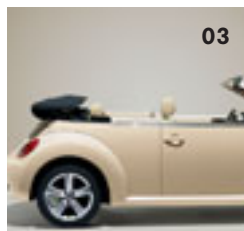
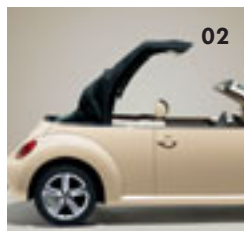
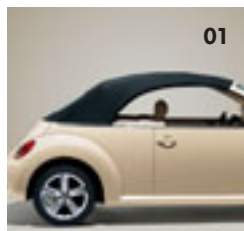



Model shown is Luna 1.4 litre with optional metallic paint.

Life isn't just black and white...

[Safety](#) | [Quality](#) | [Models](#) | [Colours & Upholstery](#) | [Equipment](#) | [Engines](#) | [Technology](#) | [Service](#)

[The New Beetle](#) | [Paint](#) | [Upholstery](#) | [Colour combinations](#)

[The New Beetle Cabriolet](#) | [Paint](#) | [Upholstery](#) | [Colour combinations](#)







[Print](#) | [Exit](#) | [◀](#) [▶](#)

Paint.

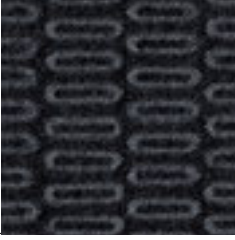

* Sunflower, metallic and pearl effect paints are optional at extra cost.
Please note: Screen technology does not allow exact reproduction of the paint colours. For further details, please contact your Volkswagen retailer.

Upholstery.

<p>All models</p> <p>'Eclipse' cloth</p>	 <p>black BS/BZ¹</p>	 <p>flannel grey BT</p>	 <p>cream BU</p>
<p>'Graffig' cloth sports seats*</p>	 <p>black EU/GA¹</p>		
<p>Perforated leather*²</p>	 <p>cream ZD</p>	 <p>black ZL/ZR¹</p>	
<p>Sports seats in leather*²</p>	 <p>cream 74</p>	 <p>black 75/79¹</p>	

* 'Graffig' cloth sports seats and leather upholstery are optional at extra cost.
¹ For use in combination with harvest moon beige paint.
² Some parts of leather interior will contain artificial leather.
 Please note: Screen technology does not allow exact reproduction of the upholstery colours. For further details, please contact your Volkswagen retailer.

Colour combinations.

Seat upholstery		Carpets	Dashboard	black A1	sunflower T1*	harvest moon beige V1	salsa red 4Y	shadow blue metallic P6*	speed blue metallic V8*	platinum grey metallic 2R*	reflex silver metallic 8E*	gecko green metallic 8U*	laser blue pearl effect Y3*	deep black pearl effect 2T*
All models – ‘Eclipse’ cloth	●													
black (BS/BZ ¹)		black	black/black	●	●	●	●	●	●	●	●	●	●	●
flannel grey (BT)		flannel grey	black/flannel grey	●	●	-	●	●	●	●	●	●	●	●
cream (BU)		cream	black/cream	●	-	●	●	●	-	●	-	●	●	●
Optional ‘Graffix’ cloth sports seats*	○													
black (EU/GA ¹)		black	black/black	○	○	○	○	○	○	○	○	○	○	○
Optional perforated leather*, 2	○													
cream (ZD)		cream	black/cream	○	-	○	○	○	-	○	-	○	○	○
black (ZL/ZR ¹)		black	black/black	○	○	○	○	○	○	○	○	○	○	○
Optional leather sports seats*, 2	○													
cream (74)		cream	black/cream	○	-	○	○	○	-	○	-	○	○	○
black (75/79 ¹)		black	black/black	○	○	○	○	○	○	○	○	○	○	○

● Standard ○ Optional at extra cost – Not available

* Sunflower, metallic and pearl effect paints, ‘Graffix’ cloth sports seats and leather upholstery are optional at extra cost.

¹ For use in combination with harvest moon beige paint.

² Some parts of leather interior will contain artificial leather.

Paint.



* Sunflower, metallic and pearl effect paints are optional at extra cost.
Please note: Screen technology does not allow exact reproduction of the paint colours.
For further details, please contact your Volkswagen retailer.

Upholstery.

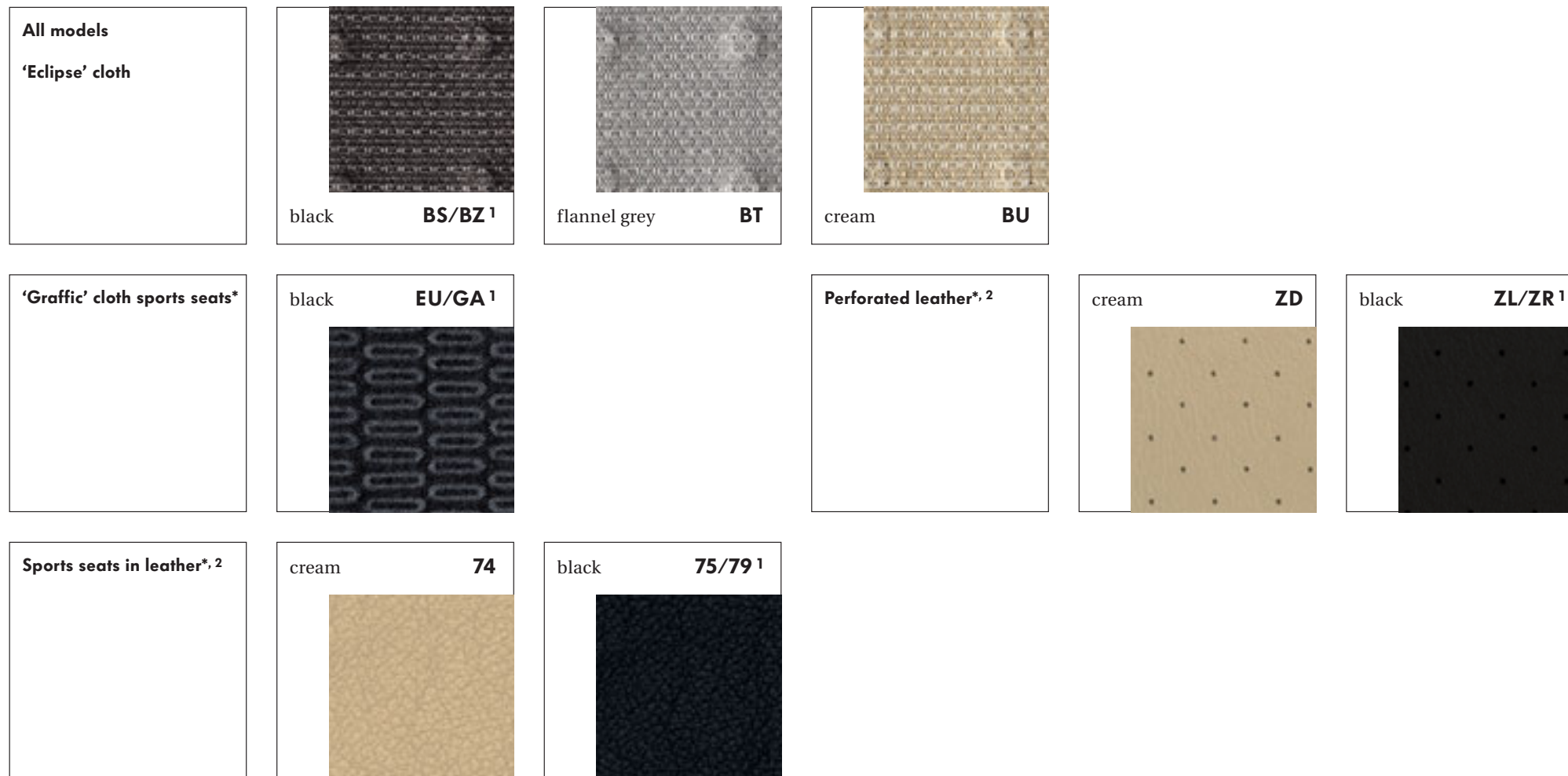

Cabriolet hood.

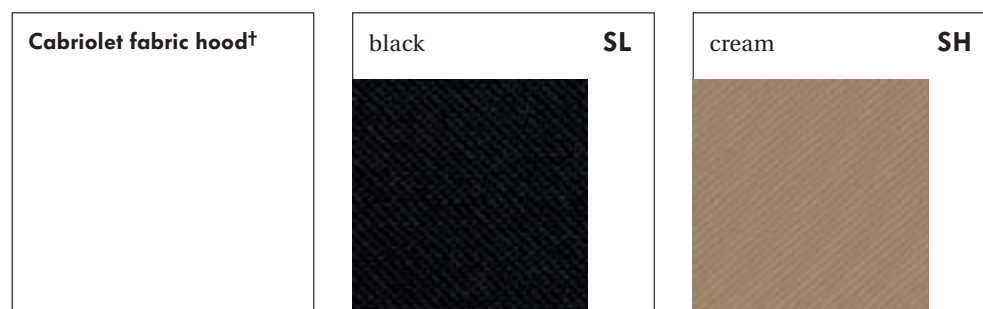

- * 'Graffig' cloth sports seats and leather upholstery are optional at extra cost.
- † Please note that the interior hood lining colour for all cabriolet hoods is black.
- ¹ For use in combination with harvest moon beige paint.
- ² Some parts of leather interior will contain artificial leather.

Please note: Screen technology does not allow exact reproduction of the upholstery and hood colours. For further details, please contact your Volkswagen retailer.

Colour combinations.

Seat upholstery		Carpets	Dashboard	Tailored hood cover	black A1	sunflower 11*	harvest moon beige V1	salsa red 4Y	shadow blue metallic P6*	speed blue metallic V8*	platinum grey metallic 2R*	reflex silver metallic 8E*	gecko green metallic 8U*	laser blue pearl effect Y3*	deep black pearl effect 2T*
All models – ‘Eclipse’ cloth	●														
black (BS/BZ ¹)		black	black/black	black	● ●	●	●	●	●	●	● ●	●	●	●	● ●
flannel grey (BT)		flannel grey	black/flannel grey	flannel grey	●	–	–	●	●	●	●	●	●	●	●
cream (BU)		cream	black/cream	cream	● ●	–	● ●	●	● ●	–	● ●	–	●	●	● ●
Optional ‘Graffix’ cloth sports seats*	○														
black (EU/GA ¹)		black	black/black	black	●	●	●	●	●	●	●	●	●	●	●
Optional perforated leather*, 2	○														
cream (ZD)		cream	black/cream	cream	● ●	–	● ●	●	● ●	–	● ●	–	● ●	●	● ●
black (ZL/ZR ¹)		black	black/black	black	● ●	●	● ●	●	●	●	● ●	●	●	●	● ●
Optional leather sports seats*, 2	○														
cream (74)		cream	black/cream	cream	● ●	–	● ●	●	● ●	–	● ●	–	● ●	●	● ●
black (75/79 ¹)		black	black/black	black	● ●	●	● ●	●	●	● ●	● ●	●	●	●	● ●

● Standard ○ Optional at extra cost – Not available

● ● Cabriolet hoods in black and cream. Unless indicated with a coloured circle, the combination is not available.

Please note: The tailored hood covers are colour co-ordinated to the upholstery colours of the New Beetle Cabriolet.

* Sunflower, metallic and pearl effect paints, ‘Graffix’ cloth sports seats and leather upholstery are optional at extra cost.

¹ For use in combination with harvest moon beige paint.

² Some parts of leather interior will contain artificial leather.

Please note: The Volkswagen Warranty does not cover the cost of cleaning the cabriolet hood.

We all enjoy different things in life, so shouldn't your New Beetle or New Beetle Cabriolet reflect your own personal taste? With a wide range of optional equipment available, we can help you create an individual specification to turn your dream car into reality.

Leather upholstery.*

With leather upholstery, you can enjoy your New Beetle and New Beetle Cabriolet in a very special, exclusive atmosphere which can only be created by using the finest materials. Not only does leather have a unique, luxurious fragrance, it has practical benefits too. It's extremely durable, easy to clean and has breathable qualities to help your interior stay fresh. In addition, you can specify leather front sports seats which also include lumbar support. Optional on all models.

* Some parts of leather interior will contain artificial leather.

01 An open display of comfort. A leather trimmed interior provides the New Beetle Cabriolet with a special elegance and perfectly complements the sensual enjoyment of open-top driving.

02 – 04 The leather interior provides an air of exclusivity with leather covered seats, steering wheel and gear knob.

05 For chilly winter days, the leather package also features heated front seats with five temperature settings.

CD autochanger.

The optional six CD autochanger is the ideal addition to the standard 'Gamma' radio/CD player. Mounted in the front armrest, it is out of sight from the opportunist thief. Optional on all models. Please note that the front centre armrest storage area is reduced if the optional front armrest-mounted six CD autochanger is fitted.

Cruise control.

On long motorway journeys cruise control provides a more relaxing drive. Simply set a speed and it will be constantly maintained without touching the accelerator. Pressing either the brake or clutch pedal immediately turns off the cruise control. Optional on all models except Luna 1.4 litre.

06 For hours of uninterrupted music listening, why not add a six CD autochanger? As it sits in the front centre armrest, it is particularly easy to reach. Optional on all models.

07 Manual air conditioning can quickly and easily achieve a pleasant interior temperature, particularly on hot summer days. Optional on Luna 1.4 litre and Luna 1.6 litre models.

08 Cruise control is perfect for long journeys, as it can maintain a constant speed from 20 mph upwards. Touching the clutch or brake will automatically disengage the speed setting. Optional on all models except Luna 1.4 litre.

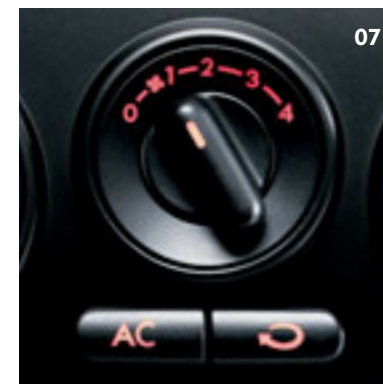
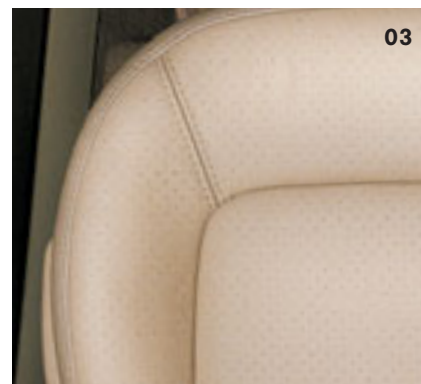
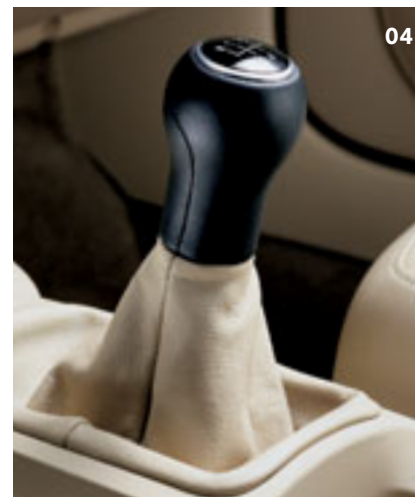
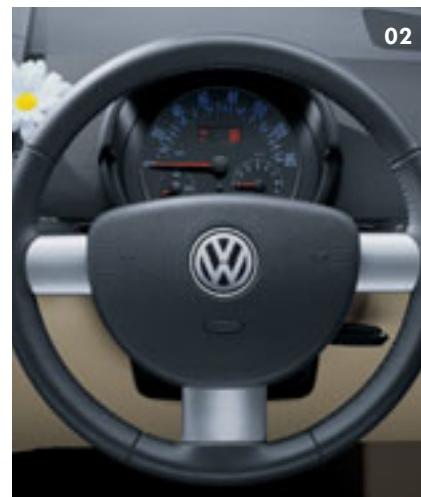

Wheels.

A choice of alternative designs are available to create a distinctive and individual finish to your New Beetle and New Beetle Cabriolet. All wheels are designed and constructed to the highest standards and are fitted with anti-theft wheel bolts.



01 Sporty 16" 'Houston' alloy wheels with 205/55 R16 tyres are standard on Luna 1.4 litre and Luna 1.6 litre models. Optional on 1.9 TDI models.

02 Stylish 16" 'Las Vegas' alloy wheels with 205/55 R16 tyres are standard on 2.0 litre and 1.8T models. Optional on Luna 1.4 litre, Luna 1.6 litre and optional at extra cost on 1.9 TDI models.

03 The performance inspired 17" 'Dallas' alloy wheels with 225/45 R17 tyres, come complete with anti-theft wheel bolts. Optional on 1.9 TDI, 2.0 litre and 1.8T models.

04 Classic 17" 'Sarasota' alloy wheels with 225/45 R17 tyres and anti-theft wheel bolts are optional on 1.9 TDI, 2.0 litre and 1.8T models.

05 Powerful front fog lights improve visibility in poor conditions. Standard on 1.8T and optional on all other models.

06 Split folding rear seats provide greater practicality. Optional on all New Beetle models. Not available on New Beetle Cabriolet.

Split folding rear seats.

The optional split folding rear seats give greater flexibility should you need to carry bulky items of luggage and a rear seat passenger. Optional on all New Beetle models. Not available on New Beetle Cabriolet.

Sports seats (not shown).

Ergonomically shaped and equipped with integral lumbar supports, the optional sports seats offer superb comfort and excellent lateral support. The sports seats come with 'Graffix' upholstery and are optional on all New Beetle and New Beetle Cabriolet models.

The Winter pack.

Throughout the coldest months, this pack provides added safety and comfort. Front fog lights improve visibility on the road ahead and are neatly integrated under the front bumper. Further safety measures include heated windscreen washer jets to help prevent freezing in sub-zero temperatures. For your comfort, this pack also contains heated front seats. Each seat is individually controlled and quickly warms to one of the five pre-programmed temperature settings. The Winter pack is optional on all New Beetle and New Beetle Cabriolet models.

Electric glass sunroof.

The New Beetle's optional sunroof is easy to operate thanks to automatic pre-selection. Just turn the dial and let the sunroof open to your desired setting. When the sunroof is open, a wind deflector automatically extends to reduce buffeting and a blind prevents dazzling from the sun. For added safety, an anti-trapping device immediately stops the roof if it meets resistance. Specify the electric glass sunroof and the driver's side grab handle is replaced with a convenient sunglasses case. Optional on all New Beetle models. Not available on New Beetle Cabriolet.



Interior cargo pack.

Net storage on the centre console and on the back of the front and rear seats creates additional storage space.

A luggage protection net secures your shopping in the boot. Optional on all New Beetle models. Not available on New Beetle Cabriolet.

Parking sensor.

Sensors on the rear bumper monitor the distance to a stationary obstacle. The sound repeats faster as the distance decreases. Optional on all models.

07 The optional electric glass sunroof has an automatic sunblind incorporated. Optional on all New Beetle models. Not available on New Beetle Cabriolet.

08 Parking made easy with the parking sensor. Optional on all models.

09 Tidily and safely stored. The net storage interior cargo pack. Optional on all New Beetle models. Not available on New Beetle Cabriolet.

10 The convenience of an electric cabriolet power hood is available as an option on Luna 1.4 litre and standard on all other New Beetle Cabriolet models.

Advanced engineering.

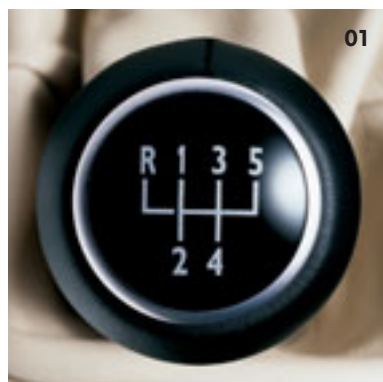

01 A slick, five speed manual gearbox is standard on all New Beetle and New Beetle Cabriolet models.

02 Ideal for cruising: the 1.4 litre 75 PS petrol engine.

03 Refinement: the 2.0 litre 115 PS petrol engine.

Over the years, Volkswagen has been at the forefront of engine design, developing an enviable reputation for technical innovation. Our engines achieve our focused objectives – to offer the perfect combination of performance, fuel efficiency* and environmental awareness.

The petrol engines:

The New Beetle and New Beetle Cabriolet are available with a wide choice of petrol engines. The range starts with a four cylinder, 1.4 litre unit that develops 75 PS. With its smooth running, it's ideal for relaxed cruising. If you'd prefer a power boost and similar acceleration, then the 1.6 litre 102 PS may be for you. Maybe the refinement of the 2.0 litre 115 PS is more to your taste – an engine capable of taking the New Beetle to 115 mph where the law permits. Then there's the turbocharged 1.8 litre engine which produces a superb 150 PS and gives exceptional performance. Whichever engine you choose it's reassuring to know they've all been developed with fuel efficiency* and low exhaust emissions in mind, and all conform to EU4 emissions regulations.

The diesel engine:

Available for the New Beetle and New Beetle Cabriolet is the 1.9 litre TDI 105 PS. Not only can it accelerate the New Beetle Cabriolet from standstill to 62 mph in 12.0 seconds whilst returning 51.4 mpg over the Combined cycle, it also conforms to EU4 emissions regulations – combining low fuel consumption* and CO₂ emissions with high power output.

The gearbox:

All engines of the New Beetle and New Beetle Cabriolet are equipped with a five speed manual gearbox, characterised by a smoothness of operation and powerful acceleration. Alternatively, with the 2.0 litre engine, you could opt for a four speed automatic in the New Beetle or a six speed automatic tiptronic in the New Beetle Cabriolet. The innovative automatic tiptronic transmission gives you the best of both worlds. When you fancy the involvement of a manual, you can change gear by a simple 'tipping' action of the gear lever forwards or backwards. Should you be faced with city traffic, you can then rely on the automatic function for more relaxed driving. The automatic tiptronic gearbox even has several mode functions that interpret your driving style, so should you be accelerating hard it will recognise this and amend the shift pattern accordingly.

* Please see the individual specifications in this section for fuel consumption figures.



Luna 1.4 litre 75 PS.

Technical specification.

		Manual	
Engine	Engine type	Four cylinder in-line – petrol	
	Cubic capacity, ltrs/cc	1.4/1390	
	Max. output, PS ⁽⁰¹⁾ /kW at rpm	75/55 5000	
	Max. torque, lbs.ft/Nm at rpm	93/126 3300	
	Gearbox	Five speed manual	
Weights, kgs	Unladen weight ⁽⁰²⁾	1182	
	Gross vehicle weight	1650	
	Payload ⁽⁰²⁾	468	
	Axle load limit: Front Rear	910 800	
Trailer load limits, kgs ⁽⁰³⁾	Braked 12% incline	1000	
	Unbraked	600	
	Towbar load limit	75	
	Max. roof load	50	
Performance	Top speed†, mph (km/h)	100 (161)	
	Acceleration, secs 0 - 62 mph	14.6	
	ABI insurance group	5	
Environmental information	Fuel grade, minimum	Unleaded, 95 RON ⁽⁰⁴⁾	
	Fuel tank capacity, galls/ltrs	12/55	
	Official fuel consumption, mpg/ltr per 100 km ⁽⁰⁶⁾		
	Urban	30.1/9.4	
	Extra-urban	48.7/5.8	
	Combined	39.8/7.1	
	Official CO ₂ emission, g/km ⁽⁰⁷⁾	169	
Emission class	EURO 4		
Noise, dB	72		
Maximum luggage capacity, cu.ft (litres)‡	With rear seat upright	7.4 (209)	
	With rear seat folded	27.2 (769)	

† Where the law permits.

‡ VDA measuring method using 200 x 100 x 50 mm blocks.

Notes.

- 01) The maximum power output figures are quoted in PS (or Pferdestärke, which is the metric equivalent of horsepower). To convert from metric to imperial horsepower, divide the PS figure by 1.0139.
- 02) Figures are calculated in accordance with manufacturer's criteria. Vehicle unladen weight ranges with 90% tank capacity without driver. The individual unladen weight depends on the specification of the vehicle, this then reduces the possible payload accordingly.
- 03) With increasing altitude the engine performance diminishes. From 1,000 m above sea level and for every 1,000 m thereafter 10% of the vehicle/trailer weight (trailer weight + gross vehicle weight) must be deducted.
- 04) Thanks to the knock control, unleaded four star (at least 95 RON) can be used instead of Super plus unleaded.
- 05) The use of bio diesel according to DIN 51606 is possible to about -10°C.
- 06) Official fuel consumption according to EU Directive 99/94. The consumption calculation according to 1999/100/EC is based on the actual unladen weight of the vehicle. Additional specifications can lead to a higher weight class and hence to consumption figures of this higher weight class. The driving style, road and traffic conditions, environmental influences and vehicle condition can in practice lead to consumption figures, which may differ from those calculated with this standard.
- 07) The weight of a vehicle will influence the level of CO₂ emission it produces; as a result, vehicles with higher levels of specification and factory-fitted options may emit higher levels of CO₂. The CO₂ figure quoted for each vehicle is the maximum possible. The unladen weight of the vehicle is calculated by range at the time of manufacture and the maximum possible CO₂ emission for that weight range is applied according to the Council Directive 80/1268EEC as amended by Commission Directive 1999/100/EC on the approximation of the laws of the member states relating to the carbon dioxide emissions and the fuel consumption of motor vehicles.

Luna 1.6 litre 102 PS.

Technical specification.

		Manual	
Engine	Engine type	Four cylinder in-line – petrol	
	Cubic capacity, ltrs/cc	1.6/1595	
	Max. output, PS ⁽⁰¹⁾ /kW at rpm	102/75 5600	
	Max. torque, lbs.ft/Nm at rpm	109/148 3800	
	Gearbox	Five speed manual	
Weights, kgs	Unladen weight ⁽⁰²⁾	1202	
	Gross vehicle weight	1680	
	Payload ⁽⁰²⁾	478	
	Axle load limit: Front Rear	940 800	
Trailer load limits, kgs ⁽⁰³⁾	Braked 12% incline	1000	
	Unbraked	600	
	Towbar load limit	75	
	Max. roof load	50	
Performance	Top speed†, mph (km/h)	111 (179)	
	Acceleration, secs 0 - 62 mph	11.6	
	ABI insurance group	7	
Environmental information	Fuel grade, minimum	Unleaded, 95 RON ⁽⁰⁴⁾	
	Fuel tank capacity, galls/ltrs	12/55	
	Official fuel consumption, mpg/ltr per 100 km ⁽⁰⁶⁾		
	Urban	27.4/10.3	
	Extra-urban	47.9/5.9	
	Combined	37.7/7.5	
	Official CO ₂ emission, g/km ⁽⁰⁷⁾	180	
Emission class	EURO 4		
Noise, dB	73		
Maximum luggage capacity, cu.ft (litres)‡	With rear seat upright	7.4 (209)	
	With rear seat folded	27.2 (769)	

† Where the law permits.

‡ VDA measuring method using 200 x 100 x 50 mm blocks.

Notes.

- 01) The maximum power output figures are quoted in PS (or Pferdestärke, which is the metric equivalent of horsepower). To convert from metric to imperial horsepower, divide the PS figure by 1.0139.
- 02) Figures are calculated in accordance with manufacturer's criteria. Vehicle unladen weight ranges with 90% tank capacity without driver. The individual unladen weight depends on the specification of the vehicle, this then reduces the possible payload accordingly.
- 03) With increasing altitude the engine performance diminishes. From 1,000 m above sea level and for every 1,000 m thereafter 10% of the vehicle/trailer weight (trailer weight + gross vehicle weight) must be deducted.
- 04) Thanks to the knock control, unleaded four star (at least 95 RON) can be used instead of Super plus unleaded.
- 05) The use of bio diesel according to DIN 51606 is possible to about -10°C.
- 06) Official fuel consumption according to EU Directive 99/94. The consumption calculation according to 1999/100/EC is based on the actual unladen weight of the vehicle. Additional specifications can lead to a higher weight class and hence to consumption figures of this higher weight class. The driving style, road and traffic conditions, environmental influences and vehicle condition can in practice lead to consumption figures, which may differ from those calculated with this standard.
- 07) The weight of a vehicle will influence the level of CO₂ emission it produces; as a result, vehicles with higher levels of specification and factory-fitted options may emit higher levels of CO₂. The CO₂ figure quoted for each vehicle is the maximum possible. The unladen weight of the vehicle is calculated by range at the time of manufacture and the maximum possible CO₂ emission for that weight range is applied according to the Council Directive 80/1268EEC as amended by Commission Directive 1999/100/EC on the approximation of the laws of the member states relating to the carbon dioxide emissions and the fuel consumption of motor vehicles.

1.9 litre TDI 105 PS.

Technical specification.

		Manual	
Engine	Engine type	Four cylinder in-line – diesel	
	Cubic capacity, ltrs/cc	1.9/1896	
	Max. output, PS ⁽⁰¹⁾ /kW at rpm	105/77 4000	
	Max. torque, lbs.ft/Nm at rpm	177/240 1800	
	Gearbox	Five speed manual	
Weights, kgs	Unladen weight ⁽⁰²⁾	1291	
	Gross vehicle weight	1720	
	Payload ⁽⁰²⁾	429	
	Axle load limit: Front Rear	1020 800	
Trailer load limits, kgs ⁽⁰³⁾	Braked 12% incline	1000	
	Unbraked	600	
	Towbar load limit	75	
	Max. roof load	50	
Performance	Top speed†, mph (km/h)	112 (180)	
	Acceleration, secs 0 - 62 mph	11.5	
	ABI insurance group	7	
Environmental information	Fuel grade, minimum	Diesel ⁽⁰⁵⁾	
	Fuel tank capacity, galls/ltrs	12/55	
	Official fuel consumption, mpg/ltr per 100 km ⁽⁰⁶⁾		
	Urban	41.5/6.8	
	Extra-urban	61.4/4.6	
	Combined	52.3/5.4	
	Official CO ₂ emission, g/km ⁽⁰⁷⁾	143	
Emission class	EURO 4		
Noise, dB	71		
Maximum luggage capacity, cu.ft (litres)‡	With rear seat upright	7.4 (209)	
	With rear seat folded	27.2 (769)	

† Where the law permits.

‡ VDA measuring method using 200 x 100 x 50 mm blocks.

Notes.

- 01) The maximum power output figures are quoted in PS (or Pferdestärke, which is the metric equivalent of horsepower). To convert from metric to imperial horsepower, divide the PS figure by 1.0139.
- 02) Figures are calculated in accordance with manufacturer's criteria. Vehicle unladen weight ranges with 90% tank capacity without driver. The individual unladen weight depends on the specification of the vehicle, this then reduces the possible payload accordingly.
- 03) With increasing altitude the engine performance diminishes. From 1,000 m above sea level and for every 1,000 m thereafter 10% of the vehicle/trailer weight (trailer weight + gross vehicle weight) must be deducted.
- 04) Thanks to the knock control, unleaded four star (at least 95 RON) can be used instead of Super plus unleaded.
- 05) The use of bio diesel according to DIN 51606 is possible to about -10°C.
- 06) Official fuel consumption according to EU Directive 99/94. The consumption calculation according to 1999/100/EC is based on the actual unladen weight of the vehicle. Additional specifications can lead to a higher weight class and hence to consumption figures of this higher weight class. The driving style, road and traffic conditions, environmental influences and vehicle condition can in practice lead to consumption figures, which may differ from those calculated with this standard.
- 07) The weight of a vehicle will influence the level of CO₂ emission it produces; as a result, vehicles with higher levels of specification and factory-fitted options may emit higher levels of CO₂. The CO₂ figure quoted for each vehicle is the maximum possible. The unladen weight of the vehicle is calculated by range at the time of manufacture and the maximum possible CO₂ emission for that weight range is applied according to the Council Directive 80/1268EEC as amended by Commission Directive 1999/100/EC on the approximation of the laws of the member states relating to the carbon dioxide emissions and the fuel consumption of motor vehicles.

2.0 litre 115 PS.

Technical specification.

		Manual	Automatic
Engine	Engine type	Four cylinder in-line – petrol	Four cylinder in-line – petrol
	Cubic capacity, ltrs/cc	2.0/1984	2.0/1984
	Max. output, PS ⁽⁰¹⁾ /kW at rpm	115/85 5400	115/85 5400
	Max. torque, lbs.ft/Nm at rpm	127/172 3200	127/172 3200
	Gearbox	Five speed manual	Four speed auto
Weights, kgs	Unladen weight ⁽⁰²⁾	1246	1250
	Gross vehicle weight	1710	1730
	Payload ⁽⁰²⁾	464	480
	Axle load limit: Front Rear	970 800	990 800
Trailer load limits, kgs ⁽⁰³⁾	Braked 12% incline	1000	1000
	Unbraked	600	600
	Towbar load limit	75	75
	Max. roof load	50	50
Performance	Top speed†, mph (km/h)	115 (185)	113 (182)
	Acceleration, secs 0 - 62 mph	10.9	12.9
	ABI insurance group	8	8
Environmental information	Fuel grade, minimum	Unleaded, 95 RON ⁽⁰⁴⁾	Unleaded, 95 RON ⁽⁰⁴⁾
	Fuel tank capacity, galls/ltrs	12/55	12/55
	Official fuel consumption, mpg/ltr per 100 km ⁽⁰⁶⁾		
	Urban	23.7/11.9	21.4/13.2
	Extra-urban	41.5/6.8	39.2/7.2
	Combined	32.5/8.7	30.1/9.4
	Official CO ₂ emission, g/km ⁽⁰⁷⁾	210	224
Emission class	EURO 4	EURO 4	
Noise, dB	72	73	
Maximum luggage capacity, cu.ft (litres)‡	With rear seat upright	7.4 (209)	7.4 (209)
	With rear seat folded	27.2 (769)	27.2 (769)

† Where the law permits.

‡ VDA measuring method using 200 x 100 x 50 mm blocks.

Notes.

- 01) The maximum power output figures are quoted in PS (or Pferdestärke, which is the metric equivalent of horsepower). To convert from metric to imperial horsepower, divide the PS figure by 1.0139.
- 02) Figures are calculated in accordance with manufacturer's criteria. Vehicle unladen weight ranges with 90% tank capacity without driver. The individual unladen weight depends on the specification of the vehicle, this then reduces the possible payload accordingly.
- 03) With increasing altitude the engine performance diminishes. From 1,000 m above sea level and for every 1,000 m thereafter 10% of the vehicle/trailer weight (trailer weight + gross vehicle weight) must be deducted.
- 04) Thanks to the knock control, unleaded four star (at least 95 RON) can be used instead of Super plus unleaded.
- 05) The use of bio diesel according to DIN 51606 is possible to about -10°C.
- 06) Official fuel consumption according to EU Directive 99/94. The consumption calculation according to 1999/100/EC is based on the actual unladen weight of the vehicle. Additional specifications can lead to a higher weight class and hence to consumption figures of this higher weight class. The driving style, road and traffic conditions, environmental influences and vehicle condition can in practice lead to consumption figures, which may differ from those calculated with this standard.
- 07) The weight of a vehicle will influence the level of CO₂ emission it produces; as a result, vehicles with higher levels of specification and factory-fitted options may emit higher levels of CO₂. The CO₂ figure quoted for each vehicle is the maximum possible. The unladen weight of the vehicle is calculated by range at the time of manufacture and the maximum possible CO₂ emission for that weight range is applied according to the Council Directive 80/1268EEC as amended by Commission Directive 1999/100/EC on the approximation of the laws of the member states relating to the carbon dioxide emissions and the fuel consumption of motor vehicles.

1.8 litre Turbo 150 PS.

Technical specification.

		Manual	
Engine	Engine type	Four cylinder in-line – petrol	
	Cubic capacity, ltrs/cc	1.8/1781	
	Max. output, PS ⁽⁰¹⁾ /kW at rpm	150/110 5800	
	Max. torque, lbs.ft/Nm at rpm	162/220 2000	
	Gearbox	Five speed manual	
Weights, kgs	Unladen weight ⁽⁰²⁾	1269	
	Gross vehicle weight	1750	
	Payload ⁽⁰²⁾	481	
	Axle load limit: Front Rear	1010 800	
Trailer load limits, kgs ⁽⁰³⁾	Braked 12% incline	1000	
	Unbraked	600	
	Towbar load limit	75	
	Max. roof load	50	
Performance	Top speed†, mph (km/h)	126 (203)	
	Acceleration, secs 0 - 62 mph	8.7	
	ABI insurance group	12	
Environmental information	Fuel grade, minimum	Unleaded, 95 RON ⁽⁰⁴⁾	
	Fuel tank capacity, galls/ltrs	12/55	
	Official fuel consumption, mpg/ltr per 100 km ⁽⁰⁶⁾		
	Urban	25.7/11.0	
	Extra-urban	44.1/6.4	
	Combined	34.9/8.1	
	Official CO ₂ emission, g/km ⁽⁰⁷⁾	194	
Emission class	EURO 4		
Noise, dB	72		
Maximum luggage capacity, cu.ft (litres)‡	With rear seat upright	7.4 (209)	
	With rear seat folded	27.2 (769)	

† Where the law permits.

‡ VDA measuring method using 200 x 100 x 50 mm blocks.

Notes.

- 01) The maximum power output figures are quoted in PS (or Pferdestärke, which is the metric equivalent of horsepower). To convert from metric to imperial horsepower, divide the PS figure by 1.0139.
- 02) Figures are calculated in accordance with manufacturer's criteria. Vehicle unladen weight ranges with 90% tank capacity without driver. The individual unladen weight depends on the specification of the vehicle, this then reduces the possible payload accordingly.
- 03) With increasing altitude the engine performance diminishes. From 1,000 m above sea level and for every 1,000 m thereafter 10% of the vehicle/trailer weight (trailer weight + gross vehicle weight) must be deducted.
- 04) Thanks to the knock control, unleaded four star (at least 95 RON) can be used instead of Super plus unleaded.
- 05) The use of bio diesel according to DIN 51606 is possible to about -10°C.
- 06) Official fuel consumption according to EU Directive 99/94. The consumption calculation according to 1999/100/EC is based on the actual unladen weight of the vehicle. Additional specifications can lead to a higher weight class and hence to consumption figures of this higher weight class. The driving style, road and traffic conditions, environmental influences and vehicle condition can in practice lead to consumption figures, which may differ from those calculated with this standard.
- 07) The weight of a vehicle will influence the level of CO₂ emission it produces; as a result, vehicles with higher levels of specification and factory-fitted options may emit higher levels of CO₂. The CO₂ figure quoted for each vehicle is the maximum possible. The unladen weight of the vehicle is calculated by range at the time of manufacture and the maximum possible CO₂ emission for that weight range is applied according to the Council Directive 80/1268EEC as amended by Commission Directive 1999/100/EC on the approximation of the laws of the member states relating to the carbon dioxide emissions and the fuel consumption of motor vehicles.

Luna 1.4 litre 75 PS.

Technical specification.

		Manual	
Engine	Engine type	Four cylinder in-line – petrol	
	Cubic capacity, ltrs/cc	1.4/1390	
	Max. output, PS ⁽⁰¹⁾ /kW at rpm	75/55 5000	
	Max. torque, lbs.ft/Nm at rpm	93/126 3300	
	Gearbox	Five speed manual	
Weights, kgs	Unladen weight ⁽⁰²⁾	1276	
	Gross vehicle weight	1750	
	Payload ⁽⁰²⁾	474	
	Axle load limit: Front Rear	950 830	
Trailer load limits, kgs ⁽⁰³⁾	Braked 12% incline	1000	
	Unbraked	600	
	Towbar load limit	75	
Performance	Top speed†, mph (km/h)	99 (160)	
	Acceleration, secs 0 - 62 mph	15.6	
	ABI insurance group	6	
Environmental information	Fuel grade, minimum	Unleaded, 95 RON ⁽⁰⁴⁾	
	Fuel tank capacity, galls/ltrs	12/55	
	Official fuel consumption, mpg/ltr per 100 km ⁽⁰⁶⁾		
	Urban	29.7/9.5	
	Extra-urban	48.7/5.8	
	Combined	39.8/7.1	
	Official CO ₂ emission, g/km ⁽⁰⁷⁾	171	
Emission class	EURO 4		
Noise, dB	72		
Maximum luggage capacity, cu.ft (litres)‡	With rear seat upright	7.1 (201)	

† Where the law permits.

‡ VDA measuring method using 200 x 100 x 50 mm blocks.

Notes.

- 01) The maximum power output figures are quoted in PS (or Pferdestärke, which is the metric equivalent of horsepower). To convert from metric to imperial horsepower, divide the PS figure by 1.0139.
- 02) Figures are calculated in accordance with manufacturer's criteria. Vehicle unladen weight ranges with 90% tank capacity without driver. The individual unladen weight depends on the specification of the vehicle, this then reduces the possible payload accordingly.
- 03) With increasing altitude the engine performance diminishes. From 1,000 m above sea level and for every 1,000 m thereafter 10% of the vehicle/trailer weight (trailer weight + gross vehicle weight) must be deducted.
- 04) Thanks to the knock control, unleaded four star (at least 95 RON) can be used instead of Super plus unleaded.
- 05) The use of bio diesel according to DIN 51606 is possible to about -10°C.
- 06) Official fuel consumption according to EU Directive 99/94. The consumption calculation according to 1999/100/EC is based on the actual unladen weight of the vehicle. Additional specifications can lead to a higher weight class and hence to consumption figures of this higher weight class. The driving style, road and traffic conditions, environmental influences and vehicle condition can in practice lead to consumption figures, which may differ from those calculated with this standard.
- 07) The weight of a vehicle will influence the level of CO₂ emission it produces; as a result, vehicles with higher levels of specification and factory-fitted options may emit higher levels of CO₂. The CO₂ figure quoted for each vehicle is the maximum possible. The unladen weight of the vehicle is calculated by range at the time of manufacture and the maximum possible CO₂ emission for that weight range is applied according to the Council Directive 80/1268EEC as amended by Commission Directive 1999/100/EC on the approximation of the laws of the member states relating to the carbon dioxide emissions and the fuel consumption of motor vehicles.

Luna 1.6 litre 102 PS.

Technical specification.

		Manual	
Engine	Engine type	Four cylinder in-line – petrol	
	Cubic capacity, ltrs/cc	1.6/1595	
	Max. output, PS ⁽⁰¹⁾ /kW at rpm	102/75 5600	
	Max. torque, lbs.ft/Nm at rpm	109/148 3800	
	Gearbox	Five speed manual	
Weights, kgs	Unladen weight ⁽⁰²⁾	1300	
	Gross vehicle weight	1770	
	Payload ⁽⁰²⁾	470	
	Axle load limit: Front Rear	970 830	
Trailer load limits, kgs ⁽⁰³⁾	Braked 12% incline	1000	
	Unbraked	600	
	Towbar load limit	75	
Performance	Top speed†, mph (km/h)	110 (178)	
	Acceleration, secs 0 - 62 mph	12.3	
	ABI insurance group	8	
Environmental information	Fuel grade, minimum	Unleaded, 95 RON ⁽⁰⁴⁾	
	Fuel tank capacity, galls/ltrs	12/55	
	Official fuel consumption, mpg/ltr per 100 km ⁽⁰⁶⁾		
	Urban	26.9/10.5	
	Extra-urban	47.1/6.0	
	Combined	36.7/7.7	
	Official CO ₂ emission, g/km ⁽⁰⁷⁾	185	
Emission class	EURO 4		
Noise, dB	73		
Maximum luggage capacity, cu.ft (litres)‡	With rear seat upright	7.1 (201)	

† Where the law permits.

‡ VDA measuring method using 200 x 100 x 50 mm blocks.

Notes.

- 01) The maximum power output figures are quoted in PS (or Pferdestärke, which is the metric equivalent of horsepower). To convert from metric to imperial horsepower, divide the PS figure by 1.0139.
- 02) Figures are calculated in accordance with manufacturer's criteria. Vehicle unladen weight ranges with 90% tank capacity without driver. The individual unladen weight depends on the specification of the vehicle, this then reduces the possible payload accordingly.
- 03) With increasing altitude the engine performance diminishes. From 1,000 m above sea level and for every 1,000 m thereafter 10% of the vehicle/trailer weight (trailer weight + gross vehicle weight) must be deducted.
- 04) Thanks to the knock control, unleaded four star (at least 95 RON) can be used instead of Super plus unleaded.
- 05) The use of bio diesel according to DIN 51606 is possible to about -10°C.
- 06) Official fuel consumption according to EU Directive 99/94. The consumption calculation according to 1999/100/EC is based on the actual unladen weight of the vehicle. Additional specifications can lead to a higher weight class and hence to consumption figures of this higher weight class. The driving style, road and traffic conditions, environmental influences and vehicle condition can in practice lead to consumption figures, which may differ from those calculated with this standard.
- 07) The weight of a vehicle will influence the level of CO₂ emission it produces; as a result, vehicles with higher levels of specification and factory-fitted options may emit higher levels of CO₂. The CO₂ figure quoted for each vehicle is the maximum possible. The unladen weight of the vehicle is calculated by range at the time of manufacture and the maximum possible CO₂ emission for that weight range is applied according to the Council Directive 80/1268EEC as amended by Commission Directive 1999/100/EC on the approximation of the laws of the member states relating to the carbon dioxide emissions and the fuel consumption of motor vehicles.

1.9 litre TDI 105 PS.

Technical specification.

		Manual	
Engine	Engine type	Four cylinder in-line – diesel	
	Cubic capacity, ltrs/cc	1.9/1896	
	Max. output, PS ⁽⁰¹⁾ /kW at rpm	105/77 4000	
	Max. torque, lbs.ft/Nm at rpm	177/240 1800-2400	
	Gearbox	Five speed manual	
Weights, kgs	Unladen weight ⁽⁰²⁾	1351	
	Gross vehicle weight	1840	
	Payload ⁽⁰²⁾	489	
	Axle load limit: Front Rear	1020 840	
Trailer load limits, kgs ⁽⁰³⁾	Braked 12% incline	1000	
	Unbraked	600	
	Towbar load limit	75	
Performance	Top speed†, mph (km/h)	111 (179)	
	Acceleration, secs 0 - 62 mph	12.0	
	ABI insurance group	8	
Environmental information	Fuel grade, minimum	Diesel ⁽⁰⁵⁾	
	Fuel tank capacity, galls/ltrs	12/55	
	Official fuel consumption, mpg/ltr per 100 km ⁽⁰⁶⁾		
	Urban	40.9/6.9	
	Extra-urban	60.1/4.7	
	Combined	51.4/5.5	
	Official CO ₂ emission, g/km ⁽⁰⁷⁾	145	
Emission class	EURO 4		
Noise, dB	71		
Maximum luggage capacity, cu.ft (litres)‡	With rear seat upright	7.1 (201)	

† Where the law permits.

‡ VDA measuring method using 200 x 100 x 50 mm blocks.

Notes.

- 01) The maximum power output figures are quoted in PS (or Pferdestärke, which is the metric equivalent of horsepower). To convert from metric to imperial horsepower, divide the PS figure by 1.0139.
- 02) Figures are calculated in accordance with manufacturer's criteria. Vehicle unladen weight ranges with 90% tank capacity without driver. The individual unladen weight depends on the specification of the vehicle, this then reduces the possible payload accordingly.
- 03) With increasing altitude the engine performance diminishes. From 1,000 m above sea level and for every 1,000 m thereafter 10% of the vehicle/trailer weight (trailer weight + gross vehicle weight) must be deducted.
- 04) Thanks to the knock control, unleaded four star (at least 95 RON) can be used instead of Super plus unleaded.
- 05) The use of bio diesel according to DIN 51606 is possible to about -10°C.
- 06) Official fuel consumption according to EU Directive 99/94. The consumption calculation according to 1999/100/EC is based on the actual unladen weight of the vehicle. Additional specifications can lead to a higher weight class and hence to consumption figures of this higher weight class. The driving style, road and traffic conditions, environmental influences and vehicle condition can in practice lead to consumption figures, which may differ from those calculated with this standard.
- 07) The weight of a vehicle will influence the level of CO₂ emission it produces; as a result, vehicles with higher levels of specification and factory-fitted options may emit higher levels of CO₂. The CO₂ figure quoted for each vehicle is the maximum possible. The unladen weight of the vehicle is calculated by range at the time of manufacture and the maximum possible CO₂ emission for that weight range is applied according to the Council Directive 80/1268EEC as amended by Commission Directive 1999/100/EC on the approximation of the laws of the member states relating to the carbon dioxide emissions and the fuel consumption of motor vehicles.

2.0 litre 115 PS.

Technical specification.

		Manual	Automatic tiptronic	
Engine	Engine type	Four cylinder in-line – petrol	Four cylinder in-line – petrol	
	Cubic capacity, ltrs/cc	2.0/1984	2.0/1984	
	Max. output, PS ⁽⁰¹⁾ /kW at rpm	115/85 5400	115/85 5400	
	Max. torque, lbs.ft/Nm at rpm	127/172 3200	127/172 3200	
	Gearbox	Five speed manual	Six speed auto tiptronic	
Weights, kgs	Unladen weight ⁽⁰²⁾	1329	1355	
	Gross vehicle weight	1800	1830	
	Payload ⁽⁰²⁾	471	475	
	Axle load limit: Front Rear	1000 840	1020 830	
Trailer load limits, kgs ⁽⁰³⁾	Braked 12% incline	1000	1000	
	Unbraked	600	600	
	Towbar load limit	75	75	
Performance	Top speed†, mph (km/h)	114 (184)	112 (181)	
	Acceleration, secs 0 - 62 mph	11.7	12.9	
	ABI insurance group	9	9	
Environmental information	Fuel grade, minimum	Unleaded, 95 RON ⁽⁰⁴⁾	Unleaded, 95 RON ⁽⁰⁴⁾	
	Fuel tank capacity, galls/ltrs	12/55	12/55	
	Official fuel consumption, mpg/ltr per 100 km ⁽⁰⁶⁾	Urban	23.5/12.0	21.2/13.3
		Extra-urban	40.9/6.9	40.9/6.9
		Combined	32.1/8.8	30.7/9.2
	Official CO ₂ emission, g/km ⁽⁰⁷⁾	212	222	
	Emission class	EURO 4	EURO 4	
Noise, dB	72	71		
Maximum luggage capacity, cu.ft (litres)‡	With rear seat upright	7.1 (201)	7.1 (201)	

† Where the law permits.

‡ VDA measuring method using 200 x 100 x 50 mm blocks.

Notes.

- 01) The maximum power output figures are quoted in PS (or Pferdestärke, which is the metric equivalent of horsepower). To convert from metric to imperial horsepower, divide the PS figure by 1.0139.
- 02) Figures are calculated in accordance with manufacturer's criteria. Vehicle unladen weight ranges with 90% tank capacity without driver. The individual unladen weight depends on the specification of the vehicle, this then reduces the possible payload accordingly.
- 03) With increasing altitude the engine performance diminishes. From 1,000 m above sea level and for every 1,000 m thereafter 10% of the vehicle/trailer weight (trailer weight + gross vehicle weight) must be deducted.
- 04) Thanks to the knock control, unleaded four star (at least 95 RON) can be used instead of Super plus unleaded.
- 05) The use of bio diesel according to DIN 51606 is possible to about -10°C.
- 06) Official fuel consumption according to EU Directive 99/94. The consumption calculation according to 1999/100/EC is based on the actual unladen weight of the vehicle. Additional specifications can lead to a higher weight class and hence to consumption figures of this higher weight class. The driving style, road and traffic conditions, environmental influences and vehicle condition can in practice lead to consumption figures, which may differ from those calculated with this standard.
- 07) The weight of a vehicle will influence the level of CO₂ emission it produces; as a result, vehicles with higher levels of specification and factory-fitted options may emit higher levels of CO₂. The CO₂ figure quoted for each vehicle is the maximum possible. The unladen weight of the vehicle is calculated by range at the time of manufacture and the maximum possible CO₂ emission for that weight range is applied according to the Council Directive 80/1268EEC as amended by Commission Directive 1999/100/EC on the approximation of the laws of the member states relating to the carbon dioxide emissions and the fuel consumption of motor vehicles.

1.8 litre Turbo 150 PS.

Technical specification.

		Manual		
Engine	Engine type	Four cylinder in-line – petrol		
	Cubic capacity, ltrs/cc	1.8/1781		
	Max. output, PS ⁽⁰¹⁾ /kW at rpm	150/110 5800		
	Max. torque, lbs.ft/Nm at rpm	162/220 2000		
	Gearbox	Five speed manual		
Weights, kgs	Unladen weight ⁽⁰²⁾	1388		
	Gross vehicle weight	1850		
	Payload ⁽⁰²⁾	462		
	Axle load limit: Front Rear	1040 850		
Trailer load limits, kgs ⁽⁰³⁾	Braked 12% incline	1000		
	Unbraked	600		
	Towbar load limit	75		
Performance	Top speed†, mph (km/h)	125 (202)		
	Acceleration, secs 0 - 62 mph	9.3		
	ABI insurance group	13		
Environmental information	Fuel grade, minimum	Unleaded, 95 RON ⁽⁰⁴⁾		
	Fuel tank capacity, galls/ltrs	12/55		
	Official fuel consumption, mpg/ltr per 100 km ⁽⁰⁶⁾	Urban	25.4/11.1	
		Extra-urban	43.5/6.5	
		Combined	34.4/8.2	
	Official CO ₂ emission, g/km ⁽⁰⁷⁾	196		
	Emission class	EURO 4		
Noise, dB	72			
Maximum luggage capacity, cu.ft (litres)‡	With rear seat upright	7.1 (201)		

† Where the law permits.

‡ VDA measuring method using 200 x 100 x 50 mm blocks.

Notes.

- 01) The maximum power output figures are quoted in PS (or Pferdestärke, which is the metric equivalent of horsepower). To convert from metric to imperial horsepower, divide the PS figure by 1.0139.
- 02) Figures are calculated in accordance with manufacturer's criteria. Vehicle unladen weight ranges with 90% tank capacity without driver. The individual unladen weight depends on the specification of the vehicle, this then reduces the possible payload accordingly.
- 03) With increasing altitude the engine performance diminishes. From 1,000 m above sea level and for every 1,000 m thereafter 10% of the vehicle/trailer weight (trailer weight + gross vehicle weight) must be deducted.
- 04) Thanks to the knock control, unleaded four star (at least 95 RON) can be used instead of Super plus unleaded.
- 05) The use of bio diesel according to DIN 51606 is possible to about -10°C.
- 06) Official fuel consumption according to EU Directive 99/94. The consumption calculation according to 1999/100/EC is based on the actual unladen weight of the vehicle. Additional specifications can lead to a higher weight class and hence to consumption figures of this higher weight class. The driving style, road and traffic conditions, environmental influences and vehicle condition can in practice lead to consumption figures, which may differ from those calculated with this standard.
- 07) The weight of a vehicle will influence the level of CO₂ emission it produces; as a result, vehicles with higher levels of specification and factory-fitted options may emit higher levels of CO₂. The CO₂ figure quoted for each vehicle is the maximum possible. The unladen weight of the vehicle is calculated by range at the time of manufacture and the maximum possible CO₂ emission for that weight range is applied according to the Council Directive 80/1268EEC as amended by Commission Directive 1999/100/EC on the approximation of the laws of the member states relating to the carbon dioxide emissions and the fuel consumption of motor vehicles.

The technology.

Transmission

- Front wheel drive
- Five speed manual: 1.4 litre 75 PS, 1.6 litre 102 PS, 1.9 litre TDI 105 PS, 2.0 litre 115 PS, 1.8 litre Turbo 150 PS
- Four speed automatic: New Beetle 2.0 litre 115 PS
- Six speed automatic tiptronic: New Beetle Cabriolet 2.0 litre 115 PS

Steering

- Power-assisted, maintenance-free rack and pinion. Collapsible steering column

Running gear

- ESP (Electronic Stabilisation Programme) including EDL (Electronic Differential Lock) and ASR (Traction Control)
- Front suspension uses coil springs with telescopic shock absorbers; all elements integrated in chassis legs. Rear suspension with gas pressure shock absorbers and separate springs
- Wheel control: front through chassis legs and (lower) triangular wishbones (directionally stabilising steering roll radius), at rear through torsion beam trailing arm with track-correcting bearings, with large-volume, directionally stabilising bearings
- Front and rear anti-roll bar
- Brake system: ABS Anti-lock brakes. Diagonally split circuits. Servo assisted. Front: Ventilated discs. Rear: Discs
- Turning circle: 35.8 feet/10.9 metres

Engines

- Front transversely-mounted
- 1.4 litre/75 PS ⁽⁰¹⁾ (55 kW) petrol engine. Four cylinder in-line engine, aluminium cylinder block, four valves per cylinder with roller rocker valves, electronic individual cylinder injection, programmed ignition with cylinder-selective anti-knock control, coil per plug ignition, longlife spark plugs, three-way front catalyst, lambda control
- 1.6 litre/102 PS ⁽⁰¹⁾ (75 kW) petrol engine. Four cylinder in-line engine, aluminium cylinder block, variable intake manifold, two valves per cylinder with roller rocker valves, electronic individual cylinder injection, programmed ignition with cylinder-selective anti-knock control, double spark ignition unit, longlife spark plugs, three-way front catalyst, lambda control
- 1.9 litre/105 PS ⁽⁰¹⁾ (77 kW) diesel engine. Four cylinder in-line engine, cast iron cylinder block, direct injection with unit injectors, turbocharged with intercooler, two valves per cylinder
- 2.0 litre/115 PS ⁽⁰¹⁾ (85 kW) petrol engine. Four cylinder in-line engine, cast iron cylinder block, two valves per cylinder, electronic individual cylinder injection, programmed ignition with cylinder-selective anti-knock control, double spark ignition unit, longlife spark plugs, three-way front catalyst, lambda control
- 1.8 litre/150 PS ⁽⁰¹⁾ (110 kW) petrol engine. Four cylinder in-line engine, five valves per cylinder, turbocharger, intercooler, electronic cylinder individual injection, programmed ignition with cylinder-selective anti-knock control, single spark ignition coils, longlife spark plugs, three-way catalyst, lambda control

01) The maximum power output figures are quoted in PS (or Pferdestärke, which is the metric equivalent of horsepower). To convert from metric to imperial horsepower, divide the PS figure by 1.0139.

New Beetle

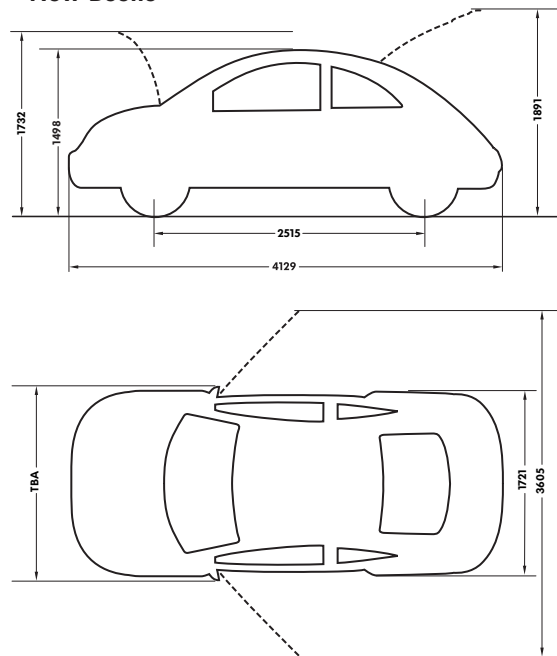

New Beetle Cabriolet

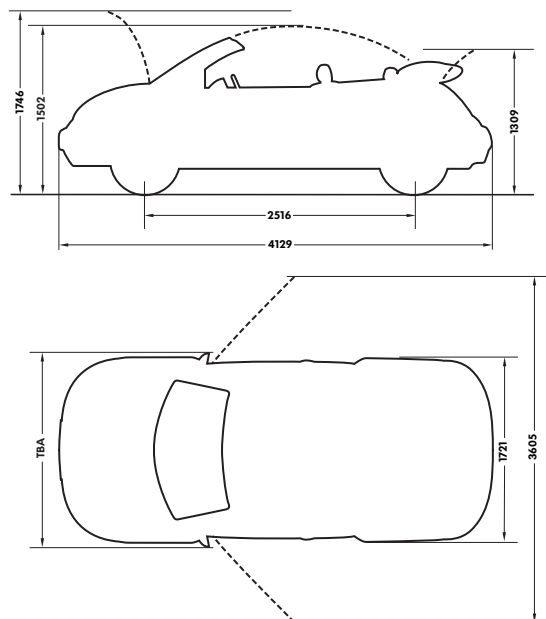

Dimensions.

	New Beetle	New Beetle Cabriolet	
Exterior dimensions	Length, mm	4129	4129
	Width – excluding door mirrors, mm	1721	1721
	Width – opened front doors, mm	3605	3605
	Height, mm	1498	1502
	Height – opened bonnet/floor, mm	1732	1746
	Height – opened tailgate/floor, mm	1891	1309
	Wheelbase, mm	2515	2516

Volkswagen service for your peace of mind.

The Volkswagen Warranty.

Three-year Warranty.

All Volkswagen New Beetles and New Beetle Cabriolets come with a three-year/60,000 miles warranty, which protects your car against the failure of most mechanical and electrical components due to manufacturing defects. This comprises a two-year manufacturer's warranty with unlimited mileage plus a further one-year/60,000 miles (whichever is soonest) Retailer Warranty. Should the mileage exceed 60,000 miles within the first two years, the manufacturer's two-year warranty will still be valid. If an additional warranty for subsequent years or higher mileage is desired, it may be purchased from an authorised Volkswagen retailer or repairer; however, this additional warranty must be purchased before the mileage reaches 60,000*. Full details of the three-year warranty are available from your authorised Volkswagen retailer or repairer.

* All warranty work must be completed by an authorised Volkswagen retailer or repairer.

Three-year Paint Warranty.

The paintwork of the New Beetle and New Beetle Cabriolet is covered against manufacturing defects for a period of three years. Naturally, the New Beetle and New Beetle Cabriolet must be cared for in compliance with the operating instructions which will be found in your vehicle handbook. Please consult your authorised Volkswagen retailer or repairer for full warranty details.

12-year Body Protection Warranty.

The internal body sections and panels of the New Beetle and New Beetle Cabriolet is covered against rusting through from the inside for 12 years. Naturally, the New Beetle and New Beetle Cabriolet must be cared for in compliance with the operating instructions. Please consult your authorised Volkswagen retailer or repairer for full warranty details.

Service Intervals.

Volkswagen are pleased to offer you a choice on how your New Beetle and New Beetle Cabriolet are serviced. The appropriate selection is entirely dependent on how the car is likely to be driven and its general use. To help you identify which type of service would be most suitable, please refer to the following guide.

The Time and Distance Service is recommended for vehicles that will cover less than 10,000 miles in 12 months and if the vehicle is likely to be used in the following way:

- Predominantly urban driving, short journeys with frequent cold starts.
- Activities regularly producing high engine loading, e.g. frequent hill climbs, driving with vehicle fully loaded and towing.
- Uneconomical driving style using high rpms with heavy acceleration and heavy braking.

The service intervals for the Time and Distance Service are as follows:

- Oil change service
Every 10,000 miles/1 year (whichever is soonest).
- Interval service
Every 20,000 miles/2 years (whichever is soonest).
- Interval service inspection
Every 40,000 miles/4 years (whichever is soonest).

The LongLife Service is recommended for vehicles with a daily mileage of more than 25 miles where the vehicle is driven regularly mainly on longer distance journeys. The vehicle is driven mainly at a constant speed with minimum vehicle and engine loading, minimal towing and driven in an economical manner.

With the LongLife Service the vehicle can cover anywhere between 10,000[†] and a maximum of 20,000[†] miles or 24 months (whichever is soonest).

[†] Please note that mileages are approximate as the service indicator system uses kilometres as the distance measurement. Please consult your authorised Volkswagen retailer or repairer for advice and full details.

Approved Accessories.

A comprehensive range of accessories from alloy wheels to carpet mats is available to complement the factory-fitted option list. Volkswagen approved accessories purchased from and fitted by your authorised Volkswagen retailer at the point of vehicle sale will also benefit from the three-year vehicle warranty.

Extended Warranty.

You may purchase additional protection from your authorised Volkswagen retailer or repairer, or contact 0870 9000 115.

Volkswagen Finance[‡].

Volkswagen Finance specialises in providing funding solutions for Volkswagen drivers. Whether your Volkswagen is for private or business use, you can choose from a range of funding options.

- Solutions – a personal contract plan
- Hire purchase
- Lease purchase
- Finance lease
- Contract hire

With all Volkswagen Finance products you can choose a fixed-cost maintenance plan to help you budget for your servicing and maintenance costs.

No matter what finance product you choose, your local Volkswagen retailer will be able to provide you with a personalised quote that could meet your budget and vehicle needs.

[‡] Volkswagen Finance is a trading name of Volkswagen Financial Services (UK) Limited. An offer of finance depends on certain conditions. Available to people over 18 in the UK only.

Volkswagen Insurance[±].

Competitive and comprehensive motor insurance designed especially for Volkswagen drivers. All new and Approved Used Volkswagens come with complimentary seven-day cover upon request – we'll e-mail a cover note straight to your retailer, enabling them to tax your car easily. This way, you can drive straight out of the showroom. Taking out annual cover is easy and it can start when the seven-day cover expires. For more information contact your local Volkswagen retailer or call 0800 051 3136.

[±] Volkswagen Insurance is underwritten and administered by Zurich Insurance Company. Volkswagen Insurance is a trading name of Volkswagen Insurance Service (Great Britain) Limited which is an appointed representative of Volkswagen Financial Services (UK) Limited. Zurich Insurance Company and Volkswagen Financial Services (UK) Limited are both authorised and regulated by the Financial Services Authority.

Volkswagen Assistance.

Every new car is registered for Volkswagen Assistance for one year. This provides vehicle recovery in the unlikely event of a breakdown (subject to conditions). Volkswagen Assistance can also be purchased for subsequent years. For full details, please contact your authorised Volkswagen retailer.

Tax Free Sales.

For full details, please contact your authorised Volkswagen retailer.

CO₂ Emission.

The weight of a vehicle will influence the level of CO₂ emission it produces; as a result, vehicles with higher levels of specification and factory-fitted options may emit higher levels of CO₂.

The CO₂ figure quoted for each vehicle is the maximum possible. The unladen weight of the vehicle is calculated by range at the time of manufacture and the maximum possible CO₂ emission for that weight range is applied according to the Council Directive 80/1268EEC as amended by Commission Directive 1999/100/EC on the approximation of the laws of the member states relating to the carbon dioxide emissions and the fuel consumption of motor vehicles.

Please Note:

Some illustrations in this brochure do not necessarily reflect UK specifications and may not be available. In particular, controls and some items of equipment are positioned differently for the UK.

The specifications contained in this brochure are for information purposes only and are subject to change. If you require any specific feature, you must consult your authorised Volkswagen retailer who is regularly updated with any change in specification. Please check model availability and full specification details with your authorised Volkswagen retailer prior to ordering.

Note: We would like to advise you that telephone calls to Volkswagen Customer Care may be monitored and recorded as part of our training and quality assurance processes. All our monitoring and recording processes meet Ofcom regulations.