



Aus Liebe zum Automobil

The Passat Estate



Design.



As soon as you set eyes on the Passat Estate, size and space will take on a new meaning. Combining the practicalities of an estate with the elegance of a saloon, this exceptional car delivers power and charisma more successfully than ever before. From the very first glance, the Passat Estate makes a definitive statement, its wide track width and low-set front end producing a striking appearance, giving a hint of the driving pleasure to come. The gleaming chrome-plated radiator grille surround, a real design highlight, reinforces the story. The rounded in-set headlights add an extra touch of style, echoed through its flowing aerodynamic curves and rear light cluster incorporating LED technology. This is a car designed to command attention and get results. Inside, the promise of the exterior is realised, with innovative design delivering new levels of functionality. Nowhere is this more apparent than in the boot space, where stowage capacity is increased to an impressive 1,641* litres, with the rear seats folded down.

As with any estate, flexibility and versatility are paramount, and here the Passat Estate excels, with a number of different options providing a wealth of practical solutions. For example, the optional cargo management system allows you to organise the load area with maximum efficiency, using an adjustable securing rail and retractable load securing strap to create areas of varying sizes and stow items safely and securely. So, whether you're looking to transport luggage, snowboards or simply some shopping, you'll find enough space and sufficient fixing solutions to meet all your stowage requirements.



01. Flexible: the rear seat and backrest of the Passat Estate can be folded asymmetrically, extending the loading space to a length of up to 1,960 mm.

02. Versatile: the optional cargo management system features an adjustable securing rail and retractable load securing strap to divide the luggage compartment laterally or diagonally, fastening items securely on both sides.

03. Stylish: the elegant design of the Passat Estate SEL with optional Bi-Xenon headlights and front fog lights.

04. Harmonious: Elegant design using refined materials, combine to create a luxurious interior.

05. Impressive: An aerodynamic rear tailgate spoiler and striking rear light clusters emphasise the character of the exterior.

06. Reassuring: Every seat is fitted with a head restraint and three-point seat belt, so you can relax whilst feeling both safe and secure.

* Measurement according to ISO 3832 using 200 x 100 x 50 mm blocks, with rear bench folded down and loading to roof (including 90 litres in the stowage space of the spare wheel recess with the Tyre Mobility Set).

Interior.



The Passat Estate not only tells a story of exceptional space and load carrying capacity, but also superb ergonomics and interior ambience. Sit in the driving seat and you'll immediately appreciate its intelligent and convenient design, with the clearly arranged instrument panel and easily accessible controls, enhanced by the beautifully co-ordinated, luxurious décor. In such an environment, it's easy to feel good.

Carefully positioned for effortless driving, the electronic parking brake and press and drive key are where you would intuitively expect them, close at hand, with parking and starting operating literally at the touch of a button. For the ultimate in relaxed driving, the cruise control system, standard on SE and SEL models, maintains a preselected speed automatically, without having to use the accelerator – ideal for motorway driving. And with an abundance of storage space within the doors, roof console and front seat centre armrest (optional on S), there is ample room to store maps, sunglasses, CDs and more.

The story of practicality continues. Thanks to the transversely mounted engine and the fact that the interior is now extended, the Passat Estate also offers plenty of space for rear seat passengers. Which means, wherever you are sitting, front or rear, you'll benefit from significantly more legroom. Never has size been more attractively presented, or aesthetics more practically arranged.

01. High-quality: the luxurious décor and precision workmanship ensure an interior ambience that is both enjoyable and relaxing.

02. Helpful: the electronic parking brake secures the vehicle easily and reliably at the touch of a button, releasing automatically as soon as you pull away.

03. Easy: thanks to the press and drive key, starting has never been simpler.

04. Convenient: the optional multifunction steering wheel enables you to select numerous functions without taking your hands from the wheel while driving. The clearly arranged instrument panel and controls are also located directly within your field of vision.

05. Relaxing: the cruise control system, which is standard on SE and SEL models, makes driving even more enjoyable. Speed is automatically controlled, over 19 mph, enabling you to take your foot off the accelerator and relax.

06. Generous: the practical centre console offers ample storage space, for CDs, sunglasses or drinks, and from SE upwards, a front seat centre armrest.

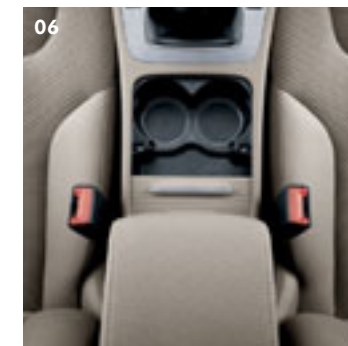
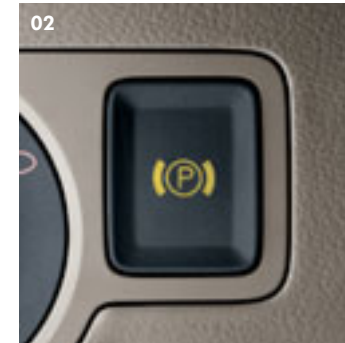

**1,641 litres
stowage capacity.**



Model shown is SE 2.0 TDI with optional 17" 'Le Mans' alloy wheels and pearl effect paint.



Interior shown is S with optional radio system RCD 500.



The Passat Estate S.

The Passat Estate S leaves nothing to the imagination, with a wealth of safety features ensuring maximum protection and driving enjoyment. The comprehensive safety package includes such features as an Anti-lock Braking System (ABS), an Electronic Stabilisation Programme (ESP), Traction Control (ASR), speed-sensitive power-assisted steering, driver's and front passenger's WOKS (whiplash-optimised head restraints), and front, side and curtain airbags. Aesthetically too, the Passat Estate S delivers, with an elegance and style that is both understated and assured. Distinctive 'Blackpoint' decorative inserts in the dash and centre console, chrome-plated instrument surrounds and stylish 'Calino' cloth upholstery combine to produce an eye-catching image, while 16 inch 'Milwaukee' alloy wheels with 215/55 R16 tyres guarantee dynamic handling and appearance. And demonstrating its immense versatility, black roof rails, storage compartments in the roof console, doors and centre console offer a final touch of practicality. There's even space in the driver's door for the optionally available Volkswagen umbrella.

The Passat Estate S also offers a whole host of standard fittings providing everything you would expect – and more – from an extraordinary car. The front electric windows and electrically heated and adjustable door mirrors provide added convenience, the tailgate unlocks automatically with remote operation and the press and drive key allows you to start the engine simply by pushing the key. In addition, the rear seat backrest with integral centre armrest splits 60:40 allowing it to be folded down in separate sections, ideal if you're loading bulky items, and the stylish four-spoke steering wheel individually adjusts to your optimum driving position. And that's just for starters. Also fitted as standard is a multifunction computer, electronic parking brake, RCD 300 radio/single CD player, 'Climatic' semi-automatic air conditioning, alarm with interior protection and remote central locking. As you can see, Volkswagen have thought of everything – all you have to do is concentrate on enjoying the drive.



The Passat Estate SE.

The Passat Estate SE offers the ultimate in comfort. Well appointed and beautifully crafted, it boasts a number of interior features designed to ensure total driving pleasure whatever the length of your journey. The 6-way electrically adjustable driver's seat with lumbar support and adjustable backrest guarantees the best possible seating posture. High quality 'Verona' velour upholstery and a leather trimmed three-spoke steering wheel and gear knob provide both comfort and style, while a front seat centre armrest offers an extra touch of luxury. To help you reduce stress on longer journeys, cruise control will automatically maintain your desired speed above 19 mph without you having to touch the accelerator pedal.

From the outside, the SE can be distinguished by its body-coloured front bumper strips, 'chrome satin' side window surrounds, chrome-plated side strips and rear strip, while 16 inch 'Catalunya' alloy wheels with 215/55 R16 tyres add a distinctive finishing touch.



Interior shown is SE with optional radio system RCD 500.



Interior shown is Sport with optional radio system RCD 500.



Stylish 17" 'Monte Carlo' alloy wheels, sports suspension, front fog lights and tinted windows from the B pillar back give the Passat Estate Sport a distinctive sporty look.

The Passat Estate Sport.

The very first glimpse of the Passat Estate Sport conveys its phenomenal power and dynamic performance. And regardless of which engine specification you choose, 17 inch 'Monte Carlo' alloy wheels with 235/45 R17 tyres ensure that the sports suspension, lowered by approximately 15 mm, performs spectacularly on tarmac. Of course, it's not until you actually drive the Passat Estate Sport that the full dynamic extent of this exceptional car is really revealed.

Once you're in the driving seat, the streamlined interior and predominance of sporting features only reinforce the impression. With a leather trimmed three-spoke steering wheel and matching gear knob providing that all-important extra grip, tinted windows from the B pillar back and a 6-way electrically-operated, fully adjustable driver's sport seat with 'Karah' cloth upholstery ensuring optimal lateral support at all times. 2Zone electronic climate control completes the carefully planned interior ergonomics, while the exterior black roof rails ensure even bulky items can be reliably secured and transported.

The Passat Estate Sport also has an automatic dimming interior rear-view mirror, rain sensor, dusk sensor and front fog lights ensuring good visibility even during bad weather. In addition, the coming/leaving home lighting function enables headlights and rear lights to illuminate the immediate area, making it easier and safer for you to get in or out of the car. Sporty and practical, the Passat Estate Sport offers an unbeatable combination.

In addition if you prefer the added stability and safety provided by four wheel drive, you could specify the Sport 2.0 litre TDI 140 PS 4MOTION. Volkswagen's sophisticated four wheel drive system allows the engine power to be transferred to the wheels with the best traction. The system gives the optimum traction for all driving situations and adds to the already high levels of driver and passenger safety, even in the most demanding conditions.



Heated front sports seats in 'Alcantara' leather with 6-way electric adjustment gives the Passat Estate SEL exceptional comfort and flexibility.

The Passat Estate SEL.

Exclusivity typifies the Passat Estate SEL. With its chrome-plated radiator grille and roundel surround, 'chrome satin' side window surrounds and side strips, high-gloss chrome-plated roof rails and 16 inch 'Adelaide' alloy wheels with 215/55 R16 tyres, the elegant exterior exudes quality and refinement. The aesthetics continue in the beautifully crafted interior, with brushed aluminium or walnut wood decorative inserts in the dash and centre console, depending upon upholstery colour. A host of features creates a more relaxed driving environment, including a multifunction display, 2Zone electronic climate control, cruise control, front sport seats in Alcantara leather*, which are heated for added comfort, an automatic dimming interior rear-view mirror and RCD 500 radio system equipped with dash-mounted six CD autochanger and eight speakers. With so many extra touches such as heated windscreen washer jets, dusk sensor, automatic coming/leaving home lighting function and front footwell illumination the Passat Estate SEL literally does all the work for you. All you have to do is enjoy the journey.

Specify the SEL V6 4MOTION, and your Passat comes equipped with 17" 'Solitude' alloy wheels with 235/45 R17 tyres, including a full size alloy spare wheel. Also included with the V6 4MOTION model is Volkswagen's 4MOTION four wheel drive system fitted as standard along with a 'Highline' multifunction computer and a tyre pressure monitoring system, which alerts the driver to any change in tyre pressure.

* Some parts of leather interior will contain artificial leather.



Interior shown is SEL with optional 'Dynaudio' Soundpack.

Engines.



01. The DSG gearbox offers a genuine alternative to a manual gearbox because it is able to change gear faster than a manual gearbox and more smoothly than a conventional automatic.

02. Highly efficient FSI technology takes the petrol engine to a new level of efficiency, boosting performance while lowering fuel consumption, even at low revs.



03. TDI diesel engines with revolutionary 'Pumpe Düse' direct injection technology deliver outstanding performance with exceptionally low fuel consumption.

Every journey is a special experience in the Passat Estate, thanks to Volkswagen's superb range of economical, high-torque petrol and diesel engines, all designed to make driving pure pleasure. The four FSI petrol variants benefit from innovative direct injection technology, where the fuel is injected into the combustion chamber under high pressure, resulting in impressive performance even at low revs. The powerful four cylinder 1.6 litre engine develops a healthy 115 PS. Two exceptional 2.0 litre engines both with a six speed gearbox offer even greater drive dynamics, generating 150 PS or 200 PS and ensuring others only have the Passat Estate's elegant rear end to admire. If it's performance you're seeking, the 3.2 litre FSI V6 4MOTION 250 PS is sure to impress, with 330 Nm of torque produced between 2,750 - 3,750 rpm and 0 - 62 mph achieved in just 7.2 seconds.

The three diesel variants are particularly sophisticated, mainly in terms of flexibility and fuel economy. First is the four cylinder 1.9 litre TDI engine with a five speed gearbox, developing 105 PS and 250 Nm of torque at 1,900 rpm. Like most Passat Estates, it has a 70 litre fuel tank (68 litres on 4MOTION models), and thanks to 'Pumpe Düse' technology, achieves 48.7 mpg on the Combined cycle* – a benefit that will make your next journey even more pleasurable.

The second diesel option, the powerful 2.0 litre TDI engine, is available with either a six speed manual gearbox or with Volkswagen's revolutionary six speed automatic DSG gearbox. With the manual gearbox, this engine can deliver 140 PS and 320 Nm between 1,750 and 2,500 rpm while returning 47.9 mpg on the Combined cycle*. In addition if you prefer the added stability and safety provided by four wheel drive, you could specify the 2.0 litre TDI 140 PS 4MOTION on SE or Sport models.

Finally, the powerful 2.0 litre TDI diesel engine produces an impressive 170 PS, can accelerate from 0 - 62 mph in 8.8 seconds and is capable of a top speed of 137 mph, where the law permits.

As part of Volkswagen's continued dedication to meet European emissions legislation, certain diesel engines are now available with an optional Diesel Particulate Filter (DPF). This is part of the exhaust system responsible for cleaning the exhaust gases before they enter the atmosphere. In addition to converting the harmful exhaust gases in the same way as a conventional catalytic converter, the DPF uses advanced technology to reduce the emission of black smoke and soot. It filters the exhaust gases and particles before they leave the vehicle exhaust system, resulting in a cleaner environment and less pollution entering the atmosphere.

Please note, driving conditions within inner-cities and the Channel Islands do not provide optimum conditions for the use of DPF technology. Therefore, it is advised that you consider this before ordering your vehicle with DPF.

* Please see the Engines section for fuel consumption and CO₂ emissions figures.

S – 1.6 litre FSI 115 PS.

Technical specification.

		Manual	
Engine	Engine type	Four cylinder petrol	
	Cubic capacity, ltrs/cc	1.6/1598	
	Max. output, PS ⁽⁰¹⁾ /kW at rpm	115/85 6000	
	Max. torque, lbs.ft/Nm at rpm	114/155 4000	
	Gearbox	Six speed manual	
Weights, kgs	Unladen weight ⁽⁰²⁾	1403	
	Gross vehicle weight	2040	
	Payload ⁽⁰²⁾	637	
	Axle load limit: Front Rear	1000 1090	
Trailer load limits, kgs ⁽⁰³⁾	Braked 12% incline	1300	
	Unbraked	730	
	Towbar load limit	85	
	Max. roof load	100	
Performance	Top speed (where the law permits), mph (km/h)	122 (197)	
	Acceleration, secs 0 - 62 mph	11.7	
	ABI insurance group	7	
Environmental information	Fuel grade, minimum	Unleaded, 95 RON ⁽⁰⁴⁾	
	Fuel tank capacity, galls/ltrs	15.4/70	
	Official fuel consumption, mpg/ltr per 100 km ⁽⁰⁵⁾		
	Urban	28.0/10.1	
	Extra-urban	45.6/6.2	
	Combined	37.2/7.6	
	Official CO ₂ emission, g/km ⁽⁰⁶⁾	181	
Emission class	EURO 4		
Noise, dB	74.0		

Notes.

- 01) The maximum power output figures are quoted in PS (or Pferdestärke, which is the metric equivalent of horsepower). To convert from metric to imperial horsepower, divide the PS figure by 1.0139.
- 02) Figures are calculated in accordance with manufacturer's criteria. Vehicle unladen weight ranges with 90% tank capacity without driver. The individual unladen weight depends on the specification of the vehicle, this then reduces the possible payload accordingly.
- 03) With increasing altitude the engine performance diminishes. From 1,000 m above sea level and for every 1,000 m thereafter 10% of the vehicle/trailer weight (trailer weight + gross vehicle weight) must be deducted.
- 04) Thanks to the knock control, unleaded four star (at least 95 RON) can be used instead of unleaded Super plus. In order to achieve maximum fuel consumption benefits on the FSI engine, Ultra Low Sulphur Petrol (ULSP) must be used.
- 05) Official fuel consumption according to EU Directive 99/94. The consumption calculation according to 1999/100/EC is based on the actual unladen weight of the vehicle. Additional specifications can lead to a higher weight class and hence to consumption figures of this higher weight class. The driving style, road and traffic conditions, environmental influences and vehicle condition can in practice lead to consumption figures, which may differ from those calculated with this standard.
- 06) The weight of a vehicle will influence the level of CO₂ emission it produces; as a result, vehicles with higher levels of specification and factory-fitted options may emit higher levels of CO₂. The CO₂ figure quoted for each vehicle is the maximum possible. The unladen weight of the vehicle is calculated by range at the time of manufacture and the maximum possible CO₂ emission for that weight range is applied according to the Council Directive 80/1268EEC as amended by Commission Directive 1999/100/EC on the approximation of the laws of the member states relating to the carbon dioxide emissions and the fuel consumption of motor vehicles.
- 07) The use of RME and FAME (bio diesel) is not possible.

S, SE – 2.0 litre FSI 150 PS.

Technical specification.

		Manual	Automatic
Engine	Engine type	Four cylinder petrol	Four cylinder petrol
	Cubic capacity, ltrs/cc	2.0/1984	2.0/1984
	Max. output, PS ⁽⁰¹⁾ /kW at rpm	150/110 6000	150/110 6000
	Max. torque, lbs.ft/Nm at rpm	148/200 3500	148/200 3500
	Gearbox	Six speed manual	Six speed auto tiptronic
Weights, kgs	Unladen weight ⁽⁰²⁾	1445	1474
	Gross vehicle weight	2080	2110
	Payload ⁽⁰²⁾	635	636
	Axle load limit: Front Rear	1040 1090	1070 1090
Trailer load limits, kgs ⁽⁰³⁾	Braked 12% incline	1500	1500
	Unbraked	750	750
	Towbar load limit	85	85
	Max. roof load	100	100
Performance	Top speed (where the law permits), mph (km/h)	130 (210)	127 (205)
	Acceleration, secs 0 - 62 mph	9.6	10.5
	ABI insurance group	10, 10	10, 10
Environmental information	Fuel grade, minimum	Unleaded, 95 RON ⁽⁰⁴⁾	Unleaded, 95 RON ⁽⁰⁴⁾
	Fuel tank capacity, galls/ltrs	15.4/70	15.4/70
	Official fuel consumption, mpg/ltr per 100 km ⁽⁰⁵⁾		
	Urban	24.6/11.5	21.9/12.9
	Extra-urban	44.1/6.4	41.5/6.8
	Combined	34.0/8.3	31.4/9.0
	Official CO ₂ emission, g/km ⁽⁰⁶⁾	197	213
Emission class	EURO 4	EURO 4	
Noise, dB	74.0	71.0	

Notes.

- 01) The maximum power output figures are quoted in PS (or Pferdestärke, which is the metric equivalent of horsepower). To convert from metric to imperial horsepower, divide the PS figure by 1.0139.
- 02) Figures are calculated in accordance with manufacturer's criteria. Vehicle unladen weight ranges with 90% tank capacity without driver. The individual unladen weight depends on the specification of the vehicle, this then reduces the possible payload accordingly.
- 03) With increasing altitude the engine performance diminishes. From 1,000 m above sea level and for every 1,000 m thereafter 10% of the vehicle/trailer weight (trailer weight + gross vehicle weight) must be deducted.
- 04) Thanks to the knock control, unleaded four star (at least 95 RON) can be used instead of unleaded Super plus. In order to achieve maximum fuel consumption benefits on the FSI engine, Ultra Low Sulphur Petrol (ULSP) must be used.
- 05) Official fuel consumption according to EU Directive 99/94. The consumption calculation according to 1999/100/EC is based on the actual unladen weight of the vehicle. Additional specifications can lead to a higher weight class and hence to consumption figures of this higher weight class. The driving style, road and traffic conditions, environmental influences and vehicle condition can in practice lead to consumption figures, which may differ from those calculated with this standard.
- 06) The weight of a vehicle will influence the level of CO₂ emission it produces; as a result, vehicles with higher levels of specification and factory-fitted options may emit higher levels of CO₂. The CO₂ figure quoted for each vehicle is the maximum possible. The unladen weight of the vehicle is calculated by range at the time of manufacture and the maximum possible CO₂ emission for that weight range is applied according to the Council Directive 80/1268EEC as amended by Commission Directive 1999/100/EC on the approximation of the laws of the member states relating to the carbon dioxide emissions and the fuel consumption of motor vehicles.
- 07) The use of RME and FAME (bio diesel) is not possible.

Sport – 2.0 litre T-FSI 200 PS.

Technical specification.

		Manual	Automatic
Engine	Engine type	Four cylinder petrol	Four cylinder petrol
	Cubic capacity, ltrs/cc	2.0/1984	2.0/1984
	Max. output, PS ⁽⁰¹⁾ /kW at rpm	200/147 5100	200/147 5100
	Max. torque, lbs.ft/Nm at rpm	207/280 1800-5000	207/280 1800-5000
	Gearbox	Six speed manual	Six speed auto tiptronic
Weights, kgs	Unladen weight ⁽⁰²⁾	1500	1518
	Gross vehicle weight	2130	2150
	Payload ⁽⁰²⁾	630	632
	Axle load limit: Front Rear	1080 1100	1100 1100
Trailer load limits, kgs ⁽⁰³⁾	Braked 12% incline	1600	1600
	Unbraked	750	750
	Towbar load limit	85	85
	Max. roof load	100	100
Performance	Top speed (where the law permits), mph (km/h)	144 (232)	141 (227)
	Acceleration, secs 0 - 62 mph	7.7	7.9
	ABI insurance group	15	15
Environmental information	Fuel grade, minimum	Unleaded, 95 RON ⁽⁰⁴⁾	Unleaded, 95 RON ⁽⁰⁴⁾
	Fuel tank capacity, galls/ltrs	15.4/70	15.4/70
	Official fuel consumption, mpg/ltr per 100 km ⁽⁰⁵⁾		
	Urban	25.0/11.3	22.6/12.5
	Extra-urban	44.1/6.4	41.5/6.8
	Combined	34.4/8.2	31.7/8.9
	Official CO ₂ emission, g/km ⁽⁰⁶⁾	194	212
Emission class	EURO 4	EURO 4	
Noise, dB	73.0	70.0	

Notes.

- 01) The maximum power output figures are quoted in PS (or Pferdestärke, which is the metric equivalent of horsepower). To convert from metric to imperial horsepower, divide the PS figure by 1.0139.
- 02) Figures are calculated in accordance with manufacturer's criteria. Vehicle unladen weight ranges with 90% tank capacity without driver. The individual unladen weight depends on the specification of the vehicle, this then reduces the possible payload accordingly.
- 03) With increasing altitude the engine performance diminishes. From 1,000 m above sea level and for every 1,000 m thereafter 10% of the vehicle/trailer weight (trailer weight + gross vehicle weight) must be deducted.
- 04) Thanks to the knock control, unleaded four star (at least 95 RON) can be used instead of unleaded Super plus. In order to achieve maximum fuel consumption benefits on the FSI engine, Ultra Low Sulphur Petrol (ULSP) must be used.
- 05) Official fuel consumption according to EU Directive 99/94. The consumption calculation according to 1999/100/EC is based on the actual unladen weight of the vehicle. Additional specifications can lead to a higher weight class and hence to consumption figures of this higher weight class. The driving style, road and traffic conditions, environmental influences and vehicle condition can in practice lead to consumption figures, which may differ from those calculated with this standard.
- 06) The weight of a vehicle will influence the level of CO₂ emission it produces; as a result, vehicles with higher levels of specification and factory-fitted options may emit higher levels of CO₂. The CO₂ figure quoted for each vehicle is the maximum possible. The unladen weight of the vehicle is calculated by range at the time of manufacture and the maximum possible CO₂ emission for that weight range is applied according to the Council Directive 80/1268EEC as amended by Commission Directive 1999/100/EC on the approximation of the laws of the member states relating to the carbon dioxide emissions and the fuel consumption of motor vehicles.
- 07) The use of RME and FAME (bio diesel) is not possible.

SEL – 3.2 litre FSI V6 4MOTION 250 PS.

Technical specification.

		Automatic	
Engine	Engine type	Six cylinder petrol	
	Cubic capacity, ltrs/cc	3.2/3168	
	Max. output, PS ⁽⁰¹⁾ /kW at rpm	250/184 6250	
	Max. torque, lbs.ft/Nm at rpm	243/330 2750-3750	
	Gearbox	Six speed auto DSG	
Weights, kgs	Unladen weight ⁽⁰²⁾	1715	
	Gross vehicle weight	2350	
	Payload ⁽⁰²⁾	635	
	Axle load limit: Front Rear	1180 1220	
Trailer load limits, kgs ⁽⁰³⁾	Braked 12% incline	2200	
	Unbraked	750	
	Towbar load limit	85	
	Max. roof load	100	
Performance	Top speed (where the law permits), mph (km/h)	151 (243)	
	Acceleration, secs 0 - 62 mph	7.2	
	ABI insurance group	16	
Environmental information	Fuel grade, minimum	Unleaded, 95 RON ⁽⁰⁴⁾	
	Fuel tank capacity, galls/ltrs	15/68	
	Official fuel consumption, mpg/ltr per 100 km ⁽⁰⁵⁾		
	Urban	20.0/14.1	
	Extra-urban	36.7/7.7	
	Combined	28.2/10.0	
	Official CO ₂ emission, g/km ⁽⁰⁶⁾	238	
Emission class	EURO 4		
Noise, dB	73.0		

Notes.

- 01) The maximum power output figures are quoted in PS (or Pferdestärke, which is the metric equivalent of horsepower). To convert from metric to imperial horsepower, divide the PS figure by 1.0139.
- 02) Figures are calculated in accordance with manufacturer's criteria. Vehicle unladen weight ranges with 90% tank capacity without driver. The individual unladen weight depends on the specification of the vehicle, this then reduces the possible payload accordingly.
- 03) With increasing altitude the engine performance diminishes. From 1,000 m above sea level and for every 1,000 m thereafter 10% of the vehicle/trailer weight (trailer weight + gross vehicle weight) must be deducted.
- 04) Thanks to the knock control, unleaded four star (at least 95 RON) can be used instead of unleaded Super plus. In order to achieve maximum fuel consumption benefits on the FSI engine, Ultra Low Sulphur Petrol (ULSP) must be used.
- 05) Official fuel consumption according to EU Directive 99/94. The consumption calculation according to 1999/100/EC is based on the actual unladen weight of the vehicle. Additional specifications can lead to a higher weight class and hence to consumption figures of this higher weight class. The driving style, road and traffic conditions, environmental influences and vehicle condition can in practice lead to consumption figures, which may differ from those calculated with this standard.
- 06) The weight of a vehicle will influence the level of CO₂ emission it produces; as a result, vehicles with higher levels of specification and factory-fitted options may emit higher levels of CO₂. The CO₂ figure quoted for each vehicle is the maximum possible. The unladen weight of the vehicle is calculated by range at the time of manufacture and the maximum possible CO₂ emission for that weight range is applied according to the Council Directive 80/1268EEC as amended by Commission Directive 1999/100/EC on the approximation of the laws of the member states relating to the carbon dioxide emissions and the fuel consumption of motor vehicles.
- 07) The use of RME and FAME (bio diesel) is not possible.

S, SE – 1.9 litre TDI 105 PS.

Technical specification.

		Manual	
Engine	Engine type	Four cylinder diesel	
	Cubic capacity, ltrs/cc	1.9/1896	
	Max. output, PS ⁽⁰¹⁾ /kW at rpm	105/77 4000	
	Max. torque, lbs.ft/Nm at rpm	184/250 1900	
	Gearbox	Five speed manual	
Weights, kgs	Unladen weight ⁽⁰²⁾	1477	
	Gross vehicle weight	2100	
	Payload ⁽⁰²⁾	623	
	Axle load limit: Front Rear	1070 1080	
Trailer load limits, kgs ⁽⁰³⁾	Braked 12% incline	1500	
	Unbraked	750	
	Towbar load limit	85	
	Max. roof load	100	
Performance	Top speed (where the law permits), mph (km/h)	115 (185)	
	Acceleration, secs 0 - 62 mph	12.4	
	ABI insurance group	7, 7	
Environmental information	Fuel grade, minimum	Diesel Non DPF ⁽⁰⁷⁾	
	Fuel tank capacity, galls/ltrs	15.4/70	
	Official fuel consumption, mpg/ltr per 100 km ⁽⁰⁵⁾		
	Urban	38.2/7.4	
	Extra-urban	57.6/4.9	
	Combined	48.7/5.8	
	Official CO ₂ emission, g/km ⁽⁰⁶⁾	153	
	Emission class	EURO 4	
	Noise, dB	72.0	
	Fuel grade, minimum	Diesel DPF ⁽⁰⁷⁾	
	Fuel tank capacity, galls/ltrs	15.4/70	
	Official fuel consumption, mpg/ltr per 100 km ⁽⁰⁵⁾		
	Urban	37.7/7.5	
	Extra-urban	56.5/5.0	
	Combined	47.9/5.9	
	Official CO ₂ emission, g/km ⁽⁰⁶⁾	156	
	Emission class	EURO 4	
Noise, dB	71.0		

Notes.

- 01) The maximum power output figures are quoted in PS (or Pferdestärke, which is the metric equivalent of horsepower). To convert from metric to imperial horsepower, divide the PS figure by 1.0139.
- 02) Figures are calculated in accordance with manufacturer's criteria. Vehicle unladen weight ranges with 90% tank capacity without driver. The individual unladen weight depends on the specification of the vehicle, this then reduces the possible payload accordingly.
- 03) With increasing altitude the engine performance diminishes. From 1,000 m above sea level and for every 1,000 m thereafter 10% of the vehicle/trailer weight (trailer weight + gross vehicle weight) must be deducted.
- 04) Thanks to the knock control, unleaded four star (at least 95 RON) can be used instead of unleaded Super plus. In order to achieve maximum fuel consumption benefits on the FSI engine, Ultra Low Sulphur Petrol (ULSP) must be used.
- 05) Official fuel consumption according to EU Directive 99/94. The consumption calculation according to 1999/100/EC is based on the actual unladen weight of the vehicle. Additional specifications can lead to a higher weight class and hence to consumption figures of this higher weight class. The driving style, road and traffic conditions, environmental influences and vehicle condition can in practice lead to consumption figures, which may differ from those calculated with this standard.
- 06) The weight of a vehicle will influence the level of CO₂ emission it produces; as a result, vehicles with higher levels of specification and factory-fitted options may emit higher levels of CO₂. The CO₂ figure quoted for each vehicle is the maximum possible. The unladen weight of the vehicle is calculated by range at the time of manufacture and the maximum possible CO₂ emission for that weight range is applied according to the Council Directive 80/1268EEC as amended by Commission Directive 1999/100/EC on the approximation of the laws of the member states relating to the carbon dioxide emissions and the fuel consumption of motor vehicles.
- 07) The use of RME and FAME (bio diesel) is not possible.

S, SE, Sport – 2.0 litre TDI 140 PS.

Technical specification.

		Manual	Automatic
Engine	Engine type	Four cylinder diesel	Four cylinder diesel
	Cubic capacity, ltrs/cc	2.0/1968	2.0/1968
	Max. output, PS ⁽⁰¹⁾ /kW at rpm	140/103 4000	140/103 4000
	Max. torque, lbs.ft/Nm at rpm (DPF)	236/320 1750-2500 (1800-2500)	236/320 1750-2500 (1800-2500)
	Gearbox	Six speed manual	Six speed auto DSG
Weights, kgs	Unladen weight ⁽⁰²⁾	1510	1532
	Gross vehicle weight	2140	2170
	Payload ⁽⁰²⁾	630	638
	Axle load limit: Front Rear	1100 1090	1130 1090
Trailer load limits, kgs ⁽⁰³⁾	Braked 12% incline	1800	1800
	Unbraked	750	750
	Towbar load limit	85	85
	Max. roof load	100	100
Performance	Top speed (where the law permits), mph (km/h)	128 (206)	126 (203)
	Acceleration, secs 0 - 62 mph	10.1	10.1
	ABI insurance group	9, 9, 9	9, 9, 9
Environmental information	Fuel grade, minimum	Diesel Non DPF ⁽⁰⁷⁾	Diesel Non DPF ⁽⁰⁷⁾
	Fuel tank capacity, galls/ltrs	15.4/70	15.4/70
	Official fuel consumption, mpg/ltr per 100 km ⁽⁰⁵⁾		
	Urban	35.8/7.9	32.1/8.8
	Extra-urban	57.6/4.9	51.4/5.5
	Combined	47.9/5.9	42.8/6.6
	Official CO ₂ emission, g/km ⁽⁰⁶⁾	156	174
	Emission class	EURO 4	EURO 4
	Noise, dB	72.0	71.0
	Fuel grade, minimum	Diesel DPF ⁽⁰⁷⁾	Diesel DPF ⁽⁰⁷⁾
	Fuel tank capacity, galls/ltrs	15.4/70	15.4/70
	Official fuel consumption, mpg/ltr per 100 km ⁽⁰⁵⁾		
	Urban	35.8/7.9	31.4/9.0
	Extra-urban	56.5/5.0	50.4/5.6
	Combined	47.1/6.0	41.5/6.8
	Official CO ₂ emission, g/km ⁽⁰⁶⁾	158	180
	Emission class	EURO 4	EURO 4
Noise, dB	73.0	67.0	

Notes.

- 01) The maximum power output figures are quoted in PS (or Pferdestärke, which is the metric equivalent of horsepower). To convert from metric to imperial horsepower, divide the PS figure by 1.0139.
- 02) Figures are calculated in accordance with manufacturer's criteria. Vehicle unladen weight ranges with 90% tank capacity without driver. The individual unladen weight depends on the specification of the vehicle, this then reduces the possible payload accordingly.
- 03) With increasing altitude the engine performance diminishes. From 1,000 m above sea level and for every 1,000 m thereafter 10% of the vehicle/trailer weight (trailer weight + gross vehicle weight) must be deducted.
- 04) Thanks to the knock control, unleaded four star (at least 95 RON) can be used instead of unleaded Super plus. In order to achieve maximum fuel consumption benefits on the FSI engine, Ultra Low Sulphur Petrol (ULSP) must be used.
- 05) Official fuel consumption according to EU Directive 99/94. The consumption calculation according to 1999/100/EC is based on the actual unladen weight of the vehicle. Additional specifications can lead to a higher weight class and hence to consumption figures of this higher weight class. The driving style, road and traffic conditions, environmental influences and vehicle condition can in practice lead to consumption figures, which may differ from those calculated with this standard.
- 06) The weight of a vehicle will influence the level of CO₂ emission it produces; as a result, vehicles with higher levels of specification and factory-fitted options may emit higher levels of CO₂. The CO₂ figure quoted for each vehicle is the maximum possible. The unladen weight of the vehicle is calculated by range at the time of manufacture and the maximum possible CO₂ emission for that weight range is applied according to the Council Directive 80/1268EEC as amended by Commission Directive 1999/100/EC on the approximation of the laws of the member states relating to the carbon dioxide emissions and the fuel consumption of motor vehicles.
- 07) The use of RME and FAME (bio diesel) is not possible.

SE, Sport – 2.0 litre TDI 4MOTION 140 PS.

Technical specification.

		Manual	
Engine	Engine type	Four cylinder diesel	
	Cubic capacity, ltrs/cc	2.0/1968	
	Max. output, PS ⁽⁰¹⁾ /kW at rpm	140/103 4000	
	Max. torque, lbs.ft/Nm at rpm (DPF)	236/320 1750-2500 (1800-2500)	
	Gearbox	Six speed manual	
Weights, kgs	Unladen weight ⁽⁰²⁾	1609	
	Gross vehicle weight	2240	
	Payload ⁽⁰²⁾	631	
	Axle load limit: Front Rear	1130 1160	
Trailer load limits, kgs ⁽⁰³⁾	Braked 12% incline	2000	
	Unbraked	750	
	Towbar load limit	85	
	Max. roof load	100	
Performance	Top speed (where the law permits), mph (km/h)	125 (201)	
	Acceleration, secs 0 - 62 mph	10.5	
	ABI insurance group	10, 10	
Environmental information	Fuel grade, minimum	Diesel Non DPF ⁽⁰⁷⁾	
	Fuel tank capacity, galls/ltrs	15/68	
	Official fuel consumption, mpg/ltr per 100 km ⁽⁰⁵⁾		
	Urban	32.5/8.7	
	Extra-urban	50.4/5.6	
	Combined	42.2/6.7	
	Official CO ₂ emission, g/km ⁽⁰⁶⁾	177	
	Emission class	EURO 4	
	Noise, dB	73.0	
	Fuel grade, minimum	Diesel DPF ⁽⁰⁷⁾	
	Fuel tank capacity, galls/ltrs	15/68	
	Official fuel consumption, mpg/ltr per 100 km ⁽⁰⁵⁾		
	Urban	32.5/8.7	
	Extra-urban	47.9/5.9	
	Combined	40.9/6.9	
	Official CO ₂ emission, g/km ⁽⁰⁶⁾	182	
	Emission class	EURO 4	
Noise, dB	72.0		

Notes.

- 01) The maximum power output figures are quoted in PS (or Pferdestärke, which is the metric equivalent of horsepower). To convert from metric to imperial horsepower, divide the PS figure by 1.0139.
- 02) Figures are calculated in accordance with manufacturer's criteria. Vehicle unladen weight ranges with 90% tank capacity without driver. The individual unladen weight depends on the specification of the vehicle, this then reduces the possible payload accordingly.
- 03) With increasing altitude the engine performance diminishes. From 1,000 m above sea level and for every 1,000 m thereafter 10% of the vehicle/trailer weight (trailer weight + gross vehicle weight) must be deducted.
- 04) Thanks to the knock control, unleaded four star (at least 95 RON) can be used instead of unleaded Super plus. In order to achieve maximum fuel consumption benefits on the FSI engine, Ultra Low Sulphur Petrol (ULSP) must be used.
- 05) Official fuel consumption according to EU Directive 99/94. The consumption calculation according to 1999/100/EC is based on the actual unladen weight of the vehicle. Additional specifications can lead to a higher weight class and hence to consumption figures of this higher weight class. The driving style, road and traffic conditions, environmental influences and vehicle condition can in practice lead to consumption figures, which may differ from those calculated with this standard.
- 06) The weight of a vehicle will influence the level of CO₂ emission it produces; as a result, vehicles with higher levels of specification and factory-fitted options may emit higher levels of CO₂. The CO₂ figure quoted for each vehicle is the maximum possible. The unladen weight of the vehicle is calculated by range at the time of manufacture and the maximum possible CO₂ emission for that weight range is applied according to the Council Directive 80/1268EEC as amended by Commission Directive 1999/100/EC on the approximation of the laws of the member states relating to the carbon dioxide emissions and the fuel consumption of motor vehicles.
- 07) The use of RME and FAME (bio diesel) is not possible.

Sport, SEL – 2.0 litre TDI DPF 170 PS.

Technical specification.

		Manual	Automatic
Engine	Engine type	Four cylinder diesel	Four cylinder diesel
	Cubic capacity, ltrs/cc	2.0/1968	2.0/1968
	Max. output, PS ⁽⁰¹⁾ /kW at rpm	170/125 4200	170/125 4200
	Max. torque, lbs.ft/Nm at rpm	258/350 1750-2500	258/350 1750-2500
	Gearbox	Six speed manual	Six speed auto DSG
Weights, kgs	Unladen weight ⁽⁰²⁾	1512	1534
	Gross vehicle weight	2140	2170
	Payload ⁽⁰²⁾	628	636
	Axle load limit: Front	1100	1130
	Rear	1090	1090
Trailer load limits, kgs ⁽⁰³⁾	Braked 12% incline	1800	1800
	Unbraked	750	750
	Towbar load limit	85	85
	Max. roof load	100	100
Performance	Top speed (where the law permits), mph (km/h)	137 (220)	135 (217)
	Acceleration, secs 0 - 62 mph	8.8	8.8
	ABI insurance group	13, 13	13, 13
Environmental information	Fuel grade, minimum	Diesel DPF ⁽⁰⁷⁾	Diesel DPF ⁽⁰⁷⁾
	Fuel tank capacity, galls/ltrs	15.4/70	15.4/70
	Official fuel consumption, mpg/ltr per 100 km ⁽⁰⁵⁾		
	Urban	34.4/8.2	32.8/8.6
	Extra-urban	52.3/5.4	49.6/5.7
	Combined	44.1/6.4	42.2/6.7
	Official CO ₂ emission, g/km ⁽⁰⁶⁾	169	177
	Emission class	EURO 4	EURO 4
Noise, dB	74.0	69.0	

Notes.

- 01) The maximum power output figures are quoted in PS (or Pferdestärke, which is the metric equivalent of horsepower). To convert from metric to imperial horsepower, divide the PS figure by 1.0139.
- 02) Figures are calculated in accordance with manufacturer's criteria. Vehicle unladen weight ranges with 90% tank capacity without driver. The individual unladen weight depends on the specification of the vehicle, this then reduces the possible payload accordingly.
- 03) With increasing altitude the engine performance diminishes. From 1,000 m above sea level and for every 1,000 m thereafter 10% of the vehicle/trailer weight (trailer weight + gross vehicle weight) must be deducted.
- 04) Thanks to the knock control, unleaded four star (at least 95 RON) can be used instead of unleaded Super plus. In order to achieve maximum fuel consumption benefits on the FSI engine, Ultra Low Sulphur Petrol (ULSP) must be used.
- 05) Official fuel consumption according to EU Directive 99/94. The consumption calculation according to 1999/100/EC is based on the actual unladen weight of the vehicle. Additional specifications can lead to a higher weight class and hence to consumption figures of this higher weight class. The driving style, road and traffic conditions, environmental influences and vehicle condition can in practice lead to consumption figures, which may differ from those calculated with this standard.
- 06) The weight of a vehicle will influence the level of CO₂ emission it produces; as a result, vehicles with higher levels of specification and factory-fitted options may emit higher levels of CO₂. The CO₂ figure quoted for each vehicle is the maximum possible. The unladen weight of the vehicle is calculated by range at the time of manufacture and the maximum possible CO₂ emission for that weight range is applied according to the Council Directive 80/1268EEC as amended by Commission Directive 1999/100/EC on the approximation of the laws of the member states relating to the carbon dioxide emissions and the fuel consumption of motor vehicles.
- 07) The use of RME and FAME (bio diesel) is not possible.

The technology.

Transmission

- Front wheel drive through asbestos-free single-plate dry clutch. Hydraulic clutch-mechanism. Five/six speed manual, six speed automatic tiptronic or six speed automatic DSG gearbox with double joint half axles
- Four wheel drive (4MOTION only) with electronically controlled multi-plate clutch. Electronic differential lock, combined with a hydraulically operated single-plate dry clutch with asbestos-free lining via a six speed manual or six speed automatic DSG gearbox
- Five speed manual: 1.9 litre TDI 105 PS
- Six speed manual: 1.6 litre FSI 115 PS, 2.0 litre FSI 150 PS, 2.0 litre T-FSI 200 PS, 2.0 litre TDI 140 PS, 2.0 litre TDI 170 PS
- Six speed automatic: 2.0 litre FSI 150 PS, 2.0 litre T-FSI 200 PS
- Six speed automatic DSG: 3.2 litre FSI V6 4MOTION 250 PS, 2.0 litre TDI 140 PS, 2.0 litre TDI 170 PS

Running gear

- Electronic Stabilisation Programme (ESP) including Electronic Differential Lock (EDL) and Traction Control (ASR)
- Front suspension through coil springs with telescopic shock absorbers, all elements integrated in chassis legs
- Rear suspension with gas pressure shock absorbers and separate springs
- Wheel control: front through chassis legs and (lower) triangular wishbones (directionally stabilising steering roll radius)
- Wheel control: rear through four-link suspension with independent wheel suspension
- Front and rear anti-roll bar

Brakes

- Electronically controlled Anti-lock Braking System (ABS) with Electronic Brake-pressure Distribution (EBD)
- Diagonal twin-circuit brake system with inner-ventilated front disc brakes and rear disc brakes
- Asbestos-free brake pads
- Hydraulic Brake Assist (HBA)
- Electronic park brake

Steering

- Electro-mechanical steering rack
- Collapsible, height and lengthways adjustable safety steering column

Engines

- Front transverse-installed engine
- 1.6 litre/115 PS⁽⁰¹⁾ (85 kW) petrol engine: four cylinder in-line engine, aluminium cylinder head, four valves per cylinder with roller valve lever drive, electronic direct injection (FSI), programmed ignition with cylinder-selective anti-knock control, four single spark ignition coils, longlife spark plugs, exhaust gas recirculation, three-way front catalyst
- 2.0 litre/150 PS⁽⁰¹⁾ (110 kW) petrol engine: four cylinder in-line engine, aluminium cylinder head, four valves per cylinder with roller valve lever drive, electronic direct injection (FSI), programmed ignition with cylinder-selective anti-knock control, four single spark ignition coils, longlife spark plugs, exhaust gas recirculation, three-way front catalyst
- 2.0 litre/200 PS⁽⁰¹⁾ (147 kW) petrol engine: four cylinder in-line engine, aluminium cylinder head, four valves per cylinder with roller rocker finger valve drive, electronic direct injection (FSI), variable inlet valve timing, programmed ignition with cylinder-selective anti-knock control, four single spark ignition coils, longlife spark plugs, exhaust gas turbocharger, three-way close-coupled pre-catalyst and underbody catalyst, lambda control
- 3.2 litre/250 PS⁽⁰¹⁾ (184 kW) petrol engine: six cylinder transverse engine in 'V' format, aluminium cylinder head, four valves per cylinder with roller rocker valve lever drive, electronic indirect injection, six single spark ignition coils, lambda control
- 1.9 litre/105 PS⁽⁰¹⁾ (77 kW) diesel engine: four cylinder in-line engine, two valves per cylinder, electronically controlled 'Pumpe Düse' high pressure injection system, oxidation catalyst, turbocharger with variable turbine geometry
- 2.0 litre/140 PS⁽⁰¹⁾ (103 kW) diesel engine: four cylinder in-line engine, four valves per cylinder (two valves per cylinder with DPF engine), electronically controlled direct injection with pump injector unit, oil cooler, intercooler, exhaust gas recirculation, oxidation catalyst, turbocharger with variable turbine geometry
- 2.0 litre/170 PS⁽⁰¹⁾ (125 kW) diesel engine: four cylinder in-line engine, cast iron cylinder block, four valves per cylinder, electronically controlled direct injection with pump injector unit ('Pumpe Düse'), oil cooler, intercooler, exhaust gas recirculation, turbocharger with variable turbine geometry, catalytic coated diesel particulate filter (DPF)

01) The maximum power output figures are quoted in PS (or Pferdestärke, which is the metric equivalent of horsepower). To convert from metric to imperial horsepower, divide the PS figure by 1.0139.

Technical specification dimensions.

Exterior dimensions

Length, mm	4774
Width – excluding door mirrors, mm	1820
Width – opened front/rear doors, mm	3723/3462
Height, mm	1517
Height – opened bonnet/floor, mm	1826
Height – opened tailgate/floor, mm	2058
Wheelbase, mm	2709
Turning circle, mm	11400

Interior dimensions

Effective headroom – front, mm (with sunroof)	970 (952)
Effective headroom – rear, mm (with sunroof)	980 (980)
Elbow width – front, mm	1466
Elbow width – rear, mm	1511
Legroom – front, mm	725-1038

Maximum luggage capacity, litres VDA measuring method using 200 x 100 x 50 mm blocks

With rear seat upright	513
With rear seat folded	1641

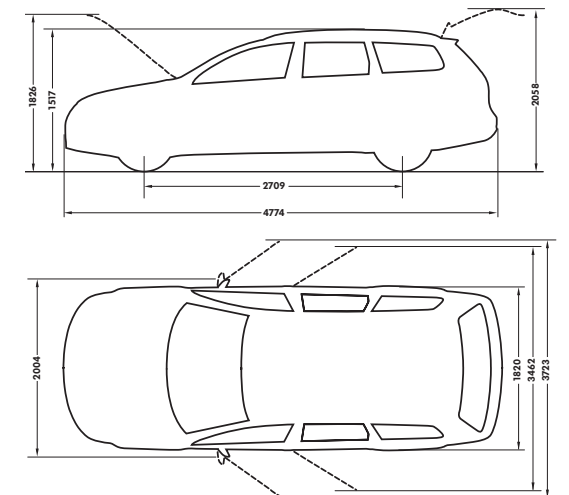

Safety.

01. The front suspension system utilises a spring strut front axle, chassis legs and (lower) triangular wishbones (directionally stabilising steering roll radius).

02. Rear wheel control is implemented through a four-link suspension system with independent wheel suspension.

03. The tyre pressure monitoring system conveniently indicates changes in tyre pressure on the instrument display. Standard on SEL V6 4MOTION models and optional on all other models.

04. Through a combination of Traction Control (ASR), Electronic Differential Lock (EDL) and Anti-lock Braking System (ABS), the Passat Estate delivers exceptional handling and braking.

05. The Electronic Stabilisation Programme (ESP) detects critical situations at an early stage and takes action by, for example, specifically braking individual wheels.

06. The body of the Passat Estate is formed from specially hardened components which possess high strength and excellent shaping characteristics. Thanks to the latest lightweight construction technology the body also offers optimal protection under heavy impact – all with a weight of only 298 kg.

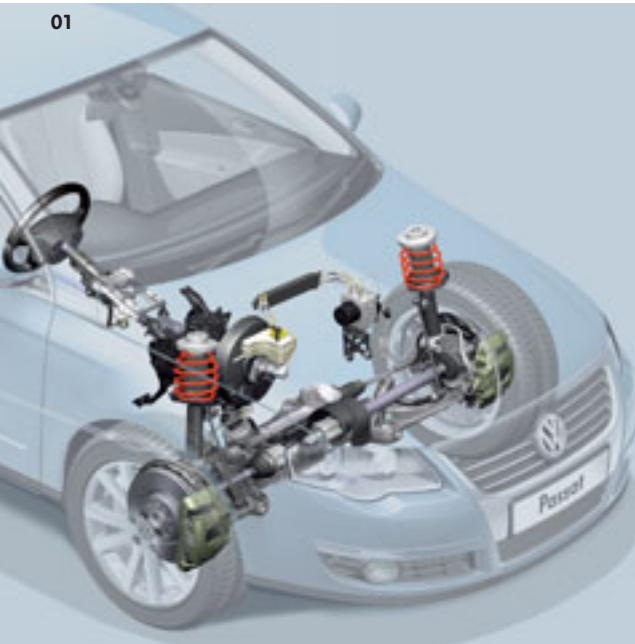

The most important consideration for any driver is safety. That's why it's so reassuring to drive the Passat Estate. With a whole range of new generation safety features included as standard, the Passat Estate provides the highest levels of safety possible, ensuring optimum protection in hazardous situations.

Of course, it's even better to avoid hazards in the first place, which is where the Passat Estate's active safety concept comes in. An innovative suspension system, with a spring strut front axle and four-link rear axle, counteracts any unevenness in the road surface, keeping the Passat Estate safely in place. At the same time, the driver benefits from electro-mechanical power-assisted steering, which reacts with extreme precision even at high speeds. The Electronic Stabilisation Programme (ESP) plays a further role, utilising Electronic Differential Lock (EDL) and Traction Control (ASR) to help correct oversteer, understeer and loss of stability of the vehicle. The result is optimum traction when rounding bends. And to ensure you retain control on a slippery surface, the Anti-lock Braking System (ABS) prevents the wheels from locking in the event of an abrupt braking manoeuvre. In addition, under emergency braking the hazard lights are automatically activated. Finally, a tyre monitoring indicator, standard on SEL V6 4MOTION and available as an optional extra on all other models, automatically lets you know via the instrument panel, as soon as there is any change in the vehicle's tyre pressure.

An important element of the Passat Estate's safety philosophy concerns the protection of other road users, and involves a completely new passive safety concept. It starts with special protection zones located in the front body area and bumpers, reducing the risk of injury to cyclists and pedestrians. Occupants of the Passat Estate are protected too, by a bodyshell equipped with crumple zones designed to absorb impact energy and protect the inner passenger compartment. Further protection is provided by a six airbag system, which includes driver's and front seat passenger's airbags, curtain airbags at the front and rear, and side impact airbags for the front, with rear available as an optional extra. In the event of an accident, WOKS (whiplash-optimised head restraints) on the front seats react within milliseconds, to help protect the head from injury and reduce whiplash. All this is supplemented by three-point automatic safety belts on all seats, an acoustic and optical warning for the driver's and front seat passenger's unfastened seat belts, and Volkswagen's innovative Isofix fittings to accommodate two child seats in the rear, providing maximum protection for children. As you can see, everything has been thought of to ensure maximum safety for all concerned, whether for other road users or for you and your passengers. You couldn't ask for more than that.

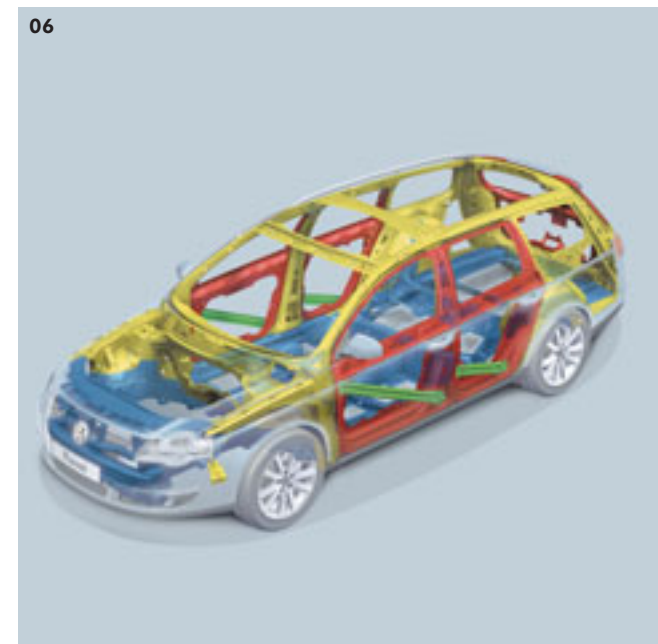

Wheels.

- 05** 'Westwood' 7½J x 17 alloy wheels with 235/45 R17 tyres. Optional on all models.
- 06** 'Macau' 7½J x 17 alloy wheels with 235/45 R17 tyres. Optional on all models.
- 07** 'Le Mans' 7½J x 17 alloy wheels with 235/45 R17 tyres. Optional on all models.
- 08** 'Monte Carlo' 7½J x 17 alloy wheels with 235/45 R17 tyres. Standard on Sport models and optional on all other models except SEL V6 4MOTION.



- 01** 'Milwaukee' 7J x 16 alloy wheels with 215/55 R16 tyres. Standard on S models and not available as an option.
- 02** 'Catalunya' 7J x 16 alloy wheels with 215/55 R16 tyres. Standard on SE models and not available as an option.
- 03** 'Adelaide' 7J x 16 alloy wheels with 215/55 R16 tyres. Standard on SEL models and not available as an option.
- 04** 'Solitude' 7½J x 17 alloy wheels with 235/45 R17 tyres. Standard on SEL V6 4MOTION models and not available as an option.



Also available, but not shown: The sports pack is designed to give your Passat Estate a sporty new look and includes a choice of 17" alloy wheels, approximately 15 mm lowered sports suspension, darkened windows from B pillar back and front fog lights.



Paint.

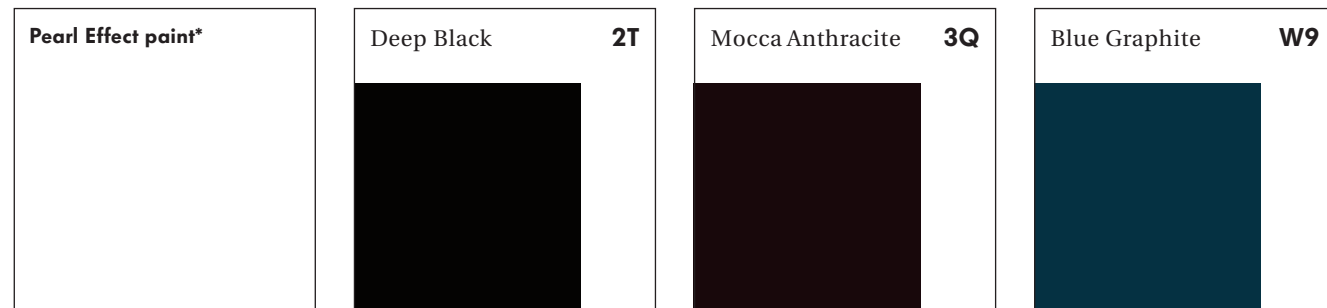
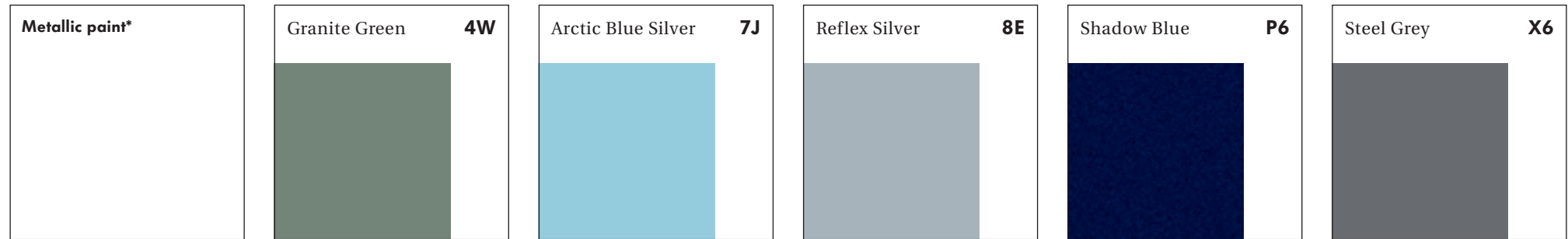
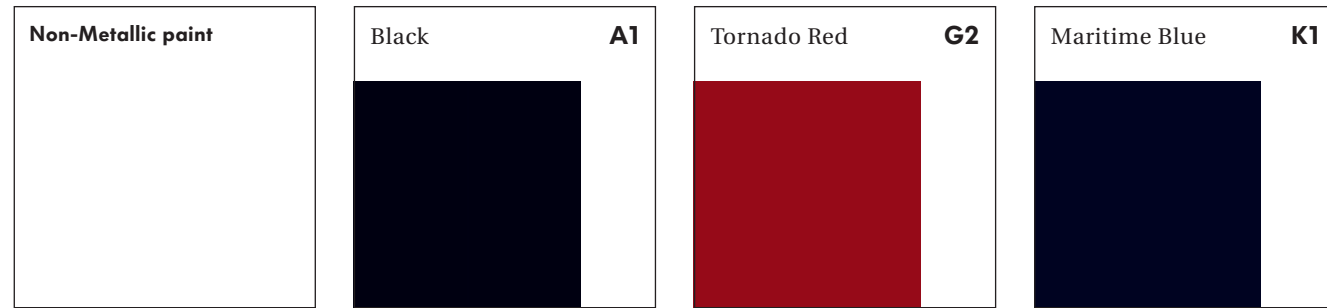

Decorative inserts.

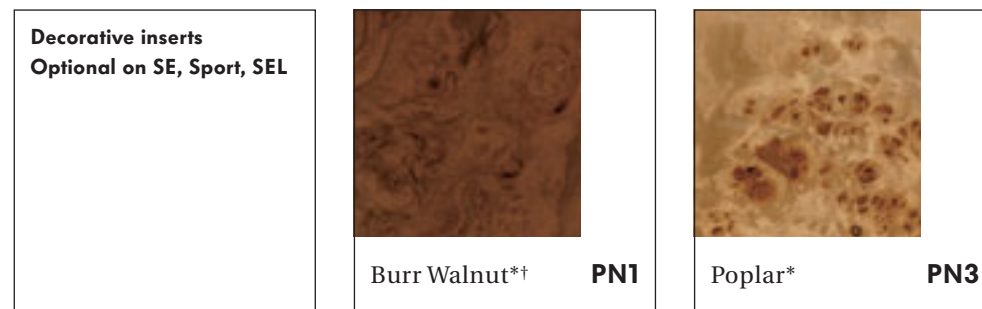

Please note: Screen technology does not allow for exact reproduction of the paint colours and decorative inserts. For further details, please contact your Volkswagen retailer.

* Decorative inserts, metallic and pearl effect paint are optional at extra cost.

† Standard on SEL models in conjunction with pure beige upholstery.

Standard upholstery.

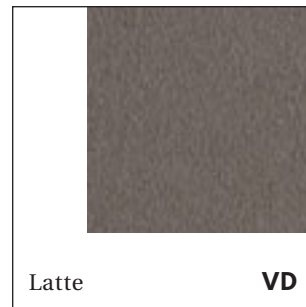
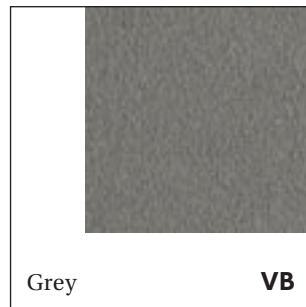
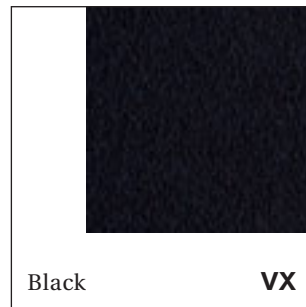
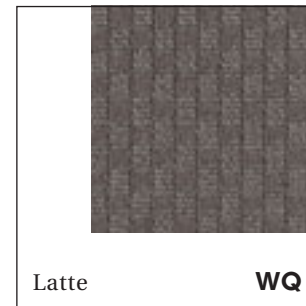
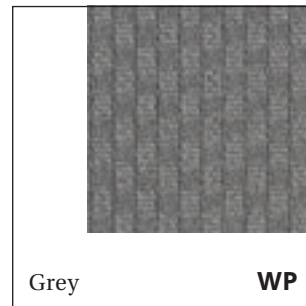
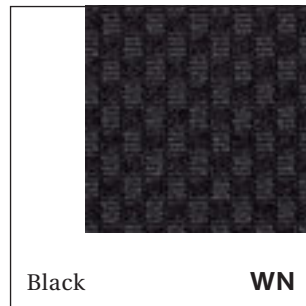
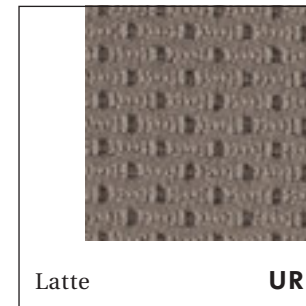
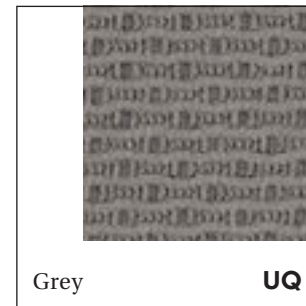
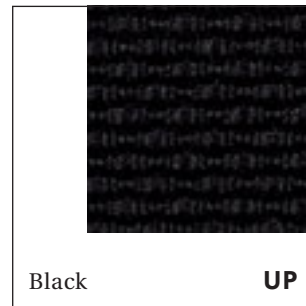
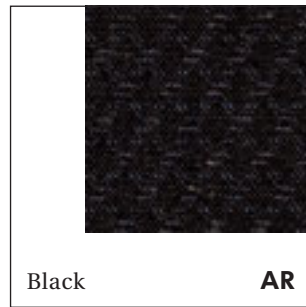
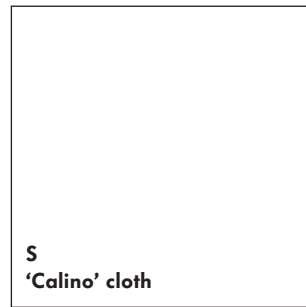

Please note: Screen technology does not allow for exact reproduction of the upholstery colours. For further details, please contact your Volkswagen retailer.

* Some parts of leather interior will contain artificial leather.

Optional upholstery.



Please note: Screen technology does not allow for exact reproduction of the upholstery colours. For further details, please contact your Volkswagen retailer.

* Some parts of leather interior will contain artificial leather.

Colour combinations.

	S	SE	Sport	SEL		Seat upholstery	Carpet	Dashboard	Black (A1)	Tornado Red (G2)	Maritime Blue (K1)	Granite Green Metallic (4W)*	Arctic Blue Silver Metallic (7J)*	Reflex Silver Metallic (8E)*	Shadow Blue Metallic (P6)*	Steel Grey Metallic (X6)*	Deep Black Pearl Effect (2T)*	Mocca Anthracite Pearl Effect (3Q)*	Blue Graphite Pearl Effect (W9)*
'Calino' cloth Standard on S	●				AR	Black	Black	Black/Black	●	●	●	●	●	●	●	●	●	●	●
'Verona' velour Standard on SE		●			UP	Black	Black	Black/Black	●	●	●	●	●	●	●	●	●	●	●
		●			UQ	Grey	Black	Black/Grey	●	●	●	●	●	●	●	●	●	●	●
		●			UR	Latte	Black	Black/Latte	●	●	●	●	●	●	●	●	●	●	●
'Karah' cloth Standard on Sport			●		WN	Black	Black	Black/Black	●	●	●	●	●	●	●	●	●	●	●
			●		WP	Grey	Black	Black/Grey	●	●	●	●	●	●	●	●	●	●	●
			●		WQ	Latte	Black	Black/Latte	●	●	●	●	●	●	●	●	●	●	●
Alcantara leather† Standard on SEL				●	VX	Black	Black	Black/Black	●	●	●	●	●	●	●	●	●	●	●
				●	VB	Grey	Black	Black/Grey	●	●	●	●	●	●	●	●	●	●	●
				●	VD	Latte	Black	Black/Latte	●	●	●	●	●	●	●	●	●	●	●
				●	VQ	Pure Beige	Pure Beige	Black/Pure Beige	●	●	●	●	●	●	●	●	●	●	●
'Vienna' leather comfort seats**† Optional on SE		○			XG	Black	Black	Black/Black	○	○	○	○	○	○	○	○	○	○	○
		○			XJ	Grey	Black	Black/Grey	○	○	○	○	○	○	○	○	○	○	○
		○			XK	Latte	Black	Black/Latte	○	○	○	○	○	○	○	○	○	○	○
		○			XM	Pure Beige	Pure Beige	Black/Pure Beige	○	○	○	○	○	○	○	○	○	○	○
Nappa leather sports seats**† Optional on Sport and SEL			○	○	ZQ	Black	Black	Black/Black	○	○	○	○	○	○	○	○	○	○	○
			○	○	ZX	Grey	Black	Black/Grey	○	○	○	○	○	○	○	○	○	○	○
			○	○	ZY	Latte	Black	Black/Latte	○	○	○	○	○	○	○	○	○	○	○
			○	○	ZZ	Pure Beige	Pure Beige	Black/Pure Beige	○	○	○	○	○	○	○	○	○	○	○

* Metallic and pearl effect paints and leather upholstery are optional at extra cost.
† Some parts of leather interior will contain artificial leather.

● Standard.
○ Optional at extra cost.

Optional equipment.



01 The combined DVD navigation/radio system comprises a 6½" colour display, DVD-ROM, acoustic and visual route recommendations, a 4 x 20 watt radio system and eight speakers, and either a six CD autochanger or glovebox-mounted iPod preparation.
The 2Zone electronic climate control air conditioning system, with indirect ventilation, uses electronic 2Zone temperature control to create an air conditioned environment individually suited to the driver and front seat passenger.

02 The RCD 500 radio system with integral dash-mounted six CD autochanger and Dynaudio sound system ensures fantastic sound quality. It uses a state-of-the-art ten channel amplifier that produces a 600 watt output through a total of ten front and rear speakers.

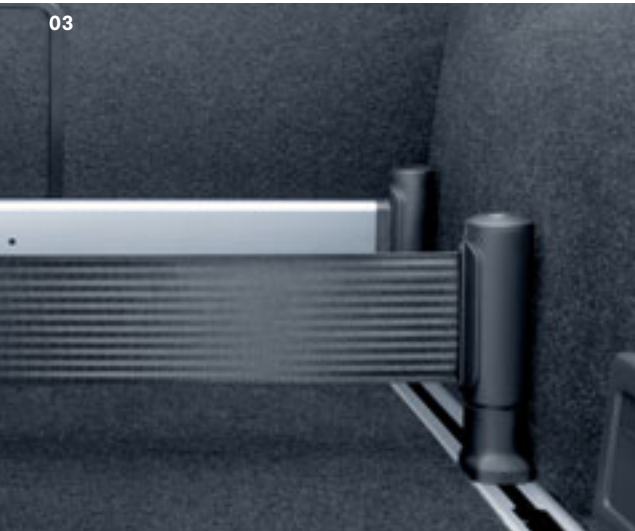

03 This specially designed cargo management system comprises two rails positioned on the left and right of the cargo area and four lashing eyelets. The rails can be used to individually fix straps and a telescopic rail into place using variable rod positions enabling secure stowage of luggage, whatever the size or shape.



04 iPod preparation mounted in the glovebox allows you to link your iPod to the vehicle's audio system. Controls are then provided through the radio keypad or optional multifunction steering wheel.

05 Bi-Xenon headlights with dynamic corner lighting produce a much clearer, brighter light for both dipped and main beam, giving you a clearer view of the road ahead and helping you drive more safely, particularly on winding roads. Also included in this option are headlight washers which help keep headlights free from dirt, ensuring maximum visibility.

06 The parking sensors, with sensors fitted in the front and rear bumpers, monitor the distance from an obstacle, helping you manoeuvre in and out of parking bays. An acoustic signal warns as an obstacle becomes closer.

07 Bluetooth telephone preparation* enables you to use your mobile phone without taking it out of your jacket pocket, thanks to Bluetooth connectivity. It is controlled via a separate keypad on the control panel.

Also available, but not shown:

Integrated child seats are integrated into the rear seat bench including seat belt tensioners for outer rear seats. A new design offers booster pillows integrated into the headrest mountings, giving your child even more side support. Please note that the integrated child seats are only available in conjunction with black upholstery or black leather.



* Only in conjunction with a multifunction steering wheel – phones must be compatible with rSAP (rSim Access Profile), please contact your retailer for phone compatibility.

Volkswagen service for your peace of mind.

The Volkswagen Warranty.

Three-year Warranty.

All Volkswagen Passat Estates come with a three-year/60,000 miles warranty, which protects your car against the failure of most mechanical and electrical components due to manufacturing defects. This comprises a two-year manufacturer's warranty with unlimited mileage plus a further one-year/60,000 miles (whichever is soonest) Retailer Warranty. Should the mileage exceed 60,000 miles within the first two years, the manufacturer's two-year warranty will still be valid. If an additional warranty for subsequent years or higher mileage is desired, it may be purchased from an authorised Volkswagen retailer or repairer; however, this additional warranty must be purchased before the mileage reaches 60,000*. Full details of the three-year warranty are available from your authorised Volkswagen retailer or repairer.

* All warranty work must be completed by an authorised Volkswagen retailer or repairer.

Three-year Paint Warranty.

The paintwork of the Passat Estate is covered against manufacturing defects for a period of three years. Naturally, the Passat Estate must be cared for in compliance with the operating instructions which will be found in your vehicle handbook. Please consult your authorised Volkswagen retailer or repairer for full warranty details.

12-year Body Protection Warranty.

The internal body sections and panels of the Passat Estates are covered against rusting through from the inside for 12 years. Naturally, the Passat Estate must be cared for in compliance with the operating instructions. Please consult your authorised Volkswagen retailer or repairer for full warranty details.

Service Intervals.

Volkswagen are pleased to offer you a choice on how your Passat Estate is serviced. The appropriate selection is entirely dependent on how the car is likely to be driven and its general use. To help you identify which type of service would be most suitable, please refer to the following guide.

The Time and Distance Service is recommended for vehicles that will cover less than 10,000 miles in 12 months and if the vehicle is likely to be used in the following way:

- Predominantly urban driving, short journeys with frequent cold starts.
- Activities regularly producing high engine loading, e.g. frequent hill climbs, driving with vehicle fully loaded and towing.
- Uneconomical driving style using high rpms with heavy acceleration and heavy braking.

The service intervals for the Time and Distance Service are as follows:

- Oil change service
Every 10,000 miles/1 year (whichever is soonest).
- Interval service
Every 20,000 miles/2 years (whichever is soonest).
- Interval service inspection
Every 40,000 miles/4 years (whichever is soonest).

The LongLife Service is recommended for vehicles with a daily mileage of more than 25 miles where the vehicle is driven regularly mainly on longer distance journeys. The vehicle is driven mainly at a constant speed with minimum vehicle and engine loading, minimal towing and driven in an economical manner.

With the LongLife Service the vehicle can cover anywhere between 10,000[†] and a maximum of 20,000[†] miles or 24 months (whichever is soonest).

[†] Please note that mileages are approximate as the service indicator system uses kilometres as the distance measurement. Please consult your authorised Volkswagen retailer or repairer for advice and full details.

Approved Accessories.

A comprehensive range of accessories from alloy wheels to carpet mats is available to complement the factory-fitted option list. Volkswagen approved accessories purchased from and fitted by your authorised Volkswagen retailer at the point of vehicle sale will also benefit from the three-year vehicle warranty.

Extended Warranty.

You may purchase additional protection from your authorised Volkswagen retailer or repairer, or contact 0870 9000 115.

Volkswagen Finance[‡].

Volkswagen Finance specialises in providing funding solutions for Volkswagen drivers. Whether your Volkswagen is for private or business use, you can choose from a range of funding options.

- Solutions – a personal contract plan
- Hire purchase
- Lease purchase
- Finance lease
- Contract hire

With all Volkswagen Finance products you can choose a fixed-cost maintenance plan to help you budget for your servicing and maintenance costs.

No matter what finance product you choose, your local Volkswagen retailer will be able to provide you with a personalised quote that could meet your budget and vehicle needs.

[‡] Volkswagen Finance is a trading name of Volkswagen Financial Services (UK) Limited. An offer of finance depends on certain conditions. Available to people over 18 in the UK only.

Volkswagen Insurance[±].

Competitive and comprehensive motor insurance designed especially for Volkswagen drivers. All new and Approved Used Volkswagens come with complimentary seven-day cover upon request – we'll e-mail a cover note straight to your retailer, enabling them to tax your car easily. This way, you can drive straight out of the showroom. Taking out annual cover is easy and it can start when the seven-day cover expires. For more information contact your local Volkswagen retailer or call 0800 051 3136.

[±] Volkswagen Insurance is underwritten and administered by Zurich Insurance Company. Volkswagen Insurance is a trading name of Volkswagen Insurance Service (Great Britain) Limited which is an appointed representative of Volkswagen Financial Services (UK) Limited. Zurich Insurance Company and Volkswagen Financial Services (UK) Limited are both authorised and regulated by the Financial Services Authority.

Volkswagen Roadside Assistance.

Every new car is registered for Volkswagen Roadside Assistance for one year. This provides vehicle home and roadside recovery in the unlikely event of a breakdown in the UK and Europe (subject to conditions). Volkswagen Roadside Assistance can also be purchased for subsequent years. For full details, please contact your authorised Volkswagen retailer.

Tax Free Sales.

For full details, please contact your authorised Volkswagen retailer.

CO₂ Emission.

The weight of a vehicle will influence the level of CO₂ emission it produces; as a result, vehicles with higher levels of specification and factory-fitted options may emit higher levels of CO₂.

The CO₂ figure quoted for each vehicle is the maximum possible. The unladen weight of the vehicle is calculated by range at the time of manufacture and the maximum possible CO₂ emission for that weight range is applied according to the Council Directive 80/1268EEC as amended by Commission Directive 1999/100/EC on the approximation of the laws of the member states relating to the carbon dioxide emissions and the fuel consumption of motor vehicles.

Please Note:

Some illustrations in this brochure do not necessarily reflect UK specifications and may not be available. In particular, controls and some items of equipment are positioned differently for the UK.

The specifications contained in this brochure are for information purposes only and are subject to change. If you require any specific feature, you must consult your authorised Volkswagen retailer who is regularly updated with any change in specification. Please check model availability and full specification details with your authorised Volkswagen retailer prior to ordering.

Note: We would like to advise you that telephone calls to Volkswagen Customer Care may be monitored and recorded as part of our training and quality assurance processes. All our monitoring and recording processes meet Ofcom regulations.