

The BMW 1 Series
Sports Hatch



The Ultimate
Driving Machine

Price List



BMW EfficientDynamics
Less emissions. More driving pleasure.



From March 2009

Contents

- 4 **BMW EfficientDynamics**
- 6 **Technical Introduction for 1 Series 3-door**
- 7 **Pricing for 1 Series 3-door**
- 8 **Technical Introduction for 1 Series 5-door**
- 9 **Pricing for 1 Series 5-door**
- 10 **Standard Equipment**
- 12 **M Sport**
- 13 **Paintwork**
- 14 **Interior Trim**
- 15 **Upholstery**
- 16 **Paintwork and Upholstery Combinations**
- 17 **Interior Trim and Upholstery Combinations**
- 18 **Colour Linked Parts**
- 19 **Wheels and Tyres**
- 21 **Optional Equipment**
- 35 **More about BMW**
- 38 **Technical Data**



The new
BMW 1 Series Sport



The Ultimate
Driving Machine

The new BMW 1 Series Sport.



The new
BMW 1 Series Sport





The Ultimate
Driving Machine

Model	Power output (hp)	0-62mph (secs)	Combined fuel consumption (mpg)	CO ₂ emissions (g/km)	VED band	Insurance group	Basic price (excluding VAT)	VAT	Retail price (including VAT)	On the road price	P11d value	BIK tax rate (2008/2009)
3-door												
116i Sport	122	9.8 (10.7)	48.7 (44.1)	139 (152)	C (D)	11 / 19	£14,230.43	£2,134.57	£16,365	£17,220	£17,045	15%
116d Sport	116	10.2	64.2	118	B	10 / 20	£15,343.48	£2,301.52	£17,645	£18,415	£18,325	13%
118d Sport	143	8.9 (9.0)	62.8 (52.3)	119 (144)	B (C)	11 / 22	£16,208.70	£2,431.30	£18,640	£19,410	£19,320	13%
5-door												
116i Sport	122	9.9 (10.8)	48.7 (44.1)	139 (152)	C (D)	11 / 19	£14,686.96	£2,203.04	£16,890	£17,745	£17,570	15%
116d Sport	116	10.3	64.2	118	B	10 / 20	£15,804.35	£2,370.65	£18,175	£18,945	£18,855	13%
118d Sport	143	9.0 (9.1)	62.8 (52.3)	119 (144)	B (C)	11 / 22	£16,669.57	£2,500.43	£19,170	£19,940	£19,850	13%

Optional Equipment*

The full range of paint colours, upholsteries, interior trims and optional equipment is available for all Sport models, priced as per the corresponding ES model, with the following exceptions:

		Pearlpoint cloth/leather upholstery	Boston leather upholstery	
All Sport models		£265	£970	
		V-spoke style 141	Star-spoke style 142	V-spoke style 217
Wheel size	Front / rear	7 J x 17	7 J x 17 / 7.5 J x 17	7.5 J x 18 / 8 J x 18
Tyre size	Front / rear	205/50 R17	205/50 R17 / 225/45 R17	205/45 R18 / 225/40 R18
	Option code	2KC	2CH	2KF
				
All Sport models		£0	£100	£475

BMW EfficientDynamics
Less emissions. More driving pleasure.



£1,315 saving is calculated based on the cost of specifying the options individually. Please note that images shown may include options available at additional cost. Figures in brackets refer to optional automatic transmission. *Please refer to the BMW 1 Series Price List for full details.



The new BMW 1 Series Sport

With near-perfect 50:50 weight distribution, award-winning BMW EfficientDynamics engine technologies and as the only car in its class with rear-wheel drive, the BMW 1 Series already sets the benchmark for dynamic performance, handling and agility.

But with the new Sport trim, now available on the 116i, 116d and 118d 3 and 5-door models, you can enhance this sporting character even further with £1,315 worth of complimentary additional equipment, over the corresponding ES model:

- 17" Star-spoke style 256 alloy wheels
- Front foglights for increased safety and visibility
- Heated exterior mirrors and windscreen washer jets
- Network cloth upholstery in Anthracite, Monaco Blue or Cranberry Red
- Sport leather steering wheel with multi-function controls
- Sport seats with electric side bolster adjustment



Every BMW 1 Series model comes equipped with a range of BMW EfficientDynamics technologies to deliver lower fuel consumption and reduced emissions, without compromising the class-leading performance.

This means for example, that both the 118d (2008 World Green Car of the Year) and the 116d (the cleanest and most fuel efficient BMW ever produced) will cost just £35 in annual road tax and travel over 700 miles on a single tank on the combined cycle.

The new BMW 1 Series Sport models provide a superior combination of sporting performance, enhanced efficiency and customer value – all adding up to an even more rewarding driving experience.



The BMW 118d - 2008 World Green Car of the Year



This is how much has gone in.

The pleasure you get from driving a BMW is the result of fine engineering – always setting the benchmark because it is based on much more than engine power. This is the thinking behind BMW's programme of EfficientDynamics. A change in philosophy, this programme of technologies helps to make positive changes in reducing CO₂ emissions and improving fuel consumption whilst enhancing driving dynamics. Changes for both today and tomorrow. Today's solutions include Brake Energy Regeneration, an innovative process for harnessing energy previously lost. As for tomorrow – even more advanced technologies to improve emissions and fuel consumption as we move towards BMW's vision of CleanEnergy and the use of hydrogen-powered engines. Nothing lost, but much gained. BMW EfficientDynamics: pushing the boundaries in terms of performance and dynamism – without compromise.

High-precision direct injection

In this cutting-edge generation of petrol direct injection, the Piezo injectors are positioned very close to the spark plugs. They inject the fuel at high pressure and with extreme precision. This ensures an outstanding power-to-consumption ratio. (Standard on 116i, 118i, 120i.)

Auto Start-Stop

BMW four-cylinder engines with six-speed manual transmission automatically shut down when the vehicle is stationary, for example at a red light or in traffic, when the driver shifts to neutral and releases the clutch. The engine restarts as soon as the clutch is activated again. This innovation significantly reduces fuel consumption especially in city traffic. (Standard on 116i, 118i, 120i, 116d, 118d, 120d, 123d.)

Optimum Shift Indicator

Timely gear shifts are one of the most effective and easiest ways to save fuel. This is where Optimum Shift Indicator in conjunction with six-speed manual transmission comes in. It shows the driver the most fuel-efficient gear to select for any driving situation. (Standard on all models.)

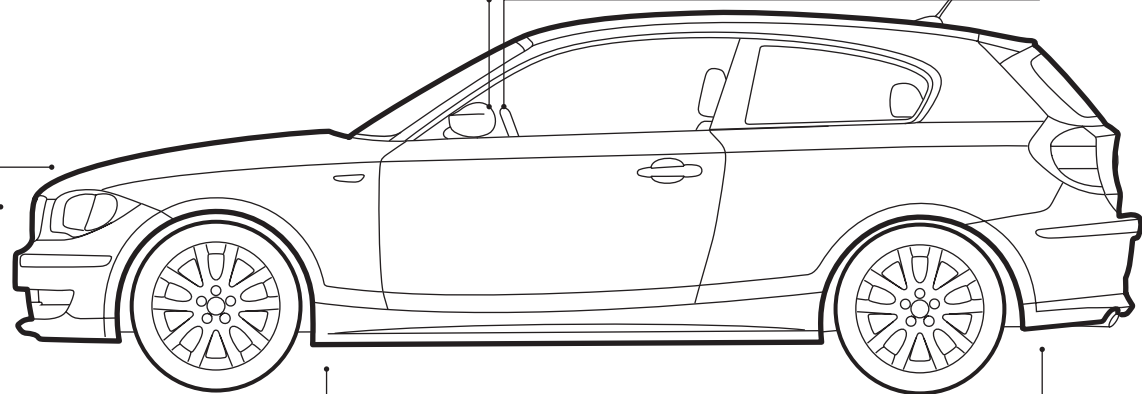

Active Aerodynamics

Engine management signals the engine's current cooling capacity requirements constantly while driving. Rendering a permanent airstream through the radiator unnecessary. The air vents in front of the radiator open or close depending on the environmental temperature and road speed. When shut they improve aerodynamics, shorten the engine's warm-up time and so reduce fuel consumption. (Standard on 116i, 118i, 120i, excluding M Sport models.)

Electric Power Steering

In comparison with conventional, hydraulic steering systems, the electrical steering only uses energy during actual steering. When the steering wheel is in a constant position – for example at high speed along the motorway – the electronic motor is inactive. (Standard on all models.)

Brake Energy Regeneration

The alternator disengages automatically when the battery is fully charged, only re-engaging when the battery needs charging. In addition, the system engages automatically when the car's brakes are applied or when coasting, to recycle otherwise wasted energy. (Standard on all models.)

Certain BMW EfficientDynamics features may be excluded depending on the optional equipment chosen. Your BMW Dealer will be pleased to provide you with more information.

And this is what comes out.

BMW already offers 81 models* with CO₂ emissions of 140 g/km or less. But that's just for starters. We're carrying on our research – in the quest to bring you more driving pleasure and less consumption.

* In the UK and Republic of Ireland.



BMW 1 Series 3-door Sports Hatch price list insert

Valid from 1 May 2009

Model	Power output (hp)	0-62 mph (secs)	Combined fuel consumption (mpg)	CO ₂ emissions (g/km)	VED band	Insurance group
Petrol						
116i	122	9.8 (10.7)	48.7 (44.1)	139 (152)	E (G)	11 / 19
116i ES	122	9.8 (10.7)	48.7 (44.1)	139 (152)	E (G)	11 / 19
116i Sport	122	9.8 (10.7)	48.7 (44.1)	139 (152)	E (G)	11 / 19
116i SE	122	9.8 (10.7)	48.7 (44.1)	139 (152)	E (G)	11 / 19
116i M Sport	122	9.8 (10.7)	48.7 (44.1)	139 (152)	E (G)	11 / 20
118i ES	143	8.7 (9.2)	47.9 (45.6)	140 (148)	E (F)	12 / 22
118i SE	143	8.7 (9.2)	47.9 (45.6)	140 (148)	E (F)	12 / 22
118i M Sport	143	8.7 (9.2)	47.9 (45.6)	140 (148)	E (F)	12 / 22
120i SE	170	7.7 (8.3)	44.1 (44.8)	152 (150)	G (F)	13 / 24
120i M Sport	170	7.7 (8.3)	44.1 (44.8)	152 (150)	G (F)	13 / 25
130i M Sport	265	6.0 (6.2)	34.0 (34.0)	197 (198)	J (J)	17 / 34

Diesel						
116d	116	10.2	64.2	118	C	10 / 20
116d ES	116	10.2	64.2	118	C	10 / 20
116d Sport	116	10.2	64.2	118	C	10 / 20
116d SE	116	10.2	64.2	118	C	10 / 20
116d M Sport	116	10.2	64.2	118	C	11 / 20
118d ES	143	8.9 (9.0)	62.8 (52.3)	119 (144)	C (F)	11 / 21
118d Sport	143	8.9 (9.0)	62.8 (52.3)	119 (144)	C (F)	11 / 21
118d SE	143	8.9 (9.0)	62.8 (52.3)	119 (144)	C (F)	11 / 21
118d M Sport	143	8.9 (9.0)	62.8 (52.3)	119 (144)	C (F)	11 / 22
120d SE	177	7.5 (7.7)	58.9 (52.3)	128 (144)	D (F)	14 / 26
120d M Sport	177	7.5 (7.7)	58.9 (52.3)	128 (144)	D (F)	14 / 26
123d SE	204	6.9 (7.0)	54.3 (50.4)	138 (148)	E (F)	16 / 32
123d M Sport	204	6.9 (7.0)	54.3 (50.4)	138 (148)	E (F)	16 / 32

Post-budget pricing

This insert is designed to be used with the BMW 1 Series 3 Door Sports Hatch Price List and details revised pricing information following the 2009 Government Budget announcement concerning changes to Vehicle Excise Duty bands and rates. The pricing found here is therefore valid from 1 May 2009 onwards.

Full technical data and details of standard and optional equipment can be found in the main Price List.

Prices and specifications

BMW (UK) Limited reserves the right to alter prices and specifications without notice. BMW (UK) Limited has made every effort to ensure the accuracy of information but does not accept liability for any errors or omissions.

Key Figures in (brackets) apply to cars with automatic transmission. Insurance group figures refer to – 20 Group Rating System / 50 Group Rating System.

Basic price (excluding VAT)	VAT	Retail price (including VAT)	On the road price	P11d value	BIK tax rate (2009 / 2010)
£13,526.09	£2,028.91	£15,555	£16,410	£16,235	15%
£14,230.43	£2,134.57	£16,365	£17,220	£17,045	15%
£14,230.43	£2,134.57	£16,365	£17,220	£17,045	15%
£15,291.30	£2,293.70	£17,585	£18,440	£18,265	15%
£16,617.39	£2,492.61	£19,110	£19,965	£19,790	15%
£15,773.91	£2,366.09	£18,140	£18,995	£18,820	16%
£16,834.78	£2,525.22	£19,360	£20,215	£20,040	16%
£18,160.87	£2,724.13	£20,885	£21,740	£21,565	16%
£17,700.00	£2,655.00	£20,355	£21,240	£21,035	18%
£18,965.22	£2,844.78	£21,810	£22,695	£22,490	18%
£22,491.30	£3,373.70	£25,865	£26,815	£26,545	27%

£14,639.13	£2,195.87	£16,835	£17,605	£17,515	13%
£15,343.48	£2,301.52	£17,645	£18,415	£18,325	13%
£15,343.48	£2,301.52	£17,645	£18,415	£18,325	13%
£16,404.35	£2,460.65	£18,865	£19,635	£19,545	13%
£17,730.43	£2,659.57	£20,390	£21,160	£21,070	13%
£16,208.70	£2,431.30	£18,640	£19,410	£19,320	13%
£16,208.70	£2,431.30	£18,640	£19,410	£19,320	13%
£17,269.57	£2,590.43	£19,860	£20,630	£20,540	13%
£18,595.65	£2,789.35	£21,385	£22,155	£22,065	13%
£18,530.43	£2,779.57	£21,310	£22,165	£21,990	18%
£19,795.65	£2,969.35	£22,765	£23,620	£23,445	18%
£20,013.04	£3,001.96	£23,015	£23,870	£23,695	18%
£21,226.09	£3,183.91	£24,410	£25,265	£25,090	18%

VED rates

Annual VED rates for brand new cars are determined by their CO₂ emission figure.

BMW 1 Series 3-door Sports Hatch models fall into one of the six categories listed below:

CO ₂ emissions g/km	Band C 111-120	Band D 121-130	Band E 131-140	Band F 141-150	Band G 151-165	Band J 186-200
Vehicle Excise Duty	£35	£120	£120	£125	£150	£215

On the road price

The recommended on the road price includes:

Delivery and BMW Emergency Service	£655
Number plates	£25
Vehicle first registration fee	£55
Vehicle Excise Duty (12 months)	See left

BMW 1 Series 5-door Sports Hatch price list insert

Valid from 1 May 2009

Model	Power output (hp)	0-62 mph (secs)	Combined fuel consumption (mpg)	CO ₂ emissions (g/km)	VED band	Insurance group
Petrol						
116i	122	9.9 (10.8)	48.7 (44.1)	139 (152)	E (G)	11 / 19
116i ES	122	9.9 (10.8)	48.7 (44.1)	139 (152)	E (G)	11 / 19
116i Sport	122	9.9 (10.8)	48.7 (44.1)	139 (152)	E (G)	11 / 19
116i SE	122	9.9 (10.8)	48.7 (44.1)	139 (152)	E (G)	11 / 19
116i M Sport	122	9.9 (10.8)	48.7 (44.1)	139 (152)	E (G)	11 / 20
118i ES	143	8.8 (9.3)	47.9 (45.6)	140 (148)	E (F)	12 / 22
118i SE	143	8.8 (9.3)	47.9 (45.6)	140 (148)	E (F)	12 / 22
118i M Sport	143	8.8 (9.3)	47.9 (45.6)	140 (148)	E (F)	12 / 22
120i SE	170	7.8 (8.4)	44.1 (44.8)	152 (150)	G (F)	13 / 24
120i M Sport	170	7.8 (8.4)	44.1 (44.8)	152 (150)	G (F)	13 / 25
130i M Sport	265	6.1 (6.3)	34.0 (34.0)	197 (198)	J (J)	17 / 34

Diesel						
116d	116	10.3	64.2	118	C	10 / 20
116d ES	116	10.3	64.2	118	C	10 / 20
116d Sport	116	10.3	64.2	118	C	10 / 20
116d SE	116	10.3	64.2	118	C	10 / 20
116d M Sport	116	10.3	64.2	118	C	11 / 20
118d ES	143	9.0 (9.1)	62.8 (52.3)	119 (144)	C (F)	11 / 21
118d Sport	143	9.0 (9.1)	62.8 (52.3)	119 (144)	C (F)	11 / 21
118d SE	143	9.0 (9.1)	62.8 (52.3)	119 (144)	C (F)	11 / 21
118d M Sport	143	9.0 (9.1)	62.8 (52.3)	119 (144)	C (F)	11 / 22
120d SE	177	7.6 (7.8)	58.9 (52.3)	128 (144)	D (F)	14 / 26
120d M Sport	177	7.6 (7.8)	58.9 (52.3)	128 (144)	D (F)	14 / 26
123d SE	204	7.0 (7.1)	54.3 (50.4)	138 (148)	E (F)	16 / 32
123d M Sport	204	7.0 (7.1)	54.3 (50.4)	138 (148)	E (F)	16 / 32

Post-budget pricing

This insert is designed to be used with the BMW 1 Series 5 Door Sports Hatch Price List and details revised pricing information following the 2009 Government Budget announcement concerning changes to Vehicle Excise Duty bands and rates. The pricing found here is therefore valid from 1 May 2009 onwards.

Full technical data and details of standard and optional equipment can be found in the main Price List.

Prices and specifications

BMW (UK) Limited reserves the right to alter prices and specifications without notice. BMW (UK) Limited has made every effort to ensure the accuracy of information but does not accept liability for any errors or omissions.

Key Figures in (brackets) apply to cars with automatic transmission. Insurance group figures refer to – 20 Group Rating System / 50 Group Rating System.

Basic price (excluding VAT)	VAT	Retail price (including VAT)	On the road price	P11d value	BIK tax rate (2009 / 2010)
£13,982.61	£2,097.39	£16,080	£16,935	£16,760	15%
£14,686.96	£2,203.04	£16,890	£17,745	£17,570	15%
£14,686.96	£2,203.04	£16,890	£17,745	£17,570	15%
£15,747.83	£2,362.17	£18,110	£18,965	£18,790	15%
£17,073.91	£2,561.09	£19,635	£20,490	£20,315	15%
£16,234.78	£2,435.22	£18,670	£19,525	£19,350	16%
£17,295.65	£2,594.35	£19,890	£20,745	£20,570	16%
£18,621.74	£2,793.26	£21,415	£22,270	£22,095	16%
£18,165.22	£2,724.78	£20,890	£21,775	£21,570	18%
£19,434.78	£2,915.22	£22,350	£23,235	£23,030	18%
£22,952.17	£3,442.83	£26,395	£27,345	£27,075	27%

£15,100.00	£2,265.00	£17,365	£18,135	£18,045	13%
£15,804.35	£2,370.65	£18,175	£18,945	£18,855	13%
£15,804.35	£2,370.65	£18,175	£18,945	£18,855	13%
£16,865.22	£2,529.78	£19,395	£20,165	£20,075	13%
£18,191.30	£2,728.70	£20,920	£21,690	£21,600	13%
£16,669.57	£2,500.43	£19,170	£19,940	£19,850	13%
£16,669.57	£2,500.43	£19,170	£19,940	£19,850	13%
£17,730.43	£2,659.57	£20,390	£21,160	£21,070	13%
£19,056.52	£2,858.48	£21,915	£22,685	£22,595	13%
£18,991.30	£2,848.70	£21,840	£22,695	£22,520	18%
£20,260.87	£3,039.13	£23,300	£24,155	£23,980	18%
£20,478.26	£3,071.74	£23,550	£24,405	£24,230	18%
£21,691.30	£3,253.70	£24,945	£25,800	£25,625	18%

VED rates

Annual VED rates for brand new cars are determined by their CO₂ emission figure.

BMW 1 Series 5-door Sports Hatch models fall into one of the six categories listed below:

CO ₂ emissions g/km	Band C 111-120	Band D 121-130	Band E 131-140	Band F 141-150	Band G 151-165	Band J 186-200
Vehicle Excise Duty	£35	£120	£120	£125	£150	£215

On the road price

The recommended on the road price includes:

Delivery and BMW Emergency Service	£655
Number plates	£25
Vehicle first registration fee	£55
Vehicle Excise Duty (12 months)	See left



116i

Engine

- Catalytic converter
- Digital Motor Electronics (DME)
- Double-VANOS
- Four-cylinder in-line petrol engine with high-precision direct injection with four-valve technology
- Oil level display

Transmission

- Gear lever, short-shift
- Six-speed manual transmission

Wheels and chassis

- 16" steel wheels with tyre size 195/55 R16
- Electric Power Steering
- Lightweight double-joint spring-strut front axle with aluminium strut brace
- Lightweight five-link rear axle
- Mobility tyre sealing system

Safety and technology

- Airbags:
 - Airbags, front sides (seat-integrated)
 - Crash sensor activating central locking release, hazard warning lights, fuel cut-off and interior lighting
 - Impact-Depending Airbag System (ID Airbags), driver and front passenger ITS head airbags – driver, front passenger and rear
- Alarm system (Thatcham 1) with remote control and engine immobiliser
- Brake Force Display
- Child locking system, rear doors (5-door only)
- Deformation zones – front and rear with door reinforcements and bumpers that regenerate to their original shape in impacts of up to 2.5 mph
- Disc brakes, front and rear with brake pad sensors
- Dynamic Stability Control (DSC) comprising:
 - Anti-lock Braking System (ABS)
 - Automatic Stability Control (ASC)
 - Cornering Brake Control (CBC)
 - Dynamic Brake Control (DBC)
 - Dynamic Traction Control (DTC)
 - Electronic Brake-force Distribution (EBD)

Safety and technology (cont.)

- First Aid kit and warning triangle
- Halogen headlights
- Head restraints – rear, foldable and removable
- High level third brake light
- On-Board Diagnosis (OBD)
- Seat belts – inertia reel at the front with pyrotechnical belt latch tensioner, belt force limiter, belt restrainer and manual height adjustment
- Seat belts – three with inertia reel, rear (two when four-seat configuration is specified)
- Side impact protection
- Tyre Puncture Warning System (TPWS)
- Visible VIN

Seats

- 60:40 split folding rear seat
- Child seat ISOFIX attachment, front and rear, with front passenger airbag deactivation
- Five seats
- Seat adjustment – front, manual
- Seat height adjustment – front, manual

Exterior equipment

- All round anti-corrosion system with partial hot galvanising, phosphate treatment and cathodic dip paintwork, preservation of hollow cavities, underfloor protection
- Exhaust tailpipe – single, oval
- Exterior mirrors – electric adjustment
- Exterior parts in body colour:
 - Bumpers
 - Door handles
 - Side sills
- Indicator lenses, clear
- Kidney grille chrome with black vertical slats
- Luggage compartment access via BMW Roundal
- Non-metallic paintwork
- Wash wipe system, rear
- Windscreen washer jets
- Windscreen wipers with adjustable intermittent intervals

Interior equipment

- Air microfilter
- Battery in luggage compartment with jump start facility in engine bay
- Central locking switch
- Courtesy lights, front and rear with soft on/off dimming
- Door sill finishers with BMW designation
- Electra cloth upholstery
- Electric windows – front and rear (rear 5-door only), with open/close fingertip control, anti-trap facility and comfort closing function (5-door only)
- Floor mats, velour
- Handbrake lever, gear lever knob and gaiters in Sensatec
- Lights-on warning
- Luggage compartment strap for small items
- Silver interior trim
- Smoker's package
- Start-Stop button
- Steering column with manual reach and rake adjustment
- Steering wheel, three-spoke
- Storage compartments in door panels, front and rear (rear 5-door only)
- Sun visors with vanity mirrors and ticket pocket
- Toolkit located in luggage compartment
- Two lashing eyes in luggage compartment

Audio and communication

- Auxilliary input point for auxilliary playing devices
- BMW Business radio with single CD player (with MP3 playback capability)
- On-Board Computer (OBC) comprising:
 - Average speed
 - Fuel consumption and range
 - Information display – analogue instruments combined with liquid crystal display
 - Journey Computer
 - Outside temperature display
- Personal Profile functions
- Power socket in rear of centre console – 12V

116d

Equipment in addition / replacement to 116i

- Common-rail injection system
- Diesel Particulate Filter (DPF)
- Digital Diesel Electronics (DDE)
- Incorrect fueling protection system
- Oil level sensor with dipstick
- Turbo

All ES models

Equipment in addition / replacement to base models

- 16" light alloy V-spoke style 229 wheels
- Air conditioning, manual

All SE models

Equipment in addition / replacement to base models

- 16" light alloy Double-spoke style 222 wheels
- Air conditioning, automatic with two-zone control
- Armrest – front, centre
- Exterior mirrors, heated
- Foglights, front
- Park Distance Control (PDC), rear
- Sport multi-function leather steering wheel, three-spoke
- Windscreen washer jets, heated

120i SE, 120d SE

Equipment in addition / replacement to SE models

- Exhaust tailpipe – single, chrome
- Satin Silver interior trim

123d SE

Equipment in addition / replacement to SE models

- 17" light alloy V-spoke style 141 wheels
- Door sill finishers with BMW designation, chrome plated, front and rear (rear 5-door only)
- Exhaust tailpipe – single, black-chrome
- Extended lighting
- Exterior trim, Chromeline (3-door)
- Exterior trim, High-gloss Shadowline (5-door)
- Handbrake lever, gear lever knob and gaiters in leather
- Network cloth upholstery
- Rear-view mirror, automatically dimming
- Run-flat tyres
- Two-stage, twin-turbo



All M Sport models – four cylinders
Equipment in addition / replacement to SE models

- 17" light alloy Double-spoke style 207M wheels
- Aluminium Glacier Silver interior trim
- Door sill finishers with M designation, chrome plated
- Exterior trim, High-gloss Shadowline
- Handbrake lever and gear lever knob in leather
- Headlining, Anthracite
- M aerodynamic bodystyling
- M Sport multi-function leather steering wheel, three spoke
- M Sport suspension
- Run-flat tyres
- Rear-view mirror, automatically dimming
- Sport seats in Flashpoint cloth/Sensatec, front

130i M Sport
Equipment in addition / replacement to M Sport models – four cylinders

- 18" light alloy M Double-spoke style 208M wheels
- Dynamic Stability Control Plus (DSC+) comprising:
 - Brake drying
 - Brake fade compensation
 - Brake pre-tensioning
 - Hill-start assistant
 - Soft-stop
- Exhaust tailpipes – twin, matt chrome
- Extended storage
- Kidney grille, chrome with chrome vertical slats
- Rain sensor with automatic headlight activation
- Six-cylinder in-line petrol engine
- VALVETRONIC engine management

● **Alpine White**
300 non-metallic

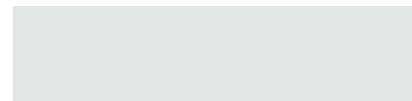

○ **Black Sapphire**
475 metallic



○ **Le Mans Blue****
381 metallic



○ **Patagonia Green***
A71 metallic



○ **Titanium Silver**
354 metallic



● **Crimson Red**
A61 non-metallic



○ **Bluewater***
896 metallic



○ **Monaco Blue***
A35 metallic



○ **Space Grey**
A52 metallic



● **Jet Black***
668 non-metallic



○ **Havana***
A17 metallic



○ **Montego Blue***
A51 metallic



○ **Tahiti Green***
A78 metallic



Key ● = Standard ○ = Optional * = Not available on M Sport models ** = Only available on M Sport models

These colour samples are designed to give you a first impression of paints and materials. Experience has shown however, that printed versions of paint, upholstery and trim colours cannot in all cases faithfully replicate the colour appearance of the originals. We recommend therefore that you consult your local BMW Dealer on your preferred choices.

● Silver 4AK

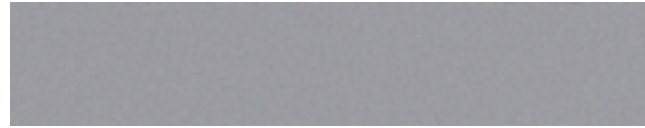

○ Black, high-gloss 4AT



○ Cashmere Silver 4B1

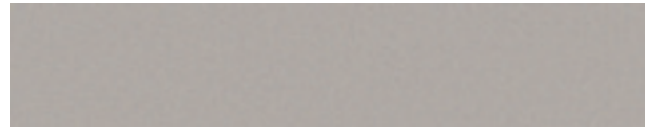

○ Light Burr Walnut wood 4A3



● Aluminium Glacier Silver 4MG**



○ Brushed Aluminium with accent line 4B3

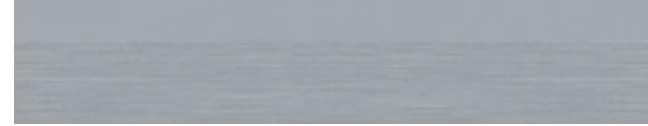

○ Dark Grey Poplar wood 4AS



○ Satin Silver 4CG¹



Key

● = Standard

○ = Optional

¹ = Standard on 120i, 120d and 123d SE

** = Standard on M Sport models

● Electra cloth*
Alaska Grey EAAL



● Flashpoint cloth / Sensatec**
Anthracite GCSW



○ Network cloth*
Anthracite AUAT



○ Pearlpoint cloth / leather*
Anthracite / Black FHAT



○ Boston leather
Alaska Grey LWAL

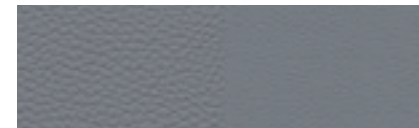

○ Boston leather
Lemon LWB7

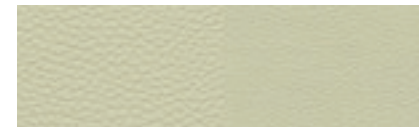

● Electra cloth*
Anthracite EAAT



○ Network cloth*
Cranberry Red AUF8



○ Pearlpoint cloth / leather*
Orange / Black FHF5



○ Boston Leather
Beige LWA5

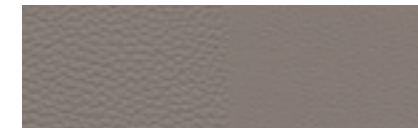

○ Boston leather
Terra LWB8

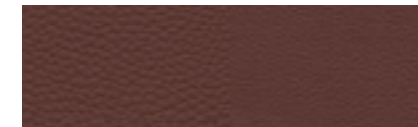

○ Network cloth*
Monaco Blue AUD9



○ Boston leather
Black LWSW

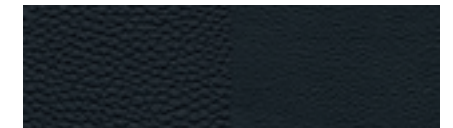

Key

● = Standard

○ = Optional

* = Not available on M Sport models

** = Only available on M Sport models

Model	Upholstery	Upholstery colour	Interior colour	Standard seats	Sport seats	Upholstery code	Metallic										Non-metallic		
							Titanium Silver	Black Sapphire	Bluewater*	Monaco Blue*	Space Grey	Montego Blue*	Havana*	Patagonia Green*	Tahiti Green*	Le Mans Blue**	Alpine White	Jet Black*	Crimson Red
							354	475	896	A35	A52	A51	A17	A71	A78	381	300	668	A61
Standard: Base, ES and SE	Electra cloth	Alaska Grey	Black	●	-	EAAL	●	●	●	●	●	●	●	●	●	-	●	●	●
		Anthracite	Black	●	-	EAAT	●	●	●	●	●	●	●	●	●	-	●	●	●
Standard: 123d SE Option: Base, ES and SE	Network cloth	Anthracite	Black	●	●	AUAT	●	●	●	●	●	●	●	●	●	-	●	●	●
		Cranberry Red	Black	●	●	AUF8	●	●	●	●	●	●	●	●	●	-	●	●	●
		Monaco Blue	Black	●	●	AUD9	●	●	●	●	●	●	●	●	●	-	●	●	●
Standard: M Sport	Flashpoint cloth / Sensatec**	Black	Black	-	●	GCSW	●	●	-	-	●	-	-	-	●	●	-	●	
Option: All	Boston leather	Alaska Grey	Alaska Grey	●	●	LWAL	●	●	●	●	●	●	●	●	●	●	●	●	●
		Beige	Beige	●	●	LWA5	●	●	●	●	●	●	●	●	●	●	●	●	●
		Black	Black	●	●	LWSW	●	●	●	●	●	●	●	●	●	●	●	●	●
		Lemon	Black	●	●	LWB7	●	●	●	●	●	●	●	●	●	●	●	●	●
		Terra	Black	●	●	LWB8	●	●	●	●	●	●	●	●	●	●	●	●	●
Option: Base, ES and SE	Pearlpoint cloth / leather	Anthracite / Black	Black	-	●	FHAT	●	●	●	●	●	●	●	●	-	●	●	●	
		Orange / Black	Black	-	●	FHF5	●	●	●	●	●	●	●	●	-	●	●	●	

Key ● = Available - = Not available * = Not available on M Sport models ** = Only available on M Sport models

The above table shows all available exterior and upholstery colour combinations. To view colour samples please consult your local BMW Dealer who will be happy to assist you with your choices. Alternatively, further combination details can be found on the 'Build your BMW' section of the www.bmw.co.uk website.

Model	Upholstery	Upholstery colour	Interior colour	Upholstery code	116i/d, 118i, 118d ES and SE models							120d, 123d, 120i, ES and SE models					M Sport models					
					Interior trim							Interior trim					Interior trim					
					Silver	Satin Silver	Black, high-gloss	Cashmere Silver	Brushed Aluminium with accent line	Dark Grey Poplar wood	Light Burr Walnut wood	Satin Silver	Black, high-gloss	Cashmere Silver	Brushed Aluminium with accent line	Dark Grey Poplar wood	Light Burr Walnut wood	Aluminium Glacier Silver**	Brushed Aluminium with accent line	Dark Grey Poplar wood	Light Burr Walnut wood	
					4AK	4CG	4AT	4B1	4B3	4AS	4A3	4CG	4AT	4B1	4B3	4AS	4A3	4MG	4B3	4AS	4A3	
Standard: Base, ES and SE	Electra cloth	Alaska Grey	Black	EAAL	●	○	○	○	○	○	○	●	◇	◇	○	○	○	-	-	-	-	
		Anthracite	Black	EAAT	●	○	○	○	○	○	○	○	●	◇	◇	○	○	○	-	-	-	-
Standard: 123d SE Option: Base, ES and SE	Network cloth	Anthracite	Black	AUAT	●	○	○	○	○	○	○	●	◇	◇	○	○	○	-	-	-	-	
		Cranberry Red	Black	AUF8	●	○	○	○	○	○	○	○	●	◇	◇	○	○	○	-	-	-	-
		Monaco Blue	Black	AUD9	●	○	○	○	○	○	○	○	●	◇	◇	○	○	○	-	-	-	-
Standard: M Sport models	Flashpoint cloth / Sensatec**	Black	Black	GCSW	-	-	-	-	-	-	-	-	-	-	-	-	-	●	◇	○	○	
Option: All	Boston leather	Alaska Grey	Alaska Grey	LWAL	-	○	○	○	○	○	○	●	◇	◇	○	○	○	●	◇	○	○	
		Beige	Beige	LWA5	-	○	○	○	○	○	○	○	●	◇	◇	○	○	○	●	◇	○	○
		Black	Black	LWSW	-	○	○	○	○	○	○	○	●	◇	◇	○	○	○	●	◇	○	○
		Lemon	Black	LWB7	-	○	○	○	○	○	○	○	●	◇	◇	○	○	○	●	◇	○	○
		Terra	Black	LWB8	-	○	○	○	○	○	○	○	●	◇	◇	○	○	○	●	◇	○	○
Option: Base, ES and SE	Pearlpoint cloth / leather	Anthracite / Black	Black	FHAT	●	○	○	○	○	○	○	●	◇	◇	○	○	○	-	-	-	-	
		Orange / Black	Black	FHF5	●	○	○	○	○	○	○	○	●	◇	◇	○	○	○	-	-	-	-

Key ● = Standard interior trim ◇ = Interior trim available at no cost ○ = Interior trim available at extra cost

- = Not available ** = Only available on M Sport models

The above table shows all available exterior and upholstery colour combinations. To view colour samples please consult your local BMW Dealer who will be happy to assist you with your choices. Alternatively, further combination details can be found on the 'Build your BMW' section of the www.bmw.co.uk website.

	Carpet	Floor mats	Dashboard		Seats		Doors		
			Lower	Upper	Seat back	Seat facing	Door insert	Door casing	Door armrest

Electra cloth upholstery

Alaska Grey	Alaska Grey	Alaska Grey	Alaska Grey	Black	Alaska Grey	Alaska Grey	Alaska Grey	Alaska Grey	Alaska Grey
Anthracite	Anthracite	Anthracite	Black	Black	Black	Anthracite	Anthracite	Black	Anthracite

Network cloth upholstery

Anthracite	Anthracite	Anthracite	Black	Black	Black	Anthracite	Anthracite	Black	Anthracite
Cranberry Red	Anthracite	Anthracite	Black	Black	Black	Cranberry Red	Cranberry Red	Black	Cranberry Red
Monaco Blue	Anthracite	Anthracite	Black	Black	Black	Monaco Blue	Monaco Blue	Black	Monaco Blue

Pearlpoint cloth / leather upholstery



Anthracite / Black	Anthracite	Anthracite	Black	Black	Black	Anthracite / Black	Anthracite / Black	Black	Black
Orange / Black	Anthracite	Anthracite	Black	Black	Black	Orange / Black	Orange / Black	Black	Black

Boston leather upholstery

Alaska Grey	Alaska Grey	Alaska Grey	Alaska Grey	Black	Alaska Grey	Alaska Grey	Alaska Grey	Alaska Grey	Alaska Grey
Beige	Beige	Beige	Beige	Black	Beige	Beige	Beige	Beige	Beige
Black	Anthracite	Anthracite	Black	Black	Black	Black	Black	Black	Black
Lemon	Anthracite	Anthracite	Black	Black	Black	Lemon	Lemon	Black	Lemon
Terra	Anthracite	Anthracite	Black	Black	Black	Terra	Terra	Black	Terra

Flashpoint / Sensatec upholstery

Black	Anthracite	Anthracite	Black	Black	Black	Anthracite	Anthracite	Black	Black
--------------	------------	------------	-------	-------	-------	------------	------------	-------	-------

		Steel wheel**	V-spoke style 229**	Double-spoke style 222**
Wheel size	Front / rear	6.5 J x 16 (116i/118i/118d) 7 J x 16 (120i/120d)	6.5 J x 16 (116i/118i/118d) 7 J x 16 (120i/120d)	7 J x 16
Tyre size	Front / rear	195/55 R16 (116i/118i/118d) 205/55 R16 (120i/120d)	195/55 R16 (116i/118i/118d) 205/55 R16 (120i/120d)	205/55 R16
	Option code	n/a	2KH	2BT
				
116i/d		●	£440	£510
ES models		-	●	£75
SE models		-	£0	●
123d SE		-	-	-

		V-spoke style 255**	V-spoke style 141	Star-spoke style 256
Wheel size	Front / rear	7 J x 16	7 J x 17	7 J x 17
Tyre size	Front / rear	205/55 R16	205/50 R17	205/50 R17
	Option code	2KN	2KC	2R2
				
116i/d		£510	£815	£815
ES models		£75	£385	£385
SE models		£0	£315	£315
123d SE		-	●	£0

Key

● = Standard £ = Optional - = Not available

** = Standard tyres are not run-flat tyres. Mobility tyre sealing system provided as standard. Run-flat tyres available as an option.

		Star-spoke style 142*	V-spoke style 217*
Wheel size	Front / rear	7 J x 17 / 7.5 J x 17	7.5 J x 18 / 8 J x 18
Tyre size	Front / rear	205/50 R17 / 225/45 R17	205/45 R18 / 225/40 R18
	Option code	2CH	2KF
			
116i/d		£915	£1,285
ES models		£475	£845
SE models		£405	£780
123d SE		£100	£470

		Double-spoke style 207M*	Double-spoke style 208M*
Wheel size	Front / rear	7 J x 17 / 7.5 J x 17	7.5 J x 18 / 8 J x 18
Tyre size	Front / rear	205/50 R17 / 225/45 R17	205/45 R18 / 225/40 R18
	Option code	2MG	2MH
			
M Sport models		●	£415
130i M Sport		£0	●

Key ● = Standard £ = Optional -- = Not available
* = Snow chains cannot be fitted to this wheel

	116i	116i ES	116i SE	116i M Sport	118i ES	118i SE	118i M Sport	120i SE	120i M Sport	130i M Sport	116d	116d ES	116d SE	116d M Sport	118d ES	118d SE	118d M Sport	120d SE	120d M Sport	123d SE	123d M Sport	Price
BMW EfficientDynamics																						
Active Aerodynamics	●	●	●	-	●	●	-	●	-	-	-	-	-	-	-	-	-	-	-	-	-	std
Auto Start-Stop	●	●	●	●	●	●	●	●	●	-	●	●	●	●	●	●	●	●	●	●	●	std
Brake Energy Regeneration	●	●	●	●	●	●	●	●	●	●	●	●	●	●	●	●	●	●	●	●	●	std
Electric Power Steering	●	●	●	●	●	●	●	●	●	●	●	●	●	●	●	●	●	●	●	●	●	std
High-precision direct injection	●	●	●	●	●	●	●	●	●	-	-	-	-	-	-	-	-	-	-	-	-	std
Optimum Shift Indicator	●	●	●	●	●	●	●	●	●	●	●	●	●	●	●	●	●	●	●	●	●	std

BMW EfficientDynamics

Active Aerodynamics	●	●	●	-	●	●	-	●	-	-	-	-	-	-	-	-	-	-	-	-	-	std
Auto Start-Stop	●	●	●	●	●	●	●	●	●	-	●	●	●	●	●	●	●	●	●	●	●	std
Brake Energy Regeneration	●	●	●	●	●	●	●	●	●	●	●	●	●	●	●	●	●	●	●	●	●	std
Electric Power Steering	●	●	●	●	●	●	●	●	●	●	●	●	●	●	●	●	●	●	●	●	●	std
High-precision direct injection	●	●	●	●	●	●	●	●	●	-	-	-	-	-	-	-	-	-	-	-	-	std
Optimum Shift Indicator	●	●	●	●	●	●	●	●	●	●	●	●	●	●	●	●	●	●	●	●	●	std

Certain BMW EfficientDynamics features may be excluded depending on the optional equipment chosen. Your BMW Dealer will be pleased to provide you with more information.

Transmission

Automatic transmission	205	○	○	○	○	○	○	○	○	○	-	-	-	-	○	○	○	○	○	○	○	£1,430
Six-speed automatic transmission with Steptronic sequential manual mode. Includes shift/interlock and adaptive transmission control (AGS). 130i and 123d models come with steering wheel mounted gear-shift paddles and sporting gearchange characteristics.											○											£1,510

Wheels and chassis

Active Steering	217	-	-	-	-	-	-	-	-	-	○	-	-	-	-	-	-	-	○	○	○	○	£905
Actively assisted steering system that reduces the number of turns lock to lock at slower speeds assisting parking and turning in cities. Inversely at higher speeds the ratio varies to ensure greater stability and optimum dynamics. Only with 530 / 534.																							
M Sport suspension	704	○	○	○	●	○	○	●	○	●	○	○	○	○	○	○	○	○	○	○	○	○	£230
Factory fitted M Sport suspension providing firmer, more sporting ride and reducing ride height by 15 mm. Standard in Dynamic package.																							
Servotronic	216	○	○	○	○	○	○	○	○	○	○	○	○	○	○	○	○	○	○	○	○	○	£170
Varies the level of assistance according to the vehicle speed. At low speeds, steering will be light due to a high level of power assistance. As speeds increase, there will be less level of assistance to help the driver hold the correct line.																							

Key Only with – these options must be ordered together / = Indicates 'or'

● = Standard ○ = Optional -- = Not available

		116i	116i ES	116i SE	116i M Sport	118i ES	118i SE	118i M Sport	120i SE	120i M Sport	130i M Sport	116d	116d ES	116d SE	116d M Sport	118d ES	118d SE	118d M Sport	120d SE	120d M Sport	123d SE	123d M Sport	Price
Safety and technology																							
Adaptive Headlights	524	○	○	○	○	○	○	○	○	○	○	○	○	○	○	○	○	○	○	○	○	○	£280
Headlights that move to follow the road via steering wheel input. Only with 521 and 522.																							
Cruise control	540	○	○	○	○	○	○	○	○	○	○	○	○	○	○	○	○	○	○	○	○	○	£180
Cruise control operated via a stalk on the steering column.																							
Foglights, front	520	○	○	●	●	○	●	●	●	●	○	○	○	○	○	○	○	○	○	○	○	○	£140
Integrated into lower front valance, includes heated exterior mirrors and heated washer jets. Standard in Dynamic package.																							
Headlight wash	502	○	○	○	○	○	○	○	○	○	○	○	○	○	○	○	○	○	○	○	○	○	£205
High pressure system for cleaning headlights. Includes fixed jets and caps in body colour.																							
High-beam Assistant	5AC	○	○	○	○	○	○	○	○	○	○	○	○	○	○	○	○	○	○	○	○	○	£105
Automatically switches between low and high beam when there is oncoming traffic/changing light conditions. Only available in combination with 430 / 431 and 521 and 522.																							
Park Distance Control (PDC), front and rear	508	○	○	○	○	○	○	○	○	○	○	○	○	○	○	○	○	○	○	○	○	○	£570
Audio warning signal of proximity of objects to the front and rear of the car. Includes rubbing strips in body colour. Signal is audio only, except when ordered in conjunction with 606 / 609 when it includes a visual display of car on monitor screen. Manual or automatic deactivation possible except when in conjunction with 235, towbar with removable ball head where system is deactivated automatically when towbar is installed. Standard in Comfort package.																							
Park Distance Control (PDC), rear	507	○	○	●	●	○	●	●	●	●	○	○	○	○	○	○	○	○	○	○	○	○	£315
Audio warning signal of proximity of objects to the rear of the car. Includes rubbing strips in body colour. Signal is audio only, except when ordered in conjunction with 606 / 609 when it includes a visual display of car on monitor screen. Manual or automatic deactivation possible except when in conjunction with 235, towbar with removable ball head, where system is deactivated automatically when towbar is installed.																							

Key Only with – these options must be ordered together
/ = Indicates 'or'

● = Standard ○ = Optional

		116i	116i ES	116i SE	116i M Sport	118i ES	118i SE	118i M Sport	120i SE	120i M Sport	130i M Sport	116d	116d ES	116d SE	116d M Sport	118d ES	118d SE	118d M Sport	120d SE	120d M Sport	123d SE	123d M Sport	Price
Safety and technology (cont.)																							
Rain sensor with automatic headlight activation	521	○	○	○	○	○	○	○	○	○	○	○	○	○	○	○	○	○	○	○	○	○	£90
Automatic intermittent activation of windscreen wipers and headlights. Standard in Comfort package.																							
Run-flat tyres	258	○	○	○	●	○	○	●	○	●	○	○	○	○	○	○	○	○	○	○	○	○	£175
Tyres with reinforced side walls which allow the vehicle to continue driving safely after a complete loss of driving pressure, for up to 150 miles.																							
Xenon headlights	522	○	○	○	○	○	○	○	○	○	○	○	○	○	○	○	○	○	○	○	○	○	£620
Xenon headlights for dimmed and main beam. Includes headlight surround rings ('Corona rings'). Xenon headlights include LED rear lights within cost of option. Includes 502.																							
Seats																							
Fifth seat deletion*	4UK	○	○	○	○	○	○	○	○	○	○	○	○	○	○	○	○	○	○	○	○	○	£0
Four-seat configuration can be specified. The rear middle seat will be replaced with a storage tray.																							
Lumbar support, driver and front passenger	488	○	○	○	○	○	○	○	○	○	○	○	○	○	○	○	○	○	○	○	○	○	£195
Electrically adjustable lumbar support for driver and front passenger.																							
Seat adjustment – front, electric with driver memory	459	○	○	○	○	○	○	○	○	○	○	○	○	○	○	○	○	○	○	○	○	○	£870
Electric adjustment for both front seats (standard and sport seats). Memory function provides two memory positions. Head restraint height and thigh support (on sport seats) remain manually adjustable. Includes automatic dipping exterior mirror when reverse gear is selected.																							
Seat heating, front	494	○	○	○	○	○	○	○	○	○	○	○	○	○	○	○	○	○	○	○	○	○	£245
Seat heating for driver and front passenger.																							
Sport seats, front	481	○	○	○	●	○	○	●	○	●	○	○	○	○	○	○	○	○	○	○	○	○	£385
Sport seats for driver and front passenger. Not available in Electra cloth upholstery. Includes manual adjustment for length, height, tilt and thigh support. Electric adjustment for side bolsters. Standard in Dynamic package.																							

Key ● = Standard ○ = Optional
* = Only available on 3-door models

		116i	116i ES	116i SE	116i M Sport	118i ES	118i SE	118i M Sport	120i SE	120i M Sport	130i M Sport	116d	116d ES	116d SE	116d M Sport	118d ES	118d SE	118d M Sport	120d SE	120d M Sport	123d SE	123d M Sport	Price
Exterior equipment																							
Comfort Access	322	○	○	○	○	○	○	○	○	○	○	○	○	○	○	○	○	○	○	○	○	○	£415
Keyless entry to the car and keyless start.																							
Exterior mirrors, folding	313	○	○	○	○	○	○	○	○	○	○	○	○	○	○	○	○	○	○	○	○	○	£165
Electrically foldable exterior mirrors. Includes heating for mirrors and windscreen washer jets. Mirror memory and automatic dipping facility on passenger side when reverse gear is selected. Not with 430.																							
Exterior trim, Chromeline*	346	○	○	○	○	○	○	○	○	○	○	○	○	○	○	○	○	○	○	○	○	○	£120
Decorative moulding side frame in chrome, window recess in chrome and door sill finishers, chrome plated.																							
Exterior trim, High-gloss Shadowline*	760	○	○	○	●	○	○	●	○	●	○	○	○	○	○	○	○	○	○	○	○	○	£175
High-gloss black finishers around windows, mirror bases and bonnet washer jet nozzles.																							
Exterior trim, High-gloss Shadowline**	339	○	○	○	●	○	○	●	○	●	○	○	○	○	○	○	○	○	○	○	○	○	£115
Exterior window trim strips and mirror bases finished in high-gloss black instead of matt black.																							
Model designation deletion	320	○	○	○	○	○	○	○	○	○	○	○	○	○	○	○	○	○	○	○	○	○	£0
Removal of model badge on the boot lid.																							
Towbar, detachable	235	○	○	○	○	○	○	○	○	○	○	○	○	○	○	○	○	○	○	○	○	○	£545
Concealed towbar with removable head and bumper aperture cover. Includes anti-fishtailing logic for trailer. Towing capacity up to 1200kg. Includes 258 on 116i/d, 118i/d and 120i/d (excluding M Sport).																							

Interior equipment

Air conditioning, automatic with two-zone control	534	○	○	●	●	○	●	●	●	●	○	○	○	○	○	○	○	○	○	○	○	○	£1,040
Fully automatic air conditioning. Includes temperature controls for left and right hand side of car, auto air-recirculation, temperature and fan controls with Personal Profile functionality, active carbon filter, humidity sensor, solar sensor and microfilter.																							
Air conditioning, manual	530	○	○	-	-	○	-	-	-	-	○	○	○	○	○	○	○	○	○	○	○	○	£660
Manually controlled air conditioning.																							
Armrest – front, centre	473	○	○	○	○	○	○	○	○	○	○	○	○	○	○	○	○	○	○	○	○	○	£110
Folding front armrest with integrated storage compartment. Standard in Comfort package.																							
In combination with 644.		○	○	○	○	○	○	○	○	○	○	○	○	○	○	○	○	○	○	○	○	○	£0

Key Not with – these options are not available for ordering together ● = Standard ○ = Optional – = Not available
 * = Only available on 3-door models
 ** = Only available on 5-door models

		116i	116i ES	116i SE	116i M Sport	118i ES	118i SE	118i M Sport	120i SE	120i M Sport	130i M Sport	116d	116d ES	116d SE	116d M Sport	118d ES	118d SE	118d M Sport	120d SE	120d M Sport	123d SE	123d M Sport	Price
Interior equipment (cont.)																							
Extended lighting	563	○	○	○	●	○	○	○	○	○	○	○	○	○	○	○	○	○	○	○	○	○	£175
Package contains the following options: – Front and rear interior reading lights – Front and rear soft-lights – Front foot well lighting – Puddle lights in exterior door handle – Sun visors with illuminated vanity mirrors for driver and passenger																							
Extended storage	493	○	○	○	○	○	○	○	○	○	○	○	○	○	○	○	○	○	○	○	○	○	£90
Package contains the following options: – 12 V socket in the luggage compartment – Nets on rear of driver's and front passenger's backrests – Two cup holders in centre console, with 606 / 609, one cup holder in centre console – Two lashing eyes – Two tensioning straps on the luggage compartment floor – Storage compartment in the instrument panel, not with 606 / 609																							
Exterior mirrors – folding, automatically dimming	430	○	○	○	○	○	○	○	○	○	○	○	○	○	○	○	○	○	○	○	○	○	£325
Folding heated exterior mirrors with mirror memory (via Personal Profile) and automatic dipping facility when reverse gear is selected. Also includes electro-chromatic interior and exterior mirrors and heated washer jets nozzles. Includes 431, Rear-view mirror, automatically dimming. Not with 313.																							
In combination with Comfort package.		○	○	○	○	○	○	○	○	○	○	○	○	○	○	○	○	○	○	○	○	○	£210
Glass sunroof	403	○	○	○	○	○	○	○	○	○	○	○	○	○	○	○	○	○	○	○	○	○	£660
Electric glass sunroof with full slide and tilt functions. Comfort opening and closing via remote key.																							
Headlining, Anthracite	775	○	○	○	○	○	○	○	○	○	○	○	○	○	○	○	○	○	○	○	○	○	£140
Headlining material in Anthracite colour.																							
Luggage compartment separating net	413	○	○	○	○	○	○	○	○	○	○	○	○	○	○	○	○	○	○	○	○	○	£85
With the rear seats folded flat, the partition net ensures that luggage remains in the load area even during sudden braking.																							
Rear-view mirror, automatically dimming	431	○	○	○	○	○	○	○	○	○	○	○	○	○	○	○	○	○	○	○	○	○	£115
Interior electro-chromatic auto dimming mirror. Included within 430 at no cost. Standard within Comfort package.																							

Key Not with – these options are not available for ordering together ● = Standard ○ = Optional
 / = Indicates 'or'

		116i	116i ES	116i SE	116i M Sport	118i ES	118i SE	118i M Sport	120i SE	120i M Sport	130i M Sport	116d	116d ES	116d SE	116d M Sport	118d ES	118d SE	118d M Sport	120d SE	120d M Sport	123d SE	123d M Sport	Price
Interior equipment (cont.)																							
Smoker's package deletion	441	○	○	○	○	○	○	○	○	○	○	○	○	○	○	○	○	○	○	○	○	○	£0
Deletion of lighter and ashtray in the front of centre console and two lighters in the rear.																							
Sun protection glass	420	○	○	○	○	○	○	○	○	○	○	○	○	○	○	○	○	○	○	○	○	○	£215
Dark tinted glass for rear side windows and rear windscreen.																							
Through-loading modular ski bag	468	○	○	○	○	○	○	○	○	○	○	○	○	○	○	○	○	○	○	○	○	○	£120
Through load including removable ski sack and cover in rear seat.																							
Windscreen with grey shade band	3AP	○	○	○	○	○	○	○	○	○	○	○	○	○	○	○	○	○	○	○	○	○	£55
Graduated grey strip across the top of the windscreen.																							
Steering wheels																							
Multi-function controls for steering wheel	249	○	○	●	●	○	●	●	●	●	○	○	○	○	○	○	○	○	○	○	○	○	£110
Multi-function controls for radio (volume, station search), telephone (if 633 / 644 is specified) and two individual programmable keys when ordered with options 606 / 609. If ordered without, keys are for audio source and air-recirculation. Only with 255.																							
Sport leather steering wheel, three-spoke	255	○	○	●	-	○	●	-	●	-	-	○	○	○	○	○	○	○	○	○	○	○	£195
Sport leather steering wheel, three-spoke. Includes handbrake and gear lever gaiter in leather when ordered with Boston leather upholstery, or in artificial leather if ordered without Boston leather upholstery. Standard in Dynamic package.																							
Steering wheel heating	248	○	○	○	-	○	○	-	○	-	-	○	○	○	○	○	○	○	○	○	○	○	£125
Thermostatically-controlled steering wheel rim heating – activated via a switch on the multi-function steering wheel. Only with 249.																							
Audio and communication																							
Bluetooth telephone audio connection	6NF	○	○	○	○	○	○	○	○	○	○	○	○	○	○	○	○	○	○	○	○	○	£70
Additional connection point for the playback of music from a mobile phone with a built in music player. Please consult your BMW Dealer for details of compatible handsets and the availability of a cradle that will need to be purchased separately.																							

Key Only with – these options must be ordered together ● = Standard ○ = Optional – = Not available

		116i	116i ES	116i SE	116i M Sport	118i ES	118i SE	118i M Sport	120i SE	120i M Sport	130i M Sport	116d	116d ES	116d SE	116d M Sport	118d ES	118d SE	118d M Sport	120d SE	120d M Sport	123d SE	123d M Sport	Price
Audio and communication (cont.)																							
Bluetooth telephone preparation	644	○	○	○	○	○	○	○	○	○	○	○	○	○	○	○	○	○	○	○	○	○	£525
Preparation for a mobile telephone with Bluetooth interface. Includes Voice Control of telephone when ordered in conjunction with 249, Multi-function controls for steering wheel. Please note that this option does not include a handset or an optional phone cradle – these must be purchased separately. It is not possible to view SMS via the vehicle display. Option 473, Armrest – front, centre, is included at no cost where not standard. Only with 663. Not with 606 / 609.																							
Bluetooth telephone preparation with telematics	633	-	-	○	○	-	○	○	○	○	○	-	-	○	○	-	○	○	○	○	○	○	£525
Preparation for a mobile phone with bluetooth interface, with the addition of a pre-fitted telematic SIM card for the use of BMW ConnectedDrive services. When ordered in conjunction with Navigation system 606 / 609, BMW ConnectedDrive – Assist and BMW ConnectedDrive – Online are included. Only with 612, 616 and 606 / 609.																							
BMW ConnectedDrive – Assist	612	-	-	○	○	-	○	○	○	○	○	-	-	○	○	-	○	○	○	○	○	○	£0
Telematics services with automatic and manual 999 emergency SOS call, BMW Breakdown Service, My Info with Google send to car function and Information Plus (location- based operator service). Includes subscription to services for three years (customer registration required to activate services). Automatically included with a Navigation system – 606 / 609, 616 BMW ConnectedDrive – Online and 633 Bluetooth telephone preparation with telematics. Only with 606 / 609 and 616 and 633.																							
BMW ConnectedDrive – Online	616	-	-	○	○	-	○	○	○	○	○	-	-	○	○	-	○	○	○	○	○	○	£0
WAP-based vehicle browser with access to the BMW Online portal. Services include news, with the ability to set up RSS news feeds, weather and the Google local search, a business listing search facility. Includes subscription to the services for three years (customer registration required to activate services). Please note function disabled when vehicle is in motion. Automatically included with a Navigation system – 606 / 609, 612 BMW ConnectedDrive – Assist and 633 Bluetooth telephone preparation with telematics. Only with 606 / 609 and 612 and 633.																							

Key Only with – these options must be ordered together Not with – these options are not available for ordering together / = Indicates 'or' ○ = Optional – = Not available

		116i	116i ES	116i SE	116i M Sport	118i ES	118i SE	118i M Sport	120i SE	120i M Sport	130i M Sport	116d	116d ES	116d SE	116d M Sport	118d ES	118d SE	118d M Sport	120d SE	120d M Sport	123d SE	123d M Sport	Price
Audio and communication (cont.)																							
BMW Professional radio with single CD player (with MP3 playback capability)	663	○	○	○	○	○	○	○	○	○	○	○	○	○	○	○	○	○	○	○	○	○	£140
Single tuner radio system with RDS, single CD player, two display lines for telephone number information (where 644 / 663 is specified) and other information such as track title. Two display lines also add additional MID functionality. MP3/WMA playback capability. Includes two-way loudspeaker system with: – Two broadband speakers in front door – Two broadband speakers in rear parcel shelf – Two central bass speakers underneath seats – Output six x 25 watt Not with 606 / 609 / 662.																							
CD changer	672	○	○	○	○	○	○	○	○	○	○	○	○	○	○	○	○	○	○	○	○	○	£290
Six CD changer located in the boot. MP3/WMA playback capability. Only with 606 / 609 / 663. Not with 694.																							
CD changer preparation	694	○	○	○	○	○	○	○	○	○	○	○	○	○	○	○	○	○	○	○	○	○	£35
Preparation for six CD player to be fitted in the boot of the vehicle. Only with 606 / 609 / 663. Not with 672.																							
Loudspeaker system – BMW Business	676	○	○	○	○	○	○	○	○	○	○	○	○	○	○	○	○	○	○	○	○	○	£360
Three way loudspeaker system with ten speakers as follows: – Four mid-range speakers (two in the front doors and two in the rear parcel shelf – four x 25 watt output) – Four tweeters (two in the front doors and two in the rear parcel shelf – four x 25 watt output) – Two woofers located underneath the front seats (two x 40 watt output)																							

Key

○ = Optional
 Only with – these options must be ordered together
 Not with – these options are not available for ordering together
 / = Indicates 'or'

		116i	116i ES	116i SE	116i M Sport	118i ES	118i SE	118i M Sport	120i SE	120i M Sport	130i M Sport	116d	116d ES	116d SE	116d M Sport	118d ES	118d SE	118d M Sport	120d SE	120d M Sport	123d SE	123d M Sport	Price
Audio and communication (cont.)																							
Loudspeaker system – LOGIC7 Professional	677	○	○	○	○	○	○	○	○	○	○	○	○	○	○	○	○	○	○	○	○	○	£695
BMW high end loudspeaker system with ten speakers as follows: – Four mid-range speakers (two in the front doors and two in the rear parcel shelf – four x 40 watt output) – Four tweeters (two in the front doors and two in the rear parcel shelf – four x 40 watt output) – Two woofers located underneath the front seats (two x 70 watt output) Surround sound function with Equalizer also included. Only with 606 / 609 / 663. Not with 662 / 676.																							
Navigation system – BMW Business	606	–	–	○	○	–	○	○	○	○	○	–	–	○	○	–	○	○	○	○	○	○	£1,430
Fixed binnacle housing a 6.5" colour monitor, map and arrow display, dynamic route planning. No changes to the Navigation system (or other) software is included. Features: – New iDrive Controller with intuitive operation and shortcut buttons – FM/AM RDS twin tuner with TMC (Traffic Message Channel) – Title search – Forward and reverse – Scan, random – Operating knob with decorative ring in matt chrome, – Favourite buttons (eight programmable buttons for iDrive functions) – Cup holder (one in centre console) Extended Personal Profile functions can be set by means of iDrive, including On-Board Computer with extended functions. Note when 606 is ordered only one CD/DVD drive is available. It is recommended that 672 CD changer is ordered in conjunction with 606 in order to overcome the potential issue of reloading the Navigation DVD. If a telephone preparation system is also required, please specify 633 Bluetooth telephone preparation with telematics and 612 BMW ConnectedDrive – Assist. Includes 249 and 473. Only with 255 and 534. Not with 609 / 644 / 662 / 663.																							

Key

○ = Optional – = Not available
 Only with – these options must be ordered together
 Not with – these options are not available for ordering together
 / = Indicates 'or'

		116i	116i ES	116i SE	116i M Sport	118i ES	118i SE	118i M Sport	120i SE	120i M Sport	130i M Sport	116d	116d ES	116d SE	116d M Sport	118d ES	118d SE	118d M Sport	120d SE	120d M Sport	123d SE	123d M Sport	Price
Audio and communication (cont.)																							
Navigation system – BMW Professional Multimedia	609	-	-	○	○	-	○	○	○	○	○	-	-	○	○	-	○	○	○	○	○	○	£1,930
– New iDrive Controller with intuitive operation and shortcut buttons – High resolution Control Display with 8.8" colour flat screen (LCD), divided into main window and assistant window – Built in 80GB hard-drive for improved speed of operation and data storage – Detailed navigation map and options to enhance route planning – Multimedia capability with 12GB storage for audio files – DVD playback functionality – Favorite buttons (eight programmable buttons for iDrive functions) – Cup holder (one in centre console) Note – if a telephone system is also required, please specify 633 Bluetooth telephone preparation with telematics, 612 BMW ConnectedDrive – Assist and 616 BMW ConnectedDrive – Online. Only with 255 and 534. Not with 606 / 644 / 662 / 663.																							
USB audio interface	6FL	○	○	○	○	○	○	○	○	○	○	○	○	○	○	○	○	○	○	○	○	○	£200
Preparation for USB storage devices to be connected. Storage pouch and connector USB cable for MP3 player/ USB storage device located under front centre armrest (where specified). Only with 606 / 609 / 663.																							
Voice Control	620	-	-	○	○	-	○	○	○	○	○	-	-	○	○	-	○	○	○	○	○	○	£315
Voice Control system for the following functions: Entertainment (radio station, radio source, track selection), Air conditioning settings, navigation displays, telephone (where specified). Please note, you need to add no-cost option Z4F in order to make 620 free of charge. Only with 606 / 609.																							
In combination with 633 / 644.		-	-	○	○	-	○	○	○	○	○	-	-	○	○	-	○	○	○	○	○	○	£0

Key

Only with – these options must be ordered together
 Not with – these options are not available for ordering together
 / = Indicates 'or'

○ = Optional – = Not available

		116i	116i ES	116i SE	116i M Sport	118i ES	118i SE	118i M Sport	120i SE	120i M Sport	130i M Sport	116d	116d ES	116d SE	116d M Sport	118d ES	118d SE	118d M Sport	120d SE	120d M Sport	123d SE	123d M Sport	Price
Paintwork, upholstery and trims																							
Non-metallic paintwork	uni	●	●	●	●	●	●	●	●	●	●	●	●	●	●	●	●	●	●	●	●	●	std
Metallic paintwork	met	○	○	○	○	○	○	○	○	○	○	○	○	○	○	○	○	○	○	○	○	○	£485
Electra cloth upholstery	EA	●	●	●	-	●	●	-	●	-	-	●	●	●	-	●	●	-	●	-	-	-	std
Cloth upholstery on standard seats. Not with 481.																							
Flashpoint cloth / Sensatec upholstery	GC	-	-	-	●	-	-	●	-	●	●	-	-	-	●	-	-	●	-	●	-	●	std
Flashpoint cloth and Sensatec upholstery. Standard on M Sport models. Seat base and back in Flashpoint cloth. Side support on back and base in Sensatec material.																							
Network cloth upholstery	AU	○	○	○	-	○	○	-	○	-	-	○	○	○	-	○	○	-	○	-	●	-	£100
Seat base, back and side supports in Network cloth. Standard in Dynamics package.																							
Pearlpoint cloth / leather upholstery	FH	○	○	○	-	○	○	-	○	-	-	○	○	○	-	○	○	-	○	-	○	-	£360
Pearlpoint cloth upholstery on the centre section of the seat with Oregon leather on the side bolsters. Only with 481.																							
In combination with Dynamic package.		○	○	○	-	○	○	-	○	-	-	○	○	○	-	○	○	-	○	-	○	-	£265
Boston leather upholstery	LW	○	○	○	○	○	○	○	○	○	○	○	○	○	○	○	○	○	○	○	○	○	£1,065
Leather upholstery. Only with 255.																							
In combination with Dynamic package.		○	○	○	-	○	○	-	○	-	-	○	○	○	-	○	○	-	○	-	○	-	£970
Interior trim, Silver	4AK	●	●	●	-	●	●	-	-	-	-	●	●	●	-	●	●	-	-	-	-	-	std
Interior trim finish in Silver. Includes door handles, centre console and instrument panel in Silver. Door release handle, Start-Stop button surround, instrument binnacle rings and air vents adjusters in matt chrome.																							
Interior trim, Satin Silver	4CG	○	○	○	-	○	○	-	●	-	-	○	○	○	-	○	○	-	●	-	●	-	£50
Interior trim finish in Satin Silver. Includes door handles, centre console and instrument panel in Satin Silver. Door release handle, Start-Stop button surround, instrument binnacle rings and air vents adjusters in matt chrome.																							

Key

Only with – these options must be ordered together
 Not with – these options are not available for ordering together

● = Standard ○ = Optional – = Not available

		116i	116i ES	116i SE	116i M Sport	118i ES	118i SE	118i M Sport	120i SE	120i M Sport	130i M Sport	116d	116d ES	116d SE	116d M Sport	118d ES	118d SE	118d M Sport	120d SE	120d M Sport	123d SE	123d M Sport	Price
Paintwork, upholstery and trims (cont.)																							
Interior trim, Aluminium Glacier Silver	4MG	-	-	-	●	-	-	●	-	●	●	-	-	-	●	-	-	●	-	●	-	●	std
Interior trim finish in Aluminium Glacier Silver. Includes door handles, centre console and instrument panel in Aluminium Glacier Silver. Door release handle, Start-Stop button surround, instrument binnacle rings and air vents adjusters in matt chrome.																							
Interior trim, Black, high-gloss	4AT	○	○	○	-	○	○	-	-	-	○	○	○	-	○	○	-	-	-	-	-	-	£50
Interior trim finish in Black. Includes door handles, centre console and instrument panel in Black. Door release handle, Start-Stop button surround, instrument binnacle rings and air vents adjusters in matt chrome.																							
Interior trim, Cashmere Silver	4B1	○	○	○	-	○	○	-	-	-	○	○	○	-	○	○	-	-	-	-	-	-	£50
Interior trim finish in Cashmere Silver. Includes door handles, centre console and instrument panel in Cashmere Silver. Door release handle, Start-Stop button surround, instrument binnacle rings and air vents adjusters in matt chrome.																							
Interior trim, Brushed Aluminium with accent line	4B3	○	○	○	○	○	○	○	○	○	○	○	○	○	○	○	○	○	○	○	○	○	£210
Interior trim finish in Brushed Aluminium. Includes door handles, centre console and instrument panel in Brushed Aluminium. Door release handle, Start-Stop button surround, instrument binnacle rings and air vents adjusters in matt chrome.																							
Interior trim, Dark Grey Poplar wood	4AS	○	○	○	○	○	○	○	○	○	○	○	○	○	○	○	○	○	○	○	○	○	£280
Interior trim finish in Dark Grey Poplar wood. Includes door handles, centre console and instrument panel in Dark Grey Poplar wood. Door release handle, Start-Stop button surround, instrument binnacle rings and air vents adjusters in matt chrome.																							
Interior trim, Light Burr Walnut wood	4A3	○	○	○	○	○	○	○	○	○	○	○	○	○	○	○	○	○	○	○	○	○	£280
Interior trim finish in Light Burr Walnut wood. Includes door handles, centre console and instrument panel in Light Burr Walnut wood. Door release handle, Start-Stop button surround, instrument binnacle rings and air vents adjusters in matt chrome.																							

Key ● = Standard ○ = Optional - = Not available

		116i	116i ES	116i SE	116i M Sport	118i ES	118i SE	118i M Sport	120i SE	120i M Sport	130i M Sport	116d	116d ES	116d SE	116d M Sport	118d ES	118d SE	118d M Sport	120d SE	120d M Sport	123d SE	123d M Sport	Price
Packages																							
Comfort package	Z8M	○	○	○	○	○	○	○	○	○	-	○	○	○	○	○	○	○	○	○	○	○	£825
Package contains the following options: - 431, Rear-view mirror, automatically dimming - 473, Armrest – front, centre - 493, Extended storage - 508, Park Distance Control (PDC), front and rear - 521, Rain sensor with automatic headlight activation																							
Dynamic package	Z8E	○	○	-	○	-	-	-	-	○	○	○	○	○	○	-	-	-	-	-	-	-	£1,295
Package contains the following options: - AUAT/AUF8/AUD9, Network cloth upholstery - 2R2, 17" light alloy wheel Star-spoke style 256 - 255, Sport leather steering wheel, three spoke - 481, Sport seats - 520, Foglights, front - 704, M Sport suspension																							

Key ○ = Optional - = Not available



116i	116i ES	116i SE	116i M Sport	118i ES	118i SE	118i M Sport	120i SE	120i M Sport	130i M Sport	116d	116d ES	116d SE	116d M Sport	118d ES	118d SE	118d M Sport	120d SE	120d M Sport	123d SE	123d M Sport	Price
------	---------	---------	--------------	---------	---------	--------------	---------	--------------	--------------	------	---------	---------	--------------	---------	---------	--------------	---------	--------------	---------	--------------	-------

Options available from your dealer

BMW Service Inclusive	Covers the cost of labour and parts for all routine servicing for 5 years or 60,000 miles, whichever comes first. Cover includes: brake fluid, air filters, micro filters, fuel filter (diesel models only), spark plugs, oil filters, engine oil. Transferable to subsequent owners.																				
5 years / 60,000 miles	<input type="checkbox"/>	<input type="checkbox"/>	<input type="checkbox"/>	<input type="checkbox"/>	<input type="checkbox"/>	<input type="checkbox"/>	<input type="checkbox"/>	<input type="checkbox"/>	<input type="checkbox"/>	<input type="checkbox"/>	<input type="checkbox"/>	<input type="checkbox"/>	<input type="checkbox"/>	<input type="checkbox"/>	<input type="checkbox"/>	<input type="checkbox"/>	<input type="checkbox"/>	<input type="checkbox"/>	<input type="checkbox"/>	<input type="checkbox"/>	£660
									<input type="checkbox"/>	<input type="checkbox"/>			<input type="checkbox"/>								£790
BMW Service Inclusive Plus	Covers the cost of labour, parts and lubricants for all routine servicing and maintenance for 5 years or 60,000 miles, whichever comes first. Cover includes: brake pads, brake discs, brake sensors, brake fluid, air filters, micro filters, fuel filter (diesel models only), spark plugs, oil filters, engine oil, clutch assembly (only if worn) and wiper blade rubbers. Transferable to subsequent owners.																				
5 years / 60,000 miles	<input type="checkbox"/>	<input type="checkbox"/>	<input type="checkbox"/>	<input type="checkbox"/>	<input type="checkbox"/>	<input type="checkbox"/>	<input type="checkbox"/>	<input type="checkbox"/>	<input type="checkbox"/>	<input type="checkbox"/>	<input type="checkbox"/>	<input type="checkbox"/>	<input type="checkbox"/>	<input type="checkbox"/>	<input type="checkbox"/>	<input type="checkbox"/>	<input type="checkbox"/>	<input type="checkbox"/>	<input type="checkbox"/>	<input type="checkbox"/>	£1,575
									<input type="checkbox"/>	<input type="checkbox"/>			<input type="checkbox"/>								£1,845
BMW Trackstar	<input type="checkbox"/>	<input type="checkbox"/>	<input type="checkbox"/>	<input type="checkbox"/>	<input type="checkbox"/>	<input type="checkbox"/>	<input type="checkbox"/>	<input type="checkbox"/>	<input type="checkbox"/>	<input type="checkbox"/>	<input type="checkbox"/>	<input type="checkbox"/>	<input type="checkbox"/>	<input type="checkbox"/>	<input type="checkbox"/>	<input type="checkbox"/>	<input type="checkbox"/>	<input type="checkbox"/>	<input type="checkbox"/>	<input type="checkbox"/>	£214.34*
24-hour vehicle tracking device utilising GSM, GPS technology and a vehicle movement sensor. (Meets Thatcham Quality Accreditation – TQA.)																					
BMW Trackstar 5	<input type="checkbox"/>	<input type="checkbox"/>	<input type="checkbox"/>	<input type="checkbox"/>	<input type="checkbox"/>	<input type="checkbox"/>	<input type="checkbox"/>	<input type="checkbox"/>	<input type="checkbox"/>	<input type="checkbox"/>	<input type="checkbox"/>	<input type="checkbox"/>	<input type="checkbox"/>	<input type="checkbox"/>	<input type="checkbox"/>	<input type="checkbox"/>	<input type="checkbox"/>	<input type="checkbox"/>	<input type="checkbox"/>	<input type="checkbox"/>	£439.45*
24-hour vehicle tracking device utilising GSM, GPS technology, a vehicle movement sensor and a driver authentication device. (Meets Thatcham Category 5 Accreditation – Cat 5.)																					

Key

- / = Indicates 'or'
- = Optional
- * = Prices exclude fitment or subscription. Please consult your BMW Dealer for further details.

Services and Benefits.

Warranties

Every BMW registered is protected by a Dealer Warranty, which provides cover for 3 years' unlimited mileage. In addition, every BMW is covered by an unlimited mileage, twelve years' anti-corrosion warranty and three years' paintwork warranty.

Full details of these warranties are available from your BMW Dealer and are provided in the BMW Warranty and Emergency Service Handbook.

BMW Emergency Service

BMW Emergency Service is the only roadside and assistance programme designed specifically for BMW vehicles offering an exceptional range of benefits and services. It is available 24 hours a day, 7 days a week and utilises a dedicated fleet of BMW Approved Technicians, equipped with Genuine BMW Parts and tools, ensuring that you and your vehicle receive the best possible care in the event of any motoring emergency. This tailor-made programme has been specifically designed to meet the needs of BMW drivers travelling in the UK and Continental Europe giving complete reassurance and peace of mind. Every new BMW is covered for three years.



BMW Magazine

Every new BMW customer receives a complimentary subscription to BMW Magazine. This lifestyle publication features all the latest news and developments from BMW, including interesting interviews, sporting news, travel experiences and art stories.

Finance and Insurance from BMW.

BMW Financial Services

Chances are, you've already decided on the BMW you want to drive. Now discover the perfect finance solution to get you behind the wheel. BMW Financial Services offers a range of tailor-made finance packages to suit you and your budget.

And to help you, at every BMW Dealership, there's a Financial Services Specialist – a dedicated expert who'll find the perfect solution for you. They'll talk you through the options and help you come to the right decision.

Our comprehensive range of finance and insurance products include:

- **BMW Select (Personal Contract Purchase)**
- **BMW Hire Purchase**
- **BMW Contract Hire**
- **BMW Car Insurance**
- **BMW Home Insurance**
- **BMW Travel Insurance**

For details of your local BMW Dealer, please call 0800 325600. Further information on our finance products can be found at www.bmw.co.uk

Finance is subject to status and available to over 18's in the UK only (excludes the Channel Islands). Guarantees and indemnities may be required. Finance is provided by BMW Financial Services, Europa House, Bartley Way, Hook, Hampshire, RG27 9UF.

BMW Car Insurance

Driving a BMW shows that you refuse to compromise on the quality of your car so why should your car insurance be any different? Designed for you, BMW Car Insurance offers cover that can help give you peace of mind.

Call BMW Car Insurance today on 0870 0240 520.

Lines open 8am – 8pm Monday to Friday, 9am – 5pm Saturdays. Max call charge from a BT landline is 8p a minute. Calls from other networks may vary.

BMW Car Insurance is underwritten by UK Insurance Limited. The Wharf, Neville Street, Leeds, LS1 4AZ, which is authorised and regulated by The Financial Services Authority.

BMW ConnectedDrive.

BMW ConnectedDrive provides telematic and online services that are fully integrated with your navigation and Bluetooth telephone system. The services provide you and your passengers access to key information from within the vehicle, helping you keep safe and in touch.



Emergency 999 SOS call

The emergency SOS call provides a direct link to a 999 emergency call centre. This call can either be activated manually, or in extreme situations the sensors in the vehicle will automatically make the call and transmit your location to the emergency services. In either instance you can be assured that help can be despatched without delay.

Breakdown call

Roadside breakdown assistance is never far away because with BMW ConnectedDrive your vehicle will have a direct link to the BMW Service Centre. This link automatically provides the operator with your vehicle details and position so that a BMW Approved Technician can be despatched quickly and easily.

Information Plus

At the push of a button local information is available wherever you may be in the country, using the Information Plus service. The service is available 24 hours a day, seven days a week and connects you to an operator who will be able to quickly access the information you need. You can request places of interest, from hotels and restaurants to museums or historical attractions. The information is then sent to your car and can then be used in your navigation system to plan a route to your destination, or to make a call on your Bluetooth telephone.

My Info

As a BMW ConnectedDrive customer you will be able to access an internet website from where you, or others, can send information to your vehicle. Multiple addresses and telephone numbers can be sent to your vehicle, they can then be transferred into your navigation system or your Bluetooth telephone. Using the My Info service you can also send residential addresses or business listings via Google Maps. When you have found a place of interest or entered the address in the map, there is a send-to-car function on the website, this will send the address and telephone number to your vehicle.

Remote Services

Remote Services provides you with the facility to contact the BMW Service Centre, who can remotely lock or unlock your vehicle. You will be required to activate your vehicle and set-up your own personal security questions within the ConnectedDrive website. After you have set-up the service, should you be in a situation where you have accidentally locked your keys in the car, the BMW Service Centre will be able to unlock your vehicle. Likewise, if you are not near your car and you cannot remember if you have locked the car, our call centre can remotely lock the vehicle for you.

Extended News and Weather

BMW ConnectedDrive provides you with access to a WAP-based browser which connects to the BMW Online portal. The portal displays the latest Weather forecast and Extended News stories from categories such as World, Business and Sports News.

My News

From your BMW Online portal, My News provides you with a selection of the latest news from internet sources, which can be defined as you desire. Through these RSS news feeds, titles and short summaries of news items from websites will be visible directly in the Control Display of your BMW. This gives you quick access to your favoured news topics and enables you to keep in touch.

Google local search

With the Google local search you can access location based information via Google Maps, from the BMW Online portal in the car. Information such as hotels and restaurants can be requested at the current vehicle location, navigation destination or at any other specific location. The content is taken directly from live Google Maps information. Search results appear in a list format, the addresses can be transferred into the navigation system or the telephone number can be transferred to a Bluetooth telephone. Some search results contain additional information such as opening hours, car park details or pictures of the location.

Routes*

With Routes you have the facility to import a route with multiple stop-off points into the navigation system. BMW Routes provides a number of default routes across Europe for you to import in your car via BMW Online. My Routes allows you to configure your own routes on the ConnectedDrive website. They can be saved onto a USB memory stick and you can import them directly into your vehicle. This provides you with the facility to plan a trip from the comfort of your own home.

*Routes is only applicable to vehicles with 609 BMW Professional Multimedia Navigation system.

BMW ConnectedDrive website

As a BMW ConnectedDrive customer you will have access to an internet website with a route planner, traffic information and text message service. The website provides a link to your vehicle by allowing you to send information to your car. You can also modify your news links for My News, or set-up Remote Services for your car. Additional services such as profile settings and a handy help page are also featured.

A three year BMW ConnectedDrive subscription is included with every vehicle equipped with an optional navigation system (606 or 609) and Bluetooth telephone preparation with telematics (633). In conjunction with Bluetooth telephone preparation with telematics (633), unlimited use of BMW ConnectedDrive is included within the subscription.

In the UK ConnectedDrive services require a connection to a UK mobile telephone network. Services are not available on the Isle of Man or the Channel Islands. Some services are available in other European countries, refer to your BMW dealer for more details. Terms and conditions apply.

Aftersales.

BMW Service Inclusive

Wouldn't it be good to know all your servicing costs in advance? Well, that's exactly what BMW Service Inclusive provides. Once you have decided which of the options best suits your needs, you can simply relax, and look forward to enjoying care-free driving, courtesy of BMW Service Inclusive.

BMW Service Inclusive lasts for 5 years or 60,000 miles (whichever occurs sooner), so all you need to do is decide which option suits you best. BMW Service Inclusive – covering all your vehicle's servicing requirements or BMW Service Inclusive Plus which in addition to servicing also covers maintenance items such as brakes pads, brake discs and windscreen wipers.

Furthermore, BMW Service Inclusive is transferable to subsequent owners within the time and mileage period, enhancing the resale value of your car.*

*For further information please contact your local BMW Dealer.

Genuine BMW Accessories

Your choice of car says a great deal about you. Genuine BMW Accessories allow you to make that statement even more personal. There's endless scope for personalising your BMW to suit your needs and style, with a wide range of accessories from exterior and interior styling to mobile communications, all of which have been designed to the same exacting standards as your vehicle. For further details on Genuine BMW Accessories for your BMW, please contact your local BMW Dealer.

BMW Lifestyle

The BMW Lifestyle Collection reflects the exclusivity and versatility of BMW design. This innovative product range demonstrates the highest quality in both materials and functionality. The extensive product portfolio includes clothing and accessories items such as miniatures, keyrings, leather goods, mountain bikes, kids' mobility products, golf accessories, motorsport and yachting products.

	116i Sports Hatch	118i Sports Hatch	120i Sports Hatch	130i Sports Hatch	116d Sports Hatch	118d Sports Hatch	120d Sports Hatch	123d Sports Hatch	
Engine and performance									
Configuration	In line / 4	In line / 4	In line / 4	In line / 6	In line / 4	In line / 4	In line / 4	In line / 4	
Displacement [cc]	1995	1995	1995	2996	1995	1995	1995	1995	
Stroke / Bore [mm]	90 / 84	90 / 84	90 / 84	88 / 85	90 / 84	90 / 84	90 / 84	90 / 84	
Power output [hp]	122	143	170	265	116	143	177	204	
Torque output [Nm]	185	190	210	315	260	300	350	400	
Top speed [mph]	127 (126)	130 (130)	139 (138)	155 (155) ⁵	124	130 (130)	142 (140)	148 (147)	
0-62 mph ¹ [s]	(5-door) (3-door)	9.9 (10.8) 8.8 (9.3)	8.8 (9.3) 7.8 (8.4)	6.1 (6.3) 7.8 (8.4)	6.1 (6.3) 7.7 (8.3)	10.3 6.0 (6.2)	9.0 (9.1) 8.9 (9.0)	7.6 (7.8) 7.5 (7.7)	7.0 (7.1) 6.9 (7.0)
Fuel consumption and emissions ^{2,3}									
Urban	37.7 / 7.5	35.8 / 7.9	32.5 / 8.7	23.2 / 12.2	53.3 / 5.3	52.3 / 5.4	46.3 / 6.1	43.5 / 6.5	
[mpg / l/100km]	(34.0 / 8.3)	(34.4 / 8.2)	(33.6 / 8.4)	(23.0 / 12.3)		(40.9 / 6.9)	(39.2 / 7.2)	(38.7 / 7.3)	
Extra-Urban	58.9 / 4.8	60.1 / 4.7	55.4 / 5.1	47.1 / 6.0	70.6 / 3.9	70.6 / 4.0	68.9 / 4.1	64.2 / 4.4	
[mpg / l/100km]	(53.3 / 5.3)	(56.5 / 5.0)	(55.4 / 5.1)	(47.1 / 6.0)		(62.8 / 4.5)	(64.2 / 4.4)	(61.4 / 4.6)	
Combined	48.7 / 5.8	47.9 / 5.9	44.1 / 6.4	34.0 / 8.3	64.2 / 4.4	62.8 / 4.5	58.9 / 4.8	54.3 / 5.2	
[mpg / l/100km]	(44.1 / 6.4)	(45.6 / 6.2)	(44.8 / 6.3)	(34.0 / 8.3)		(52.3 / 5.4)	(52.3 / 5.4)	(50.4 / 5.6)	
CO₂ emissions [g/km]	139 (152)	140 (148)	152 (150)	197 (198)	118	119 (144)	128 (144)	138 (148)	
Emissions classification	EU4	EU4	EU4	EU4	EU4	EU5	EU5	EU5	
Additional technical data									
Luggage capacity [l]	330 - 1150	330 - 1150	330 - 1150	330 - 1150	330 - 1150	330 - 1150	330 - 1150	330 - 1150	
Fuel tank capacity [l]	53	53	53	53	51	51	51	51	
Curb weight: DIN/EU ⁴ [kg]	(5-door) (3-door)	1275 / 1340 1275 / 1350	1300 / 1375 1290 / 1365	1385 / 1460 1375 / 1450	1305 / 1380 1295 / 1370	1320 / 1395 1310 / 1385	1375 / 1450 1365 / 1440	1420 / 1495 1410 / 1485	
Axle unloaded ratio DIN [%]	(5-door) (3-door)	49.5 (48.9) 49.5 (48.9)	49.9 (49.3) 49.5 (48.5)	49.3 (48.6) 47.3 (47.2)	47.7 (47.6) 48.7	49.1 48.9 (48.4)	49.3 (48.8) 48.4 (48.2)	48.8 (48.6) 47.9 (47.6)	
Gross weight / Payload [kg]	(5-door) (3-door)	1775 / 500 1755 / 490	1775 / 500 1765 / 500	1800 / 500 1790 / 500	1885 / 500 1875 / 500	1830 / 525 1820 / 510	1830 / 510 1865 / 500	1875 / 500 1910 / 500	
Axle loaded limit front/rear [kg]		855 / 1020	855 / 1020	875 / 1020	920 / 1045	885 / 1040	885 / 1040	950 / 1050	
Trailer load braked [kg]		1200	1200	1200	1200	1200 / 1200	1200	1200	
Trailer load unbraked [kg]		650	670	680	725	680	690	720	
Roof load limit [kg]		75	75	75	75	75	75	75	
Drag coefficient [cd]		0.29	0.3	0.3	0.32	0.3	0.3	0.31	

BMW 1 Series 3-door and 5-door Sports Hatches

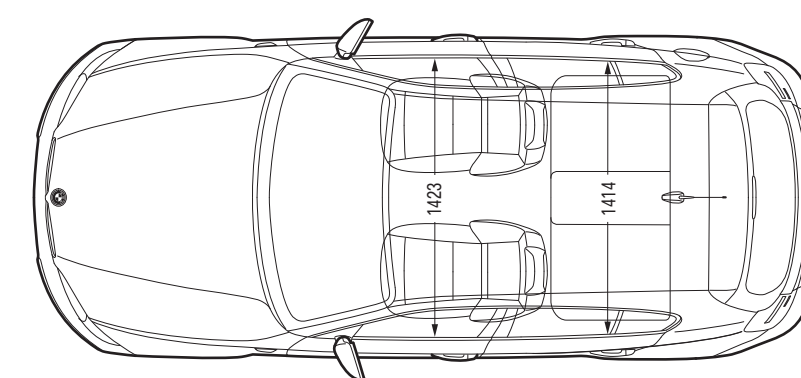
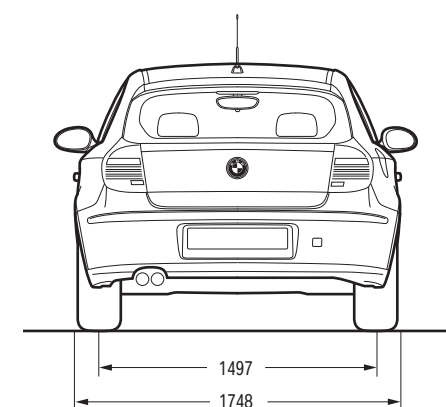
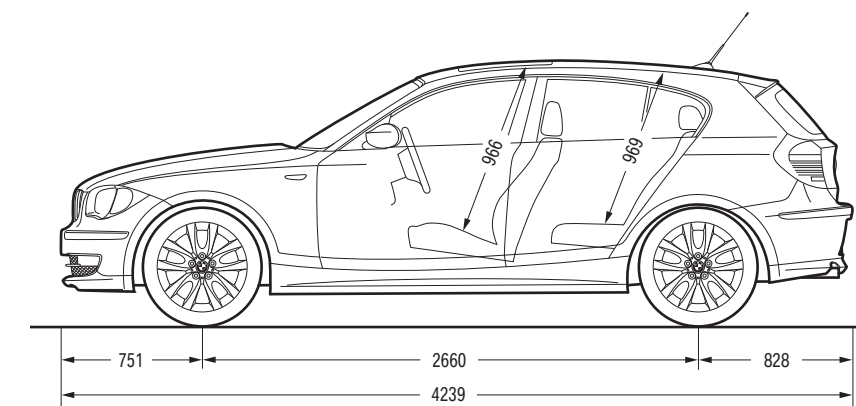
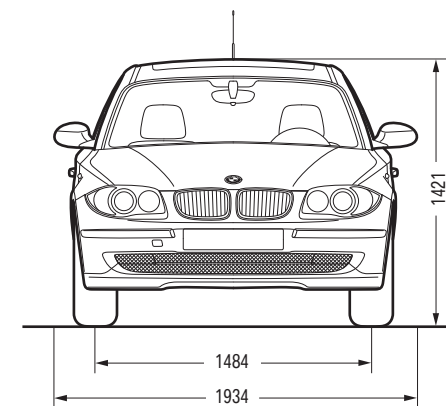

All dimensions in millimetres. Luggage compartment capacity (as per VDA standard): 330 to 1,150 litres. Model shown here is a BMW 1 Series 5-door.

¹ 0-62 mph is equal to 0-100 km/h.

² The petrol engines are designed for RON 98 grade fuel. They can be run on fuel down to RON 91 with a decrease in power.

³ All engines meet the EU4 emissions standard. Fuel consumption is determined in accordance with the ECE driving cycle made up of approximately one third urban traffic and two thirds extra-urban driving (based on the distance covered). CO₂ emissions are measured in addition to fuel consumption.

⁴ The figure quoted includes a 90 per cent tank filling, 68kg for the driver and 7 kg for luggage. Unladen weight applies to vehicles with standard. Optional equipment may increase this figure.
⁵ Electronically limited.

Figures in () apply to cars with automatic transmission.

More about BMW

Tel. 0800 325 600
www.bmw.co.uk



**The Ultimate
Driving Machine**



This price list is printed on paper which has been sourced from sustainably managed forests.