

The BMW 5 Series
Touring



The Ultimate
Driving Machine

Price List



BMW EfficientDynamics
Less emissions. More driving pleasure.



From March 2009

Contents

- 4 **BMW EfficientDynamics**
- 6 **Technical Introduction**
- 7 **Pricing**
- 8 **Standard Equipment**
- 10 **Business Edition**
- 11 **Paintwork**
- 12 **Interior Trim**
- 13 **Upholstery**
- 14 **Paintwork and Upholstery Combinations**
- 16 **Interior Trim and Upholstery Combinations**
- 18 **Colour Linked Parts**
- 19 **Wheels and Tyres**
- 22 **BMW Individual**
- 23 **Optional Equipment**
- 43 **More about BMW**
- 46 **Technical Data**



This is how much has gone in.

The pleasure you get from driving a BMW is the result of fine engineering – always setting the benchmark because it is based on much more than engine power. This is the thinking behind BMW's programme of EfficientDynamics. A change in philosophy, this programme of technologies helps to make positive changes in reducing CO₂ emissions and improving fuel consumption whilst enhancing driving dynamics. Changes for both today and tomorrow. Today's solutions include Brake Energy Regeneration, an innovative process for harnessing energy previously lost. As for tomorrow – even more advanced technologies to improve emissions and fuel consumption as we move towards BMW's vision of CleanEnergy and the use of hydrogen-powered engines. Nothing lost, but much gained. BMW EfficientDynamics: pushing the boundaries in terms of performance and dynamism – without compromise.

High-precision direct injection

In this cutting-edge generation of petrol direct injection, the Piezo injectors are positioned very close to the spark plugs. They inject the fuel at high pressure and with extreme precision. The injectors' central positioning means only part of the combustion chamber needs to be filled with an ignitable petrol-air mixture. The engine can then run "leanly" and so efficiently, precisely in the heavily used moderate load range. (Standard on 523i, 525i, 530i.)

Optimum Shift Indicator

Timely gear shifts are one of the most effective and easiest ways to save fuel. This is where Optimum Shift Indicator in conjunction with six-speed manual transmission comes in. It shows the driver the most fuel-efficient gear to select for any driving situation. (Standard on all models with manual transmission.)

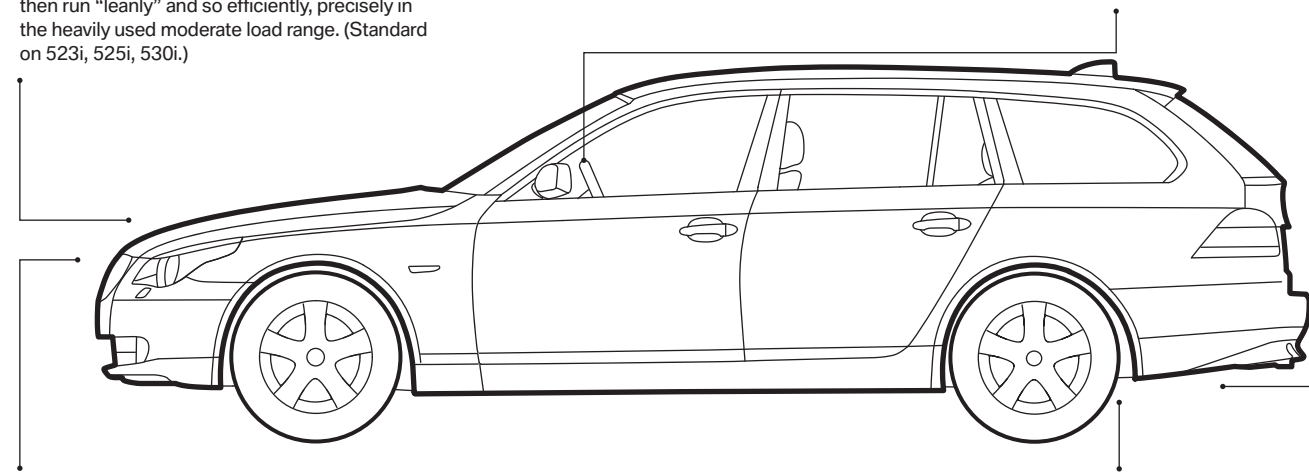

Active Aerodynamics

Engine management signals the engine's current cooling capacity requirements constantly while driving. Rendering a permanent airstream through the radiator unnecessary. The air vents in front of the radiator open or close depending on the environmental temperature and road speed. When shut they improve aerodynamics, shorten the engine's warm-up time and so reduce fuel consumption. (Standard on all SE models.)

Brake Energy Regeneration

The alternator disengages automatically when the battery is fully charged, only re-engaging when the battery needs charging. In addition, the system engages automatically when the car's brakes are applied or when coasting, to recycle otherwise wasted energy. (Standard on all models.)

Certain BMW EfficientDynamics features may be excluded depending on the optional equipment chosen. Your BMW Dealer will be pleased to provide you with more information.

And this is what comes out.

BMW already offers 81 models* with CO₂ emissions of 140 g/km or less. But that's just for starters. We're carrying on our research – in the quest to bring you more driving pleasure and less consumption.

* In the UK and Republic of Ireland.



BMW 5 Series Touring price list insert

Valid from 1 May 2009

Model	Power output (hp)	0-62 mph (secs)	Combined fuel consumption (mpg)	CO ₂ emissions (g/km)	VED band	Insurance group
Petrol						
523i SE	190	8.5 (9.1)	36.7 (36.7)	183 (184)	I (I)	17 / 34
523i M Sport	190	8.5 (9.1)	36.7 (36.7)	183 (184)	I (I)	17 / 35
525i SE	218	7.4 (7.9)	36.7 (36.7)	183 (184)	I (I)	17 / 37
525i M Sport	218	7.4 (7.9)	36.7 (36.7)	183 (184)	I (I)	17 / 38
530i SE	272	6.5 (6.8)	35.8 (36.7)	187 (184)	J (I)	18 / 41
530i M Sport	272	6.5 (6.8)	35.8 (36.7)	187 (184)	J (I)	18 / 42
550i SE	367	5.3 (5.4)	25.2 (26.4)	267 (254)	M (L)	20 / 45
550i M Sport	367	5.3 (5.4)	25.2 (26.4)	267 (254)	M (L)	20 / 45

Diesel						
520d SE	177	8.5 (8.6)	53.3 (48.7)	140 (154)	E (G)	15 / 33
520d SE Business Edition	177	8.5 (8.6)	53.3 (48.7)	140 (154)	E (G)	15 / 34
520d M Sport	177	8.5 (8.6)	53.3 (48.7)	140 (154)	E (G)	16 / 34
520d M Sport Business Edition	177	8.5 (8.6)	53.3 (48.7)	140 (154)	E (G)	16 / 35
525d SE	197	7.8 (7.9)	44.1 (42.8)	171 (176)	H (I)	16 / 35
525d SE Business Edition	197	7.8 (7.9)	44.1 (42.8)	171 (176)	H (I)	17 / 37
525d M Sport	197	7.8 (7.9)	44.1 (42.8)	171 (176)	H (I)	17 / 36
525d M Sport Business Edition	197	7.8 (7.9)	44.1 (42.8)	171 (176)	H (I)	17 / 38
530d SE	235	6.9 (7.0)	42.8 (41.5)	176 (180)	I (I)	17 / 40
530d SE Business Edition	235	6.9 (7.0)	42.8 (41.5)	176 (180)	I (I)	18 / 42
530d M Sport	235	6.9 (7.0)	42.8 (41.5)	176 (180)	I (I)	18 / 42
530d M Sport Business Edition	235	6.9 (7.0)	42.8 (41.5)	176 (180)	I (I)	18 / 42
535d SE¹	286	(6.5)	(40.9)	(182)	(I)	18 / 45
535d M Sport¹	286	(6.5)	(40.9)	(182)	(I)	18 / 45

Post-budget pricing

This insert is designed to be used with the BMW 5 Series Touring Price List and details revised pricing information following the 2009 Government Budget announcement concerning changes to Vehicle Excise Duty bands and rates. The pricing found here is therefore valid from 1 May 2009 onwards.

Full technical data and details of standard and optional equipment can be found in the main Price List.

Prices and specifications

BMW (UK) Limited reserves the right to alter prices and specifications without notice. BMW (UK) Limited has made every effort to ensure the accuracy of information but does not accept liability for any errors or omissions.

Key Figures in (brackets) apply to cars with automatic transmission. Insurance group figures refer to – 20 Group Rating System / 50 Group Rating System.
¹ = Only available with automatic transmission

Basic price (excluding VAT)	VAT	Retail price (including VAT)	On the road price	P11d value	BIK tax rate (2009 / 2010)
£26,243.48	£3,936.52	£30,180	£31,090	£30,860	24%
£28,908.70	£4,336.30	£33,245	£34,155	£33,925	24%
£27,673.91	£4,151.09	£31,825	£32,735	£32,505	24%
£30,339.13	£4,550.87	£34,890	£35,800	£35,570	24%
£31,195.65	£4,679.35	£35,875	£36,825	£36,555	25%
£33,860.87	£5,079.13	£38,940	£39,890	£39,620	25%
£40,747.83	£6,112.17	£46,860	£48,000	£47,540	35%
£42,930.43	£6,439.57	£49,370	£50,510	£50,050	35%
£24,856.52	£3,728.48	£28,585	£29,440	£29,265	19%
£25,726.09	£3,858.91	£29,585	£30,440	£30,265	19%
£27,521.74	£4,128.26	£31,650	£32,505	£32,330	19%
£28,391.30	£4,258.70	£32,650	£33,505	£33,330	19%
£28,152.17	£4,222.83	£32,375	£33,285	£33,055	25%
£29,673.91	£4,451.09	£34,125	£35,035	£34,805	25%
£30,817.39	£4,622.61	£35,440	£36,350	£36,120	25%
£32,339.13	£4,850.87	£37,190	£38,100	£37,870	25%
£31,513.04	£4,726.96	£36,240	£37,150	£36,920	26%
£33,034.78	£4,955.22	£37,990	£38,900	£38,670	26%
£34,178.26	£5,126.74	£39,305	£40,215	£39,985	26%
£35,700.00	£5,355.00	£41,055	£41,965	£41,735	26%
£35,352.17	£5,302.83	£40,655	£41,565	£41,335	27%
£38,017.39	£5,702.61	£43,720	£44,630	£44,400	27%

VED rates

Annual VED rates for brand new cars are determined by their CO₂ emission figure.

BMW 5 Series Touring models fall into one of the seven categories listed below:

CO ₂ emissions g/km	Band E 131-140	Band G 151-165	Band H 166-175	Band I 176-185	Band J 186-200	Band L 226-255	Band M 256+
Vehicle Excise Duty	£120	£150	£175	£175	£215	£405	£405

On the road price

The recommended on the road price includes:

Delivery and BMW Emergency Service	£655
Number plates	£25
Vehicle first registration fee	£55
Vehicle Excise Duty (12 months)	See left



520d SE

Engine

- Catalytic converter
- Common-rail injection system
- Diesel Particulate Filter (DPF)
- Digital Diesel Electronics (DDE)
- Engine mounts, hydraulically controlled
- EU4 emissions management
- Four-cylinder in-line diesel engine with four-valve technology
- Turbo

Transmission

- Six-speed manual transmission

Wheels and chassis

- 17" light alloy Star-spoke style 243 wheels
- Brake callipers – Aluminium, front and rear
- Disc brakes – front and rear, inner ventilated
- Double-joint spring-strut front axle, aluminium
- Integral rear axle, aluminium
- Servotronic power steering

Seats

- Child seat ISOFIX attachment, front (includes Passenger seat airbag deactivation, front)
- Child seat ISOFIX attachment, rear
- Linea cloth upholstery
- Standard seats – front, part-electric adjustment

Safety and technology

- Airbags comprising:
 - Advanced Head Protection System (AHPS II), front and rear
 - Crash sensor activating central locking release, hazard warning lights, fuel cut-off and interior lighting
 - Driver, front passenger, front and side
 - Impact-dependent airbag system (ID airbags), driver and front passenger
 - Passenger seat occupancy sensor, front
- Alarm system (Thatcham 1) with remote control and engine immobiliser
- Anti-whiplash head restraints, front
- Brake Force Display
- Check control warning system
- Child locking system, rear doors
- Condition Based Servicing (CBS)
- Cruise control with brake function

Safety and technology (cont.)

- Deformation zones – front and rear, that can absorb impacts of up to 9.5 mph. Bumpers absorb impacts up to 2.5 mph without damage
- Dynamic Stability Control Plus (DSC+) comprising:
 - Anti-lock Braking System (ABS)
 - Automatic Stability Control (ASC)
 - Brake drying
 - Brake fade compensation
 - Brake pre-tensioning
 - Cornering Brake Control (CBC)
 - Dynamic Brake Control (DBC)
 - Dynamic Traction Control (DTC)
 - Electronic Brake-force Distribution (EBD)
 - Hill-start assistant
 - Soft-stop
- First Aid kit and warning triangle
- Foglights, front and rear
- GRAV – Complete front-end, bonnet and front wings made from lightweight aluminium
- Halogen headlights
- Incorrect fuelling protection system (diesel models only)
- On-Board Diagnosis (OBD)
- Park Distance Control (PDC), front and rear
- Positioning lights, in headlight and rear light clusters
- Rain sensor with automatic headlight activation
- Run-flat tyres with Tyre Puncture Warning System (TPWS)
- Seat belts – front, inertia reel with pyrotechnical belt latch tensioner, belt force limiter and belt restrainer
- Seat belts – rear, three with inertia reel
- Side impact protection

Exterior equipment

- All round anti-corrosion system with partial hot galvanising, phosphate treatment and cathodic dip paintwork, preservation of hollow cavities, underfloor protection
- Exhaust tailpipe – single, oval, stainless steel with chrome finisher
- Exterior mirrors – aspheric, heated, with electric adjustment
- Exterior parts in body colour – bumpers, side sills, door handles, exterior mirror housing
- Exterior trim, Chromeline
- Indicator lenses, clear
- Kidney grille, chrome with black vertical slats
- Roof rails, Black
- Tailgate operation, soft-close
- Wash wipe system, rear
- Windscreen washer jets – heated, black

Interior equipment

- Air conditioning, automatic
- Armrest – front, with storage compartment
- Armrest – rear, with storage compartment
- Courtesy lights, front and rear with soft on/off dimming
- Cup holders, front and rear
- Door sill finishers with BMW designation

Interior equipment (cont.)

- Electric windows – front and rear, with open/close fingertip control, anti-trap facility and comfort closing function all round
- Floor mats, velour
- Glove compartment, lockable and illuminated
- Headlight range control, electric
- Interior trim, Grey, high-gloss
- Luggage compartment comprising
 - Boot release on A-pillar
 - Compartment cover, automatically retractable and removable
 - Compartment with electric unlocking via the key's remote control
 - Dividing net, retractable
- Multi-function leather steering wheel, three-spoke
- Personal Profile
- Power sockets, single 12V in luggage compartment
- Power sockets, twin 12V in rear of centre console
- Reading lights, front and rear
- Rear-view mirror, automatically dimming
- Shark-fin aerial
- Smoker's package (can be deleted)
- Start-Stop button
- Steering column with manual reach and rake adjustment
- Sun visors with illuminated vanity mirrors
- Toolkit located in luggage compartment

Audio and communication

- Auxiliary input for auxiliary playing devices
- BMW Business radio with single CD player
- CD changer preparation
- Control Display – 6.5" colour display screen
- Favourite buttons
- iDrive Controller with shortcut buttons
- On-Board Computer (OBC) comprising:
 - Average speed
 - Fuel consumption and range
 - Outside temperature display

525d SE

Equipment in addition / replacement to 520d SE

- Air conditioning, automatic with extended features
- Armrest – front with sliding adjustment
- Exhaust tailpipes – twin, stainless steel
- Kidney grille, chrome with chrome vertical slats
- On-Board Computer (OBC) comprising:
 - Average speed
 - Fuel consumption and range
 - Journey computer
 - Outside temperature display
 - Speed limit function
 - Stop watch
- Six-cylinder in-line diesel engine with four-valve technology

523i SE and 525i SE

Equipment in addition / replacement to 525d SE

- Cylinder specific knock control
- Digital Motor Electronics (DME)
- Double-VANOS
- High-precision direct injection
- Six-cylinder in-line petrol engine with four-valve technology
- Two-stage intake system (DISA)

530i SE and 530d SE

Equipment in addition / replacement to 523i SE, 525i SE and 525d SE

- 17" light alloy Radial-spoke style 244 wheels
- Metallic paintwork

535d SE

Equipment in addition / replacement to 530d SE

- Lane departure warning system
- Six-speed automatic transmission
- Two-stage twin-turbo

550i SE

Equipment in addition / replacement to 540i SE

- Dakota leather upholstery
- Extended lighting
- Interior trim, Anthracite Bamboo wood, high-gloss
- Lane departure warning system
- Standard seats – front, electric adjustment with driver memory
- Steering column with electric reach and rake adjustment



M Sport models

Equipment in addition / replacement to all SE models

- 18" light alloy M Double-spoke style 135M wheels
- Dakota leather upholstery (550i M Sport)
- Door sill finishers with M designation
- Exterior trim, High-gloss Shadowline
- Flashlight cloth/leather upholstery
- Headlining, Anthracite
- Interior trim, Aluminium Pentan
- Interior trim, Anthracite Bamboo wood, high-gloss (550i M Sport)
- M aerodynamic bodystyling
- M Sport multi-function leather steering wheel, three-spoke
- M Sport suspension
- Sport seats – front, part-electric adjustment (full electric adjustment for 550i M Sport)



520d SE Business Edition
Equipment in addition / replacement to 520d SE

- Bluetooth telephone preparation with telematics
- BMW ConnectedDrive – Assist
- BMW ConnectedDrive – Online
- CD changer
- Dakota leather upholstery
- Door sill finishers with Edition designation
- Navigation system – BMW Business

520d M Sport Business Edition
Equipment in addition / replacement to 520d M Sport

- Bluetooth telephone preparation with telematics
- BMW ConnectedDrive – Assist
- BMW ConnectedDrive – Online
- CD changer
- Dakota leather upholstery
- Door sill finishers with Edition designation
- Navigation system – BMW Business

525d SE Business Edition and 530d SE Business Edition
Equipment in addition / replacement to 525d SE and 530d SE

- Bluetooth telephone preparation with telematics
- BMW ConnectedDrive – Assist
- BMW ConnectedDrive – Online
- Dakota leather upholstery
- Door sill finishers with Edition designation
- Navigation system – BMW Professional Multimedia
- USB audio interface
- Voice Control

525d M Sport Business Edition and 530d M Sport Business Edition
Equipment in addition / replacement to 525d M Sport and 530d M Sport

- 19" light alloy M Double-spoke style 172M
- Bluetooth telephone preparation with telematics
- BMW ConnectedDrive – Assist
- BMW ConnectedDrive – Online
- Dakota leather upholstery
- Door sill finishers with Edition designation
- Navigation system – BMW Professional Multimedia
- USB audio interface
- Voice Control



● **Alpine White**
300 non-metallic

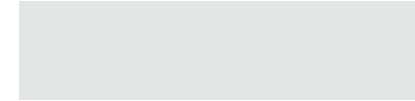

○ **Barbera Red***
A39 metallic



○ **Deep Green***
A43 metallic



○ **Monaco Blue***
A35 metallic



○ **Platinum Grey**
A68 metallic



○ **BMW Individual Aventurine Silver**
S58 metallic

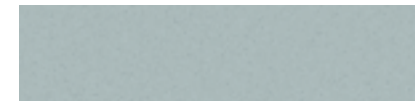

○ **BMW Individual Ruby Black**
X03 metallic



● **Imola Red****
405 non-metallic



○ **Black Sapphire***
475 metallic

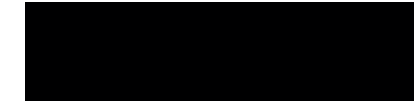

○ **Deep Sea Blue**
A76 metallic



○ **Neptune Blue***
A85 metallic



○ **Space Grey**
A52 metallic



○ **BMW Individual Azurite Black**
S34 metallic



● **Jet Black**
668 non-metallic



○ **Carbon Black****
416 metallic



○ **Le Mans Blue****
381 metallic



○ **Platinum Bronze***
A53 metallic



○ **Titanium Silver**
354 metallic



○ **BMW Individual Moonstone**
X04 metallic

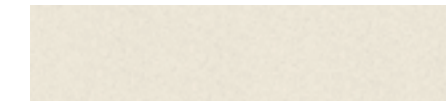

Key ● = Standard ○ = Optional * = Not available on M Sport models ** = Only available on M Sport models

More BMW Individual colourways are available for specific models. Please consult your BMW Dealer for further details.

These colour samples are designed to give you a first impression of paints and materials. Experience has shown however, that printed versions of paint, upholstery and trim colours cannot in all cases faithfully replicate the colour appearance of the originals. We recommend therefore that you consult your BMW Dealer on your preferred choices.

● Grey, high-gloss 4BX*

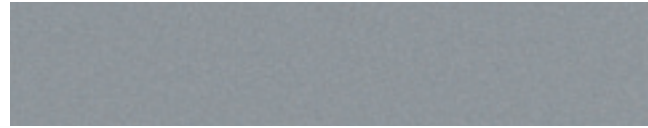

● Anthracite Bamboo wood, high-gloss 4BY¹



○ Brushed Aluminium 439



○ Light Poplar wood, high-gloss 437

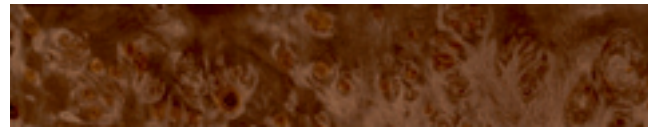

○ BMW Individual Amarone Walnut wood XE1



○ BMW Individual Red Brown Eucalyptus wood XE3



● Aluminium Pentan 4MS**

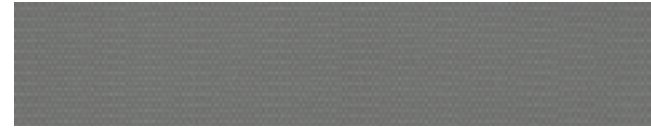

○ Black, high-gloss 4AT



○ Dark Poplar wood, high-gloss 438



○ BMW Individual Piano Black XE7

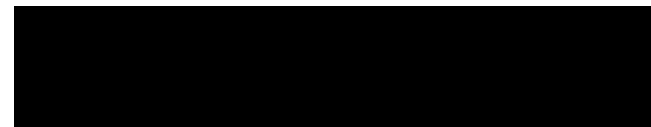

● Linea cloth* Anthracite ALAT



● Flashlight cloth / leather** Anthracite GGAT

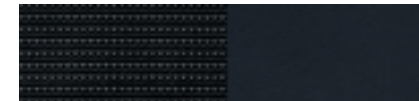

○ Dakota leather Beige LCBA



○ Dakota leather Dark Blue LCCU



○ Nasca leather Beige U6BA



○ Exclusive Nappa leather Tobacco NAF1



○ BMW Individual Extended Merino leather Amarone ZAF2



○ BMW Individual Extended Merino leather Rust Brown ZAP2



● Linea cloth* Beige ALBA



○ Fusion Artificial leather* Beige KBBA



○ Dakota leather Black LCSW



○ Dakota leather Grey LCAD

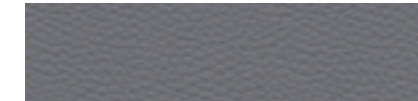

○ Nasca leather Black U6SW



○ BMW Individual Extended Merino leather Champagne ZACM

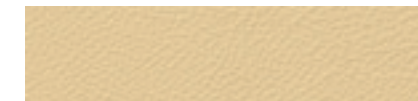

● Linea cloth* Grey ALAD



○ Fusion Artificial leather* Black KBSW



○ Dakota leather Cream Beige LCGE / LCCC



○ Dakota leather Natural Brown LCNG

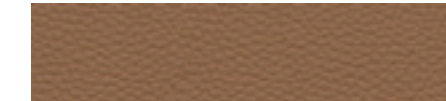

○ Exclusive Nappa leather Black NASW



○ BMW Individual Extended Merino leather Polar Grey ZAP4



Key ● = Standard ○ = Optional ¹ = Standard on 550i only * = Standard on SE, excluding 550i ** = Standard on M Sport, excluding 550i
More BMW Individual colourways are available for specific models. Please consult your BMW Dealer for further details.

Key ● = Standard ○ = Optional * = Not available on M Sport models ** = Standard on M Sport models (excluding 550i)
More BMW Individual colourways are available for specific models. Please consult your BMW Dealer for further details.

Upholstery	Upholstery colour	Upholstery Code	SE Models									550i SE						
			Grey, high-gloss 4BX	Black, high-gloss 4AT	Anthracite Bamboo wood, high-gloss 4BY	Light Poplar wood, high-gloss 437	Dark Poplar wood, high-gloss 438	Brushed Aluminium 439	Amarone Walnut XE1	Red Brown Eucalyptus XE3	Piano Black XE7	Black, high-gloss 4AT	Anthracite Bamboo wood, high-gloss 4BY	Light Poplar wood, high-gloss 437	Dark Poplar wood, high-gloss 438	Brushed Aluminium 439	Amarone Walnut XE1	Red Brown Eucalyptus XE3
Linea cloth [AL]	Anthracite	ALAT	●	◇	○	○	○	○	○	○	-	-	-	-	-	-	-	-
	Beige	ALBA	●	◇	○	○	○	○	○	○	-	-	-	-	-	-	-	-
	Grey	ALAD	●	◇	○	○	○	○	○	○	-	-	-	-	-	-	-	-
Fusion Artificial leather [KB]	Beige	KBBA	●	◇	○	○	○	○	○	○	-	-	-	-	-	-	-	-
	Black	KBSW	●	◇	○	○	○	○	○	○	-	-	-	-	-	-	-	-
Dakota leather [LC]	Beige	LCBA	●	◇	○	○	○	○	○	○	◇	●	◇	◇	◇	○	○	○
	Black	LCSW	●	◇	○	○	○	○	○	○	◇	●	◇	◇	◇	○	○	○
	Cream Beige / Black	LCCC	●	◇	○	○	○	○	○	○	◇	●	◇	◇	◇	○	○	○
	Cream Beige	LCGE	●	◇	○	○	○	○	○	○	◇	●	◇	◇	◇	○	○	○
	Dark Blue	LCCU	●	◇	○	○	○	○	○	○	◇	●	◇	◇	◇	○	○	○
	Grey	LCAD	●	◇	○	○	○	○	○	○	◇	●	◇	◇	◇	○	○	○
	Natural Brown	LCNG	●	◇	○	○	○	○	○	○	◇	●	◇	◇	◇	○	○	○
Nasca leather* [U6]	Beige	U6BA	-	◇	◇	◇	●	◇	○	○	◇	◇	◇	●	◇	○	○	○
	Black	U6SW	-	◇	◇	◇	●	◇	○	○	◇	◇	◇	●	◇	○	○	○
Exclusive Nappa leather** [NA]	Black	NASW	-	◇	●	◇	◇	◇	○	○	◇	●	◇	◇	○	○	○	○
	Tobacco	NAF1	-	◇	●	◇	◇	◇	○	○	◇	●	◇	◇	○	○	○	○
BMW Individual Extended Merino leather [ZA]	Amarone	ZAF2	●	◇	○	○	○	○	○	○	◇	●	◇	◇	○	○	○	○
	Champagne	ZACM	●	◇	○	○	○	○	○	○	◇	●	◇	◇	○	○	○	○
	Polar Grey	ZAP4	●	◇	○	○	○	○	○	○	◇	●	◇	◇	○	○	○	○
	Rust Brown	ZAP2	●	◇	○	○	○	○	○	○	◇	●	◇	◇	○	○	○	○

Key ● = Standard interior trim ◇ = Interior trim available at zero-cost ○ = Interior trim available at extra cost - = Not available
 * = Only available in combination with 453, Seat ventilation and 459, Seat adjustment – front, electric with driver memory
 ** = Only available in combination with 456, Comfort seats, front (an interior trim must be specified)

The above table shows all available interior trim and upholstery colour combinations. To view colour samples please consult your local BMW Dealer who will be happy to assist you with your choices. Alternatively, further combination details can be found on the 'Build your BMW' section of the www.bmw.co.uk website.

Upholstery	Upholstery colour	Upholstery Code	M Sport							550i M Sport								
			Black, high-gloss 4AT	Anthracite Bamboo wood, high-gloss 4BY	Aluminium Pentan 4MS	Light Poplar wood, high-gloss 437	Dark Poplar wood, high-gloss 438	Amarone Walnut XE1	Red Brown Eucalyptus XE3	Piano Black XE7	Black, high-gloss 4AT	Anthracite Bamboo wood, high-gloss 4BY	Aluminium Pentan 4MS	Light Poplar wood, high-gloss 437	Dark Poplar wood, high-gloss 438	Amarone Walnut XE1	Red Brown Eucalyptus XE3	Piano Black XE7
Flashlight cloth / leather [GG]	Anthracite	GGAT	◇	○	●	○	○	○	○	○	◇	●	◇	◇	◇	○	○	○
Dakota leather [LC]	Beige	LCBA	◇	○	●	○	○	○	○	○	◇	●	◇	◇	◇	○	○	○
	Black	LCSW	◇	○	●	○	○	○	○	○	◇	●	◇	◇	◇	○	○	○
	Cream Beige / Black	LCCC	◇	○	●	○	○	○	○	○	◇	●	◇	◇	◇	○	○	○
	Cream Beige	LCGE	◇	○	●	○	○	○	○	○	◇	●	◇	◇	◇	○	○	○
	Dark Blue	LCCU	◇	○	●	○	○	○	○	○	◇	●	◇	◇	◇	○	○	○
	Grey	LCAD	◇	○	●	○	○	○	○	○	◇	●	◇	◇	◇	○	○	○
	Natural Brown	LCNG	◇	○	●	○	○	○	○	○	◇	●	◇	◇	◇	○	○	○
Nasca leather* [U6]	Beige	U6BA	◇	◇	◇	◇	●	○	○	○	◇	◇	◇	◇	●	○	○	○
	Black	U6SW	◇	◇	◇	◇	●	○	○	○	◇	◇	◇	◇	●	○	○	○
Exclusive Nappa leather** [NA]	Black	NASW	◇	◇	●	◇	◇	○	○	○	◇	●	◇	◇	○	○	○	○
	Tobacco	NAF1	◇	◇	●	◇	◇	○	○	○	◇	●	◇	◇	○	○	○	○
BMW Individual Extended Merino leather [ZA]	Amarone	ZAF2	◇	○	●	○	○	○	○	○	◇	●	◇	◇	○	○	○	○
	Champagne	ZACM	◇	○	●	○	○	○	○	○	◇	●	◇	◇	○	○	○	○
	Polar Grey	ZAP4	◇	○	●	○	○	○	○	○	◇	●	◇	◇	○	○	○	○
	Rust Brown	ZAP2	◇	○	●	○	○	○	○	○	◇	●	◇	◇	○	○	○	○

Key ● = Standard interior trim ◇ = Interior trim available at zero-cost ○ = Interior trim available at extra cost - = Not available
 * = Only available in combination with 453, Seat ventilation, front and 459, Seat adjustment – front, electric with driver memory
 ** = Only available in combination with 456, Comfort seats, front (an interior trim must be specified)

The above table shows all available interior trim and upholstery colour combinations. To view colour samples please consult your local BMW Dealer who will be happy to assist you with your choices. Alternatively, further combination details can be found on the 'Build your BMW' section of the www.bmw.co.uk website.

	Carpet	Floor mats	Dashboard		Seats		Doors		
			Lower	Upper	Seat back	Seat facing	Door insert	Door casing	Door armrest

Linea cloth upholstery

Anthracite	Black	Black	Black	Black	Black	Anthracite	Black	Black	Black
Beige	Beige	Beige	Beige	Black	Beige	Beige	Beige	Black	Beige
Grey	Grey	Grey	Grey	Black	Grey	Grey	Grey	Black	Grey

Flashlight cloth / leather upholstery

Anthracite	Black	Black	Black	Black	Black	Anthracite	Anthracite	Black	Black
-------------------	-------	-------	-------	-------	-------	------------	------------	-------	-------

Fusion Artificial leather upholstery

Beige	Beige	Beige	Beige	Black	Beige	Beige	Beige	Black	Beige
Black	Black	Black	Black	Black	Black	Black	Black	Black	Black

Dakota leather upholstery

Beige	Beige	Beige	Black	Black	Beige	Beige	Beige	Black	Beige
Black	Anthracite	Black	Black	Black	Black	Black	Black	Black	Black
Cream Beige / Black	Anthracite	Black	Black	Black	Cream Beige	Cream Beige	Cream Beige	Black	Black
Cream Beige	Cream Beige	Cream Beige	Cream Beige	Black	Cream Beige	Cream Beige	Cream Beige	Black	Cream Beige
Dark Blue	Anthracite	Black	Black	Black	Black	Dark Blue	Dark Blue	Black	Black
Grey	Grey	Grey	Grey	Black	Grey	Grey	Grey	Black	Grey
Natural Brown	Anthracite	Black	Black	Black	Black	Natural Brown	Natural Brown	Black	Black

Nasca leather upholstery



Beige	Beige	Beige	Beige	Black	Beige	Beige	Beige	Black	Beige
Black	Black	Black	Black	Black	Black	Black	Black	Black	Black

Exclusive Nappa leather upholstery

Black	Black	Black	Black	Black	Black	Black	Black	Black	Black
Tobacco	Black	Black	Black	Black	Tobacco	Tobacco	Tobacco	Black	Black

BMW Individual Extended Merino leather upholstery



Amarone	Anthracite	Black	Black	Black	Amarone	Amarone	Amarone	Black	Amarone
Champagne	Anthracite	Black	Black	Black	Champagne	Champagne	Champagne	Black	Champagne
Polar Grey	Anthracite	Black	Black	Black	Polar Grey	Polar Grey	Polar Grey	Black	Polar Grey
Rust Brown	Anthracite	Black	Black	Black	Rust Brown	Rust Brown	Rust Brown	Black	Rust Brown

		Star-spoke style 243	Radial-spoke style 244
Wheel size	Front / rear	7.5 J x 17	7.5 J x 17
Tyre size	Front / rear	225/50 R17	225/50 R17
	Option code	2SD	2HH
			
523i SE, 525i SE, 520d SE, 525d SE		●	£80
530i SE, 550i SE, 530d SE, 535d SE		£0	●



		V-spoke style 245	Star-spoke style 122
Wheel size	Front / rear	8 J x 17	8 J x 17
Tyre size	Front / rear	245/45 R17	245/45 R17
	Option code	2KM	589
			
All SE models		£345	£345



Key ● = Standard £ = Optional – = Not available
 * = Please note that this wheel has a forged appearance
 ** = Only available in combination with a BMW Individual paintwork or BMW Individual upholstery

		Double-spoke style 278	V-spoke style 277
Wheel size	Front / rear	8 J x 17	8 J x 17
Tyre size	Front / rear	245/45 R17 ¹	245/45 R17 ¹
	Option code	2BY	2KT
			
All SE models		£775	£775

		Star-spoke style 246	Star-spoke style 124
Wheel size	Front / rear	8 J x 18	8 J x 18
Tyre size	Front / rear	245/40 R18	245/40 R18
	Option code	2SE	2C0
			
All SE models		£820	£890

Key £ = Optional
¹ = 225/50 R17 for 523i, 525i, 520d and 525d

		BMW Individual V-spoke style 152	Double-spoke style 247**
Wheel size	Front / rear	8 J x 18	8 J x 18
Tyre size	Front / rear	245/40 R18	245/40 R18
	Option code	2M0	2BS
			
All SE models		£965***	£1,095

		M Double-spoke style 135M	M Double-spoke style 172M*
Wheel size	Front / rear	8 J x 18	8.5 J x 19
Tyre size	Front / rear	245/40 R18	245/35 R19
	Option code	2NP	2NR
			
M Sport models		●	£500
525d/530d M Sport Business Edition models		-	●

Key ● = Standard £ = Optional - = Not available
 * = Snow chains cannot be fitted to these wheels
 ** = Please note that this wheel has a forged appearance
 *** = Only available in combination with a BMW Individual paintwork or BMW Individual upholstery



The most exclusive way to drive a BMW

The higher your standards, the less room there is for compromise. For drivers with the most exacting standards BMW Individual offers a range of stunning and perfectly-crafted materials to ensure that the expression of individuality has never felt so effortless.

A BMW Individual paint finish is more than just a colour, each has its own characteristic brilliance and complexity. Five layers deep, the depth of colour is more sophisticated than the regular metallic paints thanks to a special pigmentation. Xirallic or Titanium Dioxide pigments create an iridescent effect which gives the colours an unmistakable brilliance in the light.

Inside, the level of exclusivity can be continued with the distinctive yet subtle tones of BMW Individual Merino leather. A painstaking refinement process ensures that the leather is kept soft and supple, retaining a unique feel throughout its life as well as meeting the practical demands of a luxury car. And just to complete the interior, you can choose from the hand-picked wood trims that ensure the perfect grain every time.

Let yourself be inspired with BMW Individual.



		523i SE	523i M Sport	525i SE	525i M Sport	530i SE	530i M Sport	550i SE	550i M Sport	520d SE	520d SE Business Edition	520d M Sport	520d M Sport Business Edition	525d SE	525d SE Business Edition	525d M Sport	525d M Sport Business Edition	530d SE	530d SE Business Edition	530d M Sport	530d M Sport Business Edition	535d SE	535d M Sport	Price
--	--	---------	--------------	---------	--------------	---------	--------------	---------	--------------	---------	--------------------------	--------------	-------------------------------	---------	--------------------------	--------------	-------------------------------	---------	--------------------------	--------------	-------------------------------	---------	--------------	-------

BMW EfficientDynamics

Active Aerodynamics	●	-	●	-	●	-	●	-	●	●	-	-	●	●	-	-	●	●	-	-	●	-	-	std
Brake Energy Regeneration	●	●	●	●	●	●	●	●	●	●	●	●	●	●	●	●	●	●	●	●	●	●	●	std
High-precision direct injection	●	●	●	●	●	●	-	-	-	-	-	-	-	-	-	-	-	-	-	-	-	-	-	std
Optimum Shift Indicator	●	●	●	●	●	●	●	●	●	●	●	●	●	●	●	●	●	●	●	●	●	-	-	std

Certain BMW EfficientDynamics features may be excluded depending on the optional equipment chosen. Your BMW Dealer will be pleased to provide you with more information.

Transmission

Automatic transmission Six-speed automatic transmission with Steptronic sequential manual mode. Includes shift-interlock and Adaptive transmission control (AGS).	205	○	○	○	○	○	○	○	○	○	○	○	○	○	○	○	○	○	○	○	○	○	○	●	●	£1,460
Sport automatic transmission Dynamic and sporty gear changes via steering wheel paddles or selector lever. Sport buttons activates Sport mode where gear changes are almost instantaneous in either up or down shifts. Please note that on M Sport models, the M Sport steering wheel changes in design closer to 255, Sport steering wheel. Only with 255 / 710.	2TB	-	-	-	-	○	○	○	○	-	-	-	-	-	-	-	○	○	○	○	○	○	○	○	○	£1,535
																										£100

Wheels and chassis

Active Steering Effortless steering when parking and turning due to minimum steering lock (centre to full lock = 3 / 4 turn). Relaxed motoring at high speeds due to a more indirect steering.	217	○	○	○	○	○	○	○	○	-	-	-	-	-	-	-	-	-	-	-	-	-	○	○	£905	
Space-saver spare wheel Space-saver spare wheel, wheel brace, jack and wheel chock. 135 / 80 R17.	300	○	○	○	○	○	○	○	○	○	○	○	○	○	○	○	○	○	○	○	○	○	○	○	○	£75
Sport suspension Vehicle lowered by 15 mm.	226	○	-	○	-	○	-	○	-	○	○	-	-	○	○	-	-	○	○	-	-	○	-	-	£285	

Key Only with – these options must be ordered together ● = Standard ○ = Optional - = Not available
/ = Indicates 'or'

		523i SE	523i M Sport	525i SE	525i M Sport	530i SE	530i M Sport	550i SE	550i M Sport	520d SE	520d SE Business Edition	520d M Sport	520d M Sport Business Edition	525d SE	525d SE Business Edition	525d M Sport	525d M Sport Business Edition	530d SE	530d SE Business Edition	530d M Sport	530d M Sport Business Edition	535d SE	535d M Sport	Price	
Safety and technology																									
Active Cruise Control with 'Stop and Go' function	5DF	○	○	○	○	○	○	○	○	-	-	-	-	○	○	○	○	○	○	○	○	○	○	○	£1,280
Automatic adjustment of the distance between the car and the vehicle ahead. In stop/start motorway traffic, the system will maintain the distance to the car ahead even if it comes to a complete stop. Once the traffic ahead clears, the car will return to the pre-set speed, providing that the period the vehicle was stationary was not longer than 3 seconds. Only with 205 / 2TB and 606 / 609.																									
Adaptive Headlights	524	○	○	○	○	○	○	○	○	○	○	○	○	○	○	○	○	○	○	○	○	○	○	○	£370
Improved visibility by following the steering angle of the front wheels. Giving better illumination of the road ahead through corners (visibility can be improved up to 90%). Not active when the car is reversing to avoid dazzling oncoming traffic. Includes cornering light (active up to 22 mph), which provides additional illumination of the area to the front, side of the car. Only with 522.																									
Airbags, rear side	261	○	○	○	○	○	○	○	○	○	○	○	○	○	○	○	○	○	○	○	○	○	○	○	£250
Rear door side airbags with outer seat belt pretensioners. Compatible with BMW ISOFIX child seats.																									
Cruise control with brake function	544	●	●	●	●	●	●	●	●	●	●	●	●	●	●	●	●	●	●	●	●	●	●	●	std
Adjustable in five mph segments as well as one mph segments for fine tuning. Pre-set speed is automatically maintained by the application of the throttle and brakes.																									
Dynamic Drive	229	-	-	○	○	○	○	○	○	-	-	-	-	○	○	○	○	-	-	-	-	-	-	-	£1,595
Roll stabilisation via active hydraulic anti-roll bars.																									
Head-up Display	610	○	○	○	○	○	○	○	○	○	○	○	○	○	○	○	○	○	○	○	○	○	○	○	£920
Head-up display projects important information such as current speed directly into the driver's field of vision. Direction arrows from the Navigation system, Cruise control functions and Check control data can also be displayed. Only with 534 and 606 / 609.																									

Key Only with – these options must be ordered together / = Indicates 'or'

● = Standard ○ = Optional – = Not available

		523i SE	523i M Sport	525i SE	525i M Sport	530i SE	530i M Sport	550i SE	550i M Sport	520d SE	520d SE Business Edition	520d M Sport	520d M Sport Business Edition	525d SE	525d SE Business Edition	525d M Sport	525d M Sport Business Edition	530d SE	530d SE Business Edition	530d M Sport	530d M Sport Business Edition	535d SE	535d M Sport	Price	
Safety and technology (cont.)																									
Headlight wash	502	○	○	○	○	○	○	○	○	○	○	○	○	○	○	○	○	○	○	○	○	○	○	○	£205
High pressure system for cleaning main headlights. Automatically included when 522, Xenon headlights are fitted.																									
High-beam Assistant	5AC	○	○	○	○	○	○	○	○	○	○	○	○	○	○	○	○	○	○	○	○	○	○	○	£105
Supports the driver by automatically alternating between low and high beam when there is oncoming traffic and when driving through changing light conditions. The system will switch high-beam lights on and off automatically. Only with 522.																									
Lane departure warning system	5AD	○	○	○	○	○	○	●	●	○	○	○	○	○	○	○	○	○	○	○	○	○	○	○	£415
Activated by a button on the steering wheel. Once travelling at speeds in excess of 40 mph, a camera mounted in the windscreen measures the distance of the car to the white lines marking out the lane. If the car crosses one of the lines, the steering wheel vibrates as an alert that the vehicle has deviated from the lane of travel. If the indicators are used, the steering wheel will not vibrate.																									
Night Vision	611	○	○	○	○	○	○	○	○	○	○	○	○	○	○	○	○	○	○	○	○	○	○	○	£1,335
Infrared sensing camera integrated into the front bumper of the car which picks up heat signatures emitted from objects such as car exhaust systems or, more importantly, humans and animals up to 300 metres away. Control Display is used to show infrared images of obstacles on the road ahead for improved awareness and safety. Only with 502 and 609.																									
Park Distance Control (PDC), front and rear	508	●	●	●	●	●	●	●	●	●	●	●	●	●	●	●	●	●	●	●	●	●	●	●	std
Provides acoustic and visual distance warning of obstacles to the front and rear of the car. Sensors are finished in body colour.																									
Xenon headlights	522	○	○	○	○	○	○	○	○	○	○	○	○	○	○	○	○	○	○	○	○	○	○	○	£785
For low and high beam with dynamic range control, providing much better illumination of the road ahead at night or in poor visibility. Includes 502, Headlight wash.																									

Key Only with – these options must be ordered together

● = Standard ○ = Optional

	523i SE	523i M Sport	525i SE	525i M Sport	530i SE	530i M Sport	550i SE	550i M Sport	520d SE	520d SE Business Edition	520d M Sport	520d M Sport Business Edition	525d SE	525d SE Business Edition	525d M Sport	525d M Sport Business Edition	530d SE	530d SE Business Edition	530d M Sport	530d M Sport Business Edition	535d SE	535d M Sport	Price	
Seats																								
Child seat ISOFIX attachment, front 470	●	●	●	●	●	●	●	●	●	●			●	●			●	●			●			std
Front passenger seat airbag deactivation, for use with an ISOFIX child seat. Includes front ISOFIX fixings. ISOFIX child seat fixings in the rear seats are standard. For SE models with 481, Sport seats – front, part-electric adjustment and for M Sport models, option 459, Seat adjustment – front, electric with driver memory must be specified. Alternatively, for M Sport models, 456, Comfort seats, front can be specified.																								
In combination with M Sport models.		○	○	○	○						○	○			○	○			○	○				£0
Comfort seats, front 456	○	○	○	○		○		○	○				○	○			○	○			○			£1,370
Includes electric adjustment of the upper section of the backrest, backrest width, thigh support, head restraint height and steering column. Includes electric comfort head restraints with adjustment of outer pad and active head restraint functionality. Memory functions for passenger seat as well. Includes 459, Seat adjustment – front, electric with driver memory, and 488, Lumbar support, driver and front passenger. Includes 470, Child seat ISOFIX attachment, front for M Sport models. Only with LC / U6 / NA / ZA. Not with 459 / 481 / 488 / AL / GG / KB.																								£635
In combination with M Sport models.		○	○	○	○						○	○			○	○			○	○				£995
In combination with Z5N.	○	○	○	○	○	○	○	○	○				○		○						○			£815
Dynamic support seat backrest, front 4MF	○	○	○	○	○	○	○	○	○	○	○	○	○	○	○	○	○	○	○	○	○	○	○	£595
Allows greater stability and seating support for driver and front passenger through the active seat back width adjustment function, which responds to the movements of steering angle when driving. Only with 456. Not with 455.																								

Key

Only with – these options must be ordered together
 Not with – these options are not available for ordering together
 / = Indicates 'or'

● = Standard ○ = Optional

	523i SE	523i M Sport	525i SE	525i M Sport	530i SE	530i M Sport	550i SE	550i M Sport	520d SE	520d SE Business Edition	520d M Sport	520d M Sport Business Edition	525d SE	525d SE Business Edition	525d M Sport	525d M Sport Business Edition	530d SE	530d SE Business Edition	530d M Sport	530d M Sport Business Edition	535d SE	535d M Sport	Price	
Seats (cont.)																								
Lumbar support, driver and front passenger 488	○	○	○	○	○	○	○	○	○	○	○	○	○	○	○	○	○	○	○	○	○	○	○	£245
Pneumatic height and depth adjustment. Electronically adjustable for ergonomically perfect seat position and support of back muscles. Included with 455, Oscillating seat base function and 456, Comfort seats, front. Not with 455 / 456.																								
Oscillating seat base function 455	○	○	○	○	○	○	○	○	○	○	○	○	○	○	○	○	○	○	○	○	○	○	○	£575
Allows relaxed seating and driving on longer journeys. Pelvis and lumbar vertebrae are mobilised by alternating cyclical up/down adjustment of the seats surface. Includes 488, Lumbar support, driver and front passenger. Only with 456. Not with 488.																								
Seat adjustment – front, electric with driver memory 459	○	○	○	○	○	○	●	●	○	○	○	○	○	○	○	○	○	○	○	○	○	○	○	£885
All seat planes are electrically adjusted including head restraints and memory function for driver's seat (two memory positions). Includes electric steering column adjustment. When reverse gear is selected the passenger exterior mirror automatically dips to assist with parking – 'kerb view function' (standard for 550i SE / M Sport). Includes 470, Child seat ISOFIX attachment, front for M Sport models. Not with 456.																								
Seat heating, front 494	○	○	○	○	○	○	○	○	○	○	○	○	○	○	○	○	○	○	○	○	○	○	○	£295
Seat heating for driver and front passenger. Seat surface and backrest are rapidly heated to add comfort in colder months. The heated seats can be adjusted by a three-stage switch. Included with 453, Seat ventilation, front. Not with 453.																								
Seat heating, rear 496	○	○	○	○	○	○	○	○	○	○	○	○	○	○	○	○	○	○	○	○	○	○	○	£295
Seat heating for rear seats. The heated seats can be adjusted by a two-stage switch. Only with LC / U6 / NA / ZA. Only with 453 / 494.																								

Key

Only with – these options must be ordered together
 Not with – these options are not available for ordering together
 / = Indicates 'or'

● = Standard ○ = Optional

		523i SE	523i M Sport	525i SE	525i M Sport	530i SE	530i M Sport	550i SE	550i M Sport	520d SE	520d SE Business Edition	520d M Sport	520d M Sport Business Edition	525d SE	525d SE Business Edition	525d M Sport	525d M Sport Business Edition	530d SE	530d SE Business Edition	530d M Sport	530d M Sport Business Edition	535d SE	535d M Sport	Price	
Seats (cont.)																									
Seat ventilation, front	453	○	○	○	○	○	○	○	○	○	○	○	○	○	○	○	○	○	○	○	○	○	○	○	£790
Ventilation of driver and front passenger seats by air conditioned cooling vents through perforated Nasca leather upholstery. Improves comfort during hotter months, also automatically includes 494, Seat heating, front. Only with U6 / ZA and 456 / 459. Not with 481 / 494.																									
Sport seats – front, part-electric adjustment	481	○	●	○	●	○	●	○	●	○	○	●	●	○	○	●	●	○	○	●	●	○	●	○	£390
Additional side supports help ensure optimum lateral support when cornering. The seats feature individual adjustments for height, backrest and manual adjustment of seat tilt (driver's seat) and fore/aft adjustment. (550i M Sport has full electric seat adjustment.) For SE models, 470, Child seat ISOFIX attachment, front is deleted unless 459, Seat adjustment – front, electric with driver memory is specified. Not with 453 / 456, not with K6 / U6 / NA.																									

Exterior equipment

Bootlid operation, powered	316	○	○	○	○	○	○	○	○	○	○	○	○	○	○	○	○	○	○	○	○	○	○	○	£480
Automatic tailgate operation via remote control. Closing is carried out by a button on the inside of the tailgate. Load area cover also raises and lowers automatically.																									
Comfort Access	322	○	○	○	○	○	○	○	○	○	○	○	○	○	○	○	○	○	○	○	○	○	○	○	£735
Enables the opening and locking of the vehicle without having to operate the radio remote control. It is sufficient for the key to be in a pocket, briefcase or handbag. In addition, the engine can be started without the need for a key, using the Start-Stop button.																									
De-chrome	339	○	-	○	-	○	-	○	-	○	○	-	-	○	○	-	-	○	○	-	-	○	-	○	£145
Exterior window recess strips finished in matt black.																									
Exterior trim, High-gloss Shadowline	760	○	●	○	●	○	●	○	●	○	○	○	○	○	○	○	○	○	○	○	○	○	○	○	£280
Exterior window recess strips finished in high-gloss black.																									

Key Only with – these options must be ordered together ● = Standard ○ = Optional - = Not available
 Not with – these options are not available for ordering together
 / = Indicates 'or'

		523i SE	523i M Sport	525i SE	525i M Sport	530i SE	530i M Sport	550i SE	550i M Sport	520d SE	520d SE Business Edition	520d M Sport	520d M Sport Business Edition	525d SE	525d SE Business Edition	525d M Sport	525d M Sport Business Edition	530d SE	530d SE Business Edition	530d M Sport	530d M Sport Business Edition	535d SE	535d M Sport	Price	
Exterior equipment (cont.)																									
Model designation, deletion	320	○	○	○	○	○	○	○	○	○	○	○	○	○	○	○	○	○	○	○	○	○	○	○	£0
Removal of model inscription on the bootlid.																									
Roof rails, black	386	●	●	●	●	●	●	●	●	●	●	●	●	●	●	●	●	●	●	●	●	●	●	●	std
Roof rails for use with BMW's multi-functional roof-rack system.																									
Soft-close doors	323	○	○	○	○	○	○	○	○	○	○	○	○	○	○	○	○	○	○	○	○	○	○	○	£425
Motorised soft-close for doors.																									
Towbar, detachable	235	-	○	-	○	-	○	-	○	-	○	-	○	-	○	-	○	-	○	-	○	-	○	○	£570
Includes a 13-pin European electric plug. Additional electrical connectors may be required. Please consult your BMW Dealer. Only with M Sport models. Not with 3AC.																									
Towbar, fully electric	3AC	○	-	○	-	○	-	○	-	○	○	-	-	○	○	-	-	○	○	-	-	○	-	○	£790
Concealed and permanently installed behind the bumper. Released and retracted electrically by means of a button in the luggage compartment. Comes with a 13-pin European electric plug. Additional electric connectors may be required. Please consult your BMW Dealer. Not with 235, not with M Sport models.																									

Interior equipment

Air conditioning, automatic with extended features	534	○	○	○	○	○	○	○	○	○	○	○	○	○	○	○	○	○	○	○	○	○	○	○	£580
Fully automatic temperature stratification and air volume control. Separate temperature control for driver's and passenger's sides. Variable temperature rear interior ventilation by vents in centre console. Functions include: Max air conditioning button, residual heat utilisation, automatic re-circulated air control (AUC), programming function for automatic ventilation of cabin whilst parked, main functions adjustable through Control Display. Includes 473, Armrest – front, with sliding adjustment and OBC (high) which comprises: Journey computer, Speed limit function and Stop watch. Not with 473 on 520d models.																									
		●	●	●	●	●	●	●	●	●	●	●	●	●	●	●	●	●	●	●	●	●	●	●	std

Key Not with – these options are not available for ordering together ● = Standard ○ = Optional - = Not available

	523i SE	523i M Sport	525i SE	525i M Sport	530i SE	530i M Sport	550i SE	550i M Sport	520d SE	520d SE Business Edition	520d M Sport	520d M Sport Business Edition	525d SE	525d SE Business Edition	525d M Sport	525d M Sport Business Edition	530d SE	530d SE Business Edition	530d M Sport	530d M Sport Business Edition	535d SE	535d M Sport	Price
Interior equipment (cont.)																							
Armrest – front with sliding adjustment 473																							£125
Sliding armrest segment with two-compartment storage box and air vent for internal cooling. Automatically included in 534, Air conditioning, automatic with extended features, 633, Bluetooth telephone preparation with telematics capability and 644, Bluetooth telephone preparation.	●	●	●	●	●	●	●	●	○	○	○	○	○	○	○	○	○	○	○	○	○	○	std
Climate Comfort laminated glass 356	○	○	○	○	○	○	○	○	○	○	○	○	○	○	○	○	○	○	○	○	○	○	£770
Infrared reflective laminate for windscreen, side and rear windows. Includes 354, Windscreen with green shade band. Only with 534 on 520d. Not with 354 / 610 / 761.																							
Cup holders, front and rear 442	●	●	●	●	●	●	●	●	●	●	●	●	●	●	●	●	●	●	●	●	●	●	std
For driver, centred, and passenger, offset to left, in instrument panel. Including rear centre armrest with utility box and two cup holders.																							
Extended lighting 563	○	○	○	○	○	○	●	●	○	○	○	○	○	○	○	○	○	○	○	○	○	○	£180
Lighting of door-opener, front footwell lights underneath instrument panel, ambient light in front and rear door panels, door exit lights at rear and lighting of outer door area in outside mirror. Additional luggage compartment lighting in luggage compartment lid and door-compartment.																							
Extended storage 493	○	○	○	○	○	○	○	○	○	○	○	○	○	○	○	○	○	○	○	○	○	○	£190
Multi-function storage system for added flexibility.																							
Floor mats, velour 423	●	●	●	●	●	●	●	●	●	●	●	●	●	●	●	●	●	●	●	●	●	●	std
Floor mats, front and rear, in same colour as interior carpets.																							
Headlining, Anthracite 775	○	●	○	●	○	●	○	●	○	○	●	●	○	○	●	●	○	○	●	○	○	○	£255
Upgraded headlining in Anthracite, standard for all M Sport models.																							
Panoramic glass sunroof 402	○	○	○	○	○	○	○	○	○	○	○	○	○	○	○	○	○	○	○	○	○	○	£1,225
Double sunroof with electric twin tilt function and opening front section. Feature operated by car key and one-touch function.																							

Key

Only with – these options must be ordered together
 Not with – these options are not available for ordering together
 / = Indicates 'or'

● = Standard ○ = Optional

	523i SE	523i M Sport	525i SE	525i M Sport	530i SE	530i M Sport	550i SE	550i M Sport	520d SE	520d SE Business Edition	520d M Sport	520d M Sport Business Edition	525d SE	525d SE Business Edition	525d M Sport	525d M Sport Business Edition	530d SE	530d SE Business Edition	530d M Sport	530d M Sport Business Edition	535d SE	535d M Sport	Price
Interior equipment (cont.)																							
Rear-view and folding exterior mirrors, automatically dimming 430	○	○	○	○	○	○	○	○	○	○	○	○	○	○	○	○	○	○	○	○	○	○	£235
Dimming interior and exterior mirrors prevent being dazzled from a vehicle behind and also includes exterior folding mirrors for tight spots or when parking.																							
Rear-view mirror, automatically dimming 431	●	●	●	●	●	●	●	●	●	●	●	●	●	●	●	●	●	●	●	●	●	●	std
Interior mirror with automatic anti-dazzle function.																							
Ski bag 464	○	○	○	○	○	○	○	○	○	○	○	○	○	○	○	○	○	○	○	○	○	○	£185
Integrated pull-out ski bag behind rear centre armrest.																							
Smoker's package 441	●	●	●	●	●	●	●	●	●	●	●	●	●	●	●	●	●	●	●	●	●	●	std
Can be deleted, which replaces the ashtrays with oddment trays. The 12V socket in the front is also deleted.																							
Sun protection glass 761	○	○	○	○	○	○	○	○	○	○	○	○	○	○	○	○	○	○	○	○	○	○	£285
Darkened glass for rear screen and rear side windows. This option does not offer UV protection. Includes 354, Windscreen with green shade band. Not with 354 / 356.																							
Sunblind – rear windscreen, (manual) 417	○	○	○	○	○	○	○	○	○	○	○	○	○	○	○	○	○	○	○	○	○	○	£170
Manual side blinds, offer more privacy in rear of car and protection from the sun. Also aids in keeping the interior of the car cooler.																							
Universal remote control 319	○	○	○	○	○	○	○	○	○	○	○	○	○	○	○	○	○	○	○	○	○	○	£165
Can replace up to three separate remote control devices for garage door openers, electric gate openers, or similar remote control systems eradicating the need to have loose remote control handsets inside the vehicle. Certain remote control devices may not be compatible. For further details, please visit www.homelink.com .																							
Windscreen with green shade band 354	○	○	○	○	○	○	○	○	○	○	○	○	○	○	○	○	○	○	○	○	○	○	£55
Includes an attractive green stripe at the upper edge of the windscreen. Not with 356 / 610 / 761.																							

Key

Not with – these options are not available for ordering together
 / = Indicates 'or'

● = Standard ○ = Optional

		523i SE	523i M Sport	525i SE	525i M Sport	530i SE	530i M Sport	550i SE	550i M Sport	520d SE	520d SE Business Edition	520d M Sport	520d M Sport Business Edition	525d SE	525d SE Business Edition	525d M Sport	525d M Sport Business Edition	530d SE	530d SE Business Edition	530d M Sport	530d M Sport Business Edition	535d SE	535d M Sport	Price
Steering wheels																								
Sport leather steering wheel, three-spoke	255	○	-	○	-	○	-	○	-	○	○	-	-	○	○	-	-	○	○	-	-	○	-	£110
Smaller diameter, sportier steering wheel. Standard 385 mm diameter. Sport 379 mm diameter. Not with M Sport models.																								
Steering wheel heating	248	○	○	○	○	○	○	○	○	○	○	○	○	○	○	○	○	○	○	○	○	○	○	£175
Steering wheel heating element for added comfort during cooler or winter months. Activated by switch on steering column. For M Sport models, the leather on the steering wheel will change to Montana leather. Only with 494 / 453. Not with 2TB and 5AD.																								

Key

Only with – these options must be ordered together
 Not with – these options are not available for ordering together
 / = Indicates 'or'

○ = Optional – = Not available

		523i SE	523i M Sport	525i SE	525i M Sport	530i SE	530i M Sport	550i SE	550i M Sport	520d SE	520d SE Business Edition	520d M Sport	520d M Sport Business Edition	525d SE	525d SE Business Edition	525d M Sport	525d M Sport Business Edition	530d SE	530d SE Business Edition	530d M Sport	530d M Sport Business Edition	535d SE	535d M Sport	Price
Audio and communication																								
Bluetooth telephone preparation	644	○	○	○	○	○	○	○	○	○	-	○	-	○	-	○	-	○	-	○	-	○	-	£525
Preparation for a mobile phone with Bluetooth interface. Includes 473, Armrest – front with sliding adjustment. This does not include a handset or an optional phone cradle and these need to be purchased separately. Please consult your BMW Dealer for details of compatible handsets or go to www.bmw.co.uk/bluetooth . Not with 606 / 609, 473.																								
Bluetooth telephone preparation with telematics	633	○	○	○	○	○	○	○	○	○	●	○	●	○	●	○	●	○	●	○	●	○	○	£525
Preparation for a mobile phone with Bluetooth interface. Includes 473, Armrest – front with sliding adjustment. Please note that this does not include handset or an optional phone cradle and these need to be purchased separately. Please consult your BMW Dealer for details of compatible handsets or go to www.bmw.co.uk/bluetooth . Includes a pre-fitted SIM card for the use of BMW ConnectedDrive – Assist. Can only be ordered in conjunction with 606, Navigation system – BMW Business or 609, Navigation system – BMW Professional Multimedia. Only with 606 / 609, 612 and 616. Not with 473.																								
BMW ConnectedDrive – Assist	612	○	○	○	○	○	○	○	○	○	●	○	●	○	●	○	●	○	●	○	●	○	○	£0
Telematics services with automatic and manual 999 emergency SOS call, BMW Breakdown Service, My Info with Google send to car function and Information Plus (location-based operator service). Includes subscription to services for three years (customer registration required to activate services). Automatically included with a navigation system – 606 / 609, 616 BMW ConnectedDrive – Online and 633 Bluetooth telephone preparation with telematics. Only with 606 / 609 and 616 and 633.																								

Key

Only with – these options must be ordered together
 Not with – these options are not available for ordering together
 / = Indicates 'or'

● = Standard ○ = Optional – = Not available

	523i SE	523i M Sport	525i SE	525i M Sport	530i SE	530i M Sport	550i SE	550i M Sport	520d SE	520d SE Business Edition	520d M Sport	520d M Sport Business Edition	525d SE	525d SE Business Edition	525d M Sport	525d M Sport Business Edition	530d SE	530d SE Business Edition	530d M Sport	530d M Sport Business Edition	535d SE	535d M Sport	Price	
Audio and communication (cont.)																								
BMW ConnectedDrive – Online 616	○	○	○	○	○	○	○	○	○	●	○	●	○	●	○	●	○	○	○	○	○	○	○	£0
WAP-based vehicle browser with access to the BMW Online portal. Services include news, with the ability to set up RSS news feeds, weather and the Google local search, a business listing search facility. Includes subscription to the services for three years (customer registration required to activate services). Please note function disabled when vehicle is in motion. Automatically included with a navigation system – 606 / 609, 612 BMW ConnectedDrive – Assist and 633 Bluetooth telephone preparation with telematics. Only with 606 / 609 and 612 and 633.																								
BMW Individual audio system 752	○	○	○	○	○	○	○	○	○	○	○	○	○	○	○	○	○	○	○	○	○	○	£1,405	
Loudspeaker system including: Nine channel amplifier with Digital Sound Processing (DSP), 16 premium speakers with Neodym magnetic drives and hexacone diaphragms, and DIRAC signal processing which enables a perfectly timed sound experience in all seats (825W). Only with 606 / 609 / 663 / 601. Not with AL / KB upholsteries.																								
BMW Professional radio with single CD player 663	○	○	○	○	○	○	○	○	○	○	○	○	○	○	○	○	○	○	○	○	○	○	£365	
Single CD player (four-channel amplifier, aerial diversity, scan function, CD drive, connection for CD changer and six loud speakers) with the additional function of twin tuners for improved reception in built up areas such as city centres. Includes MP3 playback capability. Not with 606 / 609.																								
CD changer 672	○	○	○	○	○	○	○	○	○	●	○	●	○	○	○	○	○	○	○	○	○	○	£290	
CD changer for six CDs installed behind the glovebox compartment.																								
DAB digital radio 654	○	○	○	○	○	○	○	○	○	○	○	○	○	○	○	○	○	○	○	○	○	○	£305	
Enables reception of digital audio programmes.																								

Key

Only with – these options must be ordered together
 Not with – these options are not available for ordering together
 / = Indicates 'or'

● = Standard ○ = Optional

	523i SE	523i M Sport	525i SE	525i M Sport	530i SE	530i M Sport	550i SE	550i M Sport	520d SE	520d SE Business Edition	520d M Sport	520d M Sport Business Edition	525d SE	525d SE Business Edition	525d M Sport	525d M Sport Business Edition	530d SE	530d SE Business Edition	530d M Sport	530d M Sport Business Edition	535d SE	535d M Sport	Price
Audio and communication (cont.)																							
DVD system preparation 6FA	○	○	○	○	○	○	○	○	○	○	○	○	○	○	○	○	○	○	○	○	○	○	£65
Provides all pre-wiring for Rear seat Advanced DVD entertainment system available from BMW Accessories. Price does not include the DVD system nor fitment. Please consult your BMW Dealer for details.																							
Loudspeaker system – BMW Business 676	○	○	○	○	○	○	○	○	○	○	○	○	○	○	○	○	○	○	○	○	○	○	£380
Loudspeaker system including: amplifier, two woofers, four horn-shape midrange speakers and four tweeters (180W).																							
Loudspeaker system – LOGIC7 Professional 677	○	○	○	○	○	○	○	○	○	○	○	○	○	○	○	○	○	○	○	○	○	○	£860
Loudspeaker system including: amplifier, two woofers, six horn-shape midrange speakers, one horn-shape midrange speaker as centre speaker and four tweeters. Provides truly outstanding sound quality creating a luxurious soundscape within the cabin environment. The central bass concept using sub-woofers gives a truly authentic bass reproduction (420W).																							
Navigation system – BMW Business 606	○	○	○	○	○	○	○	○	○	●	○	●	○	–	○	–	○	–	○	–	○	○	£1,335
Navigation system with 6.5" colour display screen including 663, BMW Professional radio with single CD player. DVD based 2-D map or arrow display navigation system (with TMC) and detailed coverage of Europe including hotels, petrol stations and many more points of interest. It is also recommended to specify 672, CD changer due to the CD drive being utilised by the DVD navigation disc when in use. If a telephone system is also required, 633, Bluetooth telephone preparation with telematics, 612, BMW ConnectedDrive – Assist and 616, BMW ConnectedDrive – Online must be specified. Not with 644 / 663.																							

Key

Not with – these options are not available for ordering together
 / = Indicates 'or'

● = Standard ○ = Optional – = Not available

	523i SE	523i M Sport	525i SE	525i M Sport	530i SE	530i M Sport	550i SE	550i M Sport	520d SE	520d SE Business Edition	520d M Sport	520d M Sport Business Edition	525d SE	525d SE Business Edition	525d M Sport	525d M Sport Business Edition	530d SE	530d SE Business Edition	530d M Sport	530d M Sport Business Edition	535d SE	535d M Sport	Price	
Audio and communication (cont.)																								
Navigation system – BMW Professional Multimedia	609	○	○	○	○	○	○	○	○	○	○	○	○	●	○	●	○	●	○	●	○	○	○	£1,825
Navigation system with 8.8" high-resolution flat screen colour display including 663, BMW Professional radio with single CD player. System includes iDrive Controller with shortcut buttons, 8 freely programmable Favourite buttons, a built-in hard disc for improved operation and data storage, multimedia capabilities with 12GB storage for audio files and detailed navigation map with options to enhance route planning. Includes USB data port for music/file transfer located inside glove compartment. Traffic Message Channel (TMC) is also included along with detail points of Interest for the whole of Europe. Not with 644 / 663.										○		○											£490	
TV function	601	○	○	○	○	○	○	○	○	○	○	○	○	○	○	○	○	○	○	○	○	○	○	£795
Enables reception of digital and analogue television programmes via the 8.8" colour display screen when the car is at a standstill. (Only Freeview programmes can be received.) Only with 609.																								
USB audio interface	6FL	○	○	○	○	○	○	○	○	○	○	○	○	●	○	●	○	●	○	●	○	○	○	£200
Interface for an MP3 player or USB memory stored music files. Track selection possible via iDrive controller or steering wheel multi-function buttons. Due to the location of this option, the cooling vent in the front centre armrest is deleted. Please consult your BMW Dealer for details of compatibility. An additional adaptor cable may be required.																								
Voice Control	620	○	○	○	○	○	○	○	○	○	○	○	○	○	○	○	○	○	○	○	○	○	○	£315
Enables voice activation of the majority of main functions within iDrive, for example: Navigation destination (full word recognition), radio station, CD track selection.																								
In combination with 633 / 644.		○	○	○	○	○	○	○	○	○	○	○	○	●	○	●	○	●	○	●	○	○	○	£230

Key

Only with – these options must be ordered together
 Not with – these options are not available for ordering together
 / = Indicates 'or'

● = Standard ○ = Optional

	523i SE	523i M Sport	525i SE	525i M Sport	530i SE	530i M Sport	550i SE	550i M Sport	520d SE	520d SE Business Edition	520d M Sport	520d M Sport Business Edition	525d SE	525d SE Business Edition	525d M Sport	525d M Sport Business Edition	530d SE	530d SE Business Edition	530d M Sport	530d M Sport Business Edition	535d SE	535d M Sport	Price	
Paintwork, upholstery and trims																								
Non-metallic paintwork	uni	●	●	●	●	○	○	○	○	○	○	○	○	○	○	○	○	○	○	○	○	○	○	std
																							£0	
Metallic paintwork	met	○	○	○	○	○	○	○	○	○	○	○	○	○	○	○	○	○	○	○	○	○	○	£625
																							std	
BMW Individual paintwork	ind	○	○	○	○	○	○	○	○	○	○	○	○	○	○	○	○	○	○	○	○	○	○	£1,500
																							£875	
Interior trim, Grey, high-gloss	4BX	●	–	●	–	●	–	–	–	●	●	–	–	●	●	–	–	●	●	–	–	●	–	std
Interior trim strips, centre console and door inserts in Grey plastic. Not with U6 / NA upholsteries.																								
Interior trim, Aluminium Pentan	4MS	–	●	–	●	–	●	–	–	–	–	●	●	–	–	●	●	–	–	●	●	–	●	std
Interior trim strips, centre console and door inserts in Aluminium Pentan.																							£0	
Interior trim, Black, high-gloss	4AT	○	○	○	○	○	○	○	○	○	○	○	○	○	○	○	○	○	○	○	○	○	○	£0
Interior trim strips, centre console and door inserts in Black plastic.																								
Interior trim, Brushed Aluminium	439	○	–	○	–	○	–	○	○	○	○	○	○	○	○	○	○	○	○	○	○	○	○	£230
Interior trim strips, centre console and door inserts in Brushed Aluminium.																							£0	
Interior trim, Anthracite Bamboo wood, high-gloss	4BY	○	○	○	○	○	○	○	○	○	○	○	○	○	○	○	○	○	○	○	○	○	○	£340
Interior trim strips, centre console and door inserts in Anthracite Bamboo wood. Standard trim for 550i SE and 550i M Sport. Standard trim with Exclusive Nappa leather.																								
In combination with M Sport models.		○	○	○	○	○	○	○	○	○	○	○	○	○	○	○	○	○	○	○	○	○	○	£115
In combination with U6.		○	○	○	○	○	○	○	○	○	○	○	○	○	○	○	○	○	○	○	○	○	○	£0

Key

Not with – these options are not available for ordering together
 / = Indicates 'or'

● = Standard ○ = Optional – = Not available

		523i SE	523i M Sport	525i SE	525i M Sport	530i SE	530i M Sport	550i SE	550i M Sport	520d SE	520d SE Business Edition	520d M Sport	520d M Sport Business Edition	525d SE	525d SE Business Edition	525d M Sport	525d M Sport Business Edition	530d SE	530d SE Business Edition	530d M Sport	530d M Sport Business Edition	535d SE	535d M Sport	Price
Paintwork, upholstery and trims (cont.)																								
Interior trim, Dark Poplar wood, high-gloss 438 Interior trim strips, centre console and door inserts in Dark Poplar wood, high-gloss. Standard trim for Nasca leather upholstery.		○	○	○	○	○	○	○	○	○	○	○	○	○	○	○	○	○	○	○	○	○	○	£340
	In combination with M Sport models.		○	○	○	○	○	○	○	○	○	○	○	○	○	○	○	○	○	○	○	○	○	£115
	In combination with U6 / NA.	○	○	○	○	○	○	○	○	○	○	○	○	○	○	○	○	○	○	○	○	○	○	£0
			○	○	○	○	○	○	○	○	○	○	○	○	○	○	○	○	○	○	○	○	○	○
Interior trim, Light Poplar wood, high-gloss 437 Interior trim strips, centre console and door inserts in Light Poplar wood.		○	○	○	○	○	○	○	○	○	○	○	○	○	○	○	○	○	○	○	○	○	○	£340
	In combination with M Sport models.		○	○	○	○	○	○	○	○	○	○	○	○	○	○	○	○	○	○	○	○	○	£115
	In combination with U6/NA.	○	○	○	○	○	○	○	○	○	○	○	○	○	○	○	○	○	○	○	○	○	○	£0
			○	○	○	○	○	○	○	○	○	○	○	○	○	○	○	○	○	○	○	○	○	£0
Interior trim, BMW Individual Amarone Walnut wood XE1 Interior trim strips, centre console, rear of centre console and door inserts in Amarone Walnut.		○	○	○	○	○	○	○	○	○	○	○	○	○	○	○	○	○	○	○	○	○	○	£730
	In combination with M Sport models.		○	○	○	○	○	○	○	○	○	○	○	○	○	○	○	○	○	○	○	○	○	£405
	In combination with U6 / NA.	○	○	○	○	○	○	○	○	○	○	○	○	○	○	○	○	○	○	○	○	○	○	£525
			○	○	○	○	○	○	○	○	○	○	○	○	○	○	○	○	○	○	○	○	○	£405
Interior trim, BMW Individual Red Brown Eucalyptus wood XE3 Interior trim strips, centre console, rear of centre console and door inserts in Red Brown Eucalyptus.		○	○	○	○	○	○	○	○	○	○	○	○	○	○	○	○	○	○	○	○	○	○	£730
	In combination with M Sport models.		○	○	○	○	○	○	○	○	○	○	○	○	○	○	○	○	○	○	○	○	○	£405
	In combination with U6 / NA.	○	○	○	○	○	○	○	○	○	○	○	○	○	○	○	○	○	○	○	○	○	○	£525
			○	○	○	○	○	○	○	○	○	○	○	○	○	○	○	○	○	○	○	○	○	£405

Key / = Indicates 'or'

○ = Optional

		523i SE	523i M Sport	525i SE	525i M Sport	530i SE	530i M Sport	550i SE	550i M Sport	520d SE	520d SE Business Edition	520d M Sport	520d M Sport Business Edition	525d SE	525d SE Business Edition	525d M Sport	525d M Sport Business Edition	530d SE	530d SE Business Edition	530d M Sport	530d M Sport Business Edition	535d SE	535d M Sport	Price
Paintwork, upholstery and trims (cont.)																								
Interior trim, BMW Individual Piano Black XE7 Interior trim strips, centre console, rear of centre console and door inserts in Piano Black.		○	○	○	○	○	○	○	○	○	○	○	○	○	○	○	○	○	○	○	○	○	○	£730
	In combination with U6 / NA.		○	○	○	○	○	○	○	○	○	○	○	○	○	○	○	○	○	○	○	○	○	£405
	In combination with M Sport models.		○	○	○	○	○	○	○	○	○	○	○	○	○	○	○	○	○	○	○	○	○	£525
			○	○	○	○	○	○	○	○	○	○	○	○	○	○	○	○	○	○	○	○	○	£405
Linea cloth upholstery AL	●	-	●	-	●	-	-	-	●	-	-	-	●	-	-	-	●	-	-	●	-	-	●	std
Flashlight cloth / leather upholstery GG Combination cloth/leather upholstery in Anthracite/Black. Only with M Sport models.		●	-	●	-	●	-	○	-	-	-	●	-	-	-	●	-	-	●	-	-	●	-	std
Fusion Artificial leather upholstery KB Available in Black or Beige. Not with 453 / 455 / 456 / 481 / 496.		○	-	○	-	○	-	-	-	○	-	-	-	○	-	-	-	○	-	-	○	-	-	£155
Dakota leather upholstery LC		○	○	○	○	○	○	○	○	○	○	○	○	○	○	○	○	○	○	○	○	○	○	£1,340
In combination with M Sport models.		○	○	○	○	○	○	○	○	○	○	○	○	○	○	○	○	○	○	○	○	○	○	£815
Nasca leather upholstery U6 Includes 438, Dark Poplar wood interior trim, high-gloss. 437, Light Poplar wood interior trim, high-gloss, 4BY, Anthracite Bamboo wood interior trim, high-gloss, 439, Brushed Aluminium interior trim or 4AT, Black interior trim, high-gloss can be specified as an alternative at no cost. Additionally, M Sport models can revert back to the standard interior trim, 4MS, Aluminium Pentan. Only with 453 and 459. Not with 4BX.		○	○	○	○	○	○	○	○	○	○	○	○	○	○	○	○	○	○	○	○	○	○	£1,340
In combination with M Sport models.		○	○	○	○	○	○	○	○	○	○	○	○	○	○	○	○	○	○	○	○	○	○	£0
		○	○	○	○	○	○	○	○	○	○	○	○	○	○	○	○	○	○	○	○	○	○	£815
		○	○	○	○	○	○	○	○	○	○	○	○	○	○	○	○	○	○	○	○	○	○	£0

Key

Only with – these options must be ordered together
Not with – these options are not available for ordering together
/ = Indicates 'or'

● = Standard ○ = Optional – = Not available

	523i SE	523i M Sport	525i SE	525i M Sport	530i SE	530i M Sport	550i SE	550i M Sport	520d SE	520d SE Business Edition	520d M Sport	520d M Sport Business Edition	525d SE	525d SE Business Edition	525d M Sport	525d M Sport Business Edition	530d SE	530d SE Business Edition	530d M Sport	530d M Sport Business Edition	535d SE	535d M Sport	Price
Paintwork, upholstery and trims (cont.)																							
Exclusive Nappa leather upholstery Exclusive Nappa leather – only available in conjunction with 456, Comfort Seats, front. Includes 4BY, Anthracite Bamboo wood interior trim, high-gloss. 437 / 438, Poplar wood interior trim, high-gloss, 439, Brushed Aluminium interior trim or 4AT, Black interior trim, high-gloss can be specified as an alternative at zero cost. Additionally, M Sport models can revert back to the standard interior trim, 4MS, Aluminium Pentan. Exclusive Nappa leather is available in Black or Tobacco. Only with 456. Not with 4BX.	NA	○	○	○	○	○	○	○	○	○	○	○	○	○	○	○	○	○	○	○	○	○	£2,020
In combination with M Sport models. Only with 456. Not with 4BX.		○	○	○	○	○	○	○	○	○	○	○	○	○	○	○	○	○	○	○	○	○	£1,495
																							£685
BMW Individual Extended Merino leather upholstery BMW Individual Merino leather available in Champagne, Rust Brown, Polar Grey and Amarone. Content in BMW Individual Merino leather colour: Front and rear seats, including head restraints, front seat backrests, door trim panel inserts, and armrests in doors and centre console. Includes door sill finishers with BMW Individual designation, except on M Sport models which retain the door sill finishers with M designation. Only with 775, Headlining, Anthracite, 563, Extended lighting and 473, Armrest, front with sliding adjustment [where not already standard]. Includes BMW Individual perforated Merino leather for seat when ordered in combination with 453, Seat ventilation, front.	ZA	○	○	○	○	○	○	○	○	○	○	○	○	○	○	○	○	○	○	○	○	○	£2,805
																							£2,270
																							£1,550

Key Only with – these options must be ordered together
Not with – these options are not available for ordering together

○ = Optional

	523i SE	523i M Sport	525i SE	525i M Sport	530i SE	530i M Sport	550i SE	550i M Sport	520d SE	520d SE Business Edition	520d M Sport	520d M Sport Business Edition	525d SE	525d SE Business Edition	525d M Sport	525d M Sport Business Edition	530d SE	530d SE Business Edition	530d M Sport	530d M Sport Business Edition	535d SE	535d M Sport	Price
Packages																							
Business Media package Contents: – 606, Navigation system – BMW Business – 672, CD Changer	Z5R	-	-	-	-	-	-	-	○	-	○	-	-	-	-	-	-	-	-	-	-	-	£350
Luxury package* Contents: – 323, Soft-close doors – 4xx, Wood interior trim – 459, Seat adjustment – front, electric with driver memory – LCxx, Dakota leather upholstery	Z5N	○	-	○	-	○	-	-	○	-	-	-	○	-	-	-	○	-	-	-	-	-	£2,345
Media package Contents: – 609, Navigation system – BMW Professional Multimedia – 633, Bluetooth telephone preparation with telematics – 612, BMW ConnectedDrive – Assist – 616, BMW ConnectedDrive – Online – 672, CD changer – 620, Voice Control	Z5P	○	○	○	○	○	○	○	○	-	○	-	○	-	○	-	○	-	○	-	○	○	£2,375
Visibility package Contents: – 522, Xenon headlights – 502, Headlight wash – 524, Adaptive Headlights	Z5K	○	○	○	○	○	○	○	○	○	○	○	○	○	○	○	○	○	○	○	○	○	£905

***Luxury package alternatives**

Luxury package wood interior trim can be either: 437, Light Poplar wood interior trim, high-gloss
438, Dark Poplar wood interior trim, high-gloss
4BY, Anthracite Bamboo wood interior trim, high-gloss

Dakota leather upholstery can be either: LCSW Black Dakota
LCBA Beige Dakota
LCAD Grey Dakota
LCGE Cream Beige
LCCC Cream Beige / Black
LCNG Natural Brown
LCCU Dark Blue

Key ○ = Optional – = Not available



523i SE	523i M Sport	525i SE	525i M Sport	530i SE	530i M Sport	550i SE	550i M Sport	520d SE	520d SE Business Edition	520d M Sport	520d M Sport Business Edition	525d SE	525d SE Business Edition	525d M Sport	525d M Sport Business Edition	530d SE	530d SE Business Edition	530d M Sport	530d M Sport Business Edition	535d SE	535d M Sport	Price
---------	--------------	---------	--------------	---------	--------------	---------	--------------	---------	--------------------------	--------------	-------------------------------	---------	--------------------------	--------------	-------------------------------	---------	--------------------------	--------------	-------------------------------	---------	--------------	-------

Options available from your dealer

BMW Service Inclusive	Covers the cost of labour and parts for all routine servicing for 5 years or 60,000 miles, whichever comes first. Cover includes: brake fluid, air filters, micro filters, fuel filter (diesel models only), spark plugs, oil filters, engine oil. Transferable to subsequent owners.																						
5 years / 60,000 miles	○	○	○	○	○	○	○	○	○	○	○	○	○	○	○	○	○	○	○	○	○	○	£795
																							£895
																							£920
BMW Service Inclusive Plus	Covers the cost of labour, parts and lubricants for all routine servicing and maintenance for 5 years or 60,000 miles, whichever comes first. Cover includes: brake pads, brake discs, brake sensors, brake fluid, air filters, micro filters, fuel filter (diesel models only), spark plugs, oil filters, engine oil, clutch assembly (only if worn) and wiper blade rubbers. Transferable to subsequent owners.																						
5 years / 60,000 miles	○	○	○	○	○	○	○	○	○	○	○	○	○	○	○	○	○	○	○	○	○	○	£1,645
																							£1,880
																							£2,150
BMW Trackstar	○	○	○	○	○	○	○	○	○	○	○	○	○	○	○	○	○	○	○	○	○	○	£214.34*
BMW Trackstar 5	○	○	○	○	○	○	○	○	○	○	○	○	○	○	○	○	○	○	○	○	○	○	£439.45*

Key

- / = Indicates 'or'
- = Optional
- * = Prices exclude fitment or subscription. Please consult your BMW Dealer for further details.

Services and Benefits.

Warranties

Every BMW registered is protected by a Dealer Warranty, which provides cover for 3 years' unlimited mileage. In addition, every BMW is covered by an unlimited mileage, twelve years' anti-corrosion warranty and three years' paintwork warranty.

Full details of these warranties are available from your BMW Dealer and are provided in the BMW Warranty and Emergency Service Handbook.

BMW Emergency Service

BMW Emergency Service is the only roadside and assistance programme designed specifically for BMW vehicles offering an exceptional range of benefits and services. It is available 24 hours a day, 7 days a week and utilises a dedicated fleet of BMW Approved Technicians, equipped with Genuine BMW Parts and tools, ensuring that you and your vehicle receive the best possible care in the event of any motoring emergency. This tailor-made programme has been specifically designed to meet the needs of BMW drivers travelling in the UK and Continental Europe giving complete reassurance and peace of mind. Every new BMW is covered for three years.



BMW Magazine

Every new BMW customer receives a complimentary subscription to BMW Magazine. This lifestyle publication features all the latest news and developments from BMW, including interesting interviews, sporting news, travel experiences and art stories.

Finance and Insurance from BMW.

BMW Financial Services

Chances are, you've already decided on the BMW you want to drive. Now discover the perfect finance solution to get you behind the wheel. BMW Financial Services offers a range of tailor-made finance packages to suit you and your budget.

And to help you, at every BMW Dealership, there's a Financial Services Specialist – a dedicated expert who'll find the perfect solution for you. They'll talk you through the options and help you come to the right decision.

Our comprehensive range of finance and insurance products include:

- **BMW Select (Personal Contract Purchase)**
- **BMW Hire Purchase**
- **BMW Contract Hire**
- **BMW Car Insurance**
- **BMW Home Insurance**
- **BMW Travel Insurance**

For details of your local BMW Dealer, please call 0800 325600. Further information on our finance products can be found at www.bmw.co.uk

Finance is subject to status and available to over 18's in the UK only (excludes the Channel Islands). Guarantees and indemnities may be required. Finance is provided by BMW Financial Services, Europa House, Bartley Way, Hook, Hampshire, RG27 9UF.

BMW Car Insurance

Driving a BMW shows that you refuse to compromise on the quality of your car so why should your car insurance be any different? Designed for you, BMW Car Insurance offers cover that can help give you peace of mind.

Call BMW Car Insurance today on 0870 0240 520.

Lines open 8am – 8pm Monday to Friday, 9am – 5pm Saturdays. Max call charge from a BT landline is 8p a minute. Calls from other networks may vary.

BMW Car Insurance is underwritten by UK Insurance Limited. The Wharf, Neville Street, Leeds, LS1 4AZ, which is authorised and regulated by The Financial Services Authority.

BMW ConnectedDrive.

BMW ConnectedDrive provides telematic and online services that are fully integrated with your navigation and Bluetooth telephone system. The services provide you and your passengers access to key information from within the vehicle, helping you keep safe and in touch.



Emergency 999 SOS call

The emergency SOS call provides a direct link to a 999 emergency call centre. This call can either be activated manually, or in extreme situations the sensors in the vehicle will automatically make the call and transmit your location to the emergency services. In either instance you can be assured that help can be despatched without delay.

Breakdown call

Roadside breakdown assistance is never far away because with BMW ConnectedDrive your vehicle will have a direct link to the BMW Service Centre. This link automatically provides the operator with your vehicle details and position so that a BMW Approved Technician can be despatched quickly and easily.

Information Plus

At the push of a button local information is available wherever you may be in the country, using the Information Plus service. The service is available 24 hours a day, seven days a week and connects you to an operator who will be able to quickly access the information you need. You can request places of interest, from hotels and restaurants to museums or historical attractions. The information is then sent to your car and can then be used in your navigation system to plan a route to your destination, or to make a call on your Bluetooth telephone.

My Info

As a BMW ConnectedDrive customer you will be able to access an internet website from where you, or others, can send information to your vehicle. Multiple addresses and telephone numbers can be sent to your vehicle, they can then be transferred into your navigation system or your Bluetooth telephone. Using the My Info service you can also send residential addresses or business listings via Google Maps. When you have found a place of interest or entered the address in the map, there is a send-to-car function on the website, this will send the address and telephone number to your vehicle.

Remote Services

Remote Services provides you with the facility to contact the BMW Service Centre, who can remotely lock or unlock your vehicle. You will be required to activate your vehicle and set-up your own personal security questions within the ConnectedDrive website. After you have set-up the service, should you be in a situation where you have accidentally locked your keys in the car, the BMW Service Centre will be able to unlock your vehicle. Likewise, if you are not near your car and you cannot remember if you have locked the car, our call centre can remotely lock the vehicle for you.

Extended News and Weather

BMW ConnectedDrive provides you with access to a WAP-based browser which connects to the BMW Online portal. The portal displays the latest Weather forecast and Extended News stories from categories such as World, Business and Sports News.

My News

From your BMW Online portal, My News provides you with a selection of the latest news from internet sources, which can be defined as you desire. Through these RSS news feeds, titles and short summaries of news items from websites will be visible directly in the Control Display of your BMW. This gives you quick access to your favoured news topics and enables you to keep in touch.

Google local search

With the Google local search you can access location based information via Google Maps, from the BMW Online portal in the car. Information such as hotels and restaurants can be requested at the current vehicle location, navigation destination or at any other specific location. The content is taken directly from live Google Maps information. Search results appear in a list format, the addresses can be transferred into the navigation system or the telephone number can be transferred to a Bluetooth telephone. Some search results contain additional information such as opening hours, car park details or pictures of the location.

Routes*

With Routes you have the facility to import a route with multiple stop-off points into the navigation system. BMW Routes provides a number of default routes across Europe for you to import in your car via BMW Online. My Routes allows you to configure your own routes on the ConnectedDrive website. They can be saved onto a USB memory stick and you can import them directly into your vehicle. This provides you with the facility to plan a trip from the comfort of your own home.

*Routes is only applicable to vehicles with 609 BMW Professional Multimedia Navigation system or with Z5P Media package.

BMW ConnectedDrive website

As a BMW ConnectedDrive customer you will have access to an internet website with a route planner, traffic information and text message service. The website provides a link to your vehicle by allowing you to send information to your car. You can also modify your news links for My News, or set-up Remote Services for your car. Additional services such as profile settings and a handy help page are also featured.

A three year BMW ConnectedDrive subscription is included with every vehicle equipped with an optional navigation system (606, 609 or Z5R) and Bluetooth telephone preparation with telematics (633) or with Media package (Z5P). ConnectedDrive services are included in the standard equipment for BMW 5 Series Business Edition models. In conjunction with Bluetooth telephone preparation with telematics (633), unlimited use of BMW ConnectedDrive is included within the subscription.

In the UK ConnectedDrive services require a connection to a UK mobile telephone network. Services are not available on the Isle of Man or the Channel Islands. Some services are available in other European countries, refer to your BMW dealer for more details. Terms and conditions apply.

Aftersales.

BMW Service Inclusive

Wouldn't it be good to know all your servicing costs in advance? Well, that's exactly what BMW Service Inclusive provides. Once you have decided which of the options best suits your needs, you can simply relax, and look forward to enjoying care-free driving, courtesy of BMW Service Inclusive.

BMW Service Inclusive lasts for 5 years or 60,000 miles (whichever occurs sooner), so all you need to do is decide which option suits you best. BMW Service Inclusive – covering all your vehicle's servicing requirements or BMW Service Inclusive Plus which in addition to servicing also covers maintenance items such as brakes pads, brake discs and windscreen wipers.

Furthermore, BMW Service Inclusive is transferable to subsequent owners within the time and mileage period, enhancing the resale value of your car.*

*For further information please contact your local BMW Dealer.

Genuine BMW Accessories

Your choice of car says a great deal about you. Genuine BMW Accessories allow you to make that statement even more personal. There's endless scope for personalising your BMW to suit your needs and style, with a wide range of accessories from exterior and interior styling to mobile communications, all of which have been designed to the same exacting standards as your vehicle. For further details on Genuine BMW Accessories for your BMW, please contact your local BMW Dealer.

BMW Lifestyle

The BMW Lifestyle Collection reflects the exclusivity and versatility of BMW design. This innovative product range demonstrates the highest quality in both materials and functionality. The extensive product portfolio includes clothing and accessories items such as miniatures, keyrings, leather goods, mountain bikes, kids' mobility products, golf accessories, motorsport and yachting products.

BMW 5 Series Touring

	523i Touring	525i Touring	530i Touring	550i Touring	520d Touring	525d Touring	530d Touring	535d ¹ Touring
Engine and performance								
Configuration [cylinder/valves]	6 / 4	6 / 4	6 / 4	8 / 4	4 / 4	6 / 4	6 / 4	6 / 4
Displacement [cc]	2497	2996	2996	4799	1995	2993	2993	2993
Stroke / Bore [mm]	78.8 / 82.0	88.0 / 85.0	88.0 / 85.0	88.3 / 93.0	90.0 / 84.0	90.0 / 84.0	90.0 / 84.0	90.0 / 84.0
Power output [hp]	190	218	272	367	177	197	235	286
Torque output [Nm]	240	270	320	490	350	400	500	580
Top speed [mph]	143 (142)	151 (150)	155 ⁶	155 ⁶	139 (139)	144 (144)	152 (151)	(155) ⁶
0-62 mph [secs]	8.5 (9.1)	7.4 (7.9)	6.5 (6.8)	5.3 (5.4)	8.5 (8.6)	7.8 (7.9)	6.9 (7.0)	(6.5)
Fuel consumption and emissions^{4,7}								
Urban [mpg / l/100km]	26.6 / 10.6 (26.6 / 10.6)	26.2 / 10.8 (26.4 / 10.7)	25.4 / 11.1 (25.7 / 11.0)	16.6 / 17.0 (17.5 / 16.1)	42.2 / 6.7 (36.7 / 7.7)	33.6 / 8.4 (32.8 / 8.6)	32.1 / 8.8 (30.4 / 9.3)	(30.7 / 9.2)
Extra-Urban [mpg / l/100km]	47.1 / 6.0 (47.1 / 6.0)	47.9 / 5.9 (47.1 / 6.0)	47.1 / 6.0 (48.7 / 5.8)	36.2 / 7.8 (37.7 / 7.5)	62.8 / 4.5 (60.1 / 4.7)	54.3 / 5.2 (52.3 / 5.4)	53.3 / 5.3 (53.3 / 5.3)	(50.4 / 5.6)
Combined [mpg / l/100km]	36.7 / 7.7 (36.7 / 7.7)	36.7 / 7.7 (36.7 / 7.7)	35.8 / 7.9 (36.7 / 7.7)	25.2 / 11.2 (26.4 / 10.7)	53.3 / 5.3 (48.7 / 5.8)	44.1 / 6.4 (42.8 / 6.6)	42.8 / 6.6 (41.5 / 6.8)	(40.9 / 6.9)
CO₂ emissions [g/km]	183 (184)	183 (184)	187 (184)	267 (254)	140 (154)	171 (176)	176 (180)	(182)
Emissions classification	EU4	EU4	EU4	EU4	EU4	EU4	EU4	EU4
Additional technical data								
Luggage capacity [l]	500 - 1650	500 - 1650	500 - 1650	500 - 1650	500 - 1650	500 - 1650	500 - 1650	500 - 1650
Fuel tank capacity [l]	70	70	70	70	70	70	70	70
Curb weight: DIN/EU^{2,5} [kg]	1590 / 1665	1605 / 1680	1620 / 1695	1760 / 1835	1600 / 1675	1660 / 1735	1660 / 1735	1760 / 1835
Axle unloaded ratio DIN⁵ [%]	53.1	53.0	52.8	51.7	53.8	52.4	51.8	51.1
Gross weight / Payload⁵ [kg]	2190 / 600	2205 / 600	2220 / 600	2320 / 560	2200 / 600	2260 / 600	2260 / 600	2320 / 560
Axle loaded limit⁵ front/rear [kg]	980 / 1290	980 / 1300	980 / 1300	1070 / 1300	990 / 1300	1050 / 1300	1050 / 1300	1070 / 1300
Trailer load braked^{3,5} [kg]	1600 / 1800	1800 / 2000	2000 / 2000	2000 / 2000	1800 / 1800	2000 / 2000	2000 / 2000	2000 / 2000
Trailer load unbraked [kg]	750	750	750	750	750	750	750	750
Roof load limit [kg]	100	100	100	100	100	100	100	100
Drag coefficient [cd]	0.29	0.29	0.29	0.29	0.30	0.29	0.29	0.29

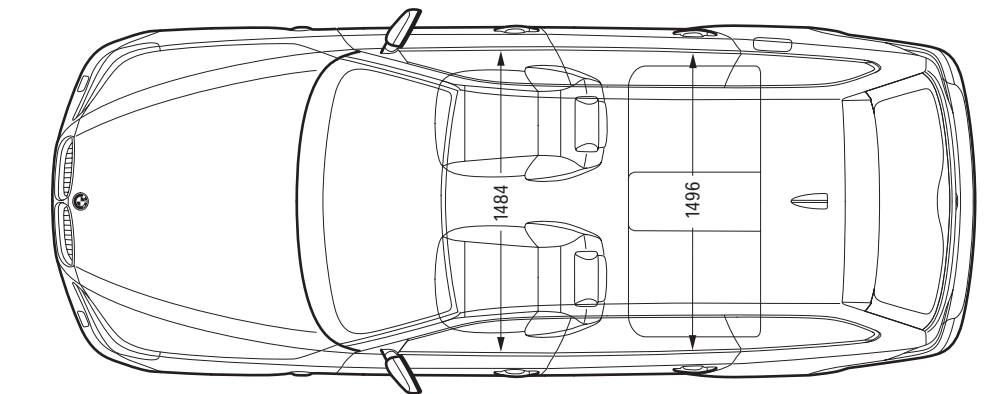
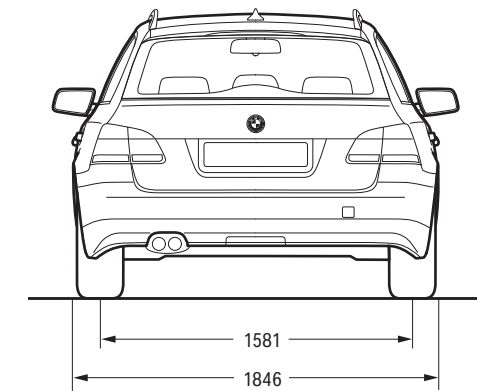
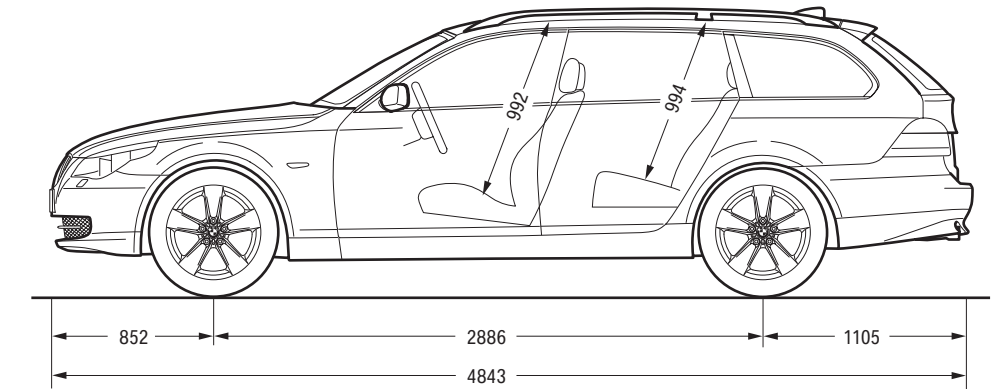
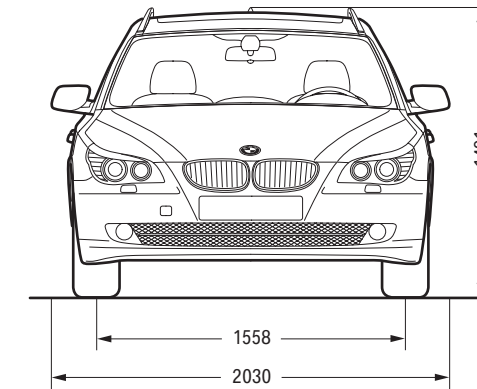

All dimensions in millimetres.

¹ Only available with automatic transmission.

² The figure quoted includes a 90 per cent tank filling, 68 kg for the driver and 7 kg for luggage. Curb weight applies to vehicles with standard equipment. Optional equipment may increase this figure.

³ The overall weight of the trailer may not exceed the maximum permissible trailer load plus the maximum permissible towbar download of 90 kg. Based on 12% / 8% gradient

⁴ The petrol engines are designed for RON 98 fuel. They may be run on fuel down to RON 91 with a slight decrease in engine power.

⁵ Figures for manual gearbox (automatic gearbox for the 535d model).

⁶ Electronically limited.

⁷ All engines meet the EU4 emissions standard. Fuel consumption is determined in accordance with the ECE driving cycle (93/116/EC) made up of approximately one third urban traffic and two thirds extra-urban driving (based on the distance covered). CO₂ emissions are measured in addition to fuel consumption. Note that fuel consumption is determined for vehicles with standard equipment. Optional equipment (such as wider tyres) can have a significant impact on fuel consumption.

Figures in () apply to cars with automatic transmission.

More about BMW

Tel. 0800 325 600
www.bmw.co.uk



**The Ultimate
Driving Machine**



This price list is printed on paper which has
been sourced from sustainably managed forests.