



Mercedes-Benz

Sprinter

Traveliner



Contents

Introduction	4
Versatility	6
Interior comforts	10
Whole life costs	14
Safety	16
Standard and optional equipment	18
Services	24
Model range, engines, technology	27
Versions, weights and dimensions	30
Glossary	34
Seat covers and paintwork	38



Sprinter Traveliner

- accommodating your every need

When it comes to carrying precious cargo like adults and children, you need a vehicle you can trust. The Mercedes-Benz Sprinter Traveliner is renowned for not only its build quality and reliable engineering but also for its safety credentials. From 7-seat to 17-seat, there's a Traveliner for your passenger transportation task. A range of heights, lengths, seating configurations, choice of engines and a host of optional extras are guaranteed to suit every one of your needs. Mercedes-Benz is a brand you can trust so trust Traveliner to accommodate your passenger transport needs.



Whatever you've planned - the Sprinter takes in its stride

Whether it's shuttling a sports team to an away match or ferrying an overseas business delegation back to the airport, the Sprinter Traveliner can be relied upon to transport your party in the utmost safety and comfort. With seating options available from seven people to an impressive seventeen, and plenty of room to store luggage, sports equipment, musical instruments or whatever else you need to carry, your passengers can sit back and enjoy the ride.

Large sliding doors and low entry height allow easy access

- ▶ Comfortable seats and plenty of legroom offer first-class travel
- ▶ Seating for 7, 9, 15 or 17 people (including the driver) and two passenger compartment heights (high roof standard on TL17)
- ▶ Spacious interior with a wide range of optional equipment to choose from
- ▶ Extensive safety equipment as standard, including Adaptive ESP®
- ▶ Comfortable work environment and easy handling

- ▶ Efficient, economical CDI diesel engines with turbocharger and intercooling
- ▶ Natural-gas (NGT) drive option available offering minimal emissions and congestion charge exemption
- ▶ ECO-Start¹ option offers fuel savings and lower CO₂ emissions

¹ Not in conjunction with NGT, automatic transmission or start-off assist



Images above show the TL9

If you like variety, you'll love the Traveliner

Flexibility is what's demanded of today's business vehicles, which is why the Sprinter Traveliner has made interior adaptability one of its top priorities. With minimal effort, all the seats can be easily removed to leave you with a huge payload capacity, enabling you to transport heavy or bulky objects without a second thought. Quick-release latches on the 7 and 9 seat variants allow the rows of two-seater or three-seater benches to be lifted out. Near-vertical interior walls and levelled-off wheel arches make optimum use of the load space. Whatever the job in hand.

- ▶ Load volume¹ from 2.2 to 5.3 m³
- ▶ Rear doors provide maximum opening angle 180° or optionally 270°
- ▶ Spare payload capacity² from 122 to 849 kg
- ▶ Sliding door with optional electric-closing aid and/or push-button electric operation

- ▶ Rear step available as an option
- ▶ Non-slip flooring in passenger compartment
- ▶ Auxiliary heater, pollen and particulate filter and front and rear air-conditioning systems optionally available

¹ Load volume calculated with all seats in passenger compartment.

² Payload includes seats, full fuel tank, driver @ 75kg and passengers @ 65kg.





Give yourself a comfortable lead

There's little to be done about today's traffic congestion and road conditions but there's plenty that can be done to smooth the ride for the driver. The Sprinter sets new standards in driver comfort with a fully adjustable seat and an instrument panel that takes design, materials quality and ergonomics to new levels. With high standards of operating ease combined with plenty of space and a range of practical, innovative extras available, you're very much in the driving seat.



Joystick-style gear lever within easy reach of the steering wheel, provides optimum comfort and control for the driver.

Contemporary finished dashboard. Provides plentiful, safe stowage and ready access to heat and ventilation controls.

Optional electrically operated wing mirrors and driver & passenger windows all within easy reach.

- ▶ Generous accommodation for all occupants and uncluttered floor layout
- ▶ Driver's seat with extensive adjustment capabilities
- ▶ Low interior noise
- ▶ Multi-way adjustable and multi-function steering wheel with trip computer available as an option
- ▶ Handy joystick-style gear lever
- ▶ Electric windows for driver and front passenger
- ▶ Three cup holders and two 1.5 litre bottle holders
- ▶ Powerful heating and ventilation system
- ▶ Optional Parktronic parking aid (front and rear) that delivers an audible signal and visual display in the exterior mirror and the instrument panel
- ▶ Large selection of audio equipment, including navigation system
- ▶ Central locking with remote control as standard
- ▶ 6-speed manual transmission including optional start-off assist (5-speed automatic transmission available as an option)
- ▶ Generous storage for a neat and tidy cab

Even in the rear, comfort doesn't take a back seat

When your business is focused on passenger transport, then customer comfort, safety and service are key factors to success, so it's good to know that the Sprinter provides first-class travel for your passengers, no matter where they sit. The comfortably upholstered seats offer good lateral support and each seat is fitted with 3-point seat belts and head restraints as standard. A light, spacious and airy atmosphere throughout completes the relaxing passenger experience.

- ▶ Contemporary patterned fabric/leatherette upholstery is both durable and tactile
- ▶ Easily accessible through sliding door measuring up to 1.30 m wide by 1.82 m high (depending on body length and roof height)
- ▶ Three-point seat belts and head restraints fitted as standard on all seats
- ▶ Large windows provide maximum visibility and light
- ▶ Privacy tinted windows available in rear passenger section as an option
- ▶ Passenger compartment air conditioning option provides additional climate control



Image shows the TL9



Convincing on the road – and on the balance sheet

The Sprinter regularly tops the table for lowest cost of ownership because of its excellent fuel economy, exceptional build quality, exemplary design, long service intervals, good resale value and state-of-the-art engines. Mercedes-Benz is driven towards optimizing the efficiency of its drive systems but not at the expense of performance and offers numerous innovations to deliver this, from maintaining traction in difficult conditions to reducing environmental impact.



At the first sign of wheel spin on slippery surfaces the Sprinter's acceleration skid control intervenes to ensure smooth start-off and acceleration.

Optional selectable or permanent all wheel drive delivers maximum traction on challenging terrain.

The Traveliner's excellent suspension and chassis set-up ensure smooth rides, even over rough surfaces or difficult conditions.

- ▶ Economical four-cylinder CDI diesel engines with Piezo injectors and diesel particulate filter as standard
- ▶ ECO-Start¹ engine-start function reduces both fuel consumption and emissions in stationary traffic
- ▶ Optional all-wheel drive² incorporating Adaptive ESP[®] and electronic traction system 4ETS (7 and 9 seat variants)
- ▶ Natural gas technology (NGT) and petrol drive option offers long operating range, minimal emissions and congestion charge exemption
- ▶ The ASSYST maintenance computer plays a key role in reducing overall maintenance costs. It allows for flexible, application-oriented oil-change intervals of typically 24,000 miles/40,000 km (18,000 miles/30,000 km for NGT) or every two years, whichever comes first. Extended intervals are also possible depending on load intensity and driving style
- ▶ 12-year corrosion perforation warranty
- ▶ Easy access to maintenance points
- ▶ Wide side rub strips to prevent minor damage
- ▶ Substantial load volume and high payload for economical transportation

¹ Not in conjunction with NGT, automatic transmission or start-off assist

² Available in selected variants. Consult your Mercedes-Benz dealer for details

Your safety is a crucial commodity

There's no such thing as too much safety and the Sprinter offers the driver and passengers the highest protection of any vehicle in its class. For example, every Traveliner is fitted with Adaptive ESP® as standard. This intuitive system measures the vehicle's load so that should it lose traction on slippery surfaces or be forced to brake suddenly, the optimum grip will be applied automatically to maintain control. This is just one of the many active and passive safety features where the Sprinter sets new standards.

- ▶ Electronic Stability Program (Adaptive ESP®), anti-lock braking system (ABS), acceleration skid control (ASR), Brake Assist (BAS) and Electronic Brake force Distribution (EBD) all fitted as standard
- ▶ Driver airbag standard with airbags for front seat passengers and windowbags and thorax bags available as options
- ▶ Three-point seatbelts fitted to all seats, with belt tensioners for driver and front passenger
- ▶ Height adjustable head restraints standard on all seats (integrated on TL15 and TL17)
- ▶ Efficient brake system for optimised braking performance
- ▶ Both exterior mirrors have integrated wide-angle auxiliary mirrors for maximum visibility
- ▶ Standard bulb failure indicator and optional tyre pressure monitoring system
- ▶ Optional bi-xenon headlamps with Add-Light System and cornering light function
- ▶ Optional light and rain sensor
- ▶ Central locking with remote control
- ▶ Strong integrated steel bodies with 'Safety-Cell' design
- ▶ Safety package of fire extinguisher and first aid kit on TL15 and TL17 as standard
- ▶ Optional rear camera in combination with 7-inch monitor to make reversing and manoeuvring easier (can also be displayed via COMAND)



Optional rain sensors keep the driver one step ahead of inclement weather.



Optional automatic tyre pressure monitoring provides advance warning to the driver of possible imminent tyre failure.



Air bags – optional window and even thorax bags can provide additional safety to driver and front-seat passenger airbags (shown activated for illustrative purposes only).

Make life easier for yourself

All Traveliners are comprehensively equipped with standard features to make each journey safe, easy and comfortable but Mercedes-Benz also offers a whole host of optional extras to make the path so much smoother.



○ **Height and reach adjustable steering wheel**

Extensive adjustment capabilities ensure drivers of different builds can quickly and easily find the optimum driving position.

● **Power-assisted steering**

Effortless manoeuvring out on the road.



● **Head restraints on all seats**

Comfortable leatherette-trimmed head restraints with four-way adjustment fitted as standard on TL7 and TL9, integrated into seat design on TL15 and TL17.



● **Comfort seats**

Modern seat design offers maximum support and comfort. Option available to adjust both cushion angle and lumbar support.



○ **Driver and passenger armrests**

Angle-adjustable armrests on the driver's seat enhance comfort and relaxation.



● **Cockpit storage**

Numerous stowage facilities, including several cup holders, allow for a clean and tidy cabin.



● **Lockable glove compartment**

A lockable, illuminated glove compartment provides secure space for storing documents and personal items.



○ **ECO-Start*; cutting costs and emissions**

By flicking a switch, an automatic engine-start function is activated that stops the engine in stationary traffic and restarts it when the clutch is depressed, thus reducing fuel consumption, noise and exhaust emissions. Available on vehicles with four-cylinder CDI diesel engines and manual transmission.

* Not in conjunction with automatic transmission or start-off assist



○ **Sliding window in sidewall/sliding door**

High-quality sliding windows can be fitted to either the left or right side of the vehicle for additional ventilation (not available on TL15 or TL17).



○ **Illuminated exits**

Provides safe entry and exit even in the dark. Standard on TL15/TL17.



● **Heating/cooling air duct to passenger compartment**

An additional air outlet is fitted in front of the first row of seats in the rear section delivering hot or cool air to the passenger compartment, as required (TL7/TL9 only).



○ **Electrically operated sliding door**

This feature allows the passenger compartment sliding door to be opened and closed in approximately five seconds at the push of a button. Safety features include an overload protection/obstruction sensor system and a childproof lock (TL7/TL9 only).



● **Seating arrangements for passenger compartment**

All depending on which version of the Traveliner is selected then single seats, or two or three seater benches are fitted in the passenger compartment to maximize the space and allow for quick and easy embarking/disembarking.



● **Safety package**

In accordance with Schedule 6 Minibus Regulations, the TL15 and TL17 both come with a fire extinguisher, first aid kit and legal signage* as standard.

* Excluding exterior markings showing unladen weight and operator name and address, which must be applied by the selling dealer at additional cost.



○ **Improved side illumination**

Bi-xenon headlamps with Add-Light System and cornering light function provide better illumination of the area directly to the side of the vehicle, very useful on tight bends, at junctions and whilst manoeuvring.



○ **Chrome radiator grille**

A chrome radiator grille with the distinctive Mercedes-Benz marque adds a dynamic, elegant note to the front of the vehicle.



● **Twin rear doors**

The symmetrical hinged rear doors open to 180° (or optionally 270°) to provide easy access for storing luggage or equipment. In the case of the TL15 and TL17, emergency exit from the rear passenger section can be gained via the rear doors.



○ **Alloy wheels**

Traveliners have the option of alloy wheels to add a sporty, elegant touch.



○ **Mounting rails for roof racks**

Two rails recessed into the roof allow roof racks, roof boxes and other roof systems to be fitted.



● **Nets in rear doors**

Additional storage space for a variety of items.



- **COMAND APS navigation system**
Integrates a variety of functions such as the radio, CD player, telephone with address book and navigation function into a single, compact unit with a clearly organised colour display. Navigation functions can be operated from the multifunction steering wheel. The relevant information appears both in the system display and also in the central display unit in the instrument cluster, where it can be easily read by the driver.



- **Air conditioning**
Temperature controllable air conditioning in the cabin with Tempmatic.



- **Rear Air conditioning**
Air conditioning system fitted to the passenger compartment roof, operated by controls in the instrument panel, provides optimum climate control for the comfort and well-being of passengers.



- **Electric closing aid for sliding door**
Eases the process of closing the passenger-compartment sliding door, particularly when the vehicle is parked facing uphill. The door can simply be slid to the contact position, at which point the closing aid pulls it to the fully closed position, almost silently and without jolting or jarring (TL7/TL9 only).



- **High roof**
Ample standing room is available with the high roof option (standard on TL17) that gives 1.9m of interior height.

Further equipment

Interior

- Cab floor lined with insulating matting and non-slip rubber surface
- Indicator lights for direction indicators, main beam headlamps, charging current, oil level, coolant level, brake fluid and brake pads
- Instrument cluster with clock display
- Leatherette upholstery
- Lockable glove compartment
- Passenger compartment sidewall trim to waist level
- Rev counter
- Spacious, open stowage shelf above windscreen

Exterior

- Hinged rear doors opening to 270° (180° standard)
- Light-alloy wheels
- Metallic or other non-standard solid colour paint finishes
- Rear windscreen wiper
- Step (rear door)
- Trailer coupling
- Trailer socket (13-pin)

Comfort and convenience

- Central locking with remote control
- Convenience lighting in passenger compartment
- Courtesy lighting for driver/front passenger doors and sliding passenger-compartment door
- Driver seat adjustable for height, angle and lumbar support
- Electric rear vent windows

- Electrically adjustable and heated exterior mirrors
- Finely adjustable heating and ventilation system with four-stage blower and two fresh-air outlets
- Grab handles at entry points (TL15 and TL17 models also have grab handles on passenger backrests)
- Heated seat for driver
- Heating air duct to passenger compartment TL7/TL9
- Multi-function steering wheel with trip computer
- Multi-way driver's seat adjustment for a relaxed seating position
- Parktronic parking and manoeuvring aid
- Power-assisted rack-and-pinion steering
- Power windows
- Radio and communication systems:
 - – "Sound 5" radio with CD player
 - – "Sound 20" radio with CD player
 - – COMAND control and display system
- Rear air conditioning (only in conjunction with front air conditioning)
- Rear camera in conjunction with 7-inch monitor (can also be displayed via COMAND)
- Sliding window in passenger compartment (TL7/TL9)
- Start-off assist (for models with manual transmission)
- Steering wheel adjustable for height and reach
- Tempmatic thermostatically controlled air conditioning
- Three-point seat belts and four-way head restraints on all seats (integrated head restraints on TL15 and TL17)
- Tinted glass (all round)

Technology

- All-wheel drive, selectable or permanent (TL7 and TL9)
- ASSYST service interval indicator
- Five-speed automatic transmission
- Speedtronic variable speed limiter
- Tachograph (standard in TL15 and TL17*)

Safety/chassis

- 16-inch tyres, 235/65 R 16
- Airbag (driver's side)
- Airbag (front passenger)
- Bi-xenon headlamps with Add-Light System and cornering light function
- Electronic anti-theft alarm system with interior monitoring and tow-away protection
- Electronic Stability Program (Adaptive ESP®) in conjunction with ABS, acceleration skid control (ASR), Electronic Brake force Distribution (EBD) and Brake Assist (BAS)
- Front fog lamps (halogen)
- Front and rear stabilisers
- Headlamp cleaning system
- Headlamp range adjustment
- Heated rear window (TL7/TL9)
- Heated windscreen with rain sensor
- High level rear brake lights
- Independent front suspension
- Laminated front windscreen
- Light and rain sensor
- Thorax bags for driver and front passenger
- Three-point seat belts on all seats, with belt tensioners for driver and front passenger
- Window bags for driver and front passenger

● Standard equipment ○ Optional equipment

*Traveliner TL15 and TL17 models are fitted as standard with a digital tachograph. In order to comply with legal regulations the tachograph must have an initial calibration carried out by an approved tachograph centre. The costs for this work are not included in the basic List Price of the vehicle. Where a tachograph is not required it can be deleted from the vehicle standard specification using Sales Code J92 at time of order for a credit price.

Our services. Professional in every respect

Investing in the right minibus for your organisation is a tough decision so it's reassuring to know that Mercedes-Benz is committed to being onboard with you for the whole journey, from identifying the best vehicle configuration to arranging servicing. Your Mercedes-Benz commercial vehicle dealer will happily provide you with detailed advice on services such as recovery packages, leasing, financing and insurance options and much more besides.

Services provided with the vehicle

- ▶ The Sprinter Traveliner, including seating, is covered by a 3-year unlimited mileage warranty with repairs carried out by the dealer network
- ▶ With around 2600 service outlets, Mercedes-Benz has one of Europe's most concentrated service networks for commercial vehicles
- ▶ Service24h; access to help around-the-clock in almost every European country. Call the service hotline: 00800 1 777 7777
- ▶ Assured mobility for new vehicles for two years with MobilityGo¹ in addition to statutory warranty package
- ▶ Genuine Mercedes-Benz spare parts
- ▶ 12-year corrosion perforation warranty²
- ▶ Free service package that covers parts, labour and lubricants for 5 years / 60,000 miles (whichever is sooner)

Additional services available as an option

- ▶ Service contracts tailored to your specific requirements
- ▶ Packages are available to expand or extend your warranty status
- ▶ Certificate of initial fitness (COIF) on TL15 and TL17 can be arranged where required

Financial services and CharterWay

- ▶ Attractive and individual leasing, financing and insurance models
- ▶ Insurance protection for both the vehicle and the finance

¹ The area of validity covers all EU member states, Iceland, Liechtenstein, Norway and Switzerland

² In accordance with our terms and conditions, the area of validity covers virtually every country in Europe





Technical data

	Diesel engines				Natural-gas ¹
Models	311CDI	313CDI	315CDI	316CDI	316NGT
Seating capacity (including driver)	7/9	15/17	7/9	15/17	7/9
Fuel type	Diesel				Natural Gas/Petrol
Emission compliance	EU4	Euro 5	EU4	Euro 5	EU4
4x2 drive system	Y	Y	Y	Y	Y
4x4 drive system	Y	N	Y	N	N
No. of cylinders	4 cylinder in-line				4 cylinder in-line
Displacement (cm ³)	2148	2143	2148	2143	1796
Power output (hp)	109	129	150	163	156
at engine speed (rpm)	3800				5000
Torque output (Nm)	280	305	330	360	240
at engine speed (rpm)	1600-2400	1200-2400	1800-2400	1400-2400	3000-4000
Transmission - Standard	6-Speed Manual				5-Speed Automatic
Transmission - Optional	5-Speed Automatic				-
Fuel tank capacity standard/optional (litres)	75/100				100/15
Gas tank capacity standard/optional (kg)	-				18/33
Fuel system	Electronically controlled direct injection with common-rail, turbocharger and charge-air cooling				Electronically controlled fuel injection with supercharger and charge air cooling
Battery (V/Ah)	12/74	12/100	12/74	12/100	12/100
Alternator (V/A)	14/180				14/150
Gross Vehicle Weight GVW (kg)	3500	3880/4000	3500	3880/4000	3500
Gross Train Weight GTW (kg)	5500	5880/0	5500	5880/0	5500

Fuel consumption with manual transmission - CDI Models					
Urban (mpg)	23.1	26.9	25.9	28.3	-
Extra-urban (mpg)	34.4	38.7	37.1	39.8	-
Combined (mpg)	29.1	33.6	32.1	34.9	-
CO2 Emissions Combined (g/km)	256	222	232	214	-

Fuel consumption with automatic transmission - NGT Models					
Natural Gas - Urban (kg/100km)	-				12.0
Natural Gas - Extra-urban (kg/100km)	-				6.8
Natural Gas - Combined (kg/100km)	-				8.7
Natural Gas - CO2 Emissions Combined (g/km)	-				238

Fuel consumption with automatic transmission - NGT Models					
Petrol - Urban (mpg)	-				17.9
Petrol - Extra-urban (mpg)	-				27.9
Petrol - Combined (mpg)	-				23.3
Petrol - CO2 Emissions Combined (g/km)	-				289



The Sprinter Traveliner

- overview

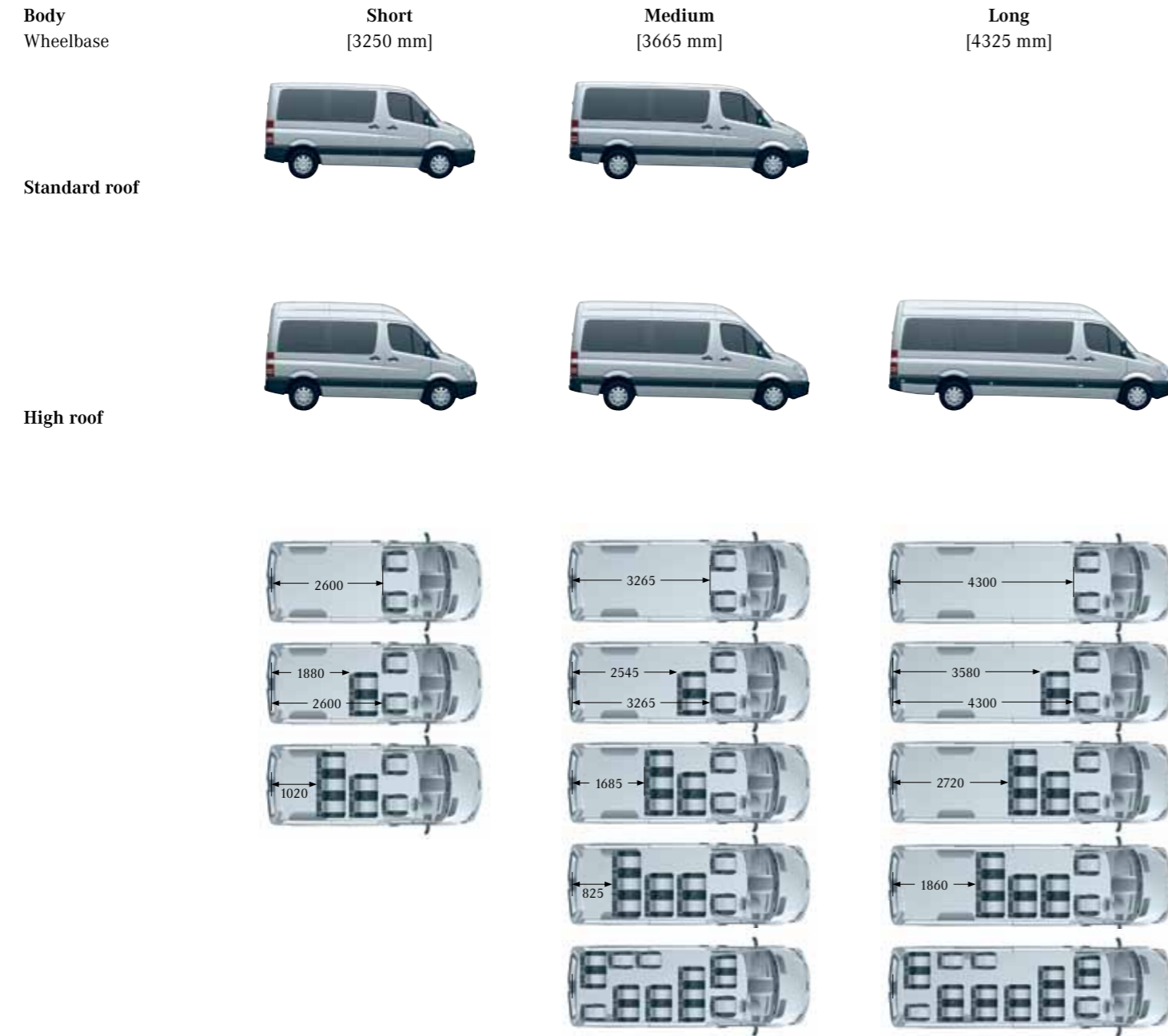

Short Sprinter Traveliner

Standard roof

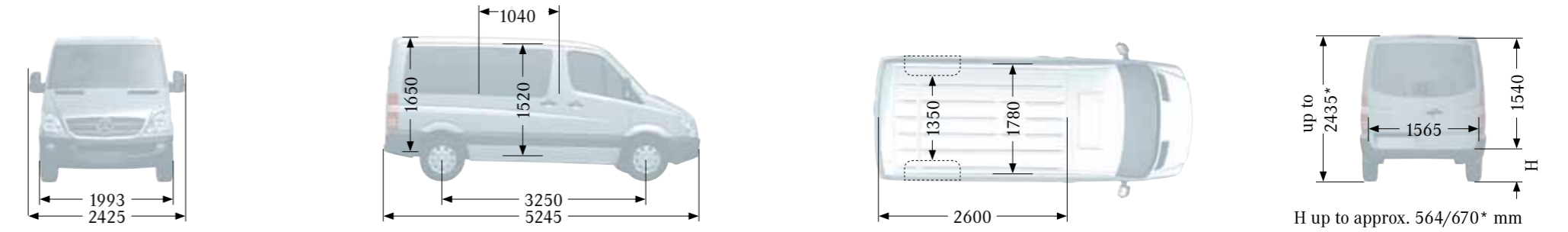

High roof

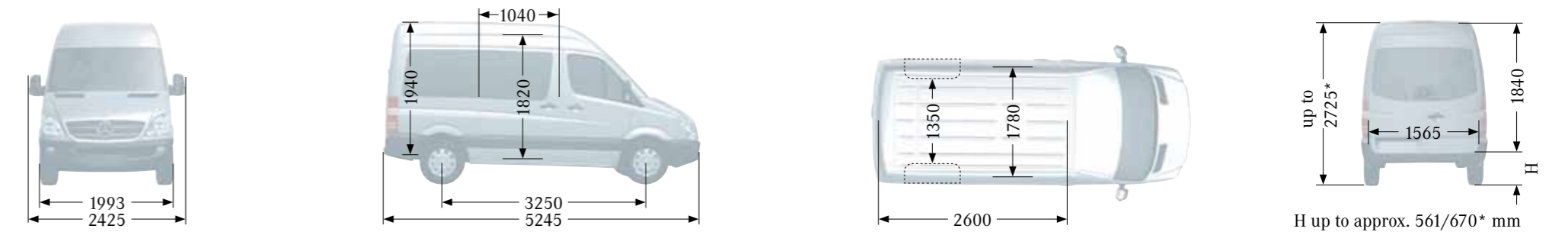

*Unladen
 All figures in mm. All dimensions for standard-specification vehicles
 All-wheel drive increases the height of the vehicle by up to 90 mm

Medium Sprinter Traveliner

Standard roof

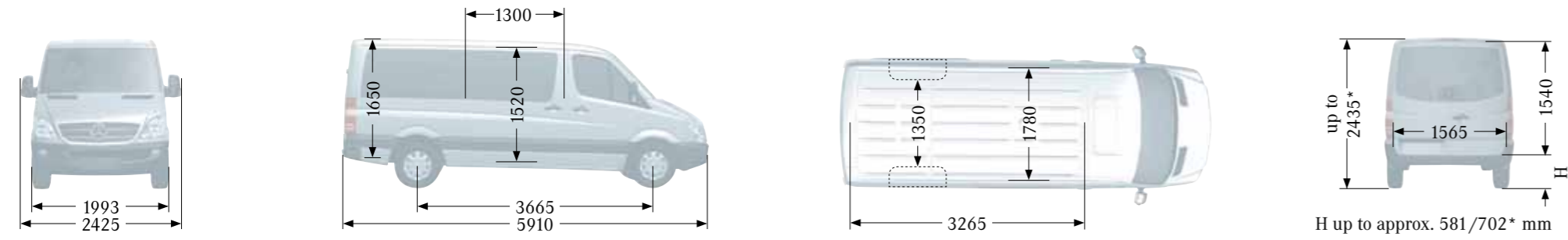

High roof

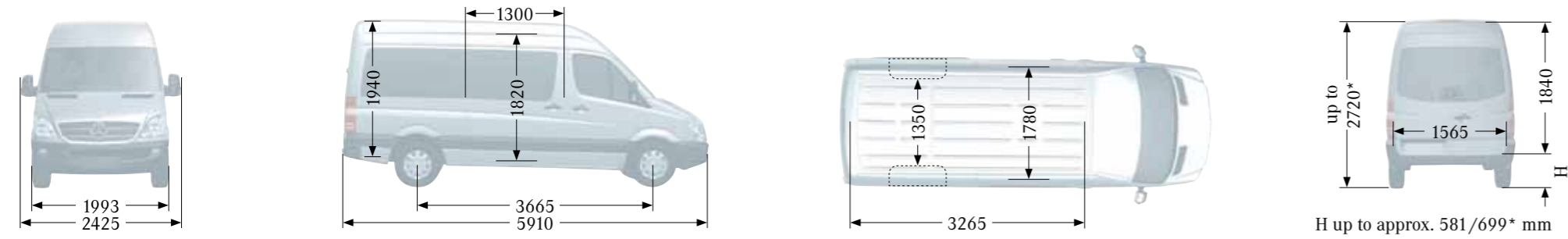

*Unladen
All figures in mm. All dimensions for standard-specification vehicles
All-wheel drive increases the height of the vehicle by up to 85 mm

Long Sprinter Traveliner

Standard roof

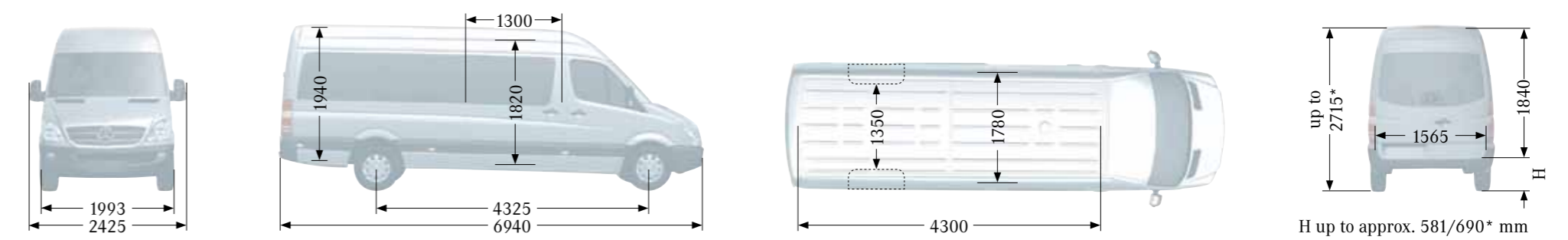

*Unladen
All figures in mm. All dimensions for standard-specification vehicles
All-wheel drive increases the height of the vehicle by up to 60 mm

Glossary

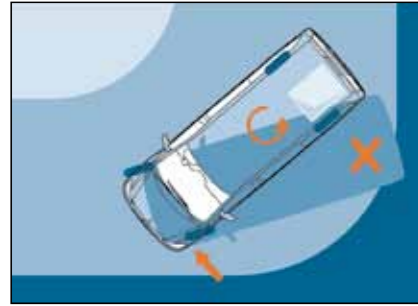

Adaptive ESP® Electronic Stability Program

Adaptive ESP® is an innovative dynamic handling control system which automatically accounts for vehicle load. It actively intervenes in potentially hazardous driving situations, e.g. by applying a specific braking force to individual wheels and adjusting the engine output as required. These measures help

the driver stabilise the vehicle. As well as aiding directional stability, Adaptive ESP® combines the functions of the anti-lock braking system (ABS), acceleration skid control (ASR), Electronic Brake force Distribution (EBD), Brake Assist (BAS) and the optional start-off assist system (AAS).

Caution:

Adaptive ESP® can only act within the laws of physics. It is therefore impossible for Adaptive ESP® to prevent skidding caused by aquaplaning, for example. If the driver exceeds physical limits, even Adaptive ESP® will not be able to prevent an accident

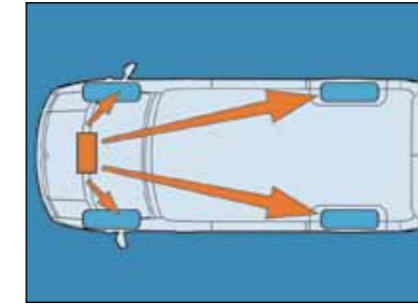

Electronic Brake force Distribution (EBD)

Electronic brake force distribution proportions the braking force between the front and rear wheels as required, in order to optimise braking efficiency in all driving situations. In this way the system prevents “overbraking” of the rear wheels, which could cause the tail to start sliding. At the same time EBD puts less stress on the front brakes, which reduces the risk of fading due to overheating.

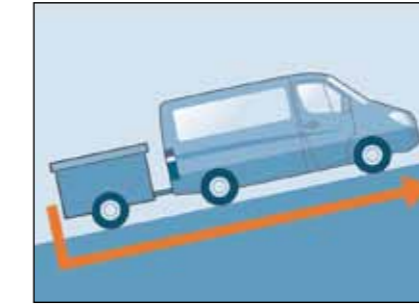

Start-off assist

Start-off assist makes it easier to move off on uphill or downhill slopes. Once the brake pedal has been released, the brake pressure is maintained for approximately two seconds, thus allowing the driver to move his or her foot to the accelerator pedal without having to worry about the vehicle rolling backwards or forwards. The brake pressure is immediately reduced as soon as start-off assist detects that the driver wishes to move off.

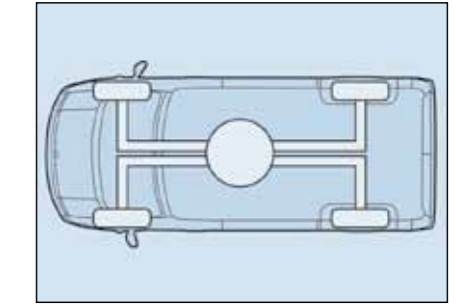

Automatic tyre pressure monitoring

The automatic tyre pressure monitoring system can help to prevent tyre failure, which might have serious consequences. It works by measuring the pressure and temperature at the valves of the four tyres in baseline condition and under changing conditions. Aerials in the wheel arches pick up radio signals carrying the data and relay them to the control unit. The system is able to provide automatic notification of a significant loss of tyre pressure so that the driver can take the appropriate action.



Anti-lock braking system (ABS)

The anti-lock braking system prevents the wheels from locking during braking. Speed sensors continuously monitor the speed of each wheel. If a wheel is on the point of locking, the brake pressure at that wheel is immediately reduced. When the danger of locking has been averted, the pressure is increased again. In this way, ABS helps the driver to maintain steering control of the vehicle, even during emergency braking. When ABS is in operation, the driver feels a slight pulsing in the brake pedal.

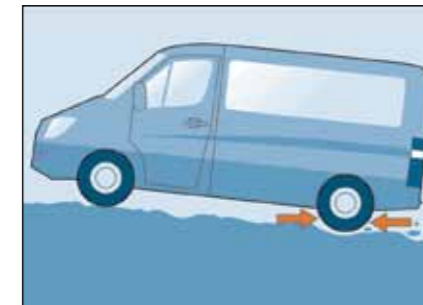

Acceleration skid control (ASR)

At the first signs of wheel spin, i.e. if the rotational speed of one of the drive wheels suddenly increases, ASR intervenes in the engine management to reduce engine power and also in the braking system to prevent wheel spin. ASR ensures smooth start-off and acceleration, without wheel spin or sideways drift. The result is improved traction and safety, particularly on split-friction or slippery surfaces.

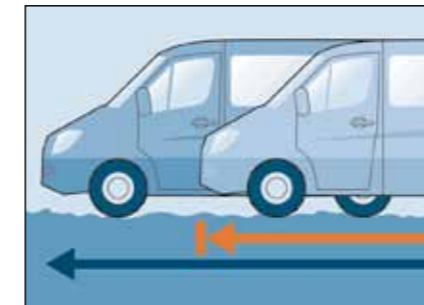

Brake Assist (BAS)

In tests carried out in driving simulators, Mercedes-Benz research engineers established that drivers do not apply the brakes vigorously enough during emergency braking. This finding led them to develop brake assist. From the speed at which the brake pedal is depressed, BAS is able to detect a situation where emergency braking is required. In such a situation the system automatically increases braking power, aided by ABS system (which prevents the wheels from locking).



Driver and front passenger airbags

A driver airbag and front passenger airbag are additional components of the passive safety system. They provide enhanced protection for the belted front-seat occupants in a severe frontal collision and act together with the seat belts and belt-force limiters as a supplementary restraint system.

Caution:

Front airbags in no way diminish the need for occupants to fasten their seat belts correctly at all times. An airbag can only develop its protection potential for a correctly restrained occupant.



Windowbags and thorax bags

The Sprinter can be equipped with driver and front passenger windowbags and thorax bags to complement the front airbags. In a severe side impact, the windowbag serves to increase the degree of protection available for the head of the occupant on the impact side. It deploys in the area of the side windows. Housed in the outside bolsters of the seat backrests, thorax bags are designed to provide increased protection for the thorax of the seat occupant.

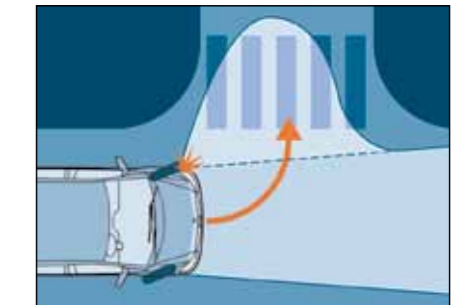

Bi-xenon headlights with Add-Light System and cornering light function

Conventional headlights fail to provide sufficient illumination of the area to the side immediately ahead of a vehicle. This is particularly true on tight bends, at junctions and when manoeuvring. In situations like these, the illumination from the low-beam headlights is complemented by an additional light source, the Add-Light System with the cornering light function. The Add-Light System operates when cornering at speeds up to 40 mph, while the cornering light function is activated when the direction indicator is operated at speeds up to 25 mph. Activation of these systems is linked to the steering angle.

Glossary



Parktronic

The Parktronic parking aid assists the driver when parking and manoeuvring with little room to spare. The system, which operates on the echo sounder principle, automatically warns the driver if it detects that the vehicle is close to an obstacle in front of or behind the vehicle. The warning is provided initially in the form of a visual display in the centre of the instrument panel (when moving forward) and in the exterior mirror (when reversing). If the gap continues to decrease, an audible warning is also activated.

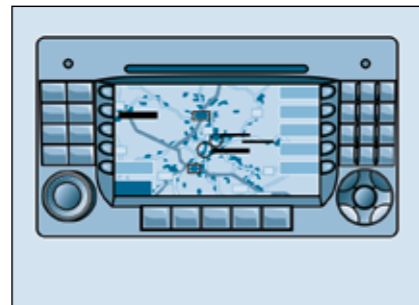

COMAND APS navigation system

Integrates a variety of functions such as the radio, CD player, telephone with address book and navigation function into a single, compact unit with a clearly organised colour display. Navigation functions can be operated from the multifunction steering wheel. The relevant information appears both in the system display and also in the central display unit in the instrument cluster, where it can be easily read by the driver.

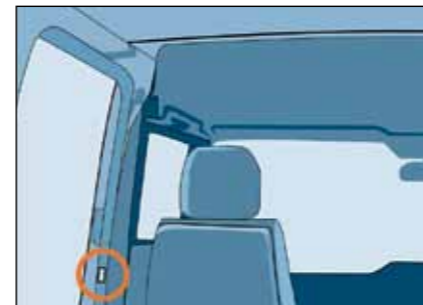

Electrically operated sliding load compartment door

This comfort and convenience feature allows the sliding door on the right or left side of the load compartment to be opened and closed electrically at the touch of a button. Safety is the primary consideration: if the opening or closing action is interrupted between the two end points, the door stops wherever it is. Also includes an overload protection/obstruction sensor system.

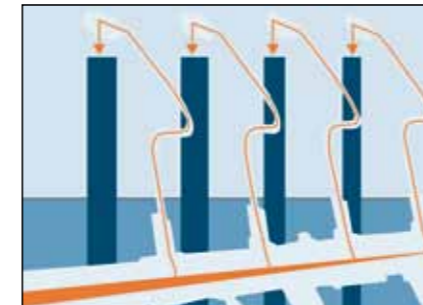

CDI diesel engines

The Sprinter range features diesel engines with the latest generation of CDI technology. All critical exhaust emissions comply with the EURO limits. After-treatment of exhaust gases is handled by oxidation catalytic converters and diesel particulate filters.



ECO-Start automatic engine-start function

Once the driver has activated the system whilst the engine is running, the system switches off the engine automatically under certain conditions as soon as the vehicle has been stationary for more than three seconds without a gear being engaged or the clutch pedal being pressed. If the clutch is pressed or the vehicle starts moving, the engine is started again automatically.

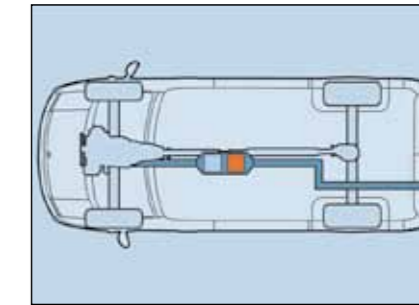

Diesel particulate filter

The new diesel particulate filter from Mercedes-Benz eliminates over 95% of particulate emissions. This brings the engines well below the legal limit and puts them on a par with petrol engines. A continuous regeneration process prevents the filter from becoming clogged and thus dispenses with the need for fuel additives.



Electric closing aid

The electric closing aid assists the user when closing the sliding door on the right or left side of the load compartment. This feature, which comes into operation shortly before the door reaches its end position, is particularly helpful when the vehicle is parked on an uphill slope and greater force is required to close the sliding door. The electric closing aid is already integrated in the scope of the electrically operated sliding load compartment door feature, which is available as special equipment.

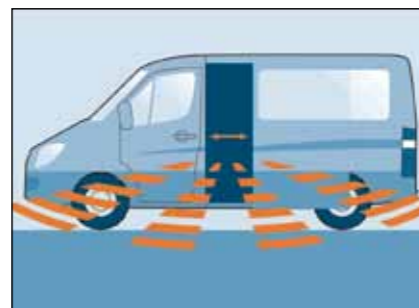

Keyless entry & slide

This driver recognition and door opening/locking system was specially developed for parcel delivery services and similar applications. With the system activated, the direction from which the driver approaches the vehicle determines whether the sliding door of the load compartment is opened automatically or the driver's door is unlocked automatically. Triggering of either response occurs once the driver approaches to within about 5 metres. If the driver moves away from the vehicle, the sliding door of the load compartment closes automatically and the vehicle is locked automatically.



Four-way head restraints

Both the height and angle of these head restraints are adjustable. The enhanced adjustment capabilities provide increased comfort. (Not available on TL15 or TL17.)

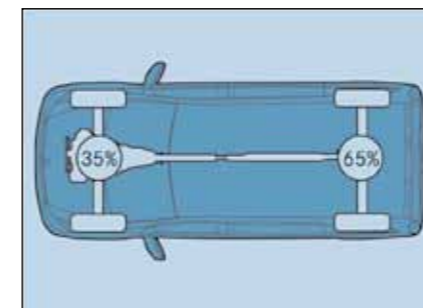

All-wheel drive

The all-wheel-drive system transfers the engine power to the front and rear axles on a 35 : 65 basis. Mechanical locking-differentials are replaced by the electronic traction system 4ETS. This automatically applies brake pressure to individual, spinning wheels, while simultaneously increasing the torque to wheels with adequate traction. This results in enhanced traction and stability in many situations: on ice, snow or wet leaves, on poor roads, in the wet or when towing a trailer.



Three-point seat belts on rear seats.

Three-point seat belts are a key safety feature, helping to restrain occupants in their seats. The Sprinter Traveliner is equipped with three-point seat belts for all of its seats.

Caution:

Never drive without your seat belt correctly fastened!

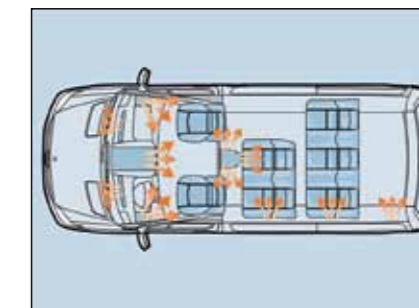

Ventilation comfort

Air outlets in the instrument panel and an additional outlet in front of the first rear seat row provide good air circulation to all seats. In conjunction with a powerful ventilation system, they ensure passenger comfort and well-being particularly on long journeys and in high ambient temperatures. For further enhanced ventilation comfort, a front air-conditioning system and a choice of rear air-conditioning systems are available.

Upholstery and paintwork

Appearance and finish matter a great deal when you're transporting people and neither the high-quality, durable upholstery fabrics, nor the polished paintwork finishes will disappoint on the Traveliner. The upholstery is easy to care for and adds an understated visual elegance to the interior.



► **"Lima" fabric upholstery, black**
This hard-wearing, dirt-resistant and flame-retardant upholstery is fitted as standard in the Traveliner.



► **Leatherette upholstery**
The optional black leatherette upholstery is particularly easy to care for.



arctic white



calcite yellow



hibiscus red



*jasper blue metallic**



velvet red



aqua green



steel blue



*carbon black metallic**



vanda blue



*brilliant silver metallic**



*amber red metallic**

The standard and metallic* paint finishes shown here are just a few of the options available for your Sprinter.

*Metallic paint finishes are optionally available at additional cost

Take-back of end-of-life vehicles. Coming full circle. After a long service life, you can return your Sprinter to us for environmentally compatible disposal in accordance with the EU End-of-Life Vehicles Directive. But that day lies a long way off. The take-back of end-of life vehicles applies to vehicles up to 3.5 tonnes gross weight in accordance with national regulations. The Sprinter has met the requirements governing the suitability of a vehicle's design for reuse and recycling for a number of years now. A network of vehicle take-back depots and dismantlers has been established to process your vehicle in an environmentally compatible manner. The ways in which both vehicles and parts can be recovered are subject to ongoing development and improvement. Consequently, the Sprinter will be able to comply with any future increases in the recycling quota within the stipulated time limits. Further information is available from www.mbvans.co.uk

Please note: changes may have been made to the product since this brochure went to press (September 2009). The manufacturer reserves the right to make changes to the design, form, colour and specification during the delivery period, provided these changes, while taking into account the interests of the vendor, can be deemed reasonable with respect to the purchaser. Where the vendor or manufacturer uses symbols or numbers to describe an order or the subject of an order, no rights may be derived solely from this. Illustrations and descriptions may include accessories and optional equipment that are not part of standard specification. Colours may differ slightly from those shown in the brochure owing to the limitations of the printing process. This brochure may contain models and services which are not available in certain countries. All references to weights and dimensions are subject to manufacturing tolerances of $\pm 5\%$.

Please consult your Mercedes-Benz van dealer for latest details and for information on legal requirements.

Mercedes-Benz UK Ltd. Tongwell, Milton Keynes MK15 8BA.

SPRTVL0909