

The new Golf Estate





Meet the new Golf Estate. More refined, more stylish than ever before.

Model shown is new Golf Estate Sportline with optional metallic paint.

Flexible, spacious, stylish. Isn't it time you discovered the new Golf Estate?



Model shown is new Golf Estate Sportline with optional metallic paint.

Design

Dynamic, practical, stylish, the new Golf Estate exudes an elegance designed to stand the test of time. Powerful lines accentuate its athletic character, while specific details, such as the new look to the front and the stylish rear define its classic style.



Exuding quality and charisma, the **all new front design** is unmistakably Golf. Range adjustable **halogen headlights** with integrated indicators flow seamlessly into the **high gloss black radiator grille**, with SE models enhanced by chrome trimmed inserts on the grille louvres. On Sportline models, an additional chrome trimmed front air intake surround and front fog light surrounds beneath the sporty **body-coloured bumper** complete its distinctive look.

Model shown is Sportline with optional metallic paint.



The **rear design** is both sporty and elegant, with the rear light clusters and fully body-coloured bumper blending into the bodyshape giving the new Golf Estate its distinctive appearance, while the integrated rear tailgate spoiler optimises the aerodynamics.

Model shown is Sportline with optional metallic paint.



The **body-coloured door mirrors** with integrated indicators not only complement the body styling, but are also highly visible to other road users.



At 1.1 square metres, the optional **panoramic sunroof** is exceptionally large, adding an extra dimension of space and light. If it gets too hot or too cold, simply close the roof at the touch of a button using the control panel in the roof console above. As well as tinted glass to minimise glare, there's also an electric sunblind that can be closed while the roof is still open, enabling you to enjoy the sunshine without fear of sunburn.

Model shown is Sportline with optional panoramic sunroof, silver anodised roof rails and metallic paint.



Stylish **16 inch 'Atlanta' alloy wheels** with 205/55 R16 tyres and anti-theft wheel bolts provide a distinctive look to the exterior. Standard on all SE models. BlueMotion Technology SE is fitted with 205/55 R16 low rolling resistance tyres as standard.



Elegant **16 inch 'Perth' alloy wheels** with 205/55 R16 low rolling resistance tyres and anti-theft wheel bolts help to reduce fuel consumption. Standard on BlueMotion Technology Sportline models.



Sporty **17 inch 'Porto' alloy wheels** with 225/45 R17 tyres and anti-theft wheel bolts add a great look, while lowered sports suspension ensures safe and spectacular handling. Standard on Sportline and optional on SE models.

Equipment

As you'd expect from Volkswagen, the new Golf Estate offers a high level of specification, with many advanced features fitted as standard, ensuring interior driving comfort that is second to none.



Quality and craftsmanship characterise the interior of the new Golf Estate SE, as demonstrated by the sumptuous optional 'Vienna' leather upholstery in Titan Black with heated front sports seats. The handbrake and steering wheel are also finished in leather providing maximum grip, as well as an extra touch of luxury, while front and rear carpet mats and 'Pyramid Black' decorative inserts in the dash and centre console complement the overall colour scheme.

Interior shown is SE DSG with optional 'Vienna' leather upholstery.



The large tailgate ensures the **luggage compartment** is easily accessible and, thanks to the 60:40 split folding rear seat backrest, can be converted to a spacious stowage area. A low loading sill enables you to manoeuvre bulky items with the greatest of ease. To help protect the boot area from wear and tear, it is trimmed in a high quality, durable fabric, again perfectly complemented to the new Golf Estate.

Interior shown is SE with optional 'Vienna' leather upholstery.



When the rear centre armrest is folded down, it provides a useful **load through facility**, enabling you to transport skis, snowboards and other long objects easily and conveniently.

Interior shown is SE with optional 'Vienna' leather upholstery.



The RCD 210 radio/MP3 compatible CD player with four front speakers will ensure enjoyment on any journey and has a handy storage compartment below for all your travel essentials. Standard on all S models.



The **glovebox** provides handy storage for items that you may wish to keep out of sight, as well as being cooled via the 'Climatic' air conditioning system.



Front and rear **electric windows** are conveniently located in the driver's door for ease of use.

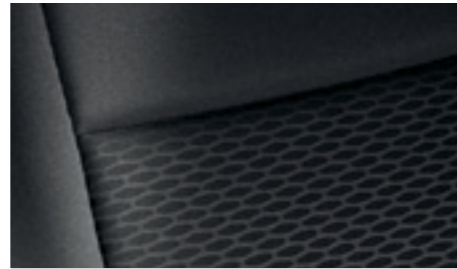

'**Spell**' upholstery in 'Titan Black' gives the interior of the new Golf Estate S a classical elegance.



Maps, books and countless other items can be easily stored in the **front seat back storage pockets**. Standard on all SE and Sportline models.

Interior shown features optional 'Vienna' leather upholstery.



The **RCD 310 radio/MP3 compatible CD player** has eight speakers and it also features an AUX-in socket for connection to an external multimedia source (e.g. iPod or MP3 player). Its large screen clearly displays radio station choices or the track listings of a compatible device connected to the AUX-in socket or optional Multi Device Interface (MDI). Standard on all SE and Sportline models.

Interior shown features optional 2Zone electronic climate control and Winter pack.



The newly designed '**Climatic**' semi-automatic air conditioning system is extremely user-friendly, providing your required cabin temperature quickly and efficiently, while maintaining your selected temperature.



The **Electronic Stabilisation Programme (ESP)** recognises critical driving situations and reacts in milliseconds by targeting brake and management systems, controlling the speed of individual wheels and helping to bring the vehicle under control.



The **front centre armrest** provides additional comfort for the driver, while the rear seat passengers also benefit from two rear air vents and two cup holders. Standard on all SE and Sportline models.



The driver's and front passenger's doors have deep **storage pockets** which can also accommodate a 1.0 litre bottle.



The **multifunction computer (Midline)** can be operated easily, and provides useful information such as average and current fuel consumption, journey time, outside temperature and range left in the fuel tank.



Two **whiplash-optimised front head restraints** not only ensure additional comfort, but also provide particularly effective support for the head and spine in the event of a collision.

Interior shown features optional 'Vienna' leather upholstery.



At speeds of over 19 mph, **cruise control** keeps your selected speed constant, enabling you to relax on longer journeys, without having to keep an eye on your speedometer. Standard on all SE and Sportline models.



Comfort and convenience are ensured with **front footwell illumination**, an **automatic coming/leaving home lighting function**, ensuring your surroundings are well lit for additional security. The **dusk sensor** activates the vehicle's headlights when natural light levels diminish (i.e. night driving and underground car parks), while the **automatically dimming interior rear-view mirror and rain sensor** provide extra safety and comfort. Standard on all SE and Sportline models.

Optional equipment

As you'd expect from such a technologically advanced and well thought out car, it also offers the very latest innovative options to help make every journey that little bit easier. For example, the RNS 510 DVD touch-screen navigation/radio system can guide you to your destination easily and efficiently, with its large colour touch-screen, 3D maps and split-screen functionality. And while your car takes care of planning the route, you can enjoy your favourite music from the DVD drive or 30 GB hard drive, or play your iPod or MP3 player through the Multi Device Interface (MDI). You can even enjoy a DVD film while the vehicle is stationary. Just one more way in which the new Golf Estate raises the driving experience to exciting new levels.



Heat insulating rear tinted windows from the B pillar back are 65% light absorbing, and helps reduce exposure to the sun's rays whilst giving your new Golf Estate a sporty look. Optional on all SE models, and standard on all Sportline models.

Model shown features optional silver anodised roof rails.



The **RCD 310 radio/MP3 compatible CD player** features eight speakers with an output of 4 x 20 watts. It also features an AUX-in socket for connection to an external multimedia source (e.g. iPod or MP3 player). Optional on all S models, and standard on all SE and Sportline models.



The **RCD 510 touch-screen radio/dash-mounted MP3 compatible six CD autochanger** features a large 6½ inch colour display, with intuitive menu navigation and touch-screen operation. It also features an AUX-in socket for connection to an external multimedia source (e.g. iPod or MP3 player) and an SD memory card slot. Optional on all SE and Sportline models.

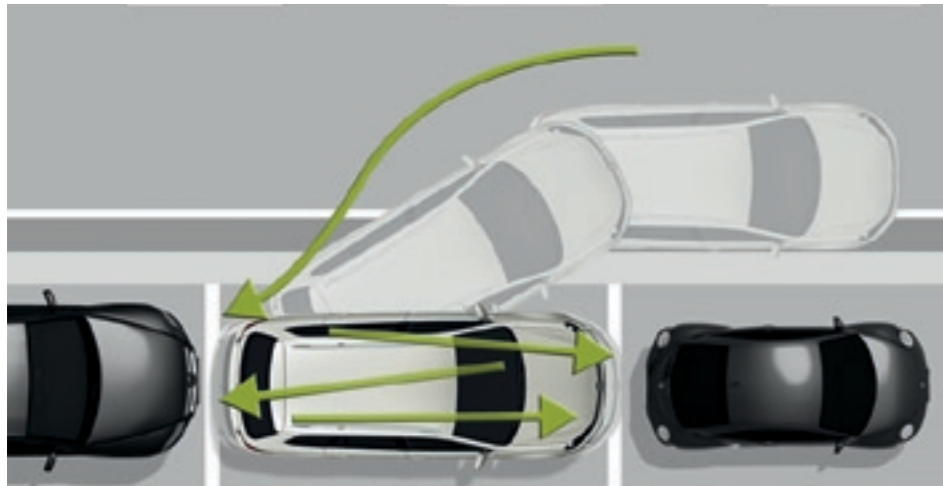

When driving past a parking space at up to 19 mph, the optional **Park Assist system** with ultrasonic front and rear parking sensors, compares the space available with the length of the new Golf Estate. If the space is suitable, the Park Assist parallel parking assistant automatically controls the steering as soon as you engage reverse gear. All you have to do is operate the accelerator, clutch and brake, while keeping a good lookout. **Parking sensors** also assist in less challenging parking manoeuvres by emitting audible signals, alerting the driver to any obstacles in the way: the closer you are to an obstacle the faster the sound frequency. In addition an **Optical Parking Display*** extends the functions of the parking sensors by showing a visual indication of your position, in monochrome on RCD 310 or colour on RCD 510 and RNS 510 navigation system, on the vehicle's audio display during parking. Optional on all SE and Sportline models.

* The Optical Parking Display feature will not function with RCD 210 radio systems.



A **rear-view camera**, provides a clear view to the rear of your vehicle, transmitting an undistorted live image to your radio or navigation system display, enabling you to manoeuvre quickly and easily into the most difficult parking space. Optional on all SE and Sportline models.

Must be ordered in conjunction with RCD 510 or RNS 510 touch-screen navigation/radio systems.



The **Multi Device Interface (MDI)** with iPod and USB cables enables you to connect and charge a compatible device, while track selection is viewed and selected via the vehicle's radio* system. Optional on all models.

* Must be ordered in conjunction with RCD 310, RCD 510 or RNS 510 touch-screen navigation/radio systems.



2Zone electronic climate control provides separate temperature controls for both driver and front passenger, enabling each to set the temperature to their individual requirements. Optional on all SE and Sportline models.



The **RNS 510 touch-screen navigation/radio system** will guide you to your destination using all but the last two digits of a UK postcode and includes a 6½ inch colour display. It also plays DVDs (when the vehicle is stationary) and music from the DVD drive, 30 GB hard drive or via an SD card. Optional on all SE and Sportline models.

RNS 510 touch-screen navigation/radio systems, RCD 510 radio system and RCD 310 radio system cannot be specified in conjunction with each other.

Paint



Reflex Silver
Metallic
8E



Salsa Red
Non-Metallic
4Y



Red Spice
Metallic
K7



Black
Non-Metallic
A1



Shadow Blue
Metallic
P6



Candy White
Non-Metallic
B4



Heavenly Blue
Metallic
R2



Platinum Grey
Metallic
2R



Deep Black
Pearl Effect
2T



Silver Leaf
Metallic
7B



Blue Graphite
Pearl Effect
W9

Standard Optional at extra cost

Please note: Screen technology does not allow for exact reproduction of the paint colours.

Upholstery

Titan Black
'Spell' cloth
BB



Standard on S, BlueMotion Technology S

Titan Black
'Vienna' leather*
TW



Optional on SE, BlueMotion Technology SE, Sportline, BlueMotion Technology Sportline

Titan Black
'Merlin' cloth
FW



Standard on SE, BlueMotion Technology SE

Corn Silk Beige
'Vienna' leather*
YY



Optional on SE, BlueMotion Technology SE, Sportline, BlueMotion Technology Sportline

Titan Black
Alcantara
XT



Standard on Sportline, BlueMotion Technology Sportline

Corn Silk Beige
Alcantara
XU



Standard on Sportline, BlueMotion Technology Sportline

* Some parts of leather interior will contain artificial leather.
 Please note: Screen technology does not allow for exact reproduction of the upholstery colours.

■ Standard ■ Optional at extra cost

Combinations

	Seat upholstery	Carpet	Dashboard	Salsa Red (4Y)	Black (A1)	Candy White (B4)	Platinum Grey Metallic (2R) *	Silver Leaf Metallic (7B) *	Reflex Silver Metallic (8E) *	Red Spice Metallic (K7) *	Shadow Blue Metallic (P6) *	Heavenly Blue Metallic (R2) *	Deep Black Pearl Effect (2T) *	Blue Graphite Pearl Effect (W9) *
'Spell' cloth Standard on S, BlueMotion Technology S	Titan Black (BB)	Black	Black/Black	●	●	●	●	●	●	●	●	●	●	●
'Merlin' cloth Standard on SE, BlueMotion Technology SE	Titan Black (FW)	Black	Black/Black	●	●	●	●	●	●	●	●	●	●	●
Alcantara Standard on Sportline, BlueMotion Technology Sportline	Titan Black (XT)	Black	Black/Black	●	●	●	●	●	●	●	●	●	●	●
	Corn Silk Beige (XU)	Black	Black/Corn Silk Beige	●	●	●	●	-	-	●	●	-	●	●
'Vienna' leather * † Optional on SE, BlueMotion Technology SE, Sportline, BlueMotion Technology Sportline	Titan Black (TW)	Black	Black/Black	○	○	○	○	○	○	○	○	○	○	○
	Corn Silk Beige (YY)	Black	Black/Corn Silk Beige	○	○	○	○	-	-	○	○	-	○	○

* Metallic and pearl effect paints and 'Vienna' leather upholstery are optional at extra cost.
† Some parts of leather interior will contain artificial leather.

● Standard.
○ Optional at extra cost.
- Not available.

S – 1.2 litre TSI 105 PS† Technical specification

		Manual	Automatic DSG
Engine	Engine type	Four cylinder petrol	Four cylinder petrol
	Cubic capacity, ltrs/cc	1.2/1197	1.2/1197
	Max. output, PS ⁽⁰¹⁾ /kW at rpm	105/77 TBA	105/77 TBA
	Max. torque, lbs.ft/Nm at rpm	TBA/TBA TBA	TBA/TBA TBA
	Gearbox	Six speed manual	Seven speed auto DSG
Weights, kgs	Unladen weight ⁽⁰²⁾	TBA	TBA
	Gross vehicle weight	TBA	TBA
	Payload ⁽⁰²⁾	TBA	TBA
	Axle load limit: Front Rear	TBA TBA	TBA TBA
Trailer load limits, kgs ⁽⁰³⁾	Braked 12% incline	TBA	TBA
	Unbraked	TBA	TBA
	Towbar load limit	TBA	TBA
	Max. roof load	TBA	TBA
Performance	Top speed (where the law permits), mph (km/h)	TBA (TBA)	TBA (TBA)
	Acceleration, secs 0 - 62 mph	TBA	TBA
	ABI insurance group, 1 - 20 (1 - 50)±	TBA (TBA)	TBA (TBA)
Environmental information	Fuel grade, minimum	Unleaded, 95 RON ⁽⁰⁴⁾	Unleaded, 95 RON ⁽⁰⁴⁾
	Fuel tank capacity, galls/ltrs	12.1/55	12.1/55
	Official fuel consumption, mpg/ltr per 100 km ⁽⁰⁶⁾		
	Urban	TBA	TBA
	Extra-urban	TBA	TBA
	Combined	TBA	TBA
	Official CO ₂ emission, g/km ⁽⁰⁷⁾	TBA	TBA
Emission class	EURO 5	EURO 5	
Noise, dB	TBA	TBA	

Notes.

- 01) The maximum power output figures are quoted in PS (or Pferdestärke, which is the metric equivalent of horsepower). To convert from metric to imperial horsepower, divide the PS figure by 1.0139.
- 02) Figures are calculated in accordance with manufacturer's criteria. The individual unladen weight depends on the specification of the vehicle, this then reduces the possible payload accordingly. The unladen weight and payload both include the fuel tank 90% full, driver (68 kg) and luggage (7 kg) in line with EU directive 95/48.
- 03) With increasing altitude the engine performance diminishes. From 1,000 m above sea level and for every 1,000 m thereafter 10% of the vehicle/trailer weight (trailer weight + gross vehicle weight) must be deducted.
- 04) Thanks to the knock control, unleaded four star (at least 95 RON) can be used instead of unleaded Super plus. In order to achieve maximum fuel consumption benefits on the TSI engine, Ultra Low Sulphur Petrol (ULSP) must be used.
- 05) The use of RME and FAME (bio diesel) is not possible.
- 06) Official fuel consumption according to EU Directive 99/94. The consumption calculation according to 1999/100/EC is based on the actual unladen weight of the vehicle. Additional specifications can lead to a higher weight class and hence to consumption figures of this higher weight class. The driving style, road and traffic conditions, environmental influences and vehicle condition can in practice lead to consumption figures, which may differ from those calculated with this standard.
- 07) The weight of a vehicle will influence the level of CO₂ emission it produces; as a result, vehicles with higher levels of specification and factory-fitted options may emit higher levels of CO₂.

† Please note, production for this engine will begin in December 2009.

± Please note, from December 2009 the insurance industry will switch from the current rating system of groups 1 - 20 to a new 1 - 50 insurance scale.

SE – 1.4 litre TSI 122 PS

Technical specification

		Manual	Automatic DSG
Engine	Engine type	Four cylinder petrol	Four cylinder petrol
	Cubic capacity, ltrs/cc	1.4/1390	1.4/1390
	Max. output, PS ⁽⁰¹⁾ /kW at rpm	122/90 5000	122/90 5000
	Max. torque, lbs.ft/Nm at rpm	148/200 1500-4000	148/200 1500-4000
	Gearbox	Six speed manual	Seven speed auto DSG
Weights, kgs	Unladen weight ⁽⁰²⁾	1394	1426
	Gross vehicle weight	1940	1970
	Payload ⁽⁰²⁾	621	619
	Axle load limit: Front Rear	990 1000	1020 1000
Trailer load limits, kgs ⁽⁰³⁾	Braked 12% incline	1300	1300
	Unbraked	690	710
	Towbar load limit	75	75
	Max. roof load	75	75
Performance	Top speed (where the law permits), mph (km/h)	125 (201)	125 (201)
	Acceleration, secs 0 - 62 mph	9.9	9.9
	ABI insurance group, 1 - 20 (1 - 50) [±]	7E (16E)	7E (16E)
Environmental information	Fuel grade, minimum	Unleaded, 95 RON ⁽⁰⁴⁾	Unleaded, 95 RON ⁽⁰⁴⁾
	Fuel tank capacity, galls/ltrs	12.1/55	12.1/55
	Official fuel consumption, mpg/ltr per 100 km ⁽⁰⁶⁾		
	Urban	34.0/8.3	36.7/7.7
	Extra-urban	53.3/5.3	55.4/5.1
	Combined	44.8/6.3	47.1/6.0
	Official CO ₂ emission, g/km ⁽⁰⁷⁾	146	139
	Emission class	EURO 5	EURO 5
Noise, dB	73.0	70.0	

Notes.

- 01) The maximum power output figures are quoted in PS (or Pferdestärke, which is the metric equivalent of horsepower). To convert from metric to imperial horsepower, divide the PS figure by 1.0139.
- 02) Figures are calculated in accordance with manufacturer's criteria. The individual unladen weight depends on the specification of the vehicle, this then reduces the possible payload accordingly. The unladen weight and payload both include the fuel tank 90% full, driver (68 kg) and luggage (7 kg) in line with EU directive 95/48.
- 03) With increasing altitude the engine performance diminishes. From 1,000 m above sea level and for every 1,000 m thereafter 10% of the vehicle/trailer weight (trailer weight + gross vehicle weight) must be deducted.
- 04) Thanks to the knock control, unleaded four star (at least 95 RON) can be used instead of unleaded Super plus. In order to achieve maximum fuel consumption benefits on the TSI engine, Ultra Low Sulphur Petrol (ULSP) must be used.
- 05) The use of RME and FAME (bio diesel) is not possible.
- 06) Official fuel consumption according to EU Directive 99/94. The consumption calculation according to 1999/100/EC is based on the actual unladen weight of the vehicle. Additional specifications can lead to a higher weight class and hence to consumption figures of this higher weight class. The driving style, road and traffic conditions, environmental influences and vehicle condition can in practice lead to consumption figures, which may differ from those calculated with this standard.
- 07) The weight of a vehicle will influence the level of CO₂ emission it produces; as a result, vehicles with higher levels of specification and factory-fitted options may emit higher levels of CO₂.

± Please note, from December 2009 the insurance industry will switch from the current rating system of groups 1 - 20 to a new 1 - 50 insurance scale.

S – 1.6 litre TDI 90 PS†

Technical specification

		Manual	
Engine	Engine type	Four cylinder diesel	
	Cubic capacity, ltrs/cc	1.6/1598	
	Max. output, PS ⁽⁰¹⁾ /kW at rpm	90/66 TBA	
	Max. torque, lbs.ft/Nm at rpm	TBA/TBA TBA	
	Gearbox	Five speed manual	
Weights, kgs	Unladen weight ⁽⁰²⁾	TBA	
	Gross vehicle weight	TBA	
	Payload ⁽⁰²⁾	TBA	
	Axle load limit: Front Rear	TBA TBA	
Trailer load limits, kgs ⁽⁰³⁾	Braked 12% incline	TBA	
	Unbraked	TBA	
	Towbar load limit	TBA	
	Max. roof load	TBA	
Performance	Top speed (where the law permits), mph (km/h)	TBA (TBA)	
	Acceleration, secs 0 - 62 mph	TBA	
	ABI insurance group, 1 - 20 (1 - 50)±	5E (13E)	
Environmental information	Fuel grade, minimum	Diesel ⁽⁰⁵⁾	
	Fuel tank capacity, galls/ltrs	12.1/55	
	Official fuel consumption, mpg/ltr per 100 km ⁽⁰⁶⁾		
	Urban	TBA	
	Extra-urban	TBA	
	Combined	TBA	
	Official CO ₂ emission, g/km ⁽⁰⁷⁾	TBA	
Emission class	EURO 5		
Noise, dB	TBA		

Notes.

- 01) The maximum power output figures are quoted in PS (or Pferdestärke, which is the metric equivalent of horsepower). To convert from metric to imperial horsepower, divide the PS figure by 1.0139.
- 02) Figures are calculated in accordance with manufacturer's criteria. The individual unladen weight depends on the specification of the vehicle, this then reduces the possible payload accordingly. The unladen weight and payload both include the fuel tank 90% full, driver (68 kg) and luggage (7 kg) in line with EU directive 95/48.
- 03) With increasing altitude the engine performance diminishes. From 1,000 m above sea level and for every 1,000 m thereafter 10% of the vehicle/trailer weight (trailer weight + gross vehicle weight) must be deducted.
- 04) Thanks to the knock control, unleaded four star (at least 95 RON) can be used instead of unleaded Super plus. In order to achieve maximum fuel consumption benefits on the TSI engine, Ultra Low Sulphur Petrol (ULSP) must be used.
- 05) The use of RME and FAME (bio diesel) is not possible.
- 06) Official fuel consumption according to EU Directive 99/94. The consumption calculation according to 1999/100/EC is based on the actual unladen weight of the vehicle. Additional specifications can lead to a higher weight class and hence to consumption figures of this higher weight class. The driving style, road and traffic conditions, environmental influences and vehicle condition can in practice lead to consumption figures, which may differ from those calculated with this standard.
- 07) The weight of a vehicle will influence the level of CO₂ emission it produces; as a result, vehicles with higher levels of specification and factory-fitted options may emit higher levels of CO₂.

† Please note, production for this engine will begin in December 2009.

± Please note, from December 2009 the insurance industry will switch from the current rating system of groups 1 - 20 to a new 1 - 50 insurance scale.

S, SE[‡] – 1.6 litre TDI 105 PS

Technical specification

		Manual	Automatic DSG
Engine	Engine type	Four cylinder diesel	Four cylinder diesel
	Cubic capacity, ltrs/cc	1.6/1598	1.6/1598
	Max. output, PS ⁽⁰¹⁾ /kW at rpm	105/77 4400	105/77 4400
	Max. torque, lbs.ft/Nm at rpm	185/250 1500-2500	185/250 1500-2500
	Gearbox	Five speed manual	Seven speed auto DSG [‡]
Weights, kgs	Unladen weight ⁽⁰²⁾	1445	1466
	Gross vehicle weight	1980	2000
	Payload ⁽⁰²⁾	610	609
	Axle load limit: Front Rear	1030 1000	1050 1000
Trailer load limits, kgs ⁽⁰³⁾	Braked 12% incline	1400	1400
	Unbraked	720	730
	Towbar load limit	75	75
	Max. roof load	75	75
Performance	Top speed (where the law permits), mph (km/h)	118 (190)	118 (190)
	Acceleration, secs 0 - 62 mph	11.9	11.9
	ABI insurance group, 1 - 20 (1 - 50) [±]	6E (15E)	6E (15E)
Environmental information	Fuel grade, minimum	Diesel ⁽⁰⁵⁾	Diesel ⁽⁰⁵⁾
	Fuel tank capacity, galls/ltrs	12.1/55	12.1/55
	Official fuel consumption, mpg/ltr per 100 km ⁽⁰⁶⁾		
	Urban	49.6/5.7	49.6/5.7
	Extra-urban	72.4/3.9	67.3/4.2
	Combined	62.8/4.5	58.9/4.8
	Official CO ₂ emission, g/km ⁽⁰⁷⁾	119	125
Emission class	EURO 5	EURO 5	
Noise, dB	71.0	71.0	

Notes.

- 01) The maximum power output figures are quoted in PS (or Pferdestärke, which is the metric equivalent of horsepower). To convert from metric to imperial horsepower, divide the PS figure by 1.0139.
- 02) Figures are calculated in accordance with manufacturer's criteria. The individual unladen weight depends on the specification of the vehicle, this then reduces the possible payload accordingly. The unladen weight and payload both include the fuel tank 90% full, driver (68 kg) and luggage (7 kg) in line with EU directive 95/48.
- 03) With increasing altitude the engine performance diminishes. From 1,000 m above sea level and for every 1,000 m thereafter 10% of the vehicle/trailer weight (trailer weight + gross vehicle weight) must be deducted.
- 04) Thanks to the knock control, unleaded four star (at least 95 RON) can be used instead of unleaded Super plus. In order to achieve maximum fuel consumption benefits on the TSI engine, Ultra Low Sulphur Petrol (ULSP) must be used.
- 05) The use of RME and FAME (bio diesel) is not possible.
- 06) Official fuel consumption according to EU Directive 99/94. The consumption calculation according to 1999/100/EC is based on the actual unladen weight of the vehicle. Additional specifications can lead to a higher weight class and hence to consumption figures of this higher weight class. The driving style, road and traffic conditions, environmental influences and vehicle condition can in practice lead to consumption figures, which may differ from those calculated with this standard.
- 07) The weight of a vehicle will influence the level of CO₂ emission it produces; as a result, vehicles with higher levels of specification and factory-fitted options may emit higher levels of CO₂.

[‡] Seven speed auto DSG only available on this model.

[±] Please note, from December 2009 the insurance industry will switch from the current rating system of groups 1 - 20 to a new 1 - 50 insurance scale.

BlueMotion Technology S, BlueMotion Technology SE‡, BlueMotion Technology Sportline – 1.6 litre TDI 105 PS
Technical specification

		Manual	Automatic DSG
Engine	Engine type	Four cylinder diesel	Four cylinder diesel
	Cubic capacity, ltrs/cc	1.6/1598	1.6/1598
	Max. output, PS ⁽⁰¹⁾ /kW at rpm	105/77 4000	105/77 4000
	Max. torque, lbs.ft/Nm at rpm	185/250 1500-2500	185/250 1500-2500
	Gearbox	Five speed manual	Seven speed auto DSG [‡]
Weights, kgs	Unladen weight ⁽⁰²⁾	1452	TBA
	Gross vehicle weight	1960	TBA
	Payload ⁽⁰²⁾	583	TBA
	Axle load limit: Front Rear	1010 1000	TBA TBA
Trailer load limits, kgs ⁽⁰³⁾	Braked 12% incline	1400	TBA
	Unbraked	720	TBA
	Towbar load limit	75	75
	Max. roof load	75	75
Performance	Top speed (where the law permits), mph (km/h)	118 (190)	TBA (TBA)
	Acceleration, secs 0 - 62 mph	11.9	TBA
	ABI insurance group, 1 - 20 (1 - 50) [±]	8E (18E)	8E (18E)
Environmental information	Fuel grade, minimum	Diesel ⁽⁰⁵⁾	Diesel ⁽⁰⁵⁾
	Fuel tank capacity, galls/ltrs	12.1/55	12.1/55
	Official fuel consumption, mpg/ltr per 100 km ⁽⁰⁶⁾		
	Urban	54.3/5.2	TBA
	Extra-urban	78.5/3.6	TBA
	Combined	67.3/4.2	TBA
	Official CO ₂ emission, g/km ⁽⁰⁷⁾	109	TBA
Emission class	EURO 5	EURO 5	
Noise, dB	71.0	TBA	

Notes.

- 01) The maximum power output figures are quoted in PS (or Pferdestärke, which is the metric equivalent of horsepower). To convert from metric to imperial horsepower, divide the PS figure by 1.0139.
- 02) Figures are calculated in accordance with manufacturer's criteria. The individual unladen weight depends on the specification of the vehicle, this then reduces the possible payload accordingly. The unladen weight and payload both include the fuel tank 90% full, driver (68 kg) and luggage (7 kg) in line with EU directive 95/48.
- 03) With increasing altitude the engine performance diminishes. From 1,000 m above sea level and for every 1,000 m thereafter 10% of the vehicle/trailer weight (trailer weight + gross vehicle weight) must be deducted.
- 04) Thanks to the knock control, unleaded four star (at least 95 RON) can be used instead of unleaded Super plus. In order to achieve maximum fuel consumption benefits on the TSI engine, Ultra Low Sulphur Petrol (ULSP) must be used.
- 05) The use of RME and FAME (bio diesel) is not possible.
- 06) Official fuel consumption according to EU Directive 99/94. The consumption calculation according to 1999/100/EC is based on the actual unladen weight of the vehicle. Additional specifications can lead to a higher weight class and hence to consumption figures of this higher weight class. The driving style, road and traffic conditions, environmental influences and vehicle condition can in practice lead to consumption figures, which may differ from those calculated with this standard.
- 07) The weight of a vehicle will influence the level of CO₂ emission it produces; as a result, vehicles with higher levels of specification and factory-fitted options may emit higher levels of CO₂.

† Please note, production for this engine will begin in December 2009.

‡ Seven speed auto DSG only available on this model.

± Please note, from December 2009 the insurance industry will switch from the current rating system of groups 1 - 20 to a new 1 - 50 insurance scale.

SE, Sportline – 2.0 TDI 140 PS

Technical specification

		Manual	Automatic DSG
Engine	Engine type	Four cylinder diesel	Four cylinder diesel
	Cubic capacity, ltrs/cc	2.0/1968	2.0/1968
	Max. output, PS ⁽⁰¹⁾ /kW at rpm	140/103 4200	140/103 4200
	Max. torque, lbs.ft/Nm at rpm	236/320 1750-2500	236/320 1750-2500
	Gearbox	Six speed manual	Six speed auto DSG
Weights, kgs	Unladen weight ⁽⁰²⁾	1495	1521
	Gross vehicle weight	2030	2050
	Payload ⁽⁰²⁾	610	604
	Axle load limit: Front Rear	1080 1000	1100 1000
Trailer load limits, kgs ⁽⁰³⁾	Braked 12% incline	1500	1500
	Unbraked	740	750
	Towbar load limit	75	75
	Max. roof load	75	75
Performance	Top speed (where the law permits), mph (km/h)	130 (210)	129 (208)
	Acceleration, secs 0 - 62 mph	9.7	9.7
	ABI insurance group, 1 - 20 (1 - 50) [±]	12E (24E)	12E (24E)
Environmental information	Fuel grade, minimum	Diesel ⁽⁰⁵⁾	Diesel ⁽⁰⁵⁾
	Fuel tank capacity, galls/ltrs	12.1/55	12.1/55
	Official fuel consumption, mpg/ltr per 100 km ⁽⁰⁶⁾		
	Urban	43.5/6.5	39.8/7.1
	Extra-urban	68.9/4.1	62.8/4.5
	Combined	56.5/5.0	51.4/5.5
	Official CO ₂ emission, g/km ⁽⁰⁷⁾	132	144
Emission class	EURO 5	EURO 5	
Noise, dB	73.0	69.0	

Notes.

- 01) The maximum power output figures are quoted in PS (or Pferdestärke, which is the metric equivalent of horsepower). To convert from metric to imperial horsepower, divide the PS figure by 1.0139.
- 02) Figures are calculated in accordance with manufacturer's criteria. The individual unladen weight depends on the specification of the vehicle, this then reduces the possible payload accordingly. The unladen weight and payload both include the fuel tank 90% full, driver (68 kg) and luggage (7 kg) in line with EU directive 95/48.
- 03) With increasing altitude the engine performance diminishes. From 1,000 m above sea level and for every 1,000 m thereafter 10% of the vehicle/trailer weight (trailer weight + gross vehicle weight) must be deducted.
- 04) Thanks to the knock control, unleaded four star (at least 95 RON) can be used instead of unleaded Super plus. In order to achieve maximum fuel consumption benefits on the TSI engine, Ultra Low Sulphur Petrol (ULSP) must be used.
- 05) The use of RME and FAME (bio diesel) is not possible.
- 06) Official fuel consumption according to EU Directive 99/94. The consumption calculation according to 1999/100/EC is based on the actual unladen weight of the vehicle. Additional specifications can lead to a higher weight class and hence to consumption figures of this higher weight class. The driving style, road and traffic conditions, environmental influences and vehicle condition can in practice lead to consumption figures, which may differ from those calculated with this standard.
- 07) The weight of a vehicle will influence the level of CO₂ emission it produces; as a result, vehicles with higher levels of specification and factory-fitted options may emit higher levels of CO₂.

± Please note, from December 2009 the insurance industry will switch from the current rating system of groups 1 - 20 to a new 1 - 50 insurance scale.

Technology

Engines

- Front transverse-installed engine
- 1.2 litre/105 PS ⁽⁰¹⁾ (77 kW) petrol engine: TBA
- 1.4 litre/122 PS ⁽⁰¹⁾ (90 kW) petrol engine: CAXA TSI engine with homogeneous mode (Lambda 1), stratified high-pressure start, double injection catalytic converter heating, turbocharger with waste gate, air-to-liquid charge-air cooling, maintenance-free timing chain, plastic intake manifold with integrated intercooler, continuous inlet camshaft timing adjustment, grey cast iron cylinder block, steel crankshaft, duo-centric oil pump, dual-circuit cooling system. Fuel system regulated according to requirements using high-pressure fuel pump with integrated pressure limiting valve
- 1.6 litre/90 PS ⁽⁰¹⁾ (66 kW) common rail diesel engine: EU5 emissions standard, four cylinder in-line engine, four valves per cylinder, aluminium-silicon alloy cylinder head, reduced piston crown volume (improves swirl generation in the cylinder), toothed backlash compensator, intake manifold with electric continual tumble flap control, electronically controlled common rail direct injection fuel system with Bosch high pressure pump (up to 1800 bar) and 8-hole piezo injector units, pre-supply electronic fuel pump, oil cooler, intercooler, low temperature exhaust gas recirculation, additional coolant pump, turbocharger with variable turbine geometry, catalytic converter and Diesel Particulate Filter (DPF)
- 1.6 litre/105 PS ⁽⁰¹⁾ (77 kW) common rail diesel engine: EU5 emissions standard, four cylinder in-line engine, four valves per cylinder, aluminium-silicon alloy cylinder head, reduced piston crown volume (improves swirl generation in the cylinder), toothed backlash compensator, intake manifold with electric continual tumble flap control, electronically controlled common rail direct injection fuel system with Bosch high pressure pump (up to 1800 bar) and 8-hole piezo injector units, pre-supply electronic fuel pump, oil cooler, intercooler, low temperature exhaust gas recirculation, additional coolant pump, turbocharger with variable turbine geometry, catalytic converter and Diesel Particulate Filter (DPF)
- 2.0 litre/140 PS ⁽⁰¹⁾ (103 kW) common rail diesel engine: EU5 emissions standard, four cylinder in-line engine, four valves per cylinder, aluminium-silicon alloy cylinder head, reduced piston crown volume (improves swirl generation in the cylinder), toothed backlash compensator, intake manifold with electric continual tumble flap control, electronically controlled common rail direct injection fuel system with Bosch high pressure pump (up to 1800 bar) and 8-hole piezo injector units, pre-supply electronic fuel pump, oil cooler, intercooler, low temperature exhaust gas recirculation, additional coolant pump, turbocharger with variable turbine geometry, catalytic converter and Diesel Particulate Filter (DPF)

Brakes

- Electronically controlled Anti-lock Braking System (ABS) with Electronic Brake-pressure Distribution (EBD)
- Diagonal twin-circuit brake system with front and rear disc brakes (front ventilated)
- Asbestos-free brake pads
- Hydraulic Brake Assist (HBA)

Steering

- Electro-mechanical steering rack
- Collapsible, height and lengthways adjustable safety steering column

Transmission

- Front wheel drive through asbestos-free single-plate dry clutch. Hydraulic clutch-mechanism. Five or six speed manual gearbox. Six or seven speed automatic DSG gearbox. Double joint half axles
- Five speed manual: 1.6 litre TDI 90 PS, 1.6 litre TDI 105 PS
- Six speed manual: 1.2 litre TSI 105 PS, 1.4 ltr TSI 122 PS, 2.0 ltr TDI 140 PS
- Six speed automatic DSG: 2.0 ltr TDI 140 PS
- Seven speed automatic DSG: 1.2 litre TSI 105 PS, 1.4 ltr TSI 122 PS, 1.6 litre TDI 105 PS

Running gear

- Electronic Stabilisation Programme (ESP) including Electronic Differential Lock (EDL), Traction Control (ASR) and Countersteer Support
- Front suspension through coil springs with telescopic shock absorbers, all elements integrated in chassis legs
- Rear suspension with gas pressure shock absorbers and separate springs
- Wheel control: front through chassis legs and (lower) triangular wishbones (directionally stabilising steering roll radius)
- Wheel control: rear through four-link suspension with independent wheel suspension
- Front and rear anti-roll bar

Dimensions

Maximum luggage capacity, litres VDA measuring method using 200 x 100 x 50 mm blocks ⁽⁰¹⁾	With rear seat upright	505
	With rear seat folded	1495
Exterior dimensions	Length, mm	4534
	Width – excluding door mirrors, mm	1781
	Width – opened front/rear doors, mm	3640/3409
	Height, mm	1504
	Height – opened bonnet/floor, mm	1715
	Height – opened tailgate/floor, mm	2061
	Wheelbase, mm	2578
	Turning circle, m	10.9
Interior dimensions	Effective headroom – front, mm (with sunroof)	972 (986)
	Effective headroom – rear, mm (with sunroof)	969 (973)
	Elbow width, front, mm	1446
	Elbow width, rear, mm	1437

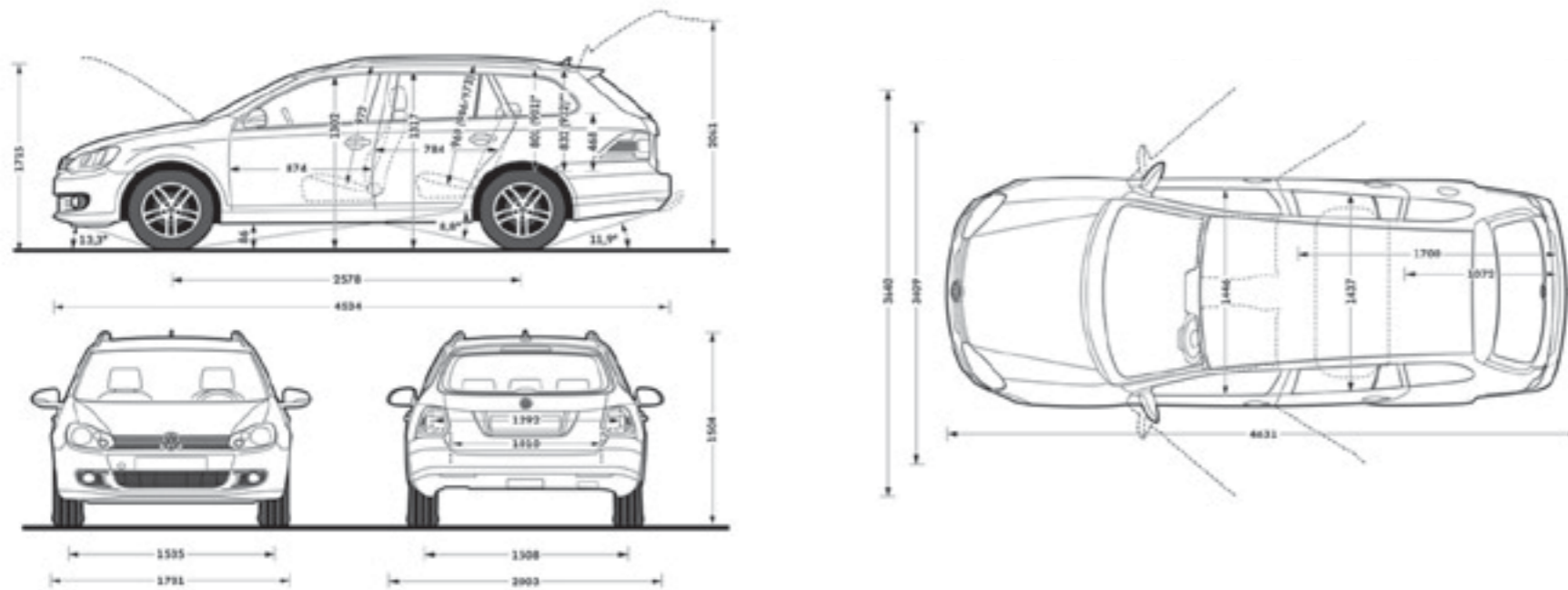

Volkswagen service

The Volkswagen Warranty.

Three-year Warranty.

All Volkswagen new Golf Estates come with a three-year/60,000 miles warranty, which protects your car against the failure of most mechanical and electrical components due to manufacturing defects. This comprises a two-year manufacturer's warranty with unlimited mileage plus a further one-year/60,000 miles (whichever is soonest) Retailer Warranty. Should the mileage exceed 60,000 miles within the first two years, the manufacturer's two-year warranty will still be valid. If an additional warranty for subsequent years or higher mileage is desired, it may be purchased from an authorised Volkswagen retailer or repairer; however, this additional warranty must be purchased before the mileage reaches 60,000*. Full details of the three-year warranty are available from your authorised Volkswagen retailer or repairer.

* All warranty work must be completed by an authorised Volkswagen retailer or repairer.

Three-year Paint Warranty.

The paintwork of the new Golf Estate is covered against manufacturing defects for a period of three years. Naturally, the new Golf Estate must be cared for in compliance with the operating instructions which will be found in your vehicle handbook. Please consult your authorised Volkswagen retailer or repairer for full warranty details.

12-year Body Protection Warranty.

The internal body sections and panels of the new Golf Estate are covered against rusting through from the inside for 12 years. Naturally, the new Golf Estate must be cared for in compliance with the operating instructions. Please consult your authorised Volkswagen retailer or repairer for full warranty details.

Approved Accessories.

A comprehensive range of accessories from alloy wheels to carpet mats is available to complement the factory-fitted option list. Volkswagen approved accessories purchased from and fitted by your authorised Volkswagen retailer at the point of vehicle sale will also benefit from the three-year vehicle warranty.

Service Intervals.

Volkswagen are pleased to offer you a choice on how your new Golf Estate is serviced. The appropriate selection is entirely dependent on how the car is likely to be driven and its general use. To help you identify which type of service would be most suitable, please refer to the following guide.

The Time and Distance Service is recommended for vehicles that will cover less than 10,000 miles in 12 months and if the vehicle is likely to be used in the following way:

- Predominantly urban driving, short journeys with frequent cold starts.
- Activities regularly producing high engine loading, e.g. frequent hill climbs, driving with vehicle fully loaded and towing.
- Uneconomical driving style using high rpms with heavy acceleration and heavy braking.

The service intervals for the Time and Distance Service are as follows:

- Oil change service
Every 10,000 miles/1 year (whichever is soonest).
- Interval service
Every 20,000 miles/2 years (whichever is soonest).
- Inspection service
Every 40,000 miles/3 years (whichever is soonest).

The LongLife Service is recommended for vehicles with a daily mileage of more than 25 miles where the vehicle is driven regularly mainly on longer distance journeys. The vehicle is driven mainly at a constant speed with minimum vehicle and engine loading, minimal towing and driven in an economical manner.

With the LongLife Service the vehicle can cover anywhere between 10,000[†] and a maximum of 18,000[†] miles or 24 months (whichever is soonest) between oil changes. Inspection service is typically in the third year of ownership and thereafter every second year, for vehicles with an approximate annual mileage of 10,000 miles.

[†] Please note that mileages are approximate as the service indicator system uses kilometres as the distance measurement. Please consult your authorised Volkswagen retailer or repairer for advice and full details.

Extended Warranty.

You may purchase additional protection from your authorised Volkswagen retailer or repairer, or contact 0870 9000 115.

Volkswagen Finance[‡].

Volkswagen Finance specialises in providing funding solutions for Volkswagen drivers. Whether your Volkswagen is for private or business use, you can choose from a range of funding options.

- Solutions – a personal contract plan
- Hire purchase
- Lease purchase
- Finance lease
- Contract hire

With all Volkswagen Finance products you can choose a fixed-cost maintenance plan to help you budget for your servicing and maintenance costs.

No matter what finance product you choose, your local Volkswagen retailer will be able to provide you with a personalised quote that could meet your budget and vehicle needs.

[‡] Volkswagen Finance is a trading name of Volkswagen Financial Services (UK) Limited. An offer of finance depends on certain conditions. Available to people over 18 in the UK only.

Volkswagen Insurance[±].

Competitive and comprehensive motor insurance designed especially for Volkswagen drivers. All new and Approved Used Volkswagens come with complimentary seven-day cover upon request – we'll e-mail a cover note straight to your retailer, enabling them to tax your car easily. This way, you can drive straight out of the showroom. Taking out annual cover is easy and it can start when the seven-day cover expires. For more information contact your local Volkswagen retailer or call 0800 051 3136.

[±] Volkswagen Insurance is underwritten and administered by Zurich Insurance plc. Volkswagen Insurance is a trading name of Volkswagen Insurance Service (Great Britain) Limited which is an appointed representative of Volkswagen Financial Services (UK) Limited. Zurich Insurance plc and Volkswagen Financial Services (UK) Limited are both authorised and regulated by the Financial Services Authority.

Volkswagen Roadside Assistance.

Every new car is registered for Volkswagen Roadside Assistance for one year. This provides vehicle home and roadside recovery in the unlikely event of a breakdown in the UK and Europe (subject to conditions). Volkswagen Roadside Assistance can also be purchased for subsequent years. For full details, please contact your authorised Volkswagen retailer or repairer.

Tax Free Sales.

For full details, please contact your authorised Volkswagen retailer.

CO₂ Emission.

Increased weight of a vehicle, including higher trim levels and the addition of options will have a detrimental influence on the level of fuel consumption and CO₂ emissions produced.

The CO₂ and fuel consumption figures are obtained from tests on a representative vehicle of the type, conducted and approved in accordance with Council Directive 80/1268/EEC as amended by Directive 1999/100/EC (or later) on the approximation of the laws of the member states relating to the carbon dioxide emissions and the fuel consumption of motor vehicles.

Please Note:

Some illustrations in this brochure do not necessarily reflect UK specifications and may not be available. In particular, controls and some items of equipment are positioned differently for the UK.

The specifications contained in this brochure are for information purposes only and are subject to change. If you require any specific feature, you must consult your authorised Volkswagen retailer who is regularly updated with any change in specification. Please check model availability and full specification details with your authorised Volkswagen retailer prior to ordering.

Note: We would like to advise you that telephone calls to Volkswagen Customer Care may be monitored and recorded as part of our training and quality assurance processes. All our monitoring and recording processes meet Ofcom regulations.