

PVW238TRG
ISSUE: 1 APRIL 2009
WWW.VOLKSWAGEN.CO.UK
TELEPHONE 0800 037 7888

The illustrations in this book do not necessarily reflect UK specifications and some items of equipment may not be available for the UK. The specifications contained in this book are for information purposes only as we cannot confirm the exact specifications of the vehicles. 4XMOTION is a registered trademark of Volkswagen AG.



THE TOUAREG.

THE TOUAREG.



Model shown is SE V10 TDI DPF with optional 20" 'Ayers rock' alloy wheels.

FEEL AT HOME,
WHEREVER YOU ARE.



Model shown is 2.5 TDI DPF with optional metallic paint.

THE TOUAREG.

The Touareg combines a smart look with the highest level of specification, including a whole range of interior and exterior features for your complete comfort and safety. Adorning the exterior, the chrome trimmed radiator grille surround and sporty 17 inch 'Canyon 5' alloy wheels with 235/65 R17 tyres create an eye-catching look, complemented by heat insulating tinted glass.

The attention to detail continues inside, with 'Trail' cloth upholstery, air conditioning and a leather trimmed four-spoke steering wheel adding a touch of luxury, while the multifunction computer with three inch monochrome screen, 'Delta' radio system with single CD player and 10 speakers, and electric front and rear windows all help to make your journey as pleasurable as possible. Power-assisted steering, manual seat height adjustment for the driver and front passenger, and electrically heated, adjustable and foldable door mirrors enhance your driving experience, while hill start assist and hill descent assist help you pull away effortlessly in all conditions, whether on tarmac or off the beaten track.



Safety, as ever, is paramount, with ABSplus (Anti-lock Braking System), EBD (Electronic Brake-pressure Distribution) and HBA (Hydraulic Brake Assist) fitted as standard on all models. ESP (Electronic Stabilisation Programme), including EDL (Electronic Differential Lock) and ASR (Anti-Slip Regulation), help you avoid hazardous situations, while Isofix child seat preparation on the outer rear seats ensures your small passengers enjoy the highest levels of protection too.



Model shown is 2.5 TDI DPF with optional sunroof, silver-look roof rails and metallic paint.



THE TOUAREG SE.



Model shown is SE V10 TDI DPF.



Interior shown is SE 3.0 V6 TDI CR with optional parking sensors, 'Engine spin' decorative inserts and metallic paint.

THE TOUAREG SE.

Comfort and style go hand in hand in the Touareg SE, with an abundance of luxurious features to give you maximum driving enjoyment. The dynamic exterior features striking 18 inch 'Valley' alloy wheels with 255/55 R18 tyres, chrome trimmed radiator grille and louvres, front fog lights, chrome protective door sill strips and chrome side window surrounds.

Inside, the story is one of pure indulgence and refinement, with 'Cricket' leather upholstery, 'Walnut' wood decorative inserts and 2Zone electronic climate control providing a sumptuous feel, while the six disc, boot-mounted CD autochanger, multifunction steering wheel, cruise control and DVD touch-screen satellite navigation/radio system with 6½ inch colour screen help make driving as stress-free as possible, however long your journey. Finally, heated front seats and heated windscreen washer jets make life that little bit easier on those cold winter mornings.

If creature comforts really are your thing, then opt for the Touareg SE V10 TDI DPF and you'll also find a host of additional features for your ultimate convenience. Bi-Xenon headlights with dynamic curve lighting for dipped and main beam, create a brighter beam and move automatically to your direction of travel, illuminating the road more efficiently and reducing stress on your eyes. Metallic or pearl effect paint and silver lacquered roof rack gutters make the exterior of your Touareg SE V10 TDI DPF even more eye-catching.



Underneath, CDC (Continuous Damping Control), the automatic self-levelling air suspension system with speed sensitive height adjustment, gives you a choice of three settings: sport, comfort and auto, designed to cope with any terrain you encounter. In addition, CDC allows manual vehicle height adjustment for easy loading and maximum ground clearance when required.

Inside the Touareg SE V10 TDI DPF the plethora of equipment continues – electrically operated front seats with 12-way adjustment, including lumbar support with memory, electrically-adjustable driver's seat belt height and steering column with memory, assure you of the best possible seating posture at all times. The front and rear parking sensors help you get in and out of tight spaces, whilst the coming/leaving home lighting function with dusk sensor and rain sensor help you get home in the dark or bad weather. Finally, telephone preparation in the front centre armrest, for Bluetooth (rSAP) enabled telephones, adds both convenience and safety to your journey.

THE TOUAREG ALTITUDE.



Model shown is Altitude 3.0 V6 TDI CR with optional silver-look roof rails, Convenience pack, CDC air suspension, Bi-Xenon headlights and metallic paint.

THE TOUAREG ALTITUDE.

As its name implies, the Touareg Altitude provides the height of luxury twinned with charismatic good looks. Sure to set your pulse racing, the sporty body kit features uniquely shaped front and rear bumpers, while the sports polished stainless steel twin exhaust tailpipes complete its impressive silhouette. The 19 inch 'Siena' alloy wheels with 275/45 R19 tyres or 20 inch 'Casablanca' alloy wheels with 275/40 R20 tyres on V10 TDI DPF models, further complements the Altitude's dynamic streamlined form. This look is finished off by heat insulating 35% tinted glass from the B pillar backwards, enhancing the stylish exterior still further while providing privacy and comfort for rear passengers.

Sit inside the Touareg Altitude and you'll find all the features of the SE, including 'Cricket' leather upholstery, heated front seats and 2Zone electronic climate control, further enhanced by the exclusive 'Piano Black' decorative inserts. The six disc CD autochanger and cruise control help to provide a stress-free environment, while a DVD touch-screen satellite navigation system will guide you to your chosen destination with both visual and audible instructions.

Choose the Touareg Altitude V10 TDI DPF and you get all the Altitude features, plus the additional equipment of the SE V10 TDI DPF, including 12-way electric front seats with memory, front and rear parking sensors, CDC (Continuous Damping Control) and telephone preparation in the front centre armrest for Bluetooth (rSAP) enabled telephones. Whichever model you opt for, the Altitude delivers an impressive package of stylish features and leading edge equipment. Allied with its exceptional capability for smooth motorway cruising and truly formidable off-road performance, what better way could you choose to travel?



Interior shown is Altitude 3.0 V6 TDI CR with optional parking sensors, CDC air suspension, Bi-Xenon headlights and metallic paint.

THE TOUAREG R50.



Model shown is R50 with optional silver-look roof rails.



Interior shown is R50.

THE TOUAREG R50.

In 2006, Volkswagen built a Touareg equipped with a V10 TDI engine which caused quite a stir, when it towed a 155 tonne Boeing 747 – proving that it has one of the most powerful diesel engines in automobile history. With the new Touareg R50, it has been possible to considerably increase the output of this state-of-the-art engine in a production vehicle. The result: 350 PS, 850 Nm of torque, 0-62 mph in just 6.7 seconds and a top speed of 146 mph (where the law permits). To ensure that this enormous engine power can be fully transferred to the road, not only is permanent 4XMOTION four wheel drive fitted as standard, but the driving dynamics package also includes adaptive roll compensation, ensuring precision steering of the vehicle on any terrain. But the new Touareg R50 doesn't just accommodate driving conditions, it also adapts itself to your individual driving style. The Dynamic Shift Program (DSP) recognises the driver's personal driving style and automatically adapts gear changes accordingly.

Furthermore, as if the uncompromising dynamics of the new Touareg R50 weren't enough, its looks will surely get your heart thumping. The sports polished stainless steel twin exhaust tailpipes give a hint of the



power within the new Touareg R50, while the extended body-coloured roof spoiler rounds off the car's distinctive rear. From the spectacular 21 inch 'Omanyt' alloy wheels with blue brake calipers to the R50 styling pack with body-coloured bumpers with central chrome strip, honeycomb style front spoiler inserts and wheel arch extensions, every single design element radiates energy. All this makes one thing certain, it will make heads turn.

Inside, it has aluminium-look pedals with 'R' logo, four-spoke multifunction leather steering wheel and aluminium-look 'Engine spin' decor. The unmistakable R50 logo is integrated into the stainless steel door sill protectors and is embossed in the head restraints of the 'Nappa' leather front sports seats. When it comes to comfort, the vehicle makes you think more of a luxurious limousine.

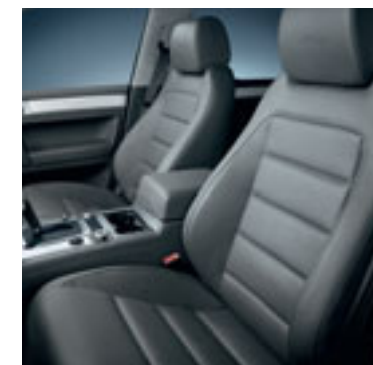

INTELLIGENT SAFETY.

A versatile vehicle like the Touareg has to stand up to the most diverse challenges. That is why it embodies the intelligent safety devices of tomorrow – and the day after. This technology not only helps provide active protection for passengers in the event of a crash, but also provides passive protection by anticipating accidents before they occur.

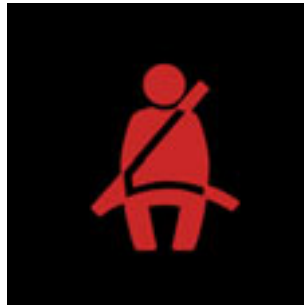

When the vehicle is moving, a warning will sound if the front seat belts are unfastened. Additionally, a light will illuminate on the dashboard to alert the front seat occupants.

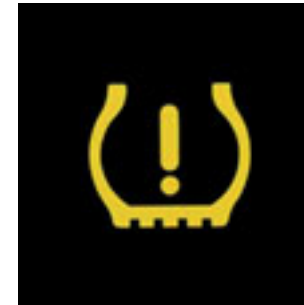

The electronic tyre pressure monitoring system shows the pressure of each tyre in the multifunction display (optional on all models).



The ABSplus system has been specially developed for the Touareg. It detects loose terrain such as sand, gravel or shingle and controls the application of power to each individual wheel, reducing braking distances by up to 20 per cent.

If the vehicle weight is on the front wheels under braking, Electronic Brake-pressure Distribution (EBD), prevents locking of the rear wheels which are subject to a lighter load.

Front fog lights mounted in the front grille provide added safety when driving in poor weather conditions (optional on entry Touareg and standard on all other models).



The latest generation Electronic Stabilisation Programme (ESP) regulates understeering and oversteering of the vehicle when cornering. Highly specialised rollover sensors determine vehicle yaw speed and yaw angle in the event of a rollover. Based on this data, intelligent safety systems decide in a fraction of a second whether to activate seat belt tensioners and airbags.

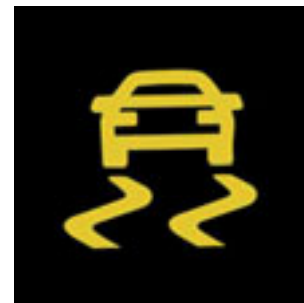

Hydraulic Brake Assist (HBA) detects the speed at which the brake pedal is depressed. In the event of reflex or emergency braking, the system automatically builds up full brake pressure faster.

Hill start assist and hill descent assist. The engine, gear change and brake management system ensures reliable hill climbing and hill descent control.

Isofix child seat preparation is used to secure a child seat on the front passenger's seat and up to two child seats in the rear.

Adaptive roll compensation. Normally, you can feel the effect of body roll during fast cornering. The Touareg's optional Continuous Damping Control (CDC) air suspension controls each shock absorber individually, thereby improving road-holding and minimising body roll for greater agility and improved safety.



Six airbags, including driver's and front passenger's airbags, two front seat side impact airbags and curtain airbags for all passengers ensure all-round protection in any seat. A deactivation switch for the front passenger's airbag is located in the glove compartment, should you need to use a child seat in the front.



Bi-Xenon headlights with dynamic curve lighting, for dipped and main beam produce a brighter light beam and wider coverage than traditional headlights. Built-in motors direct the powerful headlights in the direction of travel, thereby improving illumination when cornering and turning (optional on SE and Altitude, and standard on V10 TDI DPF and R50 models).



Parking sensors, fitted in the front and rear bumpers, monitor the distance from an obstacle, helping you manoeuvre in and out of parking bays. An optical and acoustic signal warns as obstacles become closer (standard on V10 TDI DPF and R50, and optional on all other models).

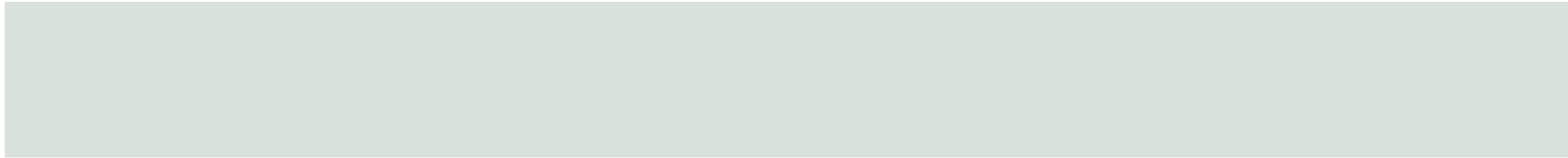
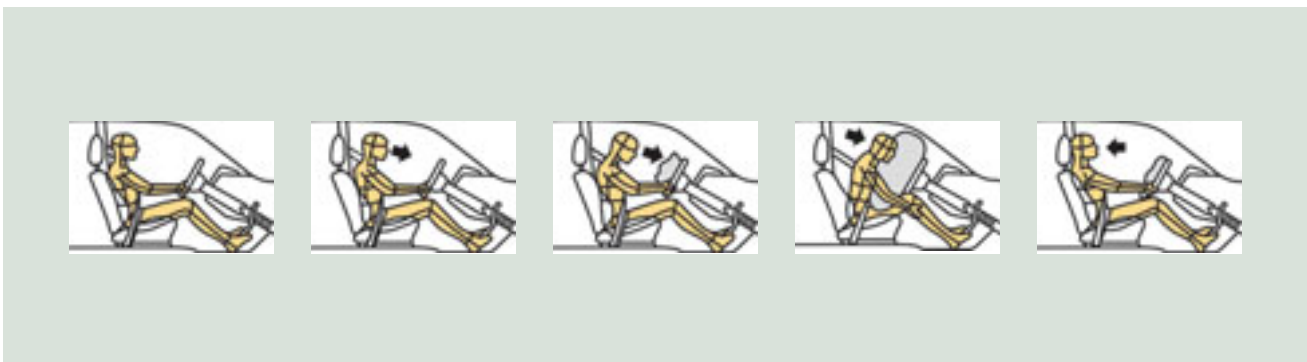

OPTIONAL EQUIPMENT.



Model shown is SE V10 TDI DPF with optional sunroof.



Interior shown is SE V10 TDI DPF with optional 'Nappa' leather.

A DREAM COMBINATION OF LUXURY, COMFORT AND TECHNOLOGY.

You'll be impressed how pleasantly straightforward the Touareg's interior looks with its extensive functionality. To ensure that you drive more comfortably without making it any more complicated, each element and display is placed where it makes sense. Here are just five of many well-thought-out examples:

You can find many central control elements easily on the centre console. This is made possible by a foot-operated parking brake which replaces the bulky handbrake.

Anyone wanting to lock all the doors quickly will find the central locking switch precisely where they need it – on the door.

When manoeuvring into the tight spaces, the press of a button allows you to electrically fold in the door mirrors, thereby gaining those crucial couple of centimetres that protect your Touareg.

When you are closing the electric windows using the switches located in the door, a force limiter detects any obstruction, such as tiny hands, preventing them from becoming trapped.

The 12-way electrically-adjustable front comfort seats can be set to your optimal driving position. In addition, electric lumbar support will ensure you arrive at your destination as relaxed as possible. Standard on R50 and when specified with V10 TDI DPF, and optional on SE and Altitude models.



WHETHER YOU ARE HEADING FOR A CITY CENTRE OR RURAL RETREAT, LET TOUCH-SCREEN SATELLITE NAVIGATION CHOOSE THE BEST ROUTE.



Wherever you may venture with your Touareg, finding your way has never been easier. Whether it's a first-class restaurant in the heart of a city or a fishing hideaway in the countryside, the satellite navigation is there to guide you to your destination. Simply enter the town and street, and the state-of-the-art touch-screen navigation system will find the most suitable route.

Operating the system is simplicity itself, as you'll appreciate the very first time you call upon its assistance. Details of your current position and the directions you'll need to follow will be clearly displayed on the navigation system's 6½" colour screen, positioned on the centre console.

Navigation information is also displayed on the multifunction screen positioned in the dashboard. To ensure you keep your eyes on the road ahead, the navigation system can also talk you through your route with precise audible instructions such as distance covered and your approximate time of arrival. Driving doesn't come much easier.

The Touareg features Volkswagen's latest generation touch-screen navigation/radio system, this new DVD based navigation unit not only delivers great sound quality but it can also guide you to your destination. A 6½" high resolution, touch-screen colour display shows a perspective (bird's-eye) view of your mapped route, in addition, landmarks, intersection zoom and points of interest. As well as featuring the latest in processor technology resulting in quick route calculations, using all but the last two digits of a UK postcode, this sophisticated system features a 30 GB hard drive to buffer the navigation data as well as store the driver's favourite audio and video files (i.e. MP3, WMA, DVD video data files), the integrated DVD drive and SD (Secure Digital) card reader also allow the playback of such audio and video files. Completing the multimedia experience is the ability to connect an external multimedia device (e.g. iPod and USB) via the AUX-in socket. Finally, included with this option is a six disc CD autochanger which is conveniently located in the boot and provides hours of uninterrupted listening pleasure.

The DVD touch-screen satellite navigation/radio system is standard on SE, Altitude and R50 models and available as an option on entry Touareg.



PERSONALISED FOR INDIVIDUALS.



Whichever Touareg you choose, you can be assured that you will be provided with a wealth of standard features to make any journey comfortable and relaxing. But for added satisfaction, why not go one step further and personalise your Touareg? There is a multitude of optional equipment available to make your Touareg as individual as you are. For example, choose 12-way electric comfort seats covered with sumptuous 'Nappa' leather and you can make any journey in the ultimate comfort. Add to that the optional 'Engine spin' or 'Walnut' decorative inserts for an aesthetically individual interior to keep you totally relaxed and stress-free.

Providing comfort for the passengers in your car is no less important and you can make them feel right at home with 4Zone electronic climate control. Each quarter of the cabin can choose their preferred temperature within a 4°C variance between adjacent zones. Or choose the Multimedia pack, DVD rear seat entertainment system mounted in the roof lining.

Or if off-roading in your Touareg is your thing, then you can prepare it for any situation with Differential Lock for the rear axle and decoupling anti-roll bars, including an additional engine guard to give you extra protection when you go off the beaten track.



Interior shown is SE 3.0 V6 TDI CR with optional parking sensors and 'Engine spin' decorative inserts.

Heat insulating tinted glass, 35% from the B pillar back reduces heat build-up in the interior (optional on entry Touareg and SE and standard on Altitude and R50 models).



Multimedia pack DVD rear seat entertainment system mounted in the roof lining provides hours of entertainment for rear seat passengers of any age (optional on SE, Altitude and R50 models).

Not in conjunction with electric sunroof. Also, with this option a tyre repair kit is fitted as standard, as a second battery replaces the temporary steel space-saver spare wheel.



Sunblind for the rear side windows provides both comfort and privacy (optional on all models).

The ski sack, which forms part of the Touring Pack, provides secure transport of skis, snowboards or other long items, whilst keeping the interior of your Touareg in showroom condition. Also included in the Touring pack are cup holders in the rear centre armrest (in lieu of tray) when folded down, a net partition and cargo management system (optional on entry Touareg, SE and Altitude models). Interior shown is SE with optional 'Engine spin' decorative inserts.



2Zone electronic climate control allows the driver and front seat passenger to maintain their individually desired temperature (optional on entry Touareg and standard on SE, Altitude and R50 models).



CDC (Continuous Damping Control) air suspension offers a choice of three suspension settings – sport, comfort and auto. Included in this option are Bi-Xenon headlights for dipped and main beam, with dynamic curve lighting and headlight washers (optional on SE and Altitude, standard on V10 TDI DPF models).

Model shown is SE V10 TDI DPF with optional 20" 'Ayers rock' alloy wheels and silver-look roof rails.



4Zone electronic climate control allows air volume and air distribution to be set individually for all four seats. Passengers on the rear seats can also regulate the temperature using additional control elements and adjustable air vents in the centre console (optional on Altitude and R50 models).

12-way electrically adjustable front comfort seats in 'Nappa' leather, including heated front seats and heated windscreen washer jets ensure comfort during the coldest months (optional on SE and Altitude, and standard on R50 models).



The keyless entry and keyless start features allow you to open and start your Touareg without even taking the key out of your pocket, not shown (optional on Altitude and standard on V10 TDI DPF and R50 models).

WHEELS.

The range of standard alloy wheels has been carefully chosen to complement the exterior styling of all Touaregs. However, you may wish to add a touch of individuality and personalise your Touareg with a choice of 18, 19 or 20 inch alloy wheels. Whichever alloy wheel you choose, you can be certain of Volkswagen's superb design and engineering.

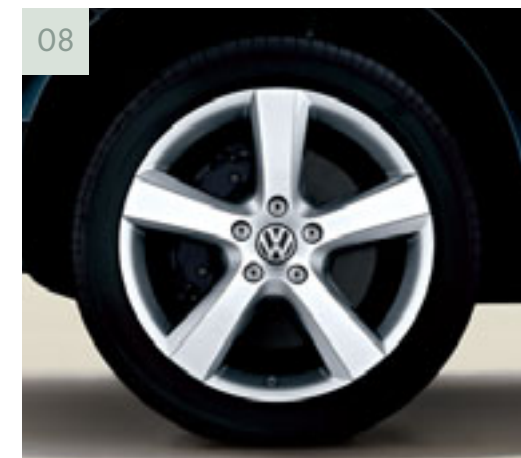
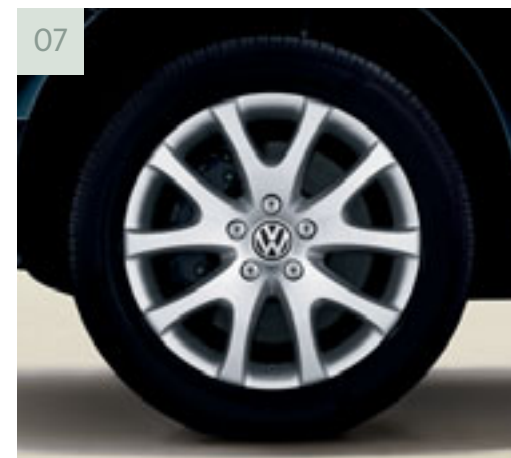
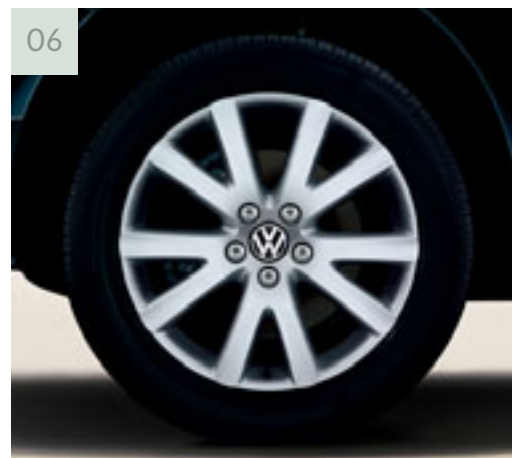

- 01 'Canyon 5' 7½J x 17" standard on entry Touareg.
- 02 'Valley' 8J x 18" standard on SE. Optional on entry Touareg.
- 03 'Siena' 9J x 19" standard on Altitude. Not V10 TDI DPF.
- 04 'Casablanca' 9J x 20" standard on Altitude V10 TDI DPF.
- 05 'Omanyt' 10J x 21" standard on R50.
- 06 'Desert' 9J x 19" optional on SE.
- 07 'Terra' 9J x 19" optional on SE.
- 08 'Ayers rock' 9J x 20" optional on SE and Altitude.



NO BOUNDARIES.
NO BARRIERS.
NO CONSTRAINTS.
NO LIMITS.

Model shown is SE 2.5 TDI DPF with optional metallic paint.

TAKE MOUNTAIN OR MOTORWAY IN YOUR STRIDE.



On the motorway.

In motorway conditions, you can get to know the sportier side of Continuous Damping Control (CDC) air suspension, standard on V10 TDI DPF and optional on SE and Altitude, as the electronic damper control features a setting which lowers the body when driving at speed.

This not only reduces air resistance and fuel consumption, but above all improves road-holding. A driving dynamics package with Active Rollover Protection (ARP) optimises cornering even further. Ultimately, the earth's surface will always present you with new challenges, and the Touareg's running gear is so finely engineered that it can master even the most unusual terrains.

Over boulders.

The electronically controlled 4XMOTION distributes the engine's torque between the front and rear axle and applies it to each wheel individually when required. If necessary, it adapts torque distribution automatically several times a second.

Cornering.

Servotronic steering regulates power assistance to the steering according to speed. At high speed, resistance is increased so you have a maximum feel for the road. While, when manoeuvring or parking, assistance is increased, so minimum effort is required.

In the city.

State-of-the-art double wishbone suspension on each axle ensures the simplicity, comfort and precision of a luxury saloon.

In the mountains.

At just a turn of the control knob, the CDC air suspension raises your Touareg up by 140 mm. This allows you to gain 300 mm of ground clearance for extreme off-road situations.



In ice and snow.

The gear ratio can be adjusted on the Touareg ensuring optimal handling in any situation. In the 'Low' setting, it translates engine speed into extremely powerful traction on slippery terrain and off-road.



Whether a manual or automatic tiptronic gearbox, the six gears transfer engine power to the wheels with maximum control. Thanks to the Dynamic Shift Program (DSP), the automatic system even recognises your gear changing patterns and adapts intelligently to your driving style.



ADAPT TO CHANGING LANDSCAPES
WITH THE GREATEST OF EASE USING CDC.

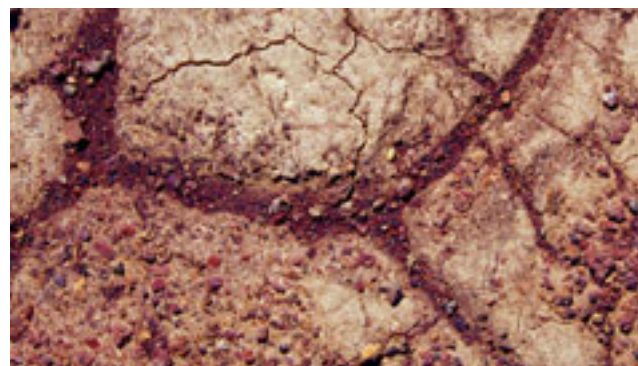

Maximum comfort even on uneven surfaces. If you set the damper adjustment control to 'Comfort', you will get to know cracks and potholes in the road from their more pleasant side. On this setting, the electronic damper control interacts with the sensors of the skyhook system to absorb even the biggest of bumps.

Optimal ground contact. The Touareg's two Electronic Differential Locks (EDL) always ensure optimal traction on slippery surfaces such as sand or grass. If necessary, up to 100% of the power is directed onto the wheel with the best traction.

Muddiest depths and impressive ground clearance. Turn the control as far as it will go and the Continuous Damping Control (CDC) air suspension lifts the Touareg. Now, even water depth up to 580 mm and 33 degree embankments no longer present a problem.

Dynamic, sporty driving performance. On level surfaces, it is comfortable shock absorption and road holding that count. The Touareg negotiates both with the utmost ease. The running gear also lowers automatically up to 35 mm at high speeds.

DISCOVER EXTREME DRIVING IN FIVE EASY LESSONS.

Rivers, mountains and deserts present some of the most difficult driving challenges in the world. So, anyone wishing to conquer them needs a vehicle with excellent off-road capabilities. And maybe a few tips on putting it into practice.

Gradients*: 28° (33° with CDC). The Touareg can scale up embankments, gradients and hills without its bumper touching the ground. Avoid using the clutch or changing gear during the climbing phase and don't accelerate any more than necessary.

Fording depth: up to 500 mm (580 mm with CDC). With the Touareg you can get through water safely and comfortably. Drive in with the direction of flow and then continue driving to the opposite bank at a constant speed – avoiding bow waves!

Ramp angle: 22° (27° with CDC). A Touareg will even overcome large tree trunks, rocks or hills without bottoming out. Watch out for troughs or soft subsoil behind the obstacle which might have a detrimental effect on ground clearance.

Climbing capability: 45°. The Touareg allows you to conquer even the steepest of slopes. First check what is over the hill. After all, on extreme slopes, you are actually looking directly into the sky, not at the ground.

Banking: 35°. Even on sloping terrain, the Touareg drives with ultimate safety. If it leans too far, don't brake, but rather steer the vehicle quickly into the fall line. This way, you can safely bring it under control.

*Gradient reduced with Altitude and R50 body styling kit.



Model shown is SE V10 TDI DPF.

PAINT.

NON-METALLIC

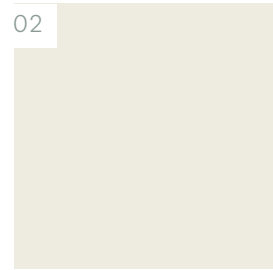
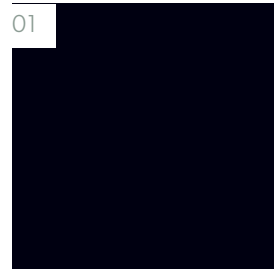
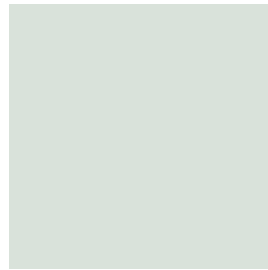

- 01 Black¹
- 02 Campanella White

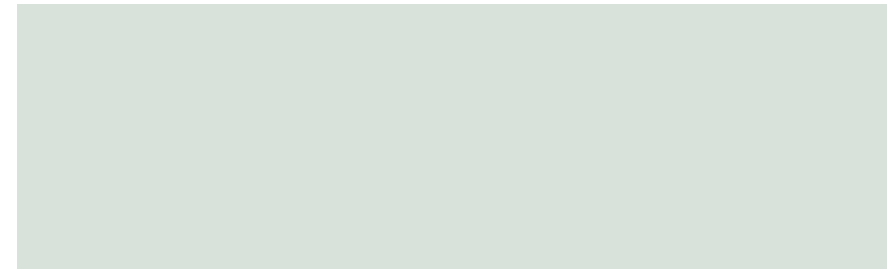

METALLIC

Standard – V10 TDI DPF, R50 models
Optional at extra cost

- Shadow Blue²
- Atacama Grey²
- Arctic Blue Silver²
- Reflex Silver
- Galapagos²

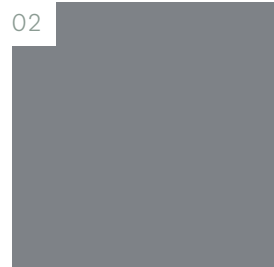

- 01 Shadow Blue²
- 02 Atacama Grey²
- 03 Arctic Blue Silver²
- 04 Reflex Silver
- 05 Galapagos²

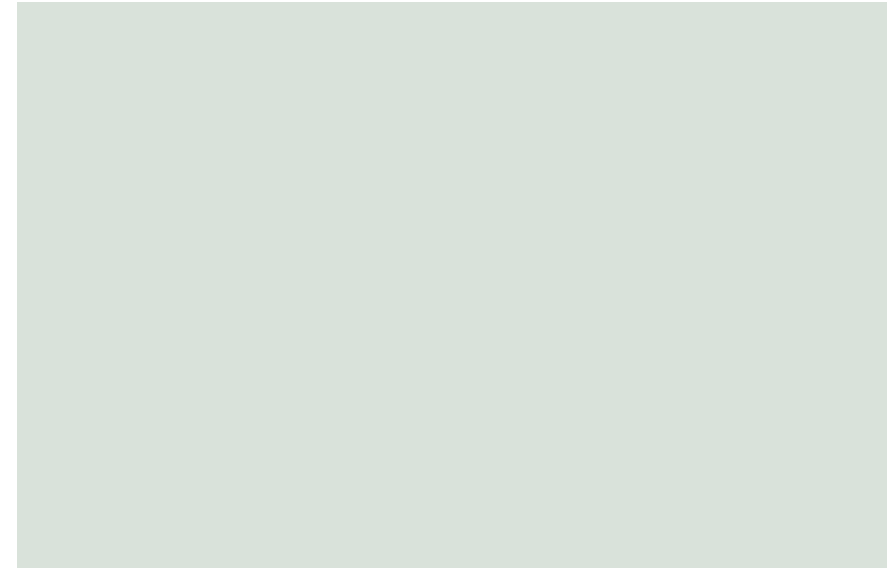
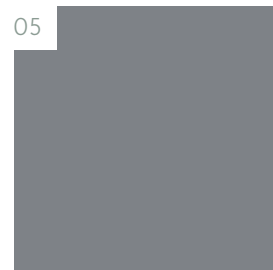
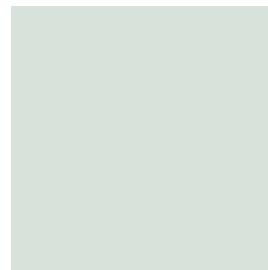

PEARL EFFECT

Standard – V10 TDI DPF, R50 models
Optional at extra cost

- Diamond Black
- Biscay Blue³

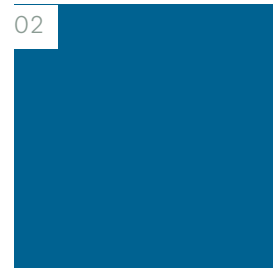
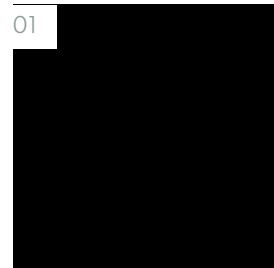
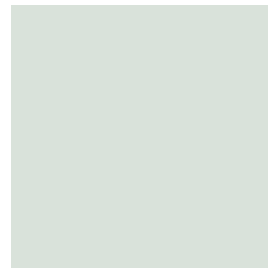

- 01 Diamond Black
- 02 Biscay Blue³

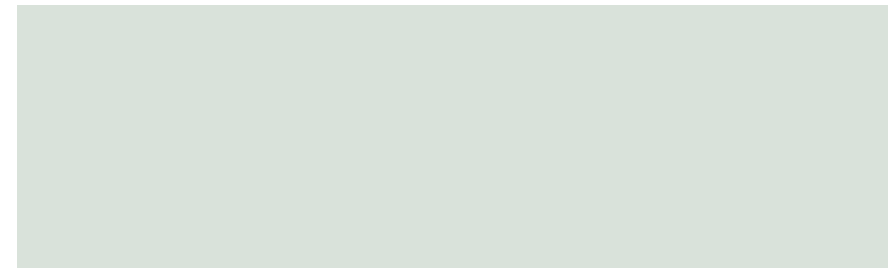

Please note: Screen technology does not allow exact reproduction of the paint colours.

¹ Not available on Altitude or R50 models.
² Not available on R50 models.
³ Only available on R50 models.

UPHOLSTERY.

'TRAIL' CLOTH
Standard – Entry Touareg

Anthracite
Crystal Grey

01 Anthracite
02 Crystal Grey

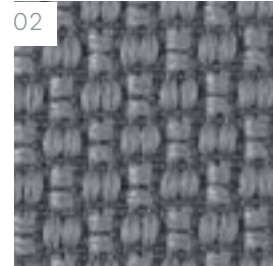
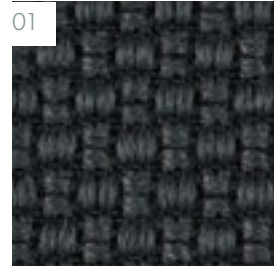

'CRICKET' LEATHER*
Standard – SE, Altitude
Optional – Entry Touareg

Anthracite
Pure Beige

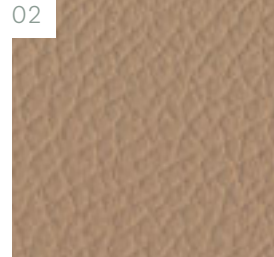
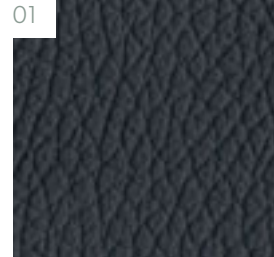

01 Anthracite
02 Pure Beige

'NAPPA' LEATHER*
Standard – R50
Optional – SE, Altitude

Anthracite
Crystal Grey¹
Latte¹
Pure Beige¹

01 Anthracite
02 Crystal Grey¹
03 Latte¹
04 Pure Beige¹

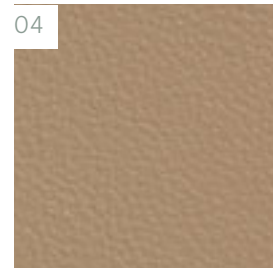
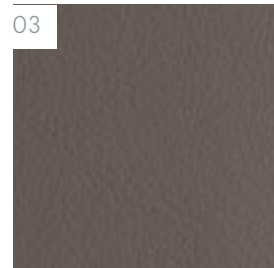
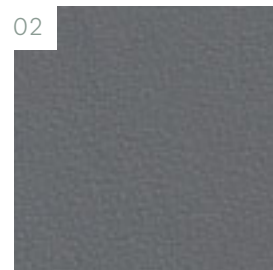
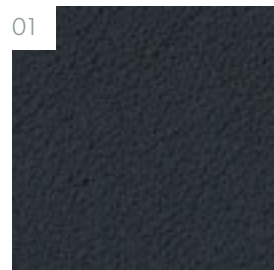

Please note: Screen technology does not allow exact reproduction of the upholstery colours.
* Some parts of leather interior will contain artificial leather.
¹ Not available on R50 models.

DECORATIVE INSERTS.

'ANTHRACITE' DECORATIVE INSERTS

Standard – Entry Touareg

'Anthracite'

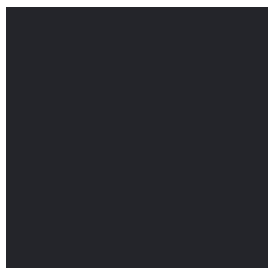

'WALNUT' DECORATIVE INSERTS

Standard – SE
Optional – Entry Touareg, Altitude

'Walnut'

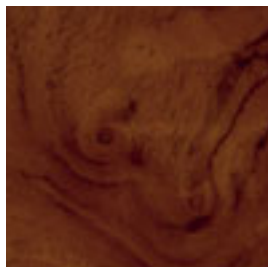

'PIANO BLACK' DECORATIVE INSERTS

Standard – Altitude
Optional – SE

'Piano Black'

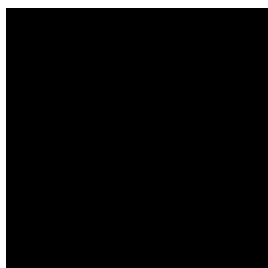

'ENGINE SPIN' DECORATIVE INSERTS

Standard – R50
Optional – SE, Altitude

01 'Engine spin'¹
02 'Engine spin'²

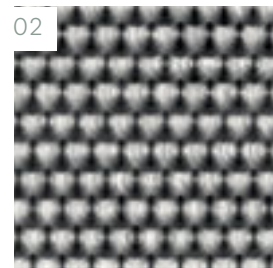
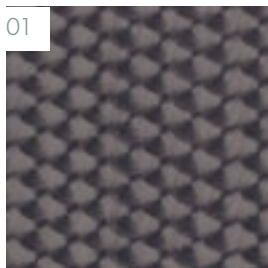

Please note: Screen technology does not allow exact reproduction of the decorative insert colours.

1 Not available on R50 models.

2 Only available on R50 models.

COMBINATIONS.

	SEAT UPHOLSTERY	DECORATIVE TRIM	DASHBOARD	CARPETS	Black ¹	Campanella White	Shadow Blue Metallic ²	Atacama Grey Metallic ²	Arctic Blue Silver Metallic ²	Reflex Silver Metallic ²	Galapagos Metallic ²	Diamond Black Pearl Effect ²	Biscay Blue Pearl Effect ³
'TRAIL' CLOTH UPHOLSTERY ON NORMAL SEATS Standard – Entry Touareg	Anthracite	Anthracite	Anthracite	Anthracite	•	•	•	•	•	•	•	•	
	Crystal Grey	Anthracite	Crystal Grey	Crystal Grey	•	•	•	•	•	•	•	•	
'CRICKET' LEATHER* ON NORMAL SEATS Standard – SE, Altitude	Anthracite	Walnut/Piano Black	Anthracite	Anthracite	•	•	•	•	•	•	•	•	
	Pure Beige	Walnut/Piano Black	Dark Beige	Pure Beige	•		•	•			•	•	
'CRICKET' LEATHER* ON NORMAL SEATS Optional – Entry Touareg	Anthracite	Anthracite	Anthracite	Anthracite	•	•	•	•	•	•	•	•	
	Pure Beige	Anthracite	Dark Beige	Pure Beige	•		•	•			•	•	
'CRICKET' LEATHER* ON COMFORT SEATS Optional – SE, Altitude Standard – V10 TDI DPF models	Anthracite	Walnut/Piano Black	Anthracite	Anthracite	•	•	•	•	•	•	•	•	
	Pure Beige	Walnut/Piano Black	Dark Beige	Pure Beige	•		•	•			•	•	
'NAPPA' LEATHER* ON COMFORT SEATS Standard – R50	Anthracite	Engine spin	Anthracite	Anthracite		•				•		•	•
'NAPPA' LEATHER* ON COMFORT SEATS Optional – SE, Altitude	Anthracite	Walnut/Piano Black	Anthracite	Anthracite	•	•	•	•	•	•	•	•	
	Crystal Grey	Walnut/Piano Black	Crystal Grey	Crystal Grey	•	•	•	•	•	•	•	•	
	Latte	Walnut/Piano Black	Dark Latte	Latte	•		•	•			•	•	
	Pure Beige	Walnut/Piano Black	Dark Beige	Pure Beige	•		•	•			•	•	

* Some parts of leather interior will contain artificial leather.

1 Not available on Altitude and R50 models.

2 Metallic and Pearl Effect paint are optional at extra cost. Standard on V10 TDI DPF and R50 models.

3 Only available on R50 models.

THE POWER OF A TRUE OFF-ROAD PERFORMER.

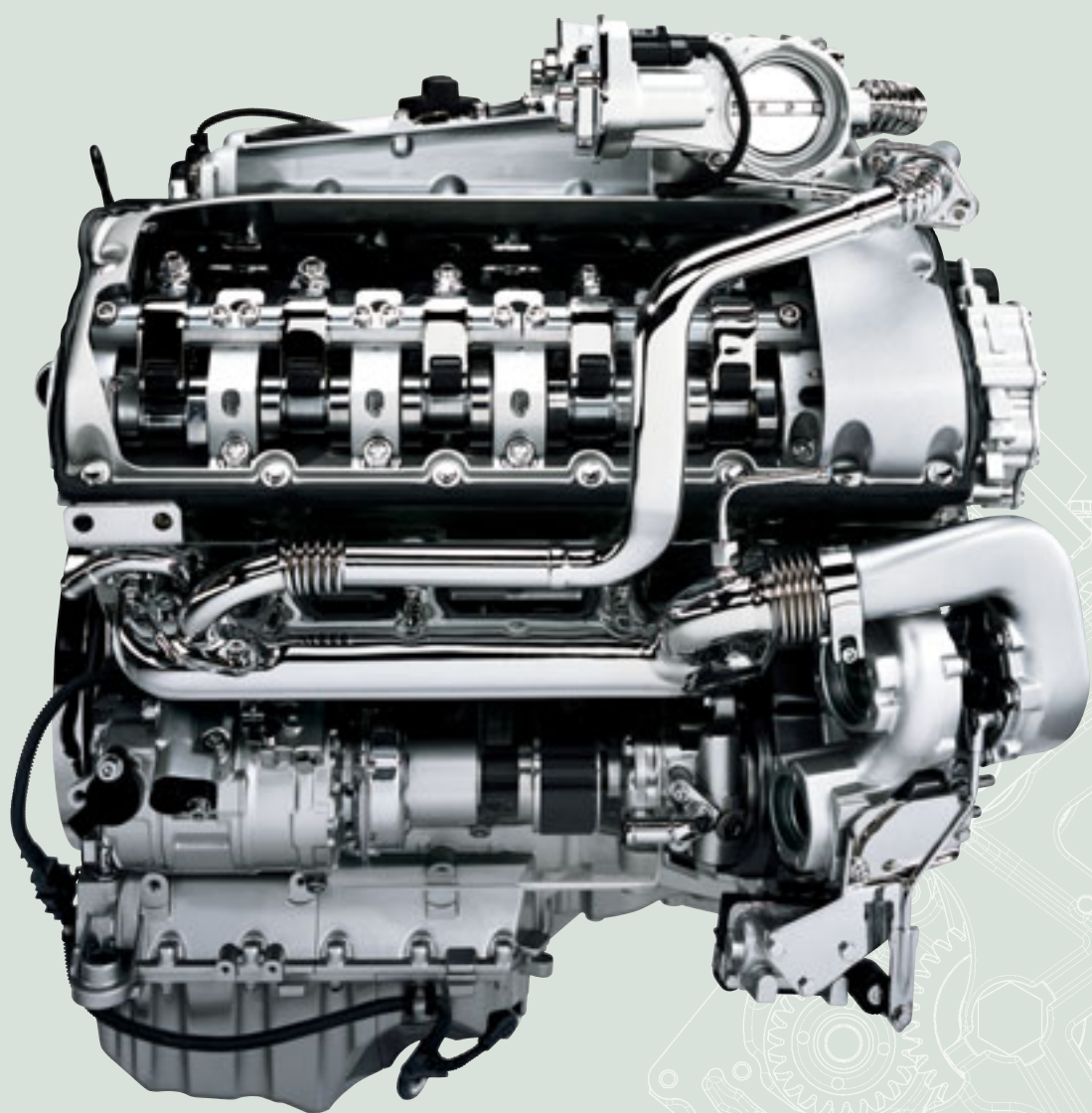

The phenomenal V10 TDI DPF generates an incredible 313 PS.

What the exterior styling of the Touareg promises, the powerful engines deliver. City streets, fast roads or desolate terrain, there is plenty of power in reserve, ensuring exceptional performance both on- and off-road. A choice of a petrol engine or four diesel engines all use powerful torque to achieve acceleration and performance throughout the rev range. Together with 4XMOTION four wheel drive and Electronic Differential Lock (EDL) they distribute power intelligently to all four wheels, ensuring maximum ride comfort whatever the terrain.

THE 2.5 TDI DPF.

Smooth and efficient, the 2.5 TDI DPF 174 PS delivers everything you would expect from a Volkswagen diesel: 0-62 mph in 11.5 seconds and a maximum torque of 400 Nm at 2,250 rpm.

THE 3.6 V6.

In any situation, superb performance is provided by this 280 PS engine. Developing peak torque of 360 Nm at 2,500 rpm, it can accelerate from standstill to 62 mph in just 8.6 seconds.

THE 3.0 V6 TDI CR.

Featuring the latest common rail technology, this engine not only ensures excellent performance and fuel consumption but also makes it incredibly quiet. The 3.0 V6 TDI CR develops 500 Nm of torque at just 2,000 rpm with an equally impressive acceleration of 0-62 mph in 8.3 seconds.

THE 5.0 V10 TDI DPF.

The V10 TDI DPF has totally changed the image of a diesel, which is not surprising from a 4x4 that develops 313 PS, and an incredible 750 Nm of torque at just 2,000 rpm. From standstill, 62 mph can be reached in just 7.4 seconds and a top speed of 144 mph, where the law permits. If you specify the R50, you get an engine that develops an awesome 350 PS, and 850 Nm of torque at only 2,000 rpm. This incredible engine achieves a top speed of 146 mph where the law permits and accelerates the R50 from standstill to 62 mph in just 6.7 seconds.

THE DIESEL PARTICULATE FILTER (DPF).

As part of Volkswagen's desire to satisfy European emissions legislation, all Touareg diesel engines are now available with a Diesel Particulate Filter (DPF). This is part of the exhaust system responsible for cleaning the exhaust gases before they enter the atmosphere. In addition to converting the harmful exhaust gases in the same way as a conventional catalytic converter, the DPF uses advanced technology to reduce the emission of black smoke and soot. It filters the exhaust gases and particles before they leave the vehicle exhaust system, resulting in a cleaner environment and less pollution entering the atmosphere.

Please note, driving conditions within inner-cities and the Channel Islands may not provide optimum conditions for the use of DPF technology. Therefore, it is advised that you consider this before ordering your vehicle with DPF.

TOUAREG, SE, ALTITUDE – 2.5 LITRE TDI DPF 174 PS. TECHNICAL SPECIFICATION.

ENGINE	
Engine type	Five cylinder diesel
Cubic capacity, ltrs/cc	2.5/2461
Max. output, PS ⁽⁰¹⁾ /kW at rpm	174/128 3500
Max. torque, lbs.ft/Nm at rpm	295/400 2250
Gearbox	Six speed manual Six speed auto tiptronic

WEIGHTS, KGS	
Unladen weight ⁽⁰²⁾	2247 (2267)
Gross vehicle weight ⁽⁰²⁾	2850
Payload ⁽⁰²⁾	603 (583)
Axle load limit: Front Rear	1425 1640

TRAILER LOAD LIMITS, KGS ⁽⁰³⁾	
Braked 12% incline	3500
Unbraked	750
Nose weight	140
Roof weight	100

INTERIOR DIMENSIONS	
Effective front head room, mm (sunroof)	1008 (983)
Effective rear head room, mm (sunroof)	987 (982)
Front elbow width, mm	1504
Rear elbow width, mm	1505

MAXIMUM LUGGAGE CAPACITY, LITRES (VDA measuring method using 200 x 100 x 50 mm blocks)	
Capacity – rear seats upright	555/500*
Capacity – rear seats folded	1570/1525*

PERFORMANCE	
Top speed, mph (km/h) – where law permits With manual gearbox steel spring	117 (188)
With manual gearbox air spring	121 (194)
With automatic gearbox steel spring	114 (183)
With automatic gearbox air spring	117 (188)
Acceleration, seconds 0 - 62 mph With manual gearbox	11.5
With automatic gearbox	11.6
ABI insurance group	15

ENVIRONMENTAL INFORMATION	
Fuel grade, minimum	Diesel 51 CN ⁽⁰⁴⁾
Fuel tank capacity, galls/ltr	22/100
Official fuel consumption, mpg/ltr per 100 km ⁽⁰⁶⁾ Urban	22.8/12.4 (22.8/12.4)
Extra-urban	38.2/7.4 (36.2/7.8)
Combined	30.7/9.2 (29.7/9.5)
Official CO ₂ emission, g/km ⁽⁰⁷⁾	243 (249)
Emission class – manual gearbox	EURO 4
Emission class – automatic gearbox	EURO 4
Noise, dB – manual gearbox	76
Noise, dB – automatic gearbox	75

EXTERIOR DIMENSIONS	
Length, mm	4754
Width, mm	1928
Height, mm	1726
Wheelbase, mm	2855
Front/rear track width, mm	1649/1661
Turning circle, m	11.6

*Please note the figure shown include either optional leather upholstery,
4Zone electronic climate control or the cargo management system.

- 01 The maximum power output figures are quoted in PS (or Pferdestärke, which is the metric equivalent of horsepower). To convert from metric to imperial horsepower, divide the PS figure by 1.0139. For example, 240 PS is equivalent to 237 bhp.
- 02 Figures are calculated in accordance with manufacturer's criteria. Vehicle unladen weight ranges with 90% tank capacity without driver (75 kg). The individual unladen weight depends on the specification of the vehicle, this then reduces the possible payload accordingly. Figures in () refer to automatic gearboxes.
- 03 With increasing altitude the engine performance diminishes. From 1,000 m above sea level and for every 1,000 m thereafter 10% of the vehicle/trailer weight (trailer weight + gross vehicle weight) must be deducted.
- 04 Fully compatible with 5% bio diesel in accordance with EN590 Standard.
- 05 Thanks to the knock control, unleaded four star (at least 95 RON) can be used instead of unleaded Super plus.
- 06 Official fuel consumption according to EU Directive 99/94. Figures in () refer to automatic gearboxes. The consumption calculation according to 1999/100/EC is based on the actual unladen weight of the vehicle. Additional specifications can lead to a higher weight class and hence to consumption figures of this higher weight class. The driving style, road and traffic conditions, environmental influences and vehicle condition can in practice lead to consumption figures, which may differ from those calculated with this standard.
- 07 The weight of a vehicle will influence the level of CO₂ emission it produces; as a result, vehicles with higher levels of specification and factory-fitted options may emit higher levels of CO₂.

Figures in () refer to automatic gearboxes.

SE, ALTITUDE – 3.6 LITRE V6 280 PS. TECHNICAL SPECIFICATION.

ENGINE	
Engine type	Six cylinder petrol
Cubic capacity, ltrs/cc	3.6/3597
Max. output, PS ⁽⁰¹⁾ /kW at rpm	280/206 6250
Max. torque, lbs.ft/Nm at rpm	265/360 2500
Gearbox	Six speed auto tiptronic

WEIGHTS, KGS	
Unladen weight ⁽⁰²⁾	(2238)
Gross vehicle weight ⁽⁰²⁾	(2945)
Payload ⁽⁰²⁾	(707)
Axle load limit: Front Rear	1415 1640

TRAILER LOAD LIMITS, KGS ⁽⁰³⁾	
Braked 12% incline	3500
Unbraked	750
Nose weight	140
Roof weight	100

INTERIOR DIMENSIONS	
Effective front head room, mm (sunroof)	1008 (983)
Effective rear head room, mm (sunroof)	987 (982)
Front elbow width, mm	1504
Rear elbow width, mm	1505

MAXIMUM LUGGAGE CAPACITY, LITRES (VDA measuring method using 200 x 100 x 50 mm blocks)	
Capacity – rear seats upright	555/500*
Capacity – rear seats folded	1570/1525*

PERFORMANCE	
Top speed, mph (km/h) – where law permits With manual gearbox steel spring	–
With manual gearbox air spring	–
With automatic gearbox steel spring	135 (218)
With automatic gearbox air spring	141 (227)
Acceleration, seconds 0 - 62 mph With manual gearbox	–
With automatic gearbox	8.6
ABI insurance group	17

ENVIRONMENTAL INFORMATION	
Fuel grade, minimum	Unleaded 95 RON ⁽⁰⁵⁾
Fuel tank capacity, galls/ltr	22/100
Official fuel consumption, mpg/ltr per 100 km ⁽⁰⁶⁾ Urban	(15.7/18.0)
Extra-urban	(30.7/9.2)
Combined	(23.2/12.2)
Official CO ₂ emission, g/km ⁽⁰⁷⁾	(296)
Emission class – manual gearbox	–
Emission class – automatic gearbox	EURO 4
Noise, dB – manual gearbox	–
Noise, dB – automatic gearbox	75

EXTERIOR DIMENSIONS	
Length, mm	4754
Width, mm	1928
Height, mm	1726
Wheelbase, mm	2855
Front/rear track width, mm	1649/1661
Turning circle, m	11.6

*Please note the figure shown include either optional leather upholstery, 4Zone electronic climate control or the cargo management system.

- 01 The maximum power output figures are quoted in PS (or Pferdestärke, which is the metric equivalent of horsepower). To convert from metric to imperial horsepower, divide the PS figure by 1.0139. For example, 240 PS is equivalent to 237 bhp.
- 02 Figures are calculated in accordance with manufacturer's criteria. Vehicle unladen weight ranges with 90% tank capacity without driver (75 kg). The individual unladen weight depends on the specification of the vehicle, this then reduces the possible payload accordingly. Figures in () refer to automatic gearboxes.
- 03 With increasing altitude the engine performance diminishes. From 1,000 m above sea level and for every 1,000 m thereafter 10% of the vehicle/trailer weight (trailer weight + gross vehicle weight) must be deducted.
- 04 Fully compatible with 5% bio diesel in accordance with EN590 Standard.
- 05 Thanks to the knock control, unleaded four star (at least 95 RON) can be used instead of unleaded Super plus.
- 06 Official fuel consumption according to EU Directive 99/94. Figures in () refer to automatic gearboxes. The consumption calculation according to 1999/100/EC is based on the actual unladen weight of the vehicle. Additional specifications can lead to a higher weight class and hence to consumption figures of this higher weight class. The driving style, road and traffic conditions, environmental influences and vehicle condition can in practice lead to consumption figures, which may differ from those calculated with this standard.
- 07 The weight of a vehicle will influence the level of CO₂ emission it produces; as a result, vehicles with higher levels of specification and factory-fitted options may emit higher levels of CO₂.

Figures in () refer to automatic gearboxes.

TOUAREG, SE, ALTITUDE – 3.0 LITRE V6 TDI CR 240 PS. TECHNICAL SPECIFICATION.

ENGINE	
Engine type	Six cylinder diesel
Cubic capacity, ltrs/cc	3.0/2967
Max. output, PS ⁽⁰¹⁾ /kW at rpm	240/176 4000
Max. torque, lbs.ft/Nm at rpm	369/500 2000
Gearbox	Six speed auto tiptronic

WEIGHTS, KGS	
Unladen weight ⁽⁰²⁾	(2321)
Gross vehicle weight ⁽⁰²⁾	(2945)
Payload ⁽⁰²⁾	(624)
Axle load limit: Front Rear	1510 1650

TRAILER LOAD LIMITS, KGS ⁽⁰³⁾	
Braked 12% incline	3500
Unbraked	750
Nose weight	140
Roof weight	100

INTERIOR DIMENSIONS	
Effective front head room, mm (sunroof)	1008 (983)
Effective rear head room, mm (sunroof)	987 (982)
Front elbow width, mm	1504
Rear elbow width, mm	1505

MAXIMUM LUGGAGE CAPACITY, LITRES (VDA measuring method using 200 x 100 x 50 mm blocks)	
Capacity – rear seats upright	555/500*
Capacity – rear seats folded	1570/1525*

Six cylinder diesel
3.0/2967
240/176 4000
369/500 2000
Six speed auto tiptronic

(2321)
(2945)
(624)
1510 1650

3500
750
140
100

1008 (983)
987 (982)
1504
1505

555/500*
1570/1525*

PERFORMANCE	
Top speed, mph (km/h) – where law permits With manual gearbox steel spring	–
With manual gearbox air spring	–
With automatic gearbox steel spring	127 (204)
With automatic gearbox air spring	131 (211)
Acceleration, seconds 0 - 62 mph With manual gearbox	–
With automatic gearbox	8.3
ABI insurance group	TBA

ENVIRONMENTAL INFORMATION	
Fuel grade, minimum	Diesel 51 CN ⁽⁰⁴⁾
Fuel tank capacity, galls/ltr	22/100
Official fuel consumption, mpg/ltr per 100 km ⁽⁰⁶⁾ Urban	(24.4/11.6)
Extra-urban	(35.8/7.9)
Combined	(30.4/9.3)
Official CO ₂ emission, g/km ⁽⁰⁷⁾	(244)
Emission class – manual gearbox	–
Emission class – automatic gearbox	EURO 5
Noise, dB – manual gearbox	–
Noise, dB – automatic gearbox	71

EXTERIOR DIMENSIONS	
Length, mm	4754
Width, mm	1928
Height, mm	1726
Wheelbase, mm	2855
Front/rear track width, mm	1649/1661
Turning circle, m	11.6

*Please note the figure shown include either optional leather upholstery,
4Zone electronic climate control or the cargo management system.

–
–
127 (204)
131 (211)
–
8.3
TBA

Diesel 51 CN ⁽⁰⁴⁾
22/100
(24.4/11.6)
(35.8/7.9)
(30.4/9.3)
(244)
–
EURO 5
–
71

4754
1928
1726
2855
1649/1661
11.6

- 01 The maximum power output figures are quoted in PS (or Pferdestärke, which is the metric equivalent of horsepower). To convert from metric to imperial horsepower, divide the PS figure by 1.0139. For example, 240 PS is equivalent to 237 bhp.
- 02 Figures are calculated in accordance with manufacturer's criteria. Vehicle unladen weight ranges with 90% tank capacity without driver (75 kg). The individual unladen weight depends on the specification of the vehicle, this then reduces the possible payload accordingly. Figures in () refer to automatic gearboxes.
- 03 With increasing altitude the engine performance diminishes. From 1,000 m above sea level and for every 1,000 m thereafter 10% of the vehicle/trailer weight (trailer weight + gross vehicle weight) must be deducted.
- 04 Fully compatible with 5% bio diesel in accordance with EN590 Standard.
- 05 Thanks to the knock control, unleaded four star (at least 95 RON) can be used instead of unleaded Super plus.
- 06 Official fuel consumption according to EU Directive 99/94. Figures in () refer to automatic gearboxes. The consumption calculation according to 1999/100/EC is based on the actual unladen weight of the vehicle. Additional specifications can lead to a higher weight class and hence to consumption figures of this higher weight class. The driving style, road and traffic conditions, environmental influences and vehicle condition can in practice lead to consumption figures, which may differ from those calculated with this standard.
- 07 The weight of a vehicle will influence the level of CO₂ emission it produces; as a result, vehicles with higher levels of specification and factory-fitted options may emit higher levels of CO₂.

Figures in () refer to automatic gearboxes.

SE, ALTITUDE – 5.0 LITRE V10 TDI DPF 313 PS. TECHNICAL SPECIFICATION.

ENGINE	
Engine type	10 cylinder diesel
Cubic capacity, ltrs/cc	5.0/4921
Max. output, PS ⁽⁰¹⁾ /kW at rpm	313/230 3750
Max. torque, lbs.ft/Nm at rpm	553/750 2000
Gearbox	Six speed auto tiptronic

WEIGHTS, KGS	
Unladen weight ⁽⁰²⁾	(2602)
Gross vehicle weight ⁽⁰²⁾	(3200)
Payload ⁽⁰²⁾	(598)
Axle load limit: Front Rear	1635 1670

TRAILER LOAD LIMITS, KGS ⁽⁰³⁾	
Braked 12% incline	3500
Unbraked	750
Nose weight	140
Roof weight	100

INTERIOR DIMENSIONS	
Effective front head room, mm (sunroof)	1008 (983)
Effective rear head room, mm (sunroof)	987 (982)
Front elbow width, mm	1504
Rear elbow width, mm	1505

MAXIMUM LUGGAGE CAPACITY, LITRES (VDA measuring method using 200 x 100 x 50 mm blocks)	
Capacity – rear seats upright	500*
Capacity – rear seats folded	1525*

10 cylinder diesel
5.0/4921
313/230 3750
553/750 2000
Six speed auto tiptronic

(2602)
(3200)
(598)
1635 1670

3500
750
140
100

1008 (983)
987 (982)
1504
1505

500*
1525*

PERFORMANCE	
Top speed, mph (km/h) – where law permits With manual gearbox steel spring	–
With manual gearbox air spring	–
With automatic gearbox steel spring	–
With automatic gearbox air spring	144 (231)
Acceleration, seconds 0 - 62 mph With manual gearbox	–
With automatic gearbox	7.4
ABI insurance group	19

ENVIRONMENTAL INFORMATION	
Fuel grade, minimum	Diesel 51 CN ⁽⁰⁴⁾
Fuel tank capacity, galls/ltr	22/100
Official fuel consumption, mpg/ltr per 100 km ⁽⁰⁶⁾ Urban	(16.9/16.7)
Extra-urban	(30.7/9.2)
Combined	(23.7/11.9)
Official CO ₂ emission, g/km ⁽⁰⁷⁾	(315)
Emission class – manual gearbox	–
Emission class – automatic gearbox	EURO 4
Noise, dB – manual gearbox	–
Noise, dB – automatic gearbox	74

EXTERIOR DIMENSIONS	
Length, mm	4754
Width, mm	1928
Height, mm	1703
Wheelbase, mm	2855
Front/rear track width, mm	1645/1657
Turning circle, m	11.6

*Please note the figure shown include either optional leather upholstery,
4Zone electronic climate control or the cargo management system.

–
–
–
144 (231)
–
7.4
19

Diesel 51 CN ⁽⁰⁴⁾
22/100
(16.9/16.7)
(30.7/9.2)
(23.7/11.9)
(315)
–
EURO 4
–
74

4754
1928
1703
2855
1645/1657
11.6

- 01 The maximum power output figures are quoted in PS (or Pferdestärke, which is the metric equivalent of horsepower). To convert from metric to imperial horsepower, divide the PS figure by 1.0139. For example, 240 PS is equivalent to 237 bhp.
- 02 Figures are calculated in accordance with manufacturer's criteria. Vehicle unladen weight ranges with 90% tank capacity without driver (75 kg). The individual unladen weight depends on the specification of the vehicle, this then reduces the possible payload accordingly. Figures in () refer to automatic gearboxes.
- 03 With increasing altitude the engine performance diminishes. From 1,000 m above sea level and for every 1,000 m thereafter 10% of the vehicle/trailer weight (trailer weight + gross vehicle weight) must be deducted.
- 04 Fully compatible with 5% bio diesel in accordance with EN590 Standard.
- 05 Thanks to the knock control, unleaded four star (at least 95 RON) can be used instead of unleaded Super plus.
- 06 Official fuel consumption according to EU Directive 99/94. Figures in () refer to automatic gearboxes. The consumption calculation according to 1999/100/EC is based on the actual unladen weight of the vehicle. Additional specifications can lead to a higher weight class and hence to consumption figures of this higher weight class. The driving style, road and traffic conditions, environmental influences and vehicle condition can in practice lead to consumption figures, which may differ from those calculated with this standard.
- 07 The weight of a vehicle will influence the level of CO₂ emission it produces; as a result, vehicles with higher levels of specification and factory-fitted options may emit higher levels of CO₂.

Figures in () refer to automatic gearboxes.

R50 – 5.0 LITRE V10 TDI DPF 350 PS. TECHNICAL SPECIFICATION.

ENGINE	
Engine type	10 cylinder diesel
Cubic capacity, ltrs/cc	5.0/4921
Max. output, PS ⁽⁰¹⁾ /kW at rpm	350/258 3500
Max. torque, lbs.ft/Nm at rpm	590/850 2000
Gearbox	Six speed auto tiptronic

WEIGHTS, KGS	
Unladen weight ⁽⁰²⁾	(2602)
Gross vehicle weight ⁽⁰²⁾	(3200)
Payload ⁽⁰²⁾	(598)
Axle load limit: Front Rear	1635 1670

TRAILER LOAD LIMITS, KGS ⁽⁰³⁾	
Braked 12% incline	3500
Unbraked	750
Nose weight	140
Roof weight	100

INTERIOR DIMENSIONS	
Effective front head room, mm (sunroof)	1008 (983)
Effective rear head room, mm (sunroof)	987 (982)
Front elbow width, mm	1504
Rear elbow width, mm	1505

MAXIMUM LUGGAGE CAPACITY, LITRES (VDA measuring method using 200 x 100 x 50 mm blocks)	
Capacity – rear seats upright	500*
Capacity – rear seats folded	1525*

PERFORMANCE	
Top speed, mph (km/h) – where law permits With manual gearbox steel spring	–
With manual gearbox air spring	–
With automatic gearbox steel spring	–
With automatic gearbox air spring	146 (235)
Acceleration, seconds 0 - 62 mph With manual gearbox	–
With automatic gearbox	6.7
ABI insurance group	TBA

ENVIRONMENTAL INFORMATION	
Fuel grade, minimum	Diesel 51 CN ⁽⁰⁴⁾
Fuel tank capacity, galls/ltr	22/100
Official fuel consumption, mpg/ltr per 100 km ⁽⁰⁶⁾ Urban	(16.9/16.7)
Extra-urban	(30.7/9.2)
Combined	(23.7/11.9)
Official CO ₂ emission, g/km ⁽⁰⁷⁾	(315)
Emission class – manual gearbox	–
Emission class – automatic gearbox	EURO 4
Noise, dB – manual gearbox	–
Noise, dB – automatic gearbox	72

EXTERIOR DIMENSIONS	
Length, mm	4754
Width, mm	1977
Height, mm	1703
Wheelbase, mm	2855
Front/rear track width, mm	1645/1657
Turning circle, m	11.6

*Please note the figure shown include either optional leather upholstery, 4Zone electronic climate control or the cargo management system.

- 01 The maximum power output figures are quoted in PS (or Pferdestärke, which is the metric equivalent of horsepower). To convert from metric to imperial horsepower, divide the PS figure by 1.0139. For example, 240 PS is equivalent to 237 bhp.
- 02 Figures are calculated in accordance with manufacturer's criteria. Vehicle unladen weight ranges with 90% tank capacity without driver (75 kg). The individual unladen weight depends on the specification of the vehicle, this then reduces the possible payload accordingly. Figures in () refer to automatic gearboxes.
- 03 With increasing altitude the engine performance diminishes. From 1,000 m above sea level and for every 1,000 m thereafter 10% of the vehicle/trailer weight (trailer weight + gross vehicle weight) must be deducted.
- 04 Fully compatible with 5% bio diesel in accordance with EN590 Standard.
- 05 Thanks to the knock control, unleaded four star (at least 95 RON) can be used instead of unleaded Super plus.
- 06 Official fuel consumption according to EU Directive 99/94. Figures in () refer to automatic gearboxes. The consumption calculation according to 1999/100/EC is based on the actual unladen weight of the vehicle. Additional specifications can lead to a higher weight class and hence to consumption figures of this higher weight class. The driving style, road and traffic conditions, environmental influences and vehicle condition can in practice lead to consumption figures, which may differ from those calculated with this standard.
- 07 The weight of a vehicle will influence the level of CO₂ emission it produces; as a result, vehicles with higher levels of specification and factory-fitted options may emit higher levels of CO₂.

Figures in () refer to automatic gearboxes.

THE TECHNOLOGY.

ENGINES

- 2.5 litre TDI DPF/128 kW (174 PS⁽⁰¹⁾) diesel engine.
Five cylinder in-line engine, two valves per cylinder utilising crossflow principle, aluminium cylinder crankcase with plasma coated bores, 'Pumpe Düse' high pressure injection system, variable vane turbocharger, electronic accelerator engine control
- 3.6 litre/206 kW (280 PS⁽⁰¹⁾) V6 petrol engine.
Six cylinder 'V' engine, four valves per cylinder, electronic direct injection (FSI), grey cast iron cylinder crankcase, cylinder angle 10.6° in VR design, bore 89 mm, stroke 96.4 mm, connecting rod length 164 mm, cylinder distance 64 mm, valve drive via roller rocker arms, continuous inlet and exhaust camshaft adjustment, single spark ignition, electronic accelerator engine control
- 3.0 litre TDI CR/176 kW (240 PS) V6 diesel engine.
Six cylinder 'V' engine, four valves per cylinder, two overhead camshafts per cylinder bank, turbocharger with variable turbine geometry, valve drive via roller valve levers, injection system of the third generation with Piezo inline injectors and 1,600 bar injection pressure
- 5.0 litre TDI DPF/230 kW (313 PS) V10 diesel engine.
10 cylinder 'V' engine, aluminium cylinder crankcase, 'Pumpe Düse' high pressure injection system, twin turbochargers with electronic boost adjustment, bore 81 mm, stroke 95.5 mm, connecting rod length 144 mm, cylinder distance 88 mm, compression 18.5 : 1, engine management with master-slave principle
- 5.0 litre TDI DPF/258 kW (350 PS⁽⁰¹⁾) V10 diesel engine.
10 cylinder 'V' engine, aluminium cylinder crankcase, 'Pumpe Düse' high pressure injection system, twin turbochargers with electronic boost adjustment, bore 81 mm, stroke 95.5 mm, connecting rod length 144 mm, cylinder distance 88 mm, compression 18.5 : 1, engine management with master-slave principle

TRANSMISSION

- Permanent four wheel drive, central differential with electronically controlled friction-disc lock and low range gearing, four wheel EDL
- 2.5 TDI DPF: Six speed manual gearbox
Six speed automatic tiptronic gearbox
- V6: Six speed automatic tiptronic gearbox
- V6 TDI DPF: Six speed automatic tiptronic gearbox
- V10 TDI DPF: Six speed automatic tiptronic gearbox

RUNNING GEAR

- Front and rear independent suspension on double wishbones with acoustically insulated subframes
- Front and rear anti-roll bar

EXTERIOR DIMENSIONS

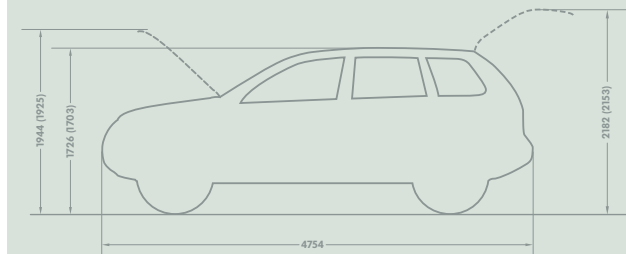
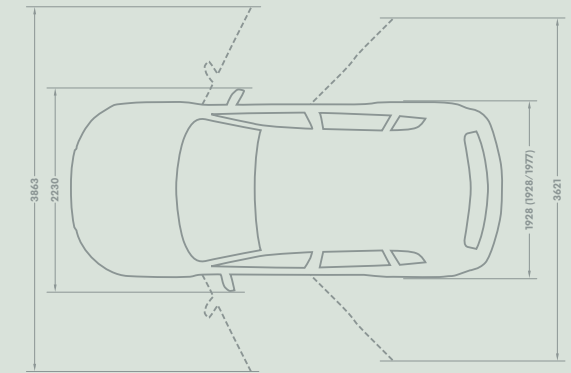

All figures in millimetres.

Figures in brackets are V10 TDI DPF/R50.

01 The maximum power output figures are quoted in PS (or Pferdestärke, which is the metric equivalent of horsepower). To convert from metric to imperial horsepower, divide the PS figure by 1.0139. For example, 240 PS is equivalent to 237 bhp.

THE OWNERSHIP EXPERIENCE.



Owning and driving a Touareg is an extremely rewarding experience. It's not just the performance, build quality, comfort and practicality that satisfies, the level of after-sales support is exemplary. To deliver such high levels of service, we've introduced a network of specialist service outlets, all having the necessary specialist equipment and high levels of skills required to look after your car.

Within each specialist service outlet we have introduced a new team member. Licensed Technicians meet the highest standards within their field for professionalism, skill and knowledge. Our aim is to make buying and looking after your car more enjoyable.

When it comes to servicing, we appreciate that it may be more convenient for us to visit you. So, whether you're at home or the office, one quick and easy phone call is all it takes to arrange for a convenient collection and delivery.

Naturally, we'll provide you with a replacement Volkswagen and we have also set up a dedicated telephone line for Touareg owners. Our Luxury Car Support Centre is open six days a week, and is a single point of contact for Touareg owners.

COMPREHENSIVE COVER FROM VOLKSWAGEN ROADSIDE ASSISTANCE.



Your Touareg is covered by the excellent support service of Volkswagen Roadside Assistance for the first three years after registration. This is a 24 hour, 365 days a year pan-European emergency home and roadside recovery service manned by professional multilingual staff. It's not just there for the unlikely event of a breakdown, Volkswagen Roadside Assistance can ease the uncertainty following an accident or the inconvenience should you run out of fuel or lose your keys. You will benefit from a priority response following your call to our dedicated team of support staff.

Volkswagen Roadside Assistance provides many benefits and complete peace of mind. For example, should you be in the unfortunate situation of a breakdown, we'll arrange overnight accommodation or onward travel for you and your passengers. In addition, there's an Accident and Legal Helpline.

Terms and conditions apply. Please see your authorised Volkswagen Luxury car specialist retailer for details and brochure.

VOLKSWAGEN SERVICE FOR YOUR PEACE OF MIND.

The Volkswagen Warranty. Three-year Warranty.

All Volkswagen Touaregs come with a three-year/60,000 miles warranty, which protects your car against the failure of most mechanical and electrical components due to manufacturing defects. This comprises a two-year manufacturer's warranty with unlimited mileage plus a further one-year/60,000 miles (whichever is soonest) Retailer Warranty. Should the mileage exceed 60,000 miles within the first two years, the manufacturer's two-year warranty will still be valid. If an additional warranty for subsequent years or higher mileage is desired, it may be purchased from any authorised Volkswagen luxury car specialist retailer; however, this additional warranty must be purchased before the mileage reaches 60,000*. Full details of the three-year warranty are available from your authorised Volkswagen luxury car specialist retailer. This three-year warranty is only available on vehicles purchased in the UK through an authorised Volkswagen luxury car specialist retailer.

* All warranty work must be completed by an authorised Volkswagen luxury car specialist retailer or repairer.

Three-year Paint Warranty. The paintwork of the Touareg is covered against manufacturing defects for a period of three years. Naturally, the Touareg must be cared for in compliance with the operating instructions which will be found in your vehicle handbook. Please consult your authorised Volkswagen luxury car specialist retailer or repairer for full warranty details.

12-year Body Protection Warranty. The internal body sections and panels of the Touareg are covered against rusting through from the inside for a period of 12 years. Naturally, the Touareg must be cared for in compliance with the operating instructions. Please consult your authorised Volkswagen luxury car specialist retailer or repairer for full warranty details.

Service Intervals. Volkswagen are pleased to offer you a choice on how your Touareg is serviced. The appropriate selection is entirely dependent on how the car is likely to be driven and its general use. To help you identify which type of service would be most suitable, please refer to the following guide.

The Time and Distance Service is recommended for vehicles that will cover less than 10,000 miles in 12 months and if the vehicle is likely to be used in the following way:

- Predominantly urban driving, short journeys with frequent cold starts.
- Activities regularly producing high engine loading, e.g. frequent hill climbs, driving with vehicle fully loaded and towing.
- Uneconomical driving style using high rpms with heavy acceleration and heavy braking.

The service intervals for the Time and Distance Service are as follows:

- Oil change service – Every 10,000 miles/1 year (whichever is soonest).
- Interval service – Every 20,000 miles/2 years (whichever is soonest).
- Inspection service – Every 40,000 miles/3 years (whichever is soonest).

The LongLife Service is recommended for vehicles with a daily mileage of more than 25 miles where the vehicle is driven regularly mainly on longer distance journeys. The vehicle is driven mainly at a constant speed with minimum vehicle and engine loading, minimal towing and driven in an economical manner.

With the LongLife Service the vehicle can cover anywhere between 10,000† and a maximum of 18,000† miles or 24 months (whichever is soonest) between oil changes. Inspection service is typically in the third year of ownership and thereafter every second year, for vehicles with an approximate annual mileage of 10,000 miles.

† Please note that mileages are approximate as the service indicator system uses kilometres as the distance measurement.

Please consult your authorised Volkswagen luxury car specialist retailer or repairer for full details.

Approved Accessories. A comprehensive range of accessories from alloy wheels to carpet mats is available to complement the factory-fitted option list. Volkswagen Approved accessories purchased from and fitted by your authorised Volkswagen luxury car specialist retailer at the point of vehicle sale will also benefit from the three-year vehicle warranty.

Maximum Peace Of Mind. To ensure you are effectively insured, Volkswagen Insurance (the trading name of Volkswagen Insurance Services Limited) offers policies developed specifically for Volkswagen drivers. The main benefit of being covered by one of the UK's largest manufacturer-approved insurance schemes is the complete peace of mind it provides. For example, should your Touareg require repair, we guarantee it will only be completed by an authorised specialist Volkswagen retailer or repairer.

Approved Used Cars. Confidence, peace of mind, reassurance. These are the virtues of buying an Approved Used car because every car has, or is supported by:

- Multipoint inspection
- Comprehensive reconditioning and valeting
- Mileage verification
- Vehicle validation check
- Volkswagen Approved Warranty
- Volkswagen Roadside Assistance‡
- 30-day/1,000 miles exchange policy‡

‡ Cars up to three years old are covered by Volkswagen Roadside Assistance. This can be purchased separately for cars over three years old.

± Terms and conditions apply, please ask for full details.

And for Approved Used Volkswagens, a service history check and certificate are also provided. When it comes to buying a used car, it's important that you can be confident in its mechanical condition, mileage and history. The Volkswagen Approved Used scheme should help put your mind at ease. Every Approved Used car for sale will have passed a rigorous inspection, and any problems found will have been rectified before the car is made ready for sale. For your extra peace of mind, it will be covered by a 12-month warranty and a 30-day/1,000 miles exchange policy.

Personal Finance Solutions. We appreciate that financial needs differ, so you'll find a team of professional advisors on hand at our specialist retailers. They will be able to offer you cost-effective, tried and trusted financial products including a range of products for both private and business consumers alike, from Volkswagen Finance*.

* Volkswagen Finance is a trading name of Volkswagen Financial Services (UK) Limited.

CO₂ Emission. The weight of a vehicle will influence the level of CO₂ emission it produces; as a result, vehicles with higher levels of specification and factory-fitted options may emit higher levels of CO₂.

The CO₂ figure quoted for each vehicle is the maximum possible. The unladen weight of the vehicle is calculated by range at the time of manufacture and the maximum possible CO₂ emission for that weight range is applied according to the Council Directive 80/1268EEC as amended by Commission Directive 1999/100/EC on the approximation of the laws of the member states relating to the carbon dioxide emissions and the fuel consumption of motor vehicles.

Please Note: Some illustrations in this brochure do not necessarily reflect UK specifications and may not be available. In particular, controls and some items of equipment are positioned differently for the UK.

The specifications contained in this brochure are for information purposes only and are subject to change. If you require any specific feature, you must consult your authorised Volkswagen luxury car specialist retailer who is regularly updated with any change in specification. Please check model availability and full specification details with your authorised Volkswagen luxury car specialist retailer prior to ordering.

Note: We would like to advise you that telephone calls to the Luxury car support centre may be monitored and recorded as part of our training and quality assurance processes. All our monitoring and recording processes meet Ofcom regulations.