

VOLVO S40

PRICE AND SPECIFICATION





Create your perfect Volvo S40

Congratulations. You're only a few steps away from your perfect Volvo S40. This price list contains everything you need to create the car that's exactly right for you.

From selecting the right package and choosing from a range of class leading engines, through to picking the perfect colour and adding the finishing touches, you're in complete control. You'll also find full engine details and in-depth technical specifications to help you make the most informed choice.

Whatever you decide, you'll be choosing a saloon that's definitely part of the Volvo family – the S40's distinctive black egg-crate grille and V-shaped bonnet see to that. Inside you'll find a revolutionary approach to interior layout with a central control unit heavily influenced by contemporary high-end design.



S40 S

The comprehensive specification includes ECC (Electronic Climate Control), 16" alloy wheels, DSTC (Dynamic Stability and Traction Control), power windows, leather steering wheel, 6-speaker radio/CD system and auxiliary input for MP3 player.

S40 SE

The SE model brings added luxury to the Volvo S40 saloon. 17" Zaurak alloy wheels, rain sensor, information centre, cruise control and a choice of interior inlays are just some of the standard SE features.

S40 SE LUX

The most luxurious version offers leather-faced upholstery, heated front seats, luxury floor mats and Nordic Light Oak trim whilst 17" Spartacus alloy wheels, autofolding power door mirrors with ground lights and a headlamp cleaning system identify this model from the outside.

S40 **R**DESIGN SPORT

The striking exterior lines are enhanced with 17" Serapis alloy wheels with full bodykit and logo on the grille. The unique interior design is complemented with embossed Leather/T-Tec upholstery, sports steering wheel and unique aluminium inlay.

S40 **R**DESIGN SE SPORT

This model combines the luxury features of the SE with the unique R-DESIGN interior details and the dramatic exterior sporty bodykit and 18" Medusa alloy wheels.

S40 **DRIVE**

DRIVE is a series of modifications, adjustments and enhancements designed to make it easy to reduce both your impact on the environment and your running costs. The Volvo S40 1.6D DRIVE produces only 118 g/km of CO₂ – which means 12 months' car tax of just £35. Its fuel consumption is up to 62.8 mpg* too, and it comes with the choice of S, SE and SE Lux trim levels – so there's no compromise on style or luxury. See page 18 for more information.

* Based on a combined cycle





On the road

How much will it cost to get behind the wheel of your own Volvo S40? Simply decide which model variant and engine type are right for you and then take a look at the full price list below.

S40 S

	Basic £	VAT £	Rec Retail Price £	On the Road Price £
PETROL				
1.6 S	£11,782.61	£1,767.39	£13,550.00	£14,295.00
1.8 S	£13,391.30	£2,008.70	£15,400.00	£16,145.00
DIESEL				
1.6D DRIVe S	£14,247.83	£2,137.17	£16,385.00	£16,995.00
2.0D S	£14,986.96	£2,248.04	£17,235.00	£17,955.00

S40 SE

	Basic £	VAT £	Rec Retail Price £	On the Road Price £
PETROL				
1.6 SE	£13,086.96	£1,963.04	£15,050.00	£15,795.00
1.8 SE	£14,695.65	£2,204.35	£16,900.00	£17,645.00
2.0 SE	£15,565.22	£2,334.78	£17,900.00	£18,645.00
DIESEL				
1.6D DRIVe SE	£15,552.17	£2,332.83	£17,885.00	£18,495.00
2.0D SE	£16,291.30	£2,443.70	£18,735.00	£19,455.00
D5 SE	£17,595.65	£2,639.35	£20,235.00	£20,955.00
FLEXIFUEL				
1.8F SE	£14,956.52	£2,243.48	£17,200.00	£17,945.00





S40 SE LUX

	Basic £	VAT £	Rec Retail Price £	On the Road Price £
PETROL				
2.0 SE Lux	£16,869.57	£2,530.43	£19,400.00	£20,145.00
DIESEL				
1.6D DRIVe SE Lux	£16,856.52	£2,528.48	£19,385.00	£19,995.00
2.0D SE Lux	£17,595.65	£2,639.35	£20,235.00	£20,955.00
D5 SE Lux	£18,900.00	£2,835.00	£21,735.00	£22,455.00

S40 *R*DESIGN SPORT

	Basic £	VAT £	Rec Retail Price £	On the Road Price £
PETROL				
1.6 R-DESIGN Sport	£14,056.52	£2,108.48	£16,165.00	£16,910.00
1.8 R-DESIGN Sport	£15,130.43	£2,269.57	£17,400.00	£18,145.00
2.0 R-DESIGN Sport	£16,000.00	£2,400.00	£18,400.00	£19,145.00
T5 R-DESIGN Sport	£18,608.70	£2,791.30	£21,400.00	£22,185.00
DIESEL				
1.6D R-DESIGN Sport	£15,769.57	£2,365.43	£18,135.00	£18,830.00
2.0D R-DESIGN Sport	£16,726.09	£2,508.91	£19,235.00	£19,955.00
D5 R-DESIGN Sport	£18,030.43	£2,704.57	£20,735.00	£21,455.00

S40 *R*DESIGN SE SPORT

	Basic £	VAT £	Rec Retail Price £	On the Road Price £
PETROL				
2.0 R-DESIGN SE Sport	£17,130.43	£2,569.57	£19,700.00	£20,445.00
T5 R-DESIGN SE Sport	£19,739.13	£2,960.87	£22,700.00	£23,485.00
DIESEL				
2.0D R-DESIGN SE Sport	£17,856.52	£2,678.48	£20,535.00	£21,255.00
D5 R-DESIGN SE Sport	£19,160.87	£2,874.13	£22,035.00	£22,755.00



The right equipment

It's essential that your Volvo comes equipped with everything you need. Below you'll find the standard equipment lists for each model variant, plus optional equipment to personalise your Volvo S40. And as you'd expect, there is an array of industry-leading, cutting edge safety innovations.

STANDARD EQUIPMENT - SAFETY & SECURITY	S	SE	SE LUX	R-DESIGN SPORT	R-DESIGN SE SPORT
Dual Stage Driver and Passenger Airbags	•	•	•	•	•
SIPS (Side Impact Protection System)	•	•	•	•	•
SIPS Airbags	•	•	•	•	•
IC (Inflatable Curtain)	•	•	•	•	•
WHIPS (Whiplash Protection System) (Front Seats)	•	•	•	•	•
ABS (Anti-lock Brake System) with EBD (Electronic Brake Distribution) and Electronic Brake Assistance	•	•	•	•	•
DSTC (Dynamic Stability and Traction Control)	•	•	•	•	•
5 Three Point Seat Belts	•	•	•	•	•
Seat Belt Pre-tensioners (Front and Outer Rear)	•	•	•	•	•
Head Restraints - All 5 Seats	•	•	•	•	•
ISOFIX Attachment (Rear Seats)	•	•	•	•	•
Anti-theft Alarm including Immobiliser and Level Sensor	•	•	•	•	•
Key Integrated Remote Control Central Locking including Fuel Flap with Deadlocking System	•	•	•	•	•
Auto Open/Close Windows/Sunroof	•	•	•	•	•
Tinted Windows	•	•	•	•	•
Water Repellent Side Windows	•	•	•	•	•
Visible VIN Plate	•	•	•	•	•
Day Running Lights	•	•	•	•	•
Headlamp Levelling System	•	•	•	•	•
High Level LED Brake Light	•	•	•	•	•
Side Marker Illumination	•	•	•	•	•
Home Safe and Approach Lighting	•	•	•	•	•
IDIS (Intelligent Driver Information System)	•	•	•	•	•

STANDARD EQUIPMENT - EXTERIOR	S	SE	SE LUX	R-DESIGN SPORT	R-DESIGN SE SPORT
16" Libra Alloy Wheels (Diamond Cut) - 205/55 R16 V Energy Saving Tyres (1.6D DRIVE only)	•				
16" Ceryx Alloy Wheels (Silver Stone) - 205/55 R16 W Tyres	•				
17" Zaurak Alloy Wheels (Silver Bright) - 205/50 R17 W Tyres		•			
17" Spartacus Alloy Wheels (Silver Bright) - 205/50 R17 W Tyres			•		
17" Serapis Alloy Wheels (Silver Bright) - 205/50 R17 W Tyres				•	
18" Medusa Alloy Wheels (Silver Bright) - 215/45 R18 W Tyres					•
Locking Wheel Nuts	•	•	•	•	•
Tyre Sealant Kit	•	•	•	•	•
Headlamp Cleaning System			•		
Autofolding Power Door Mirrors with Ground Lights			•		
Front Fog Lights		•	•	•	•
R-DESIGN Silver Matt Door Mirrors				•	•
Power Adjustable and Heated Door Mirrors	•	•	•	•	•
Speed Dependent Interval Wiper Function	•	•	•	•	•
R-DESIGN Silver Matt Grille with Logo				•	•
Rain Sensor - Automatic Windscreen Wiper Activation		•	•	•	•
Comfort Chassis (R-DESIGN Sport/R-DESIGN SE Sport Models - 1.6/1.8/1.8F/2.0/1.6D only)	•	•	•	•	•
Dynamic Chassis (R-DESIGN Sport/R-DESIGN SE Sport - T5/2.0D/D5 only)				•	•
DRIVE Lowered Chassis (1.6D DRIVE only)	•	•	•		
Rally Bar (Front Strut Stiffener)				•	•
Rear Lip Spoiler (T5 and D5 only)		•	•		
Rear Spoiler				•	•
Full Bodykit (Front and Rear Spoilers and Side Skirts)				•	•
Body Coloured Lower Mouldings		•	•	•	•
Full Body Coloured Side Mouldings	•	•	•	•	•
Unique DRIVE features (Front and Rear Lip Spoilers, Front Wheel Deflectors, Partly Covered Grille, Energy Saving Tyres (16" only) and Unique DRIVE Emblem) (1.6D DRIVE only)	•	•	•		

STANDARD EQUIPMENT - INTERIOR

	S	SE	SE LUX	R DESIGN SPORT	R DESIGN SE SPORT
ECC (Electronic Climate Control) with AQS (Air Quality System) and Pollen Filter	•	•	•	•	•
Information Centre					
Exterior Temperature Gauge	•	•	•	•	•
Cruise Control		•	•	•	•
Front and Rear Power Windows	•	•	•	•	•
Illuminated Driver and Passenger Vanity Mirrors	•	•	•	•	•
Front and Rear Reading Lights	•	•	•	•	•
Autodimming Rear View Mirror with Humidity Sensor and Compass		•	•		•
Front Centre Armrest	•	•	•	•	•
Rear Centre Armrest with Twin Cupholders and Storage	•	•	•	•	•
Front Storage Box with Removable Cupholders	•	•	•	•	•
Grocery Bag Holder		•	•		•
Rear Waste Bag/Bottle Holder		•	•		•
Rear 12v Socket	•	•	•	•	•
Power Driver's Seat with Seat Memory			•		
Heated Front Seats			•		
Height Adjustable Passenger Seat with Lumbar Support	•	•	•	•	•
Forward Folding Front Passenger Seat	•	•	•	•	•
Asymmetric Split-folding Rear Seat (60%/40%)	•	•	•	•	•
Leather Steering Wheel, Gear Knob and Handbrake Lever	•	•	•		
R DESIGN Leather Sports Steering Wheel with Aluminium Inserts and Logo				•	•
R DESIGN Sports Gear Knob with Aluminium Inserts and Leather Handbrake Lever				•	•
Steering Wheel Remote Audio Controls		•	•	•	•
R DESIGN Blue Instrument Dials				•	•
Height and Reach Adjustable Steering Column	•	•	•	•	•
Bauxite Trim	•				
Aluminium Trim		•			
Nordic Light Oak Trim			•		
R DESIGN Deco Aluminium Trim				•	•
Boda Textile Upholstery	•				
Dalarö T-Tec Upholstery		•			
Leather-faced Upholstery			•		
R DESIGN Leather/T-Tec Upholstery with Logo				•	•
Luxury Floor Mats			•		
R DESIGN Sports Floor Mats with Contrasting Piping				•	•
R DESIGN Aluminium Sports Pedals				•	•
Performance Sound Audio System – 1 x CD/Radio, 4 x 20W Amplifier and 6 Speakers	•	•	•	•	•
Aux Input for MP3 Player	•	•	•	•	•



OPTIONAL EQUIPMENT – SAFETY & SECURITY	Basic £	VAT £	Rec Retail Price £	S	SE	SE LUX	R-DESIGN SPORT	R-DESIGN SE SPORT
BLIS (Blind Spot Information System) with Autofolding Power Door Mirrors and Ground Lights	£565.22	£84.78	£650.00	o	o	u (£450)	o	o
Passenger Airbag Cut Off Switch	£21.74	£3.26	£25.00	o	o	o	o	o
Laminated Water Repellent Side Windows	£339.13	£50.87	£390.00	o	u (£300)	u (£300)	o	u (£300)
Homelink	£43.48	£6.52	£50.00	o	o	o	o	o

OPTIONAL EQUIPMENT – INTERIOR	Basic £	VAT £	Rec Retail Price £	S	SE	SE LUX	R-DESIGN SPORT	R-DESIGN SE SPORT
Powershift (6 Speed Automatic Transmission) (2.0D only)	£1,217.39	£182.61	£1,400.00	o	o	o	o	o
Geartronic Transmission (T5 and D5 only) (Not 2.0D)	£1,086.96	£163.04	£1,250.00	n/a	o	o	o	o
Information Centre	£165.22	£24.78	£190.00	o	●	●	o	●
Cruise Control	£208.70	£31.30	£240.00	o	●	●	●	●
Keyless Drive	£304.35	£45.65	£350.00	o	o	o	o	o
Power Glass Tilt and Slide Sunroof	£608.70	£91.30	£700.00	o	o	o	o	o
Autodimming Rear View Mirror with Humidity Sensor and Compass	£217.39	£32.61	£250.00	o	●	●	o	●
Grocery Bag Holder ⁽ⁱ⁾	£56.52	£8.48	£65.00	o	●	●	o	●
Front and Rear Ashtray with Cigarette Lighter	–	–	–	nco	nco	nco	nco	nco
Power Driver's Seat with Seat Memory	£478.26	£71.74	£550.00	o	o	●	o	o
Aluminium Trim	£217.39	£32.61	£250.00	o	●	nco	n/a	n/a
Virtual White Trim	£217.39	£32.61	£250.00	o	nco	nco	n/a	n/a
Nordic Light Oak Trim	£217.39	£32.61	£250.00	n/a	o	●	n/a	n/a
Leather-faced Upholstery ⁽ⁱⁱ⁾	£1,043.48	£156.52	£1,200.00	o	u (£600)	●	u (£500)	u (£500)
6 x CD Player ^{(iii)(iv)}	–	–	–	nco	nco	nco	nco	nco
High Performance Sound Audio System – 1 x CD/Radio, 4 x 40W Amplifier, USB and Aux Input and 8 Speakers (MP3/WMA Compatible)	£260.87	£39.13	£300.00	o	o	o	o	o
Dynaudio Premium Sound Audio System – with Dolby Pro Logic II Surround Sound ^(v) , 5 x 130W Amplifier, USB and Aux Input, 1 x CD and 12 Speakers (MP3/WMA Compatible)	£1,000.00	£150.00	£1,150.00	o	o	o	o	o
Steering Wheel Remote Audio Controls	£52.17	£7.83	£60.00	o	●	●	●	●
Satellite Navigation System (RTI) with RDS-TMC and Map Data on Hard Disk ⁽ⁱⁱⁱ⁾	£1,304.35	£195.65	£1,500.00	o	o	o	o	o
Bluetooth [®] Handsfree System ^{(vi)(vii)}	£217.39	£32.61	£250.00	o	o	o	o	o
Dual Band Integrated GSM Telephone ⁽ⁱⁱⁱ⁾ and Volvo On Call ^(viii)	£434.78	£65.22	£500.00	o	o	o	o	o

● = standard, o = option, n/a = not available, nco = no cost option, u (£) = upgrade, ® = Registered Trademark.

(i) Grocery Bag Holder is removed on D5 models when Tempa Spare Wheel is ordered.

(ii) Leather-faced Upholstery upgrade on R-DESIGN Sport and R-DESIGN SE Sport is only available with 5D77 Off Black.

(iii) Must be ordered in conjunction with High Performance or Dynaudio Premium Sound Audio Systems.

(iv) If a 6 x CD Player is ordered, standard USB port is removed from the audio system.





OPTIONAL EQUIPMENT - EXTERIOR	Basic £	VAT £	Rec Retail Price £	S	SE	SE LUX	REDESIGN SPORT	REDESIGN SE SPORT
Black Paint (Solid)	£217.39	£32.61	£250.00	o	o	o	n/a	n/a
Metallic/Pearlescent Paint	£456.52	£68.48	£525.00	o	o	o	o	o
Inscription™ Paint	£652.17	£97.83	£750.00	o	o	o	o	o
16" Libra Alloy Wheels (Diamond Cut) – 205/55 R16 V Energy Saving Tyres (1.6D DRIVE only)	–	–	–	●	nco	nco	n/a	n/a
16" Ceryx Alloy Wheels (Silver Stone) – 205/55 R16 W Tyres ^(ix)	–	–	–	nco	nco	nco	n/a	n/a
16" Crius Alloy Wheels (Silver Bright) – 205/55 R16 W Tyres ^(ix)	–	–	–	nco	nco	nco	n/a	n/a
16" Cursa Alloy Wheels (Silver Bright) – 205/55 R16 W Tyres ^(ix)	–	–	–	nco	nco	nco	n/a	n/a
17" Zaurak Alloy Wheels (Silver Bright) – 205/50 R17 W Tyres	£260.87	£39.13	£300.00	o	●	nco	n/a	n/a
17" Spartacus Alloy Wheels (Silver Bright) – 205/50 R17 W Tyres	£260.87	£39.13	£300.00	o	nco	●	n/a	n/a
18" Medusa Alloy Wheels (Silver Bright) – 215/45 R18 W Tyres (Not 1.6)	£434.78	£65.22	£500.00	n/a	n/a	n/a	o	●
18" Midir Alloy Wheels (Diamond Cut/Light Grey) – 215/45 R18 W Tyres (Not 1.6)	£434.78	£65.22	£500.00	n/a	n/a	n/a	o	nco
Tempa Spare Wheel ⁽ⁱ⁾	–	–	–	nco	nco	nco	nco	nco
Autofolding Power Door Mirrors with Ground Lights	£173.91	£26.09	£200.00	o	o	●	o	o
Front Fog Lights	£156.52	£23.48	£180.00	o	●	●	●	●
Rear Park Assist	£304.35	£45.65	£350.00	o	o	o	o	o
Rain Sensor	£126.09	£18.91	£145.00	o	●	●	o	●

	Basic £	VAT £	Rec Retail Price £	S	SE	SE LUX	REDESIGN SPORT	REDESIGN SE SPORT
WINTER PACK								
Heated Front Seats, Headlamp Cleaning System and Luxury Floor Mats	£347.83	£52.17	£400.00	o	o	●	u (£325)	u (£325)
Winter Pack with Active Bending Headlamps	£847.83	£127.17	£975.00	o	o	u (£575)	u (£900)	u (£900)
FAMILY PACK								
Integrated Booster Cushions x 2, Power Child Locks, Sun Curtain (Rear Shelf, Manual) and Passenger Airbag Cut Off Switch	£260.87	£39.13	£300.00	o	o	o	o	o
COMMUNICATIONS PACK								
Satellite Navigation System (RTI) with RDS-TMC and Map Data on Hard Disk ⁽ⁱⁱⁱ⁾ , Keyless Drive and Bluetooth® Handsfree System ^(vii)	£1,521.74	£228.26	£1,750.00	o	o	o	o	o

(v) Dolby and Pro Logic Surround Sound™ are trademarks of Dolby Laboratories Licensing Corporation.

(vi) Aux Input is removed when Bluetooth® Handsfree System is ordered in conjunction with Performance Sound Audio System.

(vii) Cannot be ordered in conjunction with Dual Band Integrated GSM Telephone and Volvo On Call.

(viii) Volvo On Call includes Safety package (Security package available at additional cost).

(ix) If ordered with 1.6D DRIVE model, energy saving tyres will be fitted.



What's your style?

At Volvo we know everyone is different. And that's why you can choose from a whole spectrum of colours for the exterior of your Volvo S40. Whatever your style, you'll find the perfect shade for you.



019 Black Stone⁽ⁱ⁾



426 Silver metallic



452 Black Sapphire metallic



455 Titanium Grey pearl



466 Barents Blue pearl



476 Brilliant Blue pearl



477 Inscription™ Electric Silver Coarse Flake metallic



478 Maple Red pearl⁽ⁱ⁾



479 Orinoco Blue metallic



488 Gecko Green pearl



489 Matt Gold pearl⁽ⁱ⁾



490 Chameleon Blue pearl⁽ⁱ⁾



492 Savile Grey pearl⁽ⁱ⁾



612 Passion Red



614 Ice White

NB It is not possible to reproduce exact original shades in printed matter. Please ask your Volvo dealer to show you samples.

⁽ⁱ⁾ Not available with R-DESIGN Sport and R-DESIGN SE Sport.

The wheels

And now we come to one of the most important parts of choosing your new Volvo S40. Volvo alloy wheels come in a variety of different styles, cuts and finishes – each with its own distinct character.

Your selection of alloy wheel can dramatically influence the exterior styling of your Volvo S40. What will you choose?





16" Ceryx
(Silver Stone)

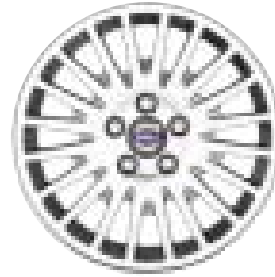

16" Crius
(Silver Bright)



16" Cursa
(Silver Bright)



16" Libra
(Diamond Cut)



17" Zaurak
(Silver Bright)

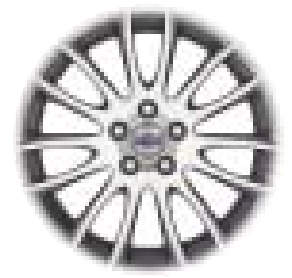

17" Spartacus
(Silver Bright)



17" Serapis
(Silver Bright)

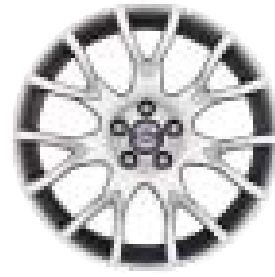

18" Medusa
(Silver Bright)



18" Midir
(Diamond Cut/Light Grey)

Interior inlays

A selection of premium materials to complement your interior fabric.

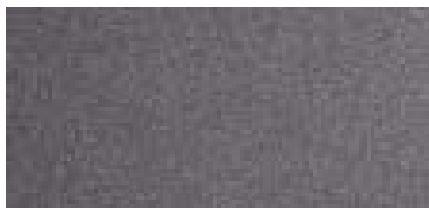

Bauxite



Aluminium



Nordic Light Oak



Virtual White

NB It is not possible to reproduce exact original shades in printed matter.



R DESIGN

Like to drive a car that turns heads? Then choose a Volvo S40 R-DESIGN. With a range of striking style flourishes both inside and out, this is a car that can't fail to be noticed.

R-DESIGN



Steering Wheel and Blue Dials



Front Grille with Logo



Silver Matt Door Mirrors



Pedals



Floor Mats



Off Black/Cream (5F7K)



R DESIGN Deco Aluminium





DRIVE

DRIVE means making a change for the better without compromise. The exterior styling is unmistakably Volvo, with strong curves and sleek lines – yet DRIVE enhancements like the lowered chassis, Libra alloy wheels and rear spoiler add distinctive finishing touches. And these changes aren't just for show – they contribute to CO₂ emissions of just 118 g/km and fuel economy of up to 62.8 mpg*.

Better fuel consumption and emissions with all the style, luxury and technology you've come to expect – who said it wasn't easy to do the right thing?

* Based on a combined cycle

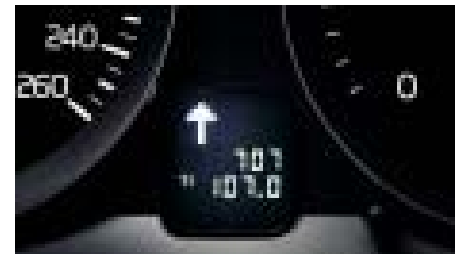

16" Libra
(Diamond Cut)



The nuts and bolts of your Volvo S40. Whatever you need to know about your new car – whether that's fuel consumption, CO₂ emissions, top speed or boot space – you'll find it here.

ENGINE	1.6 Man	1.8 Man	2.0 Man	T5	1.6D Man	1.6D DRIVe Man	2.0D	D5	1.8F Flexifuel Man
Configuration	Transverse – 16 valve	Transverse – 16 valve	Transverse – 16 valve	Transverse – 20 valve	Transverse – 16 valve	Transverse – 16 valve	Transverse – 16 valve	Transverse – 20 valve	Transverse – 16 valve
Cylinders	4	4	4	5	4	4	4	5	4
Engine capacity, cc	1596	1798	1999	2521	1560	1560	1997	2400	1798
Bore x stroke, mm	79 x 81.4	83 x 83.1	87.5 x 83.1	83 x 93.2	75 x 88.3	75 x 88.3	85 x 88	81 x 93.2	83 x 83.1
Max. output ECE, PS/kw/rpm	100/74/6000	125/92/6000	145/107/6000	230/169/5000	109/80/4000	109/80/4000	136/100/4000	180/132/4000	125/92/6000
Max. torque ECE, Nm/rpm	150/4000	165/4000	185/4500	320/ 1500 – 5000	240/1750	240/1750	320/2000	350/ 1750 – 3250	165/4000
Octane rating	95 RON Unleaded	95 RON Unleaded	95 RON Unleaded	98 RON ⁽ⁱ⁾ Unleaded	N/A Diesel	N/A Diesel	N/A Diesel	N/A Diesel	95 RON Unleaded/ Bio-ethanol (E85)
Fuel system	Multipoint fuel injection	Multipoint fuel injection	Multipoint fuel injection	Multipoint fuel injection	Common rail direct injection	Common rail direct injection	Common rail direct injection	Common rail direct injection	Multipoint fuel injection
Compression ratio	11.0:1	10.8:1	10.8:1	9.0:1	18.3:1	18.3:1	18.5:1	17.3:1	10.8:1

PERFORMANCE	1.6 Man	1.8 Man	2.0 Man	T5 Man	T5 Gt	1.6D Man	1.6D DRIVe Man	2.0D Man	2.0D P/shift	D5 Man	D5 Gt	1.8F Flexifuel Man
Top speed, mph	115	124	130	149	146	118	118	127	127	140	137	124
Acceleration 0-60mph, sec	11.3	10.3	8.9	6.3	6.7	10.8	10.8	8.9	9.1	7.5	7.9	10.3
0-62mph (0-100kmh), sec	11.9	10.9	9.5	6.8	7.2	11.4	11.4	9.5	9.6	7.9	8.5	10.9
Drag co-efficient	0.31	0.31	0.31	0.31	0.31	0.31	0.29	0.31	0.31	0.31	0.31	0.31

FUEL CONSUMPTION ⁽ⁱⁱ⁾⁽ⁱⁱⁱ⁾	1.6 Man	1.8 Man	2.0 Man	T5 Man	T5 Gt	1.6D Man	1.6D DRIVe Man	2.0D Man	2.0D P/shift	D5 Man	D5 Gt	1.8F Flexifuel Man ^(iv)
Urban mpg	30.7	28.0	27.7	22.6	20.6	45.6	49.6	37.2	36.2	33.6	29.1	27.4
(l/100km)	(9.2)	(10.1)	(10.2)	(12.5)	(13.7)	(6.2)	(5.7)	(7.6)	(7.8)	(8.4)	(9.7)	(10.3)
Extra Urban mpg	48.7	49.6	49.6	44.1	40.9	67.3	74.3	58.9	56.5	57.6	52.3	48.7
(l/100km)	(5.8)	(5.7)	(5.7)	(6.4)	(6.9)	(4.2)	(3.8)	(4.8)	(5.0)	(4.9)	(5.4)	(5.8)
Combined mpg	39.8	38.7	38.2	32.5	30.1	57.6	62.8	48.7	47.1	45.6	40.4	38.2
(l/100km)	(7.1)	(7.3)	(7.4)	(8.7)	(9.4)	(4.9)	(4.5)	(5.8)	(6.0)	(6.2)	(7.0)	(7.4)
CO ₂ g/km	169	174	176	208	224	129	118	153	159	164	184	177
VED (Vehicle Excise Duty) Band	E	E	E	F	F	C	B	D	D	D	E	E
Fuel tank volume, litres	55	55	55	62	52	52	52	52	52	60	55	55

LUGGAGE COMPARTMENT	
Volume, litres	404 (D5 325)
Volume, rear seats down, litres	883 (D5 800)

TRANSMISSION	
Manual 2.0D/T5/D5	6 speed
Manual 1.6/1.8/2.0/1.6D/1.6D DRiVe/1.8F	5 speed
Powershift (Automatic Gearbox) (2.0D)	6 speed
Geartronic T5/D5	5 speed

INSURANCE GROUPS	1.6 Man	1.8 Man	2.0 Man	T5	1.6D Man	1.6D DRiVe Man	2.0D	D5	1.8F Flexifuel Man
S	7E	10E	-	-	-	9E	10E	-	-
SE	7E	10E	12E	-	-	10E	10E	15E	10E
SE Lux	-	-	12E	-	-	10E	10E	15E	-
R-DESIGN Sport	7E	10E	12E	15E	8E	-	10E	15E	10E
R-DESIGN SE Sport	-	-	12E	15E	-	-	10E	15E	-

E = Exceeds security requirements for model concerned and group rating has been reduced.

WEIGHTS	1.6 Man	1.8 Man	2.0 Man	T5 Man	Gt	1.6D Man	1.6D DRiVe Man	2.0D Man	P/shift	D5 Man	Gt	1.8F Flexifuel Man
Min. kerb weight, kg (actual kerb weight dependent on spec.)	1317	1369	1380	1483	1497	1403	1408	1453	1479	1527	1536	1383
Max. possible towing weight braked, kg	1200	1300	1350	1500	1500	1300	800	1500	1500	1500	1500	1300
Max. towing weight unbraked approx, kg ^(w)	650	650	650	700	750	650	650	700	700	750	750	650
Max. towball weight, kg	75	75	75	75	75	75	75	75	75	75	75	75
Max. total weight, kg	1800	1850	1850	1960	1960	1880	1880	1940	1960	2020	2020	1850
Max. roof load, kg	75	75	75	75	75	75	75	75	75	75	75	75
Max. payload, kg (dependent on spec.)	483	481	470	477	463	477	472	487	481	493	484	467

POWER STEERING SYSTEM	All models
(rack & pinion) Turning circle, m (ft)	10.6 (34.9)

BRAKES	1.6/1.8/ 2.0/1.6D/1.6D DRiVe/1.8F	T5/2.0D	D5
Disc Diameter mm, front	15" - 278 Ventilated	16" - 300 Ventilated	16.5" - 320 Ventilated
Disc Diameter mm, rear	280	280	280

- (i) For best performance and lowest fuel consumption 98 RON is recommended, 95 RON can be used for normal driving.
- (ii) The results do not express or imply any guarantee of the fuel consumption of a particular car.
- (iii) Official fuel consumption figures are obtained in accordance with Directive 93/116/EC as amended by 1999/100/EC. The figures are obtained under controlled test conditions and as such consumption achieved on the road will not necessarily accord with the official test results. Factors including driving style and road, car and weather conditions will also have a bearing on actual fuel consumption achieved.
- (iv) CO₂ and fuel consumption is based on petrol operation.
- (v) Unbraked towing weight must not exceed 50% of kerb weight up to a maximum of 700 kg.

Notes

The weight of a vehicle will influence the level of CO₂ emitted. As a result, vehicles with higher levels of specification and factory fit options may emit higher levels of CO₂. Once a vehicle has been built it will be given its own specific CO₂ emission on which the Vehicle Excise Duty will be charged.

A weighbridge must be used to determine specific weights. Data valid for manual transmission unless specified.

All measurements in mm.

Gt = Geartronic Automatic Transmission.

P/shift = Powershift Automatic.

The Max. output figures are quoted in PS (Pferdestärke), which is the metric equivalent of brake horsepower.

NB Some of the information in this price list may not be correct due to product changes which may have occurred since it was printed. Some of the equipment described or shown may now be available only at extra cost. Before ordering, please ask your Volvo dealer for the latest information. The manufacturer reserves the right to make changes at any time, without notice, to prices, colour, materials, specifications and models.

Volvo Car UK Limited, Globe Park, Marlow, Buckinghamshire, SL7 1YQ.

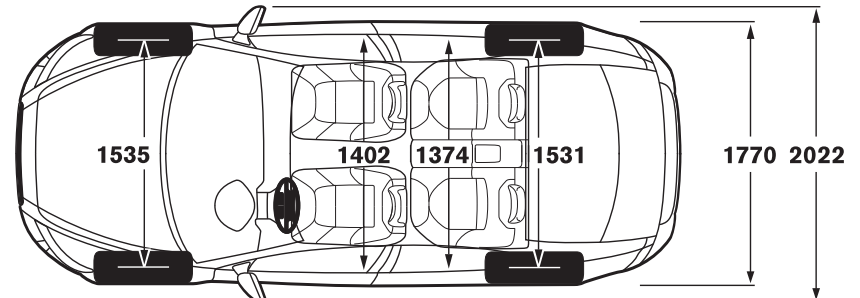
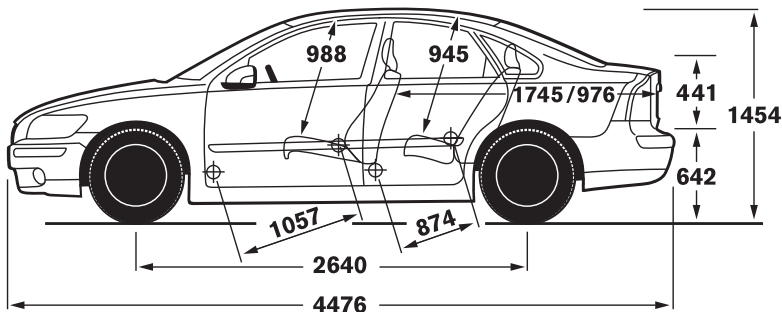

Accessories from Volvo

Of course, your Volvo S40 won't be perfect until it's exactly how you want it. And that's why we offer a range of accessories so you can completely personalise your new car. **The prices quoted below exclude fitting costs and are correct at time of going to press** – please confirm the total cost with your local Volvo dealer.

ACCESSORIES	Basic £	VAT £	Rec Retail Price £
EXTERIOR			
Aluminium Bike Rack (down tube clamp)	£53.13	£7.97	£61.10
Bike Rack (servo lift)	£113.17	£16.98	£130.15
Load Carrier	£108.22	£16.23	£124.45
Mud Flaps Front, Mud Flaps Rear (price per pair)	£28.63	£4.29	£32.92
Roofbox – Sport Time 200 (440 litre volume) ⁽ⁱ⁾	£153.56	£23.03	£176.59
Towbar – Detachable type with 13 Pin Electrics	£351.85	£55.78	£427.63
Rear Park Assist and Front Park Assist price for each from	£131.87	£19.78	£151.65
Rear Spoiler	£233.36	£35.00	£268.36
INTERIOR			
Garmin Portable Sat Nav	£310.64	£46.60	£357.24
Boot Mat – moulded plastic or textile/rubber reversible	£74.18	£11.13	£85.31
Cooler/Hot Box (excludes power cable)	£70.85	£10.63	£81.48
Bluetooth® Hands Free System	£173.67	£26.05	£199.72
iPod Interface ⁽ⁱⁱⁱ⁾	£238.30	£35.75	£274.05
USB Interface ⁽ⁱⁱⁱ⁾	£238.30	£35.75	£274.05
Combined USB/iPod Interface ⁽ⁱⁱⁱ⁾	£238.30	£35.75	£274.05
Load Liner – form moulded plastic	£75.27	£11.29	£86.56
Rubber Floor Mats (set of four)	£42.09	£6.31	£48.40
Sunblind – rear door windows (pair)	£26.31	£3.95	£30.26
Table (rear centre armrest)	£17.71	£2.66	£20.37
CHILD			
Child Seat ISOFIX ⁽ⁱⁱ⁾	£127.40	£19.11	£146.51
Infant Seat ISOFIX ⁽ⁱⁱ⁾	£163.47	£24.52	£187.99
ISOFIX Base	£94.63	£14.19	£108.82
Baby Insert	£27.93	£4.19	£32.12
Child Booster Cushion	£30.69	£4.60	£35.29
Child Booster Backrest (to go with above)	£30.69	£4.60	£35.29

(i) Other roof boxes available – please ask your dealer for details.

(ii) VAT on Child Seats is 5%.

(iii) USB and iPod Interface standard on Premium and High Performance Sound.

For further information and a complete list of all Volvo Accessories, take a look at the Accessory website at www.volvocars.co.uk/accessories or visit your local Volvo dealer.

Try an S40 for yourself with Volvo Rental

Why not hire a Volvo S40 – or any other Volvo – from Volvo Rental? You'll be guaranteed to drive a Volvo prepared to the highest standards by your local Volvo dealer. Call 0800 400 430 for more information today.





The end is just the beginning

It's a simple idea; one point of contact for all your car ownership needs – whether it's about finding the right finance deal or who to contact in an emergency. To get the most out of owning your Volvo, trust Care by Volvo.

STARTING OFF ON THE RIGHT FOOT

You might be surprised how easy and flexible financing can be. Our range of finance, service and insurance options allows you to budget around one key factor – your lifestyle.

FINANCE

As part of Volvo, Volvo Car Finance has developed a series of funding plans that will provide you with maximum choice and flexibility when acquiring a Volvo®. For details of the current promotions available, please visit www.volvocars.co.uk/financepromotions

INSURANCE

Volvo Car Insurance is designed for Volvo drivers and because we know Volvos inside out, we can offer exactly the right tools and expertise, fitting only genuine Volvo parts by trained Volvo technicians⁽ⁱ⁾. Your Volvo will come with seven days drive away insurance, so you've already got peace of mind. Because Volvo drivers have an excellent reputation, we can also offer extensive cover at a reasonable price⁽ⁱⁱ⁾.

Call now for your insurance quote on **0800 238 239**, quoting reference BROCH.



WHAT NEXT? If you'd like to find out more about the range of products and services that make up Care by Volvo, the story continues at www.volvocars.co.uk. Alternatively you can contact your nearest Volvo dealer or request relevant brochures.

(i) Finance subject to status. Guarantees/indemnities may be required. Volvo Car Finance SL7 1YQ.

(ii) When using a Volvo approved Body and Paint repairer.

(iii) Volvo Car Insurance is underwritten by Royal & Sun Alliance Insurance plc (No. 93792). Registered in England and Wales at St Mark's Court, Chart Way, Horsham, West Sussex RH12 1XL. Authorised and regulated by the Financial Services Authority. For your protection telephone calls will be recorded and may be monitored. All benefits are subject to qualifying status, terms and conditions, cover level and underwriting criteria. Service and repair benefits are subject to being carried out by a recommended repairer.

MAKING LIFE EASIER

Owning a Volvo should be a safe and enjoyable experience. To ensure it stays that way, we're committed to providing you with the best in support for as long as you own one.

SERVICE PROGRAMME

Your Volvo dealer has the unique know-how to tailor a service programme according to Volvo's strict recommendations and guarantees you years of safety and driving pleasure.

VOLVO ON CALL

Subscribe to Volvo On Call and you'll never be completely on your own. It's a GPS-based communication system providing 24-hour access to both emergency and roadside assistance wherever you are. See the Volvo On Call brochure for more information.

LOOKING AHEAD

You'll probably never find out just how good some of these services are. But should the unexpected happen, we'd like to think that you'd be even happier you chose a Volvo.

ROADSIDE ASSISTANCE

Every new car comes with one year's Volvo Assistance cover. You'll enjoy free breakdown and recovery assistance, anywhere in Europe, 24 hours a day. You can even extend cover for £85 for one year or £155 for two years. Call Volvo Assistance on **08701 650 978**.

WARRANTY

Every new Volvo comes with comprehensive protection. Our warranty covers the first three years or 60,000 miles, whichever comes first. There's a three year unlimited mileage warranty on the paintwork, and either eight or twelve years against rust perforation. If a component fails due to a defect or material fault, your dealer will swiftly rectify the problem, free of charge.

Volvo. for life

For tax free sales, including Military, Diplomat and all other Export enquiries, contact Volvo Car UK Tourist & Diplomat Sales or Volvo Car UK British Military Sales on **01707 262 388** or e-mail to vcukics@volvocars.com or bms@volvocars.com

All 'On The Road' prices quoted in this price list include Volvo standard national delivery charge, inclusive of number plates and VAT at £520 and the VED (Vehicle Excise Duty) car tax as of 1st December 2008. This charge does not include any provision for fuel. The 'On The Road' price also includes a £55 vehicle first registration fee (as set by the government – excludes Channel Islands and Isle of Man). Recommended retail prices quoted do not include these additions.

NB Some of the information in this price list may not be correct due to product changes which may have occurred since it was printed. Before ordering, please ask your Volvo dealer for the latest information. The manufacturer reserves the right to make changes at any time, without notice, to prices, colour, materials, specifications and models.