



Das Auto.

# The Tiguan

Volkswagen Information Service. Telephone 0800 333 666  
Internet: [www.volkswagen.co.uk](http://www.volkswagen.co.uk)  
© Volkswagen Group United Kingdom Limited 2010.  
Issue: 1 July 2010. Printed in UK.  
PVW281TIGB

# The Tiguan







## Contents

- 6 Exterior design
- 10 Interior design
- 14 The Tiguan S and S BlueMotion Technology
- 16 The Tiguan Match and Match BlueMotion Technology
- 18 The Tiguan Sport
- 20 The Tiguan R Line
- 24 The Tiguan Escape
- 26 4MOTION
- 28 Safety
- 30 Engines
- 32 Gearboxes
- 32 Wheels
- 34 Optional equipment
- 38 Paint
- 40 Upholstery
- 42 Combinations
- 44 Technical specification
- 50 Volkswagen service

Models shown are Tiguan Sport with optional Bi-Xenon headlights, panoramic sunroof and pearl effect paint, and Tiguan Escape.





Model shown is Tiguan Match with optional 18" 'Sierra' alloy wheels, RNS 510 DVD touch-screen navigation/radio system and pearl effect paint and Tiguan Escape.

One word describes driving the Tiguan.  
**Effortless.**





Model shown is Tiguan Sport with optional Bi-Xenon headlights and pearl effect paint.

Model shown is Tiguan Escape.

Whether you need a vehicle for everyday driving or discovering the great outdoors, there's a Tiguan to meet your exact requirements. For those looking to take the hassle out of day-to-day life, there's a choice of four different models – the Tiguan S, Match, Sport and R Line, each packed with intelligent features designed to make driving as effortless and enjoyable as possible. For those who wish to get more out of their Tiguan, Volkswagen's BlueMotion Technology has been incorporated into the S and Match models to help reduce CO<sub>2</sub> emissions and fuel consumption. For those looking to explore off the beaten track, the Tiguan Escape is designed to conquer the off-road landscape with the greatest of ease. A 28° angle of approach and corresponding underbody protection means it knows no limits, providing the ultimate in exhilaration and excitement.

**Everyday life or off-road adventure,  
there's a Tiguan for you.**





The stylish on-road front end of the Tiguan S, S BlueMotion Technology, Match, Match BlueMotion Technology, Sport and R Line with an 18° angle of approach gives a dynamic air, even when standing still, while the addition of the gleaming chrome trimmed radiator grille surround and louvres radiate elegance and sportiness. Meanwhile, the off-road design with a 28° angle of approach and sturdy underbody protection ensures the Tiguan Escape takes obstacles in its stride, while its powerful front end gives it a rugged look.

Sleek black roof rails complete the spirited on- and off-road design of the Tiguan S, S BlueMotion Technology and Escape perfectly, while chrome-plated roof rails are subtle yet stylish on Match, Match BlueMotion Technology, Sport and R Line models. The rounded in-set headlights, innovative design and confident lines give even greater elegance to its appearance. The Sport, R Line and Escape's front fog lights not only improve safety in the event of poor visibility, but also provide a sporty finish, enhancing the Tiguan's overall image, while its stylish rear light clusters enhance the rear body lines and ensure the Tiguan leaves you with a lasting impression.





If you've been impressed by the sleek exterior of the Tiguan, you'll find the interior nothing short of amazing. Its compact dimensions hide an interior that's not only exceptionally spacious, but with an intuitive layout specifically designed to help you handle the realities of day-to-day driving with the greatest of ease. Allied with high quality durable upholstery and 'Soft silver' decorative inserts, you couldn't ask for a vehicle that's more stylish, comfortable and refined – or more manageable to drive.

The adaptable interior layout allows impressive flexibility in terms of legroom or luggage capacity, while the countless storage solutions in the roof console, doors, luggage compartment and beneath the front seats on Match, Match BlueMotion Technology, Sport, R Line and Escape models, make storing those essential items easy. So, whether you're looking to transport friends, kids, luggage or otherwise, you'll find all the space you could ask for in the Tiguan. Giving you the freedom you need to live life to the full – easily, efficiently and effortlessly.



Interior shown is Tiguan Escape with optional 'Vienna' leather upholstery, 2Zone electronic climate control, Park Assist and panoramic sunroof.





As adaptable  
as your lifestyle  
demands.



If you're the kind of person that likes to be spontaneous, the Tiguan is a dream come true. Because whatever you want to do, it has the flexibility to provide exactly the seating or stowage arrangements you require. The amazingly adaptable interior is fitted with sliding and reclining rear seats that split 60:40, enabling either side to be moved backwards or forwards independently of each other. This gives you the option of either increasing boot capacity or providing your rear seat passengers with more legroom. The backs of the rear seats can also be folded down, as can the back of the front passenger seat on Match, Match BlueMotion Technology, Sport and R Line models, giving you valuable extra stowage space, useful for carrying longer items. Combined with the variable boot capacity, this gives you a massive loading volume of up to 1,510 litres. And it goes without saying that smaller items can be stowed without any problem, because the ergonomically designed storage areas offer plenty of extra space. All of which means there's very little you won't find room for in this exceptional SUV. And showing, once again, how everything about the Tiguan has been painstakingly designed to work as effortlessly as possible.



Images shown are to illustrate seating combinations only and may not necessarily reflect UK specification.



Interior shown is Tiguan S with Black 'Metropolis' cloth and optional Convenience pack, carpet mats and metallic paint.

## The Tiguan S and S BlueMotion Technology.

Impressive specification and attention to detail combine in the Tiguan S, providing a level of comfort, versatility and functionality totally geared to the demands of modern day living. Available in two wheel drive in the form of the S BlueMotion Technology as well as four wheel drive on 4MOTION models, the Tiguan S and S BlueMotion Technology are as much at home in the city as they are off-road. Fitted as standard are features such as 'Climatic' semi-automatic air conditioning, front and rear electric windows, electrically heated and adjustable door mirrors and remote central locking. An RCD 310 radio/MP3 compatible CD player with eight speakers and AUX-in socket for connection to an external multimedia source (e.g. iPod and MP3 player) and an alarm with interior protection are welcome additions, while speed sensitive power-assisted steering and the height and reach adjustable steering wheel and height adjustable driver's seat help you achieve the optimum driving position.

Your total comfort and convenience are assured, but the Tiguan S and S BlueMotion Technology offer more. It also has the intelligence to handle your real life driving needs easily and effortlessly, with such features as an electronic parking brake with auto hold function – holding you safely on a hill, and a multifunction computer (Highline), providing useful statistics about your journey, such as exterior temperature, average and current fuel consumption, average speed and estimated distance to refuelling. Durable 'Metropolis' cloth upholstery and 'Steel finish' air vent surrounds complete the interior, with everything ready to hand on the dashboard exactly where you'd expect it to be.

The high interior specification extends to the stylish exterior. 16 inch 'Cairo' alloy wheels, a side and rear protection pack, including wheel arch protection and 18° front module (a figure that defines the angle of slope the Tiguan can traverse), chrome trimmed radiator grille surround and louvres, and black roof rails confirm this, whilst body-coloured front bumper, door handles and door mirrors complete its impressive appearance. If you haven't already gathered, the Tiguan S and S BlueMotion Technology are designed to make life so easy, you'll soon wonder how you ever managed to live without them.

The S BlueMotion Technology builds over the already well equipped Tiguan S, supplemented by innovative technology to help keep fuel consumption and emissions impressively low, and unique 'BlueMotion Technology' badging to make it instantly recognisable. The Start/Stop system momentarily switches off the engine when the vehicle is stationary, in neutral and the clutch disengaged. This is notified to the driver with 'Start Stop' displayed on the multifunction computer (Highline), then disappears when driving is resumed. The multifunction computer includes a visual gear change recommendation for optimum fuel consumption, while regenerative braking utilises energy during braking and deceleration boosting the alternator voltage which in turn recharges the battery. Finally, to make driving just that little bit easier, an auto hold function prevents your vehicle from rolling back when pulling away on a slope or during a hill start.



The unique 'BlueMotion Technology' badging displays the environmental credentials of the S BlueMotion Technology for all to see.



The multifunction computer (Highline) displays important information that can be clearly and easily read. S BlueMotion Technology models also include a visual gear change recommendation for optimum fuel consumption.

Interior shown is S BlueMotion Technology.



'Cairo' design 6½J x 16 alloy wheels with 205/55 R16 tyres are both sporty and stylish. Standard on S and S BlueMotion Technology models.



## The Tiguan Match and Match BlueMotion Technology.

For those seeking an extra touch of luxury, the Tiguan Match and Match BlueMotion Technology more than delivers. In fact, from the minute you see the 17 inch 'Sahara' alloy wheels, heat insulating tinted glass from the B pillar back, chrome-plated roof rails and chrome trimmed side window surrounds, you'll know it's really something special. Stylish 'Energy' cloth upholstery, 'Soft silver' decorative inserts and a leather trimmed three-spoke multifunction steering wheel and gear knob create an interior that is as sumptuous as it is stylish. While front comfort seats with height and lumbar adjustment and 2Zone electronic climate control ensure a most comfortable journey, leaving you free to sit back, relax and enjoy day-to-day driving with minimum effort. The RCD 510 touch-screen DAB digital radio/dash-mounted MP3 compatible six CD autochanger with eight speakers adds even greater enjoyment to your trip, while DAB digital radio reception allows you to listen to all digital stations available in crystal clear sound. There is also an AUX-in socket and MDI (Multi Device Interface) for connection to an external multimedia source, such as an iPod or MP3 player. However, if that's not enough you'll also find a Bluetooth telephone preparation system\* for HFP (Hands Free Profile) enabled telephones, which allows you to make and receive calls without having to take your eyes off the road.

With useful extras including a flat tyre indicator, front centre armrest with storage compartment, folding tables on the back of the front seats, front under seat drawers and a front passenger seat that folds flat to allow transportation of longer items, the Tiguan Match offers a multitude of solutions, combined with a range of intuitive systems to make every drive safer and easier. One such system is Park Assist, a sensor controlled steering aid which helps to make parking your Tiguan an effortless experience. When passing a parking space at up to 19 mph, the Park Assist system with ultrasonic front and rear parking sensors, compares the space available with the length of the vehicle and automatically steers you into the space. All you need to do is select the appropriate gear, operate the pedals and keep a good lookout.

If you specify the Match BlueMotion Technology you have the same high specification of the Match with the addition of unique 'BlueMotion Technology' badging on the exterior. The Start/Stop system, multifunction computer (Highline) including visual gear change recommendation for optimum fuel consumption and battery regeneration, which recovers energy during braking all help reduce emissions and improve fuel consumption, while an auto hold function prevents your vehicle from rolling back when pulling away on a slope or a hill start are all welcome additions.

\* Please contact your retailer for full information on phone compatibility.



The 2Zone electronic climate control with automatic air recirculation system features dual zone temperature control for the driver and front passenger, enabling each to select their individually preferred temperature.



The RCD 510 touch-screen DAB digital radio/dash-mounted MP3 compatible six CD autochanger with eight speakers and AUX-in socket for connection to an external multimedia source (e.g. iPod and MP3 player).



'Sahara' design 7J x 17 alloy wheels with 235/55 R17 tyres are elegant and also unique to Tiguan Match models. A flat tyre indicator is also included.



Interior shown is Tiguan Match with Black 'Energy' cloth and optional metallic paint.





Interior shown is Tiguan Sport with Black/Grey 'Viewpoint' cloth and optional metallic paint.

## The Tiguan Sport.

Even before you step inside, the Tiguan Sport's dynamic front end with front fog lights and 18 inch 'Sierra' alloy wheels will get your heart pounding. Stylish, exciting and fun, the sports suspension (not lowered), front sports seats with height and lumbar adjustment, carpet mats and subtle 'Viewpoint' cloth upholstery only add to the anticipation, setting your pulse racing before you even turn the ignition. This is one car that goes the extra mile, not only in terms of aesthetics but also advanced features and superior specification. Such as the automatic coming/leaving home lighting function, front footwell illumination, rain sensor and automatically dimming interior rear-view mirror. Or the dusk sensor that automatically activates the headlights when driving at night-time or in other low light situations. All of which adds up to one thing – an effortless driving experience, dictated by common sense needs, ensuring you don't have to worry about a thing, from arriving home before dark to switching on your lights at night.

Add to that a multifunction computer (Highline), providing essential information while you drive, and the RCD 510 touch-screen radio/dash-mounted MP3 compatible six CD autochanger with eight speakers, providing incredible acoustics. For even greater pleasure, there's also an AUX-in socket for connection to an external multimedia source such as an iPod or MP3 player. It's extras such as these that make a genuine difference to everyday life and make the Tiguan Sport such a formidable package.



Sporty: Black wheel arch protection and 18 inch 'Sierra' alloy wheels emphasise the dynamic lines of the Tiguan Sport.





Model shown is Tiguan R Line with optional RNS 510 DVD touch-screen navigation/radio system.

For those who like a sporty, powerful drive and an individual look to their car, the Tiguan R Line is the perfect solution. The R Line builds upon the generous standard equipment offered on the Sport, but includes additional sporty styling cues, which give it a dynamic look and a powerful road presence.

**Dare to be different.**





Interior shown is Tiguan R Line with Black 'Monte Carlo' cloth and optional RNS 510 DVD touch-screen navigation/radio system.

## The Tiguan R Line.

The exterior design sends out a clear statement from the first moment you glimpse the striking 19 inch 'Omanyt' alloy wheels. A styling pack comprising of uniquely-shaped body-coloured front and rear bumpers, extended side sills with matt chrome strips, black rear diffuser and widened wheel arches are also fitted to give it a truly mesmerising appearance. Its flowing lines are completed by a body-coloured rear roof spoiler, front fog lights, sports suspension (not lowered), heat insulating tinted glass from the B pillar back, a matt chrome trimmed radiator grille surround and double louvres and the 'R Line' logo sitting proudly on the front wing.

Inside, the R Line really is something to indulge in. You still get all the features and functions available on the Sport, including an RCD 510 touch-screen radio/dash-mounted MP3 compatible six CD autochanger with eight speakers and AUX-in socket for connection to an external multimedia source (e.g. iPod and MP3 player), an automatic coming/leaving home lighting function and dusk and rain sensors. However, in addition to all these features, 2Zone electronic climate control is fitted as standard, and the front sports seats are upholstered in unique 'Monte Carlo' cloth, with the 'R Line' logo embroidered into the front head restraints. Add to that a leather trimmed three-spoke multifunction steering wheel with 'R Line' logo insert complete with multifunction computer (Highline), a leather gear knob and aluminium-look pedals with 'R Line' logo and all of these combine to make you feel at home in the R Line and give it an ambience of real sporting style and comfort.



Striking: The front of the Tiguan R Line is more stylish than ever featuring a uniquely shaped front bumper. The radiator grille surround, double louvres and roundel are trimmed in stylish matt chrome, while the front spoiler completes the impressive front design.



## The Tiguan Escape.

It's not by chance the Tiguan Escape got its name. With the capability to tackle nearly any terrain, this is exactly what it enables you to do. Explore uncharted territory and escape into the great unknown, all in the highest levels of luxury and comfort. The off-road design of the Escape is distinct from all other Tiguan models, with a front 28° module allowing it to traverse a larger angle of approach (from a horizontal surface to a gradient), while underbody protection at the front protects against ground contact. Front fog lights, 17 inch 'Tunis' alloy wheels, protective side bump strips, chrome trimmed radiator grille surround and louvres, and black roof rails, all add a real sense of style.

Despite its rugged exterior, the interior is the epitome of comfort, with carpet mats, contemporary 'Energy' cloth upholstery, 'Soft silver' decorative inserts and a leather trimmed three-spoke steering wheel and gear knob providing a luxurious feel. The RCD 510 touch-screen radio/dash-mounted MP3 compatible six CD autochanger with eight speakers including an AUX-in socket for connection to an external multimedia source such as an iPod or MP3 player provide entertainment on any journey, while front comfort seats with height and lumbar adjustment contribute to a unique driving experience. Practical extras include a flat tyre indicator, a foldable front passenger seat backrest, folding tables on the back of the front seats, and front under seat drawers, but it is the intelligent off-road setting and compass on the multifunction computer (Highline) display that really impress. The off-road setting, including hill descent assist, provides easier control when driving down steep gradients, while the compass will always keep you on track where there aren't any roads. All this intuitive performance at the touch of a button provides effortless driving on any terrain, giving you the capability to follow your dreams and discover what freedom really means.



17 inch 'Tunis' alloy wheels with 235/55 R17 tyres underscore the powerful image of the Tiguan Escape's exterior.

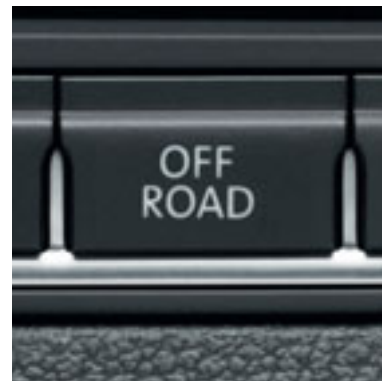

The off-road mode includes hill descent assist and ABSPlus adjusted to suit loose ground.

Interior shown is Tiguan Escape with Black 'Energy' cloth and optional metallic paint.



## Takes every challenge in its stride, with minimum effort.

Taking new pathways, pushing back boundaries, going beyond limits. For some people, this is just talk. But drive the Tiguan and, thanks to 4MOTION permanent four wheel drive, this is a reality. Standard on all 4MOTION models, Volkswagen's sophisticated four wheel drive system distributes engine power to all four wheels wherever needed, ensuring greater agility, better manoeuvrability and optimum safety. Not to mention pure driving enjoyment, whatever the journey, whether driving to work, popping to the shops or taking off for the weekend. Electronic Differential Lock (EDL) further enhances capability, using intelligent technology to ensure effortless performance, whatever the road surface.

The Tiguan Escape offers particularly impressive off-road capabilities, as its distinctive off-road front design suggests. With a 28° angle of approach and underbody protection, it takes steep angles in its stride and readily tackles all types of terrain, enabling you to explore off the beaten track. The off-road setting offers additional help by activating an integrated group of assistance systems that enhance the control of the Tiguan Escape during off-road driving. As part of this, the hill descent assist provides easier control when driving down steep gradients by actively braking all four wheels using the ESP hydraulics. The electronic parking brake – with auto hold function prevents you from rolling back on hill starts, while the accelerator pedal and ABSPlus system have been specially optimised for off-road use. So, drive the Tiguan and you really will get to the places others cannot reach. Effortlessly.

OFF  
ROAD

The **off-road setting**, includes hill descent assist and ABSPlus adjusted to suit braking on loose ground, enabling the Tiguan to manage difficult terrain at the press of a button. Standard on Escape and optional on all other 4MOTION models.



Model shown is Tiguan Escape.

Model shown is Tiguan Sport with optional Bi-Xenon headlights, panoramic sunroof and pearl effect paint.





**Flat tyre indicator:** In the event of a change in air pressure in any one of the four tyres, a warning symbol appears in the multifunction display, advising the driver to rectify the situation. Standard on Match, Match BlueMotion Technology, Sport, R Line and Escape models. When optional alloys are specified, the flat tyre indicator comes as standard.



**Electronic Stabilisation Programme:** This sensor-controlled system detects critical situations at an early stage and takes action, for example, by specifically braking individual wheels helping to bring the vehicle under control. So whether it's a tight bend or loose road surface, ESP will help you stay safely on course. Though such innovative systems are highly effective, it's worth remembering that they cannot dispense with the laws of physics.



**ABSPlus:** The Anti-lock Braking System (ABS) together with EBD (Electronic Brake-pressure Distribution) help to deliver exceptional handling and braking. When driving straight ahead on loose surfaces, the system will briefly lock the front wheels which enables them to dig into the surface and help reduce the stopping distance. When the wheels are turned, the normal ABS is activated.



**4MOTION:** Volkswagen's sophisticated four wheel drive system, distributes engine power to all four wheels wherever needed, ensuring greater agility, better manoeuvrability and optimum safety.

## Safety.

The well-designed airbag system consists of driver's and front passenger's airbags with passenger airbag deactivation switch, side impact airbags and a curtain airbag system to help protect the front and rear seat occupants in the event of an accident. When the airbag is deployed, doors are also unlocked, hazard lights and interior lights activated and the fuel pump deactivated. As a result of this intelligent airbag system, extremely strong bodywork structure and countless other safety features, the Tiguan has been awarded the maximum five stars for passenger protection in the Euro NCAP Crash-test. The Tiguan also comes with a rigid safety cell made from high strength sheet metal, bound together using laser welding techniques, resulting in extremely strong and safe joints, energy absorbing crumple zones and optimum protection for occupants even under the most severe collision conditions. Isofix child seat preparation allows the safe attachment of two child seats to the rear of the Tiguan, and additional 'top tether' securing points are also provided on the reverse sides of the rear backrests, while head restraints and three-point seat belts are provided for all five occupants, including seat belt tensioners for the driver and front passenger.



**Airbags:** All Tiguan models feature no less than six individual airbags as standard, an optional rear side airbag system can also be specified to help further protect rear seat passengers.

Image shown is for illustration purposes only and may not necessarily reflect UK specification.



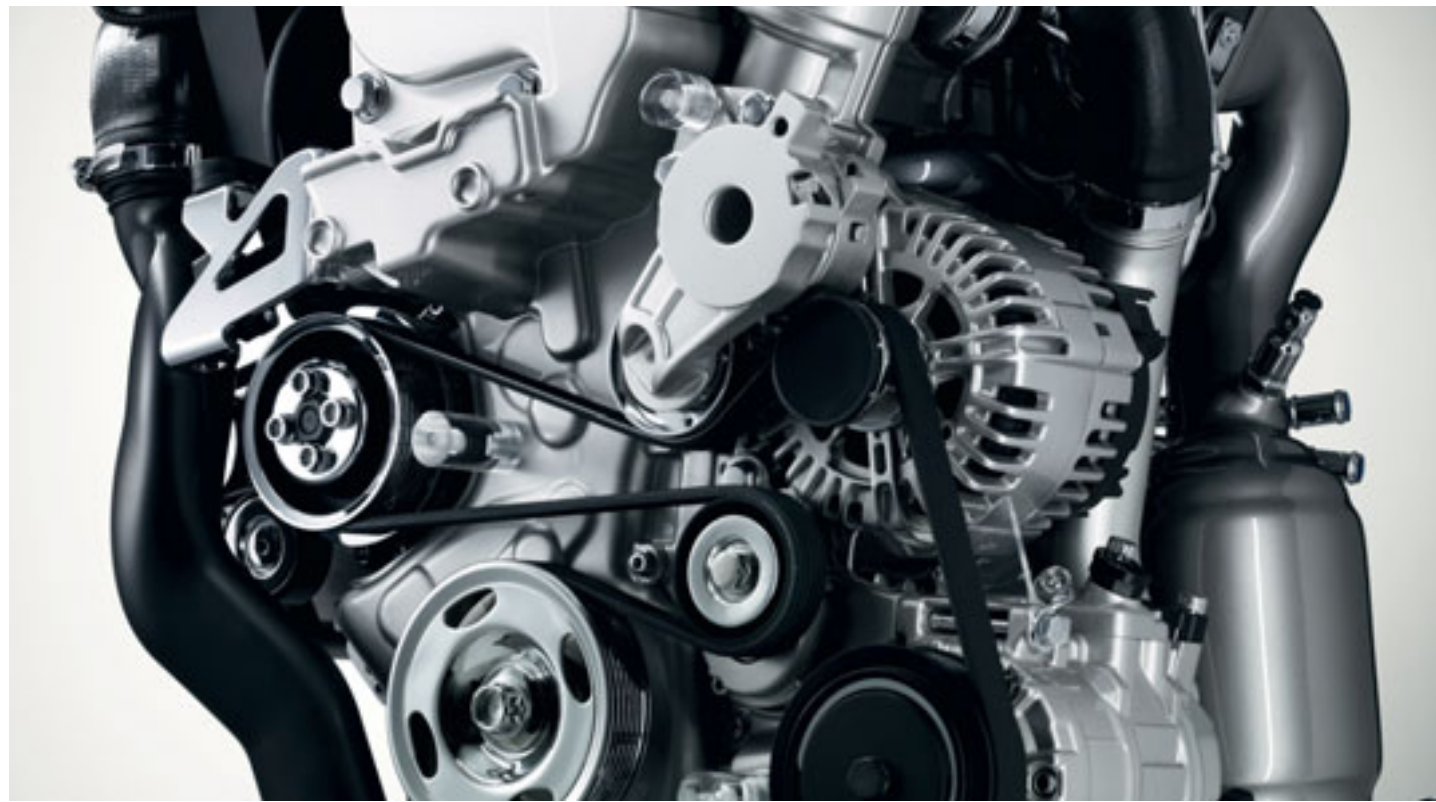

## Engines.

There is no holding back the Tiguan. Five dynamic engines transmit optimum power, all of which are assisted by the sporty six speed manual or now, you may prefer the option of a seven speed automatic DSG transmission that has been introduced for the first time on the Tiguan range. Combined with either two wheel drive or Volkswagen's 4MOTION four wheel drive system, it's enough to get your pulse racing and your adrenalin flowing on every journey.

Thanks to TSI technology, the 1.4 litre petrol engine generates an impressive 150 PS and has excellent pulling power. With 240 Nm of torque, it is available in either front wheel drive on BlueMotion Technology models, or 4MOTION four wheel drive and delivers uncompromising driving enjoyment, even on short stretches. TSI technology is also incorporated into two further petrol engines which power the Tiguan. Firstly, a 2.0 litre generating 170 PS, an engine capable of an impressive 33.2 mpg on the Combined fuel cycle, whilst achieving a top speed of 125 mph where the law permits. The most powerful engine for the Tiguan is the turbocharged 2.0 litre TSI petrol engine offering an exhilarating 200 PS. This engine can take the Tiguan from standstill to 62 mph in an impressive 7.9 seconds, on its way to a top speed of 130 mph where the law permits. Two 2.0 litre TDI engines offer everything you would expect and more, with new common rail technology being introduced for the first time in these engines. Available in front wheel drive or 4MOTION guise, this helps to noticeably reduce engine noise levels, fuel consumption and CO<sub>2</sub> emissions. Delivering a very healthy 140 PS with 320 Nm or the 170 PS unit achieving a massive 350 Nm of torque, both are fitted as standard with a Diesel Particulate Filter (DPF), which filters out exhaust gas particles, preventing them from entering the atmosphere, helping it already meet EURO 5 standards.

Powerful and economical, these are engines that let you enjoy life without the worry of being left behind. Now, there's nothing to stop you putting your foot down and really taking off.



Model shown is Tiguan Sport with optional metallic paint.

Model shown is Tiguan Escape.



## Gearboxes.

The Tiguan has everything you need to get off to a flying start. Whether you opt for the sporty six speed manual or seven speed auto DSG transmission, both have been individually optimised for the Tiguan and with either front wheel drive or 4MOTION four wheel drive, they provide outstanding traction and optimum drive comfort.



Powerful drive: Whether you select **six speed manual** or **seven speed automatic DSG transmission**, both gearboxes are perfectly tuned to the Tiguan engines, guaranteeing the ultimate in dynamics and traction.

## Wheels.

Whichever Tiguan model you've selected, here's your chance to individualise its aesthetics and create an even sportier look that will turn heads and demand attention. Adding alloys can radically change the appearance of your vehicle – choose from 16 inch to 19 inch wheels, each in an eye-catching design.



'Cairo' design 6½J x 16 alloy wheels with 205/55 R16 tyres. Standard on S and S BlueMotion Technology models.



'Sahara' design 7J x 17 alloy wheels with 235/55 R17 tyres including flat tyre indicator. Standard on Match and Match BlueMotion Technology models.



'Sierra' design 7J x 18 alloy wheels with 235/50 R18 tyres including flat tyre indicator. Standard on Sport and optional on all other models except R Line.



'Savannah' design 9J x 19 alloy wheels with 255/40 R19 tyres including flat tyre indicator. Optional on Sport models.



'Tunis' design 7J x 17 alloy wheels with 235/55 R17 tyres including flat tyre indicator. Standard on Escape and optional on S and S BlueMotion Technology models.



'Pasadena' design 7J x 18 alloy wheels with 235/50 R18 tyres including flat tyre indicator. Optional on S, S BlueMotion Technology, Match, Match BlueMotion Technology and Sport models.



'Omanyt' design 9J x 19 alloy wheels with 255/40 R19 tyres including flat tyre indicator. Standard on R Line models.

'Sports suspension' not lowered, provides a firm drive experience, improved handling and more responsive steering. Standard on the Tiguan Sport and R Line models. Optional on Match, Match BlueMotion Technology and Escape models.



## Optional equipment.



**Heat insulating tinted glass** from the B pillar back is 65% light absorbing, reducing exposure to the sun's rays and gives a sporty look. Optional on S, S BlueMotion Technology and Escape models. Standard on Match, Match BlueMotion Technology, Sport and R Line models.



**2Zone electronic climate control** maintains a constant preset temperature, providing separately controllable air conditioning for the driver and front passenger, practically without a draught. The automatic air recirculation mode also ensures that passengers are automatically protected from any unpleasant odours. Optional on S, S BlueMotion Technology, Sport and Escape models. Standard on Match, Match BlueMotion Technology and R Line models.



**Gas discharge (Bi-Xenon) headlights** produce a clearer, brighter light for both dipped and main beam, with the added convenience of headlight washers to help keep them free from dirt. The Advanced Front Lighting System (AFS) features dynamic curve lighting which provides better illumination of the road ahead when cornering. Optional on all models.



It's good to see life from a different angle. And in the Tiguan you can do just that. Quite literally, thanks to the **optional panoramic electric glass sliding sunroof**, providing an extra dimension of light and space. Offering an uninterrupted view of the sky above, it enables you to enjoy the freedom and fresh air previously experienced only in a convertible. The panoramic sliding roof is three times the size of a traditional sliding roof, while the integrated electric blind ensures protection from light and heat. Optional on all models.



Exclusive '**Vienna**' leather upholstery enhances the Tiguan's already distinctive look. The front seats are electrically heated with three preset temperature settings and also feature electric 12-way adjustment (in lieu of driver's under seat drawer) and lumbar support for the driver's seat. For added convenience this option also includes heated windscreen washer jets. Optional on all models.

Please note: Some parts of leather interior will contain artificial leather.



**Cruise control** can be set at speeds of over 19 mph to maintain a constant speed. Once set to the speed limit, all your concentration can be focused on the road ahead creating a more relaxed drive. Optional on all models.



The **Winter pack** includes heated front seats with three preset temperature settings and heated windscreen washer jets, ensuring you are fully prepared to face any cold spell. Optional on all models.



The **multifunction leather steering wheel** enables you to control the radio and multifunction computer without taking your hands off the wheel, thanks to the intuitively positioned buttons. Optional on S, S BlueMotion Technology, Sport and Escape models. Standard on Match, Match BlueMotion Technology and R Line models.





Also available, but not shown. The **Multi Device Interface (MDI)** with iPod and USB cables enables you to connect and charge a compatible device, while track selection is viewed and selected via the vehicle's radio system. Specify this option on S or S BlueMotion Technology models and it includes a front centre armrest. Optional on S, S BlueMotion Technology, Sport, R Line and Escape models. Standard on all Match models.

Please note: MDI cannot be specified in conjunction with MP3 compatible six CD autochanger.

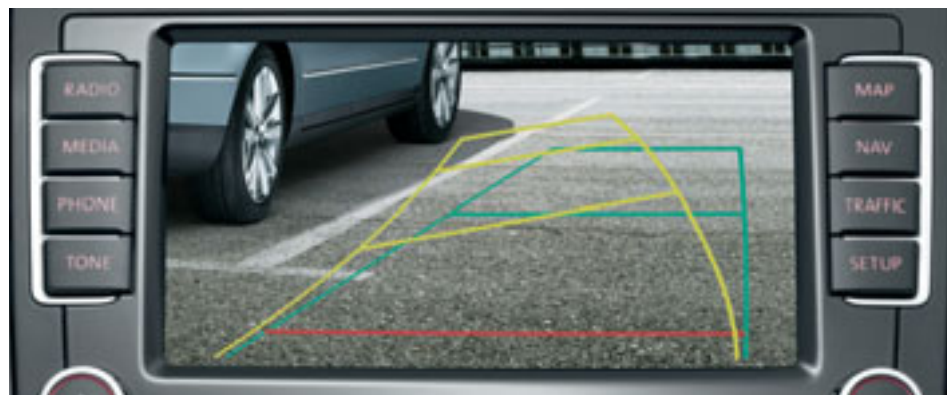

The Tiguan features Volkswagen's latest generation **voice activated RNS 510 touch-screen navigation/radio system and rear-view camera**. This DVD based navigation unit responds to spoken voice commands for navigation, CD and radio functions and not only delivers excellent sound quality but can also guide you effortlessly to your destination. A 6½ inch high resolution, touch-screen colour display shows a perspective (bird's-eye) view of your mapped route, in addition, traffic information (TMC) enabled, landmarks, intersection zoom, points of interest and a route list can all be viewed. As well as featuring the latest in processor technology, resulting in quick route calculations using all but the last two digits of a UK postcode, this sophisticated system features a 30 GB hard drive to buffer the navigation data as well as store the driver's favourite audio and video files (i.e. MP3, WMA, DVD video data files), the integrated DVD drive and SD (Secure Digital) card reader also allow the playback of such video files when the vehicle is stationary. Completing the multimedia experience is the ability to connect an external multimedia device (e.g. iPod and MP3 player) via the AUX-in socket. The innovative **rear-view camera** allows you to judge distances and view obstacles obscured from view behind your vehicle via the high resolution screen of the RNS 510 DVD navigation/radio system. For hours of uninterrupted listening pleasure you can also specify an armrest-mounted six CD autochanger. RNS 510 DVD touch-screen satellite navigation systems may not be available in conjunction with certain options, please consult your Volkswagen retailer for full details. Optional on all models.

Please note: RNS 510 DVD touch-screen navigation/radio system's rear-view camera in lieu of DAB on all Match models.  
Please note: MDI cannot be specified in conjunction with MP3 compatible six CD autochanger.



The **MP3 compatible six CD autochanger** is conveniently mounted in the front centre armrest and provides hours of listening pleasure on every journey. Specify this option on S or S BlueMotion Technology models and it includes a front centre armrest. Optional on all models.

Please note: Six CD autochanger must be ordered in conjunction with RNS 510 DVD touch-screen navigation/radio system.



The **RCD 510 touch-screen radio/dash-mounted MP3 compatible six CD autochanger** with eight speakers and AUX-in socket for connection to an external multimedia source (e.g. iPod and MP3 player). Optional on S and S BlueMotion Technology and standard on all other models. All Match models feature DAB digital receiver as standard.

Also available, but not shown. Another option for your RCD 310 or RCD 510 is a **DAB digital radio receiver**, enabling you to listen to all the digital stations available in crystal clear digital sound. Standard on all Match and optional on all other models.

Please note: DAB cannot be specified in conjunction with RNS 510 DVD touch-screen navigation/radio system.



When driving past a parking space at up to 19 mph, the optional **Park Assist** with ultrasonic front and rear parking sensors, compares the space available, which can be as little as 1.1 m longer than the length of the Tiguan. If the space is suitable, the Park Assist parallel parking assistant automatically controls the steering as soon as you engage reverse gear. All you have to do is operate the accelerator, clutch and brake, while keeping a good lookout. Parking sensors also assist in less challenging parking manoeuvres by emitting both audible and visual signals, alerting the driver to any obstacles in the way: the closer you are to an obstacle the faster the sound frequency. The **Optical Parking Display** extends the functions of the parking sensors by indicating your position on the vehicle's audio display during parking (either in monochrome on RCD 310 or colour on RCD 510 and RNS 510 DVD navigation system). Standard on all Match and optional on all other models.



The **'Dynaudio' sound system** ensures exceptional sound quality. Producing a 300 watt output through eight perfectly harmonised speakers, this is the ultimate addition to enhance any audio experience. The 'Dynaudio' sound system can be specified as part of an RCD 510 radio or RNS 510 navigation/radio option available on Match, Match BlueMotion Technology, Sport, R Line and Escape models.

Please note: RNS 510 DVD touch-screen navigation/radio system's rear-view camera in lieu of DAB on all Match models.



**Paint.**



Candy White †  
**Non-Metallic**  
B4



Reflex Silver †  
**Metallic\***  
8E



Indian Blue  
**Non-Metallic**  
F3



Nimbus Grey  
**Metallic\***  
U5



Wild Cherry Red  
**Metallic\***  
2K



Night Blue  
**Metallic\***  
Z2



Acapulco Blue  
**Metallic\***  
2W



Deep Black †  
**Pearl Effect\***  
2T



Silver Leaf  
**Metallic\***  
7B

■ Standard ■ Optional

\* Metallic and pearl effect paints are optional at extra cost.  
† Candy White (B4), Reflex Silver (8E) and Deep Black (2T) are the only colours available on R Line models.  
Please note: The print process does not allow for exact reproduction of the paint colours.  
For further details, please contact your Volkswagen retailer.



## Upholstery.

Black  
**'Metropolis' cloth**  
**AK**

**Standard on S and S BlueMotion Technology**



Black  
**'Energy' cloth**  
**GE**

**Standard on Match, Match BlueMotion Technology and Escape**

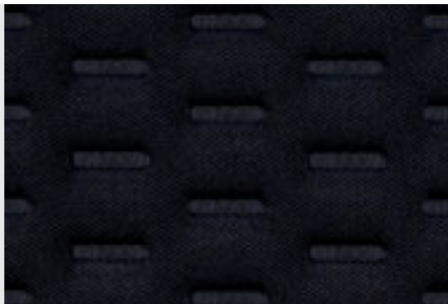

Latte  
**'Energy' cloth**  
**GJ**

**Standard on Match, Match BlueMotion Technology and Escape**

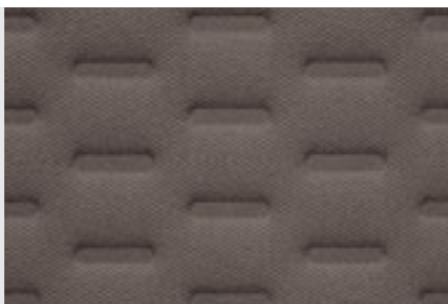

Black/Grey  
**'Viewpoint' cloth**  
**JD**

**Standard on Sport**

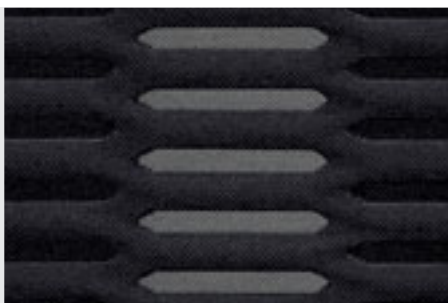

Grey/Black  
**'Viewpoint' cloth**  
**JF**

**Standard on Sport**



Black/Blue  
**'Viewpoint' cloth**  
**JG**

**Standard on Sport**



Black  
**'Monte Carlo' cloth**  
**50**

**Standard on R Line**



Black  
**'Vienna' leather\***  
**TW**

**Optional on all models**



Cornsilk Beige  
**'Vienna' leather\***  
**YY**

**Optional on all models**



Standard
  Optional

\* Leather upholstery is optional at extra cost. Some parts of leather interior will contain artificial leather.  
 Please note: The print process does not allow for exact reproduction of the upholstery colours.  
 For further details, please contact your Volkswagen retailer.



## Combinations.

	Seat upholstery	Carpet	Dashboard	Candy White (B4)	Indian Blue (F3)	Wild Cherry Red Metallic (2K) *	Acapulco Blue Metallic (2W) *	Silver Leaf Metallic (7B) *	Reflex Silver Metallic (8E) *	Nimbus Grey Metallic (U5) *	Night Blue Metallic (Z2) *	Deep Black Pearl Effect (2T) *
<b>‘Metropolis’ cloth</b> Standard on S and S BlueMotion Technology	Black (AK)	Black	Black/Black	●	●	●	●	●	●	●	●	●
<b>‘Energy’ cloth</b> Standard on Match, Match BlueMotion Technology and Escape	Black (GE)	Black	Black/Black	●	●	●	●	●	●	●	●	●
	Latte (GJ)	Black	Black/Latte	-	●	●	●	-	-	●	●	●
<b>‘Viewpoint’ cloth</b> Standard on Sport	Black/Grey (JD)	Black	Black/Black	●	●	●	●	●	●	●	●	●
	Grey/Black (JF)	Black	Black/Black	●	●	●	●	-	●	●	●	●
	Black/Blue (JG)	Black	Black/Black	-	●	-	●	-	-	-	●	●
<b>‘Monte Carlo’ cloth sports seats</b> Standard on R Line	Black (50)	Black	Black/Black	●	-	-	-	-	●	-	-	●
<b>‘Vienna’ leather* †</b> Optional on all models	Black (TW)	Black	Black/Black	○	○	○	○	○	○	○	○	○
	Cornsilk Beige (YY)	Black	Black/Cornsilk Beige	-	○	○	○	-	-	○	○	○

\* Metallic and pearl effect paints and leather upholstery are optional at extra cost.

† Some parts of leather interior will contain artificial leather.

● Standard.

○ Optional at extra cost.

- Not available.



## Technical specification.

		<b>S BlueMotion Technology, Match BlueMotion Technology 1.4 litre TSI 150 PS</b>	<b>S, Match 1.4 litre TSI 4MOTION 150 PS</b>	<b>Match 2.0 litre TSI 4MOTION 170 PS</b>	<b>Sport, R Line 2.0 litre TSI 4MOTION 200 PS</b>
<b>Engine</b>	Engine type	Four cylinder petrol	Four cylinder petrol	Four cylinder petrol	Four cylinder petrol
	Cubic capacity, ltrs/cc	1.4/1390	1.4/1390	2.0/1984	2.0/1984
	Max. output, PS <sup>(01)</sup> /kW at rpm	150/110 5800	150/110 5800	170/125 4300-6000	200/147 5100
	Max. torque, lbs.ft/Nm at rpm	177/240 1750	177/240 1750	207/280 1700	207/280 1700
	Gearbox	Six speed manual –	Six speed manual –	Six speed manual Seven speed auto DSG	Six speed manual Seven speed auto DSG
<b>Weights, kgs</b>	With manual gearbox:				
	Unladen weight <sup>(02)</sup>	1510	1621	1637	1653
	Gross vehicle weight	2080	2170	2200	2210
	Payload <sup>(02)</sup>	645	624	638	623
	Axle load limit: Front	1080	1120	1140	1140
	Rear	1050	1100	1160	1120
	With automatic DSG gearbox:				
	Unladen weight <sup>(02)</sup>	–	–	1648	1666
	Gross vehicle weight	–	–	2220	2230
	Payload <sup>(02)</sup>	–	–	647	639
Axle load limit: Front	–	–	1160	1160	
Rear	–	–	1110	1120	
<b>Trailer load limits, kgs <sup>(03)</sup></b>	Braked 12% incline				
	– manual gearbox	1800	2000	2200	2200
	– automatic DSG gearbox	–	–	2200	2200
	Unbraked	750	750	750	750
	Max. roof load	100	100	100	100
Towbar load limit	100	100	100	100	
<b>Performance</b>	Top speed, mph (km/h) – where the law permits				
	– manual gearbox	122 (197)	119 (192)	125 (201)	130 (210)
	– automatic DSG gearbox	–	–	124 (199)	130 (210)
	Acceleration, secs 0 - 62 mph				
– manual gearbox	9.3	9.6	8.5	7.9	
– automatic DSG gearbox	–	–	8.1	7.4	
ABI insurance group 1 - 20 (1 - 50) <sup>†</sup>	10E (16E), 10E (16E)	9E (15E), 10E (16E)	11E (19E)	20E (21E), 20E (21E)	
<b>Environmental information</b>	Fuel grade, minimum	Unleaded, 95 RON <sup>(04)</sup>	Unleaded, 95 RON <sup>(04)</sup>	Unleaded, 95 RON <sup>(04)</sup>	Unleaded, 95 RON <sup>(04)</sup>
	Official fuel consumption with manual gearbox mpg/ltr per 100 km <sup>(06)</sup>				
	Urban	33.2/8.5	28.0/10.1	24.4/11.6	24.4/11.6
	Extra-urban	49.6/5.7	42.2/6.7	42.2/6.7	42.2/6.7
	Combined	42.2/6.7	35.3/8.0	33.2/8.5	33.2/8.5
	Official fuel consumption with automatic DSG gearbox mpg/ltr per 100 km <sup>(06)</sup>				
	Urban	–	–	23.9/11.8	23.9/11.8
	Extra-urban	–	–	42.2/6.7	42.2/6.7
	Combined	–	–	32.8/8.6	32.8/8.6
	Official CO <sub>2</sub> emission, g/km – manual gearbox <sup>(07)</sup>	156	185	199	199
	– automatic DSG gearbox <sup>(07)</sup>	–	–	199	199
	Emission class – manual gearbox	EURO 5	EURO 5	EURO 5	EURO 5
	– automatic DSG gearbox	–	–	EURO 5	EURO 5
Noise, dB – manual gearbox	72.0	72.0	73.0	73.0	
– automatic DSG gearbox	–	–	73.0	73.0	

† Please note, as of December 2009 the insurance industry switched from the current rating system of groups 1 - 20 to a new 1 - 50 insurance scale.



## Technical specification.

		<b>S BlueMotion Technology, Match BlueMotion Technology 2.0 litre TDI 140 PS</b>	<b>S, Match, Sport, R Line, Escape 2.0 litre TDI 4MOTION 140 PS</b>	<b>Match, Sport, R Line 2.0 litre TDI 4MOTION 170 PS</b>
<b>Engine</b>	Engine type	Four cylinder diesel	Four cylinder diesel	Four cylinder diesel
	Cubic capacity, ltrs/cc	2.0/1968	2.0/1968	2.0/1968
	Max. output, PS <sup>(01)</sup> /kW at rpm	140/103 4200	140/103 4200	170/125 4400
	Max. torque, lbs.ft/Nm at rpm	236/320 1750	236/320 1750	258/350 1750
	Gearbox	Six speed manual –	Six speed manual Seven speed auto DSG	Six speed manual –
<b>Weights, kgs</b>	With manual gearbox:			
	Unladen weight <sup>(02)</sup>	1538	1665	1681
	Gross vehicle weight	2080	2240	2243
	Payload <sup>(02)</sup>	617	650	637
	Axle load limit: Front	1140	1160	1160
	Rear	1070	1130	1130
	With automatic DSG gearbox:			
	Unladen weight <sup>(02)</sup>	–	1675	–
	Gross vehicle weight	–	2270	–
	Payload <sup>(02)</sup>	–	670	–
Axle load limit: Front	–	1190	–	
Rear	–	1130	–	
<b>Trailer load limits, kgs <sup>(03)</sup></b>	Braked 12% incline			
	– manual gearbox (Escape)	2000	2200 (2500)	2200
	– automatic DSG gearbox (Escape)	–	2200 (2500)	–
	Unbraked (Escape)	750	750 (750)	750
	Max. roof load	100	100	100
Towbar load limit	100	100	100	
<b>Performance</b>	Top speed, mph (km/h) – where the law permits			
	– manual gearbox	118 (190)	116 (186)	125 (201)
	– automatic DSG gearbox	–	114 (184)	–
	Acceleration, secs 0 - 62 mph			
– manual gearbox	10.2	10.5	8.9	
– automatic DSG gearbox	–	10.5	–	
ABI insurance group 1 - 20 (1 - 50) <sup>†</sup>	10E (16E), 10E (16E)	9E (15E), TBA (TBA), 9E (15E), 9E (16E), 9E (15E)	11E (19E), 11E (18E) 11E (19E)	
<b>Environmental information</b>	Fuel grade, minimum	Diesel <sup>(05)</sup>	Diesel <sup>(05)</sup>	Diesel <sup>(05)</sup>
	Official fuel consumption with manual gearbox mpg/ltr per 100 km <sup>(06)</sup>			
	Urban	44.8/6.3	36.7/7.7	36.7/7.7
	Extra-urban	58.9/4.8	51.4/5.5	51.4/5.5
	Combined	53.3/5.3	44.8/6.3	44.8/6.3
	Official fuel consumption with automatic DSG gearbox mpg/ltr per 100 km <sup>(06)</sup>			
	Urban	–	36.2/7.8	–
	Extra-urban	–	49.6/5.7	–
	Combined	–	44.1/6.4	–
	Official CO <sub>2</sub> emission, g/km – manual gearbox <sup>(07)</sup>	139	164	165
	– automatic DSG gearbox <sup>(07)</sup>	–	169	–
	Emission class – manual gearbox	EURO 5	EURO 5	EURO 5
	– automatic DSG gearbox	–	EURO 5	–
Noise, dB – manual gearbox	71.0	71.0	74.0	
– automatic DSG gearbox	–	71.0	–	

† Please note, as of December 2009 the insurance industry switched from the current rating system of groups 1 - 20 to a new 1 - 50 insurance scale.



## Technical specification notes.

- 01 The maximum power output figures are quoted in PS (or Pferdestärke, which is the metric equivalent of horsepower). To convert from metric to imperial horsepower, divide the PS figure by 1.0139.
- 02 Figures are calculated in accordance with manufacturer's criteria. Vehicle unladen weight ranges with 90% tank capacity without driver. The individual unladen weight depends on the specification of the vehicle, this then reduces the possible payload accordingly. The unladen weight and payload both include the fuel tank 90% full, driver (68 kg) and luggage (7 kg) in line with EU directive 95/48.
- 03 With increasing altitude the engine performance diminishes. From 1,000 m above sea level and for every 1,000 m thereafter 10% of the vehicle/trailer weight (trailer weight + gross vehicle weight) must be deducted.
- 04 Thanks to the knock control, unleaded four star (at least 95 RON) can be used instead of Super plus unleaded. In order to achieve maximum fuel consumption benefits on the TSI engine, Ultra Low Sulphur Petrol (ULSP) must be used.
- 05 The use of RME and FAME (bio diesel) is not possible.
- 06 Official fuel consumption according to EU Directive 99/94. The consumption calculation according to 1999/100/EC is based on the actual unladen weight of the vehicle. Additional specifications can lead to a higher weight class and hence to consumption figures of this higher weight class. The driving style, road and traffic conditions, environmental influences and vehicle condition can in practice lead to consumption figures, which may differ from those calculated with this standard.
- 07 The weight of a vehicle will influence the level of CO<sub>2</sub> emission it produces; as a result, vehicles with higher levels of specification and factory-fitted options may emit higher levels of CO<sub>2</sub>.

## Dimensions.

Exterior dimensions		
	Length, mm (Escape)	4427 (4457)
	Width – excluding door mirrors, mm	1809
	Width – opened front/rear doors, mm	3658/3499
	Height, mm	1686
	Height – opened bonnet/floor, mm	1868
	Height – opened tailgate/floor, mm	2086
	Wheelbase, mm	2604

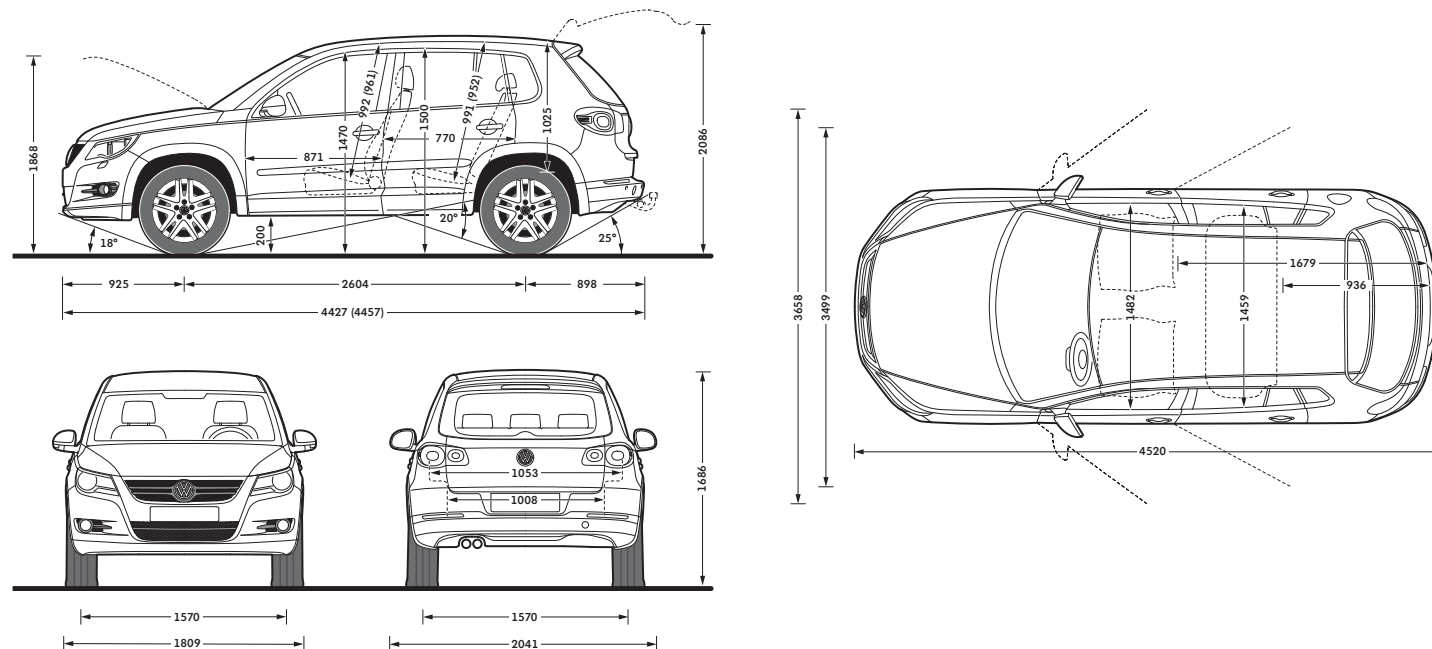

## The technology.

### Engines

- Front transversely-mounted engine
- 1.4 litre/150 PS<sup>(01)</sup> (110 kW) petrol engine.  
TSI engine with dual-charging, double injection catalytic converter heating, turbocharger with waste gate, additional mechanical supercharger, intercooler, maintenance free timing chain, continuous inlet camshaft timing adjustment, grey cast iron cylinder block, steel crankshaft, duo-centric oil pump, dual-circuit cooling system, fuel system regulated according to requirements, high pressure fuel pump with a delivery pressure of up to 150 bar, four valves per cylinder. The 1.4 TSI engine is the first to use a combination of supercharger and turbocharger. That means the engine is charged by a supercharger in addition to the turbocharger depending on the torque requirements
- 2.0 litre/170 PS<sup>(01)</sup> (125 kW) petrol engine. TBA
- 2.0 litre/200 PS<sup>(01)</sup> (147 kW) petrol engine.  
Four cylinder in-line engine, aluminium cylinder head, four valves per cylinder with roller rocker finger valve drive, electronic direct injection, variable inlet valve timing, programmed ignition with cylinder-selective anti-knock control, four single spark ignition coils, longlife spark plugs, exhaust gas turbocharger, three-way close-coupled pre-catalyst and underbody catalyst, lambda control
- 2.0 litre/140 PS<sup>(01)</sup> (103 kW) Common rail diesel engine. EU5 emissions standard, four cylinder in-line engine, four valves per cylinder, aluminium-silicon alloy cylinder head, reduced piston crown volume (improves swirl generation in the cylinder), toothed backlash compensator, intake manifold with electric continual tumble flap control, electronically controlled common rail direct injection fuel system with Bosch high pressure pump (up to 1800 bar) and 8-hole piezo injector units, pre-supply electronic fuel pump, oil cooler, intercooler, low temperature exhaust gas recirculation, additional coolant pump, turbocharger with variable turbine geometry, catalytic converter and Diesel Particulate Filter (DPF)

### Engines (continued)

- 2.0 litre/170 PS<sup>(01)</sup> (125 kW) Common rail diesel engine. EU5 emissions standard, four cylinder in-line engine, four valves per cylinder, aluminium-silicon alloy cylinder head, reduced piston crown volume (improves swirl generation in the cylinder), toothed backlash compensator, intake manifold with electric continual tumble flap control, electronically controlled common rail direct injection fuel system with Bosch high pressure pump (up to 1800 bar) and 8-hole piezo injector units, pre-supply electronic fuel pump, oil cooler, intercooler, low temperature exhaust gas recirculation, additional coolant pump, turbocharger with variable turbine geometry, catalytic converter and Diesel Particulate Filter (DPF)

### Transmission

- Front wheel drive
  - Six speed manual gearbox: 1.4 litre TSI 150 PS, 2.0 litre TDI 140 PS
- Four wheel drive
  - Six speed manual gearbox: all models
  - Seven speed auto DSG gearbox: 2.0 litre TSI 4MOTION 170 PS, 2.0 litre TSI 4MOTION 200 PS, 2.0 litre TDI 4MOTION 140 PS

### Steering

- Maintenance-free rack and pinion steering rack with speed related, electronically controlled servo assistance
- Height and reach adjustable and collapsible safety steering column

### Running gear

- Front suspension: McPherson strut, one-piece aluminium subframe, decoupled spring and shock absorber mounting, anti-roll bar
- Rear suspension: multilink, anti-roll bar
- ESP (Electronic Stabilisation Programme) – includes EDL (Electronic Differential Lock) and ASR (Traction Control)



## Volkswagen service for your peace of mind.

### The Volkswagen Warranty.

#### Three-year Warranty.

All Volkswagen Tiguan come with a three-year/60,000 miles warranty, which protects your car against the failure of most mechanical and electrical components due to manufacturing defects. This comprises a two-year manufacturer's warranty with unlimited mileage plus a further one-year/60,000 miles (whichever is soonest) Retailer Warranty. Should the mileage exceed 60,000 miles within the first two years, the manufacturer's two-year warranty will still be valid. If an additional warranty for subsequent years or higher mileage is desired, it may be purchased from an authorised Volkswagen retailer or repairer; however, this additional warranty must be purchased before the mileage reaches 60,000\*. Full details of the three-year warranty are available from your authorised Volkswagen retailer or repairer.

\* All warranty work must be completed by an authorised Volkswagen retailer or repairer.

#### Three-year Paint Warranty.

The paintwork of the Tiguan is covered against manufacturing defects for a period of three years. Naturally, the Tiguan must be cared for in compliance with the operating instructions which will be found in your vehicle handbook. Please consult your authorised Volkswagen retailer or repairer for full warranty details.

#### 12-year Body Protection Warranty.

The internal body sections and panels of the Tiguan are covered against rusting through from the inside for 12 years. Naturally, the Tiguan must be cared for in compliance with the operating instructions. Please consult your authorised Volkswagen retailer or repairer for full warranty details.

#### Service Intervals.

Volkswagen are pleased to offer you a choice on how your Tiguan is serviced. The appropriate selection is entirely dependent on how the car is likely to be driven and its general use. To help you identify which type of service would be most suitable, please refer to the following guide.

The Time and Distance Service is recommended for vehicles that will cover less than 10,000 miles in 12 months and if the vehicle is likely to be used in the following way:

- Predominantly urban driving, short journeys with frequent cold starts.
- Activities regularly producing high engine loading, e.g. frequent hill climbs, driving with vehicle fully loaded and towing.
- Uneconomical driving style using high rpms with heavy acceleration and heavy braking.

The service intervals for the Time and Distance Service are as follows:

- Oil change service                      Every 10,000 miles/1 year (whichever is soonest).
- Interval service                         Every 20,000 miles/2 years (whichever is soonest).
- Inspection service                      Every 40,000 miles/3 years (whichever is soonest).

The LongLife Service is recommended for vehicles with a daily mileage of more than 25 miles where the vehicle is driven regularly mainly on longer distance journeys. The vehicle is driven mainly at a constant speed with minimum vehicle and engine loading, minimal towing and driven in an economical manner.

With the LongLife Service the vehicle can cover anywhere between 10,000<sup>†</sup> and a maximum of 18,000<sup>†</sup> miles or 24 months (whichever is soonest) between oil changes. Inspection service is typically in the third year of ownership and thereafter every second year, for vehicles with an approximate annual mileage of 10,000 miles.

<sup>†</sup> Please note that mileages are approximate as the service indicator system uses kilometres as the distance measurement.

Please consult your authorised Volkswagen retailer or repairer for advice and full details.

#### Approved Accessories.

A comprehensive range of accessories from alloy wheels to carpet mats is available to complement the factory-fitted option list. Volkswagen approved accessories purchased from and fitted by your authorised Volkswagen retailer at the point of vehicle sale will also benefit from the three-year vehicle warranty.

#### Extended Warranty.

You may purchase additional protection from your authorised Volkswagen retailer or repairer, or contact 0870 9000 115.

#### Tax Free Sales.

For full details, please contact your authorised Volkswagen retailer.

#### Volkswagen Insurance<sup>‡</sup>.

We want you to start enjoying your new car from day one and thanks to Volkswagen Insurance complimentary seven day cover, you can. Call free on 0800 316 7892 (lines are open Monday to Friday 8 am - 9 pm and Saturday 9 am - 5 pm), provide a few details and a cover note will be sent to your retailer. They will then tax your car and you can drive it away.

Visit [www.insurewithvolkswagen.co.uk](http://www.insurewithvolkswagen.co.uk) for details of the full range of insurance products available. Here you can also get a quote for your annual car insurance and buy it online too. All of our insurance products are designed to ease the pain of making a claim.

<sup>‡</sup> Volkswagen Insurance is a trading name of Volkswagen Insurance Service (Great Britain) Limited, an appointed representative of Volkswagen Financial Services (UK) Limited, Brunswick Court, Yeomans Drive, Blakelands, Milton Keynes MK14 5LR. Registered in England number 2835230. Volkswagen Insurance is sold, underwritten and administered by Allianz Insurance plc registered in England number 84638. Registered office 57 Ladymead, Guildford, Surrey GU1 1DB. Volkswagen Financial Services (UK) Limited and Allianz Insurance plc are authorised and regulated by the Financial Services Authority. Volkswagen Financial Services (UK) Limited and Allianz Insurance plc are not part of the same corporate group.

#### Volkswagen Finance<sup>±</sup>.

Volkswagen Finance specialises in providing funding solutions for Volkswagen drivers. Whether your Volkswagen is for private or business use, you can choose from a range of funding options.

- Solutions – a personal contract plan
- Hire purchase
- Lease purchase
- Finance lease
- Contract hire

With all Volkswagen Finance products you can choose a fixed-cost maintenance plan to help you budget for your servicing and maintenance costs.

No matter what finance product you choose, your local Volkswagen retailer will be able to provide you with a personalised quote that could meet your budget and vehicle needs.

<sup>±</sup> Volkswagen Finance is a trading name of Volkswagen Financial Services (UK) Limited.

An offer of finance depends on certain conditions. Available to people over 18 in the UK only.

#### Volkswagen Roadside Assistance.

Every new car is registered for Volkswagen Roadside Assistance for one year. This provides vehicle home and roadside recovery in the unlikely event of a breakdown in the UK and Europe (subject to conditions). Volkswagen Roadside Assistance can also be purchased for subsequent years. For full details, please contact your authorised Volkswagen retailer or repairer.

#### Tax Free Sales.

For full details, please contact your authorised Volkswagen retailer.

#### CO<sub>2</sub> Emissions.

Increased weight of a vehicle, including higher trim levels and the addition of options will have a detrimental influence on the level of fuel consumption and CO<sub>2</sub> emissions produced.

The CO<sub>2</sub> and fuel consumption figures are obtained from tests on a representative vehicle of the type, conducted and approved in accordance with Council Directive 80/1268/EEC as amended by Directive 1999/100/EC (or later) on the approximation of the laws of the member states relating to the carbon dioxide emissions and the fuel consumption of motor vehicles.

#### Please Note:

Some illustrations in this brochure do not necessarily reflect UK specifications and may not be available. In particular, controls and some items of equipment are positioned differently for the UK.

The specifications contained in this brochure are for information purposes only and are subject to change. If you require any specific feature, you must consult your authorised Volkswagen retailer who is regularly updated with any change in specification. Please check model availability and full specification details with your authorised Volkswagen retailer prior to ordering.

Note: We would like to advise you that telephone calls to Volkswagen Customer Care may be monitored and recorded as part of our training and quality assurance processes. All our monitoring and recording processes meet OfTel regulations.