

C-Class Saloon and Estate



Mercedes-Benz





First impressions

Saloon. Muscular and confident on the outside, elegant and welcoming on the inside, the C-Class Saloon further improves a successful formula – one that combines countless thoughtful details with a refined and dynamic drive. ECO start/stop technology, Attention Assist and Parktronic with Advanced Parking Guidance all come as standard, while up to 10 electronic assistants and the optional Becker® Map Pilot help to make your journey as safe and hassle-free as possible. Discover the best C-Class Saloon yet.

[Overview](#) | from page 4 [Insights](#) | from page 16

Estate. The C-Class Estate sets the pulse racing – with efficiently powerful engines and agile handling – and yet soothes the spirit too, relaxing and reassuring you with vigilant safety systems and exceptional comfort. What's more, it gives you the space to carry all kinds of cargo plus the luxury of effortless loading and unloading – all wrapped in an exterior that is now sportier and more striking than ever. The C-Class Estate: proof that practicality can be scintillating.

[Overview](#) | from page 10 [Insights](#) | from page 16

Featured models:

C 350 Avantgarde | Saloon | front cover and from page 2
Palladium Silver metallic, AMG Sports Package

C 250 CDI Elegance | Saloon | from page 4
Cavansite Blue metallic, Intelligent Light System

C 350 Avantgarde | Estate | front cover and from page 10
Palladium Silver metallic, AMG Sports Package

C 350 CDI Elegance | Estate | from page 11
Diamond White metallic, Intelligent Light System

Specifications shown may include optional equipment and accessories

See Mercedes-Benz in a new light. With a wide selection of new finance and upgrade offers available across our model range, now is a great time to get yourself behind the wheel of a Mercedes-Benz. For further information contact your local Mercedes-Benz Retailer or visit www.mercedes-benz.co.uk/offers



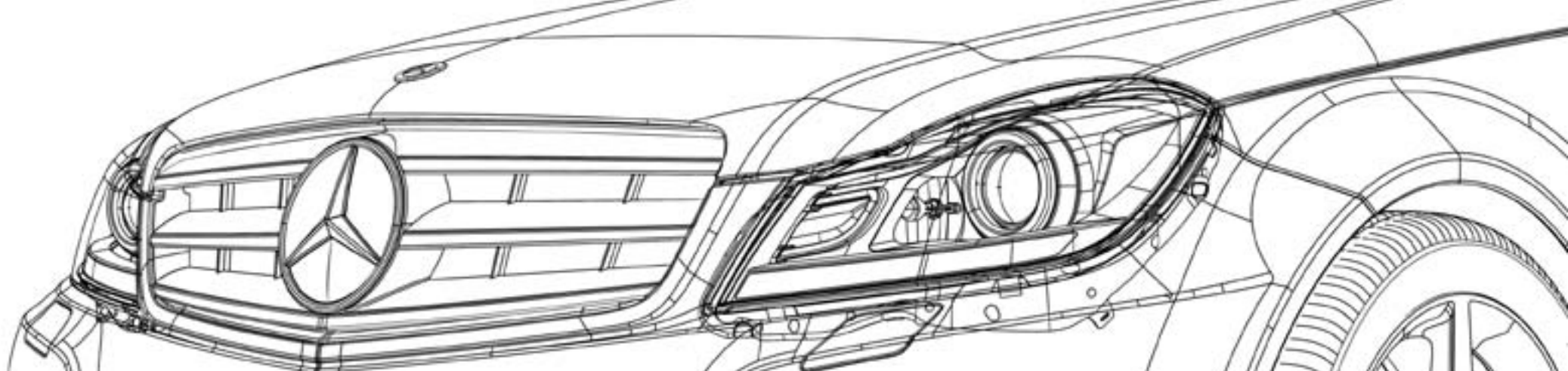

Facts

Efficiency and enjoyment: diesel and petrol engines, transmissions, suspension and Dynamic Handling Package.

Engines and suspension | from page 19

Protective instincts: technologies that enhance occupant protection and help to avoid accidents.

Safety | from page 29

More luxury, less stress: multimedia systems, electronic assistants, automatic climate control, seats and the C-Class Estate load compartment.

Comfort | from page 33

Real-world high performance: the C 63 AMG Saloon and Estate plus AMG Performance Studio options.

AMG | from page 45

Your personal C-Class: model lines, standard equipment and optional extras, alloy wheels and Retailer-fit accessories.

Equipment | from page 53

More Mercedes-Benz: Mercedes-Benz World and Museum, Roadside Assistance, Mercedes-Benz Finance and Insurance, test drive and Interactive Owner's Manuals.

Services | from page 73

The C-Class in figures: dimensions, paint finishes and technical data.

Facts and finishes | from page 75



Nobody's perfect?
We beg to differ



Some strive to achieve perfection; the C-Class simply makes it look easy. With innovative technology, unsurpassed comfort and first-class finishes, it sets standards others can only hope to emulate.

Optional Intelligent Light System with LED daytime running lights



Enjoy today – without endangering tomorrow

Performance and comfort, luxury and efficiency: the new C-Class is the car that lets you have it all. Its standard Agility Control suspension with Adaptive Damping System and optional Dynamic Handling Package maximise driving enjoyment, while BlueEFFICIENCY measures and direct-injection engines minimise CO₂ emissions. Rarely has so much pleasure been pursued so responsibly.

→ pages 19–20, 27–28





How do you follow such a handsome exterior? With a beautifully appointed interior

Its styling captures the heart, its cabin calms the soul - with high levels of comfort, sumptuous finishes and an elegantly styled dashboard. Also on board: up to 10 electronic assistants, state-of-the-art telematics and optional comfort-ventilated seats. Now that truly is a hard act to follow.





Don't settle for less. Except when it comes to emissions.

Thanks to features such as ECO start/stop and optimised aerodynamics, BlueEFFICIENCY technology reduces fuel consumption and emissions levels - without compromising on power or performance. It's a case of less, in fact, being more. → pages 19-20

Here, the finishes are just the beginning





Let your heart rule your head –
or vice versa



Whether you listen to reason or follow your emotions, you'll find it hard to say no to the C-Class Estate. Its exterior exudes desirability, its versatile cabin meets almost every need. Rarely has the sensible choice seemed so appealing.

Built for A-roads, B-roads and data highways



With engines that deliver responsive performance and an optional Driving Assistance Package that further reduces risk, the C-Class gets you to your destination as swiftly and safely as possible. What's more, it can take you online in next to no time too – courtesy of the optional COMAND Online multimedia system with direct internet access.

Optional Intelligent Light System with LED daytime running lights and 18" alloy wheels



True perfection is when there's nothing more to add or improve. Take the carefully honed exterior of the C-Class Estate. Its lines are harmonious yet highly dynamic, with alloy wheels adding a stylish finishing touch. The rear, meanwhile, is simply flawless, thanks to details such as the chrome tailgate handle and attractive LED tail lights.

Refined to the point of perfection



Versatility with a three-pointed star

The C-Class Estate is whatever you want it to be: a first-class family carriage – with luxury and legroom for five – or a trusty transporter of loads, with up to 1,500 litres of luggage space, a 540 kg maximum payload and intelligent Easy-Pack features. → pages 41-42





Its best side? The inside

The C-Class exterior may be the crowd-pleaser, but the interior is an attraction in its own right. Fine finishes and colours, a stylish dashboard featuring wood or aluminium trim and a nappa leather-trimmed steering wheel are just a few of the many eye-catching highlights.







Inspiration from above

With its pale-yellow neo-classical façade and idyllic Lake Como setting, Villa Salazar looks for all the world like the epitome of aristocratic *dolce vita*. In fact, the reality is rather different: since 1998, its elegant walls have housed the Mercedes-Benz Advanced Design Studio, interiors division – a 20-strong team of engineers, designers and model-makers who consider how the cabins of tomorrow’s Mercedes should look and feel. The villa is, in many ways, the ideal location for these professional aesthetes: as the home of Italian fashion and the centre of its leather

industry, the Como-Milan-Turin triangle combines haute couture with fine craftsmanship and offers an endless source of ideas when it comes to new forms, finishes and materials. Should they nevertheless want for inspiration, all our interior artists have to do is look up – at the sumptuous baroque frescoes decorating the villa’s walls and ceilings. With influences like this, it’s no wonder the design studio’s input leads to sumptuous and beautifully detailed interiors. To see one for yourself, just take a seat in the C-Class Saloon or Estate.



19 **BlueEFFICIENCY**21 **Diesel engines**

4-cylinder
6-cylinder

23 **Petrol engines**

4-cylinder
6-cylinder

25 **Transmissions**

6-speed manual
7G-Tronic Plus

27 **Suspension**

Agility Control suspension
Sports suspension
Dynamic Handling Package

29 **Safer driving**

Attention Assist
Lane-Keeping Assist/Blind Spot Assist
Intelligent Light System
Driving Assistance Package

31 **Anticipating danger**

Pre-Safe® Brake and BAS Plus
Pre-Safe® system

32 **Protecting occupants**

Neck-Pro front head restraints
Airbags

33 **Multimedia systems**

COMAND Online
Audio 20 radio/single CD
Harman Kardon® Logic 7®
surround sound system
Becker® Map Pilot

35 **Electronic assistants**

Speed Limit Assist
Reversing camera
Parktronic with
Advanced Parking Guidance

37 **Climate control systems**

Luxury automatic climate control
Automatic climate control
Rear seat controls

39 **Seats**

Seats
Comfort-ventilated front seats
Memory Package

41 **Load compartment (Estate)**

Luggage capacity
Load compartment cover

43 **Load compartment systems (Estate)**

Easy-Pack load-securing kit
Self-levelling suspension
Easy-Pack tailgate



45	C 63 AMG exterior	53	Lines, upholstery and trim SE Elegance Sport	73	Services Test drive Mercedes-Benz Finance and Insurance Factory Collection Interactive Owner's Manuals Roadside Assistance Mercedes-Benz World	75	Dimensions Saloon Estate
47	C 63 AMG interior	65	Standard equipment	76	Technical data	78	Paint finishes
49	C 63 AMG technology AMG 6.3-litre V8 AMG sports suspension AMG Speedshift MCT 7-speed sports transmission	67	Optional extras				
51	AMG Performance Studio	69	Alloy wheels Standard wheels Optional wheels AMG wheels				
		71	Retailer-fit accessories				



BlueEFFICIENCY – technology for more efficient driving

As the inventor of the motor car, we feel we have a special responsibility for improving its resource efficiency – without compromising on safety, comfort and driving pleasure.

Our comprehensive BlueEFFICIENCY measures have already brought significant cuts in fuel consumption to many current Mercedes-Benz models, helping to lower both their CO₂ emissions and their running costs. What's more, we are continuing to develop new environmentally friendly technologies that will reduce emissions even further and help to make motoring more sustainable in the long term.

BlueEFFICIENCY – the Mercedes-Benz efficiency drive.

In addition to highly advanced and efficient engines, BlueEFFICIENCY models come with a range of energy-saving measures that enable fuel consumption and CO₂

emissions to be reduced by up to 25%. These measures vary from model to model but can include ECO start/stop, on-demand ancillary components and low-resistance tyres, as well as aerodynamic optimisation and the use of lightweight materials.

BlueTEC – cleaner diesel power. BlueTEC is our cleanest diesel technology to date. Its combination of advanced common-rail direct injection, optimised combustion and modular emissions control systems reduces particulate levels by up to 95% and removes up to 90% of nitrogen oxides, leaving little but water, harmless nitrogen and the satisfaction of knowing you've done your bit for the environment.

HYBRID and BlueTEC HYBRID – the future of internal combustion. The next stage in our efficiency drive, hybrid drivetrains will bring new levels of fuel

efficiency and emissions reduction to tomorrow's Mercedes-Benz passenger cars. The petrol/electric HYBRID system allies an economical internal combustion engine to an electric motor that not only assists the engine when accelerating but also recovers kinetic energy during braking. In addition, the system automatically shuts off the engine as the car slows to a standstill, helping to reduce fuel consumption even further. The diesel equivalent, BlueTEC



BlueEFFICIENCY measures substantially reduce fuel consumption and CO₂ emissions





HYBRID, combines the benefits of hybrid drive with the clean-burn technology of BlueTEC. It achieves outstanding fuel economy while keeping harmful emissions to a minimum.

E-Cell and F-Cell – new drivetrain concepts.

We are also committed to the development of electric powertrains that produce zero local emissions. To this end, we've already produced limited runs of



The HYBRID system lowers fuel consumption by up to 20%

our A-Class E-Cell and B-Class F-Cell vehicles. The F-Cell, whose electric motor is powered by a hydrogen fuel cell, recently completed the F-Cell World Drive endurance test, proving itself in all kinds of driving conditions. The E-Cell meanwhile, which is powered by twin lithium-ion batteries and has a range of more than 120 miles, is currently being trialled in real-world conditions by drivers across Europe. In 2013, we also expect to begin production of the SLS AMG E-Cell,¹



The SLS AMG E-CELL¹: local emissions-free driving with a battery-powered electric motor

an all-electric supercar that delivers breathtaking performance. The planned E-Cell Plus drivetrain, meanwhile, will combine electric battery power with a small range-extending internal combustion engine.

Design for Environment. Our environmental philosophy is not just about in-car technologies. It also involves taking the entire lifecycle of each vehicle into account, from its initial planning to its end-of-life recycling. We apply the same approach to the building and maintenance of new factories too, saving energy, avoiding harmful emissions and making increasing use of renewable resources. In addition, Mercedes-Benz is involved in the development of alternative fuels and conducts research in the field of bionics.

For more information about what BlueEFFICIENCY can do for you, please visit

www.mercedes-benz.co.uk/blueefficiency



Diesel engines

Powerful, refined and impressively fuel-efficient, the C-Class diesel engines deliver improved performance and even lower emissions, thanks to the latest in Mercedes-Benz diesel technology.

4-cylinder diesel engines. The 4-cylinder C-Class diesel engines offer torquey performance and impressive responses even at low engine speeds, while also ensuring improved fuel efficiency and reduced CO₂ emissions.

The key to this impressive set of achievements is a combination of advanced technologies. The engines' fourth-generation common-rail system boasts ultra-precise injectors, increased pressures of up to 2,000 bar and further optimised combustion chambers. The higher ignition pressure and turbocharging mean high levels of torque are available at any engine speed, while the twin balancer shafts ensure the engines remain agreeably refined.

In addition, all three 4-cylinder diesel models meet Euro 5 emissions standards and come with a variety of innovative fuel-saving features. These include intelligent alternator management that enables kinetic energy to be used to charge the battery when coasting, a radiator shutter that helps to reduce drag when only moderate cooling is required, and an ECO start/stop function.

6-cylinder diesel engine. The V6-engined C 350 CDI BlueEFFICIENCY delivers improved fuel economy combined with enhanced performance. Thanks to precise and fast-acting injectors, injection pressures of up to 1,600 bar and an optimised turbocharger, it generates a maximum 620 Nm of torque, ensuring effortless acceleration in all situations, while output has increased to 265 hp (195 kW). What's more, this most powerful of C-Class diesels also comes with the ECO start/stop function, which helps to further reduce fuel consumption, and meets Euro 5 emissions regulations.

The following C-Class diesel models are available:

- C 200 CDI BlueEFFICIENCY - 136 hp (100 kW) and 360 Nm
- C 220 CDI BlueEFFICIENCY - 170 hp (125 kW) and 400 Nm
- C 250 CDI BlueEFFICIENCY - 204 hp (150 kW) and 500 Nm
- C 350 CDI BlueEFFICIENCY - 265 hp (195 kW) and 620 Nm





The C-Class offers a choice of three high-tech 4-cylinder diesel engines

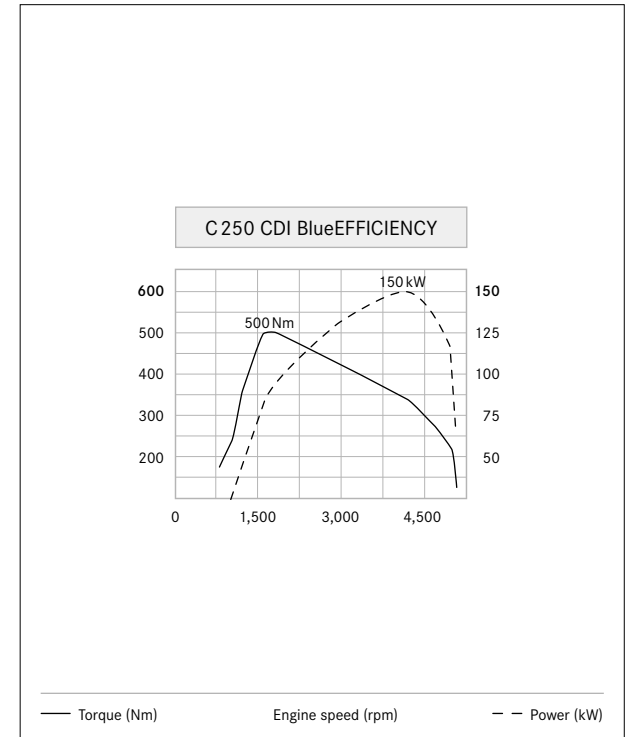

The C 250 CDI BlueEFFICIENCY combines high levels of power and torque with impressive fuel efficiency



Petrol engines

Innovative engine technology enables the petrol C-Class models to achieve even greater levels of fuel efficiency and emit less CO₂ than ever.

4-cylinder petrol engines. Direct petrol injection, variable valve control and turbocharging help the optimised 4-cylinder petrol engines to deliver high levels of power and torque along with low fuel consumption and emissions.

More complete combustion and variable valve control ensure these innovative engines use fuel more efficiently, while weight-savings and lower internal friction help to further reduce their fuel consumption. Both 4-cylinder C-Class petrol engines feature twin balancer shafts for optimum refinement and meet the strict Euro 5 emissions standards.

6-cylinder petrol engine. With fuel savings of up to 31% compared to its predecessor, the C 350 BlueEFFICIENCY's V6 offers significant improvements in fuel consumption and emissions levels. What's more, thanks to direct petrol injection technology with spray-guided combustion and piezo injectors, it combines this enhanced efficiency with refined and effortless power, delivering an output of 306 hp (225 kW) plus a maximum 370 Nm of torque from 3,500 to 5,250 rpm. Other fuel-saving measures include the ECO start/stop function, an innovative intake and exhaust system, on-demand ancillaries, intelligent alternator management and the use of lightweight materials.

The following C-Class petrol models are available:

- C 180 BlueEFFICIENCY - 156 hp (115 kW) and 250 Nm
- C 250 BlueEFFICIENCY - 204 hp (150 kW) and 310 Nm
- C 350 BlueEFFICIENCY - 306 hp (225 kW) and 370 Nm





The 4-cylinder petrol engines combine direct petrol injection, variable valve control and turbocharging

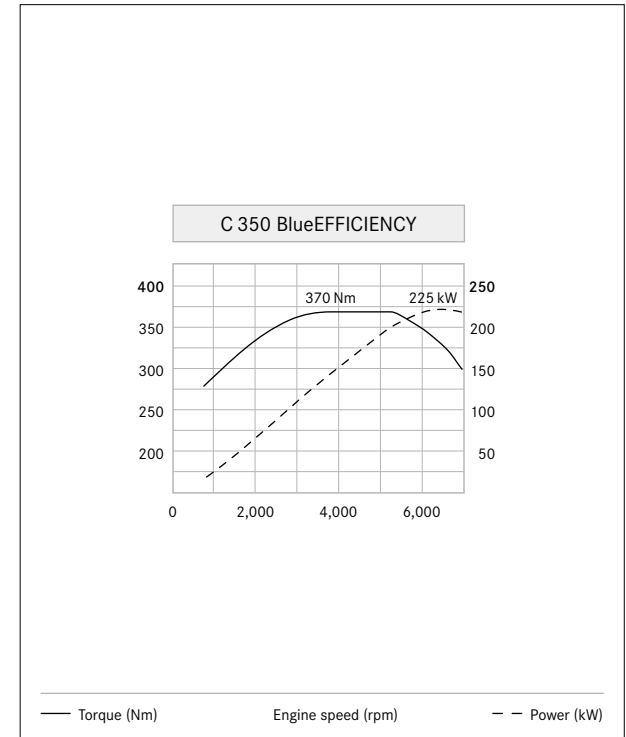

The C 350 BlueEFFICIENCY offers the ideal combination of harmonious power delivery, driving enjoyment and energy efficiency

Transmissions

The transmissions for the C-Class are perfectly matched to its engines. They offer a choice of manual and automatic systems, enable you to opt for a sporty or economical driving style, and are ergonomic and easy to use.

6-speed manual transmission. 4-cylinder C-Class models (except C 250 BlueEFFICIENCY) are equipped with our 6-speed manual transmission, which features Hill Start Assist with an innovative hold function that makes hill starts a breeze. It offers quick and precise gear changes, with ratios carefully matched to engine performance, and helps you save fuel by indicating the most efficient shift point in the instrument panel.

7G-Tronic Plus. Fitted as standard on the C 250 BlueEFFICIENCY, C 350 BlueEFFICIENCY, C 350 CDI BlueEFFICIENCY and available as an option for other 4-cylinder models, 7G-Tronic Plus is the latest version of our 7-speed automatic transmission. It ensures the engine is always operating at the optimum speed, delivers faster, smoother shifts, and provides better acceleration, even skipping gears in kickdown for more rapid overtaking.

One of the key improvements for 7G-Tronic Plus is the addition of a torque converter that delivers swift throttle responses, great durability, low noise levels and significantly improved efficiency.

All manual and automatic models come with the ECO start/stop function as standard. It cuts the engine automatically at traffic lights and when queuing, helping to further reduce fuel consumption.



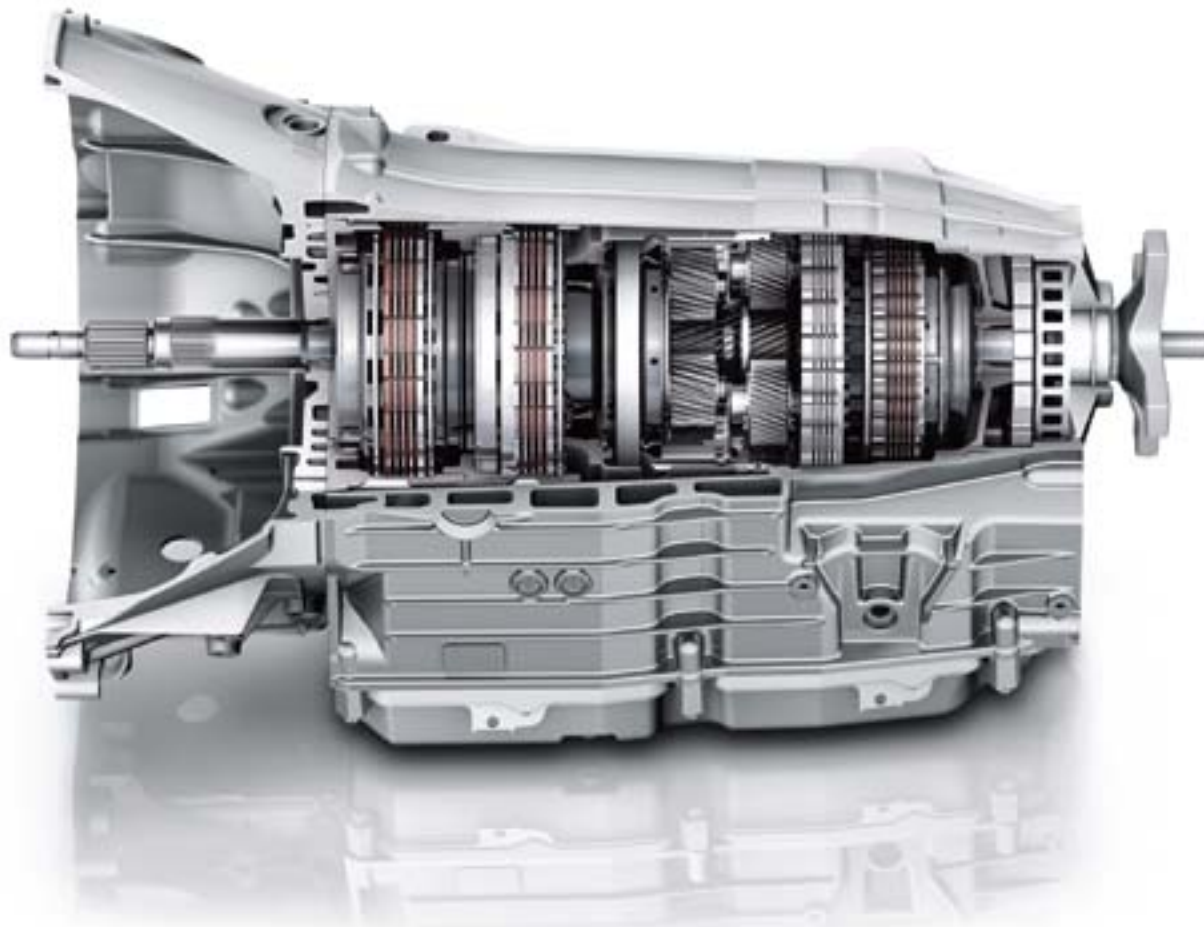

7G-Tronic Plus: the result of more than 50 years' experience in automatic transmission technology



Suspension

Thanks to Agility Control suspension with Adaptive Damping System, C-Class drivers enjoy the best of both worlds: agile handling and a supremely comfortable ride.

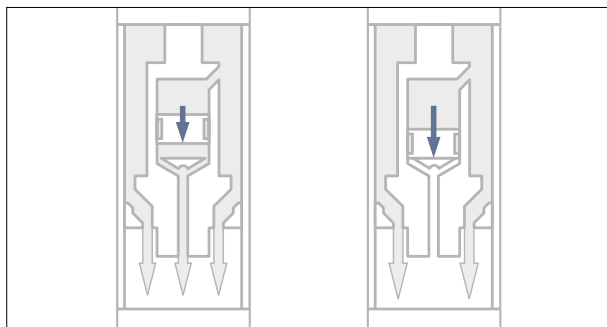

Agility and comfort combined: the C-Class suspension adjusts the damping levels automatically to suit the surface and situation

Agility Control with Adaptive Damping System

(standard on SE and Elegance). The Agility Control suspension with Adaptive Damping System offers an ideal blend of cornering ability and comfort. Its dampers automatically adjust to the requirements of the situation or surface, enhancing damping levels and optimising stability particularly on poorly made road surfaces.

Agility Control sports suspension (standard on Sport).

The C-Class Sport comes with 15 mm lower Agility Control sports suspension. It features firmer springing and damping than the standard Agility Control set-up, which helps to reduce body roll and increase stability. The sports suspension is complemented by a more direct sports parameter steering system that enables steering input to be fed more immediately to the road.



Dynamic Handling Package (optional on Sport).
The Dynamic Handling Package with sport mode enables you to switch to a sportier set-up at the touch of a button. Activating sport mode gives you firmer damping, faster throttle responses and, on automatic models, more aggressive gear shifts that optimise acceleration.



The optional Dynamic Handling Package makes for an even sportier drive



Safer driving

The C-Class offers vigilant electronic assistants that help you to recognise and defuse potentially critical situations – and hence reduce the risk of an accident. It's one of the many reasons why C-Class driving is so relaxing.

Attention Assist (standard). Particularly beneficial on long journeys, Attention Assist is an innovative system for detecting tiredness. Between speeds of approximately 50 and 110 mph, it assesses the driver's behaviour via an array of sensors and registers unexpected changes that may indicate drowsiness or concentration lapses – such as involuntary movements of the steering wheel.



By vibrating the steering wheel, Lane-Keeping Assist can warn you if the car threatens to come off the road

Lane-Keeping Assist/Blind Spot Assist (available as optional Lane-Tracking Package). Lane-Keeping Assist recognises white road markings and warns you via subtle vibrations of the steering wheel should you unintentionally stray out of lane. Blind Spot Assist, meanwhile, uses twin radar sensors to monitor the hard-to-see areas either side of the rear. In lane changes at speeds of approximately 20 mph or above, the system can detect the presence of another vehicle



For safer lane changes, Blind Spot Assist monitors the hard-to-see areas to the sides of the car's rear

in your blind spot and alert you to the danger via a symbol in the relevant exterior mirror.

Intelligent Light System (standard on Sport, optional on Elegance). The Intelligent Light System comprises a variety of modes and functions: country mode, motorway mode, fog mode, cornering light function and the Active Light System for better visibility in bends. It also includes LED daytime running lights and Adaptive



Attention Assist can detect the onset of tiredness and alert you to the need for a break



High Beam Assist, which maximises the headlamps' range when no other road users are within sight, then automatically dips the beams if the lights of an oncoming vehicle are detected.

Driving Assistance Package (optional). This option package combines a variety of intelligent safety systems. Active Blind Spot Assist makes for safer lane changes, alerting you to the presence of a vehicle

in one of your blind spots via a warning triangle in the corresponding exterior mirror. Should you proceed with the manoeuvre, the system helps you to avoid a potential collision by applying the brakes on the opposite side. Active Lane-Keeping Assist, meanwhile, gently vibrates the steering wheel should your C-Class start wandering out of lane. If there's no reaction, the system can apply the requisite braking pressure in order to correct the car's course. Also included in the

package is DISTRONIC PLUS radar-assisted cruise control. It helps you to maintain a preset distance from the vehicle in front, applying the brakes and accelerating again automatically as required, making for more relaxing driving both at speed and in stop/start traffic. In addition, Brake Assist (BAS Plus) and Pre-Safe® Brake can intervene in emergency braking situations, helping to avoid or reduce the severity of an impact.

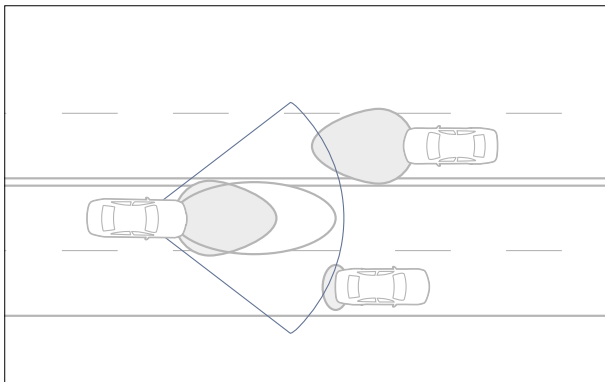

The Intelligent Light System automatically optimises visibility in a range of different situations

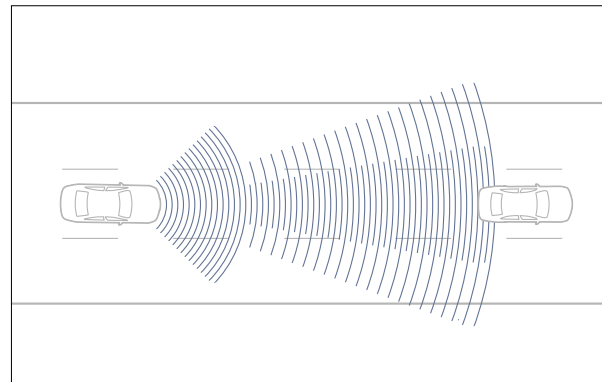

DISTRONIC PLUS radar-assisted cruise control can bring the car to a standstill and get you moving again automatically



Occupant protection

In the event of a possible or imminent accident, the C-Class does everything it can to protect you and your passengers as effectively as possible.

Pre-Safe® Brake and BAS Plus (part of optional Driving Assistance Package).

If it detects the risk of a collision, Pre-Safe® Brake alerts the driver via visual and audible warnings. At the same time, BAS Plus assesses the brake force required in order to avoid an impact. If the driver applies the brakes but uses insufficient force, BAS Plus automatically raises the braking pressure to a level that exploits the remaining stopping distance to the full, thereby also lessening the likelihood of a shunt from behind.

Should the driver fail to react to Pre-Safe® Brake's warning signals, it slows the car automatically, providing a further warning, and triggers a range of Pre-Safe® measures. If the driver still doesn't respond, the system then initiates autonomous emergency braking, enabling the speed and severity of any impact to be significantly reduced.

Pre-Safe® system (standard). If it detects a probable accident scenario, Pre-Safe® can take a range of anticipatory measures to prepare the occupants for an imminent impact. These can include activating the front seat belt tensioners and automatically closing the windows and sunroof (if fitted), ensuring maximum protection from airbags and seat belts should an impact then occur. In addition, the air chambers of the optional multi-contour front seats are instantly activated to help front seat occupants stay firmly in their seats, while the optional memory function enables the front passenger seat to be moved to a safer position in an accident. If a collision is avoided, the seat belt tension is released and the Pre-Safe® system returns to standby.

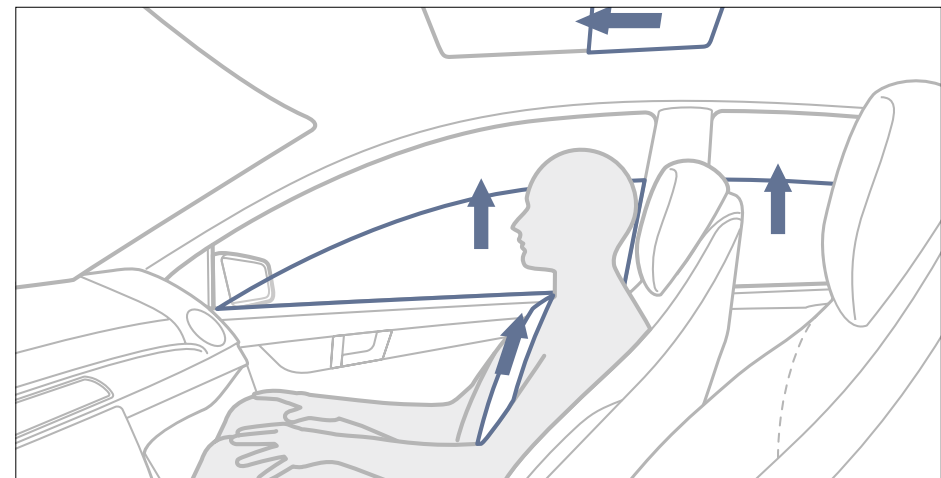

The Pre-Safe® system can detect critical situations and take anticipatory measures to enhance occupant protection



Protecting occupants

The C-Class optimises safety even if an accident proves unavoidable, initiating measures during and immediately prior to an impact that can reduce the risk of injury to its occupants.

Neck-Pro front head restraints (standard). The Neck-Pro front head restraints help to reduce the risk of whiplash injuries. In the event of a rear-end impact, they automatically move forwards and upwards, enabling them to support the head sooner. The optional Neck-Pro comfort front head restraints feature flexible bolsters that further improve side support.

Airbags (standard). The C-Class is fitted with seven airbags as standard: two dual-stage front airbags that inflate according to the projected severity of the impact, plus front sidebags, windowbags and a driver's side kneebag that helps to further reduce the risk of injury to the driver. Sidebags for rear seat occupants are available as an option.

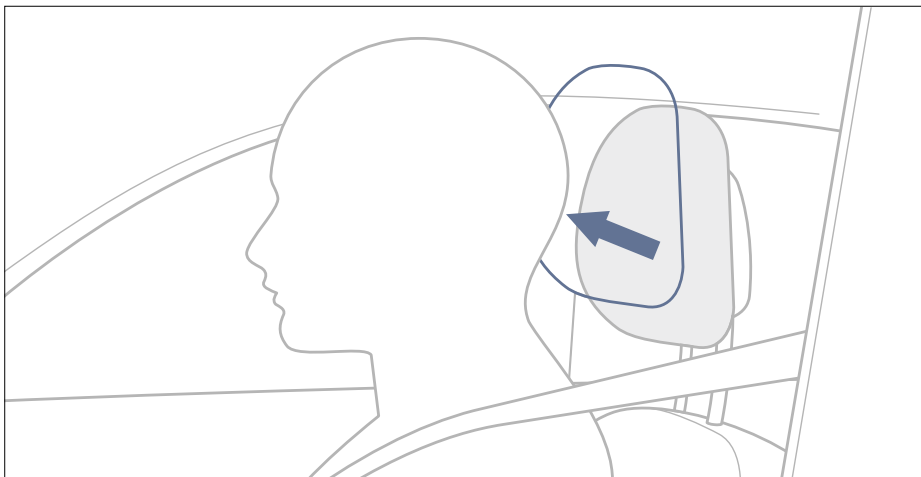

In the event of a rear-end impact, the Neck-Pro front head restraints are raised by 30 mm and moved 40 mm further forward

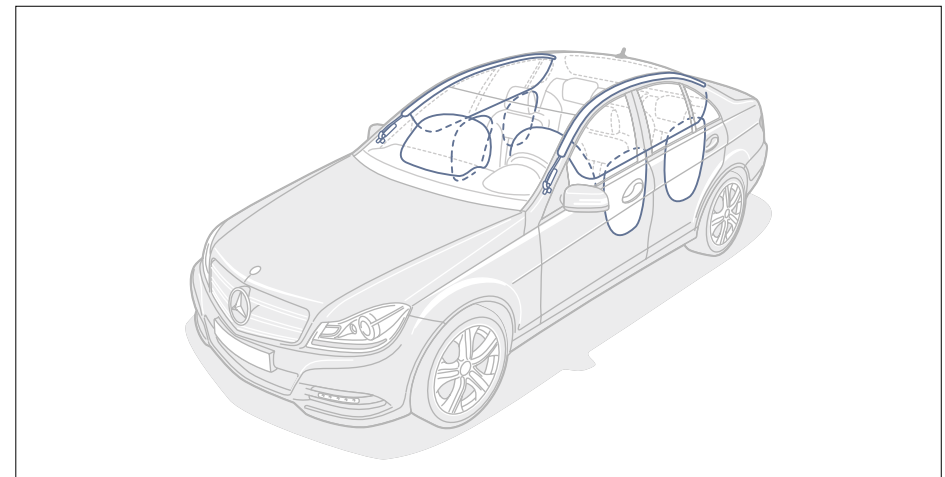

Featuring seven airbags as standard, the C-Class comes with restraint systems that help to significantly reduce the risk of injuries in an accident



Multimedia systems

The C-Class offers a choice of audio and navigation systems, from the standard Audio 20 radio/single CD system to the optional COMAND Online multimedia system.



COMAND Online is an all-in-one audio, navigation and communications centre with mobile internet access. Its key functions can be operated either using the intuitive controller or via Linguatronic voice control

COMAND Online (optional). The COMAND Online multimedia system combines hard-drive navigation with three years of free European map updates, mobile internet access and a wide range of entertainment features. These include an equaliser with speed-sensitive volume adjustment, a music library with 10 GB of storage space for audio files and a DVD drive that plays CDs, MP3s, and video or audio DVDs. Thanks to the SD memory card slot, aux-in and USB ports and Bluetooth® interface, you can also connect a variety of external devices and storage media. In conjunction with an internet-ready mobile phone, the online function and built-in browser even enable you to surf the Web and access a range of Mercedes-Benz mobile internet services. COMAND Online can be operated either via the intuitive central controller, the steering wheel's multi-function buttons or the Linguatronic voice control system, with menus and maps presented on the high-resolution 7-inch colour display in the centre of the dashboard.

Audio 20 radio/single CD (standard). The Audio 20 system offers all the key features of a modern in-car entertainment system: radio, CD drive, MP3 playback, USB and aux-in ports and Bluetooth® interface. It also now comes with a larger 5.8-inch central display and can be further enhanced with options such as a 6-disc CD changer and our Media Interface.



The Audio 20 radio/single CD system comes with a Bluetooth® interface for hands-free telephony plus a convenient telephone keypad

Harman Kardon® Logic 7® surround sound system (optional). With its subwoofer, 9-channel DSP amplifier and 3D spatial sound, this 12-speaker system delivers a first-class audio experience for each occupant. It also maintains optimum clarity and enjoyment at all times, thanks to Dolby Digital 5.1 and speed-sensitive volume adjustment.



The Harman Kardon® Logic 7® surround sound system: 12 speakers and 450 watts equals exceptional listening enjoyment

Becker® Map Pilot (optional). Becker® Map Pilot can be integrated with the Audio 20 CD system's central controller and display, turning it into a fully featured navigation system, and tailored to your needs by downloading additional functions and map updates. The control unit can be quickly secured and connected via a console in the glove compartment and removed at any time.



With the Becker® Map Pilot, map data can be viewed on the central colour display



Electronic assistants

The C-Class offers electronic driver aids that make for more effortless driving and manoeuvring, helping to ensure your journey is as relaxing as possible.



Speed Limit Assist even recognises and displays temporary speed restrictions

Speed Limit Assist (fitted with the optional COMAND Online system). Speed Limit Assist reads speed limit signs and displays the permitted maximum speed in the instrument panel and on the COMAND Online navigation screen until the limit changes. Its front-mounted camera reads speed limit warnings both on roadside signs and in overhead gantries and is particularly useful in areas where the speed limit varies or when passing through roadworks. To help identify the limit correctly, it compares speed limit signs with map data from the navigation system, enabling it to recognise when you are entering or leaving built-up areas for instance.



Reversing camera (optional; only in conjunction with COMAND Online). This rear-mounted wide-angle camera makes for safer and easier parking manoeuvres. Activated automatically as soon as the driver engages reverse, it captures the area immediately behind the car and enables you to see the image on the dashboard's central display.



The reversing camera provides additional assistance when parking

Parktronic with Advanced Parking Guidance (standard). Parktronic uses the sonar principle to help you avoid low-speed knocks during parking manoeuvres. It sends out ultrasound signals that reflect off other objects and are picked up by sensors in the front and rear bumpers. The system then processes this information and calculates the size of the gap to the front and rear, enabling it to alert you via acoustic and visual warnings as you approach the vehicle or object.



With Advanced Parking Guidance, information on the parking manoeuvre is displayed in the instrument panel

Advanced Parking Guidance can help you to find and manoeuvre into parking spaces. At speeds of around 20 mph, it measures gaps in lines of parallel-parked cars and alerts you as soon as it finds a suitably sized space. Once reverse is engaged, it then guides you in via a combination of acoustic signals and graphics in the instrument panel, showing the required steering angle and telling you when to turn the wheel.

Climate control

The right cabin climate makes for a relaxed, alert driver and contented passengers. Which is why the C-Class lets occupants choose their own individual temperature settings.



The highly effective optional luxury automatic climate control system offers draught-free ventilation, fast reactions, ease of use and low noise levels. For the new C-Class, it comes with silver-coloured dials and surround



Luxury automatic climate control (optional). With luxury automatic climate control, everyone can determine their own individual temperature settings. It includes separate controls for the driver, front passenger and those in the rear, plus extra vents in the B-pillars and an additional rear blower. In addition, it now also lets you tailor the air flow style to your tastes, giving you a choice between 'diffuse', 'medium' and 'focused'.

Automatic climate control (standard). The standard climate control system automatically maintains your desired cabin temperature and air flow settings, and can compensate for bright sun, thanks to a wind-screen-mounted sensor that measures the intensity and angle of sunlight. It also includes separate air vents for rear seat passengers, as well as a chilled glove compartment, an air recirculation function, and a combined dust and activated charcoal filter that even captures particulates.

Rear seat controls (fitted with optional luxury automatic climate control). The luxury automatic climate control system includes separate rear seat controls. They enable rear seat passengers to choose their own individual temperature, blower and air flow settings at the touch of a button.



The standard automatic climate control system takes into account sensor data such as inside and outside temperature and humidity



A separate control unit enables those in the rear to set their own temperature settings and blower speed



Seats

The seats for the C-Class meet the very highest standards of comfort, ergonomics and safety.



Seats. Front and rear C-Class occupants enjoy exceptionally comfortable seats and generous levels of leg and shoulder room. The driver also benefits from partial electric adjustment plus mechanically adjustable lumbar support, with full electric adjustment for driver and front seat passenger available as an option. For all C-Class Saloon lines, an optional $\frac{1}{3}:\frac{2}{3}$ split folding rear seat can be fitted as an option (standard on Estate).

Comfort-ventilated front seats (optional). Of benefit in both hot and cold conditions, the optional comfort-ventilated front seats offer a choice of three heat settings plus active ventilation for pleasantly cool seat surfaces. The seats are designed to ensure the flow of hot or cool air is distributed as evenly as possible, and programmed to reduce the level of heat or ventilation automatically after a set period of time.

Memory Package (optional). With the optional Memory Package, the C-Class front seats feature full electric adjustment, with easy-to-reach controls in the front doors. The Package also includes a memory function that can store up to three sets of positions for the driver's seat, steering column and exterior mirrors, plus 4-way adjustment for the lumbar region.



With the optional comfort-ventilated front seats, the heat and ventilation levels can be set individually for each seat



The optional Memory Package allows up to three sets of positions to be stored for the driver's seat, steering column and exterior mirrors



C-Class Estate load compartment

The C-Class Estate's spacious cabin combines sporting luxury with exceptional load-carrying ability.



Folding the rear seat forward creates an almost completely flat load area and frees up 1,500 litres of luggage space



Luggage capacity. A length of 4.61 metres and a width of 1.77 metres enable the C-Class Estate to offer highly impressive levels of interior space. It can accommodate up to five in comfort, with ample knee room even for those in the rear, and swallow up to 1,500 litres of luggage. The sections of the 1/3:2/3 split rear seat can each be folded forward with just one hand, and the load area with both backrests down is almost completely flat. What's more, the C-Class Estate takes payloads of up to 540 kg in its stride and features a stainless steel load sill that helps to prevent scratches to the bodywork when loading and unloading.

Load compartment cover (standard). The load compartment cover keeps your cargo safe from prying eyes and shields it from bright sunlight. In addition, it features an integral safety net, which can be extended between either the B- or C-pillars depending on the cargo volume, helping to guard against injury from objects in the load compartment. Other useful load compartment features include retractable bag hooks in the sides of the load compartment, practical luggage nets for small items, four load-securing rings and a 12-volt socket.



The seat sections can be folded forward with one hand, allowing you to vary the load space quickly and easily



The load compartment cover protects your cargo against bright sunlight and prying eyes



Load compartment systems

To help you make the most of its generous load compartment, the C-Class Estate offers a range of systems that make for even easier and safer load-carrying.



The Easy-Pack load-securing kit's cargo rails and telescopic bar enable even bulky items to be kept safely in place



Easy-Pack load-securing kit (optional). The Easy-Pack load-securing kit comprises twin cargo rails, a telescopic bar and a retractable cargo belt. The bar can be fixed at any position along the floor-mounted cargo rails, thereby creating different cargo zones or ensuring bulky loads are kept firmly in place. The cargo belt, meanwhile, allows circular or awkwardly shaped items to be held against the side of the load compartment. The kit also includes four additional load-securing rings that, together with the four standard rings, make it even easier to ensure safe transportation of all kinds of cargo.

Self-levelling suspension (optional). The self-levelling rear suspension enables the car to maintain the same ride height whether unladen or carrying the maximum payload. This helps to increase safety and stability – especially when towing – and also ensures ride comfort remains equally consistent.

Easy-Pack powered tailgate (standard). The Easy-Pack tailgate can be opened remotely with the ignition key or via a button on the driver's door, and closed again by pressing a switch in the tailgate. It can also be stopped part way and preset to open only to the height of the car's roof, helping to avoid damage to the paintwork. It can, of course, also be opened and closed manually using the external tailgate release.



The Easy-Pack powered tailgate can be closed again at the touch of a button and even stopped part way



C 63 AMG exterior

The C 63 AMG's styling perfectly matches its exhilarating performance, with AMG front and rear aprons, AMG side skirts and special front wheel arch extensions hinting at the power of its 457 hp (336 kW) AMG V8. In addition, the exterior boasts AMG-specific LED daytime running lights, plus a gloss black finish for the front apron cross-bar, an AMG-specific bonnet with new power domes and a revised front grille with a single chrome bar. → www.mercedes-amg.com

EXTERIOR

18" AMG multi-spoke alloy wheels in burnished Titanium Grey, with 235/40 tyres at the front and 255/35 at the rear

AMG bodystyling, comprising front apron with side air vents, side skirts and diffusor-style rear apron

AMG boot lid spoiler (Saloon)

AMG high-performance braking system with 360 × 36 mm front brake discs and 330 × 26 mm discs at the rear

AMG-specific bonnet with new power domes

AMG-specific front apron with gloss black cross-bar

AMG-specific front grille with single chrome bar

AMG-specific LED daytime running lights

AMG sports exhaust system with two sets of twin chromed tailpipes

Front wheel arch extensions with '6.3 AMG' badges

LED tail lights



Optional 19" AMG alloys and AMG Performance Package Plus shown





Optional 19" AMG alloy wheels shown



C 63 AMG interior

As performance-orientated inside as out, the C 63 AMG boasts an exclusive and distinctive cabin featuring highly supportive AMG sports seats with *designo* Black leather upholstery (single or two-tone leather is available as an option). There's also an AMG instrument panel with colour display and AMG start-up screen, plus a flat-rimmed three-spoke AMG Performance steering wheel with aluminium gear shift paddles and nappa leather trim that's perforated in the central grip area. Completing the highly dynamic look are AMG sports pedals, brushed dark aluminium trim, a black roof lining and brushed stainless steel AMG sill strips for the doors.

INTERIOR

AMG door sill strips in brushed stainless steel

AMG instrument panel with high-resolution 4.5-inch colour display, including Racetimer and AMG start-up screen

AMG sports parameter steering

AMG sports seats

Attention Assist

Brushed stainless steel sports pedals with rubber studs

Dark brushed aluminium interior trim

Flat-rimmed AMG Performance steering wheel with nappa leather trim and aluminium gear shift paddles

New rotary switch for transmission modes and Race Start function





C 63 AMG technology

The AMG 6.3-litre V8 delivers exceptional power, the sports transmission and suspension help you exploit it to the full – and let you switch between performance- and comfort-biased set-ups.

AMG 6.3-litre V8. Under the bonnet of the C 63 AMG is a naturally aspirated V8 equipped with track-honed racing technologies. These include variable camshaft timing, four valves per cylinder, an exceptionally rigid aluminium crankcase and a special low-friction coating for the cylinder contact surfaces. For optimum cylinder charging, this high-tech engine also features vertically arranged intake and exhaust ports plus a magnesium variable intake manifold with twin throttle flaps.

The result is free-revving performance, exceptional pulling power and instant acceleration at all speeds. The C 63 AMG delivers 457 hp (336 kW) at 6,800 rpm, plus up to 600 Nm of torque at 5,000 rpm, with in excess of 500 Nm available all the way from 2,000 to 6,250 rpm. The AMG Performance Package Plus creates an even more powerful C 63 AMG: it increases output to 487 hp (358 kW), enabling it to dispatch the 0 to 62 mph sprint in a breathtaking 4.3 seconds (4.4 seconds for Estate).

AMG sports suspension. The revised AMG sports suspension delivers enhanced agility and even greater lateral acceleration potential while also increasing ride comfort. Together with the low-profile tyres, wide front track, AMG sports parameter steering and three-stage ESP®, it ensures exceptional vehicle dynamics and an exhilarating driving experience. The triple-link front suspension, firm springing and gas pressure dampers guarantee optimum roadholding and excellent body control, yet the ride remains as comfortable as you'd expect from a Mercedes, even on longer journeys. The Electronic Stability Programme (ESP®) is tailored to the C 63 AMG's high-performance needs. It lets you determine the level of ESP® support yourself, allowing you to switch between 'on', 'off' and 'sport handling mode', and displays the current setting in the instrument panel.

As an option, the C 63 AMG can be fitted with AMG Performance suspension. Its tauter spring and damper settings make for even faster handling responses and a truly focused feel.



AMG Speedshift MCT 7-speed sports transmission.

Equipped with AMG aluminium steering wheel shift paddles, four driving modes and a Race Start function, the C 63 AMG's 7-speed sports transmission further enhances performance yet uses up to 10% less fuel than its predecessor. Its Race Start function enables the driver to exploit the engine's acceleration potential to the full, while benefitting from optimum traction at the driven wheels. The 'S' (Sport), 'S+' (Sport Plus), 'C' (Comfort) and 'M' (Manual) modes each offer different shift characteristics and speeds: gear changes in Sport and Sport Plus modes are around 20% and 40% faster respectively than in Comfort mode, while Manual mode is approximately 50% faster, with shift times of just 100 ms. The transmission also offers automatic throttle-blipping on downshifts. This not only produces a satisfyingly sporty sound, but also helps to reduce load transfer, especially when braking into bends.



The AMG Speedshift MCT 7-speed sports transmission offers a choice of modes that let you enhance comfort or maximise driving pleasure



Track-honed technology helps the AMG 6.3-litre V8 to deliver exhilarating performance



AMG Performance Studio

For an even sportier C 63 AMG, simply add options from the AMG Performance Studio. They include the AMG Performance Package Plus, which comprises an engine upgrade that increases output to 487 hp (358 kW), a Titanium Grey variable intake manifold, an AMG high-performance braking system with composite front brake discs, red brake calipers, an AMG carbon-fibre boot lid spoiler (Saloon) and an AMG Performance steering wheel with nappa leather and Dynamica microfibre trim.

Other AMG Performance Studio options include the AMG Performance suspension, the AMG Exterior Carbon-fibre Trim Package, AMG Interior Carbon-fibre Trim Package, illuminated AMG door sill strips, a locking rear differential and the AMG Driver's Package, which raises the electronically limited top speed and includes participation at an AMG 'Power & Passion' driving event. There's also a range of optional AMG alloy wheel styles: choose between Titanium Grey or Matt Black multi-spoke wheels and 5-spoke wheels in Titanium Grey.





C-Class SE

The C-Class SE comes equipped with a wide range of comfort- and safety-enhancing equipment. In addition, it features attractive exterior details such as LED tail lights and a chrome radiator grille, plus a highly harmonious interior.



EXTERIOR

16" 7-spoke alloy wheels

LED tail lights

Parktronic with Advanced Parking Guidance

Rain-sensing wipers

INTERIOR

Audio 20 radio with single CD drive

Attention Assist

Cruise control

High-Gloss Black trim

Multi-function colour display with trip computer

Nappa leather multi-function steering wheel (12-button) and shift lever

Prewiring for Becker® Map Pilot

USB and aux-in ports



Split folding rear seat shown (optional on Saloon, standard on Estate)







The SE interior features Brighton cloth upholstery as standard, with Artico artificial leather available as an option. It offers a choice of four upholstery colours (two with Artico) for the seats and door centre panels and boasts High-Gloss Black trim, with the remaining cabin surfaces finished in matching black.

BLACK

- 021 Brighton cloth
 - 121 Artico artificial leather (optional)
-

ALPACA GREY

- 028 Brighton cloth
 - 128 Artico artificial leather (optional)
-

BLACK/BLUE

- 062 Brighton cloth
-

BLACK/BEIGE

- 065 Brighton cloth
-

TRIM

- H80 High-Gloss Black
 - 734 Eucalyptus wood (optional)
-



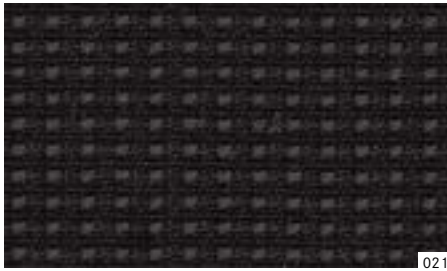

021

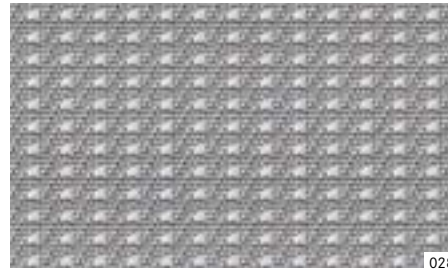

028

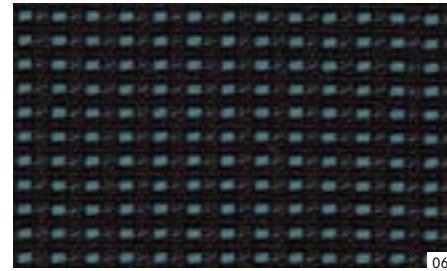

062



065



121



128



H80



H80



H80



H80



734



734



734



734



C-Class Elegance

The Elegance line puts the emphasis on refined style. Its exterior features eye-catching chrome and aluminium detailing; the harmonious interior boasts fine wood trim and subtle tone-on-tone colour schemes.



EXTERIOR

17" 7-twin-spoke alloy wheels

Chrome trim strips along sides and in rear bumper

Front fog lamps and daytime running lights with chrome surround

Shoulder line trim in polished aluminium

INTERIOR

Artico artificial leather upholstery

Attention Assist

Brown Ash wood, matt finish

Double front cup holder, glasses storage and nets in rear of front seats

Leather piping on upholstery

Multi-function colour display with trip computer

Nappa leather steering wheel and shift lever with chrome inserts

Neck-Pro comfort front head restraints

Storage Package – underseat storage and cupholder







Optional Dark Burr Walnut wood trim shown

The Elegance interior features Artico artificial leather upholstery as standard, with real leather available as an option. The upholstery comes in either Black, Almond Beige or Alpaca Grey and is complemented by finely grained matt Brown Ash wood trim. The dashboard, door centre panels and carpets are all carefully coordinated with your chosen upholstery colour.

BLACK

- 121 Artico artificial leather
 - 221 Leather (optional)
-

ALMOND BEIGE

- 125 Artico artificial leather
 - 225 Leather (optional)
-

ALPACA GREY

- 128 Artico artificial leather
 - 228 Leather (optional)
-

TRIM

- H06 Brown Ash wood, matt finish
 - 731 Dark Burr Walnut wood, gloss finish (optional)
-



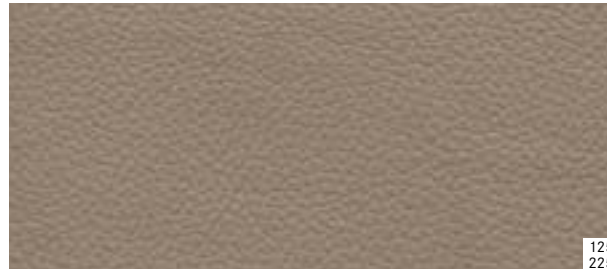

C-Class Sport

The Sport line makes for an even more dynamic C-Class. In addition to a distinctive front grille with integral three-pointed star, its exterior features AMG front and rear aprons and AMG side skirts, plus AMG 18" 7-spoke alloy wheels. To ensure the drive lives up to the looks, there's also 15 mm-lower sports suspension and sports parameter steering as standard.

EXTERIOR

18" AMG 7-spoke alloy wheels, burnished finish

AMG bodystyling, comprising front and rear aprons and side skirts

Bright silver radiator grille with chrome inserts and integral three-pointed star

Cross-drilled front brake discs, and brake calipers with 'Mercedes-Benz' lettering

Intelligent Light System with bi-xenon headlamps, Adaptive High Beam Assist and LED daytime running lights

Lowered sports suspension

Sports parameter steering

INTERIOR

Attention Assist

Black roof lining

Brushed stainless steel sports pedals with rubber studs

Cloth/Artico artificial leather upholstery in Black or Alpaca Grey

Flat-bottomed 3-spoke multi-function sports steering wheel with nappa leather trim

Front sports seats

Steering wheel shift paddles and manual mode (automatic models)



Rear bench seat shown in optional Black leather







The AMG influence is equally unmistakable inside the C-Class Sport, thanks to front sports seats, a flat-bottomed 3-spoke multi-function sports steering wheel with nappa leather trim, and instruments that echo those of the C 63 AMG. Other standard Sport line features include brushed stainless steel sports pedals, black floor mats with AMG insignia, a black roof lining and an aluminium-look shift lever with leather sleeve. Automatic models also come with steering wheel shift paddles for racing-style manual gear changes.

BLACK

- 721 Artico artificial leather/Liverpool cloth
- 221 Leather (optional)

ALPACA GREY

- 728 Artico artificial leather/Liverpool cloth
- 228 Leather (optional)

CAPPUCCINO

- 224 Leather (optional)

SAHARA BEIGE

- 235 Leather (optional)

TRIM

- 739 Brushed aluminium
 - 736 Black Ash wood, gloss finish (optional)
-





721

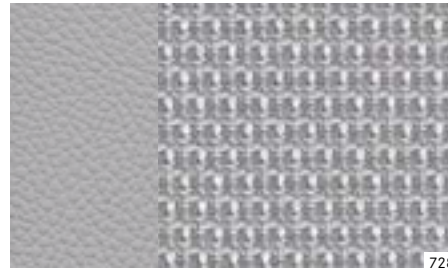

728

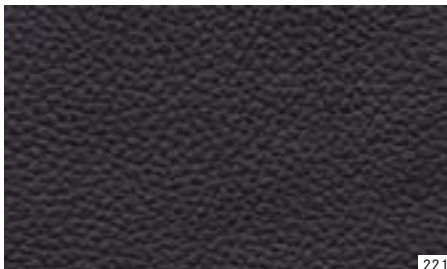

221

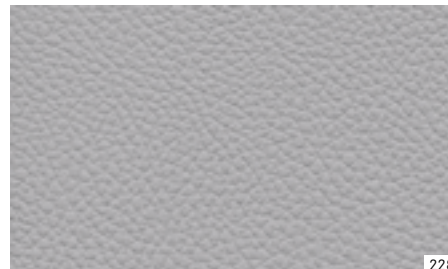

228

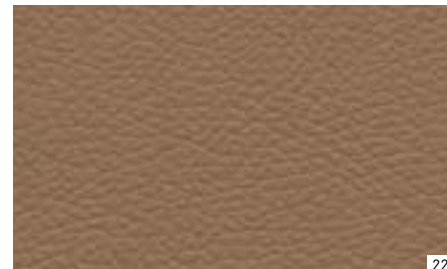

224



235



739

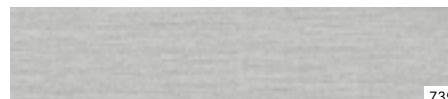

739



739



739



736



736



736



736



Standard equipment | Selection



Audio 20 radio/single CD



Automatic climate control



Nappa leather-trimmed steering wheel (SE and Elegance)



Black roof rails (Estate SE only)





Door sill panels



Split folding rear seat (Estate only), shown with optional Harman Kardon® Logic 7® surround sound system



LED tail lights



Attention Assist



Optional extras | Selection



Electric glass sunroof



Panoramic glass sunroof



Telephone pre-wiring for hands-free facility and external aerial



Becker® Map Pilot





Easy-Pack powered tailgate (Estate only)



COMAND Online navigation system



Tow bar - manually folding



Alloy wheels



16" 7-spoke alloy wheels (standard on SE, codes R20 and R75)



17" 7-twin-spoke alloy wheels (standard on Elegance, code 26R; also available as 16" option, code R27)



17" 5-twin-spoke alloy wheels (optional on SE, code R52)



18" 5-twin-spoke alloy wheels (optional on Elegance, code R70)



17" AMG 5-twin-spoke alloy wheels, burnished finish (optional on Sport, code 784)



18" AMG 7-spoke alloy wheels (standard on Sport, code 782)



18" AMG 5-twin-spoke alloy wheels, burnished finish (optional on Sport, code 786)



18" AMG 5-twin-spoke alloy wheels, burnished Titanium Grey finish (standard on C 63 AMG, code 795)





18" AMG 5-spoke alloy wheels, burnished Titanium Grey finish (optional on C 63 AMG, code 790)



19" AMG multi-spoke alloy wheels, painted black (optional on C 63 AMG, code 797)¹



19" AMG multi-spoke alloy wheels, burnished Titanium Grey finish (optional on C 63 AMG, code 788)

¹Shown with optional AMG brake calipers painted in red (part of the AMG Performance Package Plus)



Retailer-fit accessories

A Mercedes-Benz is not just a car, it's a travel companion that can be tailored to your needs – with our wide range of Retailer-fit accessories.

→ www.mercedes-benz.co.uk/accessories

Our Retailer-fit incenio alloy wheels let you tailor the exterior of your C-Class to your tastes. They come in a variety of styles ranging from the elegant to the overtly sporty and include the 17" incenio 'Proserpina' 5-spoke wheels pictured below.

A further highlight among C-Class accessories is our innovative rear seat iPad® integration system. It enables those in the back to view and listen to any media files stored on the tablet and, if the InCar Hotspot is also fitted, to go online even if the device isn't 3G enabled.



17" incenio 'Proserpina' 5-spoke alloy wheels in Sterling Silver. Other wheel styles also available

For optimum child safety, there's the KidFix seat. Suitable for children between the ages of approx. 3.5 and 12 (15 to 36 kg), it features a booster cushion and a height-adjustable backrest that help it to maximise side impact protection.

The accessories range also offers a choice of two roof boxes plus a ski and snowboard rack and a bike rack, all of which can be mounted quickly and easily on specially designed roof bars, helping you to transport awkward cargo safely and securely. The roof boxes hold



The KidFix child seat offers maximum safety for younger passengers

approx. 330 and 450 litres respectively and can be opened on either side.

For more details about these and other C-Class accessories, please see the relevant brochure or talk to your local Mercedes-Benz Retailer.



From snowboards to diving equipment, the Mercedes-Benz roof box is the elegant way to transport all manner of sports gear





With the rear seat iPad® integration system, those in the back can watch films, listen to music or surf the internet



Following the star

Test drive. A Mercedes-Benz is most at home on the road. This is the only way to experience the effortlessly superior driving feel that lends every Mercedes model its inimitable class. Feel the power of efficient engines with low fuel consumption, and precise steering designed to put you in the mood for driving. And experience what true comfort really feels like. The unique feeling of driving a Mercedes cannot be put into words, however. Which is precisely why we'd like to invite you to take a test drive. Your Mercedes-Benz Retailer will be happy to make all the necessary arrangements for you. Simply visit www.mercedes-benz.co.uk/testdrive to request a test drive. We look forward to seeing you.

Mercedes-Benz Finance. At Mercedes-Benz Finance, our single-minded aim is to provide optimum financial solutions for all those who share the Mercedes-Benz philosophy of absolute commitment to quality. Whether you are a private customer or a business user, our finance and leasing packages can be tailored to meet your individual needs. For further information on Mercedes-Benz Finance, please contact your local Mercedes-Benz Retailer.

Mercedes-Benz Insurance offers a fully comprehensive 5 star¹ Motor Insurance policy specifically designed to give you the cover you would expect from Mercedes-Benz. For a quotation, please call 0845 600 2180.²

Factory Collection. What can possibly heighten the experience of taking possession of your brand new Mercedes-Benz? The highlight might just be to see and experience where it was built in either Stuttgart, Rastatt or Bremen, and to take the long way home by driving it through some of Europe's most beautiful countryside. The Mercedes-Benz Factory Collection offers just that. Included in the Collection is an airport transfer to your hotel, one night's accommodation for one person with dinner and breakfast, a tour of the Mercedes-Benz factory, five days fully comprehensive insurance, and a return crossing by Eurotunnel (Standard Class). All you will need to pay for is your

one-way flight to Germany. For more information, please contact your local Retailer, the Mercedes-Benz Factory Collection team on 0845 273 9705 or visit www.mercedes-benz.co.uk/factorycollection

Interactive Owner's Manuals. The website also offers an interactive tour, enabling you to take a closer look at your desired model. This simulation is the ideal way to acquaint yourself with your dream car. You can view key functions in detail, gain an insight into the car's inner workings or look at the benefits of each model. For further details, visit www.mercedes-benz.co.uk/cclasssaloonmanual www.mercedes-benz.co.uk/cclassstatemanual



Roadside Assistance. Rest assured that should you ever need help, Mercedes-Benz Roadside Assistance is there for you. In the unlikely event of a technical breakdown³ you can rely on the Mercedes-Benz Roadside Assistance Team – anywhere in Europe. Simply phone our Customer Assistance Centre on 00800 1 777 7777,⁴ where our specialists will organise assistance for you. Mercedes-Benz will also assist you in the event of a minor mishap preventing you from driving your vehicle.⁵ Whether you lose your key, run out of fuel or your vehicle is damaged due to an accident or vandalism, Mercedes-Benz ensures that you still reach your destination. Often the problem can be rectified on the spot, but if this is not possible, we will naturally ensure that your vehicle is taken to the nearest Mercedes-Benz Official Workshop to get you back on the road as quickly as possible.

Mercedes-Benz World at Brooklands. Celebrate the story of Mercedes-Benz and you'll celebrate the story of motoring itself at Mercedes-Benz World in Surrey. A World of experiences. A World of discoveries. A World you will love to explore. Discover Mercedes-Benz racing heritage, from its connections to the famous Brooklands circuit through to present-day Formula 1™ brought to life in the most sensational way. View, touch and sit in every car from the Mercedes-Benz range, and encounter automotive legends like the 'Gullwing' and many other classic icons, in the UK's largest Mercedes-Benz showcase. Then set your pulse racing by booking one of our thrilling Driving Experiences. Enjoy AMG performance on the purpose-built Handling Circuits or Wet Skid Circle, an axle-twisting off-road adventure, or treat your kids over 1.5 metres tall to their own driving experience in an A-Class or on the off-road terrain in an M-Class. And for kids even younger and under 1.3 metres tall, let them be a 'Little Learner' in their own miniature electric version of the desirable Mercedes-Benz SL. For more

interactive action, take a virtual 3D journey along the production line in 'Build' and take a seat in the cinema to accelerate from the birth of the car to the latest innovations in 20 eye-opening minutes.

Relax and refuel in Café 1886, or for something more enjoy the delicious menu and elegant surroundings of the Gullwing Restaurant. Finally, extend your visit with a short stroll to Brooklands Museum to see their collection of classic cars, aviation exhibitions – and the legendary Concorde. For more information visit www.mercedes-benzworld.co.uk

¹ As rated by Defaqto, a leading UK independent financial research company. Mercedes-Benz Motor Insurance is underwritten by Aviva Insurance Limited

² Calls are charged at local rate and may be recorded

³ Technical breakdown cover is initially valid for your vehicle for four years from the date of first registration. This can be extended from the fifth year, up to a maximum of 30 years, on completion of each scheduled maintenance service, providing that this service is carried out by a Mercedes-Benz Official Workshop

⁴ In non-affiliated European countries: +44 20 7975 7077

⁵ This cover can be retained from the fifth year. Your Mercedes-Benz Official Workshop will provide details of how to renew this cover once your initial four year term has expired



Saloon dimensions

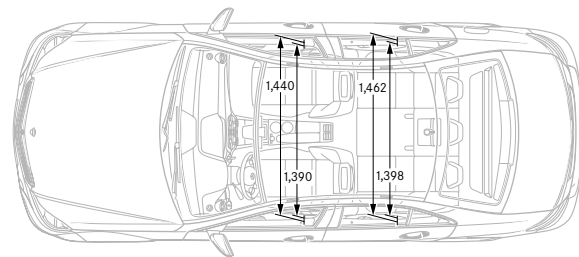
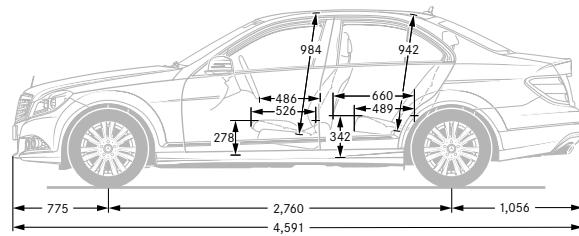
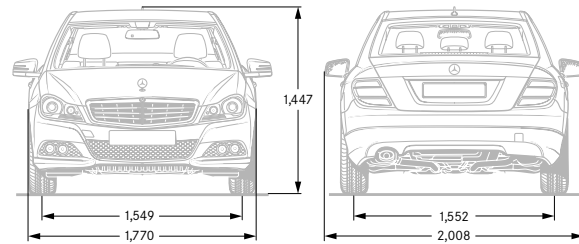

Estate dimensions

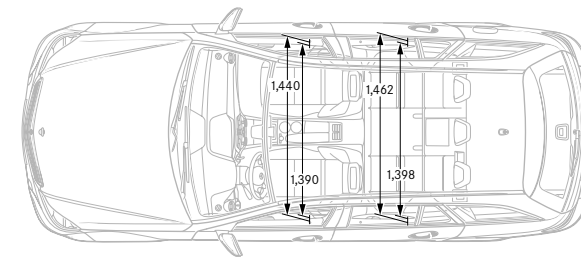
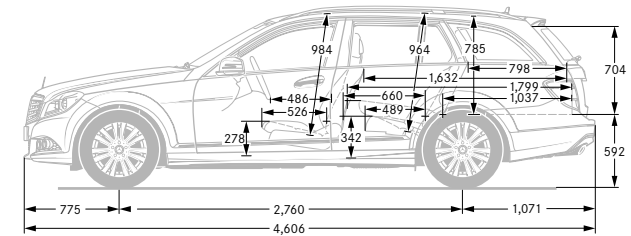
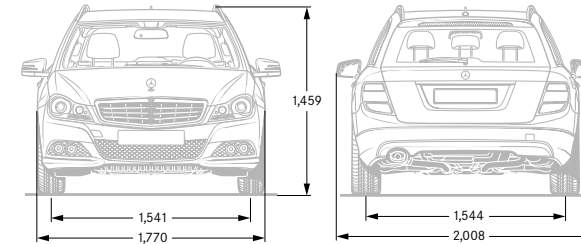

All measurements in millimetres. The dimensions shown are mean values and apply to standard-specification, unladen vehicles



Technical data | Saloon

DIESEL ENGINES	C 200 CDI BlueEFFICIENCY	C 220 CDI BlueEFFICIENCY	C 250 CDI BlueEFFICIENCY	C 350 CDI BlueEFFICIENCY
Capacity – cc	2,143	2,143	2,143	2,987
Power ¹ – hp (kW) at rpm	136 (100)/2,800–4,600	170 (125)/3,000–4,200	204 (150)/4,200	265 (195)/3,800
Acceleration 0–62 mph – sec (auto.)	9.2 (9.1)	8.4 (8.1)	7.0 (7.1)	– (6.0)
Top speed – mph (auto.)	135 (134)	144 (143)	149 (149)	– (155) ²
Fuel consumption ³ – mpg (auto.)				
Urban	47.9 (46.3)	50.4 (47.1)	46.3 (47.1)	– (39.2)
Extra-urban	68.9 (65.7)	76.3 (68.9)	70.6 (68.9)	– (54.3)
Combined	58.9 (57.6)	64.2 (58.9)	58.9 (58.9)	– (47.9)
CO ₂ emissions, combined ³ – g/km (auto.)	125–139 (129–140)	117–133 (125–136)	131–140 (131–136)	– (154–157)
Emissions standard	Euro 5	Euro 5	Euro 5	Euro 5

PETROL ENGINES	C 180 BlueEFFICIENCY	C 250 BlueEFFICIENCY	C 350 BlueEFFICIENCY	C 63 AMG
Capacity – cc	1,796	1,796	3,498	6,208
Power ¹ – hp (kW) at rpm	156 (115)/5,000	204 (150)/5,500	306 (225)/6,500	457 (336)/6,800
Acceleration 0–62 mph – sec (auto.)	9.0 (8.9)	– (7.2)	– (6.0)	– (4.5)
Top speed – mph (auto.)	140 (139)	– (149)	– (155) ²	– (155) ²
Fuel consumption ³ – mpg (auto.)				
Urban	30.4 (32.5)	– (31.7)	– (29.4)	– (15.6)
Extra-urban	54.3 (56.5)	– (52.3)	– (50.4)	– (33.2)
Combined	42.2 (44.1)	– (42.2)	– (40.4)	– (23.5)
CO ₂ emissions, combined ³ – g/km (auto.)	157–169 (148–160)	– (156–161)	– (164)	– (280)
Emissions standard	Euro 5	Euro 5	Euro 5	Euro 5

¹Figures according to Directive 80/1269/EEC in the currently applicable version ²Electronically limited ³The figures shown were obtained in accordance with the prescribed measuring process (Directive 80/1268/EEC in the currently applicable version). The figures are not based on an individual vehicle and do not constitute part of the product offer; they are provided solely for purposes of comparison between different vehicle models and are subject to change. Please check with your local Retailer for the latest figures

Technical data | Estate

DIESEL ENGINES	C 200 CDI BlueEFFICIENCY	C 220 CDI BlueEFFICIENCY	C 250 CDI BlueEFFICIENCY	C 350 CDI BlueEFFICIENCY
Capacity – cc	2,143	2,143	2,143	2,987
Power ¹ – hp (kW) at rpm	136 (100)/2,800–4,600	170 (125)/3,000–4,200	204 (150)/4,200	265 (195)/3,800
Acceleration 0–62 mph – sec (auto.)	9.6 (9.5)	8.5 (8.3)	7.3 (7.4)	– (6.3)
Top speed – mph (auto.)	130 (129)	136 (136)	148 (147)	– (155) ²
Fuel consumption ³ – mpg (auto.)				
Urban	47.1 (45.6)	47.1 (44.8)	44.1 (44.1)	– (38.7)
Extra-urban	68.9 (62.8)	70.6 (65.7)	65.7 (62.8)	– (52.3)
Combined	58.9 (55.4)	60.1 (55.4)	55.4 (54.3)	– (47.1)
CO ₂ emissions, combined ³ – g/km (auto.)	127–141 (134–144)	124–135 (134–138)	132–141 (136–138)	– (159–162)
Emissions standard	Euro 5	Euro 5	Euro 5	Euro 5

PETROL ENGINES	C 180 BlueEFFICIENCY	C 250 BlueEFFICIENCY	C 350 BlueEFFICIENCY	C 63 AMG
Capacity – cc	1,796	1,796	3,498	6,208
Power ¹ – hp (kW) at rpm	156 (115)/5,000	204 (150)/5,500	306 (225)/6,500	457 (336)/6,800
Acceleration 0–62 mph – sec (auto.)	9.2 (9.1)	– (7.4)	– (6.1)	– (4.6)
Top speed – mph (auto.)	135 (134)	– (145)	– (155) ²	– (155) ²
Fuel consumption ³ – mpg (auto.)				
Urban	30.4 (32.5)	– (31.4)	– (28.5)	– (15.2)
Extra-urban	52.3 (52.3)	– (50.4)	– (48.7)	– (32.5)
Combined	41.5 (42.8)	– (41.5)	– (38.7)	– (23.0)
CO ₂ emissions, combined ³ – g/km (auto.)	160–176 (155–163)	– (159–162)	– (170)	– (288)
Emissions standard	Euro 5	Euro 5	Euro 5	Euro 5

¹Figures according to Directive 80/1269/EEC in the currently applicable version ²Electronically limited ³The figures shown were obtained in accordance with the prescribed measuring process (Directive 80/1268/EEC in the currently applicable version). The figures are not based on an individual vehicle and do not constitute part of the product offer; they are provided solely for purposes of comparison between different vehicle models and are subject to change. Please check with your local Retailer for the latest figures

Paint finishes

The innovative Mercedes-Benz paint system features one of the finest clearcoats of any manufacturer. Its exceptionally dense molecular structure makes the paintwork more durable and lends it a deeper, more lasting sheen, helping your C-Class to retain both its looks and its long-term value.

NON-METALLIC PAINTS (standard)

- 040 Black
- 590 Fire Opal
- 650 Calcite White

METALLIC PAINTS (optional)

- 183 Magnetite Black
- 197 Obsidian Black
- 497 Cuprite Brown
- 775 Iridium Silver
- 779 Alabandine Grey
- 792 Palladium Silver
- 794 Pearl Beige
- 890 Cavansite Blue

SPECIAL METALLIC PAINT (optional)

- 799 Diamond White
-

NON-METALLIC PAINTS



040



590



650

SPECIAL PAINT



799

METALLIC PAINTS



183



197



497



775



779



792



794



890



Take-back of end-of-life vehicles. Coming full circle. At the end of its long life, you can return your C-Class to us for environment-friendly disposal in accordance with the EC End-of-Life Vehicle Directive!¹ But that day lies a long way off.

¹Applies in accordance with national regulations to vehicles up to 3.5 t permissible gross weight. The C-Class has met the statutory regulations governing the suitability of the vehicles' design for reuse and recycling for a number of years now. A network of vehicle take-back depots and dismantlers has been established which will process your vehicle in an environment-friendly manner. The ways in which both vehicles and parts can be recovered are subject to ongoing development and improvement. Consequently, the C-Class will be able to comply with any future increases in the recycling quota within the stipulated time limits. Further information is available at www.mercedes-benz.co.uk or call 0808 156 6606.

Please note: this online version of the printed brochure may contain abridged copy or other content changes. The manufacturer reserves the right to make changes to the design, form, colour and specification during the delivery period, provided these changes, while taking into account the interests of the vendor, can be deemed reasonable with respect to the purchaser. Where the vendor or the manufacturer uses symbols or numbers to describe an order or the subject of an order, no rights may be derived solely from these. The illustrations may show accessories and items of optional equipment which are not part of standard specification. Colours may differ slightly from those shown. This brochure provides a general indication of the range of models, features, optional extras and/or colours available in various countries. Some of the models, features, optional extras and/or colours shown may not be available in your country or may only be available in a different specification. Additionally, some models, features, optional extras and/or colours may only be available in combination with others. For current and more specific information in relation to the range of models, features, optional extras and/or colours available in your country, and their pricing, you should contact your nearest authorised Mercedes-Benz Retailer. E&OE. www.mercedes-benz.co.uk

