

CL-Class

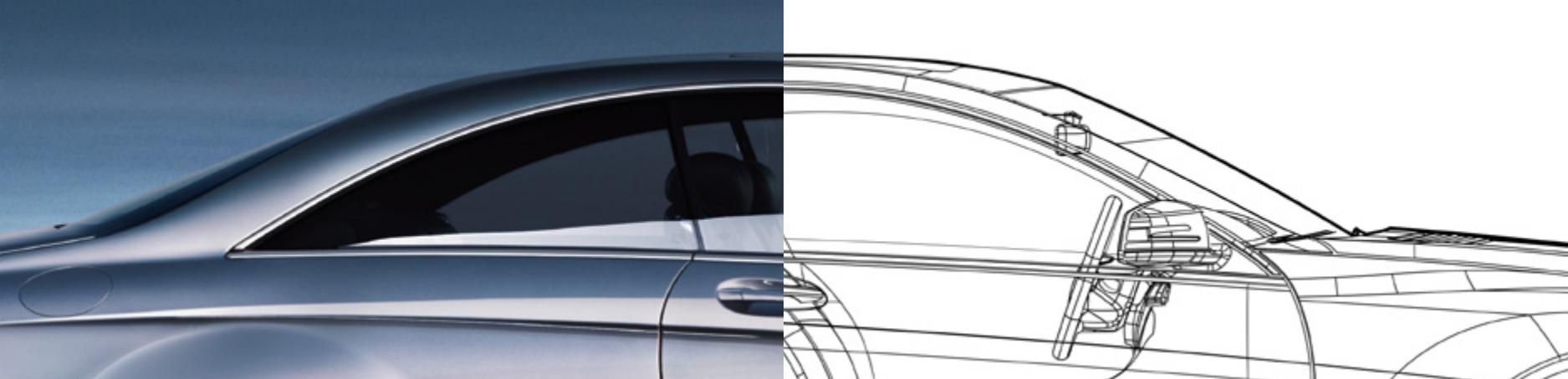

Mercedes-Benz





First impressions

The CL is not only a byword for elegance and luxury, it's also a technical tour de force. The V8 engines with BlueDIRECT injection, for instance, set a benchmark for efficient performance, while the many sensors and intelligent electronic systems ensure the CL is safer and more effortless than ever. What's more, the CL is a car of breathtaking beauty, a car whose lines stir the soul of even the most discerning souls. And whose every detail is designed and engineered to perfection. It's the state of the art in excellence.

Overview | from page 4 Insights | from page 16

See Mercedes-Benz in a new light. With a wide selection of new finance and upgrade offers available across our model range, now is a great time to get yourself behind the wheel of a Mercedes-Benz. For further information contact your local Mercedes-Benz Retailer or visit www.mercedes-benz.co.uk/offers

CL-Class



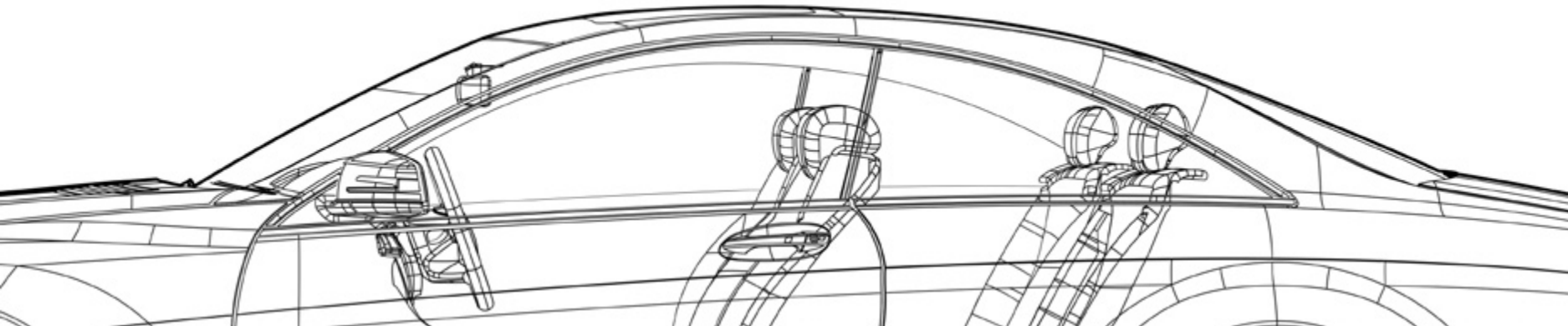

Facts

Efficiency and enjoyment: engines, transmissions and suspension.

Engines and suspension | from page 20

Optimum protection: innovations and proven technologies that help to avoid accidents and aid rescue.

Safety | from page 25

Relaxation for the road: multimedia and climate control systems, electronic assistants and dynamic multi-contour seats.

Comfort | from page 29

Three breathtaking coupés: CL 500 BlueEFFICIENCY, CL 63 AMG and CL 65 AMG.

Model variants | from page 35

Your personal CL: standard equipment and optional extras, *designo*, upholstery and trim, alloy wheels and Retailer-fit accessories.

Equipment | from page 43

More Mercedes-Benz: Mercedes-Benz World and Museum, Roadside Assistance, Mercedes-Benz Finance and Insurance, test drive and Interactive Owner's Manual.

Services | from page 55

The CL in figures: dimensions, paint finishes and technical data.

Facts and finishes | from page 57





The synthesis of vision and perfectionism:

Over the years, we've built a succession of truly special coupés. The CL is the latest in that illustrious line. It reflects the boldest and brightest ideas of our designers and engineers – and takes automotive evolution to the next level. It could just be the coupé of your dreams.

greatness



The only way to travel
for those who've already arrived:

Created for drivers who appreciate elegance, recognise
ability and always expect the best, the CL combines fine
craftsmanship and design with cutting-edge technology.
The result is a truly unforgettable luxury coupé – a car
built to standards that match your own.

in style



A composure nothing can disturb:

Sharp bends, rough surfaces, gusting winds: the CL simply takes everything in its stride. Thanks to Active Body Control (ABC) with crosswind stabilisation, it maintains maximum stability whatever the road, load or conditions, ensuring occupants enjoy a beautifully smooth ride at all times.

serenity







The ability to combine
boldness with respect:

Only the truly committed have what it takes to stay at the top. The CL, for instance, never wavers in its pursuit of improvements - be they in comfort, safety, or efficiency. It's a dedication that has helped to reduce CO₂ emissions by up to 21% (CL 500 BlueEFFICIENCY).

Proof that luxury doesn't have to be characterised by excess.

leadership





The motivation for
countless innovations:

While you're revelling in the here and now, the CL is already considering what might happen next – thanks to electronic safety aids that constantly think a few seconds ahead. What's more, the optional Driving Assistance Package now includes Active Lane-Keeping Assist and Active Blind Spot Assist that work in conjunction with ESP®, meaning they're not only able to help warn the driver of potentially dangerous situations, but also to intervene themselves if required.

your safety

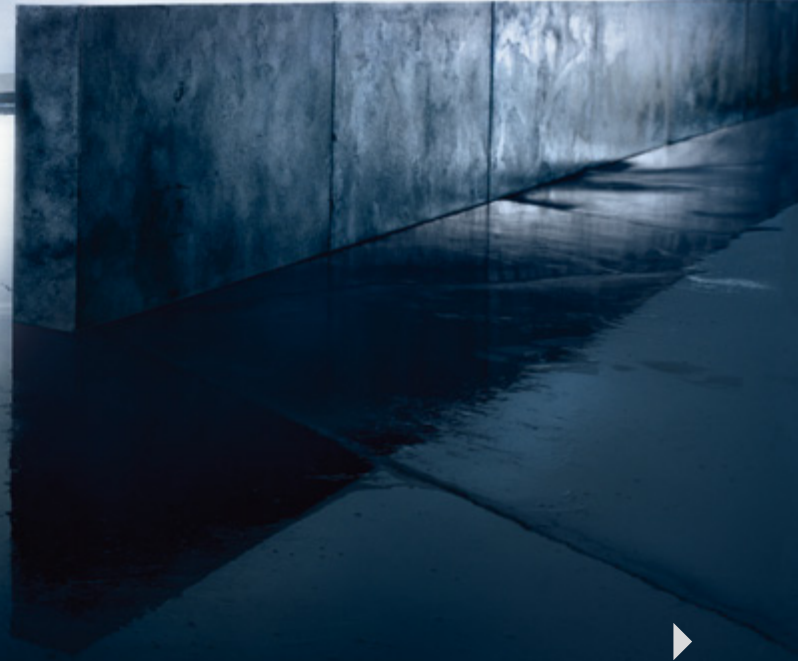



The only word that
does it justice:

Elegant, athletic and beautifully proportioned, the new CL looks almost too good to be true. From the long, sweeping bonnet and striking two-bar grille to the broader, more muscular rear, it's a shape that effortlessly cleaves the air and instantly captures the heart.

masterpiece





Power you can sense
even at a standstill:

The striking lines promise passion and power, the driving experience never fails to deliver. Exhilarating performance, effortless poise: the CL takes your breath away – long before you set off.

athleticism



Knowing someone is
looking out for you:

Thanks to its many vigilant electronic systems, the CL can help you avoid danger before it even arises. Attention Assist, for instance, monitors your reactions at the wheel and warns you gently but firmly if the sensors detect signs of fatigue. Just one of the ways in which the CL makes for a highly reassuring travel companion.

peace of mind





The manual revolution

With 27 bones, 33 muscles, three nerves, 17,000 neural receptors and an unrivalled sensitivity, the human hand is the finest tool we have – and the only one worthy of putting together a CL.

That's why 90% of the assembly operations for each CL are performed manually, with just two robot arms used in its production. All other tasks are entrusted to a select group of mechanics, whose skilled hands and trained eyes ensure that each component and every piece of interior trim is in exactly the right place. And that each CL is built with the one ingredient no machine can ever supply: the pride in helping to create a masterpiece.



One of our earliest driving aids

In their early days, motor cars were often seen as cantankerous beasts full of mysterious technology. Steering them was physically demanding and keeping them running required specialist knowledge that few possessed. Consequently, the Daimler motor company often had its vehicles delivered by genuine experts who not only handed the cars over to their new owners, but also showed the wealthy gentlemen how to operate their new technological marvel. In addition, they often fulfilled the functions of mechanic, chauffeur and travel companion too – sometimes for weeks or even months after that initial delivery.

One such automotive expert was Rudolf Schwarz. Herr Schwarz, an esteemed Daimler employee held in high regard by Gottlieb Daimler himself, was born in Ludwigsburg in 1878, making him perhaps one of the earliest driving aids. Nowadays, of course, such assistants come in the form of intelligent electronic systems, more than a dozen of which are fitted to the CL. Together, they can help to increase safety and comfort, and ensure CL driving, unlike those early car journeys, is always a truly effortless experience.



20	BlueEFFICIENCY	25	Safer driving Attention Assist Adaptive High Beam Assist Night View Assist Plus Driving Assistance Package Torque Vectoring Brake	29	Multimedia systems COMAND SplitView Harman Kardon® Logic 7® surround sound system	35	CL 500 BlueEFFICIENCY
21	Efficiency in the CL-Class						
22	Engines BlueDIRECT V8 petrol engine						
23	Transmissions 7G-Tronic 5-speed automatic transmission	27	Occupant protection Pre-Safe® system Pre-Safe® Brake Airbags	31	Electronic assistants Reversing camera Advanced Parking Guidance Speed Limit Assist		
24	Suspension Active Body Control (ABC) with crosswind stabilisation			33	Automatic climate control		
				34	Seats Dynamic multi-contour front seats Air-conditioned front seats		

CL-Class in detail



37	CL 63 AMG	43	Standard equipment	55	Services	57	Dimensions
39	CL 63 AMG – technology AMG 5.5-litre V8 AMG Speedshift MCT 7-speed automatic transmission	44	Optional extras		Mercedes-Benz World and Museum Roadside Assistance	58	Technical data
		45	<i>designo</i>		Mercedes-Benz Finance and Insurance	59	Paint finishes
41	CL 65 AMG	47	Upholstery and trim		Test drive Interactive Owner's Manual		
		52	Alloy wheels				
		53	Retailer-fit accessories				



BlueEFFICIENCY – technology for more efficient driving



Our comprehensive BlueEFFICIENCY measures have already brought significant cuts in fuel consumption to many current Mercedes-Benz models, helping to lower both their CO₂ emissions and their running costs. What's more, we are continuing to develop new environmentally friendly technologies that will reduce emissions even further and help to make motoring more sustainable in the long term.

BlueEFFICIENCY – the Mercedes-Benz efficiency drive. In addition to highly advanced and efficient engines, BlueEFFICIENCY models come with a range of energy-saving measures that enable fuel consumption and CO₂ emissions to be reduced by up to 23%. These measures vary from model to model but can include ECO start/stop, on-demand ancillary components and low-resistance tyres, as well as aerodynamic optimisation and the use of lightweight materials.

BlueTEC – cleaner diesel power. BlueTEC is our cleanest diesel technology to date. Its combination of advanced common-rail direct injection, optimised combustion and modular emissions control systems reduces particulate levels by up to 95% and removes up to 90% of nitrogen oxides, leaving little but water, harmless nitrogen and the satisfaction of knowing you've done your bit for the environment.

HYBRID and BlueTEC HYBRID – the future of internal combustion. The next stage in our efficiency drive, hybrid drivetrains will bring new levels of fuel efficiency and emissions reduction to tomorrow's Mercedes-Benz passenger cars. The diesel equivalent, BlueTEC HYBRID, combines the benefits of hybrid drive with the clean-burn technology of BlueTEC.

BlueZERO – the drivetrains of tomorrow.

The BlueZERO concept showcases three highly developed electric vehicle variants. The E-CELL is an all-electric system driven solely by the battery, E-CELL PLUS pairs battery power with a range-extending internal combustion engine, while the F-CELL features a hydrogen-based fuel-cell stack.

Design for Environment. Our environmental philosophy is not just about in-car technologies. It also involves taking the entire lifecycle of each vehicle into account, from its initial planning to its end-of-life recycling. We apply the same approach to the building and maintenance of new factories too, saving energy, avoiding harmful emissions and making increasing use of renewable resources. In addition, Mercedes-Benz is involved in the development of alternative fuels and conducts research in the field of bionics.

For more information about what BlueEFFICIENCY can do for you, please visit www.mercedes-benz.co.uk/blueefficiency



Efficiency in the CL-Class

The CL has always been a technological standard-setter – and the latest generation is no exception. Its BlueDIRECT engine comes with innovations such as direct petrol injection that help to further enhance fuel efficiency and reduce emissions.

Environmental protection and energy conservation are of ever increasing importance, with CO₂ emissions, fuel consumption and petrol prices

all key issues for today's drivers. That's why the CL, besides boasting an exceptionally low drag coefficient, now also features BlueEFFICIENCY

technology and a BlueDIRECT engine with direct petrol injection. The fuel-saving measures for the CL range include:



- 1 ECO start/stop function for the CL 500 BlueEFFICIENCY and CL 63 AMG
- 2 BlueDIRECT petrol V8 with lower displacement, direct petrol injection, two small turbochargers for rapid responses and intercooling for optimised thermodynamic efficiency
- 3 Sealed joints around headlamps for improved aerodynamics
- 4 Optimised 7G-Tronic for CL 500 BlueEFFICIENCY
- 5 EU5 compliance for all models
- 6 Alternator management system with regenerative braking (V8 engines)
- 7 Aerodynamic exterior mirror casings
- 8 Energy-saving oil, water and power steering pumps for V8 engines
- 9 Tyres designed for lower rolling resistance



Engines

Thanks to twin turbos, direct injection and many fuel-saving features, our BlueDIRECT V8 petrol engine sets new standards for efficiency and performance.

BlueDIRECT V8 petrol engine. The CL 500 BlueEFFICIENCY is the first Mercedes-Benz to feature our BlueDIRECT petrol V8. This high-tech engine features intercooled twin turbos that help to increase output to 435 hp (320 kW) while significantly improving torque levels, with a maximum of 700 Nm available from just 1,800 rpm. The result is even more rapid acceleration and effortless performance in any situation. Thanks to lightweight construction, lower displacement, direct fuel injection via ultra-precise

piezo injectors and a range of BlueEFFICIENCY features, the CL 500 BlueEFFICIENCY nevertheless uses less fuel than its predecessor and achieves a corresponding reduction in CO₂ emissions. The ECO start/stop function, which

temporarily switches off the engine when queuing at lights or in traffic jams, is just one of the many fuel-saving technologies fitted to the CL 500 BlueEFFICIENCY, which also meets the Euro 5 standard for exhaust emissions.



The BlueDIRECT petrol V8 is the first of the Mercedes-Benz BlueDIRECT engines

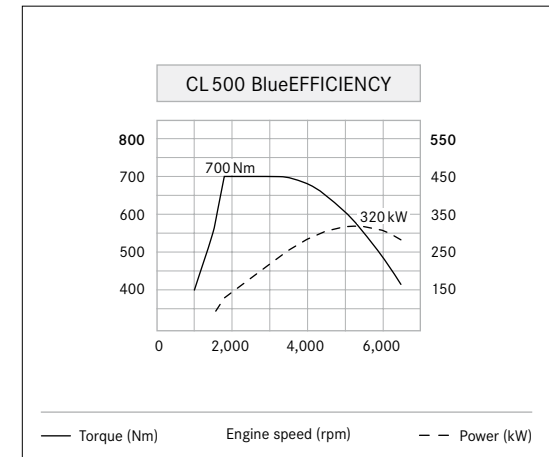

The CL 500 BlueEFFICIENCY: improved power and torque thanks to direct petrol injection and twin turbochargers

Transmissions

The CL's transmissions are perfectly matched to its engines – and let you choose the right mode for your mood.

7G-Tronic Plus. The CL500 BlueEFFICIENCY comes with an improved version of our 7G-Tronic Plus 7-speed automatic transmission. Its seven forward gears ensure the engine is always operating at the optimum speed, helping to reduce fuel consumption, while the short, slick shifts make for smoother, quieter driving. The transmission is controlled via the Direct Select gear shift lever on the steering column, while a separate set-up switch enables you to choose between manual, economy and sport modes. In manual mode, you can also change gear using racing-style steering wheel shift paddles.

5-speed automatic transmission. The perfect partner for the CL65 AMG's V12, the 5-speed automatic transmission offers rapid and barely

perceptible gear shifts and ensures optimum acceleration in any situation. It also gives you the option of changing gear manually.

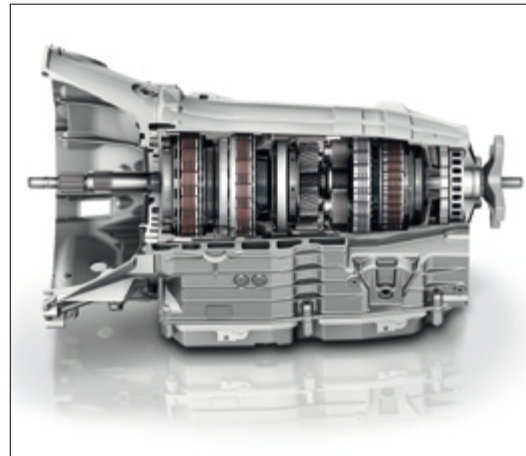

7G-Tronic Plus: the result of more than 50 years' experience in automatic transmission technology



The Direct Select gear shift lever on the steering column



Suspension

Thanks to intelligent suspension technology, the CL guarantees supreme comfort on every surface.

Active Body Control (ABC) with crosswind stabilisation (standard). Active Body Control (ABC) constantly varies the suspension settings as you drive, ensuring agile handling and a supremely comfortable ride at all times. Its

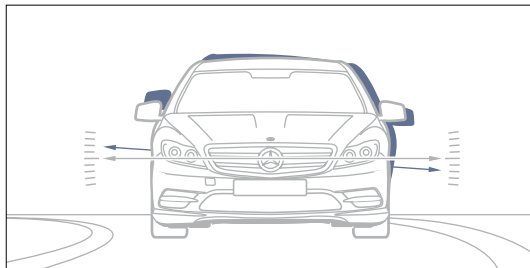

Active Body Control gives the CL a supremely agile feel. It also compensates for strong crosswinds by adjusting the load distribution between the wheels

microprocessors instantly adjust each strut to changes in the surface or situation, enabling it to compensate automatically for body roll and pitch. ABC also helps to limit squat and dive when accelerating and braking.

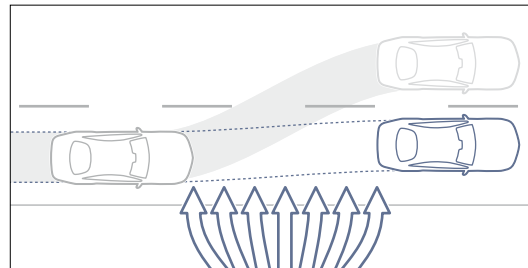

In addition, ABC includes a crosswind stabilisation function that compensates for the effect of high winds by redistributing the load between the wheels.



Microprocessors pick up on uneven road surfaces and instantly compensate to ensure a smooth ride for all passengers



Safer driving

The CL comes with a range of electronic assistants that reduce the risk of accidents by helping you to spot and avoid danger in advance.

Attention Assist (standard). Particularly beneficial on long journeys, Attention Assist is a system for detecting fatigue. Between speeds of approximately 50 and 110 mph, it assesses the driver's behaviour via an array of sensors and registers unexpected changes that may indicate tiredness, such as involuntary movements of the steering wheel.



If it detects signs of fatigue, Attention Assist suggests taking a break

Adaptive High Beam Assist (standard). Adaptive High Beam Assist ensures you enjoy optimum visibility at night without dazzling other drivers. It automatically dips the headlamps when there's oncoming traffic or vehicles ahead and then raises them again when the road is clear. What's more, the transition between main beam and dipped is smooth and almost imperceptible to the driver.

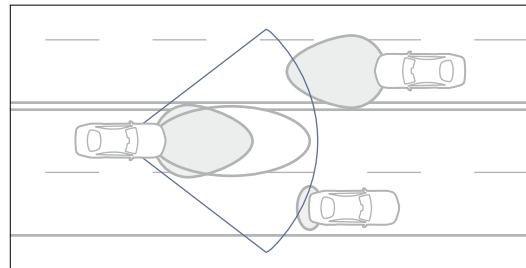

With Adaptive High Beam Assist, the transition between main beam and dipped is almost imperceptible

Night View Assist Plus (optional). This infrared camera system captures the entire area that would be illuminated on main beam and shows a black-and-white image in the instrument cluster. In situations where switching to main beam is not appropriate, Night View Assist Plus ensures you have a clearer picture of the road ahead, enabling you to react faster to potentially dangerous situations.



Night View Assist Plus helps drivers to spot pedestrians by highlighting them on the screen



Driving Assistance Package (optional). This safety-enhancing option package features Active Lane-Keeping Assist, which draws attention to unintended lane changes by gently vibrating the steering wheel. If there's no reaction, it can intervene in order to correct the car's course and help prevent a collision by precisely applying the brakes. Also fitted as part of the package is Active Blind Spot Assist. It warns you of vehicles

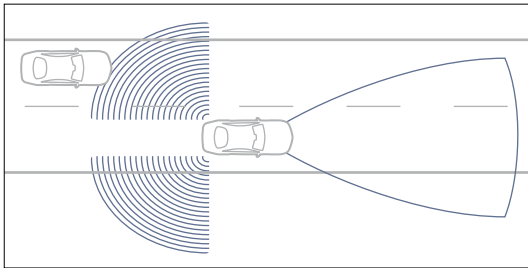

The Driving Assistance Package includes safety-enhancing features such as Active Lane-Keeping Assist and Active Blind Spot Assist

in one of your blind spots via a red triangle in the corresponding mirror. Should you nevertheless proceed to change lanes, the system can automatically apply the brakes in order to avoid a collision. The package also includes DISTRONIC Plus, a radar-assisted cruise control system that maintains a preset distance from the vehicle in front, and the Pre-Safe® Brake, which slows the car automatically if a collision with the vehicle in front seems likely.



Active Blind Spot Assist warns the driver of potentially dangerous lane changes

Torque Vectoring Brake (standard). If the ESP® system detects the onset of understeer, the Torque Vectoring Brake applies the brakes to the inside rear wheel, helping the CL to corner more precisely and predictably.

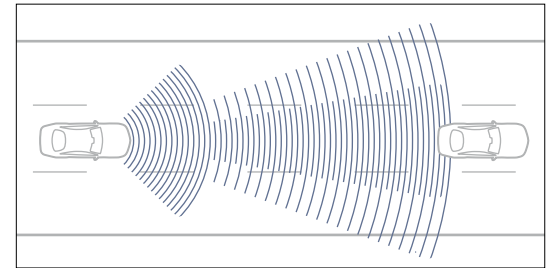

DISTRONIC Plus radar-assisted cruise control helps the driver to maintain a safe distance from the vehicle in front



Occupant protection

The CL comes with a range of systems that enhance occupant protection in the event of a probable or actual accident.

Pre-Safe® system (standard). If it detects a probable accident situation, Pre-Safe® can take anticipatory measures to protect the occupants, such as activating the seat belt tensioners, automatically closing the front windows and sunroof (if fitted), and moving the passenger seat to a better position for an impact. If optional dynamic multi-contour seats are fitted, their side bolsters can be adjusted to hold the occupants more securely in place.

Pre-Safe® Brake (fitted as part of optional Driving Assistance Package). This system alerts the driver to the risk of a collision via visual

and audible warnings. If the driver fails to react after the three acoustic warnings, the car then slows automatically, applying 40% of the full braking force (4 m per sec.) and triggering a range of Pre-Safe® measures. If the driver still does not react, the car will ultimately perform an emergency stop. These interventions can help to significantly reduce the speed and severity of an impact.

Neck-Pro head restraints (standard). Fitted to both front seats, the Neck-Pro head restraints automatically move forwards and upwards in the event of a rear-end collision. This enables

them to support the head sooner and reduce strain on the spine.

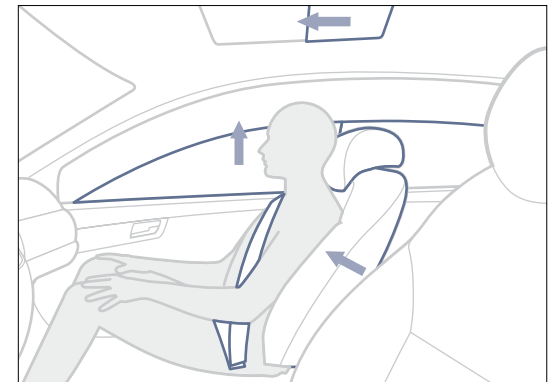

The Pre-Safe® anticipatory safety system can help to reduce the consequences of an accident



Airbags (standard). Airbags have been standard equipment on all Mercedes-Benz passenger cars since October 1992. The eight that are fitted to the CL include dual-stage front airbags, sidebags in the backrests of the front seats and rear sidebags concealed within the wheel arch trims. There are also twin windowbags that provide additional protection for both front and rear seat occupants. Airbag deployment is managed by a redeveloped control unit, which, on models fitted with proximity sensors, can even detect critical approach speeds prior to an impact.



Up to eight airbags help to protect you and your passengers in the event of an accident



Multimedia systems

The CL comes with Bluetooth® connectivity, USB and SD card interfaces and can be fitted with the Front Seat Entertainment Package, which includes SplitView and the Harman Kardon® Logic 7® surround sound system.

COMAND multimedia system (standard). The COMAND system combines the telephone, audio and video functions plus hard drive-based navigation in one easy-to-use unit. Its 6-disc DVD changer plays video and audio CDs or DVDs as well as MP3 audio files. In addition, COMAND enables you to store up to 2,500 songs on the hard drive and search its music library by title or artist, ensuring you can find the



COMAND controller in the centre console

desired track quickly and easily. All information is presented on a central colour screen, which can even display maps in 3D. COMAND also includes Linguatronic voice control, meaning many functions can be operated via simple spoken commands, as well as 3 years' worth of free updates for its European map data and a Media Interface that allows full integration and control of external media devices.

SplitView (part of the optional Front Seat Entertainment Package). Thanks to SplitView, the driver and front seat passenger can view different full-size images on the same screen. This means the passenger can watch their choice of in-car entertainment while the driver continues to see map data from the navigation system. The wireless headphones allow the passenger to enjoy audio output without distracting the driver.



SplitView enables the screen to simultaneously display different images for the driver (1) and the front seat passenger (2)



Harman Kardon® Logic 7® surround sound system (part of the optional Front Seat Entertainment Package). This 14-speaker surround sound system is tailored to the CL's cabin and features a 13-channel DSP amplifier as well as an integral subwoofer. 3D sound in Dolby Digital 5.1 guarantees maximum listening pleasure, while the speed-sensitive volume adjustment ensures the sound remains consistent throughout the journey.

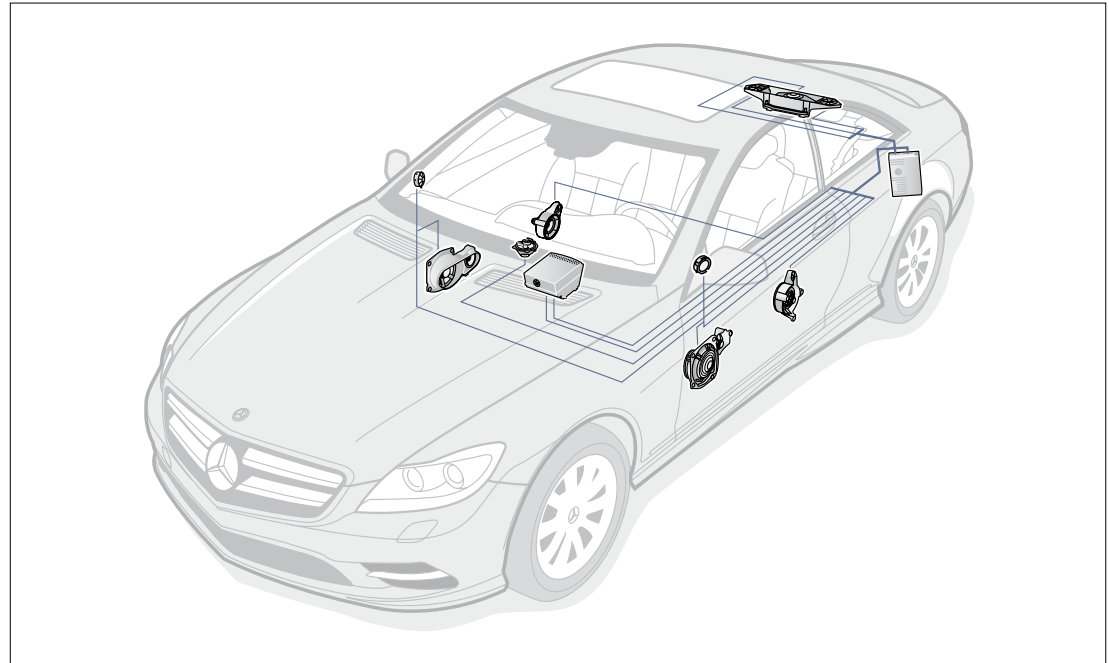

The Harman Kardon® Logic 7® surround sound system guarantees a first-class listening experience



Electronic assistants

Numerous electronic assistants help to make CL driving safer and more relaxing.



The reversing camera's wide-angle lens enables you to see what's immediately behind the car

Reversing camera (optional; standard on CL 65 AMG). The reversing camera makes for safer and easier parking manoeuvres. Fitted below the boot lid handle, this wide-angle camera captures the area immediately behind the car and displays the image on the COMAND multimedia system's screen. The camera is activated automatically as soon as the driver engages reverse.

Advanced Parking Guidance (standard). By measuring gaps via ultrasound sensors, Advanced Parking Guidance can help the driver manoeuvre into tight spaces. If the sensors detect a suitably sized space, the situation is depicted graphically in the multi-function display. The red set of tracks shows the current steering angle, the yellow lines represent the required angle. As soon as the two correspond,



the lines turn green. In addition, the system will also illustrate the distance from any objects in the car's vicinity when manoeuvring.

Speed Limit Assist (standard). Thanks to a small windscreen-mounted camera, the CL can

read speed limit signs and display the current limit in the instrument panel. This ensures the driver always knows the speed limit for any given road – a particular boon in areas where the speed limit varies or when passing through roadworks.

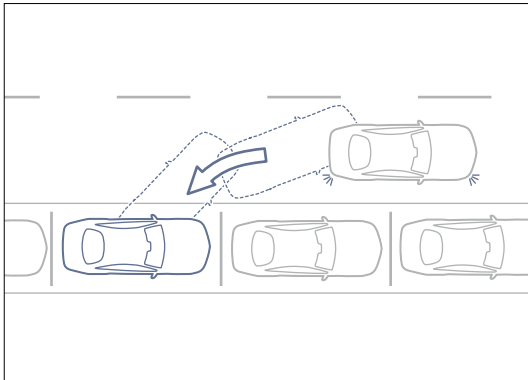

Advanced Parking Guidance helps you manoeuvre into gaps



The progress of the manoeuvre is shown in the multi-function display



The current speed limit is displayed in the instrument panel



Climate control

The CL's luxury automatic climate control enhances your comfort and helps you to stay focused at all times.

Luxury automatic climate control (standard). The CL comes with a luxury automatic climate control system that enables the driver and front seat passenger to select their own separate settings. Its sensors monitor the



Your ideal temperature at the push of a button

temperature inside and outside the cabin and ensure the preset temperature for each zone is maintained at all times, with a solar sensor in the windscreen enabling it to even compensate for strong sunlight. Front seat occupants can



The climate control menu in the COMAND multimedia system

also increase or decrease the air temperature in the footwells independently of their selected temperature settings.

As a result, each front seat occupant can enjoy the right climate for them, ensuring maximum concentration for the driver, plus optimum comfort and safety all round.

Also fitted as standard are an air recirculation function, a chilled glove compartment, and a combined dust filter and activated charcoal filter that keeps the cabin free from particulates and maintains optimum air quality at all times.



Seats

The CL seats offer optimum comfort, ergonomics and safety combined with an exclusive design.

Dynamic multi-contour seats (optional; standard on AMG models). The dynamic multi-contour front seats with massage function offer outstanding long-distance comfort. Air chambers in the lumbar and shoulder regions



Comfortable individually sculpted rear seats

can be adjusted to each occupant's individual body shape, while the side bolsters adapt automatically as you drive to ensure optimum support at all times, especially when cornering. Neck-Pro comfort front head restraints and



Dynamic multi-contour front seats with massage function

4-way adjustable lumbar support further add to your sense of well-being.

Comfort-ventilated front seats (optional; standard on AMG models). The air-conditioned seats provide either cooling ventilation or warming heat, ensuring optimum comfort all year round.



CL 500 BlueEFFICIENCY

Luxury, efficiency, performance – the CL 500 BlueEFFICIENCY triumphs on all fronts.



AMG sports styling comes as standard



The comprehensive standard equipment for the CL 500 BlueEFFICIENCY includes metallic paint, 19" AMG 5-spoke alloy wheels and the Intelligent Light System, which comprises bi-xenon headlamps, Adaptive High Beam Assist and chrome-trimmed LED daytime running lights. For easier access and exit, a doorhold system and Easy-Entry mechanisms for the front seats and steering wheel are also fitted as standard. Inside, there's finely crafted trim in Black Ash wood, standard leather upholstery that comes in five harmonious colour schemes, plus heated and electrically adjustable front seats with four-way lumbar adjustment.

The standard COMAND multimedia system combines all the key entertainment and communication functions and features a user-friendly colour display, while Attention Assist, Active Body Control (ABC) with crosswind stabilisation

and Torque Vectoring Brake all help to maximise safety and comfort. For effortless parking manoeuvres, the Advanced Parking Guidance also comes as standard.



Wood- and nappa leather-trimmed multi-function steering wheel



CL 63 AMG

A champion among sporting coupés: the CL 63 AMG. → www.mercedes-amg.com



The CL 63 AMG combines powerful performance, muscular looks and impressive efficiency



With the CL63 AMG, the first impression is always a powerful one, thanks to AMG body-styling featuring a muscular new front apron with AMG-specific LED daytime running lights and High-gloss Black cross strut, AMG side skirts and a new diffuser-style rear apron in the vehicle body colour. There's also a striking AMG-specific single-bar grille, chromed twin tailpipes and eye-catching 19" AMG 5-triple-spoke alloy wheels. For an even more dramatic look, optional 20" AMG forged alloy wheels in polished Titanium Grey are available from the AMG Performance Studio.

The cabin, too, bears the unmistakable AMG signature. It features AMG sports seats with AMG-design Passion leather upholstery, an AMG sports steering wheel with aluminium shift paddles, and an AMG instrument panel with new AMG V8 BITURBO start screen.

As well as displaying the current gear and the engine oil temperature, the instrument panel display also features a Racetimer function that allows you to record individual lap times.

The finishing touch comes courtesy of an IWC-designed analogue clock that blends beautifully with the Dark Burr Walnut trim (AMG Interior Carbon-Fibre Trim Package is available as an option).



AMG sports seats with AMG-design Passion leather upholstery and natural leather side bolsters



AMG sports steering wheel with aluminium shift paddles



CL 63 AMG – technology

The CL 63 AMG combines exhilaration with efficiency – thanks to its new AMG 5.5-litre biturbo V8 and AMG Speedshift MCT 7-speed sports transmission. → www.mercedes-amg.com

AMG 5.5-litre V8. The CL 63 AMG's new biturbo AMG V8 is not just impressively powerful, it's also exceptionally fuel-efficient. With 544 hp (400 kW) and 800 Nm of torque (571 hp/420 kW and 900 Nm with the optional AMG Performance Package) it delivers 0–62 mph in 4.5 seconds, and yet achieves class-leading 26.9 mpg on the combined cycle. This remarkable efficiency is the result of advanced technologies such as direct petrol injection, twin turbochargers and regenerative braking, combined with a transmission featuring a Controlled Efficiency mode with start/stop function. As you'd expect from an AMG engine, this high-tech V8 nevertheless delivers a satisfyingly rich and powerful sound.



The AMG 5.5-litre biturbo V8 offers up to 571 hp and 900 Nm of torque with the optional AMG Performance Package



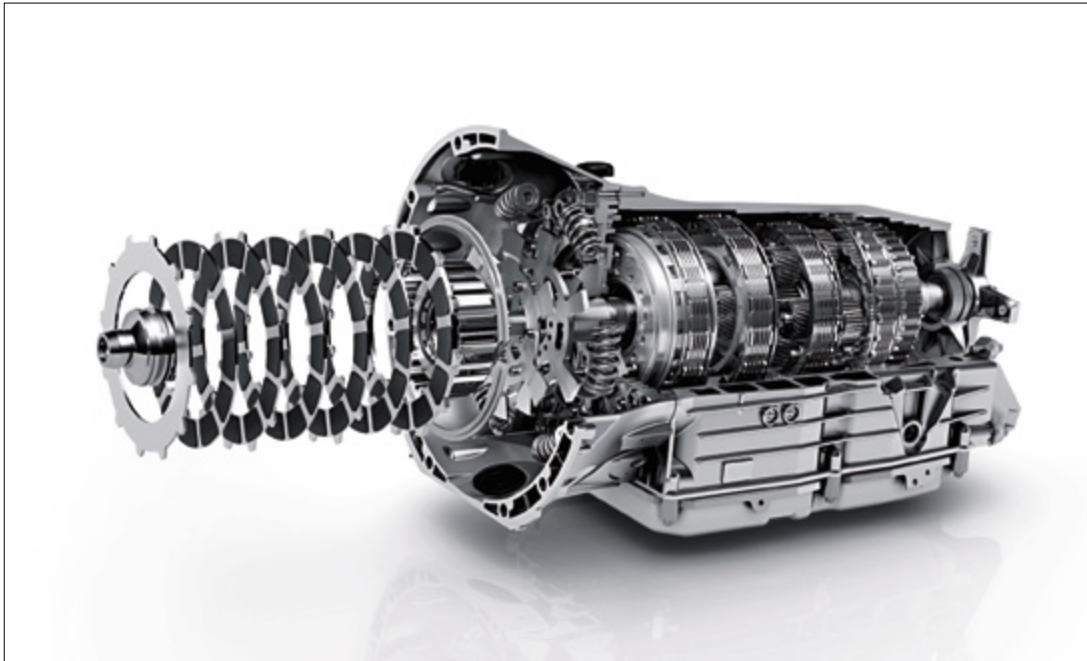

The AMG Speedshift MCT 7-speed sports transmission delivers smooth yet rapid gear changes

AMG Speedshift MCT 7-speed sports transmission.

Like the innovative engine it accompanies, the CL 63 AMG's Speedshift MCT transmission combines the best of both worlds, blending the sporty, direct and involving feel of a manual transmission with the comfort and effortlessness of an automatic. Its Controlled Efficiency, Sport and Manual modes give you a choice of three different shift styles, while the kickdown function enables the transmission to shift straight from seventh gear to fourth, for instance - allowing you to exploit the engine's performance potential to the full.



CL 65 AMG

A perfect blend of performance and exclusivity: the CL 65 AMG. → www.mercedes-amg.com



With the CL 65 AMG, exceptional performance and sumptuous luxury go hand in hand



The CL 65 AMG is a luxury coupé like no other. Its 6.0 litre biturbo AMG V12 delivers 630 hp (463 kW) and a remarkable 1,000 Nm of torque, making even the most rapid driving seem utterly effortless.

From the outside, the CL 65 AMG offers the same muscular elegance as the CL 63 AMG, but with the extra exclusivity of 20" 5-twin-spoke forged alloy wheels, front apron with chrome cross strut, diffuser-style rear apron in chrome, model-specific chromed twin tailpipes and V12 BITURBO badges on the front wings.

Inside, the highly contoured backrests of the AMG sports seats provide firm support even in fast cornering, while the standard Exclusive Passion Leather with model-specific seat upholstery and leather door centre panels lends

a highly individual look. Brushed stainless steel sports pedals with rubber studs, an AMG sports steering wheel with aluminium shift paddles, and an instrument panel with an AMG V12 BITURBO start screen are among the many other distinctive interior details.



Exclusive Passion Leather plus AMG sports seats featuring AMG-design leather upholstery

Both AMG models can be given an even more individual touch with AMG Performance Studio options. These include the AMG Exterior Carbon-Fibre Trim Package, which adds carbon-fibre for the front apron's cross-strut, the exterior mirror casings and the diffuser-style rear apron element.



Model-specific chromed twin tailpipes



Standard equipment | Selection



Wood- and nappa leather-trimmed multi-function steering wheel¹



COMAND multimedia system



Memory function for front seats



Telephone keypad

¹ Shown with optional Keyless-Go



Intelligent Light System with bi-xenon headlamps and LED daytime running lights



LED tail lights



Optional extras | Selection



Active Blind Spot Assist



Ambient interior lighting with three colour settings



Keyless-Go

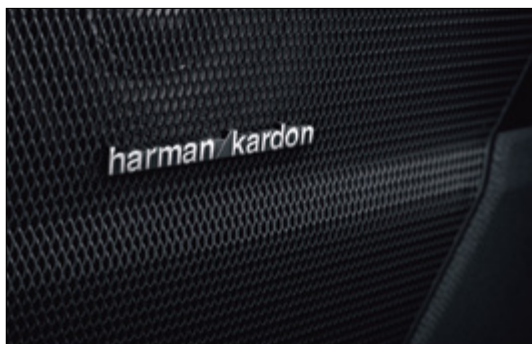

Harman Kardon® Logic 7® surround sound system



Night View Assist Plus



SplitView



designo

Exclusive colours, exquisite upholsteries and the finest interior trim: *designo* options add an extra touch of individuality to your CL.

→ www.mercedes-benz.co.uk/designo

With beautifully crafted materials and a wide variety of colours, the *designo* range offers almost endless possibilities. Eye-catching *designo* paint finishes add an exclusive touch

to the exterior. For the interior, there's *designo* Exclusive aniline leather, complemented by carefully matched wood trim, such as Black Piano Lacquer, with a gloss finish applied in up

to ten layers, or stone trims made of finely cut Norwegian granite.

All *designo* CL upholsteries feature 10-rib vertical fluting and metal *designo* backrest badges, while the wood- and leather-trimmed steering wheel and *designo* roof lining in fabric, Alcantara® or Black nappa leather further enhance the air of refinement.



designo Cashmere White Magno paint finish (code 049)



Whether you opt for a harmonious colour scheme or striking contrasts, *designo* options lend your CL an even more exclusive look and feel.

In the *designo* section of our website, you can browse through the colours and materials available and try out possible combinations.



designo Selection with *designo* logo in 18-carat gold



Door centre panels in Light Brown *designo* Exclusive aniline leather (X35)



Upholstery in Light Brown *designo* Exclusive aniline leather (X35) with Black Piano Lacquer trim (W69)



Upholstery and trim



The Black/Black interior scheme features either standard leather or optional Passion leather upholstery (standard on CL 63 AMG), with matching black carpets and cabin trim (side panel trims, dashboard, centre console and steering wheel trim). Choose the optional Exclusive Passion Leather (standard on CL 65 AMG) and elements such as the dashboard, doors and centre console are finished in Passion leather. The roof lining and A- and C-pillars are finished in Alcantara®

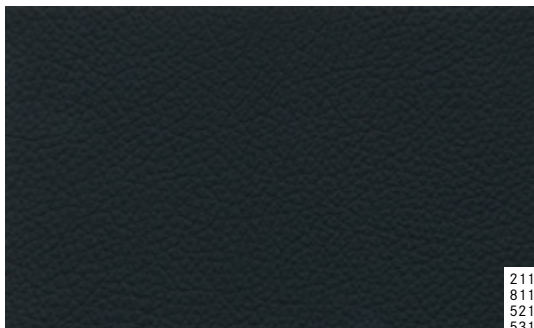

211
811
521
531



H14



731



736



H18

BLACK/BLACK

- 211 Leather
- 811 Passion leather¹
- 521 Exclusive Passion Leather¹
- 531 Exclusive Passion Leather²

TRIM

- H14 Light Burr Walnut³
- 731 Dark Burr Walnut⁴
- 736 Black Ash⁵
- H18 Brown Poplar⁶

¹Optional ²Standard on CL 65 AMG ³Optional on all models ⁴Standard on CL 63 AMG and CL 65 AMG, optional on CL 500 BlueEFFICIENCY ⁵Standard on CL 500 BlueEFFICIENCY, optional on other models ⁶Optional on CL 65 AMG



The Cashmere Beige/Savanna Beige interior scheme features Cashmere Beige leather upholstery, with matching door panels, lower dashboard trim and centre console. The steering wheel, upper dashboard trim and centre console come in Savanna Beige. As an option, this colour scheme is also available with Passion leather (standard on CL 63 AMG) or choose Exclusive Passion Leather (standard on CL 65 AMG) and elements such as the dashboard, doors and centre console are finished in Passion leather. The roof lining and A- and C-pillars are finished in Alcantara®.

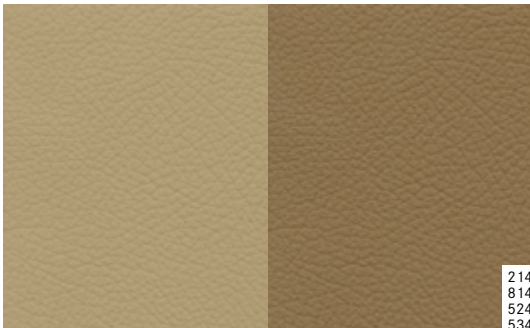

214
814
524
534



H14



731



736



H18

CASHMERE BEIGE/SAVANNA BEIGE

- 214 Leather
- 814 Passion leather¹
- 524 Exclusive Passion Leather¹
- 534 Exclusive Passion Leather²

TRIM

- H14 Light Burr Walnut³
- 731 Dark Burr Walnut⁴
- 736 Black Ash⁵
- H18 Brown Poplar⁶

¹Optional ²Standard on CL 65 AMG ³Optional on all models ⁴Standard on CL 63 AMG and CL 65 AMG, optional on CL 500 BlueEFFICIENCY ⁵Standard on CL 500 BlueEFFICIENCY, optional on other models ⁶Optional on CL 65 AMG



The Alpaca Grey/Basalt Grey interior scheme features Alpaca Grey leather upholstery, with matching door panels, lower dashboard trim, centre console and carpets. The steering wheel, upper dashboard trim and door caps come in Basalt Grey. As an option, this colour scheme is also available with Passion leather (standard on CL 63 AMG) or choose Exclusive Passion Leather (standard on CL 65 AMG) and elements such as the dashboard, doors and centre console are finished in Passion leather. The roof lining and A- and C-pillars are finished in Alcantara®

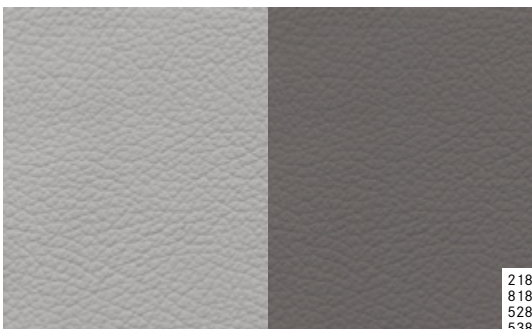

218
818
528
538



H14



731



736



H18

ALPACA GREY/BASALT GREY

- 218 Leather
- 818 Passion leather¹
- 528 Exclusive Passion Leather¹
- 538 Exclusive Passion Leather²

TRIM

- H14 Light Burr Walnut³
- 731 Dark Burr Walnut⁴
- 736 Black Ash⁵
- H18 Brown Poplar⁶

¹Optional ²Standard on CL 65 AMG ³Optional on all models ⁴Standard on CL 63 AMG and CL 65 AMG, optional on CL 500 BlueEFFICIENCY ⁵Standard on CL 500 BlueEFFICIENCY, optional on other models ⁶Optional on CL 65 AMG



The Sahara Beige/Black interior scheme features Sahara Beige leather upholstery, with matching door panels, lower dashboard trim and centre console. The steering wheel, upper dashboard trim, door caps and carpets come in Black. As an option, this colour scheme is also available with Passion leather (standard on CL 63 AMG) or choose Exclusive Passion Leather (CL 500 BlueEFFICIENCY only) and elements such as the dashboard, doors and centre console are finished in Passion leather. The roof lining and A- and C-pillars are finished in Alcantara®

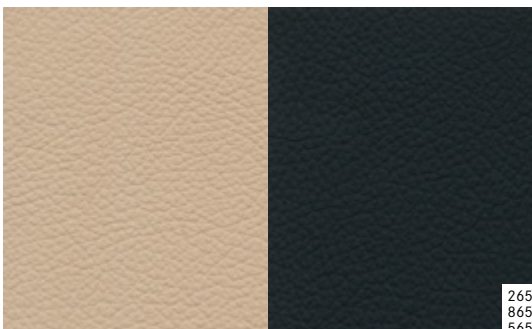

SAHARA BEIGE/BLACK¹

- 265 Leather
- 865 Passion leather²
- 565 Exclusive Passion Leather²

TRIM

- H14 Light Burr Walnut³
- 731 Dark Burr Walnut³
- 736 Black Ash⁴
- H18 Brown Poplar⁶

¹ Not available for CL 63 AMG or CL 65 AMG ² Optional ³ Optional on all models ⁴ Standard on CL 63 AMG and CL 65 AMG, optional on CL 500 BlueEFFICIENCY ⁵ Standard on CL 500 BlueEFFICIENCY, optional on other models ⁶ Optional on CL 65 AMG





The Aubergine/Black interior scheme features Aubergine leather upholstery, with matching door panels, lower dashboard trim and centre console. The steering wheel, upper dashboard trim, door caps and carpets come in Black. As an option, this colour scheme is also available with Passion leather (standard on CL 63 AMG) or choose Exclusive Passion Leather (CL 500 BlueEFFICIENCY only) and elements such as the dashboard, doors and centre console are finished in Passion leather. The roof lining and A- and C-pillars are finished in Alcantara®.

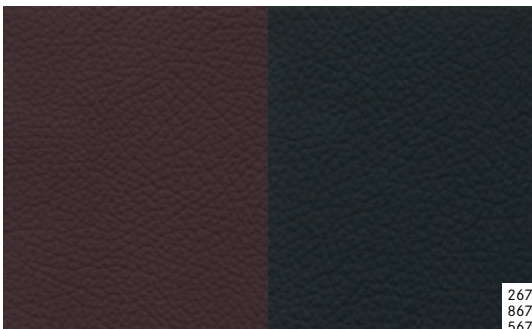

267
867
567



H14



731



736



H18

AUBERGINE/BLACK¹

- 267 Leather
- 867 Passion leather²
- 567 Exclusive Passion Leather²

TRIM

- H14 Light Burr Walnut³
- 731 Dark Burr Walnut³
- 736 Black Ash⁴
- H18 Brown Poplar⁶

¹ Not available for CL 63 AMG or CL 65 AMG ² Optional ³ Optional on all models ⁴ Standard on CL 63 AMG and CL 65 AMG, optional on CL 500 BlueEFFICIENCY ⁵ Standard on CL 500 BlueEFFICIENCY, optional on other models ⁶ Optional on CL 65 AMG



Wheels



19" AMG 5-spoke alloy wheels with high-sheen finish (standard on CL 500 BlueEFFICIENCY)



19" AMG 5-triple-spoke alloy wheels painted in Titanium Grey with high-sheen finish (standard on CL 63 AMG)



20" AMG 5-twin-spoke alloy wheels, painted in Titanium Grey (standard on CL 65 AMG, optional on CL 63 AMG)



20" AMG 5-twin-spoke alloy wheels with high-sheen finish (optional)



19" incenio 'Nuklida' 5-Y-spoke alloy wheels,¹ High sheen Titanium Silver finish (Retailer-fit accessory)



20" 'Alaraph' 10-spoke alloy wheels, Sterling Silver finish (factory-fit accessory)



20" incenio 'Kiyali' 5-spoke alloy wheels,¹ Titanium Silver (Retailer-fit accessory)

¹ incenio alloy wheels are supplied without tyres



Retailer-fit accessories

A Mercedes-Benz is not just a car, it's a travel companion that can be tailored to your needs – with our wide range of Retailer-fit accessories.

→ www.mercedes-benz.co.uk/accessories



incenio 'Maedis' design wheels

Our Retailer-fit accessories offer you a variety of ways to increase the practicality and individuality of your CL. These include a robust chromed metal coat hanger that clips onto the front head restraints and keeps suit jackets or other items from getting creased, and a boot tray that can be used to carry foodstuffs or bottles. The tray is designed to fit neatly into the CL's boot and features slightly raised edges and special ribbing that prevents cargo from sliding around the floor. The range also includes a synthetic stretch-fabric dust cover that protects your CL against dirt, dust and scratches, as well as styling enhancements such as incenio alloy wheels.





Boot tray



Coat hanger

For more information about these and other high-quality accessories, talk to your Mercedes-Benz Retailer or consult the CL-Class accessories brochure.



Dust cover



Services

Mercedes-Benz World at Brooklands. Celebrate the story of Mercedes-Benz and you'll celebrate the story of motoring itself at Mercedes-Benz World in Surrey. A World of experiences. A World of discoveries. A World you will love to explore. Discover Mercedes-Benz racing heritage, its connections to the famous Brooklands circuit and to legendary drivers. View, touch and sit in every car from the Mercedes-Benz range, and encounter automotive legends like the 'Gullwing', in the UK's largest Mercedes-Benz showcase. Then set your pulse racing by booking one of our thrilling Driving Experiences. Enjoy AMG performance on the purpose-built Handling Circuits or Wet Skid Circle, an axle-twisting off-road adventure, or treat your kids to their own drive in an A-Class if they are over 1.5 metres tall. For more interactive action, take a virtual journey along the production line in 'Build' or take a seat in the cinema and accelerate from the birth of the car to the latest innovations in 20 eye-opening minutes.

Relax and refuel in Café 1886, or for a gourmet treat enjoy the first-class menu and elegant surroundings of the Gullwing Restaurant. Finally, extend your visit with a short stroll to Brooklands Museum to see their collection of classic cars, aviation exhibitions – and the legendary Concorde. For more information visit www.mercedes-benzworld.co.uk

Mercedes-Benz Museum. More than 120 years of automotive history in one place – the Mercedes-Benz Museum in Stuttgart-Untertürkheim. With a total exhibition area of 16,500 m², it transports the visitor into a fascinating world of automotive achievement. You can see the first modern motor car, the Mercedes Simplex, discover over 100 years of motor-racing history, and, of course, admire our classics, such as the 'Gullwing' and the 'Tail Fin'. Legendary cars such as these have always occupied a special place in the hearts of car enthusiasts. Now they have a special place

of their own in the Mercedes-Benz Museum. We look forward to welcoming you there soon.

Roadside Assistance. Rest assured that should you ever need help, Mercedes-Benz Roadside Assistance is there for you. In the unlikely event of a technical breakdown¹ you can rely on the Mercedes-Benz Roadside Assistance Team – anywhere in Europe. Simply phone our Customer Assistance Centre on 00800 1 777 7777;² where our specialists will organise assistance for you. Mercedes-Benz will also assist you in the event of a minor mishap preventing you from driving your vehicle.³ Whether you lose your key, run out of fuel or your vehicle is damaged due to an accident or vandalism, Mercedes-Benz ensures that you still reach your destination. Often the problem can be rectified on the spot, but if this is not possible, we will naturally ensure that your vehicle is taken to the nearest Mercedes-Benz Official Workshop to get you back on the road as quickly as possible.



Mercedes-Benz Finance. At Mercedes-Benz Finance, our single-minded aim is to provide optimum financial solutions for all those who share the Mercedes-Benz philosophy of absolute commitment to quality. Whether you are a private customer or a business user, our finance and leasing packages can be tailored to meet your individual needs. For further information on Mercedes-Benz Finance, please contact your local Mercedes-Benz Retailer.

Mercedes-Benz Insurance offers a fully comprehensive 5 star⁴ motor insurance policy specifically designed to give you the cover you would expect from Mercedes-Benz. For a quotation, please call 0845 600 2180.⁵

Test drive. A Mercedes-Benz is most at home on the road. This is the only way to experience the effortlessly superior driving feel that lends every Mercedes model its inimitable class. Feel the power of efficient engines with low fuel consumption, and precise steering designed to put you in the mood for driving. And experience what true comfort really feels like. The unique feeling of driving a Mercedes cannot be put into words, however. Which is precisely why we'd like to invite you to take a test drive. Your Mercedes-Benz Retailer will be happy to make all the necessary arrangements for you. Simply visit www.mercedes-benz.co.uk/testdrive to request a test drive. We look forward to seeing you.



Interactive Owner's Manual. The website also offers an interactive tour, enabling you to take a closer look at your desired model. This simulation is the ideal way to acquaint yourself with your dream car. You can view key functions in detail, gain an insight into the car's inner workings or look at the benefits of each model. For further details, visit www.mercedes-benz.co.uk/clclassmanual

¹Technical breakdown cover is initially valid for your vehicle for four years from the date of first registration. This can be extended from the fifth year, up to a maximum of 30 years, on completion of each scheduled maintenance service, providing that this service is carried out by a Mercedes-Benz Official Workshop

²In non-affiliated European countries: +44 20 7975 7077

³This cover can be retained from the fifth year. Your Mercedes-Benz Official Workshop will provide details of how to renew this cover once your initial four year term has expired

⁴As rated 5 by Defaqto, a leading independent financial research company. Mercedes-Benz Motor Insurance is underwritten by Aviva Insurance UK Limited
⁵Calls are charged at local rate and may be recorded



Dimensions

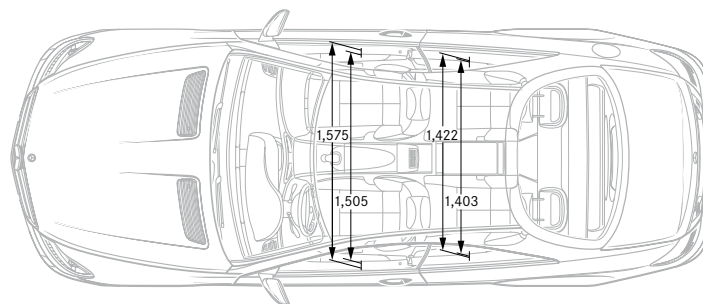
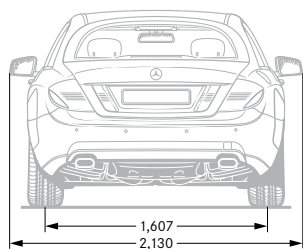
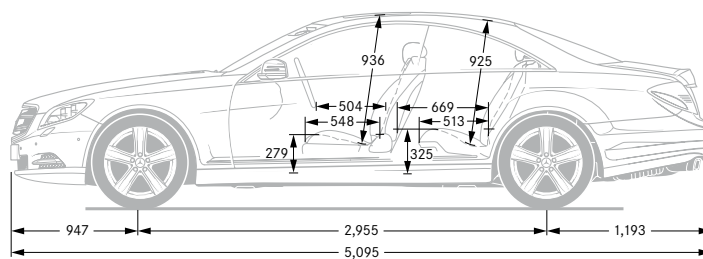
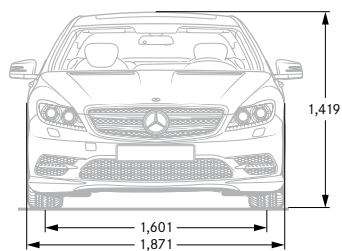

All measurements in millimetres. The dimensions shown are mean values and apply to standard-specification, unladen vehicles



Technical data

PETROL ENGINES	CL 500 BlueEFFICIENCY	CL 63 AMG	CL 65 AMG
No. of cylinders/arrangement	8/V	8/V	12/V
Total displacement – cc	4,663	5,461	5,980
Rated output ¹ – hp (kW) at rpm	435 (320)/5,250	544 (400)/5,500 [571 (420)/5,500] ²	630 (463)/4,600–5,300
Rated torque ¹ – Nm at rpm	700/1,800–3,500	800/2,000–4,500 [900/2,250–3,750] ²	1,000/2,300–4,300
Compression ratio	10.5	10.0	9.0
Acceleration 0–62 mph – sec	4.9	4.5 (4.4) ²	4.4
Top speed approx. – mph	155 ³	155 ³ (186) ²	155 ³
Tyre size – front	255/40 R 19	255/40 ZR 19	255/35 ZR 20
rear	275/40 R 19	275/40 ZR 19	275/35 ZR 20
Fuel consumption ⁴ – mpg			
Urban	20.8	19.6	13.0
Extra-urban	38.7	34.4	28.5
Combined	29.4	26.9	19.8
CO ₂ emissions, combined ⁴ – g/km/EU emissions standard	227–232/EU5	244/EU5	334/EU5
Fuel tank capacity/reserve (approx.) – l	83/11	90/14	90/14
Boot capacity – l	490	490	490
Turning circle – m	11.6	11.6	11.6
Kerb weight ⁵ – kg	2,070	2,135	2,245
Perm. GVW – kg	2,585	2,585	2,645

¹ Figures according to Directive 80/1269/EEC in the currently applicable version ²In conjunction with optional AMG Performance Package (code P30) ³Electronically limited

⁴The figures shown were obtained in accordance with the prescribed measuring process (Directive 80/1268/EEC in the currently applicable version).

The figures are not based on an individual vehicle and do not constitute part of the product offer; they are provided solely for purposes of comparison between different vehicle models

⁵ Figures according to Directive 92/21/EC, version 95/48/EC (kerb weight with fuel tank 90% full, driver, 68 kg, and luggage, 7 kg) for standard-specification vehicles.

Optional extras and accessories will generally increase this figure and reduce the payload capacity accordingly



Paint finishes

NON-METALLIC PAINT

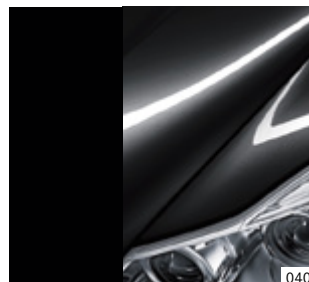

040



228



474

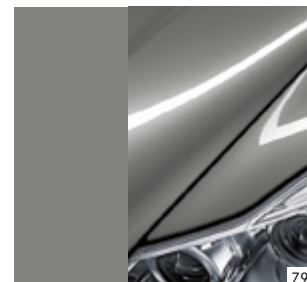

792

METALLIC PAINTS

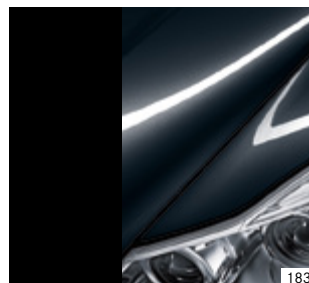

183

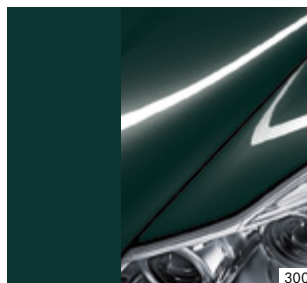

300

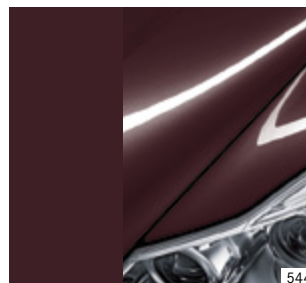

544

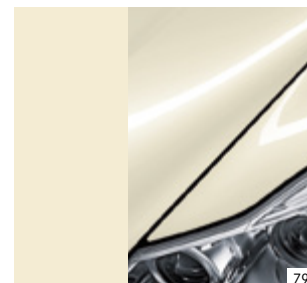

799

NON-METALLIC PAINT (standard)

040 Black

METALLIC PAINTS (standard)

183 Magnetite Black

197 Obsidian Black

228 Cornetite Blue

300 Periclase Green

370 Andorite Grey

474 Peridot Brown

544 Carneol Red

775 Iridium Silver

792 Palladium Silver

799 Diamond White¹

890 Cavansite Blue

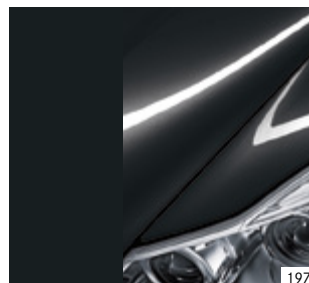

197

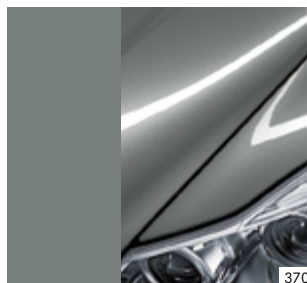

370

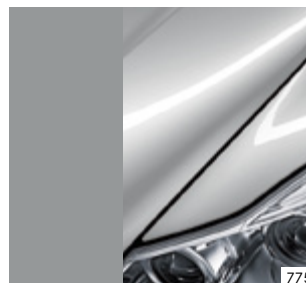

775



890

¹Available at additional cost



Take-back of end-of-life vehicles. Coming full circle. At the end of its long life, you can return your CL-Class to us for environment-friendly disposal in accordance with the EC End-of-Life Vehicle Directive.¹ But that day lies a long way off.

¹Applies in accordance with national regulations to vehicles up to 3.5 tonnes permissible gross weight. The CL-Class has met the statutory regulations governing the suitability of the vehicle's design for reuse and recycling for a number of years now. A network of vehicle take-back depots and dismantlers has been established which will process your vehicle in an environment-friendly manner. The ways in which both vehicles and parts can be recovered are subject to ongoing development and improvement. Consequently, the CL-Class will be able to comply with any future increases in the recycling quota within the stipulated time limits. Further information is available at www.mercedes-benz.co.uk or by calling 0808 156 6606.

Please note: this online version of the printed brochure may contain abridged copy or other content changes. The manufacturer reserves the right to make changes to the design, form, colour and specification during the delivery period, provided these changes, while taking into account the interests of the vendor, can be deemed reasonable with respect to the purchaser. Where the vendor or the manufacturer uses symbols or numbers to describe an order or the subject of an order, no rights may be derived solely from these. The illustrations may show accessories and items of optional equipment which are not part of standard specification. Colours may differ slightly from those shown. This brochure provides a general indication of the range of models, features, optional extras and/or colours available in various countries. Some of the models, features, optional extras and/or colours shown may not be available in your country or may only be available in a different specification. Additionally, some models, features, optional extras and/or colours may only be available in combination with others. For current and more specific information in relation to the range of models, features, optional extras and/or colours available in your country, and their pricing, you should contact your nearest authorised Mercedes-Benz Retailer. E&OE. www.mercedes-benz.co.uk

