

S-Class



Mercedes-Benz



The definition of a luxury saloon



Since the beginning of the 20th century, our cars have captivated successive generations of drivers with their elegant style and exceptional quality.

The S-Class in particular has helped to shape the face of luxury motoring. Its direct line dates back to 1951 and the inaugural Frankfurt Motor Show, where Mercedes-Benz presented its new 6-cylinder 220 saloon, a car whose effortless performance and impressive levels of equipment set the tone for a whole series of great luxury saloons.

The first of these to be officially designated 'S-Class', the W116 range, was launched in 1972. Since then, the name has stood for exceptional comfort, innovative technology and, of course, ground-breaking safety systems. Crumple zones, ABS, ESP® and the airbag, for instance, all made their debut in an S-Class – and went on to become the norm for cars of all makes and sizes. And although that alone means its place in the history books is assured, the S-Class continues to lead the way – with new technology and ever higher standards of luxury.





First impressions

For generations, the S-Class has set the standard for modern motoring – with innovations in the fields of comfort, safety and environment-friendly technology that have made it a benchmark for automotive progress. The latest S-Class continues that tradition, achieving lower levels of emissions across the engine range, setting new standards for occupant protection, in-car entertainment and driver assistance, and, of course, wrapping it all in an elegantly contemporary exterior. Rediscover a motoring icon – with the current S-Class.

Overview | page 4 Insights | page 16

S-Class

Facts

Refined pleasures: Engines and suspension	from page 19
Optimum protection: Safety	from page 29
Stress-relief: Comfort	from page 33
An S-Class for every need: Long-wheelbase version	from page 45
Powerful AMG models: S 63 AMG L and S 65 AMG L	from page 51
Your S-Class: Standard equipment, optional extras	from page 57
More Mercedes-Benz: Services	from page 75
The S-Class in figures: Technical data	from page 78





Efficiency | More enjoyment from less

Often the most impressive accomplishments are those where much is achieved with comparatively little. In driving, that means delivering the maximum amount of pleasure, while minimising the energy required. As a standard-bearer for automotive progress, the S-Class is, of course, leading the way - with enhanced efficiency across the engine range. → page 19



Composure | Every journey made effortless

Each new road poses a different set of challenges. Where one is fast, open and endlessly straight; the next may twist, wind and climb. The key is being able to take every situation equally in your stride – with a car that helps you to stay calm and in control, whatever the journey may bring.



Relaxation | Calm meets concentration

Even breathing, a steady pulse and a clear head are the unmistakable signs of a relaxed driver. And the best way to ensure a relaxed driver is to reduce the potential for danger. In the S-Class, almost a hundred sensors and a range of intelligent on-board assistants do exactly that. → page 29



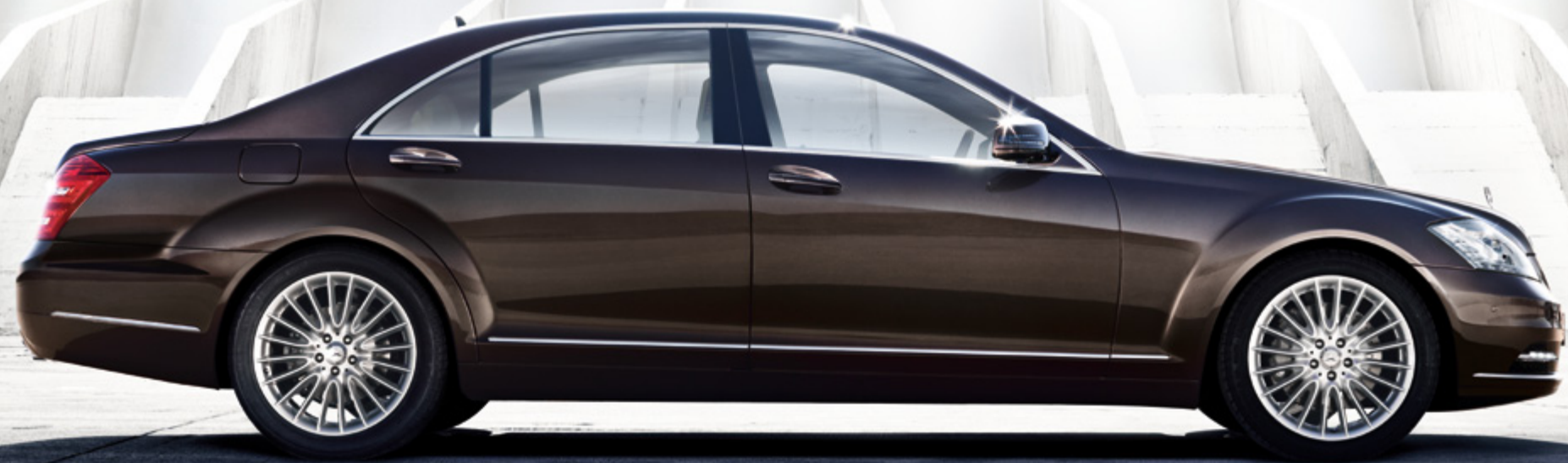

Comfort | Seats that seem made for you

The human form is built for walking – and yet nowadays most of us spend as much if not more time sitting. Which is why ergonomic and highly adjustable seats are so important. But as people come in all shapes and sizes, wouldn't it be even better if the seat could change shape to suit its occupant? Try an S-Class with dynamic multi-contour seats and judge for yourself. → page 43







Reassurance | A watchful companion

Back when our first motor car was built, all its driver had to look out for were carts, carriages and pedestrians. Today's fast-moving traffic, however, requires rather greater attention. Thankfully, the S-Class comes with a range of vigilant electronic systems that help you to spot and avoid danger, wherever it may come from. → page 39





Emotion | The essential ingredient

“I feel, therefore I am...”. In times when even cars can think, it’s the emotional experiences that count – the pleasure derived from an elegant shape, for instance, or the pride that comes from possessing it. For all its intelligence, the S-Class never fails to capture the heart.



Refinement | Power at its most cultured

To move a large mass, you need to exert a great deal of effort. Or so you might think. Then you discover how smoothly the S-Class performs, how efficiently it uses its power, and realise that sometimes a lighter touch can achieve just as much. → pages 21–24



Tranquillity | Just the whisper of tyre on tarmac

What do we hear when all is quiet? Our own heartbeat, perhaps?
The blood coursing through our veins? The S-Class is the perfect place
to find out.



Road Movie

Usually, the only thing front seat occupants get to watch is the road. And in the driver's case, that's as it should be. But what if you could have movie action on one side, while ensuring full concentration on the other – in other words, if two people could see different things on the same screen at the same time? Sounds like pie in the sky but, in fact, it's already possible – with the innovative SplitView system. Making its debut in the S-Class, it opens up a new dimension in visual display technology.

SplitView gives you two screens in one, enabling two different full-size images to be shown simultaneously on a single display unit. What you see depends solely on which side you're looking from. It means that, while the driver follows a route map from the navigation system, the passenger can explore far-off galaxies with George Lucas and Co.



19	BlueEFFICIENCY	29	Safer driving Attention Assist	33	Lights LED Light Package	45	Long-wheelbase version
20	Efficiency in the S-Class		Adaptive High Beam Assist		Bi-xenon headlamps	47	S 600 L
21	Diesel engine BlueEFFICIENCY diesel engine		Night View Assist Plus		LED tail lights	49	S-Guard
			Driving Assistance Package		Ambient interior lighting		
23	Petrol engines V6 petrol engine V8 petrol engine V12 petrol engine	31	Anticipating danger Pre-Safe® Brake and BAS Plus Pre-Safe® system	35	Multimedia systems COMAND SplitView Rear Seat Entertainment Package Bang & Olufsen BeoSound AMG		
25	Transmissions 7G-Tronic Plus 5-speed automatic transmission	32	Protecting occupants Neck-Pro head restraints Airbags	39	Electronic assistants Reversing camera Advanced Parking Guidance		
27	Suspension AirMATIC Active Body Control (ABC)			41	Automatic climate control		
				43	Seats Front Seat Comfort Package Rear Seat Comfort Package Rear Seat Memory Package		

The S-Class in detail



51 **AMG**

S 63 AMG L

AMG 5.5-litre V8 engine

AMG Speedshift MCT 7-speed
sports transmission

S 65 AMG L

57 **Standard equipment**58 **Optional extras**59 **AMG Sports Package**61 ***designo****designo* range*designo* Selection65 **Upholstery and trim**71 **Alloy wheels**73 **Retailer-fit accessories**75 **Services**Mercedes-Benz World
and Museum

Roadside Assistance

Mercedes-Benz Finance
and Insurance

Test drive

Interactive Owner's Manual

Finance offers

78 **Dimensions**79 **Technical data**81 **Paint finishes**

BlueEFFICIENCY – technology for more efficient driving



Our comprehensive BlueEFFICIENCY measures have already brought significant cuts in fuel consumption to many current Mercedes-Benz models, helping to lower both their CO₂ emissions and their running costs. What's more, we are continuing to develop new environmentally friendly technologies that will reduce emissions even further and help to make motoring more sustainable in the long term.

BlueEFFICIENCY – the Mercedes-Benz efficiency drive. In addition to highly advanced and efficient engines, BlueEFFICIENCY models come with a range of energy-saving measures that enable fuel consumption and CO₂ emissions to be reduced by up to 23%. These measures vary from model to model but can include ECO start/stop, on-demand ancillary components and low-resistance tyres, as well as aerodynamic optimisation and the use of lightweight materials.

BlueTEC – cleaner diesel power. BlueTEC is our cleanest diesel technology to date. Its combination of advanced common-rail direct injection, optimised combustion and modular emissions control systems reduces particulate levels by up to 95% and removes up to 90% of nitrogen oxides, leaving little but water, harmless nitrogen and the satisfaction of knowing you've done your bit for the environment.

HYBRID and BlueTEC HYBRID – the future of internal combustion. The next stage in our efficiency drive, hybrid drivetrains will bring new levels of fuel efficiency and emissions reduction to tomorrow's Mercedes-Benz passenger cars. The diesel equivalent, BlueTEC HYBRID, combines the benefits of hybrid drive with the clean-burn technology of BlueTEC.

BlueZERO – the drivetrains of tomorrow.

The BlueZERO concept showcases three highly developed electric vehicle variants. The E-CELL is an all-electric system driven solely by the battery, E-CELL PLUS pairs battery power with a range-extending internal combustion engine, while the F-CELL features a hydrogen-based fuel-cell stack.

Design for Environment. Our environmental philosophy is not just about in-car technologies. It also involves taking the entire lifecycle of each vehicle into account, from its initial planning to its end-of-life recycling. We apply the same approach to the building and maintenance of new factories too, saving energy, avoiding harmful emissions and making increasing use of renewable resources. In addition, Mercedes-Benz is involved in the development of alternative fuels and conducts research in the field of bionics.

For more information about what BlueEFFICIENCY can do for you, please visit www.mercedes-benz.co.uk/blueefficiency



Efficiency in the S-Class

The S-Class has always been at the forefront of technological development. Its latest innovations include fuel-saving BlueEFFICIENCY measures and standard-setting BlueTEC clean diesel technology.

The S-Class features a variety of environment-friendly technologies that help to achieve significant reductions in fuel consumption and emissions. These efficiency-enhancing

measures don't just extend to the engines either. Aerodynamic improvements, low-resistance tyres and intelligent energy management all further reduce fuel consumption and CO₂

emissions. In addition, the range now includes one of the world's cleanest diesels: the new S 350 BlueTEC with exhaust gas aftertreatment.



- 1 Tyres designed for lower rolling resistance
- 2 EU5 compliance for V6 and V8 petrol engines
- 3 Aerodynamic exterior mirror casings
- 4 Fuel-saving steering pump
- 5 Car always starts with transmission in 'E' (economy mode)
- 6 Sealed joints around headlamps for improved aerodynamics
- 7 One of the world's cleanest diesel engines (S 350 BlueTEC meets EU6 emissions standards)

Actual specification varies according to model



BlueTEC diesel engine

The fuel-efficient S-Class diesel engine is powerful, refined and now cleaner than ever.

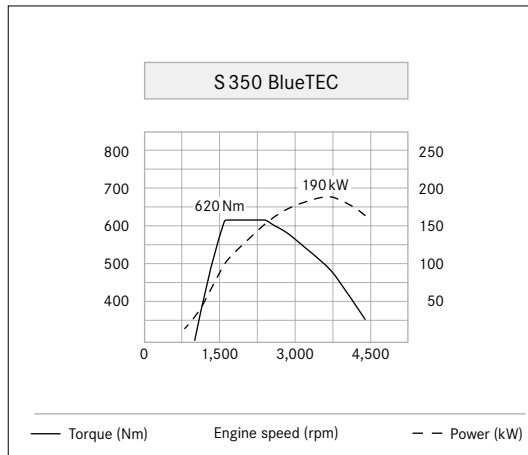

620 Nm of torque is available from 1,600 to 2,400 rpm

V6 diesel engine with BlueTEC technology.

The new S 350 BlueTEC combines outstanding fuel efficiency with exceptionally low exhaust emissions. Its environmentally friendly technology includes a system of exhaust gas aftertreatment that ensures it already meets

tomorrow's EU6 emissions standards today, making it one of the cleanest diesels in the world. In addition, the S 350 BlueTEC offers effortless performance, thanks to an output of 258 hp (190 kW) and 620 Nm of torque.



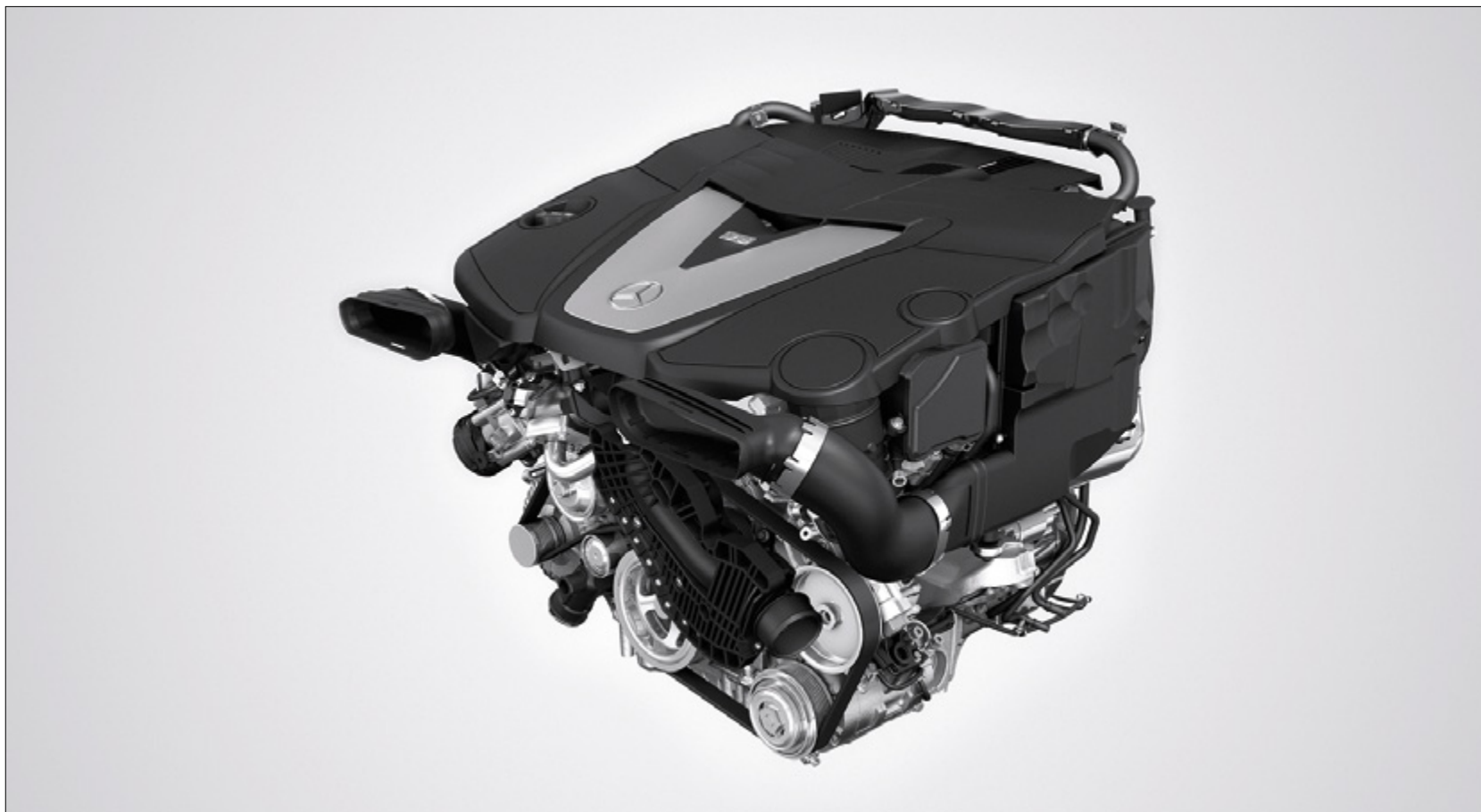

The S 350 BlueTEC boasts one of the world's cleanest diesel engines



Petrol engines

Powerful and yet easy on the environment, the S-Class petrol engines combine impressive outputs with even lower fuel consumption and CO₂ emissions. The innovative V6 and V8 engines with direct petrol injection set new standards for efficient performance, while the S 600's optimised V12 now meets strict EU5 regulations on exhaust emissions.

V6 petrol engine. The new V6 for the S 350 BlueEFFICIENCY features spray-guided direct petrol injection via piezo injectors, four valves per cylinder and variable camshaft control.

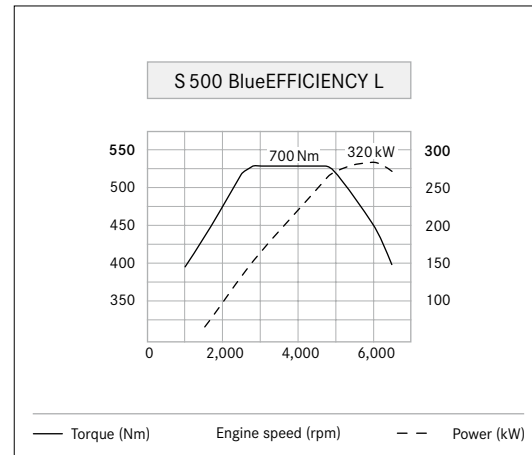

High torque even at low revs

As a result, it delivers increased refinement, greater fuel efficiency and lower CO₂ emissions, despite boasting an impressive 306 hp (225 kW), plus 370 Nm of torque at 3,500 rpm.

V8 petrol engine. The all-new S-Class V8 not only uses 19% less fuel than its predecessor, it also offers significantly improved power and torque, thanks to the addition of intercooled twin turbochargers. With an output of 435 hp (320 kW) plus 700 Nm at just 1,800 rpm, it gives the S 500 BlueEFFICIENCY L exceptionally rapid acceleration and effortlessly responsive performance at any speed. In addition, both the V6 and V8 models come with a fuel-saving ECO start/stop function that cuts the engine when standing at traffic lights.

V12 petrol engine. With its intercooled twin turbochargers and 60-degree V12 layout, the S 600's innovative engine offers superlative performance, exceptional refinement and a sublime sound. It has a maximum output of 517 hp (380 kW), delivers a spectacular 830 Nm of torque from 1,800 rpm and accelerates from 0 to 62 mph in just 4.6 seconds.



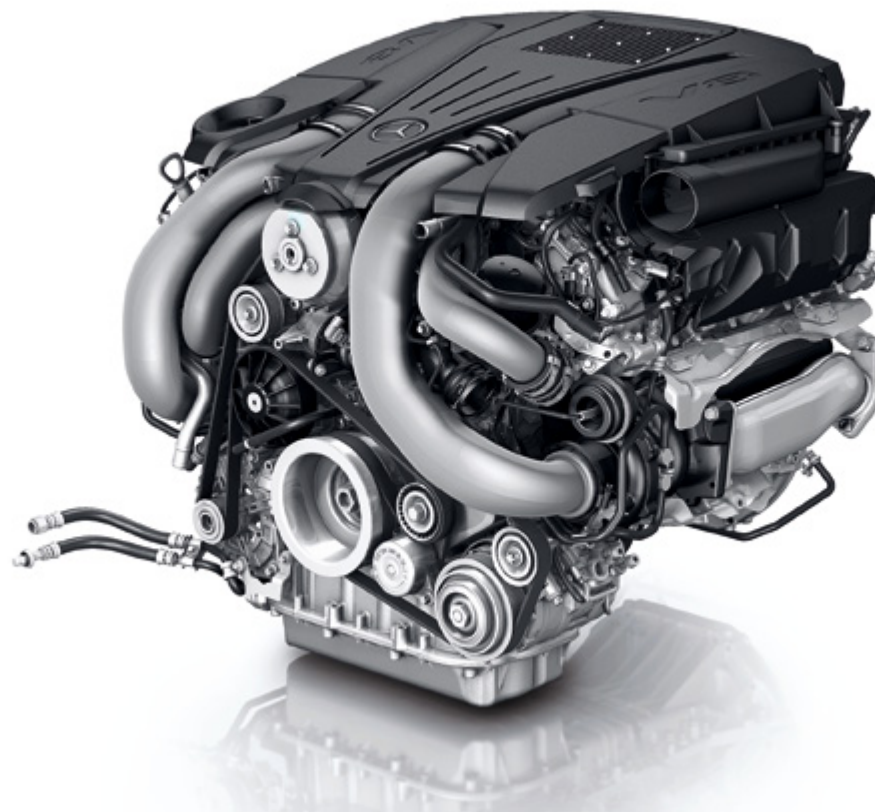

State-of-the-art technology: the new petrol V8 features high-pressure direct injection via piezo injectors



Transmissions

The S-Class transmissions are perfectly matched to its engines – and let you choose the right mode for your mood.



The Direct Select gear shift lever on the steering column

7G-Tronic Plus. The V6- and V8-engined S-Class models now come with 7G-Tronic Plus automatic transmission, a new version of our 7G-Tronic system that delivers even greater fuel efficiency. Its seven forward gears ensure the engine is always operating at the optimum speed, helping to reduce fuel consumption, while the short, slick shifts make for smoother, quieter driving. The transmission is controlled via the Direct Select gear shift lever on the steering column, while a separate set-up switch enables you to choose between manual, economy and sport modes. In manual mode,

you can also change gear using racing-style steering wheel shift paddles.

5-speed automatic transmission. The perfect partner for the S 600's V12, the 5-speed automatic transmission offers rapid and barely perceptible gear shifts and ensures optimum acceleration in any situation. It also gives you the option of changing gear manually.



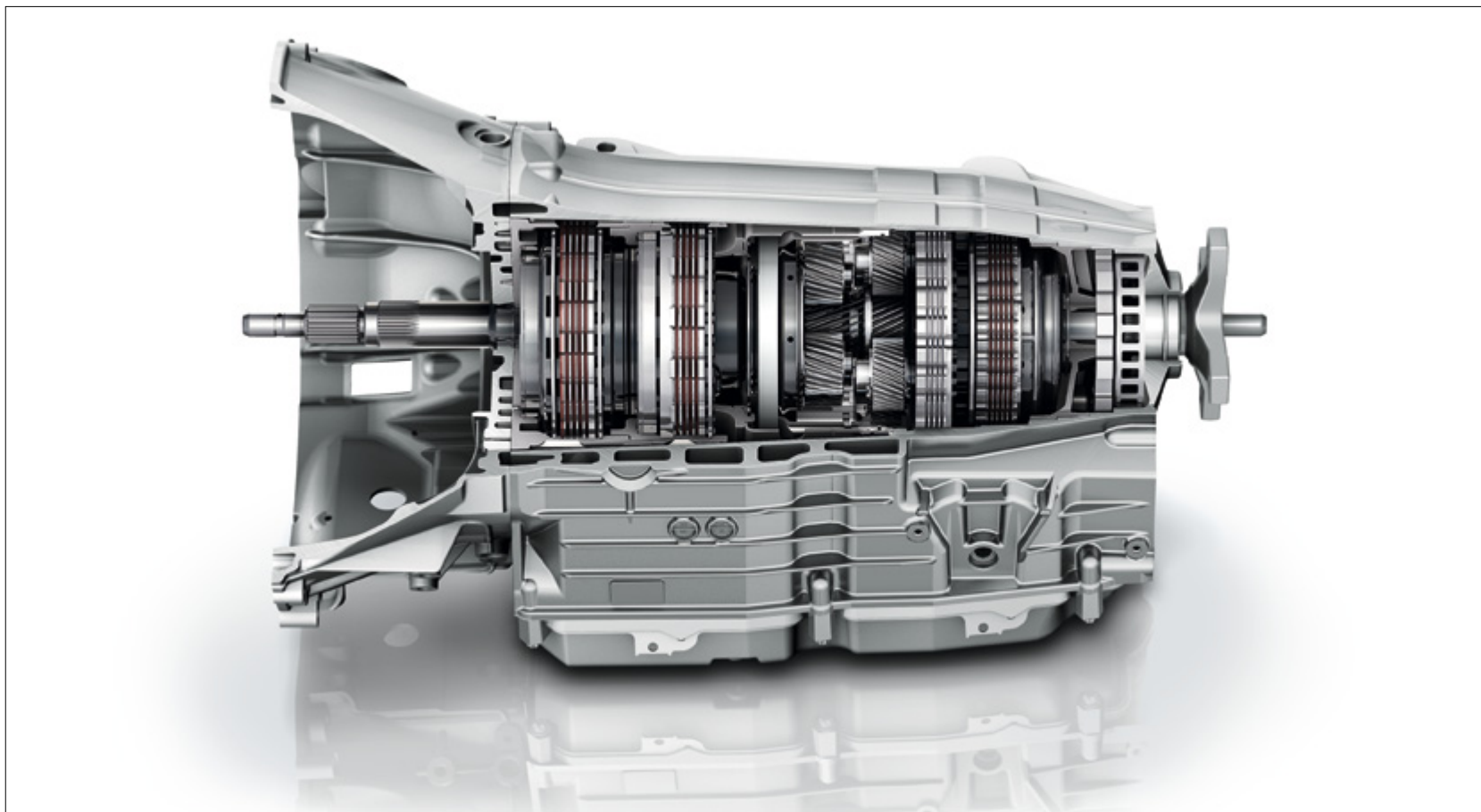

7G-Tronic Plus: the result of more than 50 years' experience in transmission technology



Suspension

Thanks to intelligent suspension technology, the S-Class guarantees supreme comfort on every surface.

The standard AirMATIC air suspension system optimises ride comfort and agility by constantly adapting to your driving, giving you firmer damping when pressing on and softer settings during more relaxed driving.

¹Not available on S 350 BlueTEC and S 350 BlueEFFICIENCY

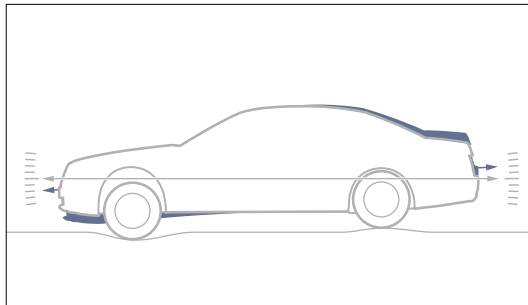

AirMATIC offers an ideal blend of surefooted handling and smooth ride

For an even more composed ride, there's Active Body Control (ABC).¹ It uses microprocessors to adjust each strut as the situation requires, enabling it to compensate automatically for body roll and pitch. It also helps to limit squat and dive when accelerating and braking.

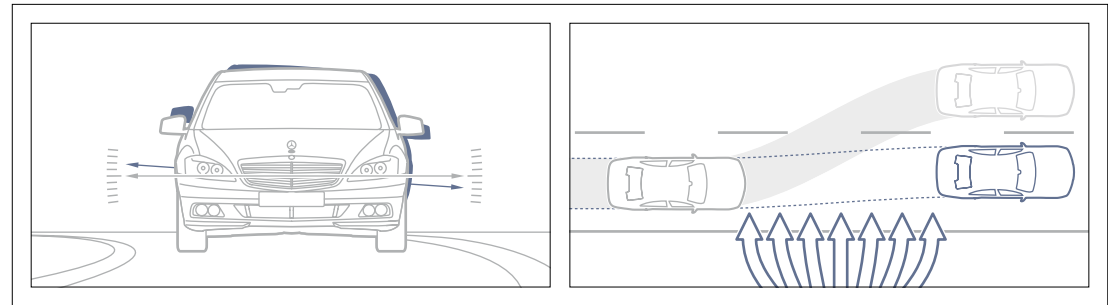

Active Body Control gives the S-Class an even more agile feel. It also compensates for strong crosswinds by adjusting the load distribution between the wheels



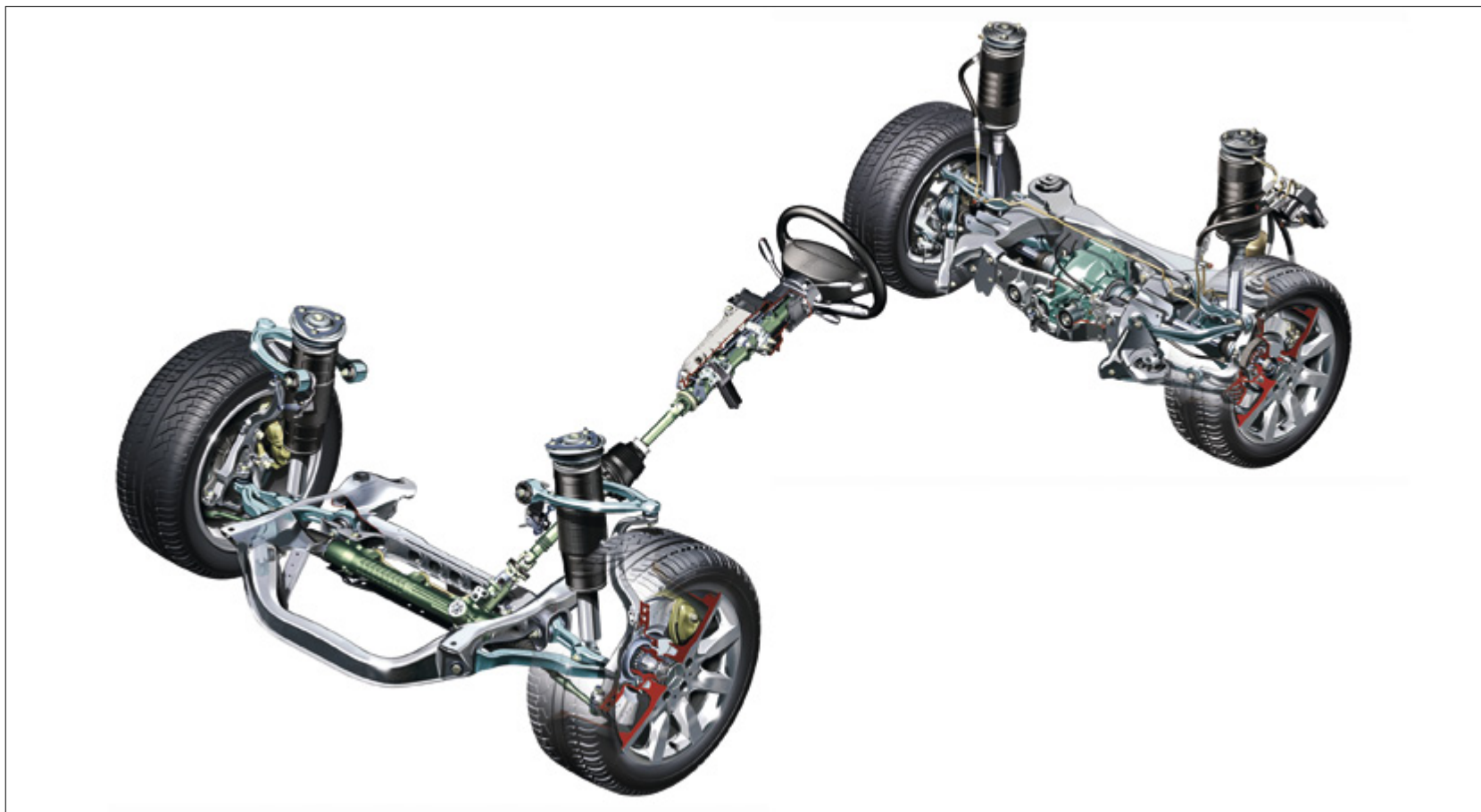

The optional Active Body Control (ABC) suspension in detail



Safer driving

The S-Class comes with a range of electronic assistants that reduce the risk of accidents by helping you to spot and avoid danger in advance.

Attention Assist (standard). Particularly beneficial on long journeys, Attention Assist is a system for detecting fatigue. Between speeds of approximately 50 and 110 mph, it assesses the driver's behaviour via an array of sensors and registers unexpected changes that may indicate tiredness, such as involuntary movements of the steering wheel.



If it detects signs of fatigue, Attention Assist suggests taking a break

Adaptive High Beam Assist (standard). Adaptive High Beam Assist ensures you enjoy optimum visibility at night without dazzling other drivers. It automatically dips the headlamps when there's oncoming traffic or vehicles ahead and then raises them again when the road is clear. What's more, the transition between main beam and dipped is smooth and almost imperceptible to the driver.

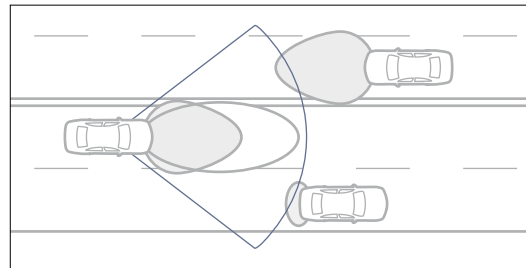

With Adaptive High Beam Assist, the transition between main beam and dipped is almost imperceptible

Night View Assist Plus (optional). This infrared camera system captures the entire area that would be illuminated on main beam and shows a black-and-white image in the instrument cluster. In situations where switching to main beam is not appropriate, Night View Assist Plus ensures you have a clearer picture of the road ahead, enabling you to react faster to potentially dangerous situations.

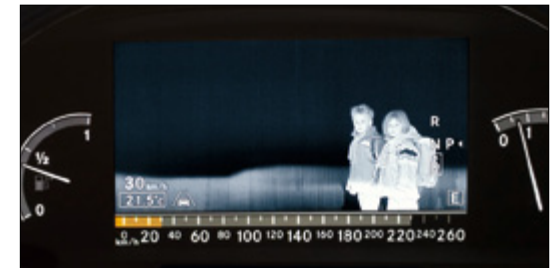

Night View Assist Plus helps drivers to spot pedestrians by highlighting them on the screen



Driving Assistance Package (optional).

The Lane-Keeping Assist function, which comes as part of the optional Driving Assistance Package, monitors lane markings via a camera and, by gently vibrating the steering wheel, warns the driver should they unintentionally wander out of lane. If the lane change is intentional, on the other hand, the system recognises this and does not emit a warning.

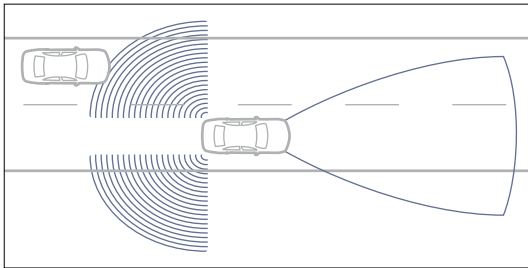

The Driving Assistance Package includes features such as Active Lane-Keeping Assist and Active Blind Spot Assist

Thanks to Blind Spot Assist, the package makes intentional lane changes safer too, using twin radar sensors to watch over the areas not visible in your exterior mirrors. If the sensors spot a vehicle in one of these blind spots, a red triangle lights up in the corresponding mirror. If the driver nevertheless indicates to change lanes, an additional warning signal sounds.



Active Blind Spot Assist warns the driver of potentially dangerous lane changes

Also included as part of the Driving Assistance Package is Distronic Plus, our radar-assisted cruise control system. It enables the S-Class to automatically maintain a preset distance from the vehicle in front, meaning less work for the driver, both in high-speed driving and stop/start traffic. In the event of an imminent front-end collision, the Pre-Safe® Brake can automatically intervene to slow the car before any impact.

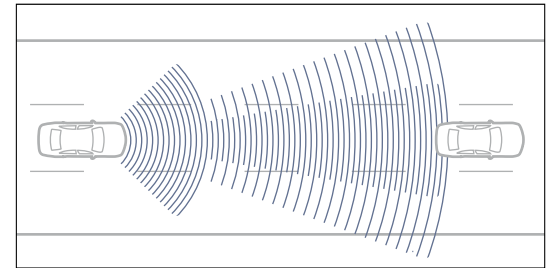

Distronic Plus radar-assisted cruise control helps the driver to maintain a safe distance from the vehicle in front



Anticipating danger

Sometimes critical situations prove unavoidable. Thankfully, the S-Class is equipped with anticipatory safety systems that can reduce the severity of an impact and even help you avoid an accident altogether.

Pre-Safe® Brake and BAS Plus (part of optional Driving Assistance Package). If it detects the risk of a collision, Pre-Safe® Brake alerts the driver via visual and audible warnings. At the same time, BAS Plus assesses the brake force required in order to avoid an impact. If the driver applies the brakes but uses insufficient force, BAS Plus automatically raises the braking pressure to a level that exploits the remaining stopping distance to the full, thereby also lessening the likelihood of a shunt from behind.

Should the driver fail to react to Pre-Safe® Brake's warning signals, it slows the car automatically, providing a further warning, and triggers a range of Pre-Safe® measures.

If the driver still doesn't respond, the system then initiates autonomous emergency braking, enabling the speed and severity of any impact to be significantly reduced.

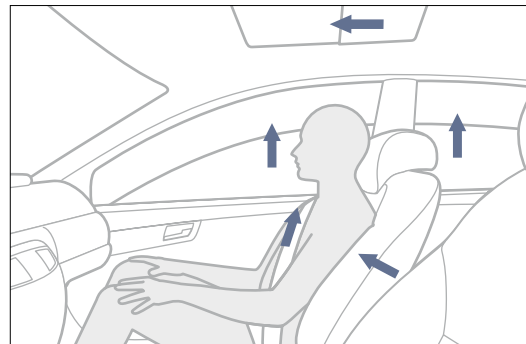

The Pre-Safe® anticipatory safety system can help to reduce the consequences of an accident

Pre-Safe® system (standard). If it detects a probable accident situation, Pre-Safe® can take anticipatory measures to protect the occupants, such as activating the seat belt tensioners, automatically closing the windows and sunroof (if fitted), and moving the passenger seat to a better position for an impact.



Protecting occupants

The S-Class optimises safety even if an accident proves unavoidable, initiating measures during and immediately prior to an impact than can reduce the risk of injury to its occupants.

Neck-Pro head restraints (standard). Fitted to both front seats, the Neck-Pro head restraints automatically move forwards and upwards in the event of a rear-end collision.

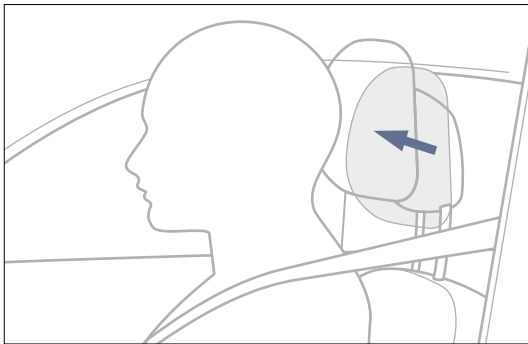

The Neck-Pro head restraints reduce the risk of whiplash in a rear-end collision

This enables them to support the head sooner and reduce strain on the spine.



Up to nine airbags help to protect you and your passengers in the event of an accident

Airbags (standard). In 1981, the S-Class became the first passenger car to be fitted with an inflatable protective cushion for the driver – just one of many S-Class safety innovations. From 1985, front seat passengers also benefited from this highly effective form of occupant protection. Today, the S-Class is fitted as standard with nine different airbags: dual-stage front airbags, sidebags in both front seats and windowbags. Plus there's the driver's side kneebag that can enhance knee and leg protection in certain types of accident. Finally there are rear sidebags that further reduce the risk of injury to children or other passengers in the rear.



Lights

The S-Class comes with safety-enhancing lighting technologies and LED daytime running lights that lend it an even more striking look.

Intelligent Light System (standard). The S-Class comes with chrome-trimmed LED daytime running lights that add a high-tech touch to the S-Class exterior. They are fitted as part of the Intelligent Light System, which also includes

bi-xenon headlamps, the Active Light System and Adaptive High Beam Assist. In addition, the system can automatically adopt special lighting modes for specific situations or conditions, such as country roads, motorways and fog.



The LED tail lights add a strikingly modern look



The LED Light Package includes bi-xenon headlights, LED daytime running lights and the Intelligent Light System (standard)



Ambient interior lighting (optional, standard on S 600 L and S 65 AMG L). Ambient interior lighting stylishly accentuates the cabin design when driving at night. Its LEDs come on as soon as the driver opens the door and make the cabin feel even roomier and more welcoming. Once the door is closed, the LEDs are automatically dimmed to the preset level selected in the COMAND multimedia system. There are five brightness levels to choose from, as well as three different colours: polar (ice blue), solar (amber) and neutral (white).



The ambient interior lighting comprises a narrow band of LEDs running around the doors and dashboard. It is dimmable and offers a choice of three colour settings



Multimedia systems

The S-Class comes with Bluetooth® connectivity, USB and SD card interfaces and can be fitted with additional multimedia technology.

COMAND multimedia system (standard). The COMAND system combines telephone, audio and video functions plus hard drive-based navigation in one easy-to-use unit. Its 6-disc DVD changer plays video and audio CDs or DVDs and offers MP3 playback. In addition, COMAND enables you to store up to 2,500 songs on the hard drive and search its music library by title

or artist, ensuring you can find the desired track quickly and easily. All information is presented on a central colour screen, which can even display maps in 3D. COMAND also includes a **Media Interface** which allows full integration and control of external media devices.

Harman Kardon Front Seat Entertainment Package with SplitView (optional; standard on S 600 L). The 14-speaker Harman Kardon® Logic 7® surround sound system, which comes as part of the Harman Kardon Front Seat Entertainment Package, includes a 13-channel DSP amplifier, a DAB digital tuner and an integral subwoofer.



COMAND controller in the centre console

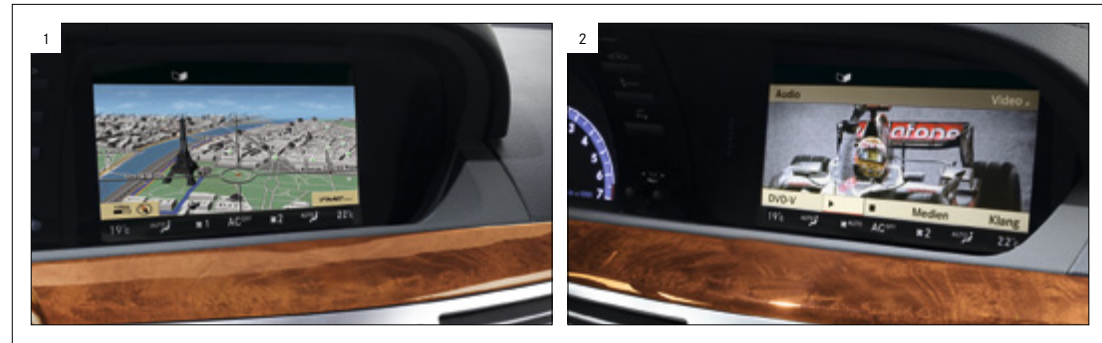

SplitView enables the screen to simultaneously display different images for the driver (1) and the front seat passenger (2)



Specially tailored to the S-Class cabin, it delivers crystal-clear 3D sound in Dolby Digital 5.1. The package also includes the innovative SplitView function. This enables the driver and front seat passenger to view different full-size images on the same screen, meaning the passenger can watch a DVD while the driver continues to use the navigation system.



In the back of the front head restraints are twin 8-inch screens

Bang & Olufsen Front Seat Entertainment Package with SplitView (optional; standard on S 65 AMG L). Alternatively, you can enjoy the benefits of SplitView technology together with the specially developed Bang & Olufsen BeoSound AMG audio system (see page 37 for more details).



The 600-watt Harman Kardon® Logic7® surround sound system guarantees a first-class listening experience

Rear Seat Entertainment Packages (optional). The S-Class offers two Rear Seat Entertainment Packages, one featuring the Harman Kardon® Logic7® surround sound system, the other with the Bang & Olufsen BeoSound AMG system, both with DVD drive, twin 8-inch TFT colour screens, wireless headphones, two aux-in sockets for external devices, and a remote control.

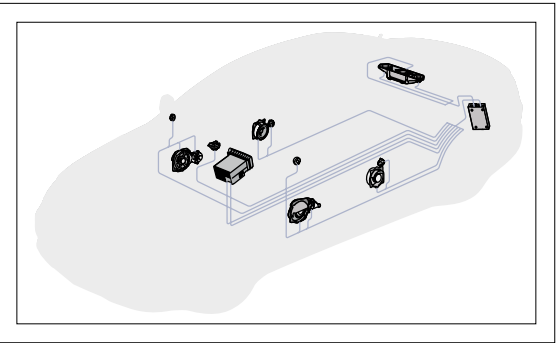

Bang & Olufsen BeoSound AMG audio system

Enjoy concert-hall surround sound in your S-Class – with the specially developed BeoSound AMG audio system.

The new, optional BeoSound AMG system by Danish audio experts Bang & Olufsen is a masterpiece of acoustic and aesthetic excellence. Its 15 high-performance speakers deliver a total output of 1,200 watts and an

exceptionally spacious sound that's more concert hall than car interior. What's more, they look as exclusive as they sound, thanks to eye-catching matt aluminium speaker and tweeter grilles in all four doors and a match-

ing grille for the rear parcel shelf subwoofer. Illuminated acoustic lenses, with one in each of the front door mirror panels and two rear passenger compartment lenses are integrated into the B-pillars.



With their high-quality grilles, the Bang & Olufsen speakers look just as good as they sound



Using the COMAND multimedia system, the sound can even be focused on the front or rear of the car, ensuring you enjoy perfect acoustics whether you're driving or being driven. In addition, the closed speaker

cabinets enhance sound definition and minimise dispersion, meaning both your music and your hands-free phone calls remain inside the car.



The illuminated acoustic lenses are especially striking at night

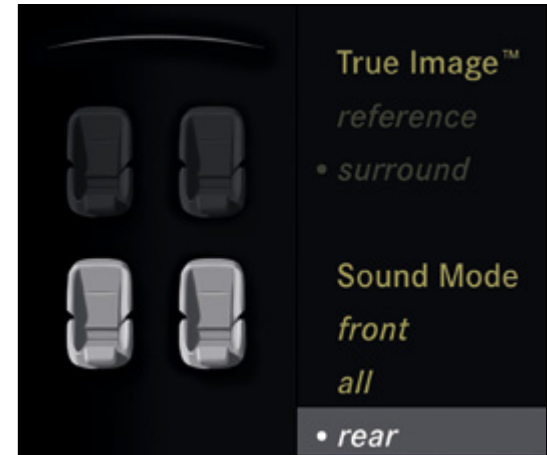

The sound can be adjusted to suit your listening habits – and your seating position too



Electronic assistants

Numerous electronic assistants help to make driving the S-Class safer and more relaxing.



The **reversing camera** (optional, standard on S 600 L and S 65 AMG L) makes for safer and easier parking manoeuvres. Fitted below the boot lid handle, this wide-angle camera captures the area immediately behind the car and displays the image on the COMAND multimedia system's screen. The camera is activated automatically as soon as the driver engages reverse.

The reversing camera's wide-angle lens enables you to see what's immediately behind the car



Advanced Parking Guidance (standard).

By measuring gaps via ultrasound sensors, Advanced Parking Guidance can help the driver manoeuvre into tight spaces. If the sensors detect a suitably sized space, the situation is depicted graphically in the multi-function

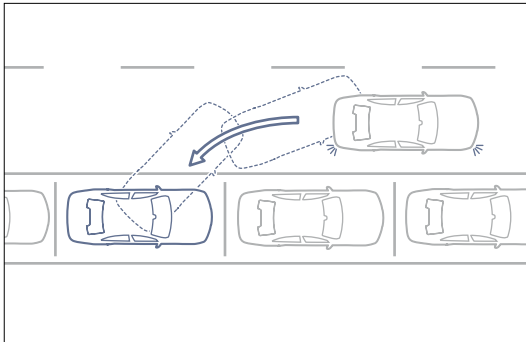

Advanced Parking Guidance assists when manoeuvring

display. The set of red lines shows the current steering angle, the yellow lines represent the required angle. As soon as the two correspond, the lines turn green. In addition, the system will also illustrate the distance from any objects in the car's vicinity when manoeuvring.

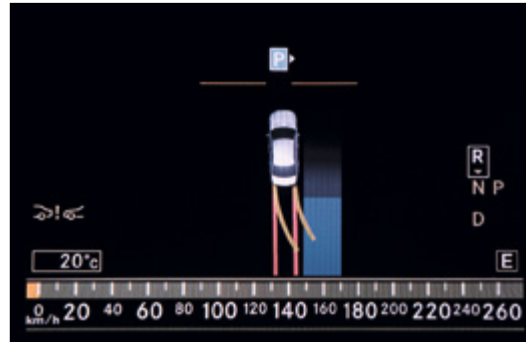

Reassuring support courtesy of Advanced Parking Guidance



Luxury automatic climate control

The right cabin climate enhances your comfort and helps you stay focused. The S-Class climate control system features four individually variable temperature zones in the front, with a further two for the rear available as an option.

The S-Class comes with a luxury automatic climate control system that enables the driver and front seat passenger to select their own



Your ideal temperature at the push of a button

separate settings. Its sensors monitor the temperature inside and outside the cabin and ensure the preset temperature for each zone is



The optional rear seat climate control unit

maintained at all times, even in strong sunlight. In addition, there's a choice of three different air flow modes – diffused, medium and focused – and an activated charcoal filter that ensures only clean air enters the cabin. Front seat occupants can also increase or decrease the air temperature in the footwells independently of their selected temperature settings.



For those in the rear, a two-zone control unit can be added as an option. Situated between the front seat backs, it enables separate temperature and air flow settings to be selected for the left and right side of the rear passenger compartment. As a result, each occupant can enjoy the right climate for them, ensuring maximum concentration for the driver, plus optimum comfort and safety all round.

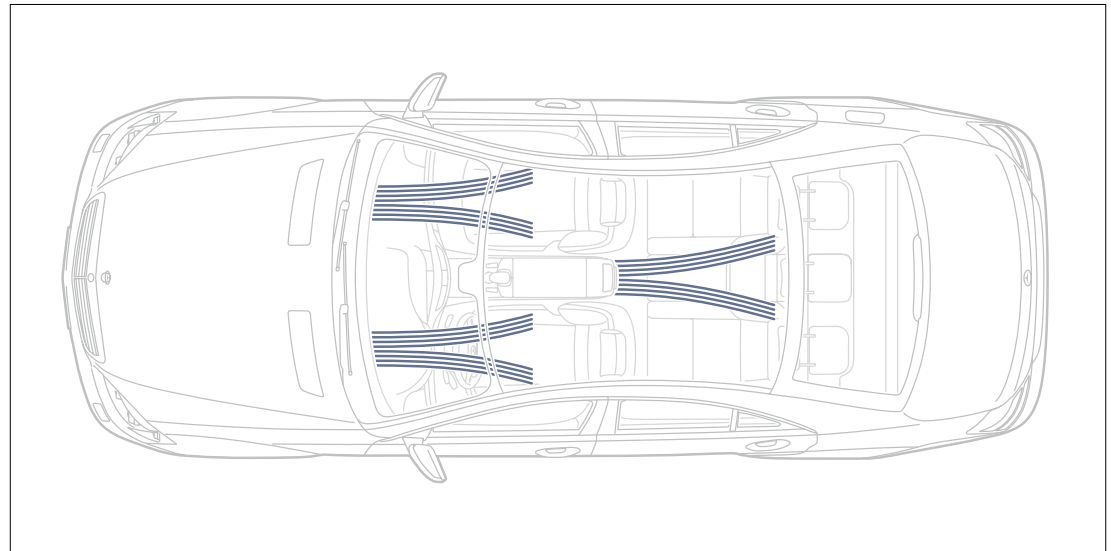

The cabin's independently variable temperature zones



Seats

The S-Class seats offer optimum comfort, ergonomics and safety – and are available with a range of option packages that make the journey even more relaxing.

Front Seat Comfort Package (optional).¹

The dynamic multi-contour seats with massage function offer outstanding long-distance comfort. Air chambers in the seats' lumbar and shoulder regions adjust to each occupant's individual body shape, while the side bolsters adapt automatically as you drive to ensure optimum support at all times, especially when cornering. They can even give their occupant a soothing massage. Simply select one of the massage function's four programmes and let the rolling motion of its seven chambers gently stimulate your back muscles. It's not only highly relaxing, it can also help you feel more focused and alert.

Front comfort head restraints complete this sense of well-being: adjustable for both height and angle, they also feature individually adjustable side bolsters for a snug fit.

¹ Standard on S600 L, S63 AMG L and S65 AMG L



Dynamic multi-contour front seats with massage function





Multi-contour rear seats with massage function

Rear Seat Comfort Package (optional).²

Multi-contour seats with massage function adjust to suit the body shape of each individual occupant, deliver relaxing massages and come with comfort head restraints.

Rear Seat Memory Package (optional). Fitted together with electric adjustment,³ the rear seat memory function enables passengers in each of the outer rear seats to store their favourite position and recall it at the touch of a button.

² Standard on S 600 L and S 65 AMG L

³ Electrically adjustable rear seats are standard on long wheelbase models



Long-wheelbase version

For working or relaxing, the long-wheelbase S-Class is the last word in luxury and comfort.



The long-wheelbase S-Class



The long-wheelbase S-Class offers even greater legroom and luxury for those in the rear. It not only has an extra 13 centimetres between the axles, it also comes equipped to the very highest standards, with exclusive items such as heated leather seats for the front and rear, electric adjustment for the outer rear seats and a full-width rear window blind. A tilting/sliding electric sunroof is also fitted as standard.

Among the options are twin individual rear seats, a panoramic glass sunroof, and the Rear Seat Entertainment Package.

Mechanically adjustable folding tables and a second telephone handset in the rear centre armrest can also be added – they turn the



Rear seat passengers benefit from extra legroom

long-wheelbase S-Class into a supremely comfortable mobile office.



All occupants enjoy a highly exclusive cabin ambience



S 600 L

Luxurious appointments and intelligent technology make the S 600 L one of the most relaxing ways to travel.

Even from the outside, exclusive design details set the S 600 L apart, such as a redesigned chrome-trimmed grille with three twin louvres, 18" 5-spoke alloy wheels in V12 design and V12 badges on the front wings, as well as model-specific split twin tailpipes and a chrome trim strip at the rear.



The V12 logo appears in the instrument panel on ignition

Inside, sumptuous Exclusive Passion leather upholstery adorns the seats, door centre panels, centre console and dashboard. The A-, B- and C-pillars and roof lining are all trimmed in *designo* Alcantara®, and there's Dark Burr Walnut trim for the doors, dashboard and steering wheel.



The split tailpipe design is exclusive to the S 600 L

Standard equipment for the S 600 L includes dynamic multi-contour front seats and multi-contour rear seats with massage function, reversing camera, Media Interface, Keyless-Go Package and ambient interior lighting with a choice of three colours, plus the Harman Kardon® Logic 7® surround sound system, which is fitted as part of the standard Front Seat Entertainment Package. In addition, this package features the COMAND multimedia system with SplitView and a DAB digital radio tuner.





The revised front end of the S 600 L with grille and LED lights



S-Guard

S-Class exterior, S-Guard safety: discover armoured protection at its most discreet. → www.mercedes-benz.com/guard

At first or even second glance, it's indistinguishable from a production model. Under the skin, however, the S-Guard is no ordinary S-Class – it's the ultimate in factory-integrated ballistics protection.

Each S-Guard is assembled on a strictly separated production line that combines high-tech manufacturing with skilled craftsmanship. Here, the S-Class passenger cell is completely reconfigured and an array of safety components

inserted to create a unique personal protection system. In addition, the brakes, suspension and electronic safety systems are all recalibrated to meet the specific needs of the S-Guard.

What's more, the S-Guard not only undergoes the same rigorous quality and safety testing as any Mercedes-Benz, it also has to meet the strict bullet and explosion resistance standards of internationally recognised independent authorities.

All this results in a factory-built armoured vehicle that combines S-Class elegance, refinement and comfort with the very highest levels of personal protection.



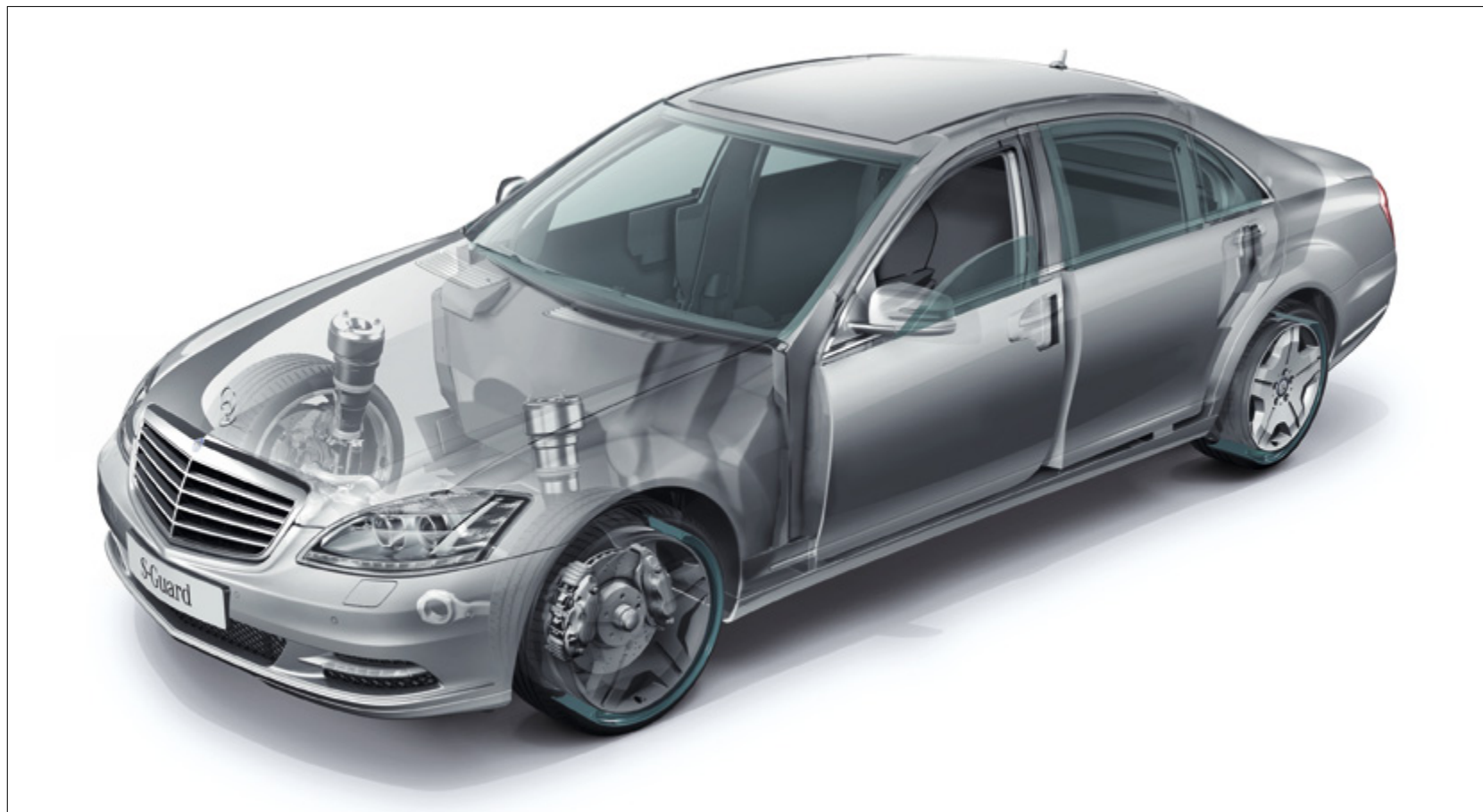

Optimum ballistics protection on the move: the S-Guard offers levels of quality and security that can't be achieved by retrofitting armour



S63 AMG L

Four-door luxury saloon? Or high-performance sports car? The S63 AMG L is both. → www.mercedes-amg.com



The S63 AMG L: outstanding performance and agility meets S-Class luxury



The exhilarating S63 AMG L is powered by a new 5.5-litre biturbo AMG V8 that delivers 544 hp (400 kW) and a maximum 800 Nm of torque. Its performance pedigree is obvious long before you turn the key, thanks to AMG bodystyling that includes a muscular front apron with LED



AMG sports seats with AMG-design Passion leather upholstery and natural leather side bolsters

daytime running lights and a diffuser-style rear apron. There are also eye-catching 19" AMG 5-triple-spoke design alloy wheels as standard.

For an even more dynamic driving experience, the optional AMG Performance Package ups the



AMG sports exhaust system with chromed twin tailpipes

engine's output to 571 hp (420 kW) and increases peak torque to 900 Nm, while the AMG Performance Studio offers styling options such as 20" AMG forged alloy wheels in polished Titanium Grey.



20" AMG forged alloy wheels



S63 AMG L - technology

The S63 AMG L combines exhilaration with efficiency – thanks to its AMG 5.5-litre biturbo V8 and AMG Speedshift MCT 7-speed sports transmission.

AMG 5.5-litre V8. The S63 AMG L's biturbo AMG V8 is not just impressively powerful, it's also exceptionally fuel-efficient. Despite delivering 544 hp (400 kW) and 800 Nm – 571 hp (420 kW) and 900 Nm with the optional AMG Performance Package – it achieves a class-leading 26.9 mpg on the combined cycle. This remarkable efficiency is the result of advanced technologies such as direct petrol injection, twin turbochargers and regenerative braking, combined with a transmission featuring a Controlled Efficiency mode with start/stop function. As you'd expect from an AMG engine, this high-tech V8 nevertheless delivers a satisfyingly rich and powerful sound.



The new AMG 5.5-litre biturbo V8 offers up to 571 hp and 900 Nm of torque with the optional AMG Performance Package



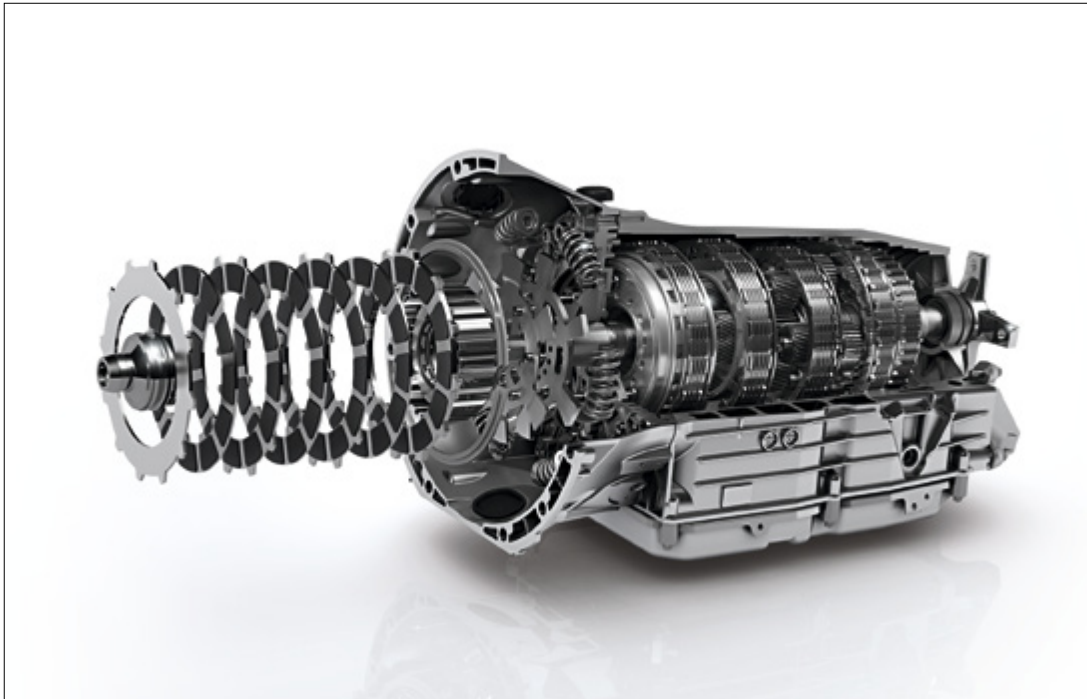

AMG Speedshift MCT 7-speed sports transmission. Like the innovative engine it accompanies, the S 63 AMG L's AMG Speedshift MCT transmission combines the best of both worlds, blending the sporty, direct and involving feel of a manual transmission with the comfort and effortlessness of an automatic. Its Controlled Efficiency, Sport and Manual modes give you a choice of three different shift styles, while the kickdown function enables the transmission to shift straight from seventh gear to fourth, for instance – allowing you to exploit the engine's performance potential to the full.

The AMG Speedshift MCT 7-speed sports transmission delivers smooth yet rapid gear changes



S 65 AMG L

An exhilarating blend of performance and exclusivity, the S 65 AMG L is the most powerful AMG saloon ever built. → www.mercedes-amg.com



A high-performance saloon without equal: the S 65 AMG L



The S 65 AMG L is the most powerful S-Class and the most powerful AMG saloon of all time, with 612 hp (450 kW) plus 1,000 Nm of torque from its 6.0-litre bi-turbo AMG V12. The result is truly exhilarating performance, with 0 to 62 mph taking just 4.4 seconds.



The AMG sports steering wheel and AMG instrument panel

Channelling all that power to the road is the AMG Speedshift 5-speed automatic transmission. In addition to effortless automatic shifts, it gives you the option of changing gear manually via the AMG sports steering wheel's aluminium shift paddles.



AMG Black Piano Lacquer/Carbon interior trim, available from the AMG Performance Studio

From the outside, 20" forged AMG alloy wheels in Titanium Grey set the S 65 AMG L apart, along with an AMG sports exhaust system featuring two sets of AMG V12-specific twin tailpipes. For an even more exclusive look, simply add options from the AMG Performance Studio.



AMG sports seats upholstered in Exclusive Passion leather with AMG V12-specific diamond stitching



Standard equipment | Selection



Nappa leather-trimmed multi-function steering wheel



Attention Assist



Chrome-style electronic key



COMAND multimedia system with colour display



Bluetooth® connectivity in COMAND

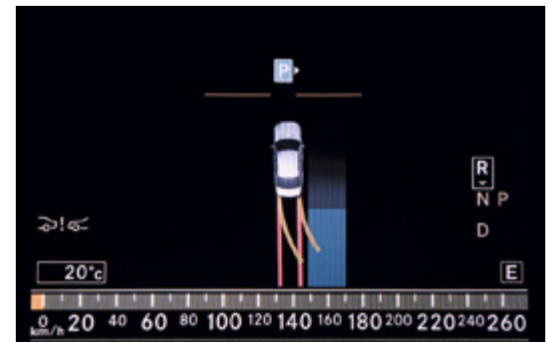

Advanced Parking Guidance



Optional extras | Selection



Rear Seat Entertainment Package



Folding rear work tables



Panoramic glass sunroof



Reversing camera¹

¹Standard on S 600 L and S 65 AMG L



Keyless-Go¹

²Standard on S 500 L, S 600 L, S 63 AMG L and S 65 AMG L



Front seat memory²

Individual features may be part of option packages and therefore may not be available as stand-alone options



AMG Sports Package

The optional AMG Sports Package makes for an even more eye-catching S-Class. → www.mercedes-benz.co.uk

The AMG Sports Package¹ lends the S-Class a highly dynamic look. Its AMG bodystyling comprises AMG front and rear aprons plus side skirts, and the package also adds burnished 19" AMG 5-spoke alloy wheels. Alternatively, 20" AMG 5-twin-spoke alloy wheels are available as a separate option.



Black Ash wood trim

Other additions include painted brake calipers with 'Mercedes-Benz' lettering and larger perforated brake discs for V6 models. Inside, there's Black Ash interior trim that's exclusive to the AMG Sports Package, a wood- and leather-trimmed steering wheel, AMG velour floor mats and brushed stainless steel sports pedals.



The striking AMG bodystyling rear apron

¹Not available for S63 AMG L and S65 AMG L





The AMG Sports Package gives the S-Class a more dynamic look



designo

Exclusive colours, exquisite upholsteries and the finest interior trim: *designo* options add an extra touch of individuality to your S-Class.

→ www.mercedes-benz.co.uk/designo

With beautifully crafted materials and a wide variety of colours, the *designo* range offers almost endless possibilities. Eye-catching

designo paint finishes add an exclusive touch to the exterior. For the interior, there's *designo* Exclusive Aniline leather, complemented by

carefully matched wood trim such as Black Piano Lacquer, with a gloss finish applied in up to ten layers, or stone trims made of finely



Door centre panels in Light Brown *designo* Exclusive Aniline leather (X35)



designo Natural Maple Grain wood trim (W64)



cut Norwegian granite. All *designo* S-Class upholsteries feature 10-rib vertical fluting and metal *designo* backrest badges, while the wood- and leather-trimmed steering wheel and Alcantara® roof lining further enhance the air of refinement.



Light Brown *designo* Exclusive Aniline leather upholstery (X35) combined with *designo* Natural Maple Grain wood trim (W64)



designo Selection

Available for the long-wheelbase models, the *designo* Selection Package creates a truly exclusive look. → www.mercedes-benz.co.uk/designo

There are two different ways to give your long-wheelbase S-Class the *designo* touch. You can create your own ideal combination from the wide range of high-quality appointments, or

make the decision easier with *designo* Selection, an option package that brings together all the most exclusive *designo* appointments.



designo Exclusive Aniline leather in Porcelain (X27) with *designo* Black Piano Lacquer trim (W69)



Wood- and leather-trimmed steering wheel with *designo* Black Piano Lacquer trim



In addition to your choice of *designo* exterior colour (*designo* metallic, *designo* mystic or *designo* magno), it adds *designo* Exclusive Aniline leather upholstery in your chosen colour, plus *designo* wood trim and a matching *designo* wood- and leather-trimmed steering wheel. The package also includes a roof lining in fluted *designo* Black nappa leather and a *designo* badge in solid 18-carat gold. Whether you opt for a harmonious colour scheme or striking contrasts, *designo* Selection makes a long-wheelbase S-Class even more special.

In the *designo* section of our website, you can browse through the colours and materials available and try out possible combinations.



designo logo in solid 18-carat gold



designo Exclusive aniline leather in Porcelain (X27)



Roof lining in fluted *designo* Black nappa leather



Upholstery and trim

Tailor the S-Class interior to your tastes – with your choice of colours, upholstery and fine wood trim.



Contrast top-stitching on the glove compartment

Passion Leather Package. This optional interior package for long-wheelbase models (standard on S 63 AMG L) comprises fine Passion leather upholstery with contrast top-stitching for the seats and armrests, plus high-quality Artico artificial leather with contrast top-stitching for the dashboard and door centre panels.

Exclusive Passion Leather Package. For an even more luxurious look, there's the Exclusive Passion Leather Package for long-wheelbase models (standard on S 600 L and S 65 AMG L). In addition to Passion leather upholstery with contrast top-stitching for the seats and armrests, it features fine Passion leather with contrast top-stitching for the dashboard, door centre panels, seat pockets, map pockets and parcel shelf, plus high-quality Alcantara® for the roof lining and trim on the A-, B- and C-pillars.



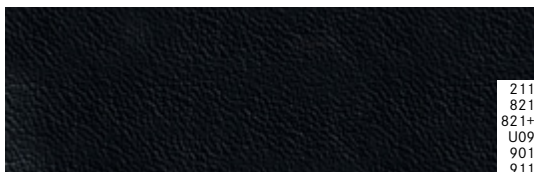

The Black/Black interior scheme features either standard leather or optional Passion leather upholstery, with black carpets and cabin trim (door, dashboard, centre console and steering wheel trim). For the long-wheelbase version, there's the option of the Passion Leather Package or the Exclusive Passion Leather Package.

BLACK/BLACK

- 211 Leather
- 821 Passion Leather
- 821+U09 Passion Leather Package
- 901 Exclusive Passion Leather Package
- 911 Exclusive Passion Leather Package (V12 models only)

TRIM

- H15 Dark Brown Eucalyptus (standard)¹
- 731 Dark Burr Walnut (gloss finish)²
- H14 Light Burr Walnut (gloss finish)
- H18 Brown Poplar (V12 models only)
- 736 Black Ash³

¹Excluding S 600 L and S 65 AMG L

²Standard on S 600 L and S 65 AMG L

³Standard with AMG Sports Package

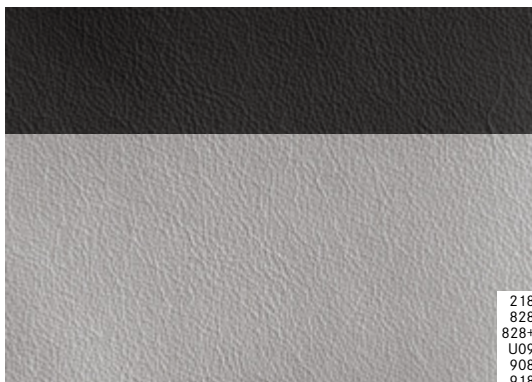

The Alpacas Grey/Basalt Grey interior scheme features Alpacas Grey leather upholstery, with matching door panels, lower dashboard trim, centre console and carpets. The steering wheel, upper dashboard trim and door caps come in Basalt Grey. As an option, this colour scheme is also available with Passion leather or with the Passion Leather Package or Exclusive Passion Leather Package (long-wheelbase versions).

ALPACA GREY/BASALT GREY

218	Leather
828	Passion leather
828+U09	Passion Leather Package
908	Exclusive Passion Leather Package
918	Exclusive Passion Leather Package (V12 models only)

TRIM

H15	Dark Brown Eucalyptus (standard) ¹
731	Dark Burr Walnut (gloss finish) ²
H14	Light Burr Walnut (gloss finish)
H18	Brown Poplar (V12 models only)
736	Black Ash ³

¹ Excluding S 600 L and S 65 AMG L

² Standard on S 600 L and S 65 AMG L

³ Standard with AMG Sports Package



The Cashmere Beige/Savanna Beige interior scheme features Cashmere Beige leather upholstery, with matching door panels, lower dashboard trim, centre console and carpets. The steering wheel, upper dashboard trim and door caps come in Savanna Beige. As an option, this colour scheme is also available with Passion leather or with the Passion Leather Package or Exclusive Passion Leather Package (long-wheelbase versions).

CASHMERE BEIGE/SAVANNA BEIGE

214	Leather
824	Passion leather
824+U09	Passion Leather Package
904	Exclusive Passion Leather Package
914	Exclusive Passion Leather Package (V12 models only)

TRIM

H15	Dark Brown Eucalyptus (standard) ¹
731	Dark Burr Walnut (gloss finish) ²
H14	Light Burr Walnut (gloss finish)
H18	Brown Poplar (V12 models only)
736	Black Ash ³

¹ Excluding S 600 L and S 65 AMG L

² Standard on S 600 L and S 65 AMG L

³ Standard with AMG Sports Package

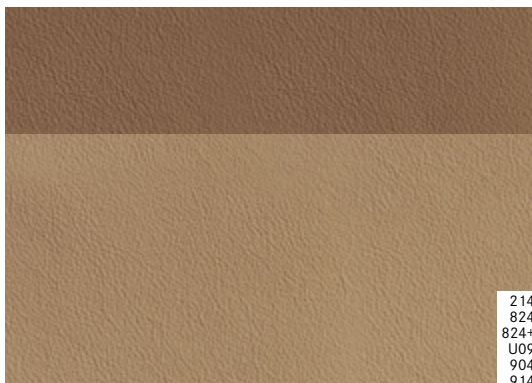

214
824
824+
U09
904
914



H15

731

H14

H18

736





The Sahara Beige/Black interior scheme features Sahara Beige leather upholstery, with matching door panels, lower dashboard trim, centre console and carpets. The steering wheel, upper dashboard trim and door caps come in Black. As an option, this colour scheme is also available with Passion leather or with the Passion Leather Package or Exclusive Passion Leather Package (long-wheelbase versions).

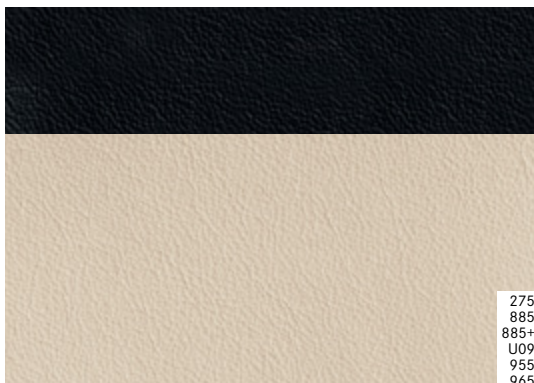

275
885
885+
U09
955
965



H15

731

H14

H18

736

SAHARA BEIGE/BLACK¹

- | | |
|---------|--|
| 275 | Leather |
| 885 | Passion leather |
| 885+U09 | Passion Leather Package |
| 955 | Exclusive Passion Leather Package |
| 965 | Exclusive Passion Leather Package (S 600 L only) |

TRIM

- | | |
|-----|---|
| H15 | Dark Brown Eucalyptus (standard) ² |
| 731 | Dark Burr Walnut (gloss finish) ³ |
| H14 | Light Burr Walnut (gloss finish) |
| H18 | Brown Poplar (V12 models only) |
| 736 | Black Ash ⁴ |

¹ Not available for S 63 AMG L and S 65 AMG L

² Excluding S 600 L and S 65 AMG L

³ Standard on S 600 L and S 65 AMG L

⁴ Standard with AMG Sports Package



The Chestnut Brown/Black interior scheme features Chestnut Brown leather upholstery, with matching door panels, lower dashboard trim, centre console and carpets. The steering wheel, upper dashboard trim and door caps come in Black. As an option, this colour scheme is also available with Passion leather or with the Passion Leather Package or Exclusive Passion Leather Package (long-wheelbase versions).

CHESTNUT BROWN/BLACK¹

274	Leather
884	Passion leather
884+U09	Passion Leather Package
954	Exclusive Passion Leather Package
964	Exclusive Passion Leather Package (S 600 L only)

TRIM

H15	Dark Brown Eucalyptus (standard) ²
731	Dark Burr Walnut (gloss finish) ³
H14	Light Burr Walnut (gloss finish)
H18	Brown Poplar (V12 models only)
736	Black Ash ⁴

¹ Not available for S 63 AMG L and S 65 AMG L

² Excluding S 600 L and S 65 AMG L

³ Standard on S 600 L and S 65 AMG L

⁴ Standard with AMG Sports Package

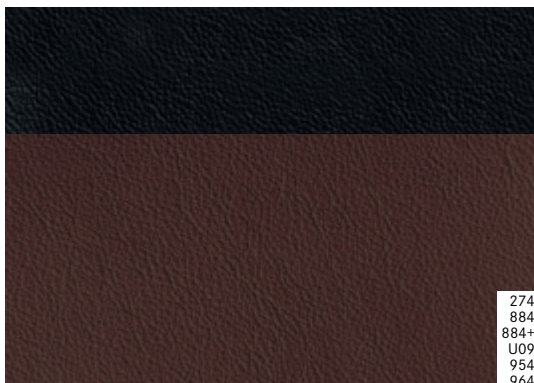

274
884
884+
U09
954
964



H15

731

H14

H18

736



Alloy wheels



18" 5-spoke alloy wheels (standard on S 350 BlueTEC (L), S 350 BlueEFFICIENCY (L) and S 500 BlueEFFICIENCY (L))



18" 15-spoke alloy wheels (optional)



19" 5-spoke alloy wheels (optional)



18" 5-spoke V12 design alloy wheels (standard on S 600 L)



18" 7-twin-spoke burnished alloy wheels (optional)



19" multi-spoke alloy wheels (optional)





19" 5-Y-spoke alloy wheels (optional)



19" AMG 5-spoke alloy wheels with high-sheen finish (optional, only with AMG Sports Package)



20" AMG 5-twin-spoke alloy wheels (optional)



19" AMG 5-triple-spoke alloy wheels with high-sheen finish (standard on S 63 AMG L)



20" AMG 5-twin-spoke alloy wheels (standard on S 65 AMG L, optional on S 63 AMG L)



Retailer-fit accessories

A Mercedes-Benz is not just a car, it's a travel companion that can be tailored to your needs – with our wide range of Retailer-fit accessories.

Our Retailer-fit accessories offer you a range of ways to increase the practicality and individuality of your S-Class. For the interior, there are high-quality details such as polished



Illuminated door sill strips with 'Mercedes-Benz' lettering

stainless steel illuminated door sills with 'Mercedes-Benz' lettering. There's also a variety of cargo-carrying accessories that enable your S-Class to meet all your leisure needs with



Coat hanger

ease. Up to six pairs of skis can be safely accommodated on the New Alustyle Comfort ski and snowboard rack, for instance. It is designed for use in conjunction with our Alustyle roof bars



The practical New Alustyle Comfort ski and snowboard rack accommodates up to six pairs of skis or four snowboards



and features a practical pull-out function for easier loading and unloading. You can even go online in your S-Class - with the Retailer-fit InCar Hotspot. It provides internet access via



The Mercedes-Benz InCar Hotspot

the car's external aerial and enables you to connect up to four laptops or other wi-fi devices at the same time.



Chromed door handle recesses



Dust cover



Following the star

Mercedes-Benz World at Brooklands. Celebrate the story of Mercedes-Benz and you'll celebrate the story of motoring itself at Mercedes-Benz World in Surrey. A World of experiences. A World of discoveries. A World you will love to explore. Discover Mercedes-Benz racing heritage, its connections to the famous Brooklands circuit and to legendary drivers. View, touch and sit in every car from the Mercedes-Benz range, and encounter automotive legends like the 'Gullwing', in the UK's largest Mercedes-Benz showcase. Then set your pulse racing by booking one of our thrilling Driving Experiences. Enjoy AMG performance on the purpose-built Handling Circuits or Wet Skid Circle, an axle-twisting off-road adventure, or treat your kids to their own drive in an A-Class if they are over 1.5 metres tall. For more interactive action, take a virtual journey along the production line in 'Build' or take a seat in the cinema and accelerate from the birth of the car to the latest innovations in 20 eye-opening minutes.

Relax and refuel in Café 1886, or for a gourmet treat enjoy the first-class menu and elegant surroundings of the Gullwing Restaurant. Finally, extend your visit with a short stroll to Brooklands Museum to see their collection of classic cars, aviation exhibitions – and the legendary Concorde. For more information visit www.mercedes-benzworld.co.uk

Mercedes-Benz Museum. More than 120 years of automotive history in one place – the Mercedes-Benz Museum in Stuttgart-Untertürkheim. With a total exhibition area of 16,500 m², it transports the visitor into a fascinating world of automotive achievement. You can see the first modern motor car, the Mercedes Simplex, discover over 100 years of motor-racing history, and, of course, admire our classics, such as the 'Gullwing' and the 'Tail Fin'. Legendary cars such as these have always occupied a special place in the hearts of car enthusiasts. Now they have a special place

of their own in the Mercedes-Benz Museum. We look forward to welcoming you there soon.

Roadside Assistance. Rest assured that should you ever need help, Mercedes-Benz Roadside Assistance is there for you. In the unlikely event of a technical breakdown¹ you can rely on the Mercedes-Benz Roadside Assistance Team – anywhere in Europe. Simply phone our Customer Assistance Centre on 00800 1 777 7777;² where our specialists will organise assistance for you. Mercedes-Benz will also assist you in the event of a minor mishap preventing you from driving your vehicle.³ Whether you lose your key, run out of fuel or your vehicle is damaged due to an accident or vandalism, Mercedes-Benz ensures that you still reach your destination. Often the problem can be rectified on the spot, but if this is not possible, we will naturally ensure that your vehicle is taken to the nearest Mercedes-Benz Official Workshop to get you back on the road as quickly as possible.



Mercedes-Benz Finance. At Mercedes-Benz Finance, our single-minded aim is to provide optimum financial solutions for all those who share the Mercedes-Benz philosophy of absolute commitment to quality. Whether you are a private customer or a business user, our finance and leasing packages can be tailored to meet your individual needs. For further information on Mercedes-Benz Finance, please contact your local Mercedes-Benz Retailer.

Mercedes-Benz Insurance offers a fully comprehensive 5 star⁴ motor insurance policy specifically designed to give you the cover you would expect from Mercedes-Benz. For a quotation, please call 0845 600 2180.⁵

Test drive. A Mercedes-Benz is most at home on the road. This is the only way to experience the effortlessly superior driving feel that lends every Mercedes model its inimitable class. Feel the power of efficient engines with low fuel consumption, and precise steering designed to put you in the mood for driving. And experience what true comfort really feels like. The unique feeling of driving a Mercedes cannot be put into words, however. Which is precisely why we'd like to invite you to take a test drive. Your Mercedes-Benz Retailer will be happy to make all the necessary arrangements for you. Simply visit www.mercedes-benz.co.uk/testdrive to request a test drive. We look forward to seeing you.

Interactive Owner's Manual. The website also offers an interactive tour, enabling you to take a closer look at your desired model. This simulation is the ideal way to acquaint yourself with your dream car. You can view key functions in detail, gain an insight into the car's inner workings or look at the benefits of each model. For further details, visit www.mercedes-benz.co.uk/sclassmanual

¹Technical breakdown cover is initially valid for your vehicle for four years from the date of first registration. This can be extended from the fifth year, up to a maximum of 30 years, on completion of each scheduled maintenance service, providing that this service is carried out by a Mercedes-Benz Official Workshop

²In non-affiliated European countries: +44 20 7975 7077

³This cover can be retained from the fifth year. Your Mercedes-Benz Official Workshop will provide details of how to renew this cover once your initial four year term has expired

⁴As rated 5 by Defaqto, a leading independent financial research company. Mercedes-Benz Motor Insurance is underwritten by Aviva Insurance UK Limited
⁵Calls are charged at local rate and may be recorded



Mercedes-Benz low rate and deposit contribution finance offers

Representative example

S 350 BlueTEC

36 monthly payments of **	£599.00
On-the-road price	£60,140.00
Customer deposit	£12,500.22
Retailer deposit contribution	£4,100.00
Duration of agreement	36 months
Optional purchase payment†	£26,825.00
Acceptance fee	£180.00
Purchase activation fee‡	£95.00
Amount of credit	£43,539.78
Total amount payable††	£65,264.22
Representative APR	4.9% APR
Fixed interest rate	4.54%

Example offers – 4.9% APR Representative

	Metallic paint	Automatic transmission	Leather	Parktronic	On-the-road price	Retailer deposit contribution	Customer deposit	36 monthly payments of**
S 350 BlueTEC	●	●	●	●	£60,140.00	£4,100.00	£12,500.22	£599.00
S 350 BlueTEC L	●	●	●	●	£64,140.00	£4,100.00	£13,240.55	£659.00

● Standard and optional equipment included in the price

Whilst these offers are only available with Mercedes-Benz Finance, our Mercedes-Benz Retailers do arrange finance on behalf of other finance companies as well

This finance campaign is available on S-Class models ordered/credit approved between 1 April and 30 June and registered by 30 September 2011, excluding AMG and special request engines † Payable if you exercise the option to purchase the car

†† Includes optional purchase payment, purchase activation fee and retailer deposit contribution ** Based on a Mercedes-Benz Agility agreement and 10,000 miles per annum. Excess mileage charges may apply. Quotations available on request for alternative contract lengths and mileages. Guarantees and indemnities may be required. Credit provided subject to status from Mercedes-Benz Financial Services UK Ltd, MK7 8ND ‡ Please speak to your Mercedes-Benz Retailer for payment terms and suitable cover periods

Mercedes-Benz Service Care

Add Mercedes-Benz Service Care for £42.50 per month†

- Maintained by Mercedes-Benz Official Workshops
- Mercedes-Benz trained technicians
- Meets requirements of Mercedes-Benz Agility finance agreement

Mercedes-Benz Motor Insurance

- 24-hour, seven days a week UK accident recovery
- Only genuine Mercedes-Benz parts used
- To qualify for up to 10% discount go to www.mercedes-benz.co.uk/motorinsurance
- Alternatively, call Mercedes-Benz Motor Insurance now on **0845 600 2180** for an annual quote

We may decline to quote in some circumstances. Cover not available in Northern Ireland

Dimensions

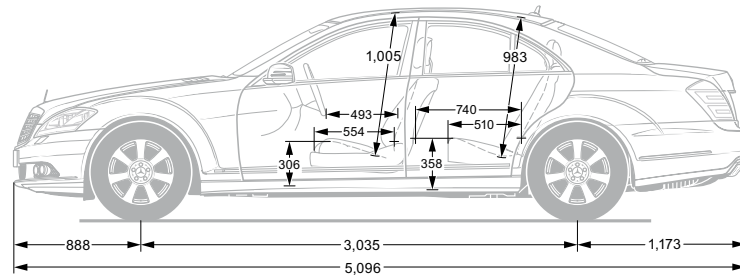

S-Class standard-wheelbase version

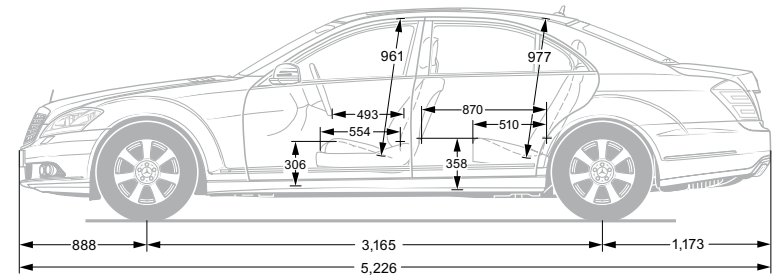

S-Class long-wheelbase version

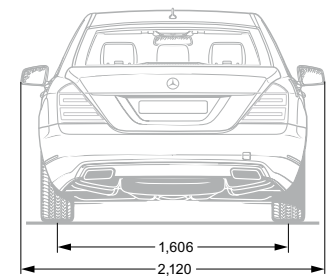
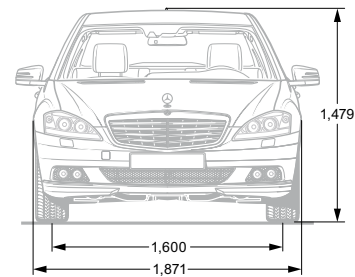
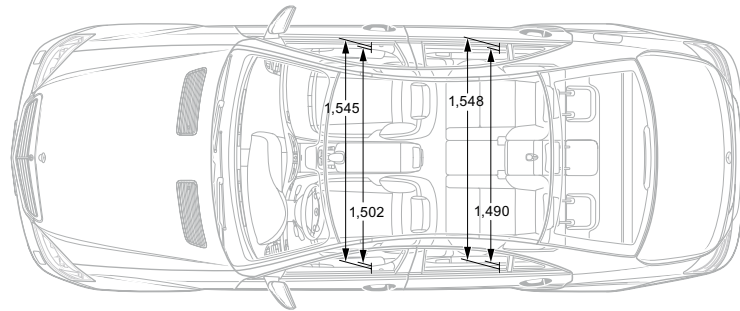

All measurements in millimetres. The dimensions shown are mean values and apply to standard-specification, unladen vehicles



Technical data

No. of cylinders/arrangement
Total displacement – cc
Rated output ¹ – hp (kW) at rpm
Rated torque ¹ – Nm at rpm
Compression ratio
Acceleration 0–62 mph – sec (long wheelbase)
Top speed approx. – mph (long wheelbase)
Tyre size – front
rear
Fuel consumption ³ – mpg
Urban (long wheelbase)
Extra-urban (long wheelbase)
Combined (long wheelbase)
CO ₂ emissions, combined ³ – g/km (long wheelbase)/EU emissions standard
Fuel tank capacity/reserve (approx.) – l
Boot capacity – l
Turning circle – m (long wheelbase)
Kerb weight ⁴ – kg (long wheelbase)
Perm. GVW – kg (long wheelbase)

DIESEL ENGINE

S 350 BlueTEC S 350 BlueTEC L

V6
2,987
258 (190)/3,600
620/1,600–2,400
15.5
7.1 (7.1)
155 ² (155 ²)
255/45 R 18
255/45 R 18
30.4 (30.4)
53.3 (53.3)
41.5 (41.5)
177–182 (177–182)/EU6
83/11
560
11.8 (12.2)
1,995 (2,060)
2,590 (2,640)

PETROL ENGINES

S 350 BlueEFFICIENCY S 350 BlueEFFICIENCY L

V6
3,498
306 (225)/6,500
370/3,500
12.0
6.9 (7.1)
155 ² (155 ²)
255/45 R 18
255/45 R 18
27.7 (27.4)
47.1 (46.3)
37.2 (36.7)
177–184 (179–186)/EU5
83/11
560
11.8 (12.2)
1,910 (1,975)
2,505 (2,555)

¹Figures according to Directive 80/1269/EEC in the currently applicable version ²Electronically limited

³The figures shown were obtained in accordance with the prescribed measuring process (Directive 80/1268/EEC in the currently applicable version). The figures are not based on an individual vehicle and do not constitute part of the product offer; they are provided solely for purposes of comparison between different vehicle models and are subject to change. Please check with your local Retailer for the latest figures ⁴With 17" alloy wheels

⁵Figures according to Directive 92/21/EC, version 95/48/EC (kerb weight with fuel tank 90% full, driver, 68 kg, and luggage, 7 kg) for standard-specification vehicles.

Optional extras and accessories will generally increase this figure and reduce the payload capacity accordingly



PETROL ENGINES

S 500 BlueEFFICIENCY L

S 600 L

S 63 AMG L

S 65 AMG L

V8	V12	V8	V12
4,663	5,513	5,461	5,980
435 (320)/5,250	517 (380)/5,000	544 (400)/5,250–5,750 [571 (420)/5,500 ⁵]	630 (463)/4,600–5,000
700/1,800–3,500	830/1,800–3,500	800/2,000–4,500 [900/2,250–3,750 ⁵]	1,000/2,300–4,300
10.5	9.0	10.0	9.0
(5.0)	(4.6)	(4.5) [4.4 ⁵]	(4.4)
(155 ²)	(155 ²)	(155 ²) [186 ⁵]	(155 ²)
255/45 R 18	255/45 R 18	255/40 ZR 19	255/35 ZR 20
255/45 R 18	275/45 R 18	275/40 ZR 19	275/35 ZR 20
(21.9)	(13.1)	(19.6)	(13.0)
(38.7)	(29.1)	(34.4)	(28.5)
(30.1)	(20.0)	(26.9)	(19.8)
(219–224)/EU5	(329–332)/EU5	(244)/EU5	(334)/EU5
83/11	90/11	90/14	90/14
560	550	560	550
(12.2)	(12.2)	(12.2)	(12.2)
(2,075)	(2,210)	(2,170)	(2,275)
(2,655)	(2,690)	(2,695)	(2,710)

¹Figures according to Directive 80/1269/EEC in the currently applicable version ²Electronically limited

³The figures shown were obtained in accordance with the prescribed measuring process (Directive 80/1268/EEC in the currently applicable version). The figures are not based on an individual vehicle and do not constitute part of the product offer; they are provided solely for purposes of comparison between different vehicle models and are subject to change. Please check with your local Retailer for the latest figures ⁴With 17" alloy wheels

⁵Figures according to Directive 92/21/EC, version 95/48/EC (kerb weight with fuel tank 90% full, driver, 68 kg, and luggage, 7 kg) for standard-specification vehicles.

Optional extras and accessories will generally increase this figure and reduce the payload capacity accordingly



Paint finishes

The innovative Mercedes-Benz paint system features one of the finest clearcoats of any manufacturer. Its exceptionally dense molecular structure makes the paintwork more durable and lends it a deeper, more lasting sheen, helping your S-Class to retain both its looks and its long-term value.

NON-METALLIC PAINT (standard)

040 Black

METALLIC PAINTS (optional)

183 Magnetite Black

197 Obsidian Black

300 Periclase Green

359 Tansanite Blue

368 Flint Grey

474 Peridot Brown

526 Dolomite Brown

544 Carneol Red

775 Iridium Silver

792 Palladium Silver

799 Diamond White¹

¹Available at additional cost

NON-METALLIC PAINT



040



359



544

METALLIC PAINTS



183



368



775



197



474



792



300

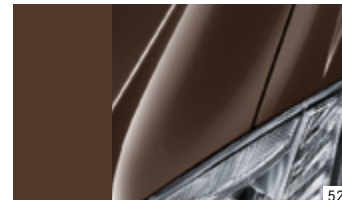

526



799

For details of *designo* exterior colours, please visit www.mercedes-benz.co.uk/designo



Take-back of end-of-life vehicles. Coming full circle. At the end of its long life, you can return your S-Class to us for environment-friendly disposal in accordance with the EC End-of-Life Vehicle Directive.¹ But that day lies a long way off.

¹Applies in accordance with national regulations to vehicles up to 3.5 tonnes gross weight. The S-Class has met the statutory regulations governing the suitability of their design for reuse and recycling for a number of years now. A network of vehicle take-back depots and dismantlers has been established which will process your vehicle in an environment-friendly manner. The ways in which both vehicles and parts can be recovered are subject to ongoing development and improvement. Consequently, the S-Class will be able to comply with any future increases in the recycling quota within the stipulated time limits. Further information is available at www.mercedes-benz.co.uk or by calling 0808 156 6606.

Please note: this online version of the printed brochure may contain abridged copy or other content changes. The manufacturer reserves the right to make changes to the design, form, colour and specification during the delivery period, provided these changes, while taking into account the interests of the vendor, can be deemed reasonable with respect to the purchaser. Where the vendor or the manufacturer uses symbols or numbers to describe an order or the subject of an order, no rights may be derived solely from these. The illustrations may show accessories and items of optional equipment which are not part of standard specification. Colours may differ slightly from those shown. This brochure provides a general indication of the range of models, features, optional extras and/or colours available in various countries. Some of the models, features, optional extras and/or colours shown may not be available in your country or may only be available in a different specification. Additionally, some models, features, optional extras and/or colours may only be available in combination with others. For current and more specific information in relation to the range of models, features, optional extras and/or colours available in your country, and their pricing, you should contact your nearest authorised Mercedes-Benz Retailer. E&OE.

Finance offers: on-the-road costs include VAT, delivery, number plates, first registration fee, 12 months' road fund licence and fuel. Written quotations available on request from your local Mercedes-Benz Retailer. We reserve the right not to allow these subsidised interest rates to be used in conjunction with any other offer. Credit provided subject to status from Mercedes-Benz Financial Services UK Ltd. Guarantees and indemnities may be required. Offers are subject to availability. Mercedes-Benz Finance is a trading name of Mercedes-Benz Financial Services UK Limited. Registered in England No. 2472364. A Daimler Company. Registered Office: Burystead Court, Caldecotte Lake Drive, Caldecotte, Milton Keynes MK7 8ND. Tel. 0870 840 5000. Fax 0870 840 9000. www.mercedes-benz.co.uk

