



# The Sprinter

Panel van



Mercedes-Benz

# Contents

<b>Sprinter panel van</b>	<b>4</b>	<b>Equipment</b>	<b>22</b>
Load compartment and functionality	6	Standard and optional equipment	22
Partially glazed panel van	8	Genuine accessories	27
		Paintwork	29
<b>Industry expertise/Body and conversion solutions</b>	<b>10</b>	<b>Technical data</b>	<b>30</b>
		Engine data and model range	30
<b>Interior</b>	<b>12</b>	Fuel consumption and CO <sub>2</sub> emissions	34
Comfort and functionality	12	Weights	36
		Dimensions	38
<b>Technology</b>	<b>14</b>		
Engines and running gear	14	<b>Glossary</b>	<b>40</b>
BlueEFFICIENCY	16	<b>Services</b>	<b>42</b>
All-wheel drive	18	<b>Test drive</b>	<b>46</b>
<b>Safety</b>	<b>20</b>		





The Sprinter. Every inch the consummate professional



Nobody knows more about your job than you do. That's why the Sprinter panel van lets you take your pick. With three wheelbase versions, four body lengths and three load compartment heights, you have a free hand selecting the right solution for virtually any transport task. Several application-matched engines can be combined with a wide range of optional equipment to fit your every need.

The Sprinter combines its many practical talents with impressive performance in the important disciplines of the economy and sustainability. The combination of advanced CDI engines and the standard BlueEFFICIENCY package guarantee a significant reduction in fuel consumption and reduced CO<sub>2</sub> emissions. Look forward to a professional partner: your Mercedes-Benz Sprinter.



# Whatever you have planned – the Sprinter takes it in its stride

The Sprinter panel van takes loads as they come. It can be loaded from behind, from the right-hand side or, optionally, from the left as well. A fourth body length and the optional super-high roof mean that you have up to 17 m<sup>3</sup> of cargo space available. Near-vertical inner walls, levelled-off wheel arches and a payload of up to 2515 kg allow the available space to be fully utilised. The exceptionally wide side load compartment opening allows Europallets to be loaded comfortably, even long-edge first. Also useful options like the KEYLESS ENTRY & SLIDE automatic door opener allow you to save valuable time during the trip.

- ▶ 3 wheelbases, 4 body lengths, 3 load compartment heights
- ▶ Max. loading length 470 cm, max. load compartment height 214 cm

- ▶ Cargo volume from 7.5 to 17 m<sup>3</sup>
- ▶ Payload from 734 to 2515 kg
- ▶ Load compartment with four sliding-door versions up to 1.30 m wide x 1.82 m high, depending on body length and roof variant
- ▶ Electrically operated load-compartment sliding doors as an optional extra: this feature makes it possible to open and close the right or left sliding door at the push of a button, apart from which the door can be stopped in any position
- ▶ Optional KEYLESS ENTRY & SLIDE feature provides fully automatic opening and closing of the load-compartment sliding door when approaching the vehicle/leaving the load compartment
- ▶ Hinged rear doors open to an angle of 180° or, as an option, up to the side wall (doors lock into position automatically)
- ▶ Practical range of bulkhead variants: continuous, with window, with sliding window or with sliding door
- ▶ Flexible load-securing and cargo-retention system: standard-fit load-securing rings and optional lashing rails in the floor, sidewalls and roof frame, as well as tensioning straps for the lashing rails; more load-securing aids are available as accessories
- ▶ Towing capacity of up to 3.5 t for selected vehicle variants
- ▶ Very easy loading





# Space for a thousand things, even with six people on board



Transport crew and cargo without having to compromise – it's easy with the partially glazed panel van. The bulkhead at the C-pillar is available as an option for the panel van with a high roof and 3.5-t perm. GVW

The Sprinter with a partially glazed load compartment combines the advantages of a panel van with those of a crewbus/minibus, making it ideal for jobs involving the transport of a crew as well as a large amount of material. Large windows behind the B-pillar, a convenient entrance, high-quality seats and plenty of space ensure that comfort is first-class in the second row, too. There is room for up to six people without having to compromise on hallmark Sprinter variability. The rear bench seat, available as an option, can be removed in next to no time.

- ▶ Optional 3-seater bench for the passenger compartment, with the option of armrests
- ▶ Room for up to six people if the optional twin passenger seat is specified
- ▶ Three-point seat belts for all seats
- ▶ Optional bulkhead at the C-pillar (available for the partially glazed panel van with a high roof and 3.5-t perm. GVW)
- ▶ For remaining loading lengths when 3-seater bench is installed (measured on load compartment floor without bulkhead installed), see illustrations below

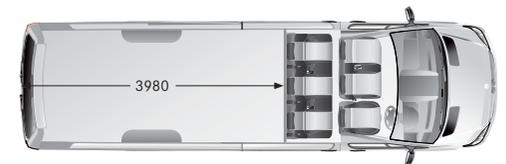
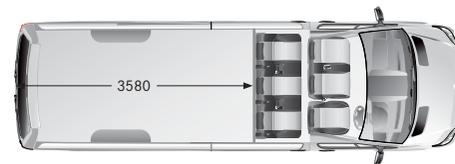
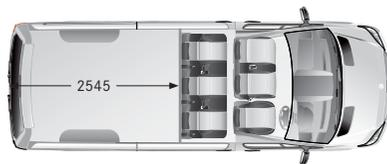
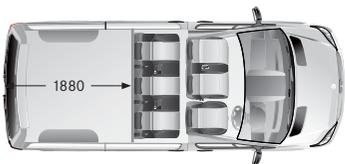

All dimensions in mm

# The Sprinter: Especially for you

A professional transport solution is always an individual transport solution. And the Sprinter is the best example of this. Its flexible vehicle concept and impressively wide range of variants make it the ideal solution for many industries and applications. Reap the benefits of Mercedes-Benz's industry know-how and vast experience – and discover your own personal Sprinter.





The Sprinter serves as a basis for all manner of body types<sup>1</sup>. The Sprinter can be converted into a mobile workshop, used as a refrigerated or deep-freeze vehicle, or equipped with a fuel-saving, aerodynamic integral box body, to name but a few examples

**Individuality as a principle.** An important part of any professional partnership is recognising your partner's needs. This is why we at Mercedes-Benz look very closely at the wishes and requirements of our customers. One of the key requirements is the ability to adapt a vehicle to a highly individual application profile. Right from the start, Mercedes-Benz vans are developed with this aspect firmly in mind, meaning that they provide an excellent basis for bodies and conversions used in all industries. Mercedes-Benz cooperates closely with qualified partner companies, meaning that the Sprinter can meet even the most unusual of individualisation requirements.

**Custom-designed solutions from qualified partners.** Bodybuilders are key partners when it comes to providing individual industry solutions. Here too, quality is the highest precept for us. This is why Mercedes-Benz cooperates closely and intensively with selected bodybuilders and offers them comprehensive support. This philosophy has numerous advantages for customers: by combining our know-how with the know-how of the bodybuilders, we are able to provide an extremely wide range of body types of a very high quality – from vehicles for the construction industry and the trades to box-body vans and refrigerated vehicles as well as vehicles for the police and rescue services.

Public authorities, in particular, appreciate our industry solutions on account of attributes such as longevity and reliability. A further plus point is the fact that our cooperation with bodybuilders also extends to service and repairs. Your Mercedes-Benz van dealer will be glad to help you find just the body type you need.

<sup>1</sup> The vehicles shown here are examples of body and conversion solutions. Some of them are available ex factory or only directly from the bodybuilder. The body and conversion solutions available vary from country to country

Give yourself  
a comfortable lead



The conditions under which you have to operate your vehicle are tough and unforgiving – and they’re not getting any easier. At least the Sprinter can help. It sets standards by providing outstanding driving and operating comfort, plenty of space and even more intelligent ideas. The interior scales new heights in terms of design, material selection and ergonomic quality. Then there is the wide range of practical and innovative equipment from which you can choose the elements you need. After all, you’re in the driving seat.

- ▶ A generous amount of space for all occupants
- ▶ Numerous stowage facilities offer plenty of handy storage space (e.g. compartment above the windscreen as standard)
- ▶ Several cup holders and 2 bottle holders (1.5-litre bottles)
- ▶ Ergonomically shaped seats with optimised seat design
- ▶ Driver’s seat with wide adjustment range
- ▶ Dual passenger seat with stowage compartment under seat cushion and integral folding table in backrest
- ▶ Low interior noise level
- ▶ Steering wheel adjustable for height and reach available as optional equipment
- ▶ Multifunction steering wheel with trip computer available as standard
- ▶ Power windows for driver and passenger
- ▶ Cruise control with activatable SPEEDTRONIC speed limiter available as standard
- ▶ Powerful heating and ventilation system
- ▶ Latest-generation radios offering the right solution for every need
- ▶ Bluetooth® hands-free system and universal interface for mobile devices – e.g. mobile navigation systems, smartphones and MP3 players – available as standard
- ▶ Optional PARKTRONIC parking aid front and rear with audible signal and visual display in the exterior mirror and on the instrument panel
- ▶ Central locking with radio remote control as standard



The handy joystick-style gearshift on the dashboard allows easy through-cab access



Standard dual passenger seat with folding table available as optional equipment

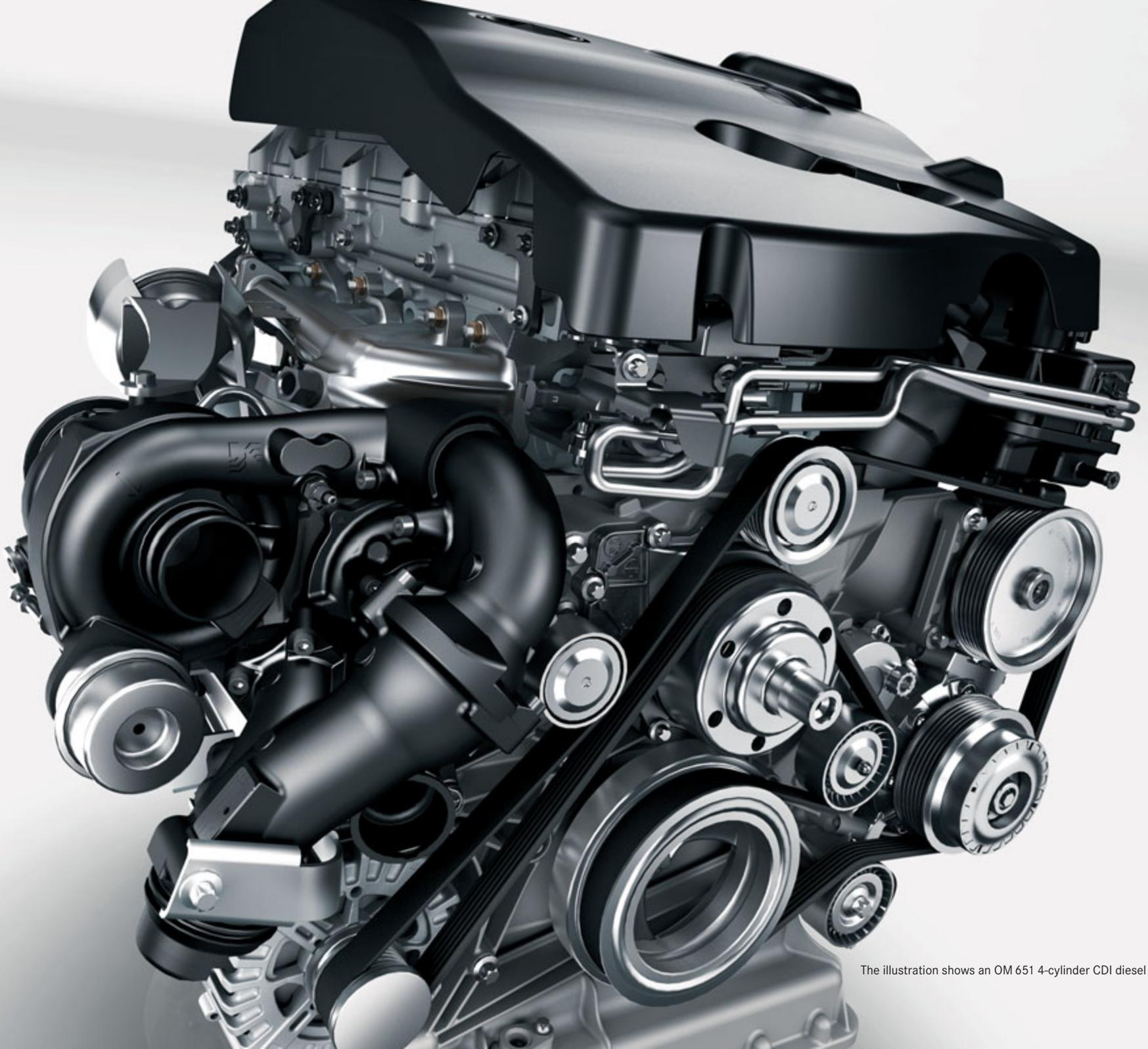

The illustration shows an OM 651 4-cylinder CDI diesel engine

# The Sprinter is impressive on the road. And on the balance sheet, too

## Economically-efficient engines

High quality standards and solid resale values contribute to the overall cost-effectiveness of the Sprinter, as do its highly sophisticated engines. When equipped with the advanced OM 651 4-cylinder CDI diesel engine, available with a choice of three power outputs, or the supremely confident OM 642 V6 CDI diesel engine, the Sprinter sets standards in terms of economic efficiency and future-compatibility. If the van is registered as a commercial vehicle, all four CDI diesel engines meet the requirements of the Euro V emission standard and consume far less fuel than the previous engines with a corresponding reduction in exhaust gas emissions. In addition to this, the CDI diesel engines can also be made to comply with the EEV (Enhanced Environmentally Friendly Vehicle) standard – currently Europe's most stringent emission standard – if requested by the customer. For example these vehicles ensure extremely low emissions of particulate matter. As well as displaying these attributes, the Sprinter's engines are also impressively quiet – thanks to effective noise insulation which ensures a pleasant sound level in the interior.

**Fuel-saving transmission.** The innovative ECO Gear 6-speed manual transmission is the ideal partner for the Sprinter's diesel engines. Thanks to a wider gear ratio spread, a wider overall gear ratio and the reduction in the engine speed level, it reduces combined fuel consumption substantially compared to the earlier Euro IV CDI diesel engines – by up to 4.5 mpg in the case of the 4-cylinder engine and by as much as 3.7 mpg in the case of the 6-cylinder engine.

- ▶ Economical 4-cylinder CDI diesel engine with a choice of 3 power outputs, two-stage turbocharger for the variants developing 129 bhp and 163 bhp; V6 CDI diesel engine delivering 190 bhp also suitable for heavier-duty jobs
- ▶ CDI diesel engines with diesel particulate filter as standard
- ▶ Fuel-saving ECO Gear 6-speed manual transmission for the CDI diesel engines

- ▶ New consumption-optimised 7G-TRONIC<sup>1</sup> 7-speed automatic transmission optionally available for the CDI engines
- ▶ Start-off Assist as standard for vehicles with automatic transmission, optional for vehicles with manual transmission
- ▶ Diverse variants with gas drive system: Sprinter NGT (Natural Gas Technology) with bivalent natural gas and petrol drive
- ▶ The optional ASSYST service computer allows flexible, application-oriented oil change intervals and therefore helps to reduce maintenance costs

<sup>1</sup> Expected to be available from 1<sup>st</sup> quarter 2012. Until replacement the 5-speed automatic transmission will be delivered.

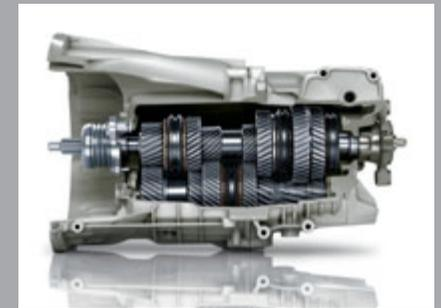

# BlueEFFICIENCY

Fast forward to viable efficiency

From 34.9 mpg. The Sprinter with BlueEFFICIENCY package<sup>1, 2, 3</sup>. Our goal is to ensure your mobility in as economical and sustainable a manner as possible for the future. We group together under the term BlueEFFICIENCY all those innovations that help make this objective possible: intelligently combined measures aimed at reducing fuel consumption and CO<sub>2</sub> emissions. The Sprinter with the BlueEFFICIENCY<sup>1, 2, 3</sup> package proves just how well this

works. In particular in urban distribution transport, the interaction of the ECO start-stop function<sup>4</sup> a thrifty diesel engine and further components ensure a significant reduction of fuel consumption and emissions especially in inner city traffic. In its thriftiest version, the Sprinter impresses with a consumption of just 34.9 mpg. The efficiency package is available for all variants of the Sprinter Panel Van powered by a CDI diesel engine.



## Components of the BlueEFFICIENCY package<sup>1, 2, 3</sup> for the Sprinter Panel Van

- ▶ OM 651 diesel engine (Euro V or Euro V/III) or OM 642 diesel engine (Euro V)
- ▶ ECO start/stop function<sup>4</sup>
- ▶ ECO power-steering pump
- ▶ Electrically-controlled fuel pump
- ▶ Shift point recommendation
- ▶ Rolling-resistance optimised tyres<sup>5</sup>
- ▶ Alternator management
- ▶ Battery management
- ▶ In-engine measures

<sup>1</sup> The efficiency package with automatic transmission and 4x2 drive for the Sprinter will not be available until the introduction of the new 7G-TRONIC 7-speed automatic transmission (expected to be available from first quarter of 2012)

<sup>2</sup> When registered as a commercial vehicle, the Sprinter features shift point recommendation, battery management and in-engine measures as standard; all other items are optional equipment. When registered as a passenger car, the efficiency package is included as standard

<sup>3</sup> Not in conjunction with automatic transmission

<sup>4</sup> In conjunction with standard manual transmission and a 3.962 optional rear-axle transmission ratio

<sup>5</sup> If available for the particular model variant, otherwise standard tyres.





4x4



# Four good reasons for driving your business forwards

## The Sprinter with all-wheel drive<sup>1</sup>

If you also need to go off-road with your Sprinter or are often faced with tough operating conditions, we recommend a 4x4 model. It truly excels under poor road and weather conditions with its combination of increased traction, enhanced directional stability and road adhesion, and latest-generation ESP<sup>®</sup>. The engageable all-wheel drive<sup>1</sup> transfers the engine power to all four wheels simultaneously, splitting it 35 : 65 between the front and rear axle. Gear reduction is available as standard to extend the range of application possibilities on difficult terrain and further improve starting performance.

One of the outstanding features of the Sprinter's all-wheel-drive system<sup>1</sup> is the absence of mechanical differential locks. In their place is the much lighter 4ETS Electronic Traction System which, being fully automatic, relieves the strain on the driver. It engages when one or more wheels start to spin, braking the spinning wheels individually and increasing the drive torque at the wheels which still offer sufficient grip.

<sup>1</sup> Available for selected variants. For availability by model, please see the tables on pages 30–33

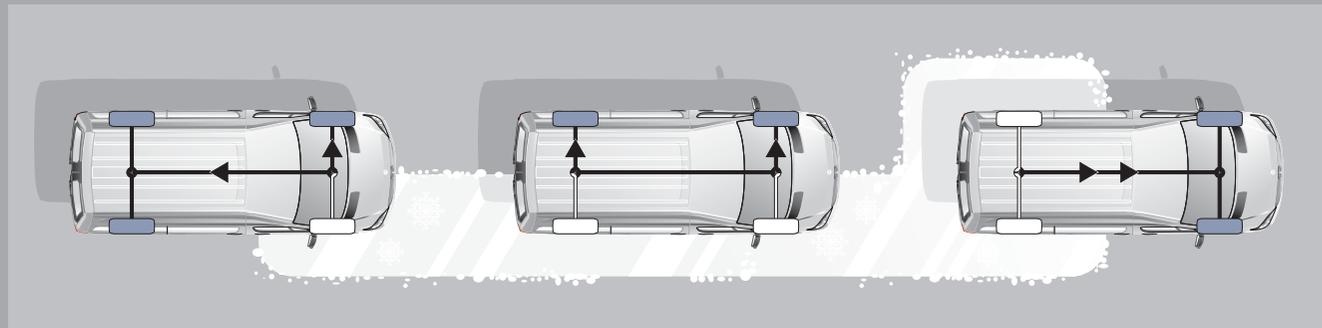

The all-wheel drive system operates even more effectively because the Electronic Traction System 4ETS is integrated in the Sprinter's standard-fit ESP<sup>®</sup>

Your safety is a precious commodity



**ADAPTIVE  
ESP<sup>®</sup>**

There's no such thing as too much safety. That's why we've made every effort to ensure that the Sprinter offers the driver, passengers and other road users the highest possible degree of protection. A prime example of this is the Electronic Stability Program ADAPTIVE ESP® which, for the first time, takes account of the vehicle load. As the vehicle load can vary during the course of a trip, sensors determine the current level, thus enabling ADAPTIVE ESP® to perform its stabilising interventions correspondingly.

In order to increase handling safety when towing a trailer, we have now extended the range of ADAPTIVE ESP® functions for the Sprinter to include Trailer Stability Assist. If the trailer starts to sway, the new system counteracts these movements to help the driver to stabilise the vehicle/trailer combination. ESP® Trailer Stability Assist is activated automatically if a trailer coupling is fitted ex factory. It can also be activated subsequently by your Mercedes-Benz dealer if a trailer coupling is retrofitted.

- ▶ ADAPTIVE ESP® Electronic Stability Programme in conjunction with anti-lock brake system (ABS), acceleration skid control (ASR), electronic brake force distribution (EBD), Brake Assist (BAS) and ESP® trailer stabilisation
- ▶ Very good crash performance
- ▶ Front airbag for the driver as standard
- ▶ Optional front airbag for the passenger, both for the single seat and the dual seat, as well as windowbags and thorax bags for the driver and passenger
- ▶ Three-point seat belts on all seats; with belt tensioners and belt force limiters for driver's and single passenger seat; seat belt warning for driver's seat standard
- ▶ Head restraints with 2-way adjustment standard on all seats; 4-way adjustment optionally available
- ▶ Hydraulic braking system
- ▶ Adaptive brake lights as standard
- ▶ Both exterior mirrors have integrated additional wide-angle mirrors
- ▶ Optional bi-xenon headlamps with Add-Light system and cornering light function
- ▶ Rain sensor with Headlamp Assist as an option
- ▶ Bulb failure indicator
- ▶ Practical load-securing system comprising load-securing rings with increased load rating as well as optional lashing rails in the floor, sidewalls and below the roof frame; optional tensioning straps
- ▶ Central locking with radio remote control and enhanced anti-theft protection; anti-theft alarm system with interior monitoring and tow-away protection available as optional extras
- ▶ Optional tyre pressure monitoring system (not available with twin tyres)
- ▶ Optional reversing camera in conjunction with a 17.8 cm monitor to aid reversing and manoeuvring (display also possible via COMAND APS)



The figure on page 21 (left) shows various airbags at their maximum deployment for illustrative purposes only.

# Make your life a little easier

The Sprinter offers a wide range of standard and optional equipment features to help make life on the road a whole lot safer and more pleasant. Why not start compiling your wish list right away?

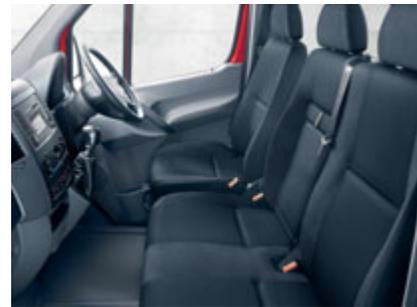

○ **Dual passenger seat.** Provides seating for a third person in the driver's section. The table function provides an additional storage surface; the seat base can be used as a stowage compartment.



○ **Armrests for driver and passenger.** The angle-adjustable armrests enhance comfort and relaxation, particularly on long journeys.



○ **Comfort seats.** Take a seat: comfort seats with adjustable seat cushion angle and other adjustment options in addition to manual lumbar support.

● Standard equipment

○ Optional equipment

- **Steering wheel adjustable for height and reach.** The wide adjustment range ensures that drivers of different sizes quickly find a seating position to suit them.



- **Hinged lid for stowage compartment.** The stowage compartment with hinged lid allows items such as a laptops, personal articles or freight papers to be stowed safely out of sight. Once opened, the hinged lid is held in its end position, making it easier to use.



- **Generous stowage facilities.** The spacious compartments in the interior panelling on the driver and passenger door provide plenty of space for a 1.5-litre bottle. These generous compartments are complemented by several other stowage facilities in the cockpit, including several cup holders and a practical compartment above the windscreen.



- **Audio 20 radio.** Radio with dual tuner, CD player with MP3 capability, Bluetooth® interface<sup>2</sup> with hands-free function and telephone keypad as standard

<sup>2</sup> Our telephony and multimedia web special gives you detailed information and useful instructions regarding the Bluetooth® compatibility of your devices: [www.mbvans.co.uk](http://www.mbvans.co.uk)



- **Front airbag<sup>1</sup> for driver.** When combined with a fastened seat belt, the front airbag for the driver increases the level of occupant protection in the event of a severe frontal collision.
- **Front airbag<sup>1</sup> for passenger.** A front airbag for the passenger (including for the dual passenger seat) is available as optional equipment.

<sup>1</sup> The picture shows simulated front airbag activation (maximum deployment) – for illustrative purposes only



- **Lockable glove compartment.** The lockable and illuminated glove compartment provides plenty of space for the safe stowage of documents and personal items.



- **COMAND APS control and display system.** High-performance multimedia system with fast hard-disc navigation for the digitised areas of Europe. 16.5 cm TFT colour display, high-resolution map display, Traffic Message Channel (TMC), DVD video/audio, 4 GB memory for MP3 files, Bluetooth® interface<sup>2</sup> with hands-free function.

<sup>2</sup> Our telephony and multimedia web special gives you detailed information and useful instructions regarding the Bluetooth® compatibility of your devices: [www.mbvans.co.uk](http://www.mbvans.co.uk)

○ **ASSYST service computer.** The optional ASSYST service computer allows flexible, application-dependent oil change intervals of up to 50,000 km in the case of the diesel models (petrol models: 40,000 km) or every two years at the latest. With the ASSYST service computer on board, maintenance intervals are up to 100,000 km (diesel models) or 80,000 km (petrol models), depending on operation.



○ **Electric step<sup>1</sup> for load compartment sliding door.** Comfortable access and exit: the electric step extends and retracts automatically on opening and closing respectively, the load compartment sliding door.



<sup>1</sup> Please contact your Mercedes-Benz dealer for information about availability.

○ **Plywood load-compartment panelling (roof-high).** Plywood panels up to the roof edge protect the sheet-metal skin against damage, e.g. caused by sliding cargo.



○ **Lashing rails on belt rail.** When used together with load-securing straps, the lashing rails mounted on the side wall secure medium-high bulky objects. Suitable tensioning straps for the lashing rails are available as optional equipment.



○ **FleetBoard product range.** Vehicle computer TiiRec creates the conditions for the use of the innovative Vehicle management and Time management telematics services (further information on page 41 and at [www.fleetboard.com](http://www.fleetboard.com)). DispoPilot mobile and DispoPilot.guide are available from your Mercedes-Benz dealer or directly from FleetBoard as retrofits for the application Logistics management.



○ **Load-compartment panelling up to belt rail, washable.** Half-height wood hardboard panels trimmed with grey PVC sheeting protect the metal surfaces from damage, e.g. due to shifting loads, and enhance the appearance of the load compartment (roof-high load-compartment panelling also available).



○ **Lashing rails under the roof frame.** In conjunction with load-securing straps, the lashing rails mounted under the roof frame can be used to secure tall, bulky objects.



● **Load-securing rings in load-compartment floor.** Can be used in combination with the optionally available tensioning straps to restrain the cargo.

● Standard equipment    ○ Optional equipment

- **Load-securing system.** Lashing rails fitted flush with the floor are a fast and simple means of restraining objects of different sizes.



- **Trailer coupling (ball-type head).** Both rigid and detachable ball-head trailer couplings are available, with 13-pin trailer socket. Maximum permissible drawbar load is 100 kg, with a maximum permissible towing capacity of 2 t (optionally higher).

- **Rear step.** An optional rear step is available, for vehicles with or without trailer coupling. A sprung rear step is also available (only for vehicles without trailer coupling).



- **Side rub strips.** Wide plastic strips protect the bodywork from minor damage.



- **Chrome-trimmed radiator grille.** An attractive chrome trim lends the radiator grille a distinctive look and further enhances the appearance of the vehicle.



- **Full-width bulkhead.** The bulkhead protects the driver and passenger from shifting loads.
- **Bulkhead with fixed or sliding window.** Optionally, the bulkhead can be fitted with a fixed or sliding window, allowing the driver to keep an eye on the load compartment.



- **Reversing camera.** When reverse gear is engaged, the reversing camera sends images of the area behind the vehicle to a 17.8 cm monitor. In this way, the system makes parking and manoeuvring easier and safer (display also possible via COMAND APS).



- **Bi-xenon headlamps with Add-Light system and cornering light function.** Better illumination of the area directly to the side of the vehicle enhances safety, especially on tight bends, at junctions and when manoeuvring.

# Further standard and optional equipment

## Interior

4-way head restraints	○
Bulkhead at the C-pillar (only available for partially glazed panel van with high roof and 3.5 t perm. GVW)	○
Bulkhead with aluminium sliding door	○
Cab carpeted with insulating mat and non-slip rubber floor covering	●
Indicator lights for turn signal indicators, main beam, charging current, oil level, coolant level, brake fluid and brake pads etc.	●
Instrument cluster with clock and outside temperature display, etc.	●
Rear seat row with 3-seater bench seat (wide or narrow)	○

## Exterior

Alloy wheels	○
Full wheel covers	○
Heated rear window	○
Hinged rear doors opening as far as the side wall	○
Hinged rear doors with window	○
Roof fan for load compartment	○
Sliding load compartment door (left)	○
Trailer coupling (reinforced) for up to 3.5 t towing capacity (vehicles with 3.5 t perm. GVW only)	○
Trailer socket, 13-pin	○

## Comfort

Auxiliary heater	○
Central locking with radio remote control	●
Electric closing aid for sliding load-compartment door	○
Electrically adjustable and heated exterior mirrors incl. heated additional wide-angle mirror	○
Electrically operated sliding load-compartment door	○

Entry/exit lights for driver and passenger	○
Heated seats for driver/passenger	○
Hot-air auxiliary heating (fuel-fired stationary heater)	○
Hot-water auxiliary heater (also functions as a stationary heater)	○
Keyless entry	○
Multi-adjustable driver's seat for a relaxed seating position	●
Multifunction steering wheel with trip computer	●
PARKTRONIC parking and manoeuvring aid	○
Power windows for driver and passenger	●
Pre-installation for radio	●
Precisely controllable heating and ventilation system with four-stage fan and two additional fresh-air vents	●
Rack-and-pinion power steering	●
Radio and communication systems:	
– Audio 20 radio	●
– Audio 20 radio with CD changer	○
– COMAND APS control and display system	○
– COMAND APS+ control and display system with DVD changer	○
Sliding window in load compartment	○
Start-off Assist (for manual transmission models)	○
Suspension seats for driver/passenger	○
TEMPMATIC temperature-controlled air conditioning	○
Tinted windows	○

## Technology

5-speed automatic transmission (standard for V6 petrol model)	○
7G-TRONIC 7-speed automatic transmission <sup>1</sup> (only in conj. with CDI diesel engine)	○
All-wheel drive	○

BlueEFFICIENCY package (see p. 16)	○
Cruise control	●
Tachograph	○
Various different final-drive ratios	○

## Safety/chassis

2-way head restraints on front seats	●
4-way head restraints	○
ADAPTIVE ESP® (Electronic Stability Program) in conjunction with ABS, ASR, EBD, BAS, Acceleration Skid Control (ASR), Electronic brake force distribution (EBD), Brake Assist (BAS) and ESP® Trailer Stability Assist (only in conj. w/trailer coupling or pre-installation for one)	●
Anti-theft alarm system with interior monitoring and tow-away protection (with or without battery-powered horn)	○
Bulb failure indicator	●
Chassis variants for a wide range of requirements	○
Front fog lamps (halogen)	○
Headlamp cleaning system	○
Headlamp range adjustment	●
Heated windscreen	○
Independent front suspension	●
Rain sensor with Headlamp Assist	○
Thorax bags for driver and passenger	○
Three-point seat belts on all seats; with belt tensioners and belt force limiters for driver's and single passenger seat	●
Tyre size 235/65 R C (3.5 ton)	●
Windowbags for driver and passenger	○

● Standard equipment    ○ Optional extra

<sup>1</sup> Expected to be available from 1<sup>st</sup> quarter 2012. Until replacement the 5-speed automatic transmission will be delivered

# Genuine accessories<sup>1</sup>

Mercedes-Benz accessories allow you to further individualise your Sprinter to fulfil your exact needs. Genuine Mercedes-Benz accessories<sup>1</sup> are optimised to suit your vehicle, and they meet stringent requirements in terms of quality and

safety. Further information and details of the entire product range can be found in our accessories brochures.



**Mobile phone cradles.** Cradles are available for common makes of mobile phone<sup>2</sup> as the link between your mobile phone and the mobile phone console. Optimum voice quality and user-friendly operation are ensured at all times. Can be fitted without any need to visit a workshop.



**Stowage box in dual passenger seat.** The spacious stowage box, made from shockproof plastic, is designed to help keep the interior tidy. It enables the supplied partition to be fitted and can be used to store suspended files. The stowage box protects the inside of the seat base frame against damage and ensures that smaller items do not get lost. It is mounted by simply inserting it. Designed for accurate fit, the box fixes itself in place.



**General-purpose securing net.** Makes securing a load child's play: the net is always ready for use by means of a lift system in the roof. After the vehicle has been loaded, the net can be stretched across the cargo quickly and easily before being secured to the load compartment floor using tensioning straps – from the side or rear doors for added convenience.



**Cargo basket.** Flexible load carrier: the cargo basket allows you to transport various forms of cargo and can be adapted to any vehicle length. The staff at your Mercedes-Benz service outlet will be glad to advise you on the parts suitable for your vehicle.

<sup>1</sup> The figures may show genuine accessories that are not available in all countries

<sup>2</sup> The mobile phone illustrated is not supplied



# Paintwork



arctic white



calcite yellow



hibiscus red



velvet red



aqua green



steel blue



vanda blue



brilliant silver metallic<sup>1</sup>



graphite grey metallic<sup>1</sup>



amber red metallic<sup>1</sup>



jasper blue metallic<sup>1</sup>



carbon black metallic<sup>1</sup>

The standard and metallic paint finishes<sup>1</sup> shown here are just a few of the options available for your Sprinter. More than 100 other optional colours are available for special paint finishes. Custom paintwork, e.g. in your company colours, is also available as an option.

<sup>1</sup> Metallic paintwork is an optional extra

# Engine data and model range

Permissible GVW [t]		Panel van											
		3.0 t		3.5 t				4.6 t			5.0 t		
Wheelbase		S	M	S	M	L	XL	M	L	XL	M	L	XL
Roof height													
<b>Models with 4x2 drive</b>													
210 CDI/310 CDI/510 CDI 70 kW (95 bhp) OM 651 DE22LA diesel engine	SR	•	•	•	•						•		
	HR	•	•	•	•	•	•				•	•	•
	SHR				•	•	•				•	•	•
213 CDI/313 CDI/413 CDI/513 CDI 95 kW (129 bhp) OM 651 DE22LA diesel engine	SR	•	•	•	•			•			•		
	HR	•	•	•	•	•	•	•	•	•	•	•	•
	SHR				•	•	•	•	•	•	•	•	•
216 CDI/316 CDI/416 CDI/516 CDI 120 kW (163 bhp) OM 651 DE22LA diesel engine	SR	•	•	•	•			•			•		
	HR	•	•	•	•	•	•	•	•	•	•	•	•
	SHR				•	•	•	•	•	•	•	•	•
219 CDI/319 CDI/419 CDI/519 CDI 140 kW (190 bhp) OM 642 DE30LA diesel engine	SR	•	•	•	•			•			•		
	HR	•	•	•	•	•	•	•	•	•	•	•	•
	SHR				•	•	•	•	•	•	•	•	•
316 NGT (bivalent) 115 kW (156 bhp) M 271 E 18 ML natural gas (CNG)/petrol engine	SR				•								
	HR				•	•							
	SHR				•	•							

		Panel van											
Permissible GVW [t]		3.0 t		3.5 t				4.6 t			5.0 t		
Wheelbase		S	M	S	M	L	XL	M	L	XL	M	L	XL
Roof height													
<b>Models with 4x4 drive</b>													
313 CDI 4x4/513 CDI 4x4 95 kW (129 bhp) OM 651 DE22LA diesel engine	SR				•						•		
	HR				•	•	•				•	•	•
	SHR				•	•	•				•	•	•
316 CDI 4x4/516 CDI 4x4 120 kW (163 bhp) OM 651 DE22LA diesel engine	SR				•						•		
	HR				•	•	•				•	•	•
	SHR				•	•	•				•	•	•
319 CDI 4x4/519 CDI 4x4 140 kW (190 bhp) OM 642 DE30LA diesel engine	SR				•						•		
	HR				•	•	•				•	•	•
	SHR				•	•	•				•	•	•

Legends for model range: Roof heights: SR = standard roof, HR = high roof, SHR = super-high roof Wheelbases/body: S = 3250 mm/Compact, M = 3665 mm/Standard, L = 4325 mm/Long, XL = 4325 mm/Extra-long (with long rear overhang of 2015 mm)

**Torque curves<sup>1</sup>:**

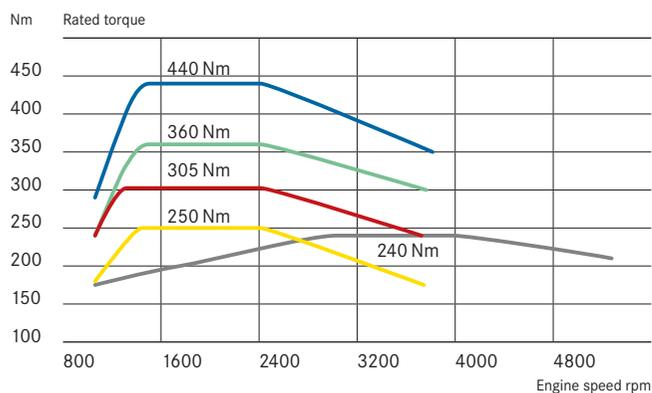

CDI engine OM 651 DE22LA	70 kW (95 bhp)
CDI engine OM 651 DE22LA	95 kW (129 bhp)
CDI engine OM 651 DE22LA	120 kW (163 bhp)
CDI engine OM 642 DE30LA	140 kW (190 bhp)
NGT/Petrol engine M 271 E 18 ML	115 kW (156 bhp)

<sup>1</sup> CDI engines certified to Euro V

# Engine data and model range

Engine		Diesel engines <sup>1</sup>					
		OM 651 DE22LA			OM 651 DE22LA		
Model		210 CDI	310 CDI	510 CDI	213 CDI	313 CDI	513 CDI
4x2 drive system		●	●	●	●	●	●
4x4 drive system		-	-	-	-	●	●
No. of cylinders/arrangement		4 in-line			4 in-line		
No. of valves per cylinder		4			4		
Displacement [cc]		2143			2143		
Rated output [bhp (kW)] at engine speed [rpm]		95 (70) 3800			129 (95) 3800		
Rated torque [Nm] at engine speed [rpm]		250 1400–2400			305 1200–2400		
Manual transmission	ECO Gear 6-speed manual transmission <sup>3</sup>	SE	SE	SE	SE	SE	SE
	NSG 370 6-speed manual transmission	-	-	-	-	-	-
Automatic transmission	7G-TRONIC 7-speed automatic transmission <sup>4</sup>	Option	Option	-	Option	Option	Option
	NAG W5A 380 5-speed automatic transmission	Option <sup>5</sup>	Option <sup>5</sup>	-	Option <sup>5</sup>	Option <sup>5</sup>	Option <sup>5</sup>
Fuel type		Diesel			Diesel		
Tank capacity [l]		Approx. 75			Approx. 75		
Capacity of compressed gas tank <sup>6</sup> /liquefied gas tank [l]		-			-		
Permissible GVW [kg]		3000	3500	5500	3000	3500	5000
Permissible GCW [kg]		5000	5500	6000/7000	5000	5500/6300 <sup>7</sup>	7000
Towing capacity <sup>8</sup> braked/unbraked [kg]		2000/750	2000/750	2000/750	2000/750	2000/750	2000/750

<sup>1</sup> For vehicles with commercial vehicle registration, all model variants with OM 651 (Euro V) and OM 642 (Euro V) are also optionally available with the consumption- and emission-reducing BlueEFFICIENCY package (see page 16). For vehicles with passenger car registration the efficiency package is standard equipment <sup>2</sup> In conjunction with the OM 642 CDI diesel engine, the Sprinter Crewbus is only approvable with a reference mass greater than 2610 kg. Your Mercedes-Benz dealer will be pleased to inform you about the effect on the configuration you desire for your vehicle <sup>3</sup> The ECO Gear 360 six-speed manual transmission is available for the 4-cylinder CDI diesel engines, while the ECO Gear 480 six-speed manual transmission is available for the 6-cylinder CDI diesel engine <sup>4</sup> Expected to be available from 1<sup>st</sup> quarter 2012. Until replacement the NAG W5A 380 5-speed automatic transmission will be delivered <sup>5</sup> In all probability the current NAG W5A 380 5-speed automatic transmission will be delivered until the 1<sup>st</sup> quarter 2012 <sup>6</sup> Depending on the number and capacity of the pressurised gas tanks. Additional tanks are available as optional equipment for the 3.5-t variant. Additional tanks are not available for the 5-t variant <sup>7</sup> Increased permissible GCW in conjunction with reinforced trailer coupling as optional equipment <sup>8</sup> Towing capacity (braked) of up to max. 3500 kg available as an option, depending on permissible gross vehicle weight and powertrain version

Key: SE = Standard equipment, Option = Optional equipment, - = not available.

Diesel engines <sup>1</sup>							Natural-gas/petrol engine <sup>2</sup>
OM 651 DE22LA			OM 642 DE30LA				M 271 E 18 ML
216 CDI	316 CDI	516 CDI	219 CDI	319 CDI	419 CDI	519 CDI	316 NGT
●	●	●	●	●	●	●	●
-	●	●	-	●	-	●	-
4 in-line			6/V 72°				4 in-line
4			4				4
2143			2987				1796
163 (120) 3800			190 (140) 3800				156 (115) 5500
360 1400-2400			440 1400-2400				240 3000-4000
SE -	SE -	SE -	SE -	SE -	SE -	SE -	- SE
Option Option <sup>5</sup>	Option Option <sup>5</sup>	Option Option <sup>5</sup>	Option Option <sup>5</sup>	Option Option <sup>5</sup>	Option Option <sup>5</sup>	Option Option <sup>5</sup>	- Option
Diesel			Diesel				Natural gas (CNG) and premium unleaded
Approx. 75			Approx. 75				Petrol tank approx. 100 (bivalent)
-			-				Approx. 125-210
3000	3500	5000	3000	3500	4600	5000	3500
5000	5500/6300/ 7000 <sup>7</sup>	7000	5000	6300/7000 <sup>7</sup>	7000	7000/8000	5500
2000/750	2000/750	2000/750	2000/750	2000/750	2000/750	2000/750	2000/750

# Fuel consumption and CO<sub>2</sub> emissions

Determined in accordance with Directive 80/1268/EEC for vehicles with 4x2 drive system

Model	Emissions standard <sup>1</sup>	Transmission	Rear axle ratio <sup>2</sup>
<b>Sprinter panel van</b>			
210 CDI/310 CDI	Euro V/EEV <sup>5</sup>	M6	4.364
		A5	4.364
		A7 <sup>6</sup>	4.182
213 CDI/313 CDI	Euro V/EEV <sup>5</sup>	M6	3.923
		A5	4.182
		A7 <sup>6</sup>	3.923
216 CDI/316 CDI	Euro V/EEV <sup>5</sup>	M6	3.923
		A5	3.923
		A7 <sup>6</sup>	3.692
219 CDI/319 CDI	Euro V/EEV <sup>5</sup>	M6	3.923
		A5	3.923
		A7 <sup>6</sup>	3.692

for vehicles with standard commercial vehicle registration

CO <sub>2</sub> emissions, combined <sup>3,4</sup> [g/km]	Fuel consumption <sup>3,4</sup> [MPG]		
	Urban	Extra-urban	Combined
235–248	24.4	36.7	31
246–259	25.7	31.7	29.4
?	?	?	?
208–225	27.2	37.7	33.2
227–241	26.9	35.3	32.1
?	?	?	?
208–225	27.2	37.7	33.2
225–238	28	35.3	32.1
?	?	?	?
260–271	20.8	34.9	28.3
262–272	23.3	32.1	28.3
?	?	?	?

for vehicles with standard commercial vehicle registration with optional BlueEFFICIENCY package

CO <sub>2</sub> emissions, combined <sup>3,4</sup> [g/km]	Fuel consumption <sup>3,4</sup> [MPG]		
	Urban	Extra-urban	Combined
222–235	26.2	36.2	31.7
–	–	–	–
?	?	?	?
195–211	30.1	39.2	35.3 <sup>8</sup>
–	–	–	–
?	?	?	?
195–211	30.1	39.2	35.3
–	–	–	–
?	?	?	?
253–264	21.4	34.4	28.2
–	–	–	–
?	?	?	?

Determined in accordance with Directive 80/1268/EEC for vehicles with 4x2 drive system

Model	Emissions standard <sup>1</sup>	Transmission	Rear axle ratio <sup>2</sup>
<b>Sprinter NGT, panel van with natural gas/petrol engine</b>			
Natural gas operation			
316 NGT bivalent	EEV	M6	4.727
	Euro V	A5	4.727
For petrol operation			
316 NGT bivalent	Euro V	M6	4.727
		A5	4.727

for vehicles with standard commercial vehicle registration

CO <sub>2</sub> emissions, combined <sup>3,4</sup> [g/km]	Fuel consumption <sup>3,4,9</sup> [MPG]		
	Urban	Extra-urban	Combined
<b>Fuel consumption<sup>3,4,9</sup> [MPG]</b>			
254-263	14.0	25.5	19.5
240-249	15.6	25.5	20.6
<b>Fuel consumption<sup>3,4</sup> [MPG]</b>			
317-329	15.7	25.7	20.8
296-308	17.5	25.7	22.2

<sup>1</sup> Diesel particulate filter is standard equipment for all CDI diesel engines

<sup>2</sup> The rear axle ratio indicated is standard. Further rear axle ratios are available as options

<sup>3</sup> The figures indicated were obtained in accordance with the prescribed measuring process (currently valid version of Directive 80/1268/EEC). The figures do not apply to a specific individual vehicle and do not form part of the product offer; they are provided solely for purposes of comparison between vehicle models. Consumption and emissions figures only apply to vehicles which have a gross weight of up to 3.5 t and are registered as commercial vehicles. The figures depend on the kerb weight of the vehicle (including driver, 75 kg), the transmission variant and the rear-axle ratio. These figures may vary in real-life operation, depending on driving style and load status of the vehicle. Figures for fuel consumption and CO<sub>2</sub> emissions are higher with an activated all-wheel-drive system

<sup>4</sup> Figures apply to all kerb weight categories

<sup>5</sup> Optionally available

<sup>6</sup> Expected to be available from 1<sup>st</sup> quarter 2012. Until replacement the NAG W5A 380 5-speed automatic transmission will be delivered

<sup>7</sup> The current figures were unfortunately not available at the time this brochure went to press

<sup>8</sup> The combined fuel consumption of the Sprinter 213/313/216/316 CDI in conj. w. the BlueEFFICIENCY package, standard manual transmission and an optional rear-axle ratio of 3.692 is 34.9 mpg

<sup>9</sup> Fuel consumption figures for natural gas H in mpg

Key: M6 = 6-speed manual transmission, A5 = 5-speed automatic transmission, A7 = 7G-TRONIC 7-speed automatic transmission, - = not available

# The Sprinter panel van at a glance

		Short with 3250 mm wheelbase		Medium with 3665 mm wheelbase		
						
		Standard roof	High roof	Standard roof	High roof	Super-high roof
<b>Cargo area [m<sup>2</sup>]</b>		4.4	4.4	5.2-5.5	5.2-5.5	5.2-5.5
<b>Cargo volume [m<sup>3</sup>]</b>		7.5	8.5	9.0	10.5	11.5
<b>Max. loading length [mm]</b>		2600	2600	3265	3265	3265
<b>Kerb weight<sup>1,2</sup> [kg] with perm. GVW</b>	3.0 t	2120-2180	2155-2215	2205-2270	2235-2300	-
	3.5 t	2145-2205	2180-2240	2230-2295/2390 <sup>2</sup>	2260-2329/2420	2295-2360/2455 <sup>2</sup>
	5.0 t	-	-	2490-2530	2520-2560	2550-2595
<b>Payload<sup>3</sup> [kg] with perm. GVW</b>	3.0 t	820-880	785-845	730-795	700-765	-
	3.5 t	1295-1355	1260-1320	1110 <sup>2</sup> /1205-1270	1080 <sup>2</sup> /1175-1240	1045 <sup>2</sup> /1140-1205
	5.0 t	-	-	2470-2510	2440-2480	2405-2445
<b>Permissible GVW [kg]</b>		3000/3500	3000/3500	3000/3500/4600/5000	3000/3500/4600/5000	3500/4600/5000
<b>Max. roof load [kg]</b>		300	150	300	150	-
<b>Track circle/turning circle Ø [m]</b>		12.3	12.3	13.6	13.6	13.6

<sup>1</sup> Figures according to respective version of Directive 92/21/EEC or 97/27/EC, whichever is applicable for the vehicle category in question at the time of going to press, (kerb weight incl. tools/spare wheel and, if applicable, trailer coupling, if supplied by manufacturer, fuel tank 90% full, driver and, if applicable, luggage) for standard-specification vehicles. Optional equipment and accessories will generally increase this figure and reduce the payload accordingly. Note: according to ISO-M06 1176, the kerb weight figures are reduced by up to 75 kg

<sup>2</sup> Vehicles with all-wheel drive: kerb weight is increased by c. 130-165 kg

<sup>3</sup> Vehicles with all-wheel drive: payload decreases by c. 130-165 kg

**Long with 4325 mm wheelbase**

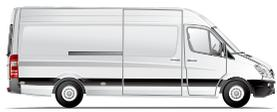

High roof	Super-high roof
7.1-7.4	7.1-7.4
14.0	15.5
4300	4300
-	-
2415-2480/2595 <sup>2</sup>	2445-2510/2625 <sup>2</sup>
2710-2750	2525-2580
-	-
905 <sup>2</sup> /1020-1085	875 <sup>2</sup> /990-1055
2250-2290	2220-2260
3500/4600/5000	3500/4600/5000
150	-
15.6	15.6

**Extra-long with 4325 mm wheelbase and long rear overhang of 2015 mm**



High roof	Super-high roof
7.8-8.0	7.8-8.0
15.5	17.0
4700	4700
-	-
2475-2535	2505-2565
2765-2805	2570-2625
-	-
965-1025	935-995
2195-2235	2165-2205
3500/4600/5000	3500/4600/5000
150	-
15.6	15.6

Short with 3250 mm wheelbase

Standard roof

High roof

Medium with 3665 mm wheelbase

Standard roof

High roof

Super-high roof



H up to approx.  
585/687<sup>1</sup>



H up to approx.  
585/690<sup>1</sup>



H up to approx.  
637/790<sup>2</sup>



H up to approx.  
637/790<sup>2</sup>

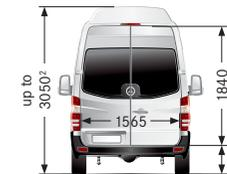

H up to approx.  
637/790<sup>2</sup>

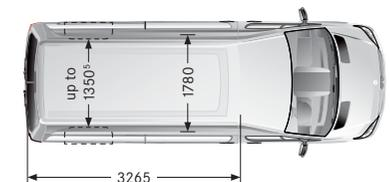
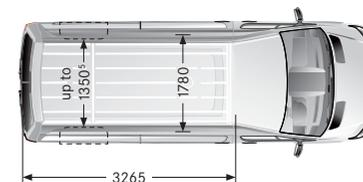
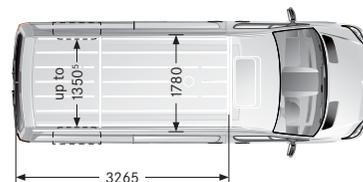
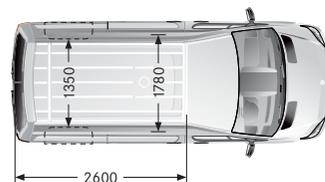
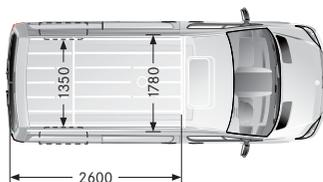
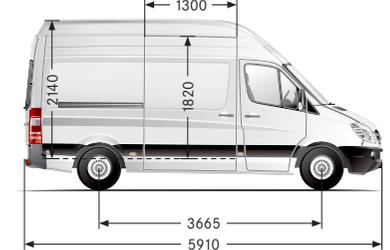
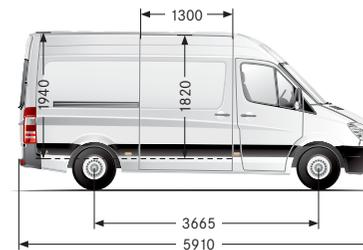
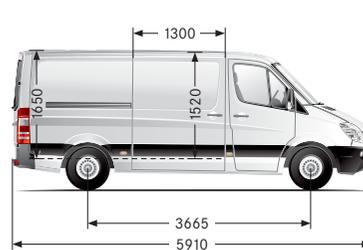
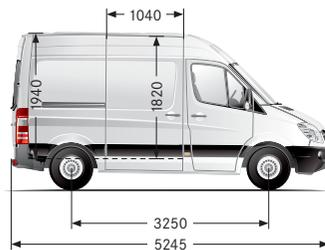
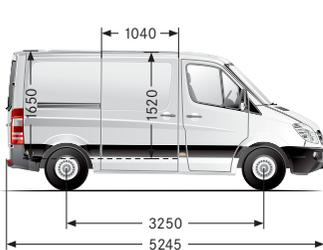

<sup>1</sup> Unladen  
All dimensions are in mm. All weights apply to standard-specification vehicle

<sup>2</sup> Unladen. All-wheel drive increases the height of the vehicle by up to 85 mm

Long with 4325 mm wheelbase  
High roof

Super-high roof

Extra-long with 4325 mm wheelbase and long rear overhang of 2015 mm  
High roof

Super-high roof

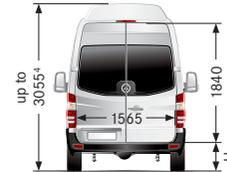
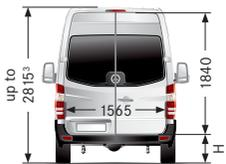

H up to approx.  
640/785<sup>3</sup>

H up to approx.  
640/785<sup>3</sup>

H up to approx.  
647/790<sup>4</sup>

H up to approx.  
647/790<sup>4</sup>

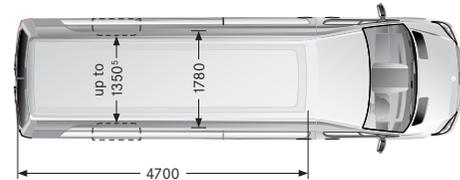
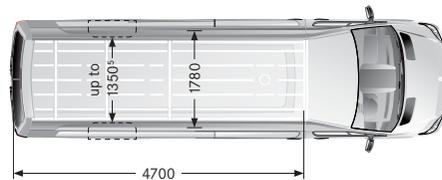
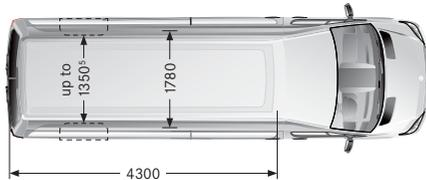
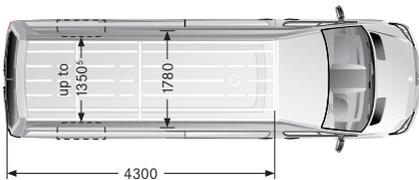
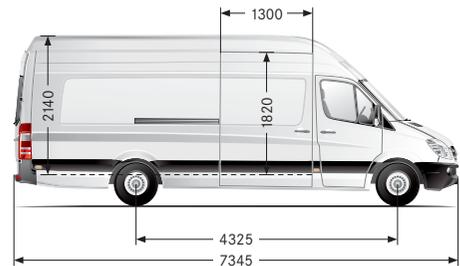
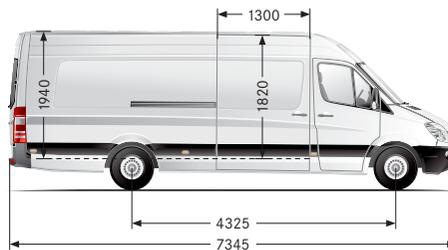
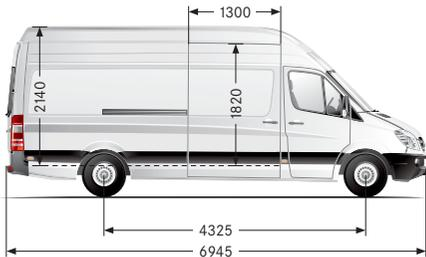
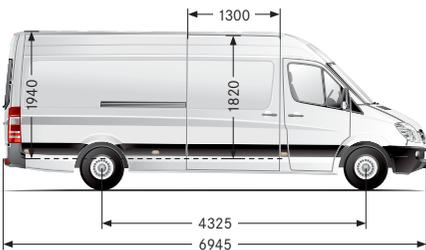

<sup>3</sup> Unladen. All-wheel drive increases the height of the vehicle by up to 95 mm

<sup>4</sup> Unladen. All-wheel drive increases the height of the vehicle by up to 80 mm

<sup>5</sup> Vehicles with a perm. GVW of 4.6 tons and super-single tyres and vehicles with 5.0 t perm. GVW and twin tyres feature different through-loading widths between wheel arches

# Glossary

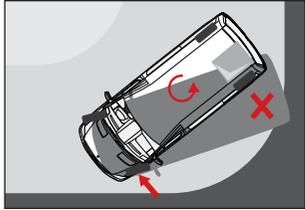

## ADAPTIVE ESP® Electronic Stability Program

ADAPTIVE ESP® is an innovative dynamic handling control system which, for the first time, also takes the vehicle load into account. It actively intervenes in certain hazardous driving situations, e.g. if there is an imminent risk of skidding, by applying a braking force to one or more wheels and adjusting the engine output as required so as to help the driver deal with the hazardous situation. As well as aiding directional stability, ADAPTIVE ESP® combines the functions of the anti-lock braking system (ABS), acceleration skid con-

trol (ASR), electronic brake force distribution (EBD), Brake Assist (BAS) and the optional Start-off Assist system. In addition to this, ESP® Trailer Stability Assist enhances handling safety when towing a trailer.

### A word of advice:

**ADAPTIVE ESP® can only act within the laws of physics. It is therefore impossible for ADAPTIVE ESP® to prevent skidding resulting from aquaplaning, for example. If the driver exceeds the physical limits, even ADAPTIVE ESP® will not be able to prevent an accident!**

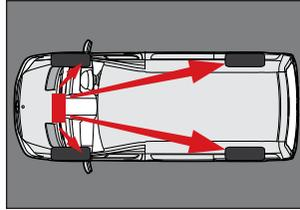

## Electronic brake force distribution (EBD)

Electronic brake force distribution (EBD) proportions the braking force between the front and rear wheels of the van as required, in order to optimise braking efficiency in all driving situations. In this way the system prevents “overbraking” of the rear wheels, which could cause the tail to start sliding. At the same time EBD puts less stress on the front brakes, which reduces the risk of fading due to overheating.

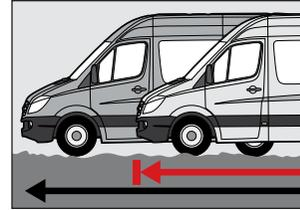

## Brake Assist (BAS)

In tests carried out in the driving simulator, our research engineers established that drivers do not apply the brakes vigorously enough during emergency braking. This finding led them to develop Brake Assist. From the speed at which the brake pedal is depressed, Brake Assist is able to detect a situation where emergency braking is required. In such a situation the system automatically increases braking power, aided by the anti-lock braking system (ABS) which prevents the wheels from locking up.

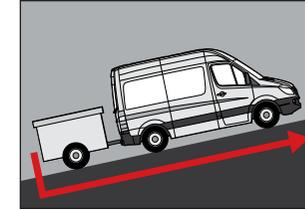

## Start-off Assist

Start-off Assist, an integral part of the ESP®, makes it easier to start off on uphill slopes: after the brake pedal is released, the brake pressure is maintained for approximately two seconds, allowing the driver to move their foot from the brake pedal to the accelerator without having to worry about the vehicle starting to roll. Start-off Assist is activated on uphill slopes of approx. 4% or steeper. It is not activated when starting off on the flat or on a downhill slope.

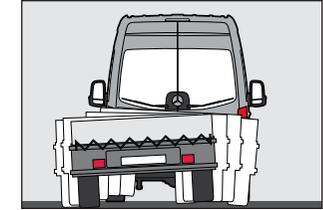

## ESP® Trailer Stability Assist

This system complements ADAPTIVE ESP® and enhances driving safety when towing a trailer, selectively braking the wheels of the towing vehicle and reducing engine torque when the trailer fishtails, thereby helping the driver to stabilise the combination. If the system intervenes several times in succession, the braking action becomes increasingly stronger, resulting in a significant reduction in vehicle speed.

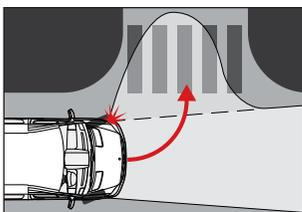

#### Bi-xenon headlamps with Add-Light system and cornering light function

Conventional headlamps are unable to provide sufficient illumination of the area to the side immediately ahead of a vehicle. This is particularly true on tight bends, at junctions and when manoeuvring. In situations like these, the illumination provided by the low-beam headlamps is complemented by an additional light source: the Add-Light system operates when cornering at speeds up to 70 km/h, while the cornering light function is activated when the direction indicator is operated at speeds up to 40 km/h – depending on the steering angle in both cases.

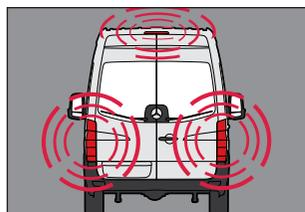

#### Adaptive brake lights

The adaptive brake lights enhance active safety as they give a clearer signal when the vehicle is braked in an emergency. This is achieved thanks to the fact that all the brake lights start to flash in the event of emergency braking at speeds above 50 km/h, thus warning following traffic and shortening the reaction times of the drivers. If the vehicle is braked to a standstill from a speed of more than 70 km/h, the hazard warning lights are activated automatically.



#### Windowbags and thorax bags

The Sprinter can be equipped with windowbags and thorax bags to complement the driver and passenger front airbags. In a severe side impact, the windowbag serves to increase the degree of protection available for the head of the occupant on the impact side. It deploys in the area of the side windows. Housed in the outside bolsters of the seat backrests, thorax bags are designed to provide increased protection for the thorax of the seat occupant.

#### A word of advice:

**Airbags in no way diminish the need for occupants to fasten their seat belts correctly before every journey: an airbag can only provide its full protective effect if the occupant is wearing the seat belt correctly.**

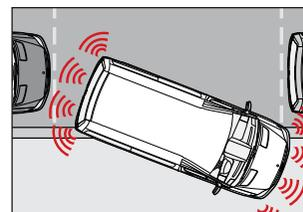

#### PARKTRONIC

The PARKTRONIC parking aid assists the driver when parking and manoeuvring with little room to spare. The system, which operates on the echo sounder principle, automatically warns the driver if it detects that the vehicle is close to an obstacle in front of or behind the vehicle. The warning is provided initially in the form of a visual display in the centre of the instrument panel (when moving forward) and in the exterior mirror (when reversing). If the gap continues to decrease, an audible warning is also activated.



#### ECO start/stop function

Under certain conditions the system shuts off the engine automatically if the vehicle is stationary for more than three seconds without the driver engaging a gear or using the clutch pedal. If the clutch pedal is depressed or the vehicle moves, the engine is automatically restarted.

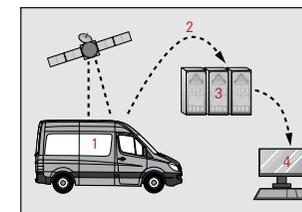

#### FleetBoard Telematics services

With its telematics services especially developed for vans, Daimler FleetBoard enables cost savings of 10% and more. The data support the fleet operators among other things in the reduction of fuel costs, optimum maintenance interval planning and an increase in efficiency thanks to professional tour planning and dynamic order processing. Via an interface in the vehicle (1), the FleetBoard TiiRec vehicle computer accesses the vehicle's electronics. Via GSM/GPRS (2), the vehicle's data and trip data are transmitted to the server at the FleetBoard Service Center (3) from where they are made available – password protected – to the fleet operator via internet (4). For comprehensive information on Daimler FleetBoard and product range offered, please visit [www.fleetboard.com](http://www.fleetboard.com)

# Working for your success

Mercedes-Benz is never far away: with some 2600 conveniently situated outlets, we have one of Europe's most extensive service networks for vans. But we offer much more besides: our vehicle services and mobility packages as well as our individual leasing, financing and insurance solutions can help your business to operate competitively and cost-effectively – both with regard to procurement of the vehicle and throughout its entire useful life.

You can experience our comprehensive range of services in our extensive network of company-owned sales and service outlets or at your local dealership. Your Mercedes-Benz service advisor will be pleased to provide you with detailed advice on what is available and what best suits your needs.

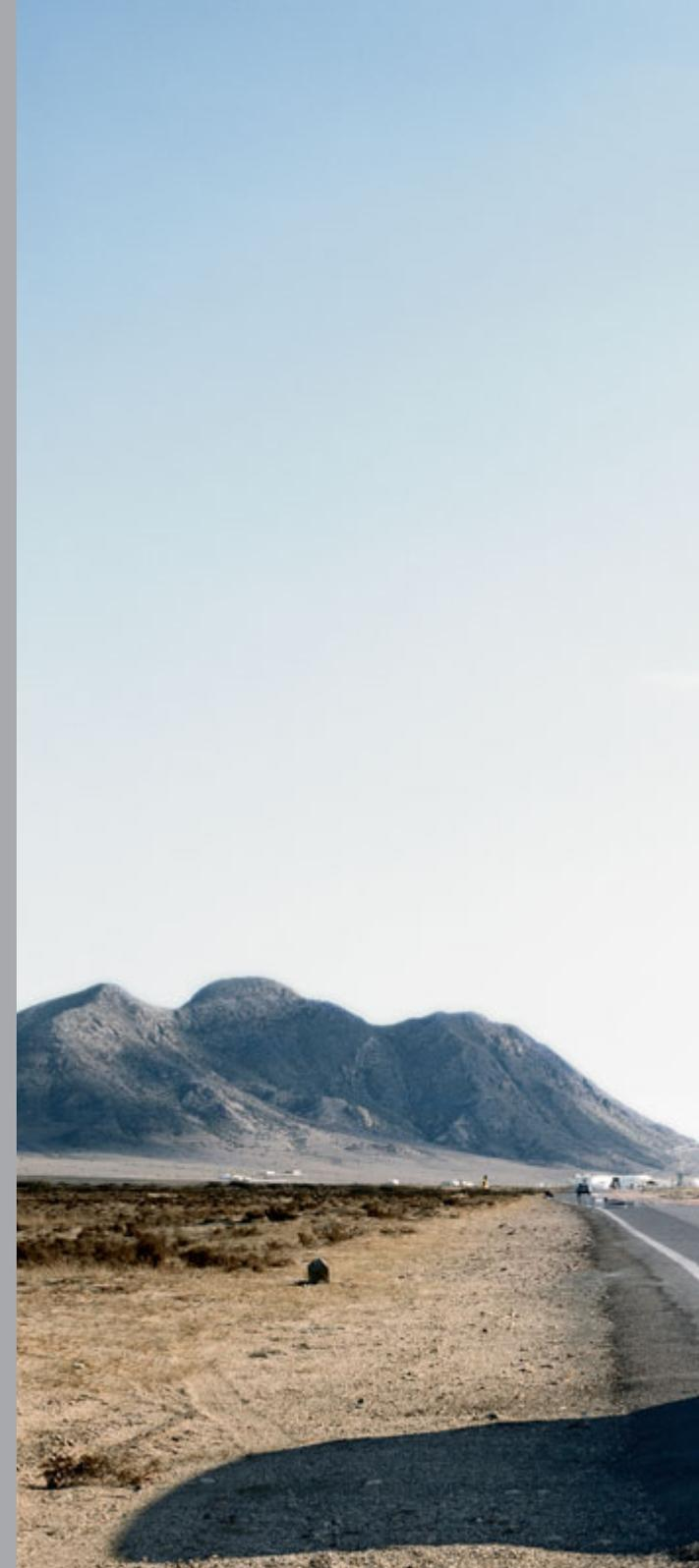

## Finance, leasing and insurance

Ownership options

Hire purchase

Agility

Leasing options

Finance lease

Operating lease

Contract hire

Insurance options

Van insurance

Finance GAP insurance

Invoice Gap insurance

## Service and parts

Extended opening hours

Mercedes-Benz Service24h

Mercedes-Benz ExpressService

Mercedes-Benz MobilityGo

MercedesServiceCard

Mercedes-Benz Genuine Parts

Mercedes-Benz Genuine  
Remanufactured Parts



## Financing, leasing and insurance

---

You've found the ideal vehicle for your requirements but want to remain flexible in financial terms? Ask the financing experts at Mercedes-Benz Financial Services about our offers tailored to your needs giving you greater leeway with your budget. Whether you are looking for leasing, financing or insurance, we can provide them all. For more information about the financing and leasing services available from Mercedes-Benz Financial Services visit [www.mbvans.co.uk](http://www.mbvans.co.uk)

### Mercedes-Benz Financing

Vehicle financing from Mercedes-Benz Financial Services puts you behind the wheel of your chosen vehicle with manageable instalments. Regardless of the financing method you choose, you own your new vehicle, yet retain your financial flexibility. The monthly instalments are calculated on the basis of the following criteria:

- ▶ Purchase price
- ▶ Annual percentage rate
- ▶ Initial payment
- ▶ Period of agreement
- ▶ Final instalment
- ▶ Total mileage (in case of balloon financing)

#### Our financing products:

- ▶ Hire Purchase
- ▶ Hire purchase with balloon
- ▶ Agility

#### Your benefits at a glance:

- ▶ Faster access to the vehicle you want
- ▶ Fixed interest rate throughout the entire period of the agreement
- ▶ Clear calculation basis
- ▶ Transparent costs
- ▶ One partner: Mercedes-Benz

### Mercedes-Benz Leasing

You'd like to drive a new vehicle equipped to your own specification and only pay for using it? Then leasing is ideal for you. Attractive instalments mean that only a small amount of capital is tied up and you know the exact amount of the monthly costs involved; this provides a better planning basis for your business, while ensuring that your credit potential is maintained. The vehicle remains the property of the lessor – Mercedes-Benz Financial Services. The following criteria are used to calculate the level of the monthly leasing instalments:

- ▶ Purchase price
- ▶ Initial payment
- ▶ Period of agreement
- ▶ Mileage to be covered during agreement
- ▶ Fixed residual value of vehicle (not applicable to finance lease)

#### Our leasing products:

- ▶ Finance lease
- ▶ Operating lease
- ▶ Contract hire

#### Your benefits at a glance:

- ▶ Faster access to the vehicle you want
- ▶ You always have an up-to-date vehicle
- ▶ No capital tied up
- ▶ Fixed monthly instalments
- ▶ You choose the mileage and duration of the agreement
- ▶ At the end of the lease period, you simply return the vehicle
- ▶ As a business user, you can claim the monthly instalments as business expenses

### Mercedes-Benz Insurance

Regardless of where your Mercedes-Benz vehicle takes you, you can travel with the extra peace of mind that comes from our extensive insurance packages with attractive terms. And, of course, they come with the high standard of quality you expect from Mercedes-Benz.

#### Our insurance products:

- ▶ Van insurance
- ▶ Finance GAP insurance
- ▶ Invoice GAP insurance

#### Your benefits at a glance:

- ▶ Attractive terms matched to the Mercedes-Benz vehicle range
- ▶ Specialised van insurance packages
- ▶ In the event of damage, vehicle is routed to a Mercedes-Benz service partner for repair with Mercedes-Benz genuine parts

## Mercedes-Benz CharterWay

---

The most experienced name in the market, CharterWay is the professionals' choice for combined services for Mercedes-Benz commercial vehicles:

**CharterWay Service.** This product line brings together maintenance and repair activities in three separate service packages: BestBasic, Select, and Complete. The cover provided ranges from a simple warranty extension to coverage of all prescribed maintenance work to complete cover including wear and tear repairs.

**CharterWay ServiceLeasing.** This Mercedes-Benz CharterWay product combines simple leasing with one of the three CharterWay service packages (BestBasic, Select or Complete). In this way, all your requirements from vehicle procurement to management to workshop service are covered with just one product.

**CharterWay Rental<sup>1</sup>.** Our rental offers allow you to increase your transport capacity flexibly on a short-term or long-term basis without having to tie up capital with all the risks which that entails.

For individual advice, please consult your Mercedes-Benz dealer or refer to Mercedes-Benz CharterWay at [www.mbvans.co.uk](http://www.mbvans.co.uk)

## Service and parts

---

**Extended opening hours.** Many Mercedes-Benz service outlets are open from Monday to Friday until 8 p.m. some till 10 p.m. and others around the clock.

**Mercedes-Benz Service24h.** If your Mercedes should ever have starting problems or break down en route, our free<sup>2</sup> Service24h hotline (on 00800 3 777 7777) will arrange expert assistance for you as quickly as possible. This Hotline can be accessed from all European countries. 365 days a year, 24 hours a day, our service teams make sure that you are back on your way again without delay.

**Mercedes-Benz ExpressService.** Oil changes and the smaller maintenance tasks along with the replacement of wear parts and minor repairs can be performed without having to make an appointment and often at a fixed price. Most of these tasks can be completed within 2 hours.

**Mercedes-Benz MobilityGo.** Mercedes-Benz MobilityGo gives you free on-the-spot breakdown or starting assistance should your vehicle break down or fail to start; the free MobilityGo service package also includes payment of taxi fares and the provision of a replacement vehicle. We will also keep you mobile and pay your costs if your vehicle has to go into the workshop under warranty and the repairs are likely to take more than two hours. Your Mercedes-Benz dealer will be happy to provide you with further details about MobilityGo conditions and coverage.

**MercedesServiceCard.** This guaranteed payment card ensures fast, straightforward assistance at authorised workshops throughout Europe. It also speeds up the processing of calls to Service24h and can be used to pay tunnel and toll charges as well as fuel bills.

**Mercedes-Benz Genuine Parts.** Mercedes-Benz Genuine Parts undergo rigorous material and functional testing, are engineered to fit your vehicle perfectly and remain available for 15 years after the end of series production.

**Mercedes-Benz Genuine Remanufactured Parts.** If your van has been on the road for some time, Mercedes-Benz Genuine Remanufactured Parts are an ideal choice. Reconditioned in accordance with the current state of the art, they are subjected to the same function checks as new parts and come with the same high guaranteed quality as that of our Mercedes-Benz Genuine Parts. There's one key difference: they cost up to 50% less!

<sup>1</sup> Available in selected countries only

<sup>2</sup> This hotline number can be called toll-free from landline phones and mobile phones. In some European countries, calls from mobile phones are subject to a charge set by the network operator. If your network operator does not permit international/free calls, we recommend that you use the relevant supplementary number for the country concerned as an alternative. This can be found on the Service24h sticker in your vehicle

# Test the Sprinter

Test drive the vehicle of your dreams

Nowhere is a Mercedes more at home than on the road. This is the only way to experience the effortlessly superior driving feel that makes every model so special. Discover the extent to which the Sprinter's variability, high level of comfort and cost-effectiveness can enrich your company by accepting our invitation to take a test drive. Your Mercedes-Benz dealer will be happy to make all the necessary arrangements for you. Simply visit [www.mbvans.co.uk](http://www.mbvans.co.uk) to locate your nearest Mercedes-Benz dealer. We look forward to seeing you.

You can also find the Owner's Manual for the Sprinter on the internet to help you become acquainted with the functions and features which await you. Please go to [www.mbvans.co.uk](http://www.mbvans.co.uk) and look at owners manuals in the service section.





**Take-back of end-of-life vehicles.** Coming full circle. At the end of its long working life, you can return your Sprinter to us for environment-friendly disposal in accordance with the EU End-Of-Life Vehicle Directive. But that day lies a long way off. The take-back of end-of-life vehicles applies in accordance with national regulations for vehicles with a perm. GVW of up to 3.5 t. The Sprinter has met the statutory regulations governing the suitability of the vehicle's design for re-use and recycling for a number of years now. A network of vehicle take-back depots and dismantlers has been established which will process your vehicle in an environment-friendly manner. The ways in which both vehicles and parts can be recovered are subject to ongoing development and improvement. Consequently, the Sprinter will be able to comply with any future increases in the recycling quota within the stipulated time limits. For further information, visit [www.mbvans.co.uk](http://www.mbvans.co.uk) and/or call your national hotline.

**Please note:** changes may have been made to the product since this brochure went to press (15.04.2011). The manufacturer reserves the right to make changes to the design, form, colour and specification during the delivery period, provided these changes, while taking into account the interests of the vendor, can be deemed reasonable with respect to the purchaser. Where the vendor or the manufacturer uses symbols or numbers to describe an order or the subject of an order, no rights may be derived solely from these. The illustrations and descriptions may show or refer to accessories and items of optional equipment which are not part of standard specification. Colours may differ slightly from those shown in the brochure, owing to the limitations of the printing process. This brochure may contain models and services which are not available in certain countries.

This brochure is distributed internationally and may contain models and services which are not available in certain countries. Information given regarding statutory regulations, legal requirements and taxation applies only to the Federal Republic of Germany at the time of going press. Please consult your Mercedes-Benz van dealer for final details and for information about the statutory regulations and legal requirements which apply in other countries.

[www.mbvans.co.uk](http://www.mbvans.co.uk)