



VOLVO XC90



THERE'S MORE TO LIFE THAN A VOLVO. THERE'S GETTING WHERE YOU WANT TO GO. THERE'S GETTING THERE IN STYLE AND COMFORT. THERE'S POWER, AGILITY AND UNRESTRICTED PLEASURE. AND THERE'S DESIRE. DESIRE TO ENJOY THE BEST AND DESIRE TO SHARE THIS WITH THOSE YOU LOVE, NO MATTER WHERE YOUR JOURNEY TAKES YOU. THAT'S WHY YOU SHOULD TAKE A CLOSER LOOK AT THE XC90.

CONTENTS

THE VOLVO XC90

Driver's environment	10
Passenger comfort	12
In-car entertainment	18
Performance	22
Personal security	24
Safety & Environment	26

YOUR VOLVO XC90

Engines & Equipment	32
Style guide	34
Exterior design	36
Interior design	40
Executive	46
R-DESIGN	50
Features, Options & Accessories	52

www.volvocars.com



The subtle application
of pure strength.

The XC90 wouldn't be the superb SUV it is without a little muscle. But the application of power without discrimination has never been our business, and here, you'll find no exceptions. Amongst a wealth of outstanding performance enhancing technology you'll find features such as AWD with Instant Traction and six-speed Geartronic transmission with a winter setting.

Harmonising power with subtlety can be a bridge too far for many SUV's. But with one depression of the accelerator pedal on an XC90, you'll feel equal parts muscle and grace and instantly enjoy what is surely one of nature's most potent combinations.



Expect more and that's exactly what you'll get.

As you settle back into the sumptuous leather interior, let the waves of music from the Premium Sound music system wash over you and feel the confident, quiet purr of a masterful V8 engine, we suggest you try this short mental exercise.

Look around you. Feel the contentment from your companions. Take a deep breath. Then try to remember what you once called expectations.



You can leave it, but it will never leave you.

Why do the most profound experiences leave the deepest impression? Take the interior of the XC90. No matter what the world outside is doing, you, your friends or your family will be enveloped in an environment that is as calm and understated as it is luxurious. No surprise there really. This SUV was created for people who are dedicated to pleasure – and to sharing it. The only downside is that you'll occasionally have to leave your XC90. But don't worry. Experience this exceptional SUV once and it will never leave you.



Something this good was
always meant to be shared.



There are no second-class seats in the Volvo XC90. Painstaking craftsmanship and superior materials ensure that comfort and safety rule – from bumper to bumper. From its Interior Air Quality System to a child-friendly booster cushion, nothing and no-one has been forgotten in the pursuit of pure satisfaction. And like many of the good things in life, the Volvo XC90 was made to be shared. Now it's over to you.



Our designers are dreamers – are you?

Have you ever dreamt of a car that is as big as your life? A car with a choice of interior packages, each one an impeccable reflection of contemporary auto styling? Features that are as intuitive as they are facilitating and performance that takes you effortlessly from town to dirt track? We did. And we decided to share it with you. Why not climb in and join us in Dreamland?



64 expressions
of versatility.

Every one of the seven seats in the Volvo XC90 offers much more than superb comfort. They can also be configured in 64 different ways. Add the fact that every passenger seat can be folded flush and you have the perfect marriage of versatility and luxury. Loading is an easy job too – just open the liftgate section of the split tailgate for lighter objects or let both sections open wide for heavier loads.





Upgrade your
comfort zone.

Our relentless quest to deliver pleasure expresses itself emphatically within the welcoming cocoon of the Volvo XC90. Air control ensures that no matter what's happening on the other side of that toughened glass, you'll stay comfortable. Features such as integrated Bluetooth handsfree and our Road and Traffic Information system are at your fingertips – and service – whenever they're required. And dual screen Rear Seat Entertainment keeps things under control over your shoulder, should this be required.



When was the last time
you felt music?



There is one sure way to transform a journey into an event – add some good music. If you can do this through a system that leads the way in audio excellence, all the better.

Volvo's Premium Sound system delivers a seriously moving aural experience. It features a new digital class D amplifier, 12 high-end loudspeakers, Dolby® Pro Logic® II surround sound and is fully compatible with your iPod® or MP3 player. We could say more but in this case, we'll let the music do the talking.



It takes extraordinary character to shoulder big responsibility.

Engine power and an improved environment. To many, these terms sound like a contradiction. To us they represented a call to action.

A challenge to develop technology that doesn't compromise on performance while at the same time acknowledging our environmental responsibility. The result is a series of engines that break the mould – and a few records. The V8, for example, is the world's first Ultra Low Emission Vehicle II (ULEV II) compliant eight-cylinder engine. The D5 turbodiesel and six-cylinder petrol versions don't disappoint either – in terms of city and country driving pleasure or reduced emissions.

Carrying this power also presented challenges of its own. To meet these, design characteristics such as a low centre of gravity, precisely calculated weight distribution and high ground clearance were applied. As a result, you stay firmly and comfortably rooted to the road, no matter where it's taking you.



Sometimes a reduced pulse rate is preferred.

In the case of the Volvo XC90, relaxation is a state of mind not exclusive to driving or enjoying the ride. Leave this car and you'll be able to enjoy the same feeling. Tough door locks, an electronic immobiliser and laminated side windows help keep unwanted visitors at bay. Approach and Home Safe lighting provide welcome reassurance when entering and leaving the car in unlit areas. And should it be required, the Volvo On Call facility delivers its own particular calming effect.

Wherever it takes you, this SUV has the capacity to get your pulse racing. But when it comes to security, you'll be pleased to know it does exactly the opposite.



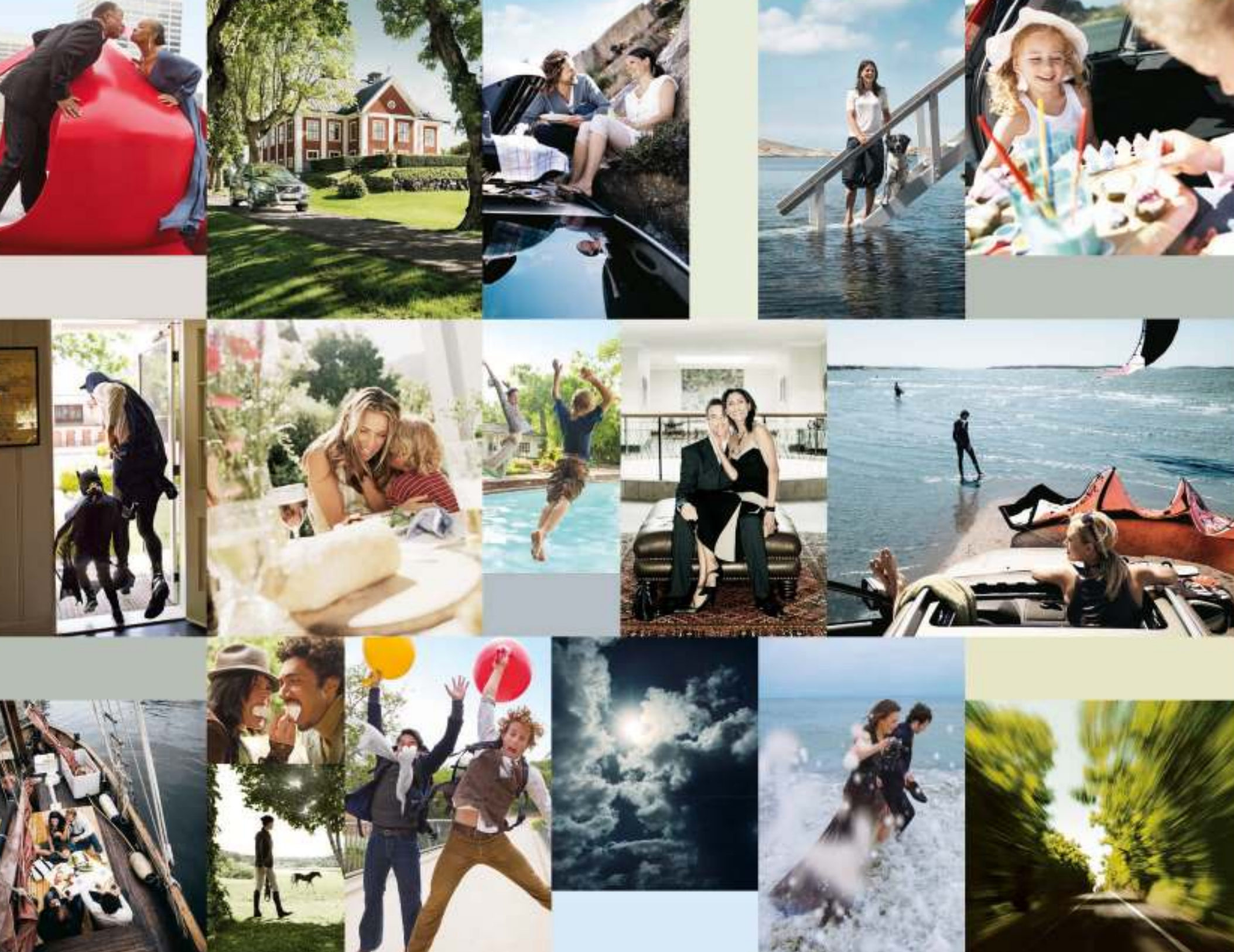

THERE'S MORE TO LIFE THAN A VOLVO. THAT'S WHY WE DESIGN OUR CARS TO SUPPORT YOU IN ANY SITUATION ON THE ROAD. THAT'S WHY OUR SAFETY TECHNOLOGY HAS PUSHED AUTOMOTIVE DEVELOPMENT FOR MORE THAN EIGHTY YEARS. THAT'S WHY WE AIM FOR A FUTURE WHERE CARS DON'T CRASH. THAT'S WHY WE LEAD THE WAY TO ZERO EMISSIONS, AND OFFER ONE OF THE PREMIUM SEGMENTS STRONGEST RANGES OF LOW CO₂ ALTERNATIVES. AND THERE ARE ALL THE REASONS IN THE WORLD TO MOVE THE BOUNDARIES FOR WHAT'S POSSIBLE AND WHAT'S NOT. THAT'S WHY WE INNOVATE FOR LIFE.

EYES IN THE BACK.

Park Assist alerts you if you're too close to an obstacle behind your car when reversing.

ALL-ROAD STABILITY.

Volvo's All-Wheel Drive (AWD) with Instant Traction™ enhances driving stability and traction in all weathers, all seasons and on all roads.

STAY ON TRACK.

Volvo's anti-skid system Dynamic Stability and Traction Control (DSTC) improves handling and safety in a wide range of challenging situations.

RAIN PROOF.

Water-repellent side windows improve vision in the rain, and a rain sensor automatically engages the wipers if it begins to rain or if water splashes onto your windscreen.

KEEP THE BALANCE.

Roll Stability Control (RSC) senses an impending rollover and helps stabilise the vehicle if needed.

24/7 PEACE OF MIND.

Stay cool. Volvo On Call is Volvo's integrated emergency and roadside assistance technology.

EXHILARATING COMFORT.

Ergonomic design in seats and driver's environment makes you relaxed and helps maintain your concentration on driving.

AN EYE ON THE BLIND SPOT.

The Blind Spot Information System (BLIS) helps you detect vehicles entering your blind spot.

ON-ROAD ENLIGHTENMENT.

Active Bending Lights (ABL) with Dual Xenon technology expands your vision range when driving in the dark and provides considerably improved illumination around bends.

Innovated for your enjoyment, the Volvo safety technologies will protect more than the fun of driving.

Across the world, Volvo equals safety. And that comes with good reason, because few carmakers can match our record of safety innovations and the commitment for safety that has guided us for more than 80 years. Of course, this makes us extremely proud. But we're not satisfied. Because we know what we want to achieve: zero accidents. This huge task calls for innovative thinking and a brand new approach to the way we design cars. Good news is we've already come a long way. For starters, our cars are more fun and engaging to drive than ever (because a bored driver will never be a safe driver). Neither is the technology needed any figment of the imagination – some is already available in your Volvo. This means driving a Volvo today is like having a first peek at a very exciting automotive future – a future where passionate engineering and design do more to help you get the most out of life.

After all, there's more to life than a Volvo.



Designed to catch the light brilliantly, this car also reflects a promise.

Thankfully, the automotive industry is moving away from fantasyland to the real world. Our journey towards a better environment started already in the early 70's. Then we were among the first carmakers to acknowledge the environmental downside of cars and to do something about it. Since then we are constantly innovating to reduce the environmental impact of the cars and how we make them.

Today's biggest challenge is, of course, to reduce the carbon dioxide emissions that cause climate change. Today we offer one of the premium segments strongest ranges of low CO₂ alternatives: the Volvo DRIVe variants. Utilising innovative power-train technology together with advanced aerodynamics, low friction technology and lightweight materials, the DRIVe range is an important step towards zero emissions.

In near future we will introduce new technology such as plug-in hybrid vehicles that will further reduce CO₂ emissions and can be charged from a standard wall socket. And we're heavily engaged in the development of electrical vehicles – a technology that will dramatically reduce the environmental footprint of our cars and make them even more fun to drive.

Good for you, and for the world we share.



85% RECYCLABLE.

To help minimise its total environmental impact, every Volvo is designed to facilitate recovery and recycling at the end of its useful life.

FRESH CABIN AIR.

A cabin filter removes dust, pollen and other particles from the incoming air. Continuously monitoring incoming air and shutting out carbon monoxide, ground-level ozone and nitrogen dioxide, Volvo's Interior Air Quality System helps ensure that the air you breathe in the vehicle is cleaner than that outside when driving in heavy city traffic.

MAXIMISED FUEL EFFICIENCY WITH DIESEL.

Volvo's advanced common rail turbodiesel technology ensures superior fuel economy and low CO₂ emissions, like the high-performance turbodiesel D5.

ALLERGY-TESTED INTERIOR MATERIALS.

All our upholsteries and interior textiles are tested for certain allergy-inducing or harmful substances and comply with Oeko-Tex Standard 100. And several interior metal details are tested with regard to contact allergies. Good for you, and for anyone who shares your ride.

FUEL-SAVING DESIGN.

To reduce energy-loss from wind and roll resistance, we utilise advanced aerodynamic design, light-weight materials and low-friction technology. Together with state-of-the-art engine technology, this lowers your CO₂ emissions and helps you travel further on less fuel.

CLEANER EXHAUST.

All Volvo engines comply with stringent international requirements – the V8 is the world's first ULEV II (Ultra-Low Emission Vehicle II) compliant eight-cylinder engine. Fast responding after a cold start, Volvo's advanced emission control eliminates between 95 and 99% of carbon monoxide, hydrocarbons and nitrogen oxides from petrol engine exhaust gases. The Volvo turbodiesels feature a particulate filter that removes about 95% of the particles from the diesel exhaust gases.



PETROL ENGINES

V8 AWD

auto
 322 CO₂ g/km
 13.5 l/100 km
 315 hp
 440 Nm

3.2 AWD

auto
 275 CO₂ g/km
 11.8 l/100 km
 238 hp
 320 Nm

DIESEL ENGINE

D5 AWD

man/auto
 219/224 CO₂ g/km
 8.3/8.5 l/100 km
 185 hp
 400 Nm

D3 FWD

auto
 224 CO₂ g/km
 8.5 l/100 km
 163 hp
 340 Nm

Technical data may be subject to change. Please talk to your Volvo dealer for the latest information.

N.B. The contents in the equipment levels may vary from country to country. Please ask your Volvo dealer for further information.

THE CREATION OF YOUR VOLVO STARTS UNDER THE HOOD. A major part of the experience ahead of you is defined by the engine you choose. Is it maximum performance and a sporty engine character that make your heart tick? Or do you prefer relaxed cruising and the highest possible fuel mileage? Whichever engine satisfies your requirements, you will enjoy instant power and smooth running while state-of-the-art fuel management systems make the most of every micro-drop of fuel. Pick your engine, and enjoy the drive.

EQUIP YOUR OWN VOLVO XC90. As you define your own style and specify your needs, choose one of Volvo's equipment levels – Kinetic, Momentum or Summum. These ample packages add luxury and comfort beyond the impressive standard equipment level and reflect our core belief that functionality and beauty go everywhere together. For more information about the different equipment levels, please contact your Volvo dealer or visit www.volvocars.com

KINETIC (STANDARD)

AUX input
 Airbag, passenger side
 Aluminium roof rails
 Aluminium wheels 17"
 Audio controls in steering wheel
 Colour-coordinated wheel arches
 Cruise control
 Cup holders, tunnel console
 Dynamic Stability and Traction Control (DSTC)
 Electronic Climate Control (ECC)
 Emergency Brake Assist (EBA)
 Floor mats
 Fog lights in front spoiler
 Illuminated vanity mirrors, driver and passenger
 Inflatable Curtain (IC)

Interior Air Quality System (IAQS)
 Leather-clad gear knob
 Leather-clad steering wheel
 Load protection net
 Marstrand upholstery
 Outside temperature gauge
 Performance audio package
 Power windows front and rear
 Remote control central locking
 Side Impact Protection System (SIPS)
 Steering wheel in height and reach adjustable
 Trip computer
 Watch dial instrument cluster
 Whiplash Protection System (WHIPS)

MOMENTUM

includes Kinetic equipment level plus the following:
 Aluminium inlays
 Auto dimming mirror
 Grocery bag holder
 High Performance audio package
 Leather upholstery
 Load cover
 Ground lighting
 Rain sensor
 Retractable rear-view mirrors
 Water repellent front side windows
 Power seat, driver and manual height adjustable, passenger seat

SUMMUM

includes Momentum equipment level plus the following:
 Aluminium wheels 18"
 Active Bending Lights (ABL)
 Chromed exterior details
 Front bumper bar
 Headlamp washers
 Heated front seats
 Luxury floor mats
 Memory for rear-view mirrors
 Sanded Silver inlays
 Soft leather upholstery
 Stainless steel end pipes
 Power seat, passenger



WANT A DYNAMIC TOUCH? If stylish and sporty looks get your pulse racing, this may be the Volvo XC90 for you: Soft leather Soft Beige upholstery in Offblack interior with Sanded Silver inlays, leather-clad steering wheel, leather-clad gear knob. Exterior colour Black Sapphire metallic with colour matched side decor and Situla 18" Silver Bright aluminium wheels. Complete the dynamic touch with running boards in aluminium.



OR MODERN LUXURY? Some people prefer sophisticated, timeless elegance. If that sounds like you, your new Volvo XC90 can look like this: Soft leather Soft Beige upholstery in Sandstone Beige interior with Dark wood inlays, Dark wood steering wheel and Dark wood gear knob. Exterior colour Oyster Grey metallic and Camulus 18" Silver Bright aluminium wheels.

COLOUR YOUR VOLVO. When it comes to the appearance of your Volvo, the choice of exterior colour, wheels and other styling items are probably your most important design decisions. And to add a truly exquisite touch to the paintwork of your Volvo – choose one of the unique Inscription colours. For more exterior styling options and to build your new Volvo online, please visit www.volvocars.com



614 Ice White
Also available for R-DESIGN



493 Caper Green metallic



612 Passion Red
Only available for R-DESIGN



477 Electric Silver metallic
Also available for R-DESIGN



472 Oyster Grey metallic
Inscription



492 Savile Grey metallic
Also available for R-DESIGN



452 Black Sapphire metallic
Also available for R-DESIGN



702 Flamenco Red metallic



467 Magic Blue metallic
Also available for R-DESIGN



426 Silver metallic



487 Ember Black metallic
Inscription



019 Black Stone

Inscription

Inscription is our exclusive design programme for a truly distinguished look.

Clean colours

To reduce usage of environmentally hazardous solvents, all Volvo exterior colours are water-based. What's more, our painting facilities are among the cleanest in the world.

Please note: It's not possible to reproduce exact original shades in printed matter. Please ask your dealer to show you samples.

EXTERIOR DESIGN. It's muscular without being aggressive. Purposeful lines hint of a truly versatile character, while its refined dynamic looks reveal a more sophisticated side. Rounded shapes interact with distinctively sculpted sections, creating a confident

Scandinavian style. Add to this a stance that leaves no doubt as to the intentions of this Volvo SUV. And to further emphasise the adventurous spirit of the Volvo XC90, there are a number of specially designed styling options.



Aluminium running boards and foot steps

Provide a more striking impression while matching the front and rear skid-plates. What's more, they protect the door sills on uneven surfaces and make it easier to get in and out – and they're useful when loading the roof. Dimensioned for a load of 300 kg. For extra convenience, foot steps can be added to the running board.

Side décor

Running along the bottom of the doors and wheel arches, the side décor gives the Volvo XC90 an even more exclusive appearance. It's painted in the same colour as the vehicle, and features an integrated metallic lower moulding.

Front bumper bar

Integrated in the front bumper to give the vehicle an even more powerful stance. Painted in Silverstone to match other exterior styling details. Alternatively, it can be painted in the same colour as the vehicle.

Aluminium crossbars

An aerodynamic design element that complements the roof rails and the design of your Volvo. These aluminium crossbars also allow you to exploit the roof's load-carrying capacity to the full.

EXTERIOR DESIGN Aluminium wheels



Camulus 7x18"
Silver Bright



Situla 7x18"
Silver Bright



Neptune 7x17"
Silver Stone

ACCESSORY Aluminium wheels



Thalassa 8x20"
Diamond Cut/Dark Grey matt
or Light Grey



Alastor 8x19"
Silver Bright



Oceanus 8x19"
Silver Bright



Nereus 7x18"
Polished



Nereus 7x18"
Silver Bright



Aquarius 7.5x17"
Silver Stone

IMAGINE YOUR NEW INTERIOR. Crafted according to your requirements, the interior of your Volvo can take on any number of personalities. Choose between two interior colours – Offblack and Sandstone Beige – and different upholstery variants. Pick the interior that suits you and add the finishing touch with the interior trim, steering wheel, gear knob and floor mat of your choice. After all, you're probably going to spend a lot of time here.



Ergonomic design Developed in co-operation with ergonomic specialists to provide generous support for the body during hours of driving, the seats in the Volvo XC90 are among the most comfortable in the automotive world. Multiple adjustment possibilities and adjustable lumbar support make it easy to find the perfect driving position.



Soft leather
In a class of its own, this option allows you to enjoy specially designed exclusive seats fully upholstered in finest Soft Leather with contrasting seams and piping on all seats. Extra padding in the seats contributes to luxurious seating comfort.



Leather
This is a hide quality that's comfortable, durable and has a coarse grain pattern. Like all Volvo leather, it's organically tanned and ages beautifully.



Marstrand textile/vinyl
This rugged yet elegant upholstery combines two materials. The fabric running through the centre panels is rich in contrast and comfort, while the leather imitation vinyl on the outer panels is smooth and highly practical.

INTERIOR DESIGN Offblack



Leather-clad steering wheel, Offblack



Leather-clad sports steering wheel, Offblack with aluminium inlay



Dark wood steering wheel, Offblack



Sapeli wood steering wheel, Offblack



Leather-clad gear knob Manual



Leather-clad gear knob Geartronic



Gear knob with Dark wood trim Geartronic



Gear knob with Sapeli wood trim Geartronic



Manganite trim in tunnel console and glove box



Cross Brushed aluminium trim in tunnel console and glove box



Sanded Silver trim in tunnel console and glove box



Dark wood trim in tunnel console and glove box



Sapeli wood trim in tunnel console and glove box

INTERIOR DESIGN Offblack



Offblack interior with Soft leather Chestnut upholstery (CM0D), Sanded Silver inlays, leather-clad steering wheel and gear knob.

Seat colour	Interior colour	Leather-clad steering wheel	Dashboard	Door inserts/ door panels	Carpeting	Roof lining
Calcite	Offblack	Offblack	Offblack	Calcite/Offblack	Offblack	Quartz
Soft Beige	Offblack	Offblack	Offblack	Soft Beige/Offblack	Offblack	Offblack
Chestnut	Offblack	Offblack	Offblack	Chestnut/Offblack	Offblack	Quartz
Offblack	Offblack	Offblack	Offblack	Offblack/Offblack	Offblack	Quartz



Soft leather Offblack (CM00)



Soft leather Soft Beige (CM0U)



Soft leather Chestnut (CM0D)



Leather Offblack (C900)



Leather Calcite (C90T)



Marstrand, textile/vinyl, Offblack (C000)

INTERIOR DESIGN Sandstone Beige



Leather-clad steering wheel, Sandstone Beige



Leather-clad gear knob Manual



Leather-clad gear knob Geartronic



Manganite trim in tunnel console and glove box

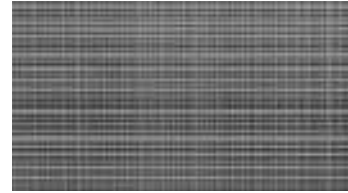

Cross Brushed aluminium trim in tunnel console and glove box



Sanded Silver trim in tunnel console and glove box



Sapeli wood steering wheel, Sandstone Beige



Gear knob with Dark wood trim Geartronic



Gear knob with Sapeli wood trim Geartronic



Dark wood trim in tunnel console and glove box



Sapeli wood trim in tunnel console and glove box

Seat colour	Interior colour	Leather-clad steering wheel	Dashboard	Door inserts/ door panels	Carpeting	Roof lining
Soft Beige	Sandstone	Sandstone	Espresso	Soft Beige/Mocca	Mocca	Soft Beige



Sandstone Beige interior with Soft leather Soft Beige upholstery (CM10), Sanded Silver inlays, leather steering wheel and gear knob.



Soft leather Soft Beige (CM10)



Leather Soft Beige (C910)



The head of the class.

No matter its duration, any journey in a Volvo XC90 Executive will be memorable. Sophisticated yet tasteful styling on the inside is complimented by a unique design profile. From its 19" Galateia wheels to its door mirror capping, chrome finished rear door pillars, front bumper bar and chrome tipped tailpipes, this thoroughbred version of a thoroughbred SUV will always create the right impression.





Inside the specially designed Volvo XC90 Executive, you'll find seats upholstered in Executive Soft Leather with contrasting seams and piping – all the way back to the third row. As well as featuring the supreme comfort of ventilated leather, the front seats are also equipped with a massage facility. A luxury we're sure you'll appreciate during driving on longer journeys.

Leather trimmed door panels with front padded armrests add to comfort while the hand-ground walnut wood trim and extra thick pile of the nubuck trimmed floor mats are the final word in understated luxury. And for that final exclusive touch? Why not add an integrated cooler box between the front seats?



Offblack interior, Executive Soft Leather perforated Soft Beige (CUSU)



Offblack interior, Executive Soft Leather perforated Chestnut (CU0P)



Offblack interior, Executive Soft Leather perforated Offblack (CU00)



Sandstone Beige interior, Executive Soft Leather perforated Soft Beige (CU10)



Wooden steering wheel, Offblack (Optional)



Wooden steering wheel, Sandstone Beige (Optional)



Gear knob with Walnut wood trim Geartronic (Standard)



Walnut wood trim in tunnel console and glove box (Standard)

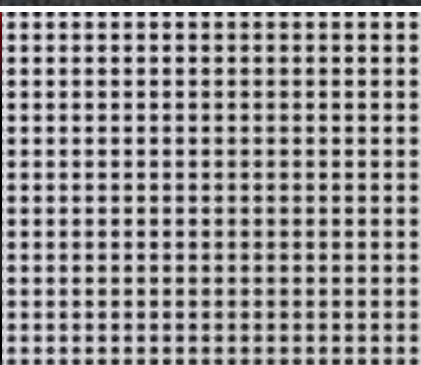

The R-DESIGN variant of the multi-award-winning Volvo XC90 has it all: Compelling performance, distinctive styling, and, of course, legendary Volvo safety. With its sports-tuned chassis, the Volvo XC90 R-DESIGN is not shy – especially not around corners. The exceptionally agile Volvo XC90 R-DESIGN secures its high-traction road-holding ability courtesy of a unique, sports-tuned chassis, sports-calibrated steering, and sophisticated stability control technologies. The result is a vehicle that feels quicker and more responsive, yet remarkably composed and purposeful. This is preventive safety from Volvo that helps keep the thrill of driving (and much more) alive.

R-DESIGN seats

The leather R-DESIGN seats are covered in two premium grades of chrome-free hide with a contrasting colour inlay and embossed R-DESIGN logo. The front seats feature extra padding and beefier side bolsters to hug you in the corners.

Sports-tuned chassis

The Volvo XC90 R-DESIGN has a specially tuned chassis that separates this vehicle from the crowd. The front suspension uses McPherson struts with anti-dive and anti-lift functionality. The multi-link independent rear suspension is attached to a steel sub-frame. The front and rear both have firmer shocks and stiffer anti-roll bars for added stability and quicker steering response.

Servotronic power steering

The R-DESIGN steering wheel with aluminium inlay doesn't just look smart. Behind it, the Servotronic power steering uses sophisticated, speed-sensitive technology to regulate the amount of power assistance a driver needs. At highway speeds, steering is firmer and more immediate. When parking or in slow traffic, steering is light and effortless. The Volvo XC90 R-DESIGN has a specially tuned Servotronic system that increases steering feedback significantly in 50–60 km/h range.

High performance wheels

The distinctive Vulcanis 19" wheels with five diamond cut spokes couldn't be more serious about driving. Behind them lie large, ventilated disc brakes, firmer shocks for improved body control and stiffer anti-roll bars to help keep the car flat through hard turns. If this isn't enough for you, Cratus 20" wheels are available as an option.

Sports tailpipes

Unique chrome-finish tailpipes ensure the XC90 R-DESIGN sticks out from the crowd. Indeed, this feature alone could be what other drivers notice first as they follow your lead. The V8 model also features a sports-tuned exhaust system.

A selection of R-DESIGN items are also available as part of our Accessories range. Please contact your local dealer for further information.

SAFETY

At the core of every car we make, state-of-the-art technology helps support the driver and protect the occupants. And to further enhance the Volvo safety experience, there's a range of supplementary safety technology – for more performance and peace of mind.



SAFETY Preventive

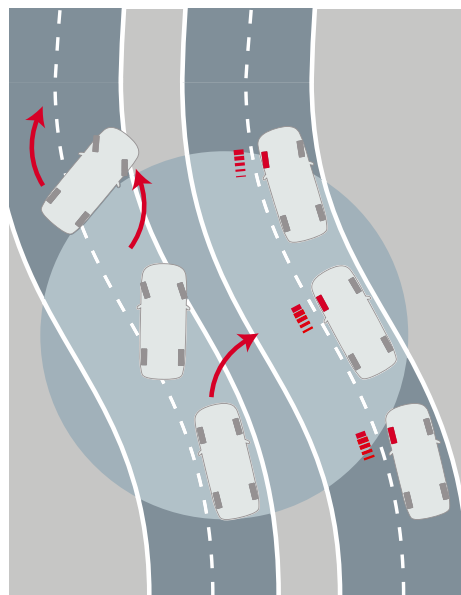

Dynamic Stability and Traction Control (DSTC)

By helping prevent fishtails, spinouts, and rollovers, stability control technology like DSTC has been described as one of the most vital safety advances of the past decade. At the core of DSTC, a gyroscope senses the car's direction and compares this with steering wheel movements as well as the actual rotation of the car's wheels. DSTC is able to detect a potential skid and help counteract this by reducing the engine's power output, or braking on one or more wheels.



Active Bending Lights (ABL)

In addition to improving illumination by about 230% using Dual Xenon light technology, the Active Bending Lights give a 90% boost to your vision round bends at night. Controlled by microprocessors, the motorised lamps turn up to 15 degrees in either direction when driving – reliably lighting up your chosen path. A twilight sensor disengages the adaptive function during daylight to extend its lifespan.

Water-repellent front side windows

To help offer far better visibility in the rain, these front side windows help repel water as you drive. The hydrophobic surface treatment turns water into small drops that will be blown away by the force of the wind. This also gives you the benefit of less ice or frost in winter conditions.

Roll Stability Control (RSC)

In the event of an emergency manoeuvre, Volvo's Roll Stability Control (RSC) can step in to help prevent the vehicle from rolling over. It features a gyroscopic sensor that registers the vehicle's lean angle and rollover risk. If required, RSC will cut engine power or brake one or more of the wheels just enough to reduce the centrifugal force and help regain balance.

SAFETY Protective



Passenger airbag cut-off switch

This switch allows you to disengage the passenger airbag using the car key. When the airbag is switched off, you are notified via a message in the roof console display. The force of the passenger airbag is designed to help protect adults – children risk serious injury. Therefore, the airbag must first be disengaged if you intend to put a person shorter than 140 cm in the front passenger seat.



Whiplash Protection System (WHIPS)

Integrated in the front seats, Volvo's WHIPS cradles the occupant to help reduce the risk of whiplash injury (one of the most common types of traffic injury and often the result of a low-speed rear impact collision). The function is activated by a collision of sufficient force from behind. Independent research has shown that WHIPS is one of the most effective systems in the world and can reduce the risk of long-term invalidity by 50%.

Frontal structure

The generous front deformation zones are designed to yield in a controlled way to help absorb crash energy before it reaches the cabin. The transversely mounted and very compact engine enables optimal use of the deformation zones to help protect occupants. Longitudinal steel struts help disperse crash energy away from the front to the rear of the vehicle, further helping to reduce the strain on the occupants.

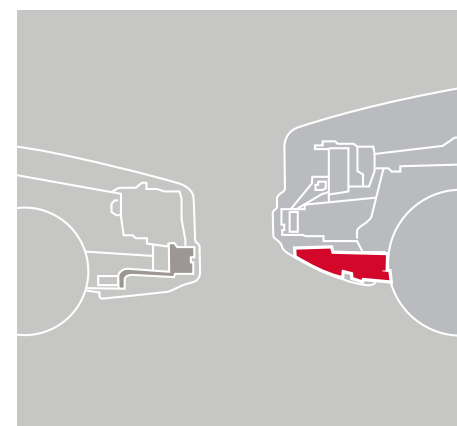

Lower cross member

To help protect the occupants in an oncoming car with lower positioned bumpers, there's a low cross member integrated in the front structure. In an impact, this cross member is designed to help activate the other car's own crumple zones and other safety systems to help reduce the risk of injury.

Restraint technologies

In a collision, Volvo's restraint technologies interact to help reduce the impact. The **safety belts with pre-tensioners** activate within a few thousandths of a second in the event of a collision or rollover and tighten the belt to help keep the occupants securely restrained. The front seat safety belts then release a little so that the driver and passenger are cushioned by the airbags in a controlled manner. Helping to optimise protection, the **dual-stage airbags** adapt the level of inflation depending on the force of the collision. The driver's airbag also interacts with the deformation of the collapsible steering column. **Side airbags** in the front seats help reduce the risk of serious injuries in a side collision. In a collision or rollover, the **Inflatable Curtain (IC)** helps protect the heads of both front and rear outboard occupants. It also stays inflated for some seconds to provide prolonged protection for subsequent impacts.



In a Volvo, safety is about interaction. Because it's not the number of safety features that determines how safe a car is. It's how well they seamlessly interact to help keep the occupants out of harm's way.

In a rear impact the rear deformation zones will help absorb crash energy. Even behind the third row there's a good deal of space to help provide effective protection. The fuel tank is designed to remain well protected in front of the rear axle. The head restraints help protect the neck and spine, and Volvo's unique Whiplash Protection System (WHIPS) cradles the front seat occupants in a controlled manner to help prevent whiplash injuries.

In a side impact Volvo's unique Side Impact Protection System (SIPS) helps distribute the crash forces across the car's body, away from the occupants. The side airbags in the front seats help protect the chest and hip, while the Inflatable Curtain (IC) adds head protection for all outboard occupants, including the ones in the third row.

In a roll-over a gyroscope activates Volvo's Roll Over Protection System (ROPS). The safety belt pre-tensioners deploy to help keep occupants more securely restrained, and the Inflatable Curtain (IC) helps provide head protection. Additionally, the safety cage is reinforced to help keep the passenger compartment intact.

In a frontal collision the generous deformation zones will yield to help absorb crash energy. The compact powertrain is designed to help optimise deformation. Inside the vehicle, safety belts interact with the collapsible steering column and dual-stage airbags to help keep the occupants out of harm's way. A lower cross member helps protect occupants in an oncoming car with lower positioned bumpers. The front and bonnet are also designed to help reduce the risk of injury to unprotected road-users.



Roll Over Protection System (ROPS)

A robust roof structure together with Volvo's unique Roll Over Protection System (ROPS) help protect the occupants in a rollover situation. ROPS is activated by a gyroscope that monitors the vehicle's leaning angle. The safety belt pre-tensioners are activated at every seat to help keep occupants more securely restrained. At the same time, the inflatable curtain (IC) deploys and remains inflated for several seconds to help provide extended protection. To help keep the passenger compartment intact despite severe external forces, door pillars and strategic parts of the safety cage is reinforced in ultra high-strength steel.

Pedestrian protection

To help reduce the risk of serious injuries on unprotected road-users, the front of the vehicle is gently rounded, the headlamps are integrated flush with the body, and the bonnet is energy-absorbing to act as a crumple zone.

Side Impact Protection System (SIPS)

SIPS is a Volvo unique safety system that has been developed to help protect where occupants are most exposed to the crash forces. The steel framework of the vehicle – including the front seats – is designed and reinforced to help displace the impact of a side-collision away from the occupants to other parts of the car body and help prevent intrusion into the cabin. The side structure is extremely strong to help withstand a severe side impact. The Inflatable Curtain (IC) for all the outboard occupants including the ones in the third row and the front seat side airbags interact to help provide further protection.



Volvo's child safety programme

To further enhance protection for children, we offer a child safety programme that is among the most comprehensive in the car world. Because infants have large heads and weak necks*, we know that a child up to the age of 3-4 travels most safely facing the rear. Volvo's rear-facing child seats help provide maximum protection in a wide range of collisions. Children who have outgrown the child seat travel most safely seated on a booster seat, secured with the car's safety belt.

* In a frontal collision at 50 km/h, the head of a six-month infant can be exposed to forces corresponding to a load of 100 kg!

Please note: If the front passenger seat airbag is switched on, children under 140 cm in height should never be seated in the front seat – not in conjunction with a child seat, a booster cushion or under any other circumstances.



► Infant seat (up to 13 kg)

Infants, from newborns up to about 1 year of age, travel safely backwards in this comfortable seat. It's installed using the car's safety belt. And for extra convenient installation using the car's ISOFIX attachments, an ISOFIX base can be added. Side wings help protect in a side impact, and the headrest and five-point harness are easily adjusted. The headrest is padded for a comfortable sleep and there's a canopy to block the sun. What's more, the infant seat is easy to carry and can be used as a babysitter.

► = Accessory (can be fitted after you've purchased your car).

SAFETY Child safety



► Convertible child seat (9–25 kg)

From the age of 9 months to about 6 years of age a child can continue to be seated backwards in this new child seat. Advanced design helps provide world-class protection and flexible seating for many years. The seat is fitted using the car's safety belt and is easily adjusted to help optimise comfort and safety. An integrated support leg helps facilitate safe backward installation. We recommend that children be seated backwards as long as possible. But when a child grows bigger (15–25 kg) and can not comfortably be seated facing to the rear, this seat can also be used as a forward-facing booster cushion that puts a child at the correct position for the car's safety belt.

SAFETY Security



HomeLink®

With buttons integrated in the sun visor, HomeLink® allows you to operate remote controlled home appliances – such as garage door, home alarm and exterior lighting – without leaving the car.

HomeLink is a registered trademark of Johnson Controls Technology Company.



Power retractable door mirrors with ground lighting

At the touch of a button, these door mirrors can be folded flat against the car where they are less likely to get damaged after you've parked. The integrated ground lighting is activated with the remote control. Beyond enhancing security to and from your car at night, this is also convenient when getting in and out.



Integrated booster cushion (15–36 kg)

The integrated booster cushion in the rear middle seat helps position a child (15–36 kg) at the correct position for the safety belt. It also offers a high level of comfort and visibility. The middle seat slides forward to bring a child closer to adults in the front. And for more legroom, simply lift out the rear section of the centre console. When not in use, the cushion is concealed in the middle rear seat.

Power child safety lock

The power child lock enables you to conveniently lock the rear doors and rear power windows from the driver's seat and prevent them from being opened from the inside.

Approach and Home Safe Lighting

Activated with the remote control, Approach Lighting provides a warm reception on a dark night. This consists of interior and side lights – ground lighting too, if you choose it. Home Safe Lighting is activated with the headlight stalk as you leave the car and it provides a similar courtesy when exiting your car. This feature includes a dipped beam from the headlight to accompany you to your door.

Laminated side door windows

Laminated side windows turn an attempted smash-and-grab into a time consuming ordeal. They also enhance sound comfort in the cabin and contribute to UV protection. Additionally, this option also includes water-repellent glass in the front side windows for improved visibility in wet weather.

Volvo On Call

Activating automatically if any of your car's airbags are deployed – or at the touch of a button – Volvo On Call is Volvo's roadside assistance and emergency service. Not only does it put you in direct contact with a Volvo On Call operator, a built-in GPS system allows them to pinpoint your location and get help to you as soon as possible. The system can also alert you to an attempted break-in, and if the car is stolen it can be traced via satellite.

COMFORT

A Volvo is always designed for more than one. Our technology aims to enhance the feel-good factor for everybody with the privilege of riding in a Volvo. And to further improve comfort and convenience, there's a range of clever equipment – customised for your Volvo and the people inside it.



COMFORT Seats



Seven individual seats

All occupants will appreciate the comfort of a separate, ergonomically designed seat. Cinema-style seating helps provide an excellent view, wherever you're seated. The easily adjustable front and second row seats make it easy to find the perfect seating position and maximum comfort. The middle seat also features an integrated booster cushion. In the third row of seats two passengers of up to 160 cm ride comfortably. Each rear seat is easy to fold individually into the load area floor so you can transport both passengers and cargo without compromising on either comfort or safety.

► = Accessory (can be fitted after you've purchased your car).

COMFORT Seats



Fore-aft adjustable second row

Each seat in the second row can be moved forwards and backwards to offer you maximum comfort and versatility. While the outer seats can slide forward a full 100 mm, the middle seat features an integrated booster cushion and can slide forward nearly 300 mm so you can move a child closer to the adults in the front. And to provide added legroom for the passenger in the middle seat, simply remove the centre console's rear section.

Third row

Two passengers (up to approximately 160 cm tall) ride in comfort in the rear-most seats. Cup holders, table and smart storage solutions make longer trips more enjoyable. To further enhance comfort, air conditioning with adjustable ventilation and heating vents can be fitted at the rear.



Power front seats

Find your perfect driving position with push-button ease. The driver's seat also incorporates a memory function that stores three separate seat and door mirror settings connected to a specific remote control – a feature that's appreciated when the car has several drivers.

COMFORT Climate

Electronic Climate Control (ECC)

ECC ensures you and your passengers always enjoy a pleasant in-car climate. It maintains the set temperature inside the car however much the temperature outside changes, or the sun shines in. The driver and front-seat passenger can set the temperature individually for each side.

Interior Air Quality System (IAQS)

Volvo's IAQS continuously monitors incoming air and will, if necessary, temporarily close external air vents to shut out carbon monoxide, ground-level ozone and nitrogen dioxide. Meanwhile, an active carbon filter protects the occupants from other harmful gases and unpleasant odours. This helps ensure that the air you breathe in the car is cleaner than that outside when driving in heavy city traffic and tunnels.



Power glass sunroof

This makes the interior feel extra light and airy. It opens and closes at the touch of a button. If the sun is too strong, just close the built-in sunshade.

COMFORT Climate



Third row AC

Supplementing Electronic Climate Control, this manual air-conditioning system boosts comfort in the third row. Passengers can conveniently adjust fan speed themselves and regulate air flow via separate vents.

► Sunshades

Easily attached to the rear door and load compartment windows, these help reduce the heat and glare of direct sunlight. Simple to remove when they're not needed.

Engine and cabin heater, fuel driven

A fuel-driven heater will make your car easier to start, help reduce environmental impact and warm up the cabin. Start the heater directly, or set the time you'd like to enter your warm and defrosted car. With a remote starter you can activate the heater without going out to the car. And if your car is equipped with Volvo On Call, you can send an SMS to your car from your mobile phone to start the heater.

COMFORT Storage



► Electric cooler and heater box

Beyond keeping your drinks cold in the load compartment, this can be used as a hot box to keep food warm. This connects to the power outlet in the load compartment and is secured with mounting straps.

Cup holders, rear

Retractable cup holders are easily accessed in the rear of the tunnel console, and bottles can be conveniently stored in the door panels.



Front centre armrest and cupholders

The centre armrest conceals a host of conveniences. Fold back the upper section to reveal a handy storage space for CDs, sunglasses and other small items. It also provides rear seat passengers with a convenient table. Double cup holders in the front of the armrest ensure that refreshments are always easy to reach. These cup holders can be concealed when not in use. Here you'll also find an AUX input.

TECH & SOUND

Employing the latest information technology, your Volvo is prepared to support and entertain you at a very high level. Surround yourself and your friends with world-class sound and enjoy the innovations that help ensure your command of the road and the pleasure of travelling.



TECH & SOUND Driver's support



Automatically dimmed inner rear-view mirror

This is a mirror that automatically adjusts itself to deflect the headlamp beams of the car behind you. When there's no light to dazzle you, it automatically readjusts to its normal setting. This can be supplemented with an integrated compass.

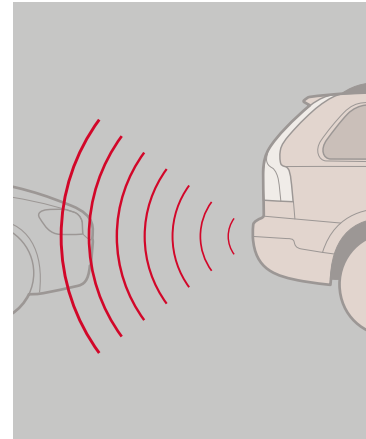

Park assist rear

► Park assist front

Activated when you engage reverse gear, rear park assist helps you when reversing into tight spaces. The audio system is turned down and a pulsating sound from the rear loudspeakers becomes a continuous tone as you approach an obstacle. Front park assist performs a similar function at the front of the vehicle – alerting you via the front loudspeakers.



Rain sensor

Once activated, the rain sensor can start the windscreen wipers as soon as it begins to rain or if water splashes onto the windscreen. For your convenience, it can also automatically adapt the intermittent windscreen-wiper function. Its sensitivity can be adjusted via a ring on the wiper stalk.



► Park Assist Camera

If the car is equipped with RTI navigation and park assist camera, this helps display what's going on behind your car when reversing. The system uses the RTI screen and a camera discretely located over the license plate. On-screen guiding lines provide extra assistance for smooth parking.

TECH & SOUND Communication



Integrated Bluetooth® handsfree system

► Bluetooth® handsfree system

Bluetooth® technology enables a mobile phone to be connected to the infotainment system in your Volvo, wirelessly. Once configured for a mobile phone, the system automatically recognises your phone as you enter the car. And as you climb in and out of the car, the system automatically allows you to switch freely from the phone to the handsfree system and back again. With Volvo's integrated Bluetooth® handsfree system you conveniently operate your phone using the buttons in the steering wheel or the centre console keypad. To further enhance your comfort and safety, you can also add Volvo On Call roadside assistance and emergency service. Available as an accessory, there's also a voice-controlled Bluetooth® handsfree system that will listen to your command and make calls for you.

The Bluetooth word mark and logos are owned by the Bluetooth SIG, Inc. and any use of such marks by Volvo Car Corporation is under license. Other trademarks and trade names are those of their respective owners.



Road and Traffic Information (RTI)

Volvo's GPS-based RTI navigation system offers both voice guidance and graphic navigation all the way to your destination. Via TMC (Traffic Message Channel) radio data broadcasts, RTI also lets you know if there's weather-related trouble on route and recommends an alternative. Extremely swift and precise, this new generation RTI features a hard disc drive covering maps for major parts of Europe. The system is fully integrated in your Volvo and is easily controlled from the steering wheel or optional remote, and the screen is positioned so you can keep your attention on traffic. You can choose between two operating modes – Easy and Advanced. When RTI is not needed, the screen is hidden into the dash.

To help you keep track of new roads and points of interest, you can join our MapCare programme for two free map updates.

► Volvo's Portable Navigation System

This portable and powerful Garmin nüvi® 765 navigation unit integrates smoothly with the design of your Volvo. Just fit it into the docking unit on top of the dashboard. The wide bright touch screen is conveniently positioned in your field of vision. It allows you to navigate with ease, plan your route and find your points of interest. And beyond navigation, there are travel and entertainment functions such as an MP3 player, currency converter, calculator and FM transmitter. The navigation unit is easy to carry with you and can also be used outside the car. Maps covering major parts of Europe are stored in memory.

nüvi is a trademark of Garmin Ltd.

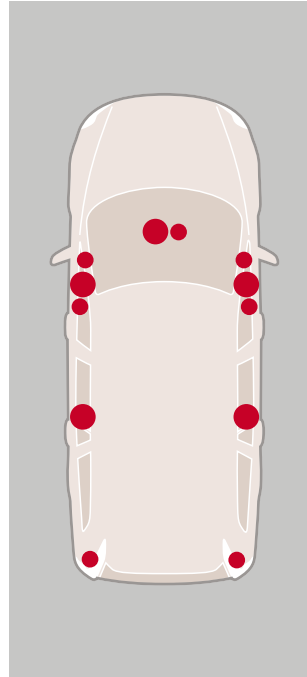

Premium Sound audio system

The Premium Sound system is in a class of its own. The digital class D amplifier generates 5x130 watts of music. Dolby® Pro Logic® II surround sound recreates a sound that's equally authentic at each seating position. There are 12 high-end loudspeakers specially developed for the Volvo XC90 and a true concert hall experience. The Premium Sound system includes:

- RDS radio
- MP3 and WMA compatible CD player
- USB and AUX input
- 5x130 W digital class D amplifier
- Dolby® Pro Logic® II surround sound with centre loudspeaker and digital sound processor
- 12 high-end loudspeakers

Options: steering wheel integrated controls, separate remote control and rear headphone connectors. A 6-CD changer is available (replaces the CD player) – this option deletes the USB input, but a USB and iPod® Music Interface (accessory) can be added.

Dolby, Pro Logic, and the double-D symbol are registered trademarks of Dolby Laboratories.

Premium Sound loudspeakers

The twelve high-end loudspeakers in the Premium Sound system are powered by a 5x130 W digital amplifier. There are three separate drivers – woofer, midrange and tweeter – in each front door, a coaxial woofer/tweeter in each rear door and a tweeter in each rear pillar. Each speaker has a crossover filter to maximise fidelity. The latest generation Dolby® surround system with a centre loudspeaker and sound processor recreates authentic sound with a strong sense of presence for everyone in the vehicle – a Volvo world first. The digital class D amplifier features new technology that provides extremely high efficiency, enabling it to generate the most audio power from the least amount of current.

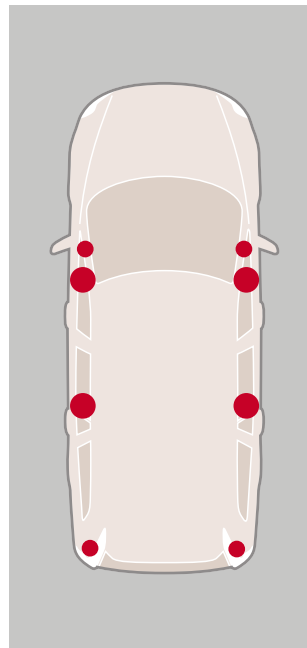

High Performance audio system

A powerfully versatile system. Each loudspeaker is fitted with a more powerful magnet and a larger coil. Coupled to the High Performance amplifier, this system provides superb transient reproduction, high power durability and low distortion for a superb listening experience. High Performance includes:

- RDS radio
- MP3 and WMA compatible CD player
- USB and AUX input
- 4x40 W High Performance amplifier
- 8 High Performance loudspeakers

Options: steering wheel integrated controls, separate remote control and rear headphone connectors. A 6-CD changer is available (replaces the CD player) – this option deletes the USB input, but a USB and iPod® Music Interface (accessory) can be added.



Rear headphone connectors

Allow four rear-seat passengers to listen to the radio or their favourite CD, at the same time, without disturbing other occupants. With separate controls for headphone volume and audio source. Also features controls for changing tracks or switching radio stations.



MP3 compatibility

There are a number of ways to enjoy MP3 music files in your Volvo XC90. If you'd like to connect your personal MP3 player to the audio system, there's a standard auxiliary audio input between the front seats. Volume is conveniently controlled from the steering wheel, centre console and rear headphone connectors. Choosing the High Performance or Premium Sound audio system, there's also a USB* port that allows you to fully integrate your iPod®, MP3 player or USB device with the audio system. Playlists, songs and artists are clearly displayed in the centre console, while your player will be charged at the same time. These audio systems also feature an MP3 and WMA compatible CD player.

* Not in combination with a 6-CD changer. Choosing a 6-CD changer, you can add a USB and iPod® Music Interface to connect your MP3 player to the audio system.

► USB and iPod® Music Interface

For the Performance audio system, you can add a separate USB and iPod® Music Interface (accessory) to connect your MP3 player.

iPod is a trademark of Apple Computer Inc.



Rear Seat Entertainment (RSE) dual screen

With Volvo's new generation DVD-based RSE dual screen, the rear seat passengers can enjoy a film or play a game – together or separately. Adding a digital TV receiver, passengers can also watch terrestrial TV broadcasts while travelling. Two 8-inch widescreen displays are integrated in the front seat head restraints and provide excellent image quality. Wireless headphones keep things calm in the cabin and you can listen to the music or program of your choice. Via an AUX input, you can also connect external devices such as an iPod®, MP3 player, extra DVD player or a digital camera. The RSE system is an integrated part of the car. It matches the interior perfectly and is available with all upholstery.

PACK & LOAD

A world champion in versatility, Volvo has a proud heritage in providing smart solutions for both cargo and passengers – without compromising safety or comfort. So whatever you need to expand your world and the capabilities of your Volvo, here you'll find some practical equipment to make it happen.



PACK & LOAD Compartment



Foldable front seat backrest

To help you carry long objects inside your Volvo, the front passenger seat backrest can be conveniently folded flat.

Load compartment

The cargo volume is 615 litres with the second row seatbacks up, while the full loading capacity is 1837 litres. Each passenger seat can be folded individually to give you maximum flexibility for combining passengers and cargo. The head restraints are easily folded out of the way. And by folding flat the middle seat, you can transport long loads while still carrying passengers in unimpaired comfort and safety.

Dual-split tailgate

A convenient loading height and a dual-split tailgate with the lower section at the same height as the load compartment floor make the Volvo XC90 easy to load and unload. The lower section of the tailgate also serves as a stable platform for accessing cargo on the roof – or a convenient bench that can be supplemented with a seat cushion and a picnic table.



Load cover

A retractable load cover to conceal your gear in the load compartment. Colour-coordinated with the interior. Can only be used when the third row seats are folded down.



Grocery bag holder

This integrated holder unfolds from the load compartment floor and keeps your shopping bags and other similar items in place.

PACK & LOAD Compartment



Complete dirt protector

This durable vinyl liner covers the floor, the sides of the rear cargo area and the backs of the seats on the second row to protect against grime and water. It is simple to mount. The backrest section of the liner is split to allow the backrests to be folded down separately. The rear section can also be folded out over the lower tailgate section.

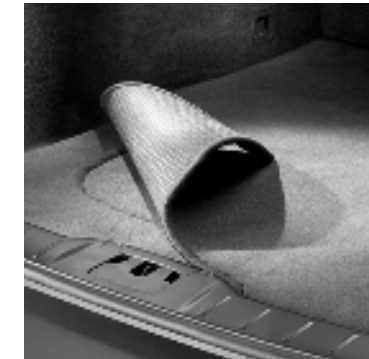

Load compartment mats

The load compartment mats – in textile or moulded plastic – are tailor-made to fit perfectly in your XC90. The textile mat is reversible and waterproof, with colour-keyed textile on one side and rubber on the other. This allows you to maintain the attractive appearance of the load compartment even if you occasionally transport dirty loads.



Protective grille and load compartment divider

Fitted behind the second row of seats to help protect occupants from unsecured cargo when braking hard. Complement with a load compartment divider, and you conveniently separate dirty or fragile cargo from other cargo.



Net pocket

Practical storage for small items along both side panels in the load compartment. Colour-coordinated with the interior.

Load securing net

Attached to the floor-mounted load loops, this elastic net helps keep your gear securely in place in the cargo compartment. Colour-coordinated with the interior. Can only be used when the third row seats are folded.

PACK & LOAD Carrying/Towing



Roof load carrying system

To help you fully utilise the roof of your Volvo, we've developed a range of versatile load carrying accessories. This system is dimensioned to carry up to 100 kg. The factory-fitted attachment points in the car's roof make the load carriers easy to fit, and even quicker if your car has roof rails. Various load accessories – such as roof boxes and different holders for bikes, skis, surfboards and kayaks – can be attached to the load carriers to meet your needs. These accessories can be almost freely combined for flexibility and many are aerodynamically designed to help reduce fuel consumption and wind noise. And most of them can be locked with the same key, using Volvo's One-Key System.

► = Accessory (can be fitted after you've purchased your car).

PACK & LOAD Carrying/Towing



Automatic levelling

When you tow or carry a heavy load, automatic levelling adjusts the rear shock absorbers so the vehicle will maintain road holding, ground clearance and headlight angle.

Towing equipment

A Volvo tow bar – fixed or removable – is the ultimate load accessory. The removable tow bar is easy to detach and refit when necessary. When not in use, it's completely out of the way. A range of tow bar mounted bicycle holders is available – you can take up to four bikes (or two e-bikes) conveniently and safely on the back of your Volvo. Loading is easy, and the holder can be tilted to allow access to the load compartment.

PERFORMANCE

In a Volvo, powertrain and chassis interact to strike the perfect balance between excitement and stability. And to further enhance the experience, additional technologies are available.



PERFORMANCE Chassis



Six-speed Geartronic automatic transmission

For the best of two worlds, there's the six-speed Geartronic – a responsive automatic that's ideal for relaxed driving, tough conditions or towing. This also allows manual gear shifting so you can maintain a lower gear to bring up the revs or for the added assistance of engine braking. A special winter setting makes it easier to move off and maintain grip on slippery surfaces.

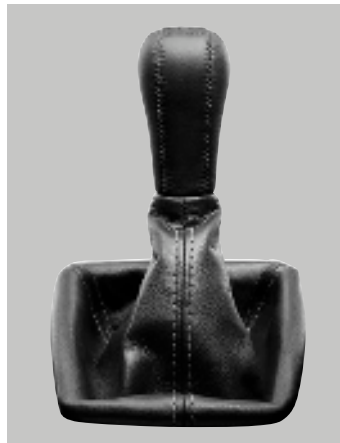

Six-speed manual transmission

The six-speed all-synchromesh manual gearbox offers fluid and precise gear selection. The sixth gear improves comfort and fuel economy on the motorway. The smooth action of the clutch assures that you move off with confidence and grace.

PERFORMANCE Chassis

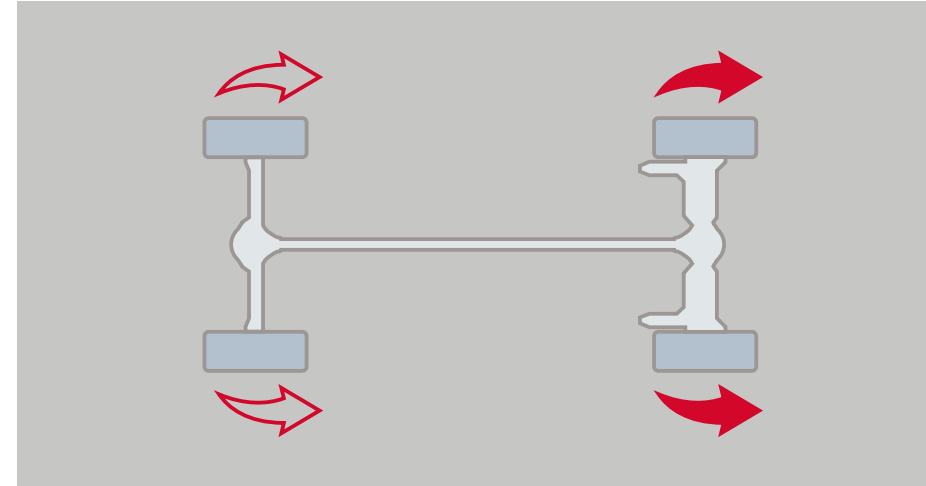

All-wheel drive with Instant Traction™

Volvo's pre-charged, electronically controlled all-wheel drive technology – AWD with Instant Traction™ – means greater agility. Constant hydraulic pressure ensures that power is promptly distributed to the wheels with the best traction. Wheel spin is minimised to provide immediate acceleration and reassuring stability in slippery conditions. When cruising on straight and dry roads, front wheels receive up to 95% of the power for optimum stability and fuel economy. However, during quick acceleration or in a sharp bend, up to 50% of the power instantly goes to the rear wheels – depending on what's needed to achieve maximum stability and grip. The immediate response of the AWD system allows under-steering and over-steering tendencies to be compensated with exceptional precision, giving a feeling of total control and driving pleasure.

Chassis

The Volvo XC90's all-road capability is based on generous ground clearance (218 mm), a comparatively low centre of gravity and an advanced chassis. The rigid body enables optimal suspension performance, balanced handling and a high level of comfort. Front and rear suspension interact to provide stable braking and smooth steering. In a curve, the rear wheels have a slight steering facility for added stability and steering response. The Volvo XC90 R-DESIGN has a specially tuned sport chassis – the front and rear suspensions both have firmer shocks and stiffer anti-roll bars for added stability and quicker steering response.

Speed dependent steering

The optional speed dependent and progressive power steering provides progressively less servo assistance the faster you drive. Higher steering precision and enhanced road feedback are easily enjoyed benefits. At lower speeds, added power assistance makes the car even easier to manoeuvre, for instance when parking. The Volvo XC90 R-DESIGN has a specially tuned speed dependent steering that further increases road feed-back for a sportier driving experience.

7-seater

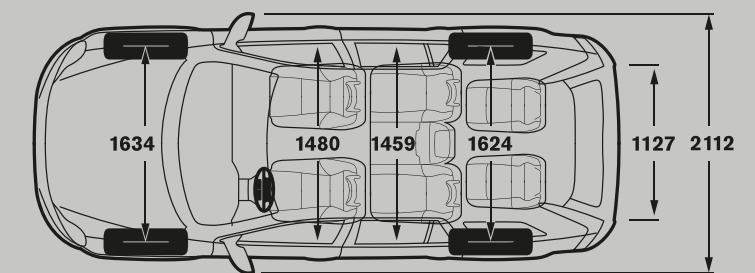
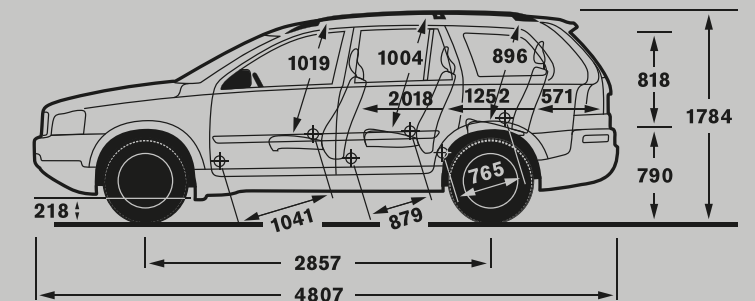

► = Accessory (can be fitted after you've purchased your car).

Volvo. for life

THERE'S MORE TO LIFE THAN A VOLVO.



THAT'S WHY YOU DRIVE ONE.

VOLVO

Volvo Car Corporation SP_XC90_00011_03-11. English.