

A-Class



Mercedes-Benz





First impressions

Nothing can prepare you for the effect the A-Class has on your eyes, on your heart, and on your preconceptions. The new A-Class is a car for a new era and a new generation. A car that wants it all and shuns compromise at any cost. The design spells out the future. It's where incredible agility meets high efficiency, and comfort forms a perfect balance with technology.

There are so many stylish options to choose from, so you can have the A-Class just the way you like it. It's all here, and it's ready to go. As soon as you take to the wheel your head will follow your heart and the A-Class leads the way.

[Overview](#) | [from page 4](#) [Insights](#) | [from page 14](#)

Featured models:

A 250 BlueEFFICIENCY AMG Sport | Metallic Polar Silver | front cover and pages 4-7

AMG 5-twin-spoke alloy wheels, Black Artico artificial leather/Dinamica microfibre upholstery, carbon fibre-look trim

A 180 BlueEFFICIENCY SE | Non-metallic Jupiter Red | from page 2 and pages 8-11

10-spoke alloy wheels, Black/White Artico artificial leather/cloth upholstery, matrix-look trim

A 250 BlueEFFICIENCY Engineered by AMG | Metallic Polar Silver | from page 12

AMG 5-spoke alloy wheels, Black leather upholstery, carbon fibre-look trim

Specifications shown may include optional equipment and accessories



With an iPhone® or iPad® you can download the interactive A-Class brochure app either by scanning the QR code or by visiting the App Store



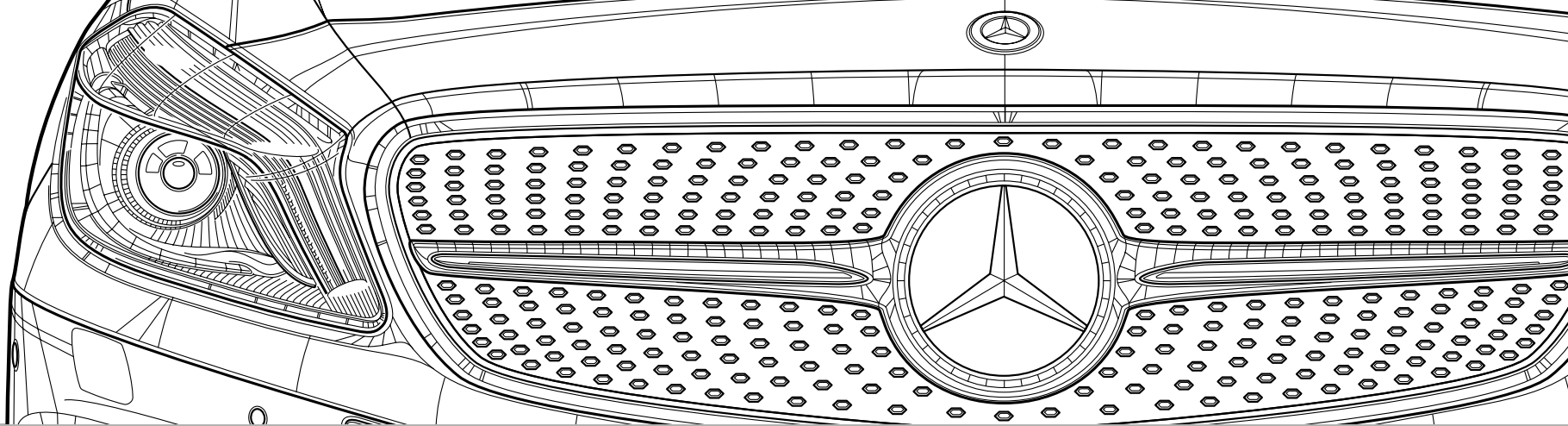

Facts

For driving pleasure: BlueEFFICIENCY, diesel and petrol engines, transmissions and suspension.

Engines and suspension | from page 17

For safety: electronic assistants that help prevent accidents and enhance occupant protection – Attention Assist, Collision Prevention Assist, DISTRONIC Plus and Pre-Safe.[®]

Safety | from page 23

For relaxed driving: standard and optional comfort features, including multimedia systems and electronic assistants, climate control and seats.

Comfort | from page 27

For individual style: a wide range of standard equipment and optional equipment for A 180, SE, Sport, AMG Sport and Engineered by AMG, as well as the optional Night Package, Exclusive Package and AMG Exclusive Package, wheels and Retailer-fit accessories.

Equipment | from page 33

For all-round service: test drive, Mercedes-Benz Finance and Insurance, Interactive Owner's Manual, Roadside Assistance and Mercedes-Benz World.

Services | from page 61

For every little detail: dimensions, paint finishes and technical data.

Facts and finishes | from page 63



1 glance

and you're hooked



It's hard to take your eyes off this new Mercedes. Truly distinctive on the outside, it waves goodbye to boredom on the road. Inside, you're welcomed by maximum comfort. High tech? Of course. Highest level of safety? It goes without saying. Efficiency? You've guessed it. Here's a Mercedes true to its tradition. And a car like you've never seen it before. Hello, new A-Class.



130 bpm

When you're left speechless,
your heart says it all



Feel life pulsating: those taut lines and highly defined edges, concave curves meeting convex shapes – every inch of the A-Class plays with the light in a perfect rhythm. Muscular and athletic like a coupé, it's no wonder you're beaming.



1 of a kind

Endless equipment options, but only one that really matters



Your style, your way, your personality, your A-Class. Five model lines, five very different forms of expression. Dynamic and confident with the A 180 and SE, or even more athletic with the Sport, AMG Sport or Engineered by AMG. If you want to enhance the distinctive styling, there's the optional Night Package. Choose the Exclusive Package or the AMG Exclusive Package for further luxurious touches. The new A-Class is a Mercedes-Benz through and through, but there's no doubt it takes after you.





800 × 480

A crisp resolution with COMAND Online

Keeping in touch with the virtual world couldn't be simpler behind the wheel, courtesy of the new 7-inch display. It's your window of endless opportunities: surf the net, tweet away or get in touch on Facebook. And in the real world, electric parking brake, Active Park Assist, reversing camera and hold function ensure you enjoy every mile a little more. The new A-Class helps you stay connected.



600 miles

Refuelling has become a rarity.
Great for the future and for your wallet



The new A-Class is a true endurance athlete. With consumption as low as 85 mpg, you'll get further than you'll think. All made possible by efficient turbocharged engines with direct injection, and the standard ECO start/stop function which helps save fuel when at a standstill. It's what we call BlueEFFICIENCY.



5+11

More awareness and less risk



When your five senses reach their limit, 11 electronic assistants step in. Radar-assisted Collision Prevention Assist, awareness-enhancing Attention Assist and Hill Start Assist are all standard on the new A-Class. For even greater levels of safety, Distronic Plus radar-assisted cruise control and the Pre-Safe® anticipatory safety system are available as an option. That's plenty of technology to keep you out of harm's way.







6.6 sec

A spontaneous sprint: from 0 to 62 mph in the nick of time

Steam ahead with an impression to last. Powered by a well-trained muscle, at the heart a powerful direct injection 4-cylinder petrol or diesel engine. Change gears seamlessly with the 7G-DCT 7-speed automatic transmission. Hug the tarmac with the Dynamic Handling Package which includes Selective Damping System and sports suspension. The A-Class Engineered by AMG takes things up by another notch. It even looks like an athlete with the distinctive front diamond grille with one louvre and decorative red strip on front and rear bumpers. Don't drive away for anything less.



$$C_d = 0.27$$

Reduce drag and you'll reduce fuel consumption

The A-Class features such a streamlined body, even the air is stopped in its tracks. In fact, the air resistance is similar to a notchback, which makes the A-Class the most aerodynamic in its segment. Less drag means more benefits: greater fuel efficiency and more miles between refuelling. On top of it all, greater aerodynamics keep wind noise to a minimum.



California's thinktank

At Palo Alto, there's something in the air. Every day, the entire Silicon Valley is buzzing with brain waves in the Californian sun. Top universities and visionary start-ups vie for the best minds, constantly exchanging ideas like segments on a hard-drive.

This hotspot for progress is also the home of the Mercedes-Benz Research and Development Center North America. A wide range of disciplines take part in the quest for tomorrow's innovations. User-interface designers, software and hardware engineers connect digital lifestyle with digital drive style. This cross-functional method serves as the foundation of their cooperation.

Not even the walls can stop the creative flow in the Californian Research Center. They are painted with a special finish that allows the use of pens. This speeds up the creative process, saves paper and encourages thinking in all sorts of directions. It's quite literally off-the-wall thinking – without it, there would be no automobile today, and there certainly wouldn't be any solutions for the car of the future.



17 BlueEFFICIENCY**18 Efficiency in the A-Class****19 Diesel engines**

4-cylinder diesel engines

20 Petrol engines

4-cylinder petrol engines

21 Transmissions

6-speed manual transmission

7G-DCT 7-speed automatic transmission

22 Suspension

Suspension and steering

Sports suspension

Direct Steering

23 Integrated safety concept

Attention Assist

Collision Prevention Assist

Adaptive Brake Assist

DISTRONIC Plus

Lane-Keeping Assist/Blind Spot Assist

Intelligent Light System

Pre-Safe® anticipatory safety system

Active Bonnet

Airbags

Mercedes-Benz Emergency Call System

Rescue assistance

27 Multimedia systems

COMAND Online system

Audio 20 radio/single CD

Becker® Map Pilot navigation system

Harman Kardon® Logic 7®

surround sound system

29 Electronic assistants

Reversing camera

Active Park Assist with Parktronic

Speed Limit Assist

30 Lighting and climate control

Light and Sight Package

Luxury automatic climate control

31 Seats

4-way lumbar support

Memory Package

32 Sunroof and storage

Panoramic sliding sunroof

Luggage compartment

Storage Package



33 Model variants

A 180
SE
Sport
AMG Sport
Engineered by AMG

51 Equipment packages

Night Package
Exclusive Package
AMG Exclusive Package

55 Standard equipment**56 Optional extras****57 Wheels**

Standard wheels
Optional wheels
AMG wheels

59 Retailer-fit accessories**61 Services**

Test drive
Mercedes-Benz Finance and Insurance
Interactive Owner's Manual
Roadside Assistance
Mercedes-Benz World

63 Dimensions**64 Technical data****66 Paint finishes**

BlueEFFICIENCY – technology for more efficient driving

Our comprehensive BlueEFFICIENCY measures have already brought significant cuts in fuel consumption to many current Mercedes-Benz models, helping to lower both their CO₂ emissions and their running costs. What's more, we are continuing to develop new environmentally friendly technologies that will reduce emissions even further and help to make motoring more sustainable in the long term.

BlueEFFICIENCY – the Mercedes-Benz efficiency drive.

BlueEFFICIENCY models feature a range of measures that can considerably reduce fuel consumption and CO₂ emissions. They include aerodynamic optimisation, low-resistance tyres and intelligent energy management technologies such as the ECO start/stop function, which comes as standard on the majority of our passenger car models. Many of our model ranges also now offer new BlueDIRECT engines. Their innovative direct petrol injection system delivers significantly more power, yet also helps to cut fuel consumption by up to 25%.

BlueTEC – cleaner diesel power. BlueTEC is our cleanest diesel technology to date. Its combination of advanced common-rail direct injection, optimised combustion and modular emissions control systems reduces particulate levels by up to 95% and removes up to 90% of nitrogen oxides, leaving little but water and nitrogen.

Hybrid – internal combustion at its most intelligent.

Our hybrid system combines a conventional petrol engine with an electric motor that boosts acceleration and enables brake energy to be recuperated and stored in the battery. In addition, our latest-generation hybrid models offer all-electric propulsion at up to approx. 20 mph, as well as the ability to 'glide' at speeds of up to 100 mph, by shutting down the combustion engine for maximum efficiency and zero emissions. In the E-Class, this advanced hybrid technology can also be enjoyed in diesel form, thanks to the new E 300 BlueTEC Hybrid.¹

E-Cell and F-Cell – new drivetrain concepts. We've also already rolled out limited production runs of two all-electric vehicles with zero local emissions: the A-Class E-Cell² and the B-Class F-Cell.² The F-Cell uses a hydrogen fuel cell to drive its electric motor, while the E-Cell is powered solely by twin lithium-ion batteries. Our F 125! F-CELL Plug-In Hybrid, meanwhile, demonstrates the possibilities of innovative zero-emission motoring for luxury vehicles.

Design for Environment. Our environmental philosophy is not just about in-car technologies. It also involves taking the entire lifecycle of each vehicle into account, from its initial planning to its end-of-life recycling. In addition, Mercedes-Benz is involved in the development of alternative fuels and conducts research in the field of bionics.

For more information about our holistic approach, see www.mercedes-benz.co.uk/blueefficiency

¹E 300 BlueTEC Hybrid Saloon: Euro 5 emissions rating. Fuel consumption, urban: 65.7–67.3 mpg; extra-urban: 65.7–67.3 mpg; combined: 65.7–67.3 mpg; combined CO₂ emissions: 112–109 g/km; efficiency rating A+ ²Provisional efficiency rating A+
Figures obtained in accordance with the prescribed measuring process (Regulation 715/2007/EC in the currently applicable version). The figures are not based on an individual vehicle and do not constitute part of the product offer; they are provided solely for purposes of comparison between different vehicle models



Efficiency in the A-Class

The new A-Class combines high levels of driver appeal with BlueEFFICIENCY measures that help to optimise fuel economy and reduce CO₂ emissions.

Environmental protection and energy conservation play a key role in the development of any Mercedes-Benz. That's why every new A-Class comes with fuel-saving

BlueEFFICIENCY technology such as the standard shift point indicator for manual transmission models. It helps recommend the most fuel-efficient shift points, helping

you to reduce fuel consumption and emissions as you drive. Other A-Class BlueEFFICIENCY features include:



- 1 Energy-saving ancillary systems
- 2 Adjustable radiator shutter (A 180 BlueEFFICIENCY) and on-demand fuel pump
- 3 High-efficiency alternator
- 4 New direct injection petrol engines; optimised diesel engines
- 5 Outstanding aerodynamics, resulting in a drag coefficient of 0.27
- 6 ECO start/stop function fitted as standard
- 7 ECO indicator fitted as standard
- 8 New 7G-DCT dual-clutch transmission (optional)
- 9 Tyres designed for lower rolling resistance
- 10 Intelligent use of weight-saving aluminium (for front wings, bonnet and other body parts)



Diesel engines

The new A-Class offers the very latest in Mercedes-Benz diesel technology. Its diesel engines are cleaner, more powerful and more refined, while also delivering improved CO₂ emissions and fuel consumption.

4-cylinder diesel engines. The new A-Class diesel engines offer all the familiar qualities of modern Mercedes-Benz diesels, delivering generous torque, excellent low-speed responses, and low CO₂ emissions, as well as enhanced refinement and less vibration.

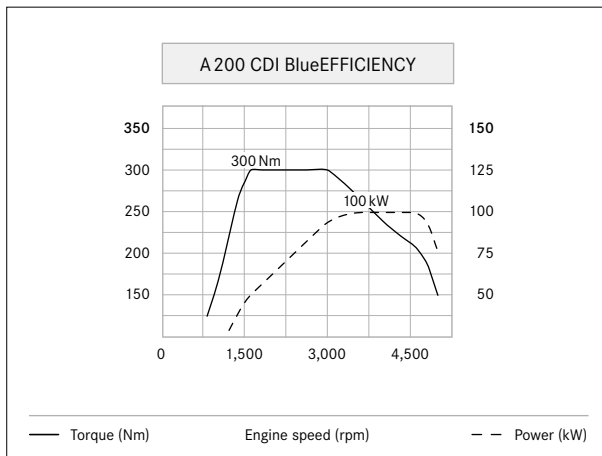

In the A 200 CDI BlueEFFICIENCY, the maximum 300 Nm of torque is available from just 1,600 to 3,000 rpm

What's more, they also benefit from further improved fuel efficiency, thanks to a fourth-generation common-rail diesel system that features higher injection pressures (1,800 bar), optimised combustion chambers and precise magnetic valve injectors. Increased combustion pressures



The A 200 CDI BlueEFFICIENCY's 4-cylinder diesel engine combines impressive pulling power with low fuel consumption and emissions

and turbocharging with variable turbine geometry ensure high levels of torque are available at any speed, while intelligent ancillary management helps to further reduce fuel consumption.

Three different A-Class models are available: the A 180 CDI BlueEFFICIENCY offers 109 hp (80 kW) and 260 Nm of torque; the A 200 CDI BlueEFFICIENCY produces 136 hp (100 kW) and a maximum 300 Nm of torque; and the A 220 CDI BlueEFFICIENCY boasts 170 hp (125 kW) and 350 Nm. All come fitted with our ECO start/stop function, which cuts the engine temporarily when the car comes to a standstill, and meet European emissions standards.

Petrol engines

The new A-Class petrol engines deliver lower fuel consumption and emissions without compromising on performance or refinement.

4-cylinder petrol engines. The new A-Class petrol engines boast impressive levels of power and torque, exemplary refinement and reassuringly low fuel consumption and emissions. This admirable blend of qualities is achieved courtesy of the combination of direct petrol injection, variable valve timing and turbocharging. In conjunction with high-pressure injection via precise piezo injectors, the optimised combustion process makes for cleaner combustion, enhancing the engine's operating efficiency and thereby improving fuel economy. Variable valve timing, which ensures the cylinders are charged only to the degree required, helps to further reduce fuel use, as do the engines' lower weight, reduced internal friction and on-demand ancillaries. In addition, the A-Class petrol engines come with ECO start/stop as standard, enabling them to save fuel when at a standstill.

There are three A-Class petrol models to choose from: the A 180 BlueEFFICIENCY offers 122 hp (90 kW) and a maximum 200 Nm of torque, the A 200 BlueEFFICIENCY has 156 hp (115 kW) plus 250 Nm of torque and the A 250 BlueEFFICIENCY boasts 211 hp (155 kW) and



The A 180 BlueEFFICIENCY delivers its maximum 200 Nm of torque all the way from 1,250 to 4,000 rpm

350 Nm of torque. All petrol engines comply with European emissions standards.

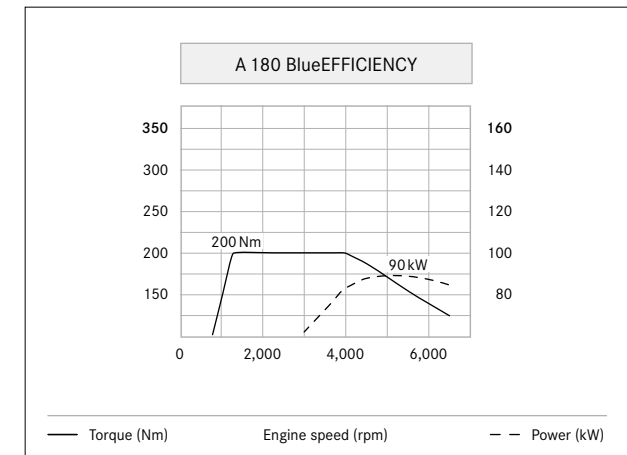

The A 180 BlueEFFICIENCY's new 4-cylinder petrol engine benefits from direct petrol injection, variable valve timing and turbocharging

Transmissions

The transmissions for the new A-Class are perfectly matched to its engines. They offer a choice of manual and dual-clutch systems, enabling you to opt for a sporty or economical driving style.

6-speed manual transmission (standard on A 180 CDI BlueEFFICIENCY, A 200 CDI BlueEFFICIENCY, A 180 BlueEFFICIENCY and A 200 BlueEFFICIENCY). The new 6-speed manual transmission offers short throws and hence rapid gear changes. In addition, all models come with the fuel-saving ECO start/stop function, which cuts the engine temporarily at traffic lights or when queuing, as well as a new ECO indicator in the instrument panel that helps to encourage efficient driving.

7G-DCT 7-speed automatic transmission (standard on A 220 CDI BlueEFFICIENCY and A 250 BlueEFFICIENCY, optional on all other models except A 180). This 7-speed dual-clutch transmission is an ideal blend of comfort, performance and efficiency. It consists of two independent gearbox units for the odd and even gears respectively, each with its own separate clutch. Under acceleration or deceleration, the currently inactive unit is able to preselect the next ratio ready for the anticipated up- or downshift. This makes for smoother, more immediate

sequential shifts with no loss of power. With a choice of 'Economy', 'Sport' and 'Manual' modes, engaged via a button on the centre console, 7G-DCT also allows you to choose between the comfort and convenience of automatic shifts or the greater involvement of manual gear changes. 'Economy' and 'Sport' modes offer different shift characteristics and speeds, with upshifts

coming at higher revs in 'Sport' mode than in 'Economy' and downshifts performed earlier. In 'Manual' mode, you determine the shift points yourself via gear shift paddles on the steering wheel. 7G-DCT also features an ergonomic Direct Select gear shift lever and cruise control with Speedtronic variable speed limiter.



7G-DCT – efficient gear changes without interrupting the flow of power



Suspension

The A-Class suspension and steering systems offer a fine blend of comfort, stability and precision. For even greater agility, there's the Dynamic Handling Package with sports suspension and Direct Steering.

Suspension and steering. The new A-Class is fitted with optimised McPherson struts at the front and an all-new multi-link rear suspension with weight-saving aluminium components, a combination that guarantees high levels of stability and comfort. The standard rack-and-pinion steering system, meanwhile, combines safety, precision and feel thanks to electromechanical assistance that decreases with speed and an integral Steer Control system that lends a hand in potentially critical situations.

Sports suspensions. There are two formidable sports suspensions available, dependent on the model line. Both give the A-Class even more agile and surefooted handling. Firmer springing and damping result in a sportier feel, helping to further increase stability and reduce roll. The sports suspension standard on the AMG Sport is lowered by 15 mm and includes the Dynamic Handling Package and Selective Damping System. The Engineered by AMG features its own exclusively matched sports suspension with even firmer settings and enhanced responsiveness.

Direct Steering (part of Dynamic Handling Package; optional on Sport and standard on AMG Sport). The Direct Steering system varies the steering ratio according to the steering angle, thus translating steering inputs even more immediately to the road and significantly reducing the steering effort required in tight turns or when parking.

At high speeds, it offers excellent straight-line stability and provides exceptionally accurate feedback.



The A-Class combines agility with high levels of comfort



Integrated safety concept

Like all our passenger cars, the new A-Class is built according to an integrated safety concept. It ensures the many passive and active protection systems work together to enhance safety in every situation – helping to bring our vision of accident-free driving another step closer.

As the inventor of the motor car, we feel a particular responsibility towards road safety. That's why we were the first manufacturer to develop an integrated safety concept that seamlessly combines a car's active and passive safety features, thus ensuring optimum all-round protection. This concept covers four different areas – safer driving, anticipating danger, protecting occupants and pedestrians and post-crash safety – and incorporates measures designed to maximise safety in every situation, by helping you to stay safe, alerting you to danger, and assisting you wherever possible. In addition, our unique Pre-Safe® anticipatory safety system recognises likely accident scenarios and takes steps that help to further enhance occupant protection. If a collision can't be avoided, intelligent passive safety systems help to provide protection where it's needed, while solutions that can minimise the consequences of an accident and facilitate emergency assistance are also a key part of this safety concept.

Safer driving: Attention Assist (standard). Particularly beneficial on long journeys, Attention Assist is a system for detecting fatigue. Between speeds of approximately 50 and 110 mph, it assesses the driver's behaviour via an array of sensors, compares it to the behaviour patterns already stored for that driver and thus registers unexpected changes that may indicate an increase in tiredness or inattentiveness.



If it detects signs of tiredness or inattentiveness, Attention Assist recommends taking a break

Safer driving: Collision Prevention Assist (standard). At speeds from approximately 20 mph, Collision Prevention Assist recognises if you are too close to the vehicle or object in front of you, whether it's moving or stationary. It can then alert you via visual and acoustic warnings. If you apply the brakes, Adaptive Brake Assist ensures exactly the brake force required to avoid a collision.



Collision Prevention Assist can warn you if it detects you come too close to the vehicle or object in front

Safer driving: Adaptive Brake Assist (standard). This modular braking system combines the anti-lock braking system (ABS) and the Electronic Stability Programme (ESP®) with additional braking functions that enhance convenience and safety. By drying the brakes in the wet and priming them automatically, i.e. placing the brake pads against the discs as soon as you take your foot off the accelerator, Adaptive Brake Assist gives you even more rapid braking responses and shorter stopping distances, while the Hill Start Assist function prevents you from rolling backwards when switching from brake to accelerator on inclines. With the hold function, you can also keep the brakes engaged by twice pressing and releasing the brake pedal.

Safer driving: DISTRONIC PLUS (optional; not available on A 180). This radar-assisted cruise control system maintains a preset distance from the vehicle in front, accelerating and braking automatically and thus making for more relaxing progress in high-speed driving. What's

more, DISTRONIC PLUS is equally effective in stop/start traffic, thanks to a sensor that reads radar signals at distances ranging from just 0.2 to 200 metres. DISTRONIC PLUS is only available in conjunction with the 7G-DCT 7-speed automatic transmission.

Safer driving: Lane-Keeping Assist/Blind Spot Assist (offered as Lane-Tracking Package option; not available on A 180). Lane-Keeping Assist recognises white road

markings and warns you via subtle vibrations of the steering wheel should you unintentionally stray out of lane. Blind Spot Assist, meanwhile, uses twin radar sensors to monitor the hard-to-see areas behind and to the sides and rear of the car. In lane changes at speeds of approximately 20 mph or above, the system can detect the presence of another vehicle in your blind spot and alert you to the danger via visual and acoustic warnings.

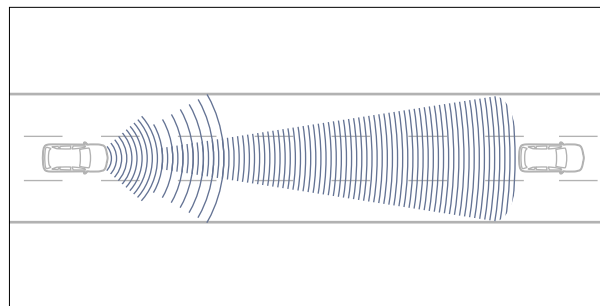

DISTRONIC PLUS radar-assisted cruise control automatically maintains a preset distance from the vehicle in front



Safer driving: Intelligent Light System (optional; not available on A 180). The Intelligent Light System comprises a variety of modes and functions: country mode, motorway mode, fog mode, cornering light function, the Active Light System and Adaptive High Beam Assist, which automatically maximises the headlamps' range then lowers them again as soon as the lights of an oncoming vehicle are detected. Also included are LED tail lights and integrated LED daytime running lights that help enhance visibility on the road.

Anticipating danger: Pre-Safe® anticipatory safety system (optional; not available on A 180). If it detects a probable accident scenario, Pre-Safe® can take a range of anticipatory measures to reduce the risk of injury to the occupants. Pre-Safe® evaluates sensor data from systems such as ESP® and BAS, enabling it to detect heavy over- or understeer and emergency braking. If need be, it can then instantly activate the front seat

belt tensioners, close the windows and move the front passenger seat to a safer position for an accident, ensuring maximum protection from airbags and seat belts should an impact then occur.

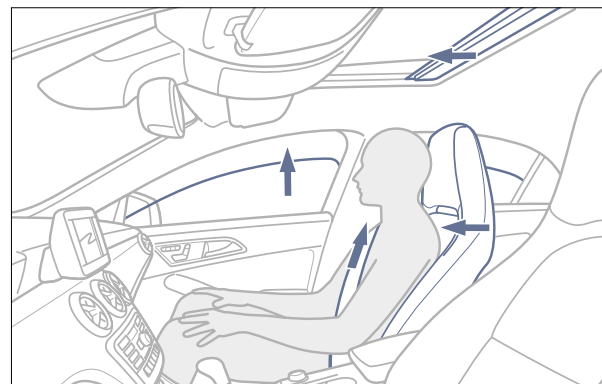

The Pre-Safe® system can detect critical situations and take anticipatory measures to enhance occupant protection

Protecting occupants and pedestrians: Active Bonnet (standard). If a pedestrian or cyclist hits the front of the A-Class, the rear of its bonnet is lifted by 8.5 centimetres, helping to reduce the risk of injury. Active Bonnet deploys automatically at speeds of between approx. 15 and 35 mph.

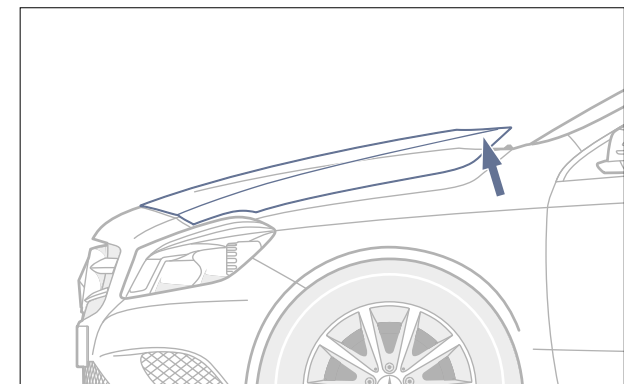

Active Bonnet helps to reduce the risk of injury to pedestrians and cyclists in the event of a collision

Protecting occupants and pedestrians: airbags

(standard). In conjunction with the robust bodyshell and high-strength passenger compartment, the seven standard airbags ensure occupants enjoy optimum crash protection. In addition to dual-stage front airbags, there are windowbags that stretch from the A- to the C-pillars,

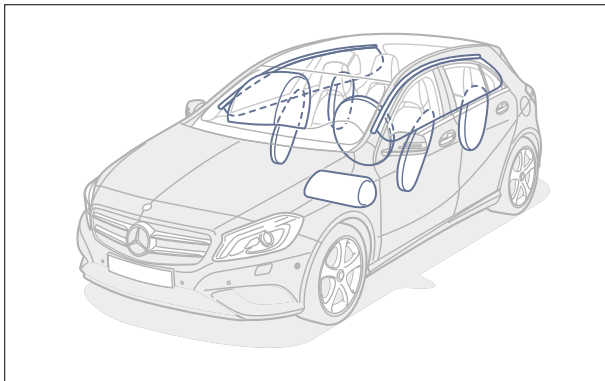

Windowbags for front and rear seat occupants, front airbags and sidebags and a driver's kneebag are all fitted as standard

front seat sidebags that also offer protection for the thorax and pelvis areas and a driver's kneebag that helps to further reduce the risk of injury in the event of an impact. Optional rear sidebags are also available (not available on A 180).

Post-crash safety: Mercedes-Benz Emergency Call System

(part of COMAND Online option). Should the restraint systems' sensors detect an accident, the emergency call system can use a mobile phone to automatically contact the emergency services (if the phone is switched on and connected to the vehicle). In addition, it simultaneously sends GPS data and other vehicle information to the Mercedes-Benz Emergency Call centre, where an operator will attempt to make contact with you by phone. The emergency call system can also be activated manually.

Post-crash safety: rescue assistance. Mercedes-Benz has developed a range of measures that help to minimise the secondary consequences of an accident and facilitate occupant rescue. These include automatic engine cut-off, self-activating hazard lights and emergency cabin lighting. In addition, the central locking system is automatically released in the event of an accident, and there are special crash joints between the front doors and wings that make it easier to open the doors after frontal collisions. In addition, Mercedes-Benz provides a rescue guide for emergency services that can be downloaded from the Internet at www.mercedes-benz.co.uk/rescueguide



Multimedia systems

For your in-car entertainment and communication, the new A-Class offers a choice of high-quality units: from the standard Audio 20 radio/single CD system with pre-wiring for Becker® Map Pilot navigation system to the optional COMAND Online system.



COMAND Online allows you to select from a wide range of information, entertainment and communication functions and view maps on its high-resolution 7-inch colour display

COMAND Online (optional; not available on A 180). The COMAND Online system combines hard-drive navigation with three years of free European map updates, mobile Internet access and a wide range of entertainment features. These include speed-sensitive volume adjustment, a music library with 10 GB of storage space for audio files and a DVD drive that plays CDs, MP3s, and video or audio DVDs. Thanks to the SD memory card slot, aux-in socket, USB port and Bluetooth® interface, you can also connect a variety of external devices and storage media. In conjunction with an Internet-ready mobile phone, the online function and built-in browser even enable you to surf the Web, access news and weather forecasts and use apps such as Facebook, Google Local Search with Street View and Panoramio, and downloadable Google Maps routes. COMAND Online can be operated either via the intuitive central controller, the steering wheel's multi-function buttons or the Linguatronic voice control system, with menus and maps presented on the high-resolution 7-inch colour display in the centre of the dashboard.



Audio 20 radio/single CD (standard). In addition to a tuner and CD drive with MP3/WMA/AAC playback, the Audio 20 system features Becker® Map Pilot navigation system pre-wiring, a Bluetooth® hands-free interface, USB port and aux-in socket in the glove compartment and an integrated telephone keypad. It also comes with six speakers that deliver crystal-clear sound and a 5.8-inch tablet-style display. An optional 6-disc CD changer can be added as an option (not available for A 180).

The system is operated either via the central controller or the steering wheel's multi-function buttons.

Becker® Map Pilot navigation system (optional).

Becker® Map Pilot can be integrated with the Audio 20 radio/single CD system and operated via the central controller, the multi-function steering wheel or Linguatronic voice control. It can also be tailored to your needs by downloading additional functions and map data.

Harman Kardon® Logic 7® surround sound system

(optional; not available on A 180). With its subwoofer, 9-channel DSP amplifier and Dolby Digital 5.1 and DTS technology, this high-performance 500-watt 11-speaker system delivers a truly first-class audio experience. Its surround sound can be optimised for the front, rear or middle of the cabin or for the entire interior.



The Becker® Map Pilot navigation system works with the Audio 20 radio/single CD's display and the multi-function display in the instrument cluster



Electronic assistants

In addition to a host of safety systems, the new A-Class now offers a wide range of electronic assistants that enhance safety and convenience when driving and manoeuvring.

Reversing camera (optional; not available on A 180).

This wide-angle camera with on-screen guide lines makes for safer and easier parking manoeuvres, capturing the area immediately behind the car and displaying the image on the central display. The camera is activated automatically as soon as the driver engages reverse.

Active Park Assist with Parktronic (optional; not available on A 180). With Active Park Assist, the A-Class can find parking spaces for you and even manoeuvre itself into them. At speeds of up to approximately 20 mph, it identifies a suitable space, then asks you to confirm

whether you wish to proceed. Once you've come to a standstill and engaged reverse, the system simply steers you in, manoeuvring so precisely that it requires a gap just 1.30 metres longer than the car.

Speed Limit Assist (fitted with the optional COMAND Online system). Speed Limit Assist reads speed limit signs and displays the permitted maximum speed in the instrument panel until the limit changes. The front-mounted camera detects round speed limit warnings both on roadside signs and in overhead gantries and is particularly useful in areas where the speed limit varies

or when passing through roadworks. To help identify the limit correctly, it compares speed limit signs with map data from the navigation system.



With the reversing camera, the COMAND Online display shows you what's immediately behind the car when manoeuvring



Active Park Assist displays the status of the parking manoeuvre in the instrument panel



Speed Limit Assist shows the permitted maximum speed in the instrument panel and on the COMAND Online display



Lighting and climate control

The Light and Sight Package enhances safety and comfort, while optional luxury automatic climate control helps occupants to enjoy ideal cabin conditions at all times.

Light and Sight Package (optional on SE, standard on Sport, AMG Sport and Engineered by AMG; not available for A 180). The Light and Sight Package helps to enhance visibility and safety in the dark or in poor weather, adding rain-sensing wipers and a larger screenwash reservoir, as well as courtesy and warning lights for the doors and tailgate. It also includes illuminated vanity mirrors, illuminated footwells front and rear, illuminated door sills, illuminated headrests on driver and passenger seats, independently operable rear reading lights and a rear roof console light, while ambient interior lighting for the door

panels, grab handles and front seats lend a stylish touch to the cabin at night.

Luxury automatic climate control (optional; not available on A 180). This two-zone automatic climate control system allows the driver and front passenger to set separate temperatures for each side of the cabin. In addition, it compensates automatically for external influences such as sunlight, air quality and humidity, ensuring occupants enjoy optimum comfort whatever the weather.



The Light and Sight Package's additional interior lighting adds a practical and stylish touch



The optional luxury automatic climate control system maintains your ideal cabin temperature at all times



Seats

The new A-Class offers attractive and supportive seats front and rear. In addition, it offers options that give those in the front an even greater range of seat adjustment.

The A 180's seats feature high backrests with adjustable head restraints and good side support, and are upholstered in Black cloth.

All other models have high-quality sports seats with integrated head restraints as standard. The SE comes with Artico artificial leather/cloth upholstery, the Sport offers Black Artico/chequered-design cloth and the AMG Sport and Engineered by AMG models both feature Black Artico artificial leather/Dinamica microfibre with

contrasting red top-stitching. Optional leather upholstery is also available – as part of either the Exclusive Package or AMG Exclusive Package. A Seat Comfort Package comprising seat height adjustment and tilt adjustment for the front seats is fitted as standard on all models.

4-way lumbar adjustment for front seats (optional; not available for A 180). This option enables the driver and front seat passenger to adjust the level of lumbar support according to their individual needs via air chambers

within the front seat backrests. These twin chambers can be inflated or deflated in accordance with the occupant's chosen setting and are also height-adjustable.

Memory Package (optional; not available on A 180). The Memory Package adds full electrical adjustment to both front seats. It also allows three sets of positions for the driver's seat, steering column and exterior mirrors to be saved and recalled at any time.



The comfortable front seats boast excellent ergonomics and a wide range of adjustment



Those in the rear benefit from similarly high levels of comfort



Sunroof and storage

The new A-Class offers ample luggage and storage space, while the panoramic sliding sunroof makes its interior feel even roomier.

Panoramic sliding sunroof (optional; not available on A 180). The large glass area of this electrically operated sliding sunroof allows light to stream into the cabin, making for a particularly airy and welcoming atmosphere. It comes with a motor-driven blind for instant shade and a wind deflector designed to keep wind noise to a minimum when the sunroof is open. If the optional Light and Sight Package is fitted, the sunroof even closes automatically should it start raining.



The panoramic sliding sunroof makes the A-Class interior feel even lighter and more spacious

Luggage compartment. Folding the $\frac{1}{3}:\frac{2}{3}$ split rear seat forward creates up to 1,157 litres of load space and an almost completely flat floor of up to 1.24 metres in length. With both rear seat sections in place, the A-Class has a luggage capacity of 341 litres.



The A-Class rear can be turned into a spacious load area with minimum effort

Storage Package (optional; not available on A 180). The Storage Package combines a range of extras that help you to keep small items safely and securely stowed. These include a glasses compartment in the overhead control panel, storage boxes beneath the front seats, parcel nets on the front seat backrests, in the front passenger footwell, on the sides of the luggage compartment and on the underside of the rear parcel shelf, plus a useful 12V socket in the boot.



The practical Storage Package combines a range of additional compartments and nets



A-Class A 180

The new A-Class A 180 offers stylish comfort as standard.



The A 180 combines dynamic lines, intelligent ideas and high levels of attention to detail. The exterior features 15" 10-hole steel wheels, a body-colour rear bumper with a black diffusor-style insert, while the state-of-the-art safety equipment includes driver aids such as Attention Assist and Collision Prevention Assist.







The A 180's generously-equipped interior features a multi-function steering wheel, a multi-function display in the instrument panel and a 6-speaker Audio 20 radio/single CD system featuring 5.8-inch tablet-style display, Becker® Map Pilot navigation system pre-wiring and Bluetooth® hands-free interface. The seats and door centre panels are upholstered in Black Domburg cloth and there's Honeycomb-look interior trim as standard.



021

Upholstery

021 Black Domburg cloth

Trim

Honeycomb look



A-Class SE

Distinctively confident: the A-Class SE.

Stylish and self-assured, the A-Class SE adds chrome belt-line strips and a body-colour two-louvre grille with chrome trim. Also fitted as standard are 16" 10-spoke alloy wheels that further underline its distinctive personality.









The SE interior welcomes you with standard sports seats and Artico artificial leather/cloth upholstery in either Black or Black/White. The standard equipment also includes a 12-button nappa leather multi-function steering wheel, matrix-look interior trim and chrome surround for the gear shift lever and air vents.

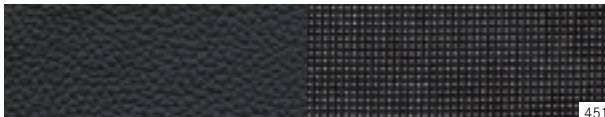

451

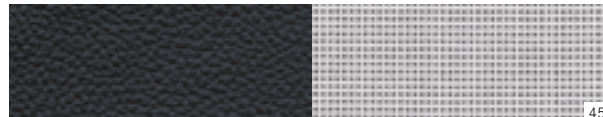

455

Upholstery

451 Black Artico artificial leather/cloth

455 Black/White Artico artificial leather/cloth

Trim

Matrix look



A-Class Sport

The A-Class Sport adds athletic appeal.

True to its name, the Sport line has a dynamic look that features chrome exterior trim, a silver two-louvre grille, twin sports tailpipes and 17" bi-colour 5-twin-spoke alloy wheels. For added comfort and safety, it also comes with cruise control as standard plus a Light and Sight Package that includes illuminated headrests, rain-sensing wipers, additional reading lights and illuminated vanity mirrors.



A-Class Sport shown in optional Mountain Grey (code 787)





A-Class Sport shown in optional Mountain Grey (code 787)







The Sport interior is similarly striking, thanks to sports seats with Black Artico artificial leather/chequered-design cloth upholstery and contrasting top-stitching. Grey Artico artificial leather/chequered-design cloth is available as a no-cost option. Chequered pattern design trim is available in either Black or Grey, depending on the upholstery colour chosen.



361

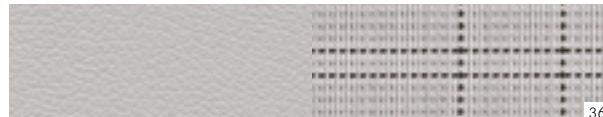

368

Upholstery

361 Black Artico artificial leather/chequered-design cloth

368 Grey Artico artificial leather/chequered-design cloth

Trim

Black chequered-pattern look

Grey chequered-pattern look



A-Class AMG Sport

Looks and feels more sporty on the road: the A-Class AMG Sport.

The AMG Sport lends an even bolder, more forceful look to the A-Class exterior, adding 18" AMG multi-spoke alloy wheels, front brake calipers with 'Mercedes-Benz' lettering, and AMG bodystyling comprising front apron, rear apron and side skirts. On the road, its Dynamic Handling Package, which includes 15 mm lower sports suspension and selective damping, ensures it feels every bit as good as it looks.



A-Class AMG Sport shown in optional South Seas Blue (code 162)





A-Class AMG Sport shown in optional South Seas Blue (code 162)







Inside, the AMG Sport boasts an exclusive and exceptionally sporty ambience. The many highlights include sports seats upholstered in Artico artificial leather/Dinamica microfibre with contrast red stitching, carbon fibre-look trim, and a nappa leather multi-function sports steering wheel with red stitching, perforations in the grip areas and a flattened lower section.



651



Upholstery

651 Black Artico artificial leather/Dinamica microfibre

Trim

Carbon-fibre look



A-Class Engineered by AMG

Expressive design meets impressive performance with specially-developed AMG sports suspension.



Unmistakably Engineered by AMG. The striking diamond grille adds to the dynamic character of the A-Class

The Engineered by AMG line is the A-Class at its most dynamic. In addition to AMG bodystyling, 18" AMG 5-twin-spoke alloy wheels and lowered sports suspension 'Engineered by AMG', it boasts a striking diamond grille that's exclusive to this line, plus bi-xenon headlamps, red trim parts on front and rear bumpers, and red brake calipers with 'Mercedes-Benz' lettering.

The Engineered by AMG interior champions many striking highlights including a red colour theme throughout. The sport seats feature Artico artificial leather/Dinamica microfibre seats with contrast red top-stitching and matching red *designo* seat belts. The air vents have black surrounds and red inserts, whilst the sporty instrument cluster comes with silver-coloured dials and red needles.



For a truly sporty feel, the multi-function steering wheel is trimmed in nappa leather with contrast red stitching, which is repeated on the door armrests with chrome-look trim. The dynamic look is further enhanced by carbon fibre-look trim, brushed metal sports pedals with rubber studs and stainless steel door sills. And to complete it all in style, the velour floor mats with red stitching carry the Engineered by AMG signature.



Sports seats in Artico artificial leather/Dinamica microfibre and carbon-fibre look trim





Night Package

Available for the Sport and AMG Sport lines, the optional Night Package makes for an even more striking exterior. It includes a two-louvre high-gloss black grille with chrome trim, black exterior mirrors, high-gloss black beltline strips, 18" alloy wheels with run-flat capability, and heat-insulating privacy glass for the rear windscreen and rear side windows. Beautiful bi-xenon headlamps with integrated LED daytime running and matching LED tail lights illuminate the road at night.



Exclusive Package and AMG Exclusive Package



The optional Exclusive Package adds an extra touch of luxury to the A-Class Sport interior. It includes heated front sports seats with 4-way lumbar adjustment and a choice of Lava Black, Hazelnut Brown or Crystal Grey leather upholstery. The door centre panels, centre armrest and upper dashboard are trimmed in matching Artico artificial leather, while the steering wheel and gear shift lever have black leather trim. For the AMG Sport and Engineered by AMG lines, there's the optional AMG Exclusive Package featuring two-tone red-cut leather upholstery with contrasting red decorative seams.





801

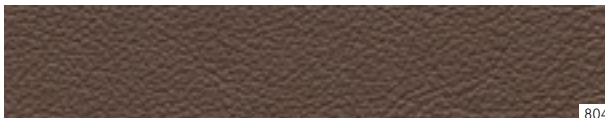

804

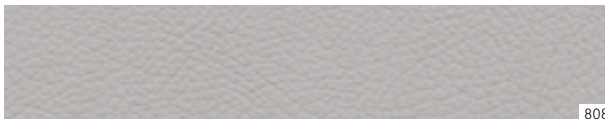

808

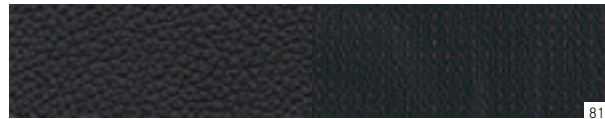
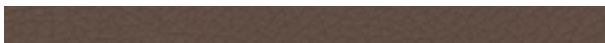

811



Exclusive Package

Upholstery

801 Lava Black leather

804 Hazelnut Brown leather

808 Crystal Grey leather

Trim

Black Artico artificial leather

Crystal Grey Artico artificial leather

Hazelnut Brown Artico artificial leather

AMG Exclusive Package

Upholstery

811 Lava Black leather with red perforations

Trim

Carbon-fibre look



Standard equipment | Selection



3-spoke 12-button multi-function steering wheel



Audio 20 radio/single CD with 5.8-inch screen



Air conditioning



Twin cup holders



ECO start/stop button

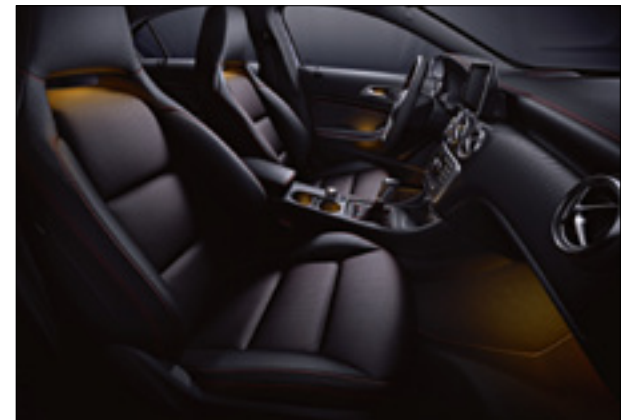

Ambient lighting



Optional extras | Selection



Bi-xenon headlamps



Panoramic sliding sunroof



Tow bar (not available for AMG Sport or Engineered by AMG)



Harman Kardon® Logic 7® surround sound system



Reversing camera



Luxury automatic climate control



Wheels



15" 10-hole steel wheels (standard on A 180, code R00)



17" 5-twin-spoke bi-colour alloy wheels (standard on Sport, code R48)



17" 5-twin-spoke alloy wheels (optional on Sport, code R11)



16" 10-spoke alloy wheels 205/55 R 16 (standard on SE, code 55R)



17" 5-twin-spoke alloy wheels, Titanium finish (optional on Sport, code 44R)



18" bi-colour 5-twin-spoke alloy wheels (standard on Sport as part of the optional Night Package, code R38)





18" bi-colour 5-twin-spoke alloy wheels (optional on Sport; only in conjunction with the optional Night Package, code R10)



18" AMG multi-spoke alloy wheels, black finish (optional on AMG Sport and AMG Sport with the optional Night Package, code 646)



18" AMG 5-spoke alloy wheels (standard on Engineered by AMG, code 774)



18" AMG multi-spoke alloy wheels (standard on AMG Sport, code 791)



18" AMG 5-twin-spoke alloy wheels (standard on AMG Sport as part of the optional Night Package, code 781)



Retailer-fit accessories

A Mercedes-Benz is not just a car, it's a travel companion that can be tailored to your needs – with our wide range of Retailer-fit accessories.

→ www.mercedes-benz.co.uk/accessories

More practicality? More connectivity? More striking styling? Or perhaps all three? However you want to enhance your A-Class, you'll find there's a Retailer-fit accessory for you.

With the Mercedes-Benz Drive Kit Plus for iPhone®, you can integrate your iPhone® 4/4S fully with the car's



Elegant, aerodynamic and extremely practical: the roof box for the A-Class offers style and space in equal measure

Audio 20 radio/single CD or COMAND Online system. Used in conjunction with the Digital DriveStyle app, which can be downloaded free of charge from the iTunes® App Store, it gives you access to your phone's media files, which can be selected via the audio system's easy-to-use controller and viewed on its central display.

The integration with your A-Class and the app's revolutionary user interface design also open up a whole range of digital possibilities. You can find your way with advanced Garmin® navigation software featuring Internet-based real-time traffic information, online points-of-interest search and 3D maps. You can listen to your own custom radio stream courtesy of AUPEO! Personal Radio, an online music service that plays tracks according to whatever genre or artist you enter. And you can keep up to date with your social networks too, thanks to the sharing and posting functions for Facebook, Twitter and Glympse, the playback of music and other content from social networks and a special read-aloud function. What's more, you'll never have to search high and low for

your vehicle again. The intuitive Car Finder automatically stores its location, while the navigation system's walking directions guide you back to wherever you parked it.

For an A-Class with added carrying capacity, there's the spacious roof box 400. It swallows up to approximately 400 litres of luggage, can take loads of up to 75 kg and has handles on both sides. There's even a custom luggage set to help you make the most of the available space. It comprises three cases plus a ski bag for up to two pairs of skis.

The accessories range also offers exterior styling accessories such as a sporty roof spoiler and a rear apron with diffusor-look insert. Together, they give your A-Class an even more athletic look.

For more details about these and other A-Class accessories, please see the relevant brochure or talk to your local Mercedes-Benz Retailer.





With Drive Kit Plus for iPhone® and the Digital DriveStyle app, your smartphone is fully integrated into the new A-Class



Services

Test drive. Words can only do so much. Some things have to be experienced to be truly appreciated. Which is why we'd like to invite you for a test drive. Feel the power of efficient engines that offer impressive fuel consumption. Feel exhilarated by precise steering, designed to connect the driver with the road and enjoy sumptuous levels of comfort. Your Mercedes-Benz Retailer will be happy to make arrangements for you to experience the things that set a Mercedes-Benz apart. Alternatively, to request a test drive online simply visit www.mercedes-benz.co.uk/testdrive We look forward to seeing you.

Mercedes-Benz Finance. At Mercedes-Benz Finance, our single-minded aim is to provide optimum financial solutions for all those who share the Mercedes-Benz philosophy of absolute commitment to quality. Whether you are a private customer or a business user, our finance and leasing packages can be tailored to meet your individual needs. For further information on Mercedes-Benz Finance, please contact your local Mercedes-Benz Retailer.



Mercedes-Benz Insurance offers a fully comprehensive 5 star¹ Motor Insurance policy specifically designed to give you the cover you would expect from Mercedes-Benz. For a quotation, please call 0845 600 2180?

Interactive Owner's Manual. The website also offers an interactive tour, enabling you to take a closer look at your desired model. This simulation is the ideal way to acquaint yourself with your dream car. You can view key functions in detail, gain an insight into the car's inner workings or look at the benefits of each model. For further details, visit www.mercedes-benz.co.uk/aaclassmanual



Roadside Assistance. Rest assured that should you ever need help, Mercedes-Benz Roadside Assistance is there for you. In the unlikely event of a technical breakdown³ you can rely on the Mercedes-Benz Roadside Assistance Team – anywhere in Europe. Simply phone our Customer Assistance Centre on 00800 1 777 7777,⁴ where our specialists will organise assistance for you. Mercedes-Benz will also assist you in the event of a minor mishap preventing you from driving your vehicle³. Whether you lose your key, run out of fuel or your vehicle is damaged due to an accident or vandalism, Mercedes-Benz ensures that you still reach your destination. Often the problem can be rectified on the spot, but if this is not possible, we will naturally ensure that your vehicle is taken to the nearest Mercedes-Benz Official Workshop to get you back on the road as quickly as possible.

¹ As rated by Defaqto, a leading UK independent financial research company.
Mercedes-Benz Motor Insurance is underwritten by Aviva Insurance Limited
² Calls are charged at local rate and may be recorded

Mercedes-Benz World at Brooklands. Celebrate the story of Mercedes-Benz and you'll celebrate the story of motoring itself at Mercedes-Benz World in Surrey. Discover Mercedes-Benz racing heritage, from its connections to the famous Brooklands circuit through to present-day Formula 1™ brought to life in the most sensational way. View, touch and sit in every car from the Mercedes-Benz range, and encounter automotive legends like the 'Gullwing' and many other classic icons, in the UK's largest Mercedes-Benz showcase. Then set your pulse racing by booking one of our thrilling Driving Experiences. Enjoy AMG performance on the purpose-built Handling Circuits or Wet Skid Circle, an axle-twisting off-road adventure, or treat your kids over 1.5 metres tall to their own driving experience in an A-Class or on the off-road terrain in an M-Class.

³ Cover is initially valid for your vehicle for four years from the date of first registration. This can be extended from the fifth year, up to a maximum of 30 years, on completion of each scheduled maintenance service, providing that this service is carried out by a Mercedes-Benz

And for kids even younger and under 1.3 metres tall, let them be a 'Little Learner' in their own miniature electric version of the desirable Mercedes-Benz SL. For more interactive action, take a virtual 3D journey along the production line in 'Build' and take a seat in the cinema to accelerate from the birth of the car to the latest innovations in 20 eye-opening minutes.

Relax and refuel in Café 1886, or for something more enjoy the delicious menu and elegant surroundings of the Gullwing Restaurant. Finally, extend your visit with a short stroll to Brooklands Museum to see their collection of classic cars, aviation exhibitions – and the legendary Concorde. For more information visit www.mercedes-benzworld.co.uk

Official Workshop. Minor mishap cover is provided at the absolute discretion of Mercedes-Benz
⁴In non-affiliated European countries: +44 20 7975 7077



Dimensions

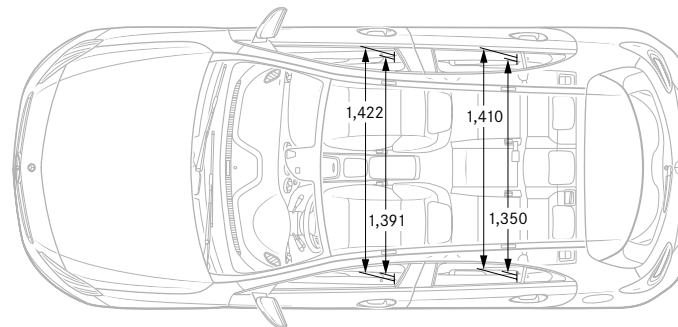
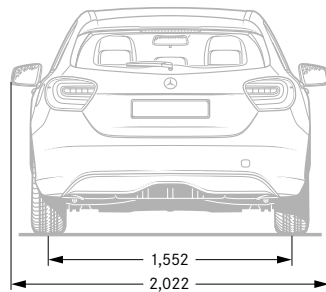
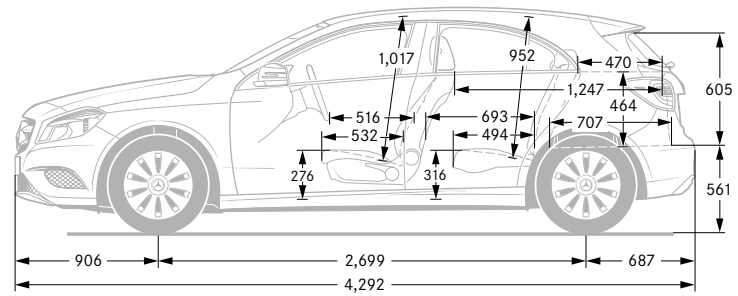
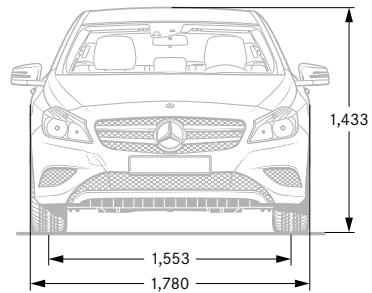

All measurements in millimetres. The dimensions shown are mean values and apply to standard-specification, unladen vehicles



Technical data

	Diesel engines			
	A 180 CDI BlueEFFICIENCY	A 180 CDI BlueEFFICIENCY (7G-DCT)	A 200 CDI BlueEFFICIENCY	A 220 CDI BlueEFFICIENCY
Arrangement/cylinders/valves	in-line/4/16	in-line/4/16	in-line/4/16	in-line/4/16
Total displacement – cc	1,461	1,796	1,796	2,143
Rated output ¹ – hp (kW) at rpm	109 (80)/4,000	109 (80)/3,200–4,600	136 (100)/3,600–4,400	170 (125)/3,400–4,000
Rated torque ¹ – Nm at rpm	260/1,750–2,500	250/1,400–2,800	300/1,600–3,000	350/1,400–3,400
Acceleration 0–62 mph – sec (auto.)	11.3	(10.6)	9.3 (9.2)	– (8.2)
Top speed, approx. – mph	118	118	130	137
Tyre size, front	205/55/R16	205/55/R16	225/45 R17	225/40 R18
Tyre size, rear	205/55/R16	205/55 R16	225/45 R17	225/40 R18
Fuel consumption ² – mpg (auto.)				
Urban	62.8	(58.9)	51.4 (56.5)	– (52.3)
Extra-urban	85.6	(74.3)	72.4 (70.6)	– (74.3)
Combined	74.3	(68.9)	62.8 (65.7)	– (64.2)
CO ₂ emissions, combined ² – g/km (auto.)	98	(109)	118 (114)	– (115)
EU emissions standard	EU5	EU5	EU5	EU6
Fuel tank capacity/reserve (approx.) – l	50/6.0	50/6.0	50/6.0	50/6.0
Boot capacity – l	341–1,157	341–1,157	341–1,157	341–1,157
Turning circle – m	11.00	11.00	11.00	11.00
Kerb weight ³ – kg (auto.)	1,395/565	(1,475/525)	1,445/565 (1,475/525)	– (1,485/525)
Perm. Gross Vehicle Weight – kg (auto.)	1,960	(2,000)	2,010 (2,000)	– (2,010)

¹ Figures according to Directive 80/1269/EEC in the currently applicable version ² The figures shown were obtained in accordance with the prescribed measuring process (Directive 80/1268/EEC in the currently applicable version). The figures are not based on an individual model and do not constitute part of the product offer; they are provided solely for purposes of comparison between different vehicle models

³ Figures according to Directive 92/21/EC, version 95/48/EC (kerb weight with fuel tank 90% full, driver, 68 kg, and luggage, 7 kg) for standard-specification vehicles. Optional extras and accessories will generally increase this figure and reduce the payload capacity accordingly

Arrangement/cylinders/valves
Total displacement – cc
Rated output ¹ – hp (kW) at rpm
Rated torque ¹ – Nm at rpm
Acceleration 0–62 mph – sec (auto.)
Top speed, approx. – mph
Tyre size, front
Tyre size, rear
Fuel consumption ² – mpg (auto.)
Urban
Extra-urban
Combined
CO ₂ emissions, combined ² – g/km (auto.)
EU emissions standard
Fuel tank capacity/reserve (approx.) – l
Boot capacity – l
Turning circle – m
Kerb weight ³ – kg (auto.)
Perm. Gross Vehicle Weight – kg (auto.)

Petrol engines

A 180 BlueEFFICIENCY	A 200 BlueEFFICIENCY	A 250 BlueEFFICIENCY	Engineered by AMG A 250 BlueEFFICIENCY
in-line/4/16	in-line/4/16	in-line/4/16	in-line/4/16
1,595	1,595	1,991	1,991
122 (90)/5,000	156 (115)/5,300	211 (155)/5,500	211 (155)/5,500
200/1,250–4,000	250/1,250–4,000	350/1,200–4,000	350/1,200–4,000
9.2 (9.1)	8.4 (8.3)	(6.6)	(6.6)
126	139	149	149
195/65 R 15	205/55 R 16	225/45 R 17	235/40 R 18
195/65 R 15	205/55 R 16	225/45 R 17	235/40 R 18
37.7 (39.8)	37.2 (39.2)	(33.6)	(33.6)
65.7 (62.8)	61.4 (60.1)	(56.5)	(55.4)
51.4 (52.3)	49.6 (50.4)	(45.6)	(44.1)
128 (127)	134 (131)	(145)	(148)
EU6	EU6	EU6	EU6
50/6.0	50/6.0	50/6.0	50/6.0
341–1,157	341–1,157	341–1,157	341–1,157
11.00	11.00	11.00	11.00
1,370/565 (1,395/525)	1,370/565 (1,395/525)	(1,445/525)	(1,445/525)
1,935 (1,920)	1,935 (1,920)	(1,970)	(1,970)

¹ Figures according to Directive 80/1269/EEC in the currently applicable version ² The figures shown were obtained in accordance with the prescribed measuring process (Directive 80/1268/EEC in the currently applicable version). The figures are not based on an individual model and do not constitute part of the product offer; they are provided solely for purposes of comparison between different vehicle models

³ Figures according to Directive 92/21/EC, version 95/48/EC (kerb weight with fuel tank 90% full, driver, 68 kg, and luggage, 7 kg) for standard-specification vehicles. Optional extras and accessories will generally increase this figure and reduce the payload capacity accordingly

Paint finishes

Non-metallic paints (standard)

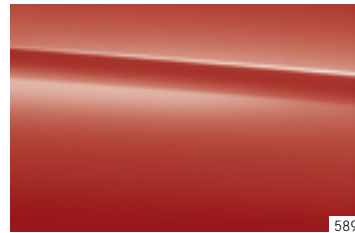

589



650

Non-metallic paints (standard)

589 Jupiter Red

650 Cirrus White

Metallic paints (optional)¹

162 South Seas Blue

191 Cosmos Black

761 Polar Silver

787 Mountain Grey

893 Monolith Grey²

894 Universe Blue

designo paint (optional)³

662 *designo* Magno Mountain Grey⁴

¹ Not available for A 180

² Not available for AMG Sport and Engineered by AMG

³ Additional-cost option. Only available on AMG Sport and Engineered by AMG. Expected availability first quarter 2013

⁴ *designo* Magno matt paint finishes require special care. Please ask your Retailer for further details

Metallic paints (optional)¹

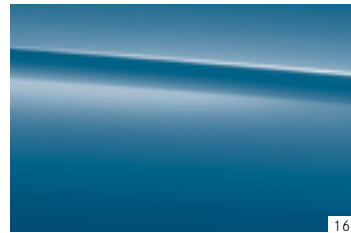

162

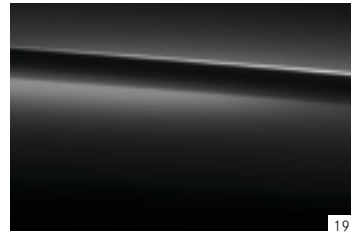

191



761

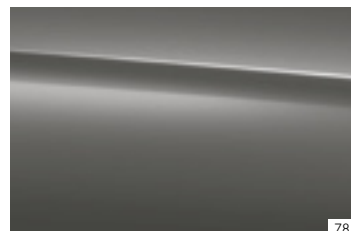

787

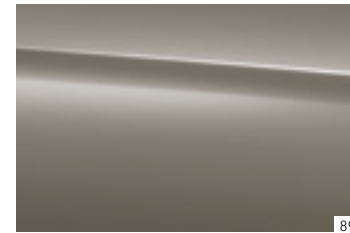
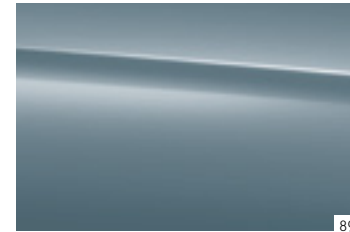
893²

894

designo paint (optional)³

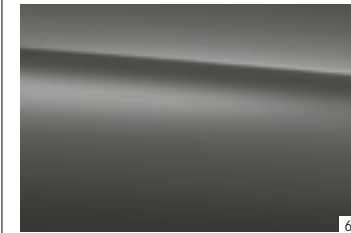
662⁴

Take-back of end-of-life vehicles. Coming full circle. At the end of its long life, you can return your A-Class to us for environment-friendly disposal in accordance with the EC End-of-Life Vehicle Directive!¹ But that day lies a long way off.

¹Applies in accordance with national regulations to vehicles up to 3.5t permissible gross weight. The A-Class has met the statutory regulations governing the suitability of the vehicles' design for reuse and recycling for a number of years now. A network of vehicle take-back depots and dismantlers has been established which will process your vehicle in an environment-friendly manner. The ways in which both vehicles and parts can be recovered are subject to ongoing development and improvement. Consequently, the A-Class will be able to comply with any future increases in the recycling quota within the stipulated time limits. For further information, please go to www.mercedes-benz.co.uk or call 0808 156 6606.

Please note: changes may have been made to the products since this brochure went to press (18.05.2012). The manufacturer reserves the right to make changes to the design, form, colour and specification during the delivery period, provided these changes, while taking into account the interests of the vendor, can be deemed reasonable with respect to the purchaser. Where the vendor or the manufacturer uses symbols or numbers to describe an order or the subject of an order, no rights may be derived solely from these. The illustrations may show accessories and items of optional equipment which are not part of standard specification. Colours may differ slightly from those shown in the brochure, owing to the limitations of the printing process. This brochure has been compiled by Daimler AG of Germany and is distributed internationally. It provides a general indication of the range of models, features, optional extras and/or colours available in various countries. Some of the models, features, optional extras and/or colours shown may not be available in your country or may only be available in a different specification. Additionally some models, features, optional extras and/or colours may only be available in combination with others. For current and more specific information in relation to the range of models, features, optional extras and/or colours available in your country, and their pricing, you should contact your nearest authorised Mercedes-Benz Retailer. E&OE www.mercedes-benz.co.uk

