



> View price list



> View offers



> SOUND WITH POWER



> Mercedes-Benz Magazine

B-Class



Mercedes-Benz





> View price list



> View offers



> SOUND WITH POWER



> Mercedes-Benz Magazine

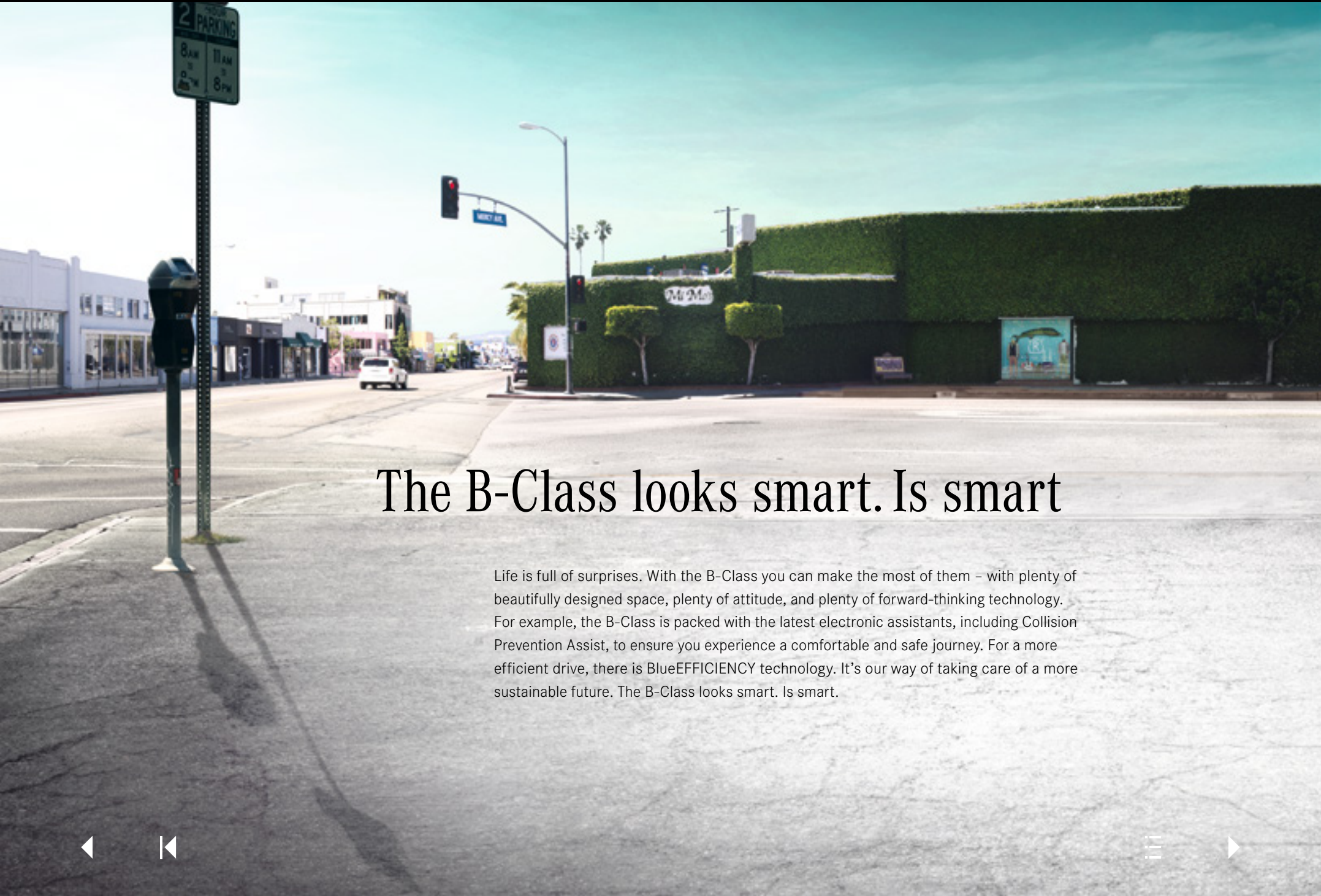

The B-Class looks smart. Is smart

Life is full of surprises. With the B-Class you can make the most of them – with plenty of beautifully designed space, plenty of attitude, and plenty of forward-thinking technology. For example, the B-Class is packed with the latest electronic assistants, including Collision Prevention Assist, to ensure you experience a comfortable and safe journey. For a more efficient drive, there is BlueEFFICIENCY technology. It's our way of taking care of a more sustainable future. The B-Class looks smart. Is smart.





> View price list



> View offers



> SOUND WITH POWER



> Mercedes-Benz Magazine



Featured models at a glance:

4 | Mercedes-Benz B 220 CDI Sport
Polar Silver metallic

18" bi-colour alloy wheels, panoramic sliding sunroof, Active Park Assist, Exclusive Package, Hazelnut Brown leather upholstery, high gloss Black Ash wood trim

10 | Mercedes-Benz B 180 SE
Jupiter Red non-metallic

17" alloy wheels, Intelligent Light System, Domburg fabric upholstery in Grey, Matrix-look trim, automatic climate control, heated seats, rear centre armrest



With an iPhone® or iPad® you can download the interactive B-Class brochure app either by scanning the QR code or by visiting the App Store

Equipment options at a glance:

18 | Engines and suspension

26 | Safety

30 | Comfort

38 | Equipment

54 | Services

56 | Facts and finishes

Specifications shown may include optional equipment and accessories





> View price list



> View offers



> SOUND WITH POWER



> Mercedes-Benz Magazine



Space for even the fullest of lives

Whatever you've planned, the B-Class is ready for it. The B-Class provides the comfort required for those longer journeys and the space to carry plenty. Combine this with the joy of driving this exciting Mercedes-Benz with its even sportier, stylish look inside and out. The striking front with high-tech headlights and a ravishing side profile provide plenty of attitude. Pair this with the latest Mercedes-Benz safety systems and you have all the ingredients for a perfect day on the road.

B-Class Sport with optional panoramic sliding sunroof, Active Park Assist and metallic paint





> View price list



> View offers



> SOUND WITH POWER



> Mercedes-Benz Magazine

Room for five and your inspiration



B-Class Sport with optional panoramic sliding sunroof, Active Park Assist and metallic paint





> View price list



> View offers



> SOUND WITH POWER



> Mercedes-Benz Magazine



B-Class Sport with optional panoramic sliding sunroof, Active Park Assist and metallic paint





> View price list



> View offers



> SOUND WITH POWER



> Mercedes-Benz Magazine

Your favourite song is on the radio, your friends in the rear provide you with the latest gossip. Sometimes one pair of eyes just doesn't seem enough to stay completely focused. To make sure you're well equipped for what's ahead, the B-Class is fitted with Collision Prevention Assist as standard – a first for a car in this class. This system constantly watches the road without ever getting distracted by events elsewhere. And with the possibility of up to ten other electronic assistants on board, it's just one of many ways the B-Class looks out for you. → Page 28, 29, 34, 35

Always looks where you're going



B-Class Sport with optional panoramic sliding sunroof, Active Park Assist and metallic paint

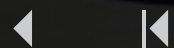



> View price list



> View offers



> SOUND WITH POWER



> Mercedes-Benz Magazine



Compact enough to fit in most parking spaces, spacious enough to accommodate all your adventures. The 488-litre load compartment provides plenty of room for your weekly shopping, luggage or pushchair. Need more space? Simply opt for the Easy-Vario-Plus Package. For all your smaller items, there are clever storage compartments throughout, and should you need further space to keep those important items safely packed away, you can opt for the Storage Package. Needless to say, you and your passengers will enjoy lots of room to stretch your legs. → Page 36, 37

Interior shown includes optional automatic climate control (two-zone control with display showing manual fan setting and air distribution), COMAND Online system, Exclusive Package, Memory Package, Harman Kardon® Logic 7® surround sound system, automatic transmission and rear centre armrest





> View price list



> View offers



> SOUND WITH POWER



> Mercedes-Benz Magazine

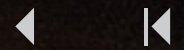



> View price list



> View offers



> SOUND WITH POWER



> Mercedes-Benz Magazine



Whether you choose Jupiter Red or Cirrus White, there are blue skies ahead

With the B-Class you're always one step ahead. By saving fuel and reducing emissions, recycling materials and protecting resources, we're helping you look after the future. In addition to the standard BlueEFFICIENCY and ECO start/stop technologies, the B-Class also features one of the best drag coefficients around, making it even more efficient – whatever paint finish you choose. → Page 20, 21

B-Class SE shown with optional bi-xenon headlamps, LED daytime running lights and 17" 7-twin-spoke alloy wheels





> View price list



> View offers



> SOUND WITH POWER



> Mercedes-Benz Magazine





> View price list



> View offers



> SOUND WITH POWER



> Mercedes-Benz Magazine

Everyone loves surprises, but wouldn't you like to know what's around the corner?



B-Class SE shown with optional bi-xenon headlamps, LED daytime running lights and 17" 7-twin-spoke alloy wheels

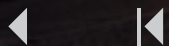



> View price list



> View offers



> SOUND WITH POWER



> Mercedes-Benz Magazine



Brains and beauty

B-Class SE shown with optional bi-xenon headlamps and LED daytime running lights





> View price list



> View offers



> SOUND WITH POWER



> Mercedes-Benz Magazine

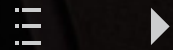



> View price list



> View offers



> SOUND WITH POWER



> Mercedes-Benz Magazine



Wherever life takes you, with the B-Class you're travelling in style. Choose the B-Class SE for comprehensive standard equipment including leather steering wheel, chrome styling and Active Park Assist. The B-Class Sport stays true to its name with features such as 18" bi-colour alloy wheels, lowered comfort suspension, Direct Steering, bi-xenon headlamps and privacy glass. For further luxuries, the optional Exclusive Package has sumptuous leather and wood trim. Whether you prefer stylish chrome details throughout the cabin, heat-insulating privacy glass or beautiful ambient lighting, the B-Class' attention to detail creates a unique atmosphere of well-being. → Pages 40–53





> View price list



> View offers



> SOUND WITH POWER



> Mercedes-Benz Magazine

Hitting the wall 700 times over

Crashing and smashing is part of our daily routine in the Mercedes-Benz 'crash hall': we're experts at light collisions, heavy ones, frontal and rear impacts, side and top crashes. This gives us the data for designing the best possible collision protection for our cars. In carefully prepared laboratory tests, our engineers crash prototypes against the wall more than 700 times a year. While crash tests are the more spectacular side of the Daimler safety philosophy, our integrated safety concept

combines many active and passive safety systems so that you can safely master any traffic situation, but especially when anticipating a possible accident and reducing its severity if the worst comes to the worst. For example, Collision Prevention Assist monitors the area in front of the car using radar technology. It can alert the driver in time about potential accidents ahead at speeds of 20 mph and more, allowing a dangerous situation to pass you by without a trace.





> View price list



> View offers



> SOUND WITH POWER



> Mercedes-Benz Magazine

The B-Class in detail

Engines and suspension

- 18 | Mercedes-Benz Intelligent Drive and Mercedes-Benz Connect
- 19 | BlueEFFICIENCY
- 20 | Diesel engines
- 22 | Petrol engines
- 24 | Transmissions
- 25 | Suspension

Safety

- 26 | Integrated safety concept

Comfort

- 30 | Multimedia systems
- 32 | Electronic assistants
- 34 | Versatility
- 36 | Seats
- 37 | Light and Sight Package

Equipment

- 38 | B-Class SE
- 42 | B-Class Sport
- 46 | Exclusive Package
- 48 | Standard equipment
- 49 | Optional extras
- 50 | Alloy wheels
- 52 | Retailer-fit accessories

Services

- 54 | Services

Facts and finishes

- 56 | Dimensions
- 57 | Technical data
- 59 | Paint finishes

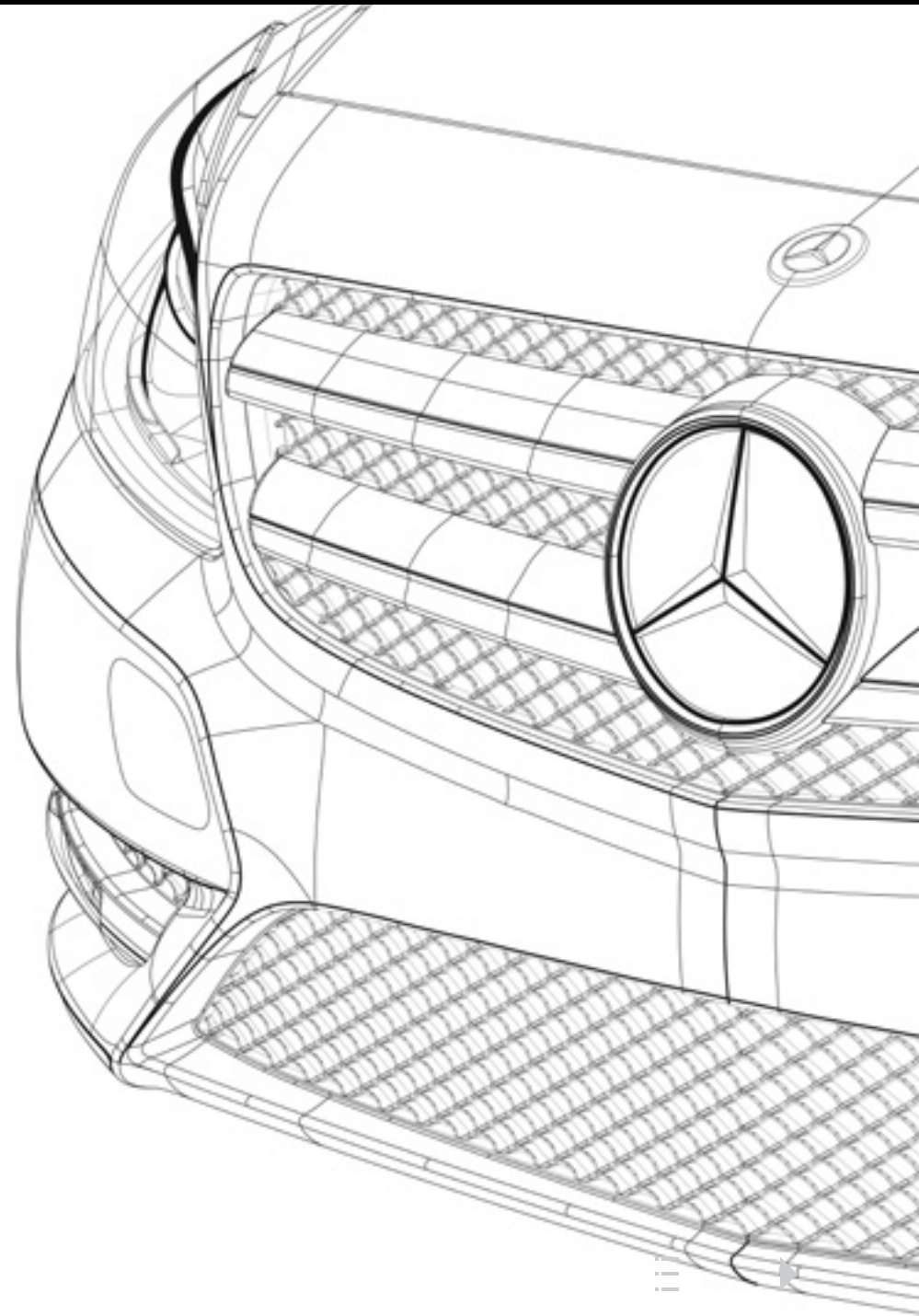



Connected with all the senses

With Mercedes-Benz Intelligent Drive and Mercedes-Benz Connect, we have taught our cars to think. It takes us one step closer to our vision of accident-free driving.

Our engineers live in the future, constantly aiming to turn innovative thinking into everyday solutions. This aspiration has resulted in many developments with a lasting impact on automotive engineering. In other words, our work ensures that a Mercedes-Benz is always ahead of its time.

Innovative technologies such as the Pre-Safe® anticipatory safety system and Distronic Plus radar-assisted cruise control first made it onto the road in a Mercedes-Benz, setting new standards in vehicle safety. It marked the first time active and passive systems were combined – for even better protection and ride comfort. Time and time again we have pioneered solutions to get closer to realising our vision of accident-free driving.

Mercedes-Benz Intelligent Drive takes things a step further by intelligently combining sensors with safety systems and electronic assistants. For us, it's a logical progression as the traffic situation has changed. There are more vehicles on the road, the driver's job is becoming more complex and distractions are increasing.

Radar-assisted Cruise Control with Steering Assist and Stop & Go Pilot marks another important step towards autonomous driving. Steering Assist provides lateral assistance to keep the car in lane. It works with a stereo camera capturing road markings and vehicles driving ahead at low speeds. The system brakes if necessary and accelerates to a preset speed when possible. As a result, your driving comfort is significantly enhanced, especially on long journeys or in slow-moving traffic jams.

Mercedes-Benz Connect. Serving as a smart interface between car and Internet, Mercedes-Benz Connect offers a whole range of services for your comfort, safety and information. It's an effortless, highly efficient way to keep the driver connected with the digital world when on the move. The system can be paired with COMAND Online, live traffic information, the Mercedes-Benz Emergency Call System and with many individual Mercedes-Benz apps. While your car remembers your preferences and adapts accordingly, it can even advise you to take specific actions and interact with your social networks. Mercedes-Benz Connect turns our vision of seamlessly connected mobility into reality. In the future, the way we drive will change dramatically, making it more comfortable, more efficient and safer as a result.

A Mercedes-Benz can monitor the road situation, alert you to possible dangers, and if necessary, act independently. Our cars are becoming increasingly intelligent, too. That is why a Mercedes-Benz takes you beyond a specific destination – it takes you straight to the future.



BlueEFFICIENCY – fast forward to tomorrow

Mercedes-Benz is quicker at getting future technologies to where they matter most: on the road. With ever more efficient vehicles and a production process that wastes fewer and fewer resources. We call this comprehensive approach BlueEFFICIENCY. By way of example, BlueTEC technology for the diesel engine reduces nitrogen oxide

emissions by up to 90%. Our Hybrid models featuring an intelligent combination of internal combustion engine and electric drive can reduce fuel consumption significantly, while the SLS AMG Coupé Electric Drive takes electric mobility to a new level. Technical and aerodynamic optimisation measures right down to the last detail make

the BlueEFFICIENCY Editions available in selected model series true champions of efficiency. But every B-Class model already boasts a raft of BlueEFFICIENCY features – holistic vehicle optimisation measures that are adapted specifically for this model series.



BlueEFFICIENCY covers a range of measures:

- 1 Energy-saving ancillaries
- 2 Adjustable radiator shutters and intelligent oil pump management
- 3 Highly efficient generator
- 4 Engines with petrol direct injection; optimised diesel engines
- 5 Air-conditioning compressor feature
- 6 Enhanced aerodynamics. Improvement by 13% compared to previous model (drag coefficient 0.26)
- 7 ECO start/stop function
- 8 Driver information to encourage fuel-efficient driving
- 9 EU5 emissions standard across the range
- 10 Tyres designed for lower rolling resistance
- 11 7G-DCT 7-speed dual-clutch automatic transmission (optional)





Diesel engines

Cleaner, more efficient, more powerful: The B-Class is a showpiece for Mercedes-Benz diesel technology. The engines are quiet yet bursting with energy, offering low fuel consumption and reduced emission levels.

4-cylinder engines. The 4-cylinder diesel engine offers a torque performance and an impressive response even at a low engine speed, while also ensuring improved fuel efficiency and reduced CO₂ emissions.

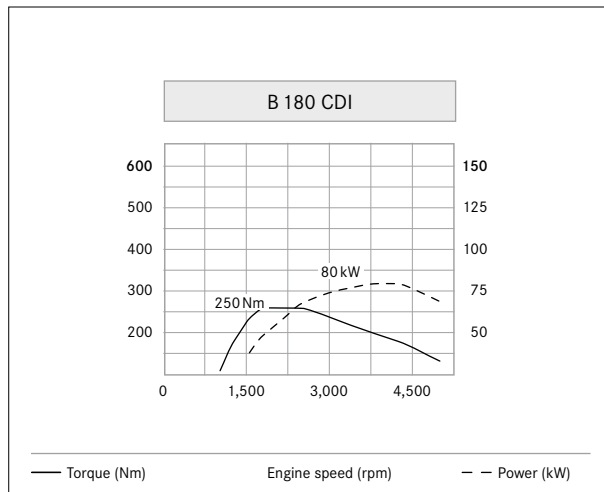

The B180 CDI engine reaches maximum torque between 1,400 and 2,800 rpm

Noise and vibration levels have also been significantly reduced. The key to this impressive set of achievements is a combination of advanced technologies. The engines' fourth-generation common-rail system boasts ultraprecise magnet valve injectors, increased pressures of 1,800 bar and further optimised combustion chambers. The higher ignition pressure and turbocharging mean high levels of torque are available at any engine speed.

A whole range of measures helps to further increase overall vehicle efficiency of the B-Class. These include tyres with lower rolling resistance, improved aerodynamics and intelligent ancillary unit management. In addition, the current engine generation boasts impressive performance and high levels of torque whilst keeping fuel consumption and CO₂ emissions low.

But that's not all: the standard ECO start/stop function automatically switches off the engine at traffic lights or in a traffic jam. The standard ECO display keeps the driver informed about efficiency and encourages an economic driving style. All diesel engines meet the EU standard for exhaust emissions.

There are three 4-cylinder diesel engines to choose from:

- B 180 CDI ECO/B 180 CDI - 109 hp (80 kW) with 250 Nm max. torque
- B 200 CDI - 136 hp (100 kW) with 300 Nm max. torque
- B 220 CDI - 168 hp (125 kW) with 350 Nm max. torque

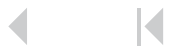



> View price list



> View offers



> SOUND WITH POWER



> Mercedes-Benz Magazine

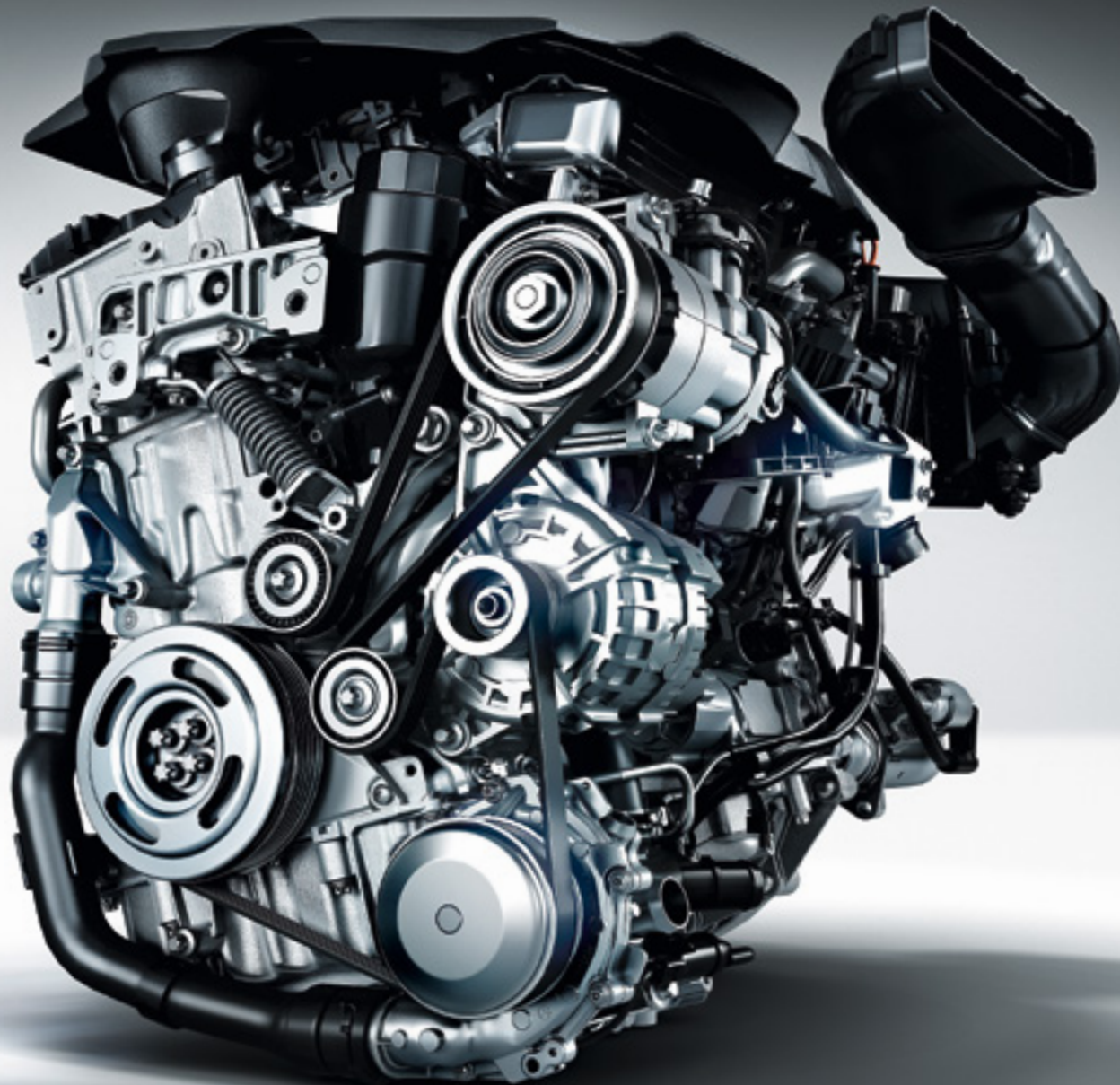

The 4-cylinder B180 CDI diesel engine combines high levels of torque with low fuel consumption and reduced emissions





Petrol engines

The petrol engines deliver on all fronts, boasting significantly lower fuel consumption and reduced CO₂ emissions, with performance continuing to be impressive.

4-cylinder engines. Direct petrol injection, variable valve control and turbocharging help these petrol engines to deliver high levels of power and torque along with low fuel consumption and emissions.

For higher combustion efficiency and performance which, in turn, guarantees lower fuel consumption, the refined combustion system works with direct petrol injection and highly precise piezo injectors. Variable camshaft control ensures precisely the right amount of fuel is used for any given situation. Weight-savings and lower internal friction also help to further reduce fuel consumption.

The petrol engines also benefit from BlueEFFICIENCY measures to reduce the warming up phase, intelligent oil pump management and a highly efficient generator.

There are two 4-cylinder variants available:

- B 180 with 122 hp (90 kW) with 200 Nm max. torque
- B 220 4MATIC with 184 hp (135 kW) with 350 Nm max. torque

The 4-cylinder B-Class petrol engines meet the current EU6 emissions standard.

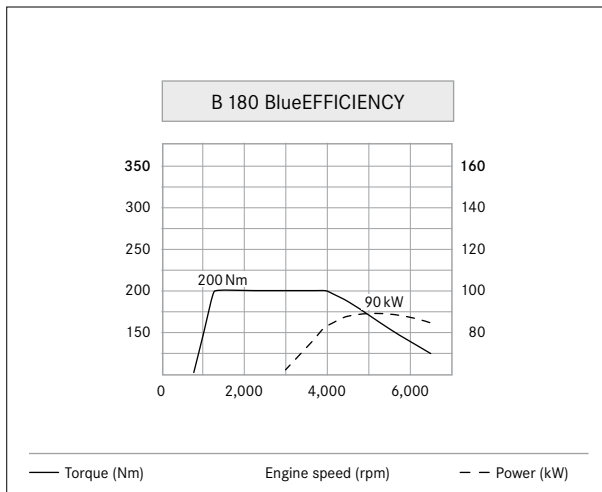

The B 180 offers 200 Nm maximum torque between 1,250 and 4,000 rpm





> View price list



> View offers



> SOUND WITH POWER



> Mercedes-Benz Magazine



The B180 4-cylinder petrol engine features direct injection with piezo injectors and turbocharging





Transmissions

Whether you choose the 6-speed manual or the 7G-DCT 7-speed dual-clutch automatic, both transmissions are tailor-made to suit the B-Class' individual engines with optimised weight and excellent levels of performance and drive comfort.

6-speed manual transmission (standard). All engines come with our 6-speed manual transmission combined with ECO start/stop function as standard. The 6-speed manual transmission benefits from short, precise shift throws while the transmission ratios are ideally matched to the engine and the final drive ratio. The ECO start/stop function temporarily switches the engine off when the car is coming to a standstill, for example, at a red traffic light, or when in a traffic jam. It restarts as soon as you touch the accelerator or depress the clutch. Additionally, a shift point indicator and current fuel consumption display helps you to drive more efficiently.

7G-DCT 7-speed dual-clutch automatic transmission (optional). The dual-clutch transmission achieves a unique combination of comfort, sportiness and efficiency. It consists of two part-transmissions, each featuring its own clutch. One is responsible for the 'even' gears, the other takes care of the 'odd' ones. During acceleration or braking, the transmission that is currently not in use will preset the next higher or lower gear. When changing gear, the system switches to the currently inactive transmission. As a result, gear changes are delivered faster without loss of throttle. Both clutch and gear changes are fully automatic to ensure significantly smooth gear shifts. The driver can choose between 'Economy', 'Sport' and 'Manual' modes to suit their individual driving style. The 'Sport' mode, for example, will choose a higher gear at higher revs than in 'Economy' mode, and lower gears are activated sooner. For an even sportier driving style, drivers can shift gears via the 'Manual' mode, or use the steering wheel shift paddles.

For greater efficiency, the transmission also features ECO start/stop function. Additionally, an ergonomic Direct Select gear shift lever and cruise control with Speedtronic variable speed limiter are also standard on the 7G-DCT 7-speed dual-clutch automatic transmission.



Comfortable gear shifts without throttle disruption: the 7G-DCT



Suspension

Whatever suits your B-Class model. A suspension system to match.

Suspension and steering. Completely redesigned and optimised, the suspension combining McPherson front axle and four-link front suspension ensure optimum road holding and ride comfort. The standard rack-and-pinion steering system with integrated Steer Control offers precise handling in critical driving situations. For additional comfort and safety, the electro-mechanical power steering decreases at increased speeds.

Lowered comfort suspension with Sports Direct Steering (as part of the B-Class Sport). The lowered comfort suspension with selective dampers combines agility and drive safety with excellent body control. The lowered comfort suspension has a sporty setup for even more direct response, resulting in agile handling and a dynamic driving sensation. The body is additionally lowered by 15 mm.

Sports Direct Steering (as part of the B-Class Sport). Featuring an innovative spur rack, this system blends driver comfort and safety with a sporty edge. Working together with the suspension system, Sports Direct Steering allows a more spontaneous response to steering movements. At lower speeds, in tight corners or, when parking, for example, very little steering effort is required. At higher speeds, straight-line stability is outstanding.

4MATIC. The permanent all-wheel drive system offers fully variable torque distribution between the front and rear axle. This makes for sporty driving characteristics with optimum traction, whatever the driving conditions.

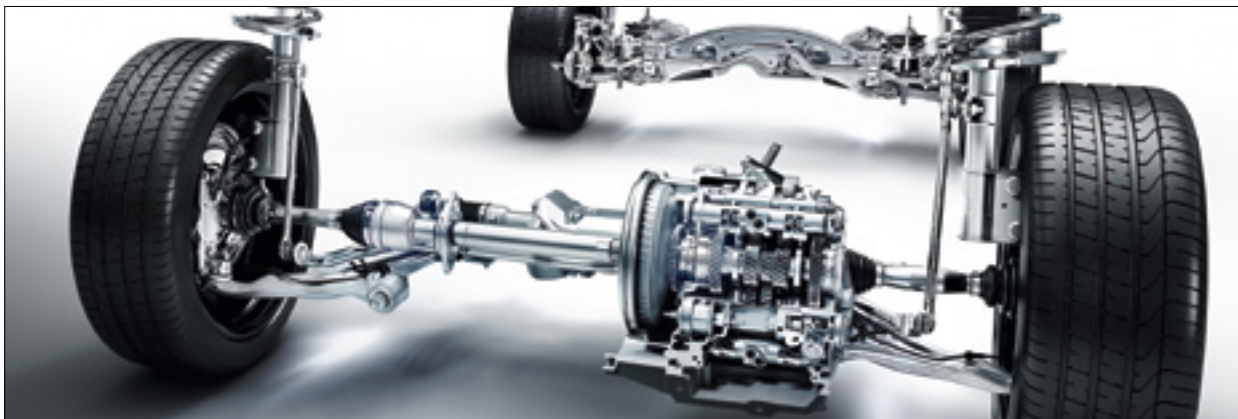



Integrated safety concept

Like all our passenger cars, the B-Class is built according to an integrated safety concept. It ensures the many passive and active protection systems work together to enhance safety in every situation – helping to bring our vision of accident-free driving another step closer.

As the inventor of the motor car, we feel a particular responsibility towards road safety. That's why we were the first manufacturer to develop an integrated safety concept that seamlessly combines a car's active and passive safety features, thus ensuring optimum all-round protection. This concept covers four different areas – safer driving, anticipating danger, protecting occupants and post-crash safety – and incorporates measures designed to maximise safety in every situation, by helping you to stay safe, alerting you to danger, and assisting you wherever possible. In addition, our unique Pre-Safe® anticipatory safety system recognises likely accident scenarios and takes steps that help to further enhance occupant protection. If a collision can't be avoided, intelligent passive safety systems help to provide protection where it's needed, while solutions that can minimise the consequences of an accident and facilitate emergency assistance are also a key part of this safety concept. A selection of these technologies for the phases 'safer driving', 'anticipating danger', 'protecting occupants' and 'post-crash safety' are presented on the following pages.

Safer driving: Attention Assist (standard). If it detects signs of tiredness, Attention Assist alerts the driver via visual and acoustic warnings and recommends taking a break. It monitors driver behaviour via an array of sensors and registers unexpected changes that may indicate drowsiness or concentration lapses.

Safer driving: Adaptive Brake (standard). In conjunction with anti-lock braking system (ABS), this modular driving dynamics system helps improve traction and drive comfort, enhancing the B-Class' safety performance in critical driving situations. It includes automatic brake drying for driving in wet conditions, ensuring a faster reaction to the pedal and thus a shorter stopping distance. By priming the brakes, the system automatically moves the brake pads into surface contact with the brake discs when the driver suddenly takes the foot off the accelerator. This enables the brakes to engage fully and firmly in less time. During hill starts, the system helps prevent unintentional rolling backwards when switching from brake pedal to accelerator. Additionally, the hold function, activated by pressing the pedal twice, holds the car stationary, even if the driver takes the foot off the brake pedal.



Attention Assist recommends a break when the system detects tiredness or a lack of concentration



Safer driving: Distronic Plus (optional). Distronic Plus radar-assisted cruise control helps you to maintain the required distance from the vehicle in front. The system works between standstill and 124 mph and for distances between 8 inches and 200 yards, applying the brakes automatically (bringing the car to a standstill if necessary) and accelerating again once the situation allows. If, however, a collision seems likely, the Collision Prevention Assist Plus (part of Distronic Plus) can initiate a partial braking manoeuvre to avoid a collision or to reduce its impact. Distronic Plus is only available in conjunction with the optional 7-speed dual-clutch 7G-DCT transmission.

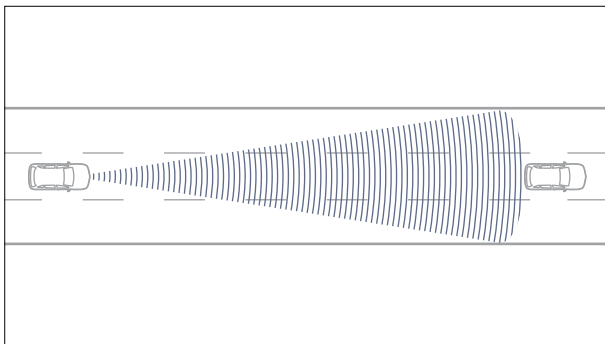

Distronic Plus helps the driver keep the required distance to the car in front

Safer driving: Lane-Tracking Package (optional). Lane-Keeping Assist recognises white road markings and warns you via subtle vibrations of the steering wheel should you unintentionally stray out of lane. Blind Spot Assist, meanwhile, uses twin radar sensors to monitor the hard-to-see areas either side of the rear. In lane changes at speeds of approximately 20 mph or above, the system can detect the presence of another vehicle in your blind spot and alert you to the danger via a symbol in the relevant exterior mirror.

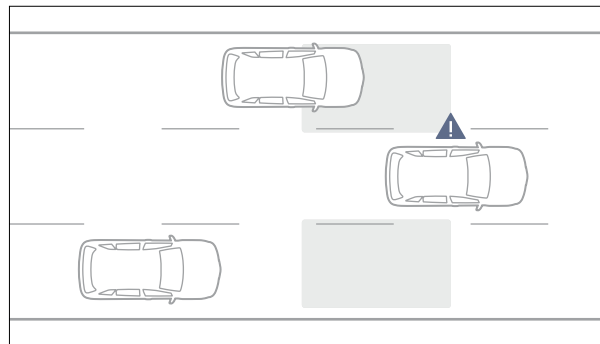

Lane-Keeping Assist/Blind Spot Assist are designed to warn the driver about potentially dangerous situations

Safer driving: Intelligent Light System (optional). The Intelligent Light System comprises a variety of modes and functions that help your visibility at night or in other low-visibility conditions. Country mode and motorway mode adjust the light to suit the road, while the Active Light System enables the beams to follow your steering angle. Also included is Adaptive High Beam Assist, which always provides the maximum headlamp range and dips the headlamps automatically when on high beam, if the lights of an oncoming vehicle are detected. Additionally, the chrome-trimmed LED daytime running lights in the front bumper and LED tail lights, further enhance visibility on the road.

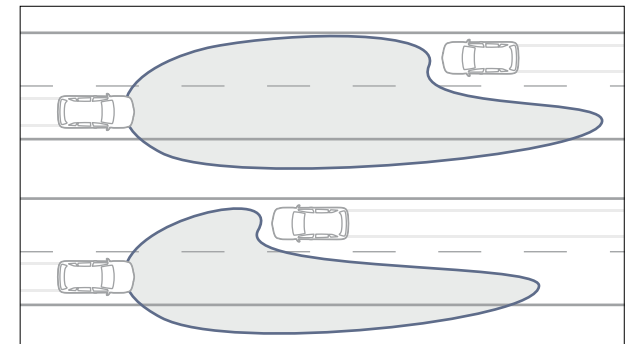

The Intelligent Light System automatically adapts to changing light and driving conditions





Anticipating danger: Collision Prevention Assist

(standard). Collision Prevention Assist can alert the driver if the distance to the vehicle in front decreases with unusual rapidity, thereby helping you to avoid front-end shunts. The radar-assisted warning system works from speeds around 20mph. When the brakes are then applied, the Adaptive Brake Assist function can automatically increase the brake force if necessary, ensuring the available stopping distance is exploited to the full and thereby increasing the chances of avoiding an impact.



Collision Prevention Assist alerts the driver via acoustic and visual warning if the distance to the car in front becomes too low

Anticipating danger: Pre-Safe® system (optional).

If it detects a probable accident scenario, Pre-Safe® anticipatory safety system can take a range of measures to reduce the risk of injury to the occupants. Triggered by events such as emergency braking, these can include activating the front seat belt tensioners and automatically closing the windows and sunroof (if fitted), ensuring maximum protection from airbags and seat belts should an impact then occur.

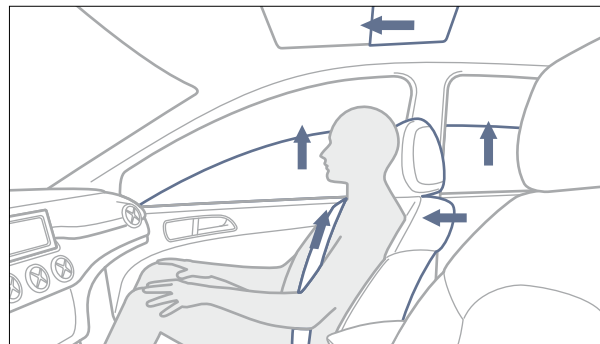

The Pre-Safe® system helps to enhance safety belt and airbag performance

Protecting occupants: restraint systems (standard).

The 3-point seat belts, seat belt tensioners, belt force limiters and airbags are all carefully coordinated so as to keep injuries to a minimum. In addition to the rigid passenger cell, seven standard airbags further reduce the risk of injury: dual-stage front airbags, which are triggered according to the severity of the impact, windowbags, pelvisbags for driver and front passenger, and a driver's side kneebag. Sidebags for rear seat occupants are available as an option. If the crash sensors detect an impact, the seat belts are instantly tensed, helping to ensure the occupants remain firmly in their seats, while the belt force limiter relaxes the belt as the situation allows, in order to prevent undue force being applied to the rib cage.



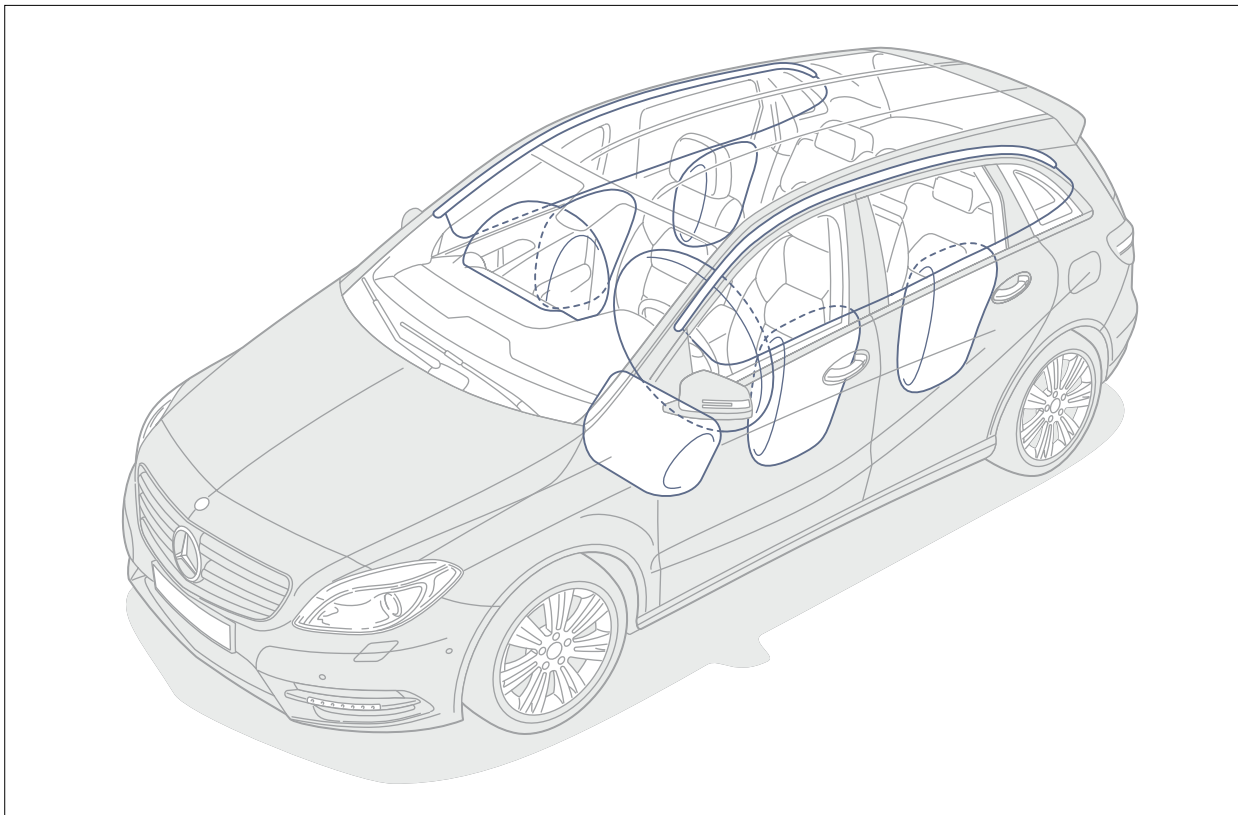

Seven airbags help to significantly reduce the risk of injury in a collision

Post-crash safety: Mercedes-Benz Emergency

Call System (part of optional COMAND Online system). If the restraint system detects a collision, it automatically makes a call to the Mercedes-Benz emergency call centre with the position and data of the car. The centre then makes a voice connection to the car. The emergency call can also be made manually.

Post-crash safety: rescue assistance. Mercedes-Benz has developed a range of measures that help to minimise the secondary consequences of an accident and facilitate occupant rescue. These include automatic engine cut-off, self-activating hazard lights and emergency cabin lighting. In addition, the central locking system is automatically released in the event of an accident, and there are special crash joints between the front doors and wings that make it easier to open the doors after frontal collisions. In addition, Mercedes-Benz provides a rescue guide for emergency services that can be downloaded from the Internet at www.mercedes-benz.co.uk/rescueguide



Multimedia systems

The B-Class offers plenty to keep you entertained: Audio 20 radio/single CD, the optional Becker® Map Pilot navigation system, COMAND Online or Harman Kardon® Logic 7® surround-sound system.



COMAND Online is your all-in-one gateway to audio, navigation and communication featuring a high-resolution 7-inch display

COMAND Online (optional). The system combines hard disk drive (HDD) navigation with a high-resolution 7-inch tablet-design display for 3D map viewing. Multimedia functions include radio, speed-sensitive volume control, music register with 10 GB of storage for audio files, free European map data updates¹ and live traffic information,¹ which provides precise, up-to-date traffic data for improved route planning and more accurately estimated time of arrival. A USB connection, SD memory card slot, Bluetooth® interface for hands-free access and the Media Interface allow connection to external data storage media. The DVD drive can play video and audio DVDs as well as CDs and MP3 files. The online feature allows access to the Internet and Mercedes-Benz apps via an Internet-enabled mobile phone, including Facebook, Internet radio, parking space search, special destination searches via Google Street View or sending routes from Google™ maps to the vehicle, and hotel finder as well as news and weather reports. You can operate the system via the COMAND controller and the multi-function steering wheel, or simply use Linguatronic voice control.

¹Free of charge for the first three years





Audio 20 radio/single CD (standard). The Audio 20 system offers all the key features of a modern in-car entertainment system: radio, CD drive, MP3, WMA and AAC playback, USB port and Bluetooth® interface. It also comes with a 5.8-inch central display and can be further enhanced with options such as a 6-disc CD changer. Whilst all Audio 20 radio/CD functions can be operated via the central controller, the USB port is located in the centre armrest for your convenience. Additionally, six speakers throughout the cabin ensure excellent sound quality.

Media Interface (optional). The improved Media Interface is perfectly matched to mobile audio devices such as Apple iPod®. As the folder structure of the player is copied over to the Interface and the music transferred digitally, tracks can be quickly changed and the titles displayed.

Becker® Map Pilot navigation system (optional). Becker® Map Pilot can be integrated with the Audio 20 radio/CD system's central controller and display, turning it into a fully featured 3D map navigation system. Downloading additional functions and map updates helps you tailor it to your needs. You can operate the system using voice recognition, via the central controller, or from the multi-function steering wheel. The control unit can be quickly secured and connected via a plug-in port in the glove compartment and removed at any time.



The Becker® Map Pilot navigation system shows vital information both via the Audio 20 radio/single CD display, and the multi-function colour display

Harman Kardon® Logic 7® surround sound system (optional). With its 12 high-performance speakers and Logic 7® multi-channel spatial sound technology, this 450-watt surround sound system with 9-channel DSP-amplifier makes every journey a listening experience to remember. Combined with COMAND Online, it also features a Dolby-Digital 5.1 system. Additionally, the system can be adjusted to provide the perfect surround sound for specific areas of your B-Class, for the entire cabin, front, centre or rear area.



Concert-like sound quality is delivered by the Harman Kardon® Logic 7® surround sound system



Electronic assistants

It's not just safety features that premier in the B-Class. There are also plenty of new electronic assistants designed to keep you relaxed and safe.

Reversing camera with parking guidelines (standard on Sport, optional on SE). This rear-mounted wide-angle camera makes for safer and easier parking manoeuvres. Activated automatically as soon as the driver engages reverse, it captures the area immediately behind the car and enables you to see the image on the dashboard's central display (or in the COMAND Online display, if fitted).



The central display shows the area behind the car during a parking manoeuvre

Active Park Assist (standard on SE, optional on Sport). Active Park Assist can assess parallel parking spaces as you drive and, if it finds one that fits, it'll even help you steer the car in. When driving at up to 20 mph, the system will recommend a parking space. Once this is approved by the driver and the car is in reverse, the system parks the car at a touch of a button. All the driver has to do, is apply the clutch, brake and accelerator, the car does the steering for you.



The multifunction display informs the driver about the current parking process

The improved system now works even more precisely: For the automatic parking procedure, the parking space has to be just 1.3 metres longer than the vehicle. And parking in a bend has been optimised. Working with 10 ultrasound sensors, placed at the front and the rear of the vehicle, and a control unit to calculate the best possible parking angle and parking space. The car can even steer automatically out of the space. The driver only has to operate the accelerator and brake pedals and pay attention to the traffic. Leaving the parking space is activated by the button on the steering wheel once the engine has been started and the turning indicator set.



> View price list



> View offers



> SOUND WITH POWER



> Mercedes-Benz Magazine

Speed Limit Assist (fitted with the optional COMAND Online system). This system reads speed limit signs and displays the permitted maximum speed in the car's instrument panel until the limit changes. Its front-mounted camera detects signs mounted above the carriageway as well as those by the side of the road and is particularly useful in areas where the speed limit varies or when passing through roadworks. To help identify the limit correctly, it compares speed limit signs with map data from the navigation system, enabling it to recognise when you are entering or leaving built-up areas, for instance. Speed Limit Assist not only helps the driver stay within the speed limit, it also enhances driving comfort, especially on longer journeys with frequently changing speed limits.



The Speed Limit Assist alerts the driver to the current speed limit





Versatility

Because no day is the same: the rear seats and the load compartment are designed to adjust to your varying needs.

Rear seats. The B-Class greets rear passengers with ample legroom and head restraints for all three rear seats (with the middle one designed to give the driver optimum visibility). The outer seats feature ISOFIX child seat points with top-tether anchorage points. Two integrated child seats for the outer seats with removable head restraints are available as an option.

Load compartment. When you need extra space, the individual sections of the 60:40 split rear seats can be folded to create an almost completely flat loading area measuring 1.57 metres with a luggage capacity of 1,547 litres. If you're using the B-Class as a 5-seater, you'll enjoy 488 litres of luggage space. For added flexibility, the height-adjustable load compartment floor is available as an option. Additionally, the B-Class features bag hooks, four load-securing rings and a load compartment cover to keep your cargo safe from prying eyes.

Easy-Vario-Plus Package (optional). Adapting the B-Class to your requirements couldn't be simpler. Easy-Vario-Plus includes rear seats with fore/aft and tilt-angle adjustment and a folding rear armrest with twin cup holders.

Load Compartment Package (optional, standard with Easy-Vario-Plus Package). It includes a height-adjustable load compartment floor and folding storage. As an additional option, the package is also available with an integral safety net, which can be extended between either the B- or C-pillars depending on the cargo volume, helping to guard against injury from objects in the load compartment.



The B-Class helps you create an almost completely flat luggage area in seconds



Set in the upper position, the optional height-adjustable load compartment reveals a handy storage area

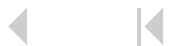



> View price list



> View offers



> SOUND WITH POWER



> Mercedes-Benz Magazine



Comfort 35





Seats and Memory Package

A totally new modular seating system was developed for the B-Class, equally satisfying the requirements of ergonomics, comfort and safety.

Seats. Front and rear passengers enjoy exceptionally comfortable seats and generous levels of leg and shoulder room. The driver also benefits from partial seat height adjustment. The stylish standard 'Domburg' fabric upholstery is available in grey or black. The Sport model features Artico leather¹ upholstery in a choice of stylish colours to suit your individual taste.

Seat Comfort Package (standard). To provide further comfort and individual ergonomic settings, especially for longer journeys, the driver and front passenger seats come with height and seat angle adjustment.

Four-way lumbar support for driver and front passenger (optional). For the best support and comfortable seating positions, the backrest of both driver and front passenger seat can be individually adjusted. Both seats feature air chambers that can be set to your individual requirements for added lumbar support. Additionally, the air chamber height can also be modified.

Memory Package (optional). With the Memory Package, the B-Class driver's and front passenger's seats feature full electric adjustment. The package also includes a memory function that can store up to three sets of positions for the driver's seat, head restraint and exterior mirrors. All settings can be retrieved at the touch of a button. When reversing, the exterior mirror on the passenger side is automatically lowered as well.



The B-Class front seats offer a wealth of options for the most ergonomic and comfortable seating position



The Memory Package with full electric adjustment stores up to three individual seating positions

¹Man-made leather

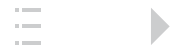
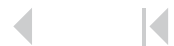



Light and Sight

Light and Sight features multiple benefits: it enhances the ambiance of the beautiful interior and makes driving the B-Class a truly comfortable and reassuring experience.

Light and Sight. These features improve driving conditions and your safety considerably, especially when driving at night or in bad weather. It helps you to see and be seen more clearly. The Light and Sight features include rain-sensing windscreen wipers complete with larger screen-wash container, as well as warning lights on front doors and tailgate. Inside, the illuminated instrument panel, door trim and door handles all form part of the integrated ambient interior lighting, adding to the exclusive, welcoming feel of the B-Class. Whilst the sun visors with vanity mirror,

the rear-view mirror and the front footwells also feature elegant lighting, passengers in the rear can enjoy an ambient uplight and seperately controllable left and right reading lights. Illuminated door sill panels for driver and front-seat passenger doors can be supplied as an addition to Light and Sight.



At night-time, the ambient interior lighting creates a stylish atmosphere on-board the B-Class



The tailgate features a handy warning light illuminating the area around the car



Both front footwells and doors are illuminated for your comfort and safety





B-Class SE

The B-Class SE offers the kind of premium equipment you'd expect from a Mercedes-Benz, combined with plenty of space and versatility. The Light and Sight features and Active Park Assist come as standard, along with an Audio 20 radio/single CD system that includes Bluetooth® interface and USB port, an intuitive controller and a tablet-style central display. It also features innovative electronic assistants such as Collision Prevention Assist and Attention Assist.

Exterior

16" alloy wheels

Heated exterior mirrors in body colour, electrically adjustable, and integral indicator

Light Assist with automatic light activation

Active Park Assist

Round LED daytime running lights

Interior

Air conditioning

Attention Assist

Audio 20 radio/single CD with 5.8-inch screen and USB port

Collision Prevention Assist

Driver's kneebag

Electric parking brake

Matrix-look trim in Black

Multi-functional leather-trimmed steering wheel

Seat Comfort Package



Optional Becker® Map Pilot navigation system shown



Optional rear centre armrest shown





> View price list



> View offers



> SOUND WITH POWER



> Mercedes-Benz Magazine



The B-Class SE, featuring sleek 16" 10-spoke alloy wheels and optional front fog lamps and metallic paint





> View price list



> View offers



> SOUND WITH POWER



> Mercedes-Benz Magazine



Inside the B-Class SE, silver chrome details perfectly set off the tone-on-tone black interior. Domburg fabric upholstery comes as standard as does the Matrix-look trim in Black. The Domburg cloth upholstery is available in either Black or Grey. Artico leather¹ in either Black, Sahara Beige or Crystal Grey is available as an option.

Domburg cloth

011 Black

018 Grey

Artico leather¹

101 Black²

105 Sahara Beige²

108 Crystal Grey²

Trim

H88 Matrix Black

Optional Becker® Map Pilot navigation system shown

¹Man-made leather ²Optional

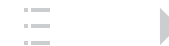



> View price list



> View offers



> SOUND WITH POWER



> Mercedes-Benz Magazine



011

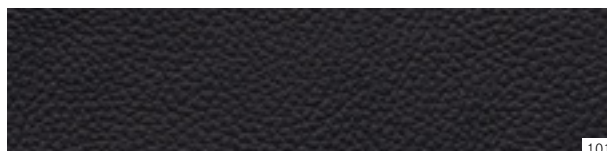

101



018



105

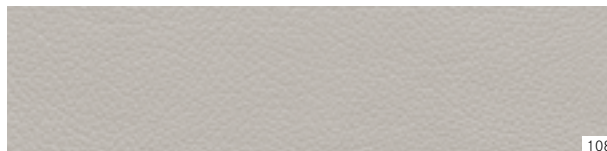

108



H88



H88





B-Class Sport

The B-Class is proud of its sporty credentials. It comes with two-louvre sport grille, 18" bi-colour alloy wheels and heat-insulating dark-tinted glass. And for a truly dynamic drive, the Sport model is equipped with lowered comfort suspension and Sports Direct Steering.



Optional automatic climate control and Becker® Map Pilot navigation system shown

Exterior

18" bi-colour alloy wheels

Bi-xenon headlamps with LED bar daytime running lights

Lowered comfort suspension

Reversing camera

Sports Direct Steering

Two-louvre grille

Visible twin sports tailpipes

Interior

Artico leather¹ upholstery

Privacy glass

Sports pedals with rubber studs

¹Man-made leather



Optional rear centre armrest shown





> View price list



> View offers



> SOUND WITH POWER



> Mercedes-Benz Magazine



The B-Class Sport is fitted with lowered comfort suspension, 18" bi-colour alloy wheels, drilled front brake discs and optional panoramic sliding sunroof





> View price list



> View offers



> SOUND WITH POWER



> Mercedes-Benz Magazine



Inside, the sporty theme continues: the B-Class Sport features brushed stainless steel sports pedals with rubber studs, plus Artico leather¹ upholstery, Silver Honeycomb trim and a black roof lining.

Artico leather¹

- 101 Black
 - 105 Sahara Beige
 - 108 Crystal Grey
-

Trim

- H89 Silver Honeycomb
-

¹Man-made leather



Optional panoramic sliding sunroof, automatic climate control and Becker® Map Pilot navigation system shown



> View price list



> View offers



> SOUND WITH POWER



> Mercedes-Benz Magazine

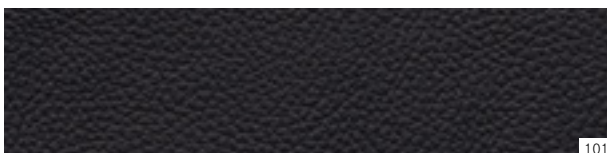

101

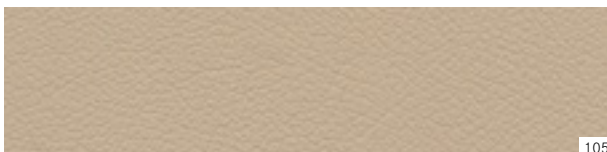

105

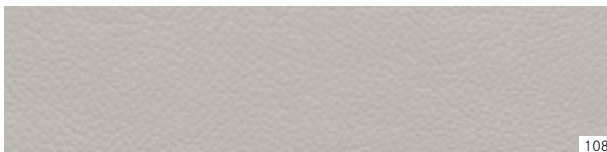

108



H89





Exclusive Package

The optional Exclusive Package is designed for all those who demand a little more luxury. It includes seats with real leather upholstery and four-way lumbar adjustment in the front. There's a choice of three carefully appointed leather options: Lava Black, Hazelnut Brown and Crystal Grey. These colours are repeated throughout on door panels, armrests, and, if you opt for Crystal Grey, also beneath the dashboard and centre console.



201

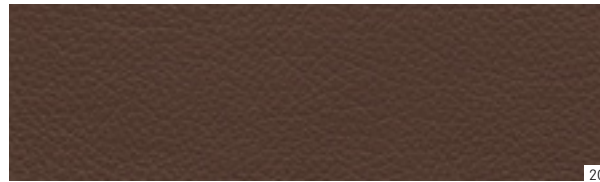

204

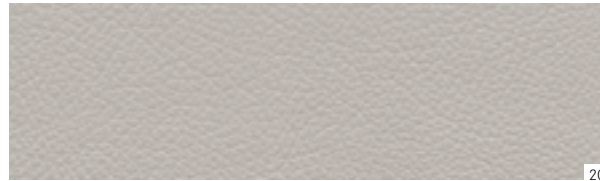

208



736



H03

Chrome elements on dashboard dials and controls as well as on the gear shift lever are perfectly balanced with the chosen interior colour, and set against Lava Black for the remainder of the interior with floor mats in the appointed interior colour. The dashboard is fitted with high gloss Black Ash wood or silk matt Brown Burr Walnut wood interior trim.

Interior

Adjustable centre console armrest with Artico leather¹ and top-stitching

Armrest on door panels with Artico leather¹ and top-stitching

Black Ash wood trim

Black roof lining (Hazelnut Brown upholstery)

Door panels in Artico leather¹ with top-stitching

Electronic locking system with infrared remote control

Floor mats with inset appointed interior colour

Front seats with four-way lumbar adjustment

Grey roof lining (Lava Black, Crystal Grey upholstery)

Heated front seats

Leather-trimmed gear shift/selector lever with silver chrome ring

Leather upholstery with top-stitching

Stainless steel door sills

Storage – covered in black synthetic material

¹Man-made leather

Leather

201 Lava Black

204 Hazelnut Brown

208 Crystal Grey

Trim

736 High gloss Black Ash wood

H03 Silk matt Brown Burr Walnut wood (no-cost option)





> View price list



> View offers



> SOUND WITH POWER



> Mercedes-Benz Magazine



Optional COMAND Online system, automatic climate control, 7G-DCT 7-speed dual-clutch automatic transmission, Harman Kardon® Logic 7® and Memory Package

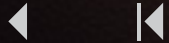



> View price list



> View offers



> SOUND WITH POWER



> Mercedes-Benz Magazine

Standard equipment | Selection



Multi-function steering wheel



Audio 20 radio/single CD



Ambient lighting



Collision Prevention Assist



Air conditioning



Luggage compartment cover





> View price list



> View offers



> SOUND WITH POWER



> Mercedes-Benz Magazine

Optional extras | Selection



Panoramic sliding sunroof



Harman Kardon® Logic 7® surround sound system



Telephone pre-wiring



Becker® Map Pilot navigation system



Automatic climate control - two-zone control with display



Memory Package





> View price list



> View offers



> SOUND WITH POWER



> Mercedes-Benz Magazine

Alloy wheels



Standard on B-Class SE: 16" 10-spoke alloy wheels, tyre size 205/55 R 16 (code 55R)



Standard on B-Class Sport: 18" bi-colour alloy wheels, tyre size 225/40 R 18 (code 01R)





> View price list



> View offers



> SOUND WITH POWER



> Mercedes-Benz Magazine



Optional for B-Class SE: 17" 7-twin-spoke alloy wheels, tyre size 225/45 R17 (code 26R)



Optional for B-Class Sport at no extra cost: 17" 5-spoke alloy wheels, tyre size 225/45 R17 (code R24)





Retailer-fit accessories

Concert hall, sports companion, holiday hold-all: adapting the B-Class exactly to your needs couldn't be simpler. → www.mercedes-benz.co.uk/accessories



Rear seat entertainment system. This elegant system allows rear-seat passengers to watch DVDs, view their favourite pictures and even play video games on two superb 17.8 cm colour screens without disturbing the driver or restricting the rear field of vision. The system's separate DVD players mean that rear-seat passengers have the option of watching a different video source on each screen, allowing each to select their own preferred entertainment. The AV-in connection, USB port and SD card slot allow other storage media to be used too. Supplied with two sets of infrared headphones and a remote control; also available as a single monitor set. Your B-Class does not require any pre-wiring, allowing this system to be fitted at a later stage.

Great entertainment for the rear seats – with two high-resolution LCD colour displays

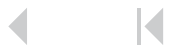



Concertina load sill protection. For scratch-free and comfortable loading, the B-Class can be fitted with a protective mat featuring highly durable nylon. When the load sill protection is not in use, it can be secured with velcro fittings and neatly tidied away on the luggage compartment floor behind the tailgate. For added comfort, the mat can be simply unfolded with one hand.

The rear-mounted bicycle rack. This lockable rear-mounted bicycle rack offers safe and comfortable transport for two or three bikes. Securing the bicycles is effortless, while the rack is easy to attach to the tow bar. A simple fold-down mechanism means that the boot can still be opened. When folded, the rack can be stored in a handy nylon bag.

Roof boxes. These highly durable roof boxes have been aerodynamically designed to suit the B-Class. For easy loading and unloading, they can be opened from both sides. The boxes are available in two sizes: the Family box in metallic Black or matt Silver has a loading capacity of 450 litres, whilst the Sport Box in metallic Titan or matt Silver offers 330 litres.



The load sill protection prevents scratches when loading and unloading



The rear-mounted and folding bicycle rack is available for two or three bikes



The roof boxes are available in two colours, offering a loading capacity of 330 litres or 450 litres





Services

Test drive. You've seen the pictures, you've read the facts. Now all that's missing is to experience your dream Mercedes in the flesh. Which is why we invite you to take it for a spin. See it with your own eyes. Rev up the engine, and feel how your chosen Mercedes hugs the road. Relax in style or play with a whole host of exciting onboard technology. Contact your Mercedes-Benz Retailer for a test drive, or simply go online and visit www.mercedes-benz.co.uk/testdrive. We can't wait to see you in the driving seat.

Mercedes-Benz Finance. At Mercedes-Benz Finance, our single-minded aim is to provide optimum financial solutions for all those who share the Mercedes-Benz philosophy of absolute commitment to quality. Whether you are a private customer or a business user, our finance and leasing packages can be tailored to meet your individual needs. For further information on Mercedes-Benz Finance, please contact your local Mercedes-Benz Retailer.



Mercedes-Benz Insurance offers a fully comprehensive 5-star-rated¹ Motor Insurance policy specifically designed to provide the cover you would expect from Mercedes-Benz. For a quotation, please call 0845 600 2180²

Interactive Owner's Manual. The website also offers an interactive tour, enabling you to take a closer look at your desired model. This simulation is the ideal way to acquaint yourself with your dream car. You can view key functions in detail, gain an insight into the car's inner workings or look at the benefits of each model. For further details, visit www.mercedes-benz.co.uk/bclassmanual



Roadside Assistance and Accident Management. Rest assured that should you ever need help, Mercedes-Benz Roadside Assistance is there for you. In the unlikely event of a technical breakdown³ you can rely on the Mercedes-Benz Roadside Assistance Team – anywhere in Europe. Mercedes-Benz will also assist you in the unfortunate event of an accident, from recovering your car and delivering it to your preferred Mercedes-Benz Retailer right through to managing your insurance claim in full, you will be looked after by the experts who built your Mercedes-Benz.⁴ Minor mishaps are also covered. Whether you lose your key, run out of fuel, or your vehicle is damaged due to vandalism, Mercedes-Benz ensures that you still reach your destination. Often the problem can be rectified on the spot, but if this is not possible, we will naturally ensure that your vehicle is taken to the nearest Mercedes-Benz Retailer to get you back on the road as quickly as possible.

¹As rated by Defaqto, a leading UK independent financial research company
²Mercedes-Benz Motor Insurance is underwritten by Aviva Insurance Limited. For joint protection, calls may be recorded and/or monitored. All calls are charged at local rate. We may decline to quote in some circumstances

Simply phone our Customer Assistance Centre on 00800 1 777 7777,⁵ where our specialists will organise assistance for you.

Service Care. To keep a tight grip on costs, Mercedes-Benz offers service plans to cover the costs of an annual service, for two, three and four years. Plans can be paid monthly with interest-free instalments or alternatively, if you pay upfront, should you sell your vehicle any remaining services will be transferred to the new owner. All routine maintenance and additional items are covered. To find out more, please contact your local Retailer or visit www.mercedes-benz.co.uk/servicecare

³Cover is initially valid for your vehicle for four years from the date of first registration. This can be extended from the fifth year, up to a maximum of 30 years, on completion of each scheduled maintenance service, providing that this service is carried out by a Mercedes-Benz Retailer. Minor mishap cover is provided at the absolute discretion of Mercedes-Benz

Mercedes-Benz World at Brooklands. Discover Mercedes-Benz racing heritage, from its connections to the famous Brooklands circuit through to present-day Formula 1™ brought to life in the most sensational way at Mercedes-Benz World in Surrey. View, touch and sit in every car from the Mercedes-Benz range, and encounter automotive legends like the ‘Gullwing’ and many other classic icons, in the UK’s largest Mercedes-Benz showcase. Then set your pulse racing by booking one of our thrilling AMG or 4×4 Driving Experiences. Relax and refuel in Café 1886, or enjoy the delicious menu and elegant surroundings of the Gullwing Bistro. For more information, visit www.mercedes-benzworld.co.uk

⁴Management of claims for non-fault accidents only
⁵In non-affiliated European countries: +44 20 7975 7077





Dimensions

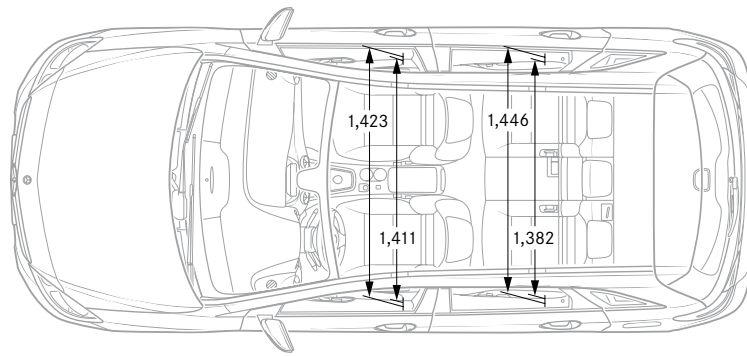
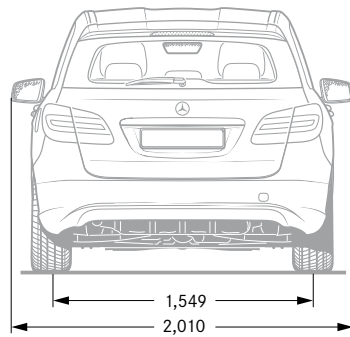
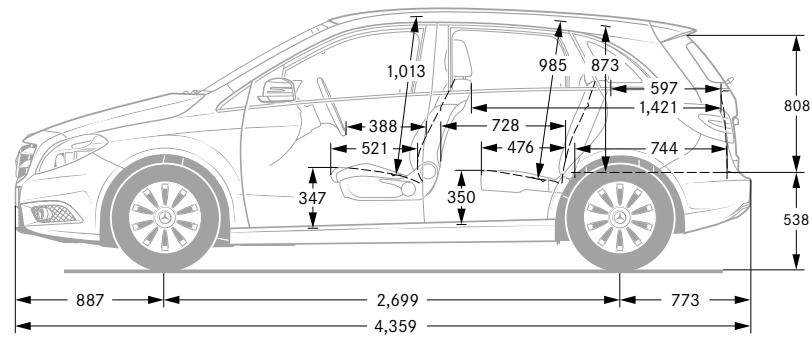
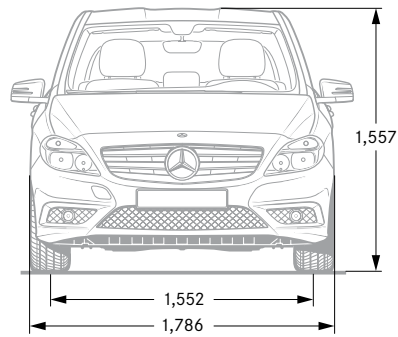

All measurements in millimetres. The dimensions shown are mean values and apply to standard-specification, unladen vehicles





Technical data

	Diesel engines			
	B 180 CDI ECO	B 180 CDI (7G-DCT)	B 200 CDI	B 220 CDI
Arrangement/cylinders/valves	In-line/4/8	In-line/4/8	In-line/4/16	In-line/4/16
Total displacement – cc	1,461	1,461	1,796	2,143
Power ¹ – hp (kW) at rpm	109 (80)/4,000	109 (80)/4,000	136 (100)/3,600–4,400	168 (125)/3,400–4,000
Torque ¹ – Nm at rpm	260/1,750–2,500	260/1,750–2,500	300/1,600–3,000	350/1,400–3,400
Acceleration 0–62 mph – sec (auto.)	11.6	11.6 (11.9)	9.5 (9.3)	– (8.3)
Top speed, approx. – mph (auto.)	118	118 (118)	130 (130)	– (137)
Tyre size	205/55 R 16	205/55 R 16	205/55 R 16	225/40 R 18
Fuel consumption ² – mpg (auto.)				
Urban	64.2	54.3 (57.7)	52.3 (57.7)	– (50.4)
Extra-urban	83.1	68.9 (76.4)	74.3 (72.4)	– (70.6)
Combined	74.3	62.8 (68.9)	64.2 (67.3)	– (61.4)
EU emissions standard	EU5	EU5	EU5	EU6
CO ₂ emissions, combined ² – g/km (auto.)	98	113–117 (107–115)	114–121 (112–120)	– (117–120)
Fuel tank capacity/reserve (approx.) – l	40/6.0	50/6.0	50/6.0	50/6.0
Boot capacity – l	488–1,547	488–1,547	488–1,547	488–1,547
Turning circle – m	11.00	11.00	11.00	11.00
Kerb weight ³ – kg (auto.)	1,425	1,435 (1,505)	1,475 (1,505)	– (1,500)
Perm. GVW – kg (auto.)	1,900	2,000 (2,000)	2,030 (2,025)	– (2,020)
Permissible towing capacity – kg unbraked/braked (auto.)	–/–	715/1,200 (730/1,200)	735/1,500 (750/1,500)	– (750/1,500)

¹Figures according to Directive 80/1269/EEC in the currently applicable version. ²The figures shown were obtained in accordance with the prescribed measuring process (Regulation [EC] 715/2007 in the currently applicable version). The figures are not based on an individual model and do not constitute part of the product offer; they are provided solely for purposes of comparison between different vehicle models.

³Figures according to Directive 92/21/EC, version 95/48/EC (kerb weight with fuel tank 90% full, driver, 68 kg, and luggage, 7 kg) for standard-specification vehicles. Optional extras and accessories will generally increase this figure and reduce the payload capacity accordingly.





	Petrol engines	
	B 180	B 220 4MATIC
Arrangement/cylinders/valves	In-line/4/16	In-line/4/16
Total displacement – cc	1,595	1,991
Rated output ¹ – hp (kW) at rpm	122 (90)/5,000	184 (135)/5,500
Rated torque ¹ – Nm at rpm	200/1,250–4,000	350/1,400–4,000
Acceleration 0–62 mph – sec (auto.)	10.4 (10.2)	– (7.5)
Top speed, approx. – mph (auto.)	118 (118)	– (140)
Tyre size	205/55 R 16	225/40 R 18
Fuel consumption ² – mpg (auto.)		
Urban	35.3 (37.2)	– (33.6)
Extra-urban	60.1 (58.9)	– (49.6)
Combined	47.9 (48.7)	– (42.2)
EU emissions standard	EU6	EU6
CO ₂ emissions, combined ² – g/km (auto.)	137–144 (135–139)	– (156)
Fuel tank capacity/reserve (approx.) – l	50/6.0	56/6.0
Boot capacity – l	488–1,547	488–1,547
Turning circle – m	11.00	11.00
Kerb weight ³ – kg (auto.)	1,395 (1,425)	– (1,530)
Perm. GVW – kg (auto.)	1,960 (1,950)	– (2,055)
Permissible towing capacity – kg braked/unbraked (auto.)	695/1,200 (710/1,200)	– (750/1,500)

¹Figures according to Directive 80/1269/EEC in the currently applicable version. ²The figures shown were obtained in accordance with the prescribed measuring process (Regulation [EC] 715/2007 in the currently applicable version). The figures are not based on an individual model and do not constitute part of the product offer; they are provided solely for purposes of comparison between different vehicle models.

³Figures according to Directive 92/21/EC, version 95/48/EC (kerb weight with fuel tank 90% full, driver, 68 kg, and luggage, 7 kg) for standard-specification vehicles. Optional extras and accessories will generally increase this figure and reduce the payload capacity accordingly.





Paint finishes

The highly durable nature of the Mercedes-Benz paint system makes it one of the best clear coats available in the automotive industry. A highly dense molecular structure provides the key to the extremely resilient paint, regardless whether it's non-metallic or metallic, giving the surface a longer lasting, more intense shine.

Non-metallic paints



589



650

Metallic paints

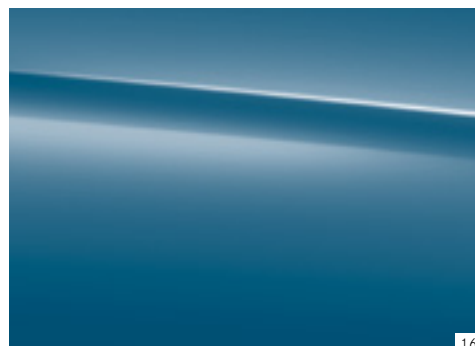

162

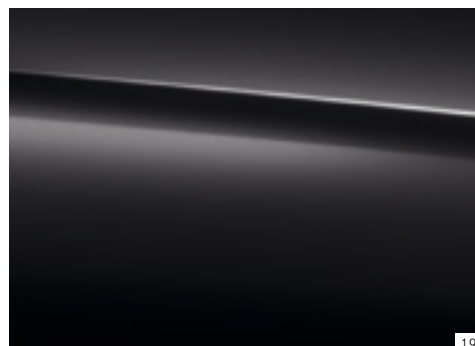

191



761

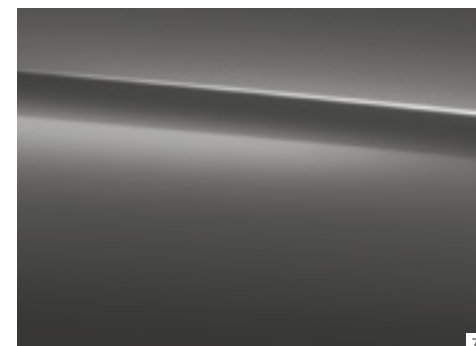

787

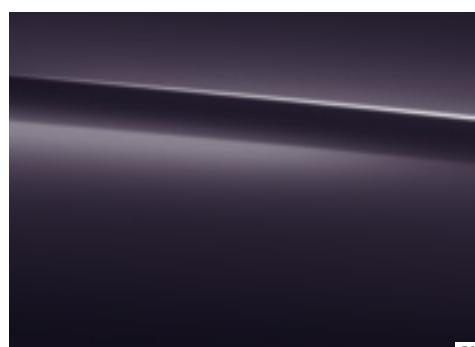

592

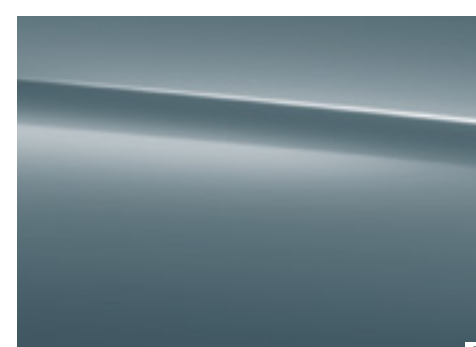

894

Non-metallic paints (standard)

- 589 Jupiter Red
- 650 Cirrus White

Metallic paints (optional)

- 162 South Seas Blue
- 191 Cosmos Black
- 592 Northern Lights Violet
- 761 Polar Silver
- 787 Mountain Grey
- 894 Universe Blue





> View price list



> View offers



> SOUND WITH POWER



> Mercedes-Benz Magazine

Take-back of end-of-life vehicles. Coming full circle. At the end of its long life, you can return your B-Class to us for environment-friendly disposal in accordance with the EC End-of-Life Vehicle Directive! But that day lies a long way off.

¹Applies in accordance with national regulations to vehicles up to 3.5 t permissible gross weight. The B-Class has met the statutory regulations governing the suitability of the vehicles' design for reuse and recycling for a number of years now. A network of vehicle take-back depots and dismantlers has been established which will process your vehicle in an environment-friendly manner. The ways in which both vehicles and parts can be recovered are subject to ongoing development and improvement. Consequently, the B-Class will be able to comply with any future increases in the recycling quota within the stipulated time limits. For further information, please go to www.mercedes-benz.co.uk or call 0808 156 6606.

Please note: this online version of the printed brochure may contain abridged copy or other content changes. The manufacturer reserves the right to make changes to the design, form, colour and specification during the delivery period, provided these changes, while taking into account the interests of the vendor, can be deemed reasonable with respect to the purchaser. Where the vendor or the manufacturer uses symbols or numbers to describe an order or the subject of an order, no rights may be derived solely from these. The illustrations may show accessories and items of optional equipment which are not part of standard specification. Colours may differ slightly from those shown in the brochure, owing to the limitations of the printing process. This brochure has been compiled by Daimler AG of Germany and is distributed internationally. It provides a general indication of the range of models, features, optional extras and/or colours available in various countries. Some of the models, features, optional extras and/or colours shown may not be available in your country or may only be available in a different specification. Additionally some models, features, optional extras and/or colours may only be available in combination with others. For current and more specific information in relation to the range of models, features, optional extras and/or colours available in your country, and their pricing, you should contact your nearest authorised Mercedes-Benz Retailer. E&OE. www.mercedes-benz.co.uk

