



[View price list](#)



[View offers](#)



[SOUND WITH POWER](#)



[Mercedes-Benz Magazine](#)

CL-Class



Mercedes-Benz





> View price list



> View offers



> SOUND WITH POWER



> Mercedes-Benz Magazine



First impressions

The CL is not only a byword for elegance and luxury, it's also a technical tour de force. The V8 engines with BlueDIRECT injection, for instance, set a benchmark for efficient performance, while the many sensors and intelligent electronic systems ensure the CL is safer and more effortless than ever.

What's more, the CL is a car of breathtaking beauty, a car whose lines stir the soul of even the most discerning. And whose every detail is designed and engineered to perfection. It's the state of the art in excellence.

[Overview](#) | [from page 4](#) [Insights](#) | [from page 13](#)

Featured models:

CL 500 | Palladium Silver metallic paint |

[front cover and page 2](#)

AMG alloy wheels in 5-spoke design with high-sheen finish, Exclusive Passion leather in Black, Light Burr Walnut wood trim

CL 500 | Cornetite Blue metallic paint | page 9

AMG alloy wheels in 5-twin-spoke design, Exclusive Passion leather in Sahara Beige/Black, Brown Poplar wood trim

CL 63 AMG | Iridium Silver metallic paint | page 11

AMG alloy wheels in 5-triple-spoke design, Exclusive Passion leather in Black, AMG carbon-fibre trim

Specifications shown may include optional equipment and accessories

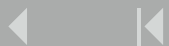



> View price list



> View offers



> SOUND WITH POWER



> Mercedes-Benz Magazine

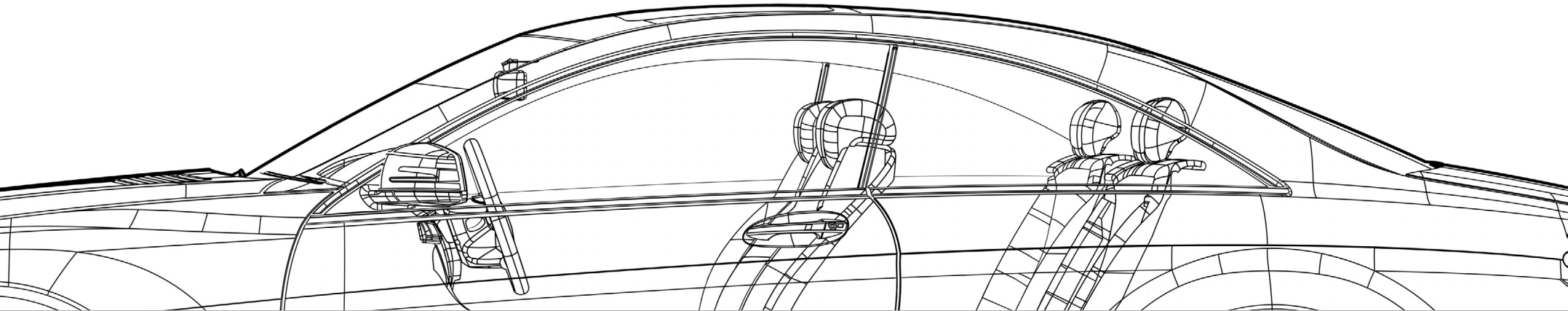

Facts

Efficiency and enjoyment: Mercedes-Benz Intelligent Drive, Efficiency in the CL, engines, transmissions and suspension.

Engines and suspension | from page 16

Integrated safety in the CL-Class: safer driving, anticipating danger, protecting occupants and post-crash safety.

Safety | from page 24

Relaxation for the road: multimedia systems, electronic assistants, climate control and dynamic multi-contour seats.

Comfort | from page 28

A breathtaking coupé: CL 500.

CL 500 | from page 34

Powerful AMG models: CL 63 AMG, CL63 AMG technology and CL 65 AMG.

AMG | from page 36

Your personal CL: standard equipment and optional extras, *designo*, upholstery and trim, alloy wheels and Retailer-fit accessories.

Equipment | from page 42

More Mercedes-Benz: test drive, Mercedes-Benz Finance and Insurance, Interactive Owner's Manual, Roadside Assistance and Accident Management, Service Care and Mercedes-Benz World.

Services | from page 54

CL in figures: dimensions, paint finishes and technical data.

Facts and finishes | from page 56

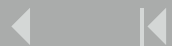



> View price list



> View offers



> SOUND WITH POWER



> Mercedes-Benz Magazine



The synthesis of vision and perfectionism:

Over the years, we've built a succession of truly special coupés. The CL is the latest in that illustrious line. It reflects the boldest and brightest ideas of our designers and engineers – and takes automotive evolution to the next level. It could just be the coupé of your dreams.

greatness





> View price list



> View offers



> SOUND WITH POWER



> Mercedes-Benz Magazine

The only way to travel
for those who've already arrived:

Created for drivers who appreciate elegance, recognise ability and always expect the best, the CL combines fine craftsmanship and design with cutting-edge technology. The result is a truly unforgettable luxury coupé – a car built to standards that match your own.

in style

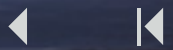



> View price list



> View offers



> SOUND WITH POWER



> Mercedes-Benz Magazine

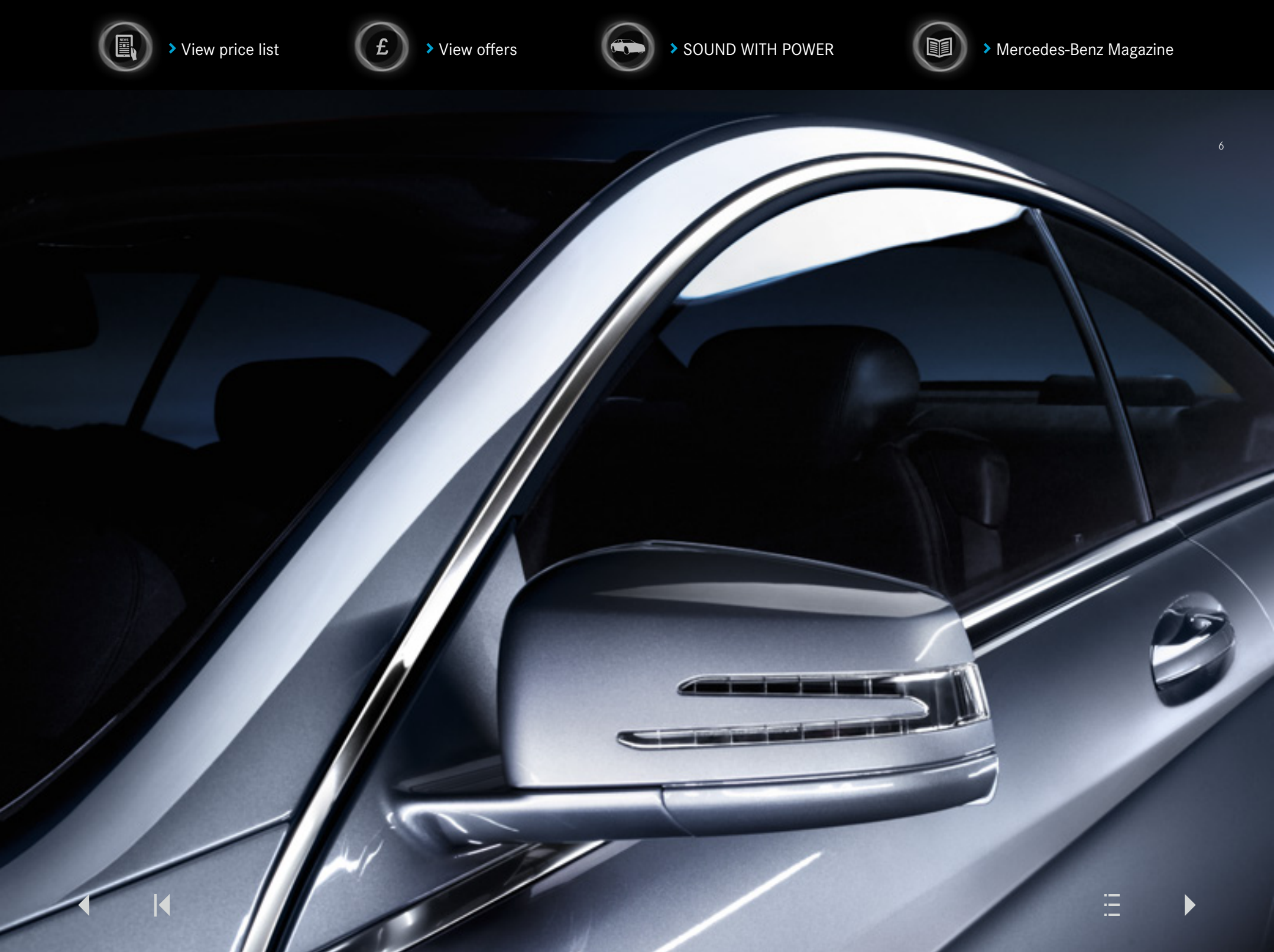



> View price list



> View offers



> SOUND WITH POWER



> Mercedes-Benz Magazine





> View price list



> View offers



> SOUND WITH POWER



> Mercedes-Benz Magazine

**The ability to combine
boldness with respect:**

Only the truly committed have what it takes to stay at the top. The CL, for instance, never wavers in its pursuit of improvements – be they in comfort, safety, or efficiency. It's a dedication that has helped to reduce CO₂ emissions by up to 21% (CL 500). Proof that luxury doesn't have to be characterised by excess.

leadership





> View price list



> View offers



> SOUND WITH POWER



> Mercedes-Benz Magazine

The motivation for countless innovations:

While you're revelling in the here and now, the CL is already considering what might happen next – thanks to electronic safety aids that constantly think a few seconds ahead. What's more, the optional Driving Assistance Package now includes Active Lane-Keeping Assist and Active Blind Spot Assist that work in conjunction with ESP®, meaning they're not only able to help warn the driver of potentially dangerous situations, but also to intervene themselves if required. It is also keeping an eye on you with its Attention Assist – it follows your reactions at the wheel and can suggest taking a break as soon as it notices any signs of fatigue.

your safety

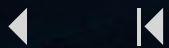



> View price list



> View offers



> SOUND WITH POWER



> Mercedes-Benz Magazine



The only word that
does it justice:

Elegant, athletic and beautifully proportioned, the CL looks almost too good to be true. From the long, sweeping bonnet and striking two-bar grille to the broader, more muscular rear, it's a shape that effortlessly cleaves the air and instantly captures the heart.

masterpiece





> View price list



> View offers



> SOUND WITH POWER



> Mercedes-Benz Magazine



**A composure
nothing can disturb:**

Sharp bends, rough surfaces, gusting winds: the CL simply takes everything in its stride. Thanks to Active Body Control (ABC) with crosswind stabilisation, it maintains maximum stability whatever the road, load or conditions, ensuring occupants enjoy a beautifully smooth ride at all times.

serenity





> View price list



> View offers



> SOUND WITH POWER



> Mercedes-Benz Magazine

**Power you can sense
even at a standstill:**

The striking lines promise passion and power, the driving experience never fails to deliver. Exhilarating performance, effortless poise: the CL takes your breath away – long before you set off.

athleticism

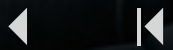



One of our earliest driving aids

In their early days, motor cars were often seen as cantankerous beasts full of mysterious technology. Steering them was physically demanding and keeping them running required specialist knowledge that few possessed. Consequently, the Daimler motor company often had its vehicles delivered by genuine experts who not only handed the cars over to their new owners, but also showed the wealthy gentlemen how to operate their new technological marvel. In addition, they often fulfilled the functions of mechanic, chauffeur and travel companion too – sometimes for weeks or even months after that initial delivery.

One such automotive expert was Rudolf Schwarz. Herr Schwarz, an esteemed Daimler employee held in high regard by Gottlieb Daimler himself, was born in Ludwigsburg in 1878, making him perhaps one of the earliest driving aids. Nowadays, of course, such assistants come in the form of intelligent electronic systems, more than a dozen of which are fitted to the CL. Together, they can help to increase safety and comfort, and ensure CL driving, unlike those early car journeys, is always a truly effortless experience.





Engines and suspension

Safety

Comfort

CL 500

16 **Mercedes-Benz Intelligent Drive**

17 **Efficiency in the CL-Class**

18 **Engines**

BlueDIRECT V8 petrol engine

20 **Transmissions**

7G-Tronic Plus

5-speed automatic transmission

22 **Suspension**

Active Body Control (ABC) with crosswind stabilisation

24 **Integrated safety concept**

Attention Assist

Adaptive High Beam Assist

Night View Assist Plus

Driving Assistance Package

Pre-Safe® Brake and BAS Plus

Pre-Safe® system

Restraint systems

Rescue assistance

28 **Multimedia systems**

COMAND multimedia system

SplitView

Harman Kardon® Logic 7® surround sound system

30 **Electronic assistants**

Reversing camera

Parktronic with Parking Guidance

Speed Limit Assist

32 **Climate control**

Luxury automatic climate control

33 **Seats**

Dynamic multi-contour seats

Comfort-ventilated front seats

34 **CL 500**

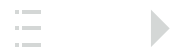



> View price list



> View offers



> SOUND WITH POWER



> Mercedes-Benz Magazine

AMG

Equipment

Services

Facts and finishes

15

36 **CL 63 AMG**

38 **CL 63 AMG – technology**

AMG 5.5-litre V8 engine

AMG Speedshift MCT 7-speed sports transmission

40 **CL 65 AMG**

42 **Standard equipment**

43 **Optional extras**

44 *designo*

46 **Upholstery and trim**

51 **Alloy wheels**

Standard alloy wheels

Optional alloy wheels

Retailer-fit alloy wheels

52 **Retailer-fit accessories**

54 **Services**

Test drive

Mercedes-Benz Finance and Insurance

Interactive Owner's Manual

Roadside Assistance and

Accident Management

Service Care

Mercedes-Benz World

56 **Dimensions**

57 **Technical data**

58 **Paint finishes**





Mercedes-Benz Intelligent Drive – a new era in mobility

Our engineers focus on the future every day in order to make innovative technology a reality. This aspiration has resulted in developments with a lasting impact on automotive engineering. In other words, our work ensures that a Mercedes-Benz will always be ahead of its time.

We have developed one groundbreaking solution after another to get closer to realising our vision of safe and accident-free driving. Innovative technologies such as the Pre-Safe® anticipatory safety system and Distronic Plus radar-assisted cruise control first made it onto the road in a Mercedes-Benz, setting new standards in vehicle safety. It marked the first time active and passive systems were combined – for even better protection and ride comfort.

Mercedes-Benz Intelligent Drive takes things a step further by intelligently combining sensors with safety systems and electronic assistants. For us, it's a logical progression as the traffic situation has changed. There are more vehicles on the road, the driver's job is becoming more complex and distractions are increasing.

Once again, we have revolutionised the car to provide even more assistance and to help deal with road situations effectively: today, a Mercedes-Benz has an even greater spatial awareness. It has a better view of the road and other road users, and it can react to what it sees.

We have developed a stereo camera system that is capable of capturing three dimensions. Together with further sensors, this produces a 360° view – a precise image of the surroundings. If the safety systems and electronic assistants detect danger, they can respond within a fraction of a second to provide the driver with the right assistance for the situation in hand. For example, by performing an emergency braking manoeuvre in dangerous situations, or by dimming part of the main beam for the benefit of oncoming traffic.

Pioneer of innovation – Mercedes-Benz Intelligent Drive once again underlines our leading ambition and points the way ahead to accident-free and autonomous driving. The following pages include further information about our safety and comfort systems. They are available as standard equipment or optional extras for the CL-Class, depending on the model specification. Further details can be found on pages 34–38 and 40–41.



Efficiency in the CL-Class

The CL has always been a technological standard-setter – and the latest generation is no exception. Its BlueDIRECT engine comes with innovations such as direct petrol injection that help to further enhance fuel efficiency and reduce emissions..



Environmental protection and energy conservation are of ever increasing importance, with CO₂ emissions, fuel consumption and petrol prices all key issues for today's drivers. That's why the CL, besides boasting an exceptionally low drag coefficient, now also features BlueEFFICIENCY technology and a BlueDIRECT engine with direct petrol injection. The fuel-saving measures for the CL range include:

- 1 ECO start/stop function for the CL 500 and CL 63 AMG
- 2 BlueDIRECT petrol V8 with lower displacement, direct petrol injection, two small turbochargers for rapid responses and intercooling for optimised thermodynamic efficiency
- 3 Sealed joints around headlamps for improved aerodynamics
- 4 Optimised 7G-Tronic for CL 500
- 5 EU5 compliance for all models
- 6 Alternator management system with regenerative braking (V8 engines)
- 7 Aerodynamic exterior mirror casings
- 8 Energy-saving oil, water and power steering pumps for V8 engines
- 9 Tyres designed for lower rolling resistance



Engines

Thanks to twin turbos, direct injection and many fuel-saving features, our BlueDIRECT V8 petrol engine sets new standards for efficiency and performance.

BlueDIRECT V8 petrol engine. The CL 500 is the first Mercedes-Benz to feature our BlueDIRECT petrol V8. This high-tech engine features intercooled twin turbos that help to increase output to 435 hp (320 kW) while significantly improving torque levels, with a maximum of 700 Nm available from just 1,800 rpm. The result is even more rapid acceleration and effortless performance in any situation. Thanks to lightweight construction, lower displacement, direct fuel injection via ultra-precise piezo injectors and a range of BlueEFFICIENCY features, the CL 500 nevertheless uses less fuel than its predecessor and achieves a corresponding reduction in CO₂ emissions.

The ECO start/stop function, which temporarily switches off the engine when queuing at lights or in traffic jams, is just one of the many fuel-saving technologies fitted to the CL 500, which also meets the EU5 standard for exhaust emissions.

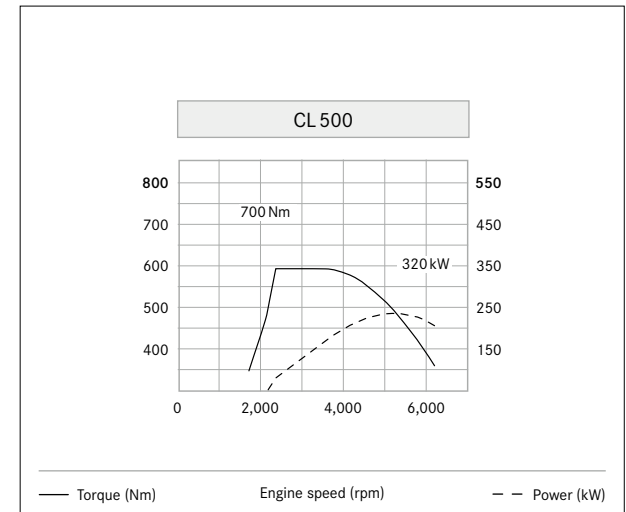

The CL 500: improved power and torque thanks to direct petrol injection and twin turbochargers





> View price list



> View offers



> SOUND WITH POWER



> Mercedes-Benz Magazine

Engines and suspension

Safety

Comfort

CL 500

AMG

Equipment

Services

Facts and finishes

19



The BlueDIRECT petrol V8 is the first of the Mercedes-Benz BlueDIRECT engines





> View price list



> View offers



> SOUND WITH POWER



> Mercedes-Benz Magazine

Engines and suspension

Safety

Comfort

CL 500

AMG

Equipment

Services

Facts and finishes

20

Transmissions

The CL's transmissions are perfectly matched to its engines – and let you choose the right mode for your mood.

7G-Tronic Plus. The CL 500 comes with an improved version of our 7G-Tronic Plus 7-speed automatic transmission. Its seven forward gears ensure the engine is always operating at the optimum speed, helping to reduce fuel consumption, while the short, slick shifts make for smoother, quieter driving. The transmission is controlled via the Direct Select gear shift lever on the steering column, while a separate set-up switch enables you to choose between 'Manual', 'Economy' and 'Sport' modes. In 'Manual' mode, you can also change gear using racing-style steering wheel gear shift paddles.

5-speed automatic transmission. The perfect partner for the CL 65 AMG's V12, the 5-speed automatic transmission offers rapid and barely perceptible gear shifts and ensures optimum acceleration in any situation. It also gives you the option of changing gear manually.



The Direct Select gear shift lever on the steering column





> View price list



> View offers



> SOUND WITH POWER



> Mercedes-Benz Magazine

Engines and suspension

Safety

Comfort

CL 500

AMG

Equipment

Services

Facts and finishes

21

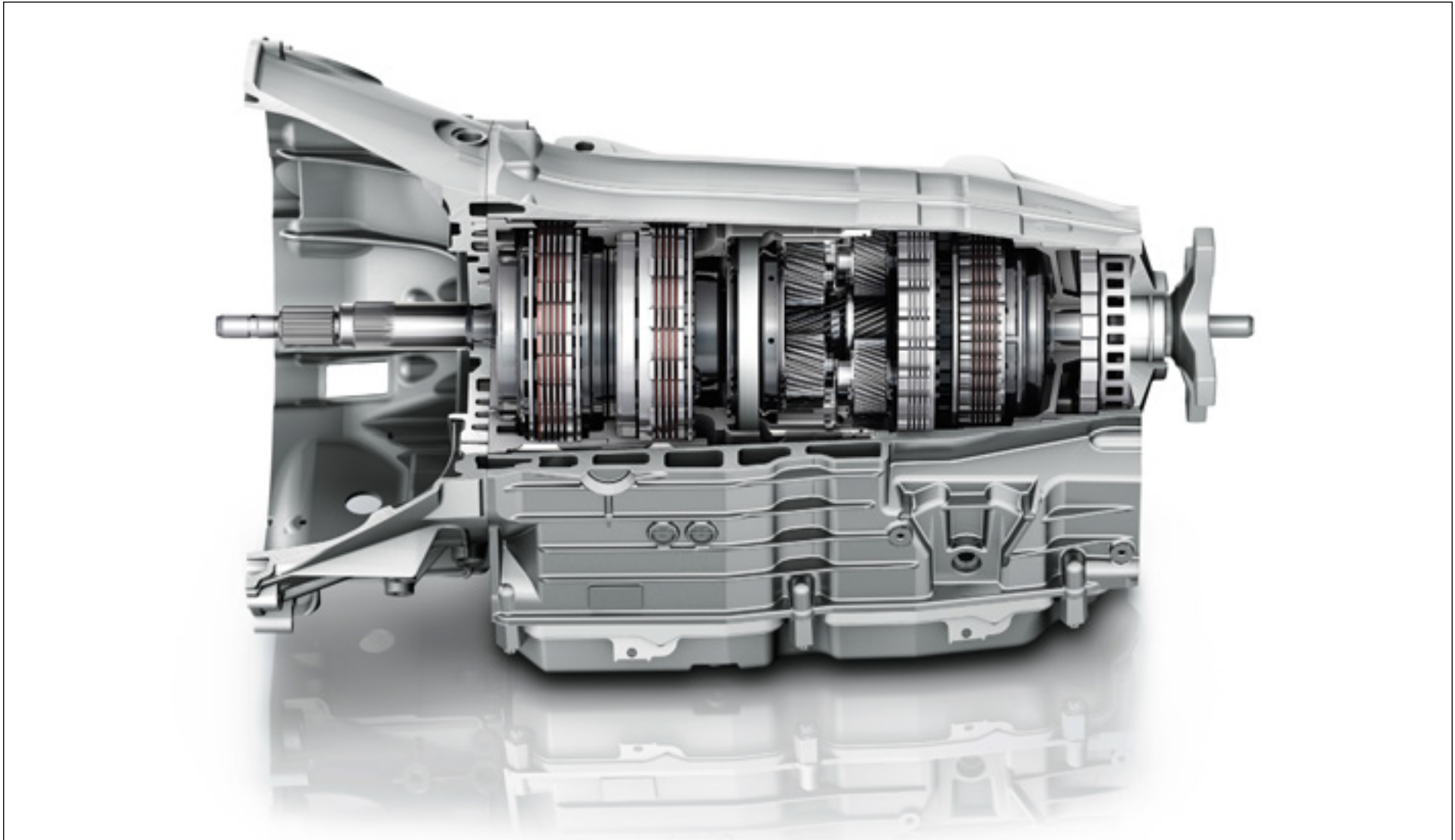

7G-Tronic Plus: the result of more than 50 years' experience in automatic transmission technology





Suspension

Thanks to intelligent suspension technology, the CL guarantees supreme comfort on every surface.

Active Body Control (ABC) with crosswind stabilisation

(standard). Active Body Control (ABC) constantly varies the suspension settings as you drive, ensuring agile handling and a supremely comfortable ride at all times. Its microprocessors instantly adjust each strut to changes in the surface or situation, enabling it to compensate automatically for body roll and pitch. ABC also helps to limit squat and dive when accelerating and

braking. In addition, ABC includes a crosswind stabilisation function that compensates for the effect of high winds by redistributing the load between the wheels.

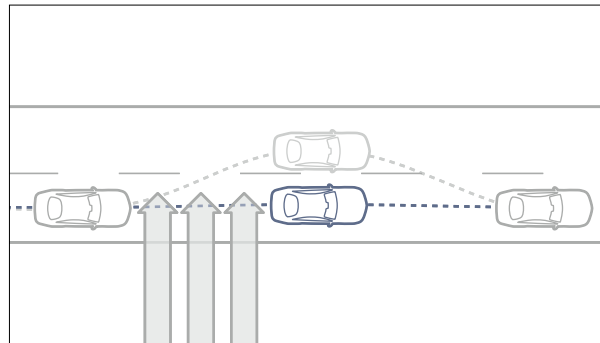
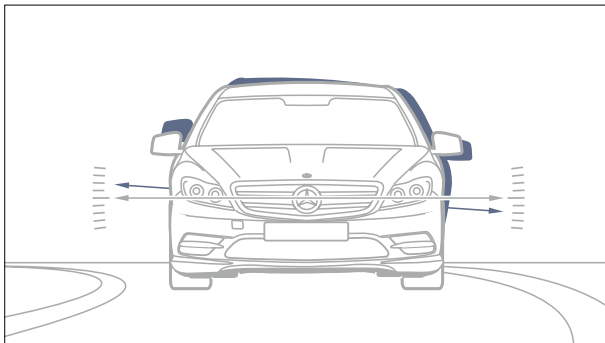

Active Body Control gives the CL a supremely agile feel. It also compensates for strong crosswinds by adjusting the load distribution between the wheels





> View price list



> View offers



> SOUND WITH POWER



> Mercedes-Benz Magazine

Engines and suspension

Safety

Comfort

CL500

AMG

Equipment

Services

Facts and finishes

23



Microprocessors pick up on uneven road surfaces and instantly compensate to ensure a smooth ride for all passengers





Integrated safety concept

Like all our passenger cars, the CL-Class is built according to an integrated safety concept. It ensures the many passive and active protection systems work together to enhance safety in every situation – helping to bring our vision of accident-free driving another step closer.

As the inventor of the motor car, we feel a particular responsibility towards road safety. That's why we were the first manufacturer to develop an integrated safety concept that seamlessly combines a car's active and passive safety features, thus ensuring optimum all-round protection. This concept covers four different areas – safer driving, anticipating danger, protecting occupants and post-crash safety – and incorporates measures designed to maximise safety in every situation, by helping you to stay safe, alerting you to danger, and assisting you wherever possible. In addition, our unique Pre-Safe® anticipatory safety system recognises likely accident scenarios and takes steps that help to further enhance occupant protection. If a collision can't be avoided, intelligent passive safety systems help to provide protection where it's needed, while solutions that can minimise the consequences of an accident and facilitate emergency assistance are also a key part of this safety concept.

A selection of these technologies for the phases 'safer driving', 'anticipating danger', 'protecting occupants' and 'post-crash safety' are presented on the following pages.

Safer driving: Attention Assist (standard). Particularly beneficial on long journeys, Attention Assist is a system for detecting fatigue. Between speeds of approximately 50 and 110 mph, it assesses the driver's behaviour via an array of sensors and registers unexpected changes that may indicate tiredness, such as involuntary movements of the steering wheel.

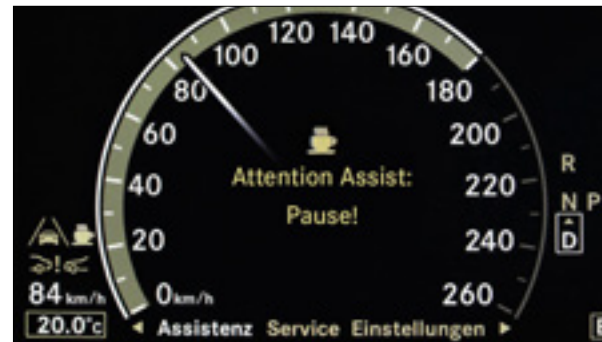

If it detects signs of fatigue, Attention Assist suggests taking a break

Safer driving: Adaptive High Beam Assist (standard). Fitted as part of the Intelligent Light System, Adaptive High Beam Assist ensures you enjoy optimum visibility at night without dazzling other drivers. It automatically dips the headlamps when there's oncoming traffic or vehicles ahead and then raises them again when the road is clear. What's more, the transition between main beam and dipped is smooth and almost imperceptible to the driver.

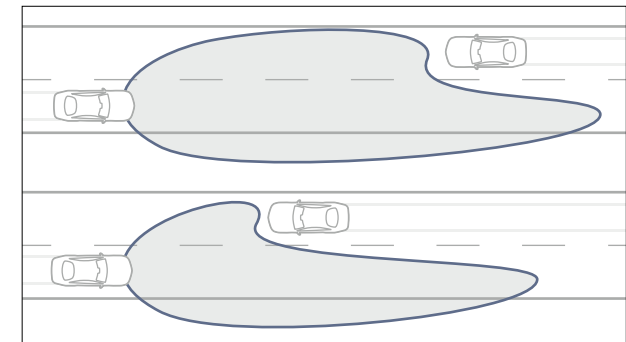

With Adaptive High Beam Assist, the transition between main beam and dipped is almost imperceptible



Safer driving: Night View Assist Plus (optional). This infrared camera system captures the entire area that would be illuminated on main beam and shows a black-and-white image in the instrument cluster. In situations where switching to main beam is not appropriate, Night View Assist Plus ensures you have a clearer picture of the road ahead, enabling you to react faster to potentially dangerous situations.



Night View Assist Plus helps drivers to spot pedestrians by highlighting them on the screen

Safer driving: Driving Assistance Package (optional). This package comprises a range of intelligent safety technologies. Active Lane-Keeping Assist draws the driver's attention to unintended lane changes, gently vibrating the steering wheel if the car wanders across lane markings. If the driver doesn't react to the warning, the system is able to intervene in order to correct the car's course. Active Blind Spot Assist makes intentional lane changes safer too, using twin radar sensors to watch over the areas not visible in your exterior mirrors. If the sensors spot a vehicle in one of these blind spots, a flashing red



Active Blind Spot Assist warns the driver of potentially dangerous lane changes

triangle appears in the corresponding mirror, accompanied by an acoustic warning from the instrument panel. Should the driver nevertheless proceed to change lanes, the system can intervene and help prevent a collision by automatically applying the brakes on the appropriate side. DISTRONIC Plus radar-assisted cruise control, meanwhile, enables the CL-Class to automatically maintain a preset distance from the vehicle in front, both in high-speed driving and stop/start traffic. Also included in the package are our Brake Assist BAS Plus and Pre-Safe® Brake systems – to give that feeling of safety on every trip.

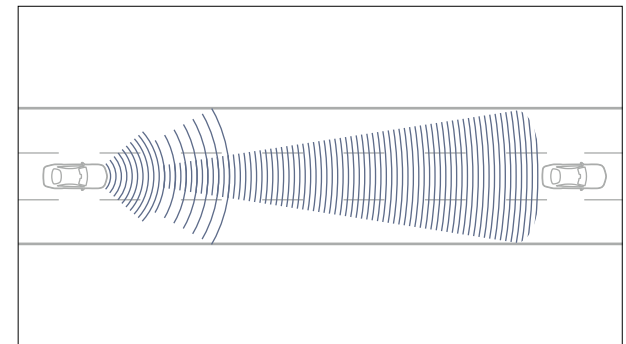

DISTRONIC Plus radar-assisted cruise control helps the driver to maintain a safe distance from the vehicle in front

**Anticipating danger: Pre-Safe® Brake and BAS Plus**

(part of optional Driving Assistance Package). If it detects the risk of a collision, Pre-Safe® Brake alerts the driver via visual and audible warnings. At the same time, BAS Plus assesses the brake force required in order to avoid an impact. If the driver applies the brakes but uses insufficient force, BAS Plus automatically raises the braking pressure to a level that exploits the remaining stopping distance to the full, thereby also lessening the likelihood of a shunt from behind.

Should the driver fail to react to Pre-Safe® Brake's warning signals, the system intervenes automatically, applying 40% of the full braking force 1.6 seconds before the calculated point of impact and triggering a range of Pre-Safe® measures. If the driver still doesn't respond, the system then initiates autonomous emergency braking, enabling the speed and severity of any impact to be significantly reduced.

Anticipating danger: Pre-Safe® system (standard). If it detects a probable accident situation, Pre-Safe® can take anticipatory measures to protect the occupants, such as activating the seat belt tensioners, automatically closing the front windows and sunroof (if fitted), and moving the passenger seat to a better position for an impact. If optional dynamic multi-contour seats are fitted, their side bolsters can be adjusted to hold the occupants more securely in place.

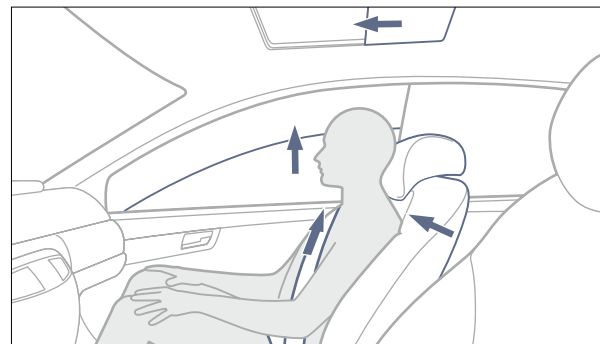
**Protecting occupants: restraint systems** (standard).

In the CL-Class, the 3-point seat belts, seat belt tensioners, belt force limiters and airbags are all carefully coordinated so as to keep injuries to a minimum. Eight airbags ensure optimum occupant protection, with dual-stage front airbags, four sidebags and two windowbags fitted as standard. If the crash sensors detect an impact, the seat belts are instantly tensed, helping to ensure the occupants remain firmly in their seats, while the belt force limiter relaxes the belt as the situation allows, in order to prevent undue force being applied to the rib cage.



> View price list



> View offers



> SOUND WITH POWER



> Mercedes-Benz Magazine

Engines and suspension

Safety

Comfort

CL 500

AMG

Equipment

Services

Facts and finishes

27



Post-crash safety: rescue assistance. Mercedes-Benz has developed a range of measures that help to minimise the secondary consequences of an accident and facilitate occupant rescue. These include automatic engine cut-off, self-activating hazard lights and emergency cabin lighting. In addition, the central locking system is automatically released in the event of an accident, and there are special crash joints between the front doors and wings that make it easier to open the doors after frontal collisions. In addition, Mercedes-Benz provides a rescue guide for emergency services that can be downloaded from the Internet at www.mercedes-benz.co.uk/rescueguide





Multimedia systems

The CL comes with Bluetooth® connectivity, USB port and SD card slot and can be fitted with the Front Seat Entertainment Package, which includes SplitView and the Harman Kardon® Logic 7® surround sound system.

COMAND multimedia system (standard). The COMAND system combines the telephone, audio and video functions plus hard drive-based navigation in one easy-to-use unit. Its 6-disc DVD changer plays video and audio CDs or DVDs as well as MP3 audio files. In addition, COMAND enables you to store up to 2,500 songs on the hard drive and search its music library by title or artist, ensuring you can find the desired track quickly and easily. All information

is presented on a central colour screen, which can even display maps in 3D. COMAND also includes Linguatronic voice control, meaning many functions can be operated via simple spoken commands, as well as 3 years' worth of free updates for its European map data and a Media Interface that allows full integration and control of external media devices.

SplitView (part of the Front Seat Entertainment Package). Thanks to SplitView, the driver and front seat passenger can view different full-size images on the same screen. This means the passenger can watch their choice of in-car entertainment while the driver continues to see map data from the navigation system. The wireless headphones allow the passenger to enjoy audio output without distracting the driver.



COMAND controller in the centre console

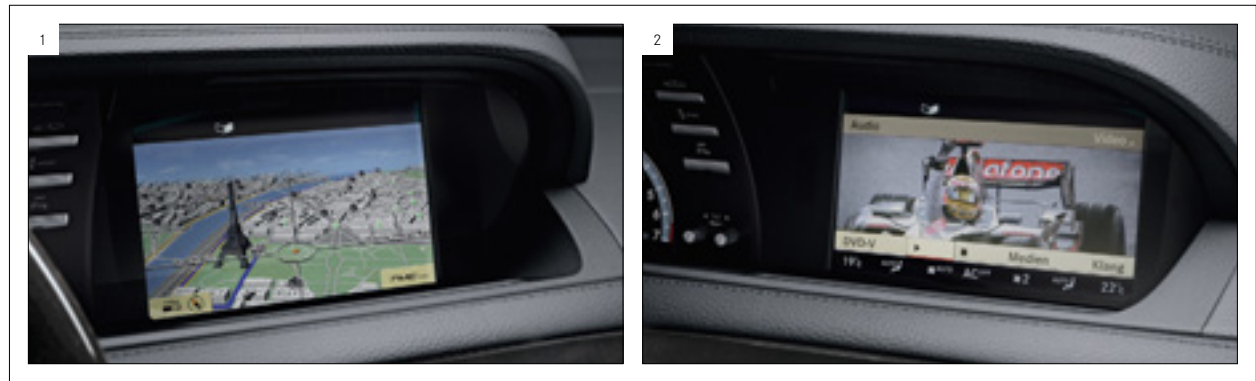

SplitView enables the screen to simultaneously display different images for the driver (1) and the front seat passenger (2)





Harman Kardon® Logic7® surround sound system

(part of the optional Front Seat Entertainment Package). This 14-speaker surround sound system is tailored to the CL's cabin and features a 13-channel DSP amplifier as well as an integral subwoofer. 3D sound in Dolby Digital 5.1 guarantees maximum listening pleasure, while the speed-sensitive volume adjustment ensures the sound remains consistent throughout the journey.

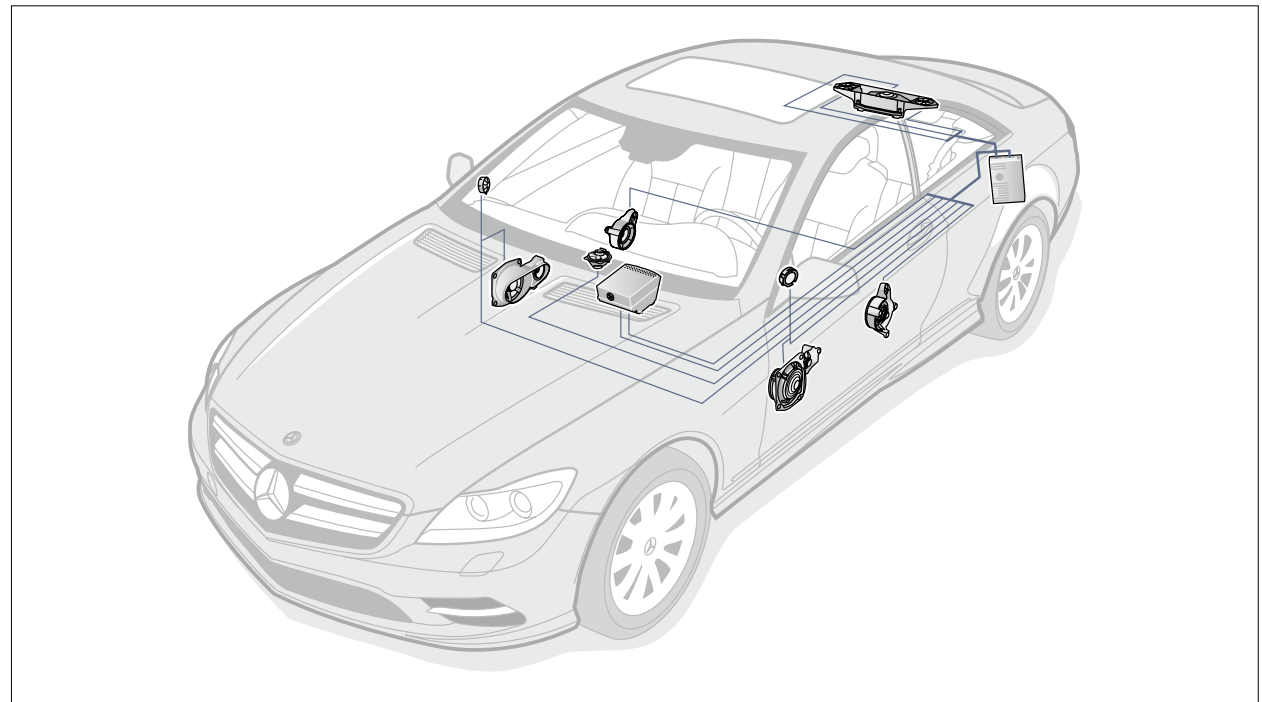

The Harman Kardon® Logic7® surround sound system guarantees a first-class listening experience



> View price list



> View offers



> SOUND WITH POWER



> Mercedes-Benz Magazine

Engines and suspension

Safety

Comfort

CL 500

AMG

Equipment

Services

Facts and finishes

30

Electronic assistants

Numerous electronic assistants help to make CL driving safer and more relaxing.



The reversing camera's wide-angle lens enables you to see what's immediately behind the car

Reversing camera (optional; standard on CL 65 AMG).

The reversing camera makes for safer and easier parking manoeuvres. Fitted below the boot lid handle, this wide-angle camera captures the area immediately behind the car and displays the image on the COMAND multimedia system's screen. The camera is activated automatically as soon as the driver engages reverse.





Parktronic with Parking Guidance (standard).

By measuring gaps via ultrasound sensors, Parktronic can help the driver manoeuvre into tight spaces. If the sensors detect a suitably sized space, the situation is depicted graphically in the multi-function display. The red set of tracks shows the current steering angle, the yellow lines represent the required angle. As soon as the two

correspond, the lines turn green. In addition, the system will also illustrate the distance from any objects in the car's vicinity when manoeuvring.

Speed Limit Assist (standard). Thanks to a small windscreen-mounted camera, the CL can read speed limit signs and display the current limit in the instrument panel. This ensures the driver always knows the speed limit for any given road – a particular advantage in areas where the speed limit varies or when passing through roadworks.

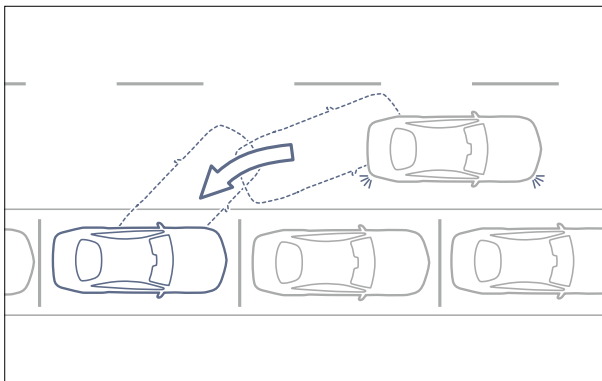

Advanced Parking Guidance helps you manoeuvre into gaps



The progress of the manoeuvre is shown in the multi-function display



The current speed limit is displayed in the instrument panel





Climate control

The CL's luxury automatic climate control enhances your comfort and helps you to stay focused at all times.

Luxury automatic climate control (standard). The CL comes with a luxury automatic climate control system that enables the driver and front seat passenger to select their own separate settings. Its sensors monitor the

temperature inside and outside the cabin and ensure the preset temperature for each zone is maintained at all times, with a solar sensor in the windscreen enabling it to compensate even for strong sunlight. Front seat

occupants can also increase or decrease the air temperature in the footwells independently of their selected temperature settings.

As a result, each front seat occupant can enjoy the right climate for them, ensuring maximum concentration for the driver, plus optimum comfort and safety all round.

Also fitted as standard are an air recirculation function, a chilled glove compartment, and a combined dust filter and activated charcoal filter that keeps the cabin free from particulates and maintains optimum air quality at all times.



Your ideal temperature at the push of a button



The climate control menu in the COMAND multimedia system





Seats

The CL seats offer optimum comfort, ergonomics and safety combined with an exclusive design.

Dynamic multi-contour seats (optional; standard on AMG models). The dynamic multi-contour front seats with massage function offer outstanding long-distance comfort. Air chambers in the lumbar and shoulder regions

can be adjusted to each occupant's individual body shape, while the side bolsters adapt automatically as you drive to ensure optimum support at all times, especially when cornering. Neck-Pro comfort front head restraints

and 4-way adjustable lumbar support further add to your sense of well-being.

Comfort-ventilated front seats (optional; standard on AMG models). The air-conditioned seats provide either cooling ventilation or warming heat, ensuring optimum comfort all year round.



Comfortable individually sculpted rear seats



Dynamic multi-contour front seats with massage function





> View price list



> View offers



> SOUND WITH POWER



> Mercedes-Benz Magazine

Engines and suspension

Safety

Comfort

CL 500

AMG

Equipment

Services

Facts and finishes

34

CL 500

Luxury, efficiency, performance – the CL 500 triumphs on all fronts.



AMG sports styling comes as standard





The comprehensive standard equipment for the CL 500 includes metallic paint, 19" AMG 5-spoke alloy wheels and the Intelligent Light System, which comprises bi-xenon headlamps, Adaptive High Beam Assist and chrome-trimmed LED daytime running lights. For easier access and exit, a doorhold system and Easy-Entry mechanisms for the front seats and steering wheel are also fitted as standard. Inside, there's finely crafted trim in Black Ash wood, standard leather upholstery that comes in five harmonious colour schemes, plus heated and electrically adjustable front seats with four-way lumbar adjustment.

The standard COMAND multimedia system combines all the key entertainment and communication functions and features a user-friendly colour display, while Attention Assist, Active Body Control (ABC) with crosswind stabilisation

and Torque Vectoring Brake all help to maximise safety and comfort. For effortless parking manoeuvres, Parktronic also comes as standard.



Wood- and nappa leather-trimmed multi-function steering wheel



CL 63 AMG

A champion among sporting coupés: the CL 63 AMG. → www.mercedes-benz.co.uk/amg

With the CL 63 AMG, the first impression is always a powerful one, thanks to AMG bodystyling featuring a muscular front apron with AMG-specific LED daytime running lights and High-Gloss Black cross strut, AMG side skirts and a diffuser-style rear apron in the vehicle body colour. There's also a striking AMG-specific single-bar grille, chromed twin tailpipes and eye-catching 19" AMG 5-triple-spoke alloy wheels. For an even more dramatic look, optional 20" AMG forged alloy wheels in painted Titanium Grey are available from the AMG Performance Studio. The cabin, too, bears the unmistakable AMG signature. It features AMG sports seats with AMG-design Passion leather upholstery, an AMG sports steering wheel with aluminium shift paddles, and an AMG instrument panel with AMG V8 BITURBO start screen.

As well as displaying the current gear and the engine oil temperature, the instrument panel display also features a Racetimer function that allows you to record individual lap times.

The finishing touch comes courtesy of an IWC-designed analogue clock that blends beautifully with the Dark Brown Burr Walnut trim (AMG Interior Carbon-Fibre Trim Package is available as an option).



AMG sports seats with AMG-design Passion leather upholstery and natural leather side bolsters



AMG sports steering wheel with aluminium gear shift paddles





> View price list



> View offers



> SOUND WITH POWER



> Mercedes-Benz Magazine

Engines and suspension

Safety

Comfort

CL 500

AMG

Equipment

Services

Facts and finishes

37



The CL 63 AMG combines powerful performance, muscular looks and impressive efficiency





CL 63 AMG – technology

The CL 63 AMG combines exhilaration with efficiency – thanks to its AMG 5.5-litre biturbo V8 and AMG Speedshift MCT 7-speed sports transmission.

→ www.mercedes-benz.co.uk/amg

AMG 5.5-litre V8 engine. The CL 63 AMG's biturbo AMG V8 is not just impressively powerful, it's also exceptionally fuel-efficient. With 544 hp (400 kW) and 800 Nm of torque (571 hp/420 kW and 900 Nm with the optional AMG Performance Package) it delivers 0–62 mph in 4.5 seconds, and yet achieves class-leading 26.9 mpg on the combined cycle. This remarkable efficiency is the result of advanced technologies such as direct petrol injection, twin turbochargers and regenerative braking, combined with a transmission featuring a 'Controlled Efficiency' mode with start/stop function. As you'd expect from an AMG engine, this high-tech V8 nevertheless delivers a satisfyingly rich and powerful sound.



The AMG 5.5-litre biturbo V8 offers up to 571 hp and 900 Nm of torque with the optional AMG Performance Package



AMG Speedshift MCT 7-speed sports transmission.

Like the innovative engine it accompanies, the CL 63 AMG's Speedshift MCT transmission combines the best of both worlds, blending the sporty, direct and involving feel of a manual transmission with the comfort and effortlessness of an automatic. Its 'Controlled Efficiency', 'Sport' and 'Manual' modes give you a choice of three different shift styles, while the kickdown function enables the transmission to shift straight from seventh gear to fourth, for instance – allowing you to exploit the engine's performance potential to the full.

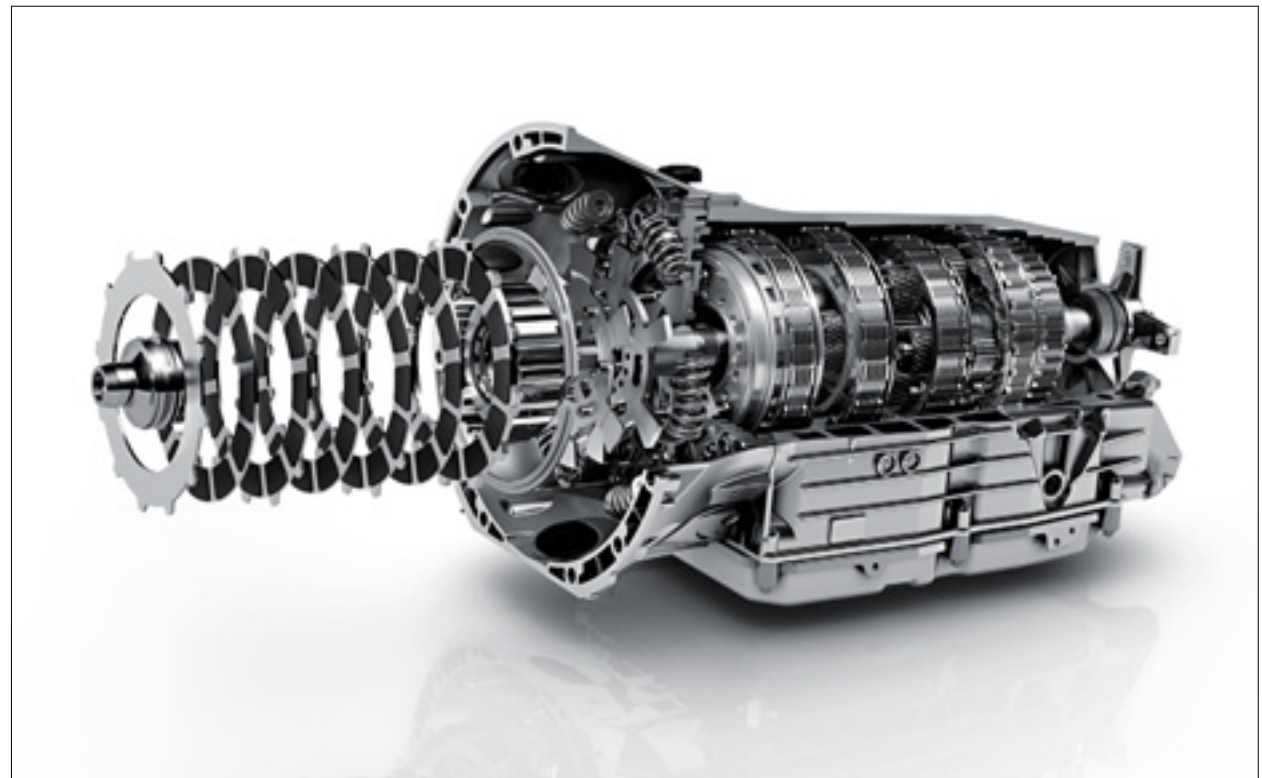

The AMG Speedshift MCT 7-speed sports transmission delivers smooth yet rapid gear changes



CL 65 AMG

A perfect blend of performance and exclusivity: the CL 65 AMG. → www.mercedes-benz.co.uk/amg

The CL 65 AMG is a luxury coupé like no other. Its 6.0 litre biturbo AMG V12 delivers 630 hp (463 kW) and a remarkable 1,000 Nm of torque, making even the most rapid driving seem utterly effortless.

From the outside, the CL 65 AMG offers the same muscular elegance as the CL 63 AMG, but with the extra exclusivity of 20" 5-twin-spoke forged alloy wheels, front apron with chrome cross strut, diffuser-style rear apron in chrome, model-specific chromed twin tailpipes and 'V12 BITURBO' badges on the front wings.

Inside, the highly contoured backrests of the AMG sports seats provide firm support even in fast cornering, while the standard Exclusive Passion leather with model-specific seat upholstery and leather door centre panels lends

a highly individual look. Brushed stainless steel sports pedals with rubber studs, an AMG sports steering wheel with aluminium shift paddles, and an instrument panel with an 'AMG V12 BITURBO' start screen are among the many other distinctive interior details.

Both AMG models can be given an even more individual touch with AMG Performance Studio options. These include the AMG Exterior Carbon-Fibre Trim Package, which adds carbon fibre for the front apron's cross-strut, the exterior mirror casings and the diffuser-style rear apron element.

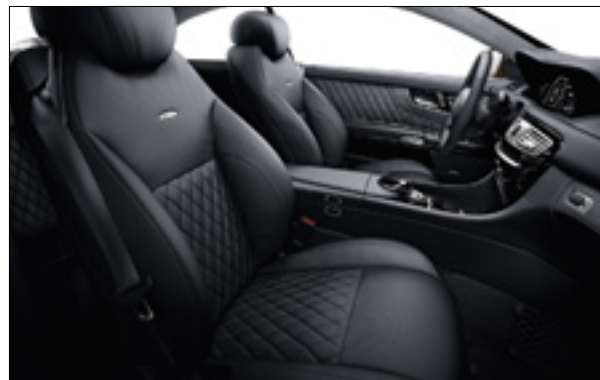

Exclusive Passion leather plus AMG sports seats featuring AMG-design leather upholstery



Model-specific chromed twin tailpipes





> View price list



> View offers



> SOUND WITH POWER



> Mercedes-Benz Magazine

Engines and suspension

Safety

Comfort

CL 500

AMG

Equipment

Services

Facts and finishes

41



With the CL 65 AMG, exceptional performance and sumptuous luxury go hand in hand





> View price list



> View offers



> SOUND WITH POWER



> Mercedes-Benz Magazine

Engines and suspension

Safety

Comfort

CL 500

AMG

Equipment

Services

Facts and finishes

42

Standard equipment | Selection



Wood- and nappa leather-trimmed multi-function steering wheel¹



COMAND multimedia system



Memory function for front seats



Telephone keypad

¹ Shown with optional Keyless-Go



Intelligent Light System with bi-xenon headlamps and LED daytime running lights



LED tail lights

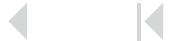



> View price list



> View offers



> SOUND WITH POWER



> Mercedes-Benz Magazine

Engines and suspension

Safety

Comfort

CL 500

AMG

Equipment

Services

Facts and finishes

43

Optional extras | Selection



Active Blind Spot Assist (as part of the Driving Assistance Package)



Ambient interior lighting with three colour settings



Keyless-Go



Harman Kardon® Logic 7® surround sound system¹

¹ Included in Front Seat Entertainment Package (code P45)



Night View Assist Plus



SplitView²





> View price list



> View offers



> SOUND WITH POWER



> Mercedes-Benz Magazine

Engines and suspension

Safety

Comfort

CL 500

AMG

Equipment

Services

Facts and finishes

44

designo

Exclusive colours, exquisite upholsteries and the finest interior trim: *designo* options add an extra touch of individuality to your CL.

→ www.mercedes-benz.co.uk/designo



designo Cashmere White Magno paint finish (code 049)

With beautifully crafted materials and a wide variety of colours, the *designo* range offers almost endless possibilities. Eye-catching *designo* paint finishes add an exclusive touch to the exterior. For the interior, there's *designo* Exclusive Aniline leather, complemented by carefully matched wood trim, such as Black Piano Lacquer, with



designo Selection Package with *designo* logo in 18-carat gold

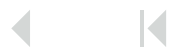



a gloss finish applied in up to ten layers, or stone trims made of finely-cut Norwegian granite.

All *designo* CL upholsteries feature 10-rib vertical fluting and metal *designo* backrest badges, while the wood- and leather-trimmed steering wheel and *designo* roof lining in

fabric, Alcantara® or Black nappa leather further enhance the air of refinement.

Whether you opt for a harmonious colour scheme or striking contrasts, *designo* options lend your CL an even more exclusive look and feel.

In the *designo* section of our website, you can browse through the colours and materials available and try out possible combinations.



Door centre panels in Light Brown *designo* Exclusive Aniline leather (X35)



Upholstery in Light Brown *designo* Exclusive Aniline leather (X35) with Black Piano Lacquer trim (W69)





Upholstery and trim



The Black/Black interior scheme features either standard leather or optional Passion leather upholstery (standard on CL 63 AMG), with matching Black carpets and cabin trim (side panel trims, dashboard, centre console and steering wheel trim). Choose the optional Exclusive Passion leather (standard on CL 65 AMG) and elements such as the dashboard, doors and centre console are finished in Passion leather. The roof lining and A- and C-pillars are finished in Alcantara®.

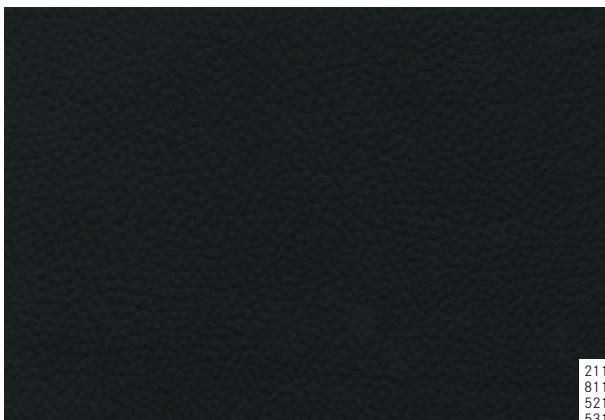

211
811
521
531



H14



731



736



H18

Black/Black

- 211 Leather
- 811 Passion leather¹
- 521 Exclusive Passion leather¹
- 531 Exclusive Passion leather²

Trim

- H14 Light Burr Walnut wood¹
- 731 Dark Brown Burr Walnut wood³
- 736 Black Ash wood^{1,4}
- H18 Brown Poplar wood⁵

¹ Optional ² Standard on CL 65 AMG ³ Standard on CL 63 AMG and CL 65 AMG, optional on CL 500 ⁴ Standard on CL 500 ⁵ Optional on CL 65 AMG





The Cashmere Beige/Savanna Beige interior scheme features Cashmere Beige leather upholstery, with matching door panels, lower dashboard trim and centre console. The steering wheel, upper dashboard trim, door caps and carpets come in Savanna Beige. As an option, this colour scheme is also available with Passion leather (standard on CL 63 AMG) or choose Exclusive Passion leather (standard on CL 65 AMG) and elements such as the dashboard, doors and centre console are finished in Passion leather. The roof lining and A- and C-pillars are finished in Alcantara®

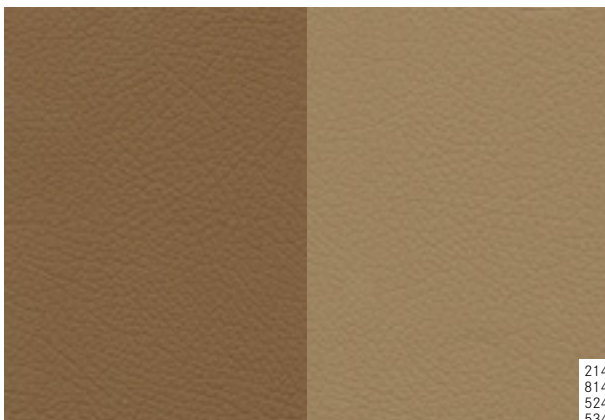

214
814
524
534



H14



731



736



H18

Cashmere Beige/Savanna Beige

- 214 Leather
- 814 Passion leather¹
- 524 Exclusive Passion leather¹
- 534 Exclusive Passion leather²

Trim

- H14 Light Burr Walnut wood¹
- 731 Dark Brown Burr Walnut wood⁵
- 736 Black Ash wood^{1,4}
- H18 Brown Poplar wood⁵

¹ Optional ² Standard on CL 65 AMG ³ Standard on CL 63 AMG and CL 65 AMG, optional on CL 500 ⁴ Standard on CL 500 ⁵ Optional on CL 65 AMG





The Alpaca Grey/Basalt Grey interior scheme features Alpaca Grey leather upholstery, with matching door panels, lower dashboard trim, centre console and carpets. The steering wheel, upper dashboard trim and door caps come in Basalt Grey. As an option, this colour scheme is also available with Passion leather (standard on CL 63 AMG) or choose Exclusive Passion leather (standard on CL 65 AMG) and elements such as the dashboard, doors and centre console are finished in Passion leather. The roof lining and A- and C-pillars are finished in Alcantara®.

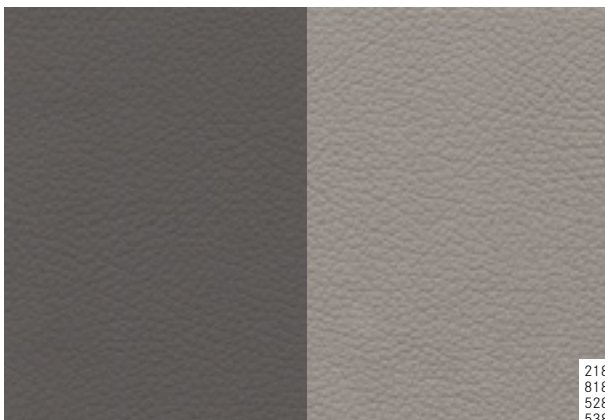

218
818
528
538



H14



731



736



H18

Alpaca Grey/Basalt Grey

- 218 Leather
- 818 Passion leather¹
- 528 Exclusive Passion leather¹
- 538 Exclusive Passion leather²

Trim

- H14 Light Burr Walnut wood¹
- 731 Dark Brown Burr Walnut wood³
- 736 Black Ash wood⁴
- H18 Brown Poplar wood⁵

¹ Optional ² Standard on CL 65 AMG ³ Standard on CL 63 AMG and CL 65 AMG, optional on CL 500 ⁴ Standard on CL 500 ⁵ Optional on CL 65 AMG





The Sahara Beige/Black interior scheme features Sahara Beige leather upholstery, with matching door panels, lower dashboard trim and centre console. The steering wheel, upper dashboard trim, door caps and carpets come in Black. As an option, this colour scheme is also available with Passion leather (standard on CL 63 AMG) or choose Exclusive Passion leather (CL 500 BlueEFFICIENCY only) and elements such as the dashboard, doors and centre console are finished in Passion leather. The roof lining and A- and C-pillars are finished in Alcantara®.

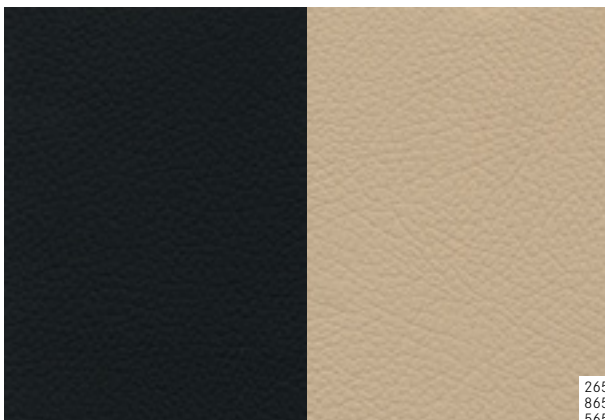

265
865
565



H14



731



736



H18

Sahara Beige/Black¹

- 265 Leather
- 865 Passion leather²
- 565 Exclusive Passion leather²

Trim

- H14 Light Burr Walnut wood²
- 731 Dark Brown Burr Walnut wood³
- 736 Black Ash wood⁴
- H18 Brown Poplar wood⁵

¹ Not available for CL 63 AMG or CL 65 AMG ² Optional ³ Standard on CL 63 AMG and CL 65 AMG, optional on CL 500 ⁴ Standard on CL 500 ⁵ Optional on CL 65 AMG





The Aubergine/Black interior scheme features Aubergine leather upholstery, with matching door panels, lower dashboard trim and centre console. The steering wheel, upper dashboard trim, door caps and carpets come in Black. As an option, this colour scheme is also available with Passion leather (standard on CL 63 AMG) or choose Exclusive Passion leather (CL 500 only) and elements such as the dashboard, doors and centre console are finished in Passion leather. The roof lining and A- and C-pillars are finished in Alcantara.[®]

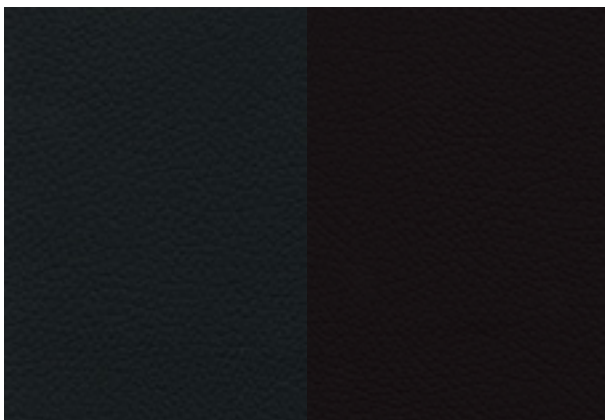

H14



731



736



H18

Aubergine/Black¹

- 267 Leather
- 867 Passion leather²
- 567 Exclusive Passion leather²

Trim

- H14 Light Burr Walnut wood²
- 731 Dark Brown Burr Walnut wood³
- 736 Black Ash wood⁴
- H18 Brown Poplar wood⁵

¹ Not available for CL 63 AMG or CL 65 AMG ² Optional ³ Standard on CL 63 AMG and CL 65 AMG, optional on CL 500 ⁴ Standard on CL 500 ⁵ Optional on CL 65 AMG





Alloy wheels



19" AMG 5-spoke alloy wheels with high-sheen finish (standard on CL 500)



19" AMG 5-triple-spoke alloy wheels painted in Titanium Grey with high-sheen finish (standard on CL 63 AMG)



20" AMG 5-twin-spoke alloy wheels, painted in Titanium Grey (standard on CL 65 AMG, optional on CL 63 AMG)



20" AMG 5-twin-spoke alloy wheels with high-sheen finish (optional)



19" 'Nuklida' 5-Y-spoke alloy wheels,¹ high-sheen Titanium Silver finish (Retailer-fit accessory)



20" 'Kiyali' 5-spoke alloy wheels,¹ Titanium Silver (Retailer-fit accessory)

¹ incenio alloy wheels are supplied without tyres





Retailer-fit accessories

A Mercedes-Benz is not just a car, it's a travel companion that can be tailored to your needs – with our wide range of Retailer-fit accessories.

→ www.mercedes-benz.co.uk/accessories

Our Retailer-fit accessories offer you a variety of ways to increase the practicality and individuality of your CL. These include a robust chromed metal coat hanger that clips onto the front seat head restraints to keep suit jackets or other items from getting creased. A very practical and

reassuring technical feature is Tracker.™ If your CL-Class is ever stolen, VHF (Very High Frequency) technology tracks your car's location – even if it's held in a garage or an underground car park. If your CL-Class is an AMG model, you might want to add an extra stylish touch with

AMG door pins. Their rectangular shape and chromed aluminium finish with 'AMG' lettering lends your AMG that extra branded detail. Should your vehicle be parked up for any length of time, our AMG-branded indoor cover will protect the bodywork from scratches and dust.



Coat hanger



Tracker™



AMG door pins



> View price list



> View offers



> SOUND WITH POWER



> Mercedes-Benz Magazine

Engines and suspension

Safety

Comfort

CL500

AMG

Equipment

Services

Facts and finishes

53

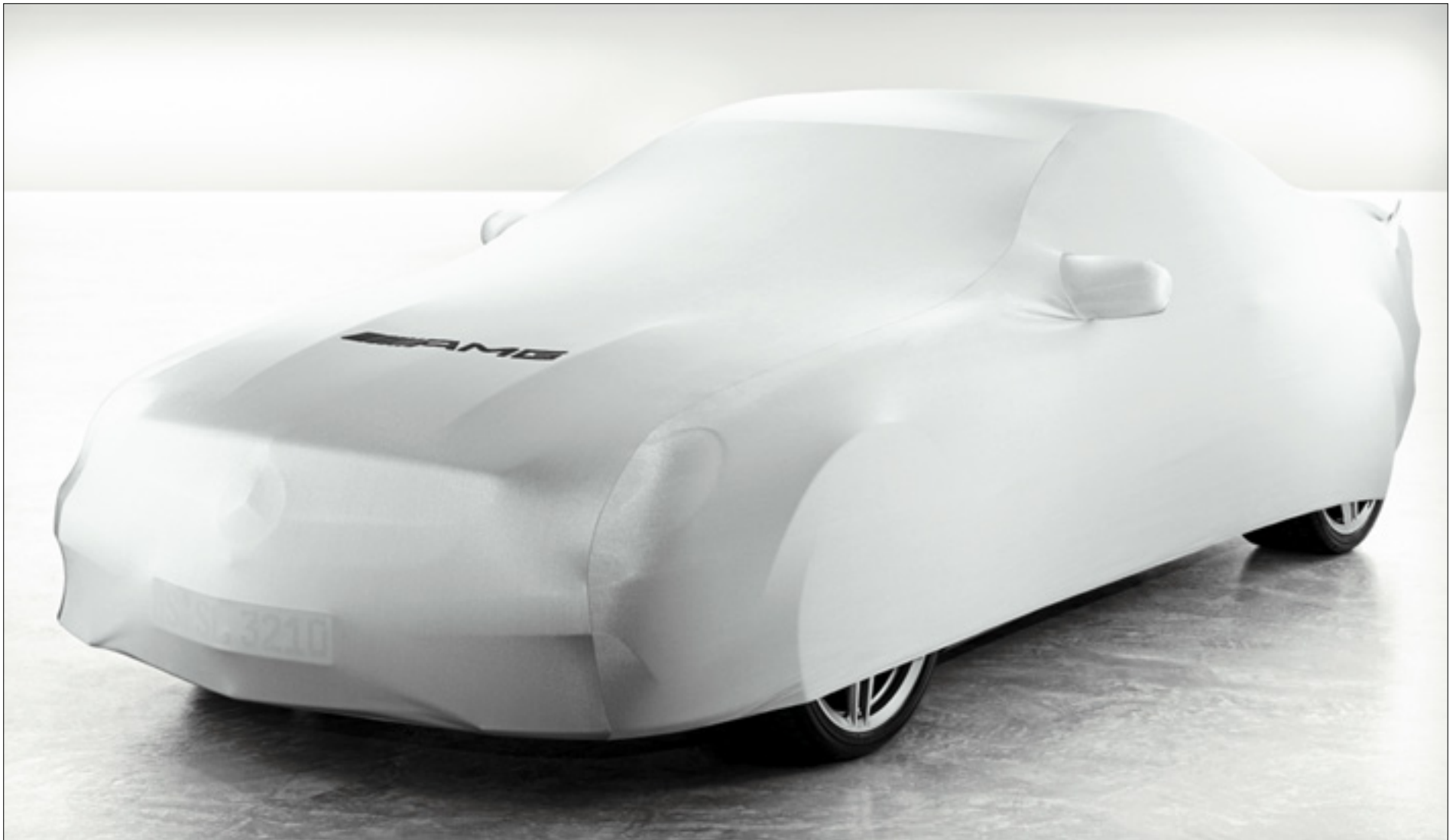

AMG indoor car cover





Services

Test drive. You've seen the pictures, you've read the facts. Now all that's missing is to experience your dream Mercedes in the flesh. Which is why we invite you to take it for a spin. See it with your own eyes. Rev up the engine, and feel how your chosen Mercedes hugs the road. Relax in style or play with a whole host of exciting onboard technology. Contact your Mercedes-Benz Retailer for a test drive, or simply go online and visit www.mercedes-benz.co.uk/testdrive. We can't wait to see you in the driving seat.

Mercedes-Benz Finance. At Mercedes-Benz Finance, our single-minded aim is to provide optimum financial solutions for all those who share the Mercedes-Benz philosophy of absolute commitment to quality. Whether you are a private customer or a business user, our finance and leasing packages can be tailored to meet your individual needs. For further information on Mercedes-Benz Finance, please contact your local Mercedes-Benz Retailer.



Mercedes-Benz Insurance offers a fully comprehensive 5-star-rated¹ Motor Insurance policy specifically designed to provide the cover you would expect from Mercedes-Benz. For a quotation, please call 0845 600 2180²

Interactive Owner's Manual. The website also offers an interactive tour, enabling you to take a closer look at your desired model. This simulation is the ideal way to acquaint yourself with your dream car. You can view key functions in detail, gain an insight into the car's inner workings or look at the benefits of each model. For further details, visit www.mercedes-benz.co.uk/clclassmanual



Roadside Assistance and Accident Management. Rest assured that should you ever need help, Mercedes-Benz Roadside Assistance is there for you. In the unlikely event of a technical breakdown³ you can rely on the Mercedes-Benz Roadside Assistance Team – anywhere in Europe. Mercedes-Benz will also assist you in the unfortunate event of an accident, from recovering your car and delivering it to your preferred Mercedes-Benz Retailer right through to managing your insurance claim in full, you will be looked after by the experts who built your Mercedes-Benz.⁴ Minor mishaps are also covered. Whether you lose your key, run out of fuel, or your vehicle is damaged due to vandalism, Mercedes-Benz ensures that you still reach your destination. Often the problem can be rectified on the spot, but if this is not possible, we will naturally ensure that your vehicle is taken to the nearest Mercedes-Benz Retailer to get you back on the road as quickly as possible.

¹As rated by Defaqto, a leading UK independent financial research company

²Mercedes-Benz Motor Insurance is underwritten by Aviva Insurance Limited. Calls are charged at local rate and may be recorded. We may decline to quote in some circumstances

Simply phone our Customer Assistance Centre on 00800 1 777 7777,⁵ where our specialists will organise assistance for you.

Service Care. To keep a tight grip on costs, Mercedes-Benz offers service plans to cover the costs of an annual service, for two, three and four years. Plans can be paid monthly with interest-free instalments or alternatively, if you pay upfront, should you sell your vehicle any remaining services will be transferred to the new owner. All routine maintenance and additional items are covered. To find out more, please contact your local Retailer or visit www.mercedes-benz.co.uk/servicecare

³Cover is initially valid for your vehicle for four years from the date of first registration. This can be extended from the fifth year, up to a maximum of 30 years, on completion of each scheduled maintenance service, providing that this service is carried out by a Mercedes-Benz

Mercedes-Benz World at Brooklands. Discover Mercedes-Benz racing heritage, from its connections to the famous Brooklands circuit through to present-day Formula 1™ brought to life in the most sensational way at Mercedes-Benz World in Surrey. View, touch and sit in every car from the Mercedes-Benz range, and encounter automotive legends like the ‘Gullwing’ and many other classic icons, in the UK’s largest Mercedes-Benz showcase. Then set your pulse racing by booking one of our thrilling AMG or 4×4 Driving Experiences. Relax and refuel in Café 1886, or enjoy the delicious menu and elegant surroundings of the Gullwing Bistro. For more information, visit www.mercedes-benzworld.co.uk

Official Workshop. Minor mishap cover is provided at the absolute discretion of Mercedes-Benz

⁴Management of claims for non-fault accidents only

⁵In non-affiliated European countries: +44 20 7975 7077





Dimensions

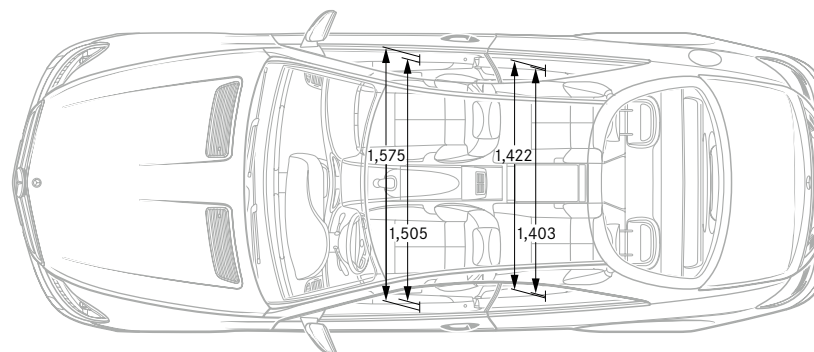
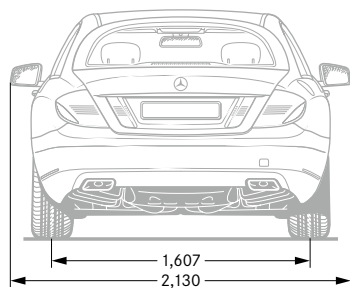
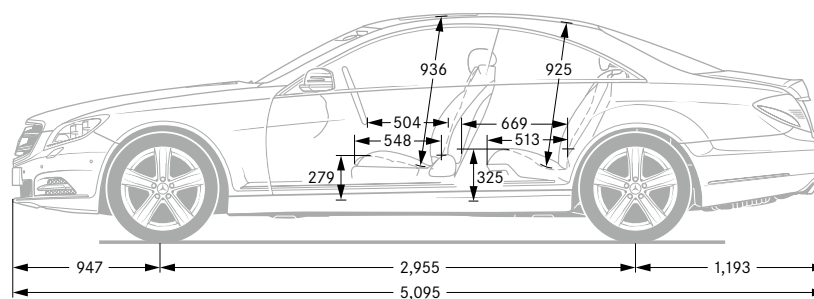
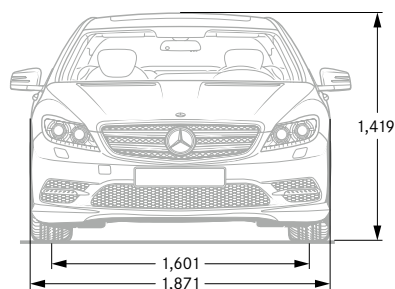

All measurements in millimetres. The dimensions shown are mean values and apply to standard-specification, unladen vehicles





Technical data

Petrol engines	CL 500	CL 63 AMG	CL 65 AMG
Arrangement/cylinders/valves	V/8/32	V/8/32	V/12/36
Total displacement - cc	4,663	5,461	5,980
Rated output ¹ - hp (kW) at rpm	435 (320)/5,250	544 (400)/5,250-5,750 [571 (420)/5,500]	630 (463)/4,600-5,000
Rated torque ¹ - Nm at rpm	700/1,800-3,500	800/2,000-4,500 [900/2,250-3,750]	1,000/2,300-4,300
Acceleration 0-62 mph - sec	4.9	4.5 [4.4]	4.4
Top speed approx. - mph	155 ²	155 ² [186]	155 ²
Tyre size - front	255/40 R 19	255/40 ZR 19	255/35 ZR 20
rear	275/40 R 19	275/40 ZR 19	275/35 ZR 20
Fuel consumption ³ - mpg			
Urban	20.8	19.6	13.0
Extra-urban	38.7	34.4	28.5
Combined	29.4	26.9	19.8
CO ₂ emissions, combined ³ - g/km	227-232	244	334
EU emissions standard	EU5	EU5	EU5
Fuel tank capacity/reserve (approx.) - l	83/11	90/14	90/14
Boot capacity - l	490	490	490
Turning circle - m	11.6	11.6	11.6
Kerb weight ⁴ - kg	2,070	2,135	2,245
Perm. GVW - kg	2,585	2,585	2,645

Figures in square brackets in conjunction with optional AMG Performance Package (code P30)

¹ Figures according to Directive 80/1269/EEC in the currently applicable version

² Electronically limited

³ The figures shown were obtained in accordance with the prescribed measuring process (Regulation [EC] 715/2007 in the currently applicable version). The figures are not based on an individual vehicle and do not constitute part of the product offer; they are provided solely for purposes of comparison between different vehicle models

⁴ Figures according to Directive 92/21/EC, version 95/48/EC (kerb weight with fuel tank 90% full, driver, 68 kg, and luggage, 7 kg) for standard-specification vehicles. Optional extras and accessories will generally increase this figure and reduce the payload capacity accordingly





Paint finishes

Non-metallic paint



040

Metallic paints



183



474



890

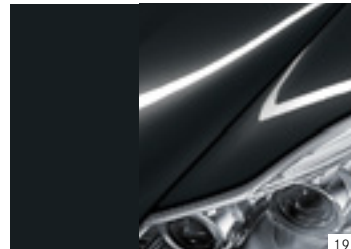

197



775

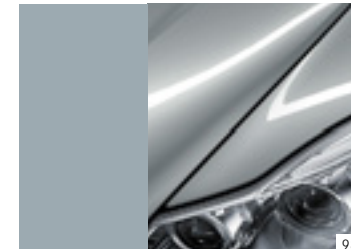

988



228



792



370

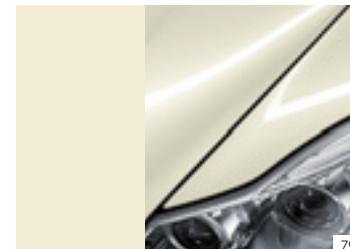

799

Non-metallic paint (standard)

040 Black

Metallic paints (standard)

183 Magnetite Black

197 Obsidian Black

228 Cornetite Blue

370 Andorite Grey

474 Peridot Brown

775 Iridium Silver

792 Palladium Silver

799 Diamond White¹

890 Cavansite Blue

988 Diamond Silver

¹Available at additional cost





> View price list



> View offers



> SOUND WITH POWER



> Mercedes-Benz Magazine

Take-back of end-of-life vehicles. Coming full circle. At the end of its long life, you can return your CL-Class to us for environment-friendly disposal in accordance with the EC End-of-Life Vehicle Directive.¹ But that day lies a long way off.

¹Applies in accordance with national regulations to vehicles up to 3.5t permissible gross weight. The CL-Class has met the statutory regulations governing the suitability of the vehicle's design for reuse and recycling for a number of years now. A network of vehicle take-back depots and dismantlers has been established which will process your vehicle in an environment-friendly manner. The ways in which both vehicles and parts can be recovered are subject to ongoing development and improvement. Consequently, the CL-Class will be able to comply with any future increases in the recycling quota within the stipulated time limits. Further information is available at www.mercedes-benz.co.uk or by calling 0808 156 6606.

Please note: this online version of the printed brochure may contain abridged copy or other content changes. The manufacturer reserves the right to make changes to the design, form, colour and specification during the delivery period, provided these changes, while taking into account the interests of the vendor, can be deemed reasonable with respect to the purchaser. Where the vendor or the manufacturer uses symbols or numbers to describe an order or the subject of an order, no rights may be derived solely from these. The illustrations may show accessories and items of optional equipment which are not part of standard specification. Colours may differ slightly from those shown. This brochure provides a general indication of the range of models, features, optional extras and/or colours available in various countries. Some of the models, features, optional extras and/or colours shown may not be available in your country or may only be available in a different specification. Additionally, some models, features, optional extras and/or colours may only be available in combination with others. For current and more specific information in relation to the range of models, features, optional extras and/or colours available in your country, and their pricing, you should contact your nearest authorised Mercedes-Benz Retailer. E&OE. www.mercedes-benz.co.uk

