



CLS-Class

Coupé and Shooting Brake



Mercedes-Benz





First impressions

Shooting Brake. Form follows function. That's a well-established design principle, now beautifully challenged by the new CLS Shooting Brake. The result is an extraordinary piece of design: at the heart, a bold rear section that blends harmoniously with the striking overall appearance. Of course, there's plenty more than stunning looks to marvel at as the CLS Coupé's brother is a master of versatility. The new CLS Shooting Brake. Time to reinvent space.

[Insight | page 4](#) [Overview | from page 5](#)

Coupé. Your heart starts to race, your head understands completely: be it rationally or emotionally, the CLS is a compelling proposition. It blends boldness with elegance, combines agility with the latest safety technology, and proves that even improved performance and enhanced efficiency can go hand in hand. In fact, with its innovative technology and distinctive four-door coupé design, it makes even the most routine drives feel extraordinary – and ensures your passengers enjoy the journey almost as much as you do.

[Insight | page 16](#) [Overview | from page 17](#)

Featured models:

CLS 350 CDI BlueEFFICIENCY Shooting Brake AMG Sport | *designo* Magno Allanite Grey | front cover and from page 5, alloy wheels in 5-spoke design, *designo* Passion leather in Cashmere White, trim in Black Piano Lacquer

CLS 350 CDI BlueEFFICIENCY Shooting Brake | *designo* Magno Cashmere White | from page 10, alloy wheels in 5-spoke design, Luxury Package, Exclusive Passion leather in Almond Beige, trim in matt finish Light Brown Poplar wood

CLS 63 AMG Shooting Brake | Diamond White | from page 13, AMG alloy wheels in triple-spoke design, Black leather, trim in carbon fibre

CLS 350 BlueEFFICIENCY AMG Sport | *designo* Alubeam Titanium | from page 17, alloy wheels in 5-spoke design, Exclusive Passion leather in Aubergine, trim in Black Piano Lacquer

CLS 350 CDI BlueEFFICIENCY | Thulite Red | from page 22, alloy wheels in 5-spoke design, Porcelain leather, trim in matt finish Light Brown Poplar wood

CLS 63 AMG | Metallic Iridium Silver | from page 24, AMG alloy wheels in triple-spoke design, Exclusive Passion Black leather seats, trim in Black Piano Lacquer

Specifications shown may include optional equipment and accessories



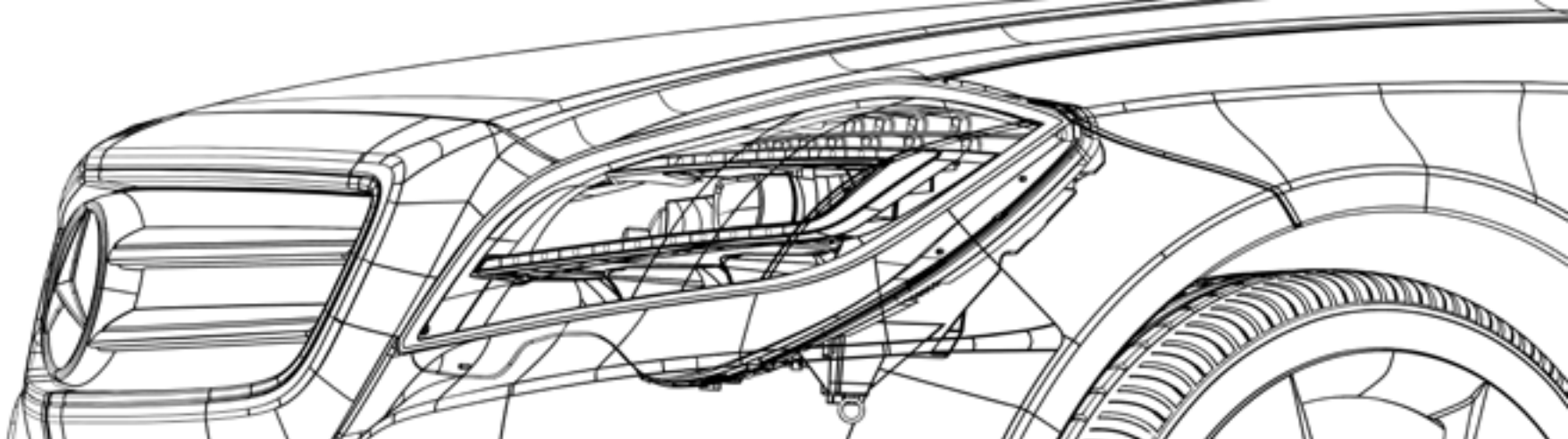

Facts

Efficiency and enjoyment: BlueEFFICIENCY, diesel and petrol engines, transmissions and suspension.

Engines and suspension | from page 29

Integrated safety in the CLS: safer driving, anticipating danger, protecting occupants and post-crash safety.

Safety | from page 37

Relaxation for the road: lighting, multimedia systems, electronic assistants, seats, space and versatility.

Comfort | from page 41

CLS 63 AMG: exterior, interior and technology, plus AMG Performance Studio.

AMG | from page 51

Your personal CLS: model lines, standard equipment and optional extras, Luxury Package, upholstery and trim, alloy wheels and Retailer-fit accessories.

Equipment | from page 59

More Mercedes-Benz: test drive, Mercedes-Benz Finance and Insurance, Interactive Owner's Manuals, Roadside Assistance and Mercedes-Benz World.

Services | from page 77

CLS in figures: dimensions, paint finishes and technical data.

Facts and finishes | from page 79



What's in a name? How the Shooting Brake came to be

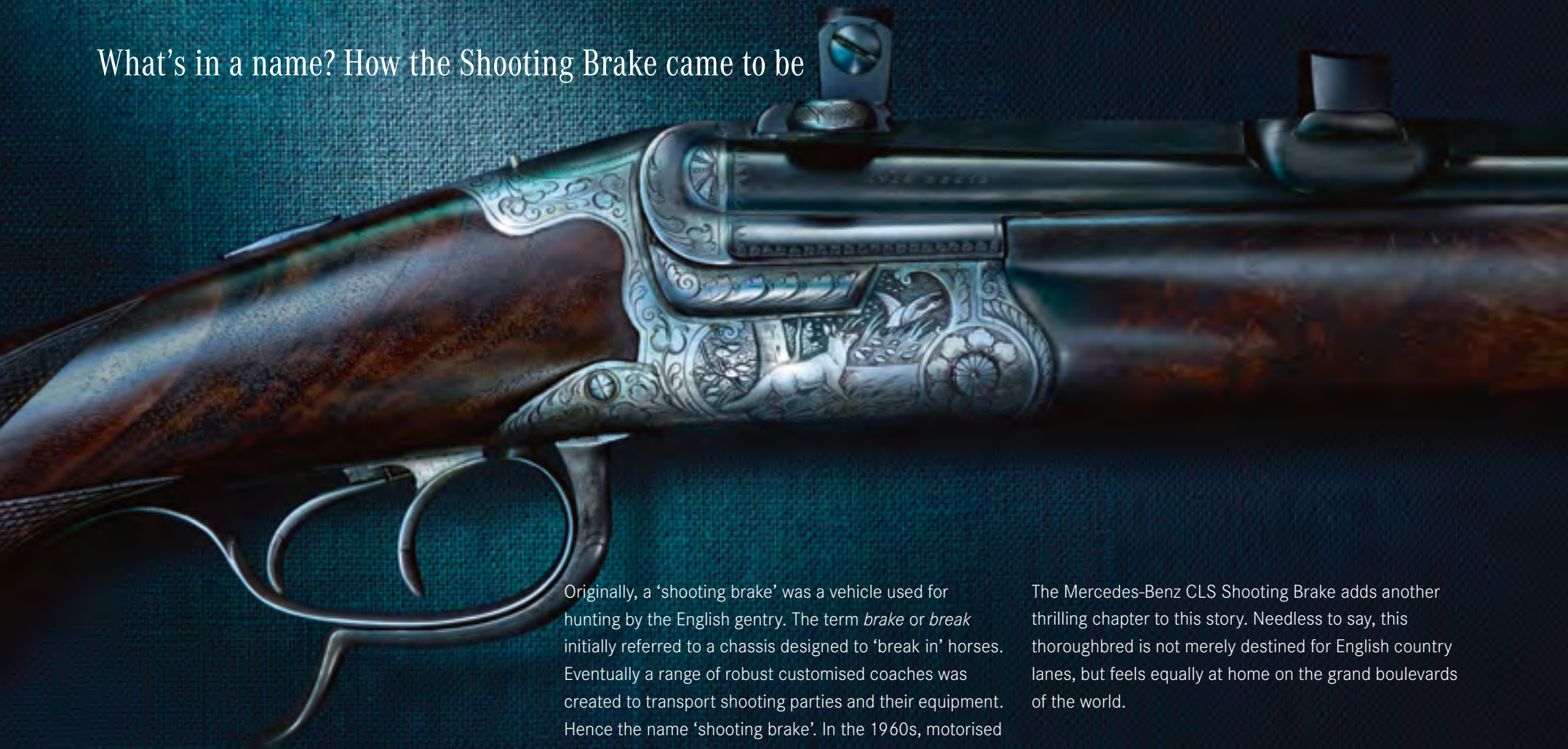

Originally, a 'shooting brake' was a vehicle used for hunting by the English gentry. The term *brake* or *break* initially referred to a chassis designed to 'break in' horses. Eventually a range of robust customised coaches was created to transport shooting parties and their equipment. Hence the name 'shooting brake'. In the 1960s, motorised shooting brakes became very popular in the UK. These were grand sports cars, which offered their well-to-do owners ample space and luxury.

The Mercedes-Benz CLS Shooting Brake adds another thrilling chapter to this story. Needless to say, this thoroughbred is not merely destined for English country lanes, but feels equally at home on the grand boulevards of the world.



A new era never starts with a fad





Stick to convention, and fashion will overtake you. Aim for the status quo, and you'll never surpass it. Build a car without passion, and it won't be one that claws the road like the new CLS Shooting Brake. Get ready for the chase. With agile engines and 7G-Tronic Plus.

Chases corners. Not trends







Is luxury a must, or personal style? Should taste be reflected in a car's trim?
Will double-lapped seams in fine materials make all the difference to your day?
Take a test drive and you'll see: the answer may very well be yes.





Learn a new design language

How do you explain the brand-new, or a category that doesn't quite exist? What do you call a thoroughbred sports car with plenty of luggage space? And how do you describe a car unlike any other? Meet the new CLS Shooting Brake.



Racing line meets performance curve





You're always one step ahead. You're up at the crack of dawn. You dismiss ideas, only to develop new ones. You celebrate success but don't rest on your laurels. Why should you? After all, you have the new CLS Shooting Brake to relax in.





The stuff that powers pioneers

It takes strength to swim against the tide, courage to divert from a well-trodden path and passion to be a pioneer. You'll find all these traits in the new CLS 63 AMG Shooting Brake. It can't wait to share its bold power with you. → Pages 51-58





Everything has its unique space: artists paint in studios, great tenors sing at the opera, motor enthusiasts flock to the racetrack. Your luggage also deserves a special place – like in the optional load space with *designo* open-pore American Cherry wood with Black wood inlays and aluminium rails.





The future has red-green-blue eyes

If the front end of a car is its face, the headlamps are surely its eyes – the windows to its personality. And while traditional bulb-and-reflector systems have prevented designers from creating genuinely individual headlamps, the introduction of LED technology is literally changing the face of car design. LED headlamps not only provide a brighter light and faster reactions than conventional systems; their powerful diodes also open up a whole range of new styling possibilities, allowing for even bolder and more exciting designs (standard on AMG Sport).

In addition, LEDs enhance visibility for the driver. Their light, which is generated by an array of diodes in the additive colours red, green and blue, has a thermodynamic temperature of 5,500 kelvin, the same as that of average noon daylight. As a result, it is easier on our eyes, which have evolved to function best in daylight conditions.



Too breathtaking for words





There are times when it can be hard to keep your emotions in check – such as the moment you first set eyes on the CLS. It's not just the captivating looks that make this four-door coupé so hard to resist. However, there are many rational reasons for choosing a CLS too, some of which you'll find outlined on the following pages. See for yourself – and discover just how prudent following your heart can be.

Rarely have reason and emotion been so closely intertwined





The exterior captures the heart, the interior further strengthens the attraction – caressing your senses with sumptuous leather, fine wood trim and elegant matt silver finishes. Just take a seat. You'll find falling in love has never felt so relaxing. → Pages 67-72





Boosts testosterone levels, cuts emissions





CLS squared

You can't have too much of a good thing, as the CLS AMG Sport proves. It takes all the finest qualities of the regular CLS – and gives you even more of each. Meaning even more striking looks, more generous equipment levels, and sports suspension and braking systems for an even more dynamic drive. → Pages 61–62



Protects the body, stirs the soul

Its beauty is unmistakable, but other CLS attributes are less immediately obvious: such as its ability to help you steer clear of harm. In potentially critical situations, the many electronic safety assistants can make all the difference, helping you to avoid accidents and reducing the risk of injury if the worst should come to the worst. → Pages 59–60



CLS: three letters that make the heart leap







Supportive AMG sports seats, nappa leather upholstery, exceptional comfort: in the CLS 63 AMG, you could almost forget you're in a genuine performance car. For an instant reminder, simply select one of the four driving modes from the AMG Drive Unit and flex your right foot. → Pages 53–56



There are few faster ways to lose your heart than the CLS 63 AMG. The AMG-enhanced exterior is instantly captivating, the acceleration simply breathtaking. You'll be powerless to resist.

→ Pages 51–58

Love at the first set of lights



29 **BlueEFFICIENCY**30 **CLS BlueEFFICIENCY**31 **Diesel engines**

4-cylinder

V6 diesel

33 **Petrol engines**

V6 petrol

35 **Transmission**

7G-Tronic Plus automatic transmission

36 **Suspension**

Direct Control suspension

AirMATIC air suspension

Direct Steering

37 **Integrated safety concept**

Attention Assist

Night View Assist

Lane-Tracking Package

Driving Assistance Package

LED tail lights and adaptive brake lights

Pre-Safe® system

Pre-Safe® Brake

Brake Assist (BAS Plus)

Restraint systems

Neck-Pro front head restraints

Mercedes-Benz Emergency Call System

Post-crash safety

41 **Lighting**

High-performance LED headlamps

LED Intelligent Light System

Bi-xenon headlamps

LED tail lights

43 **Multimedia systems**

COMAND Online system

Audio 20 CD

Becker® Map Pilot navigation system

Harman Kardon® Logic 7® surround

sound system

Bang & Olufsen BeoSound surround

sound system

45 **Electronic assistants**

Speed Limit Assist

Reversing camera

Parktronic with Active Park Assist

47 **Seats**

Memory Package

Dynamic Multi-Contour Seat Package

Individual rear seats

49 **Space and versatility**

Load area

Designer aluminium rails

Easy-Pack load-securing kit

Easy-Pack Quickfold

51 **CLS 63 AMG Exterior**53 **CLS 63 AMG Interior**55 **CLS 63 AMG technology**

AMG 5.5-litre V8

AMG Speedshift MCT 7-speed

sports transmission

AMG sports suspension with

Ride Control

57 **AMG Performance Studio**

59 Model lines

CLS
CLS AMG Sport

63 Luxury Package**65 Standard equipment****66 Optional extras****67 Upholstery and trim****73 Alloy wheels**

Standard wheels
Optional wheels
AMG wheels

75 Retailer-fit accessories**77 Services**

Test drive
Mercedes-Benz Finance and Insurance
Interactive Owner's Manuals
Roadside Assistance
Mercedes-Benz World

79 Dimensions**80 Technical data****82 Paint finishes**

BlueEFFICIENCY – technology for more efficient driving

Comprehensive BlueEFFICIENCY measures have already brought significant cuts in fuel consumption to all our 4-, 6- and 8-cylinder models (G-Class and R-Class excluded), helping to lower both their CO₂ emissions and their running costs. What's more, we are continuing to develop new environmentally friendly technologies that will reduce emissions even further and help to make motoring more sustainable in the long term.

BlueEFFICIENCY – the Mercedes-Benz efficiency drive.

BlueEFFICIENCY models feature a host of measures that can considerably reduce fuel consumption and CO₂ emissions. They include aerodynamic optimisation, low-resistance tyres and intelligent energy management technologies such as the ECO start/stop function, which comes as standard on the majority of our passenger car models. Many of our model ranges also now offer BlueDIRECT V6 or V8 direct petrol injection engines that deliver significantly more power, while helping to cut fuel consumption by up to 25%.

BlueTEC – cleaner diesel power. BlueTEC is our cleanest diesel technology to date. Its combination of advanced

common-rail direct injection, optimised combustion and modular emissions control systems reduces particulate levels by up to 95% and removes up to 90% of nitrogen oxides, leaving little but water and nitrogen.

Hybrid – internal combustion at its most intelligent.

A combination of components working together in perfect harmony, the Mercedes-Benz hybrid drivetrain allies a conventional engine to an electric motor that boosts power when required – during acceleration, for instance – and enables brake energy to be recuperated then fed to the battery. What's more, our latest-generation hybrid models allow you to travel for over half a mile in almost noiseless electric-only mode (at speeds of up to approx. 20 mph) and can 'coast' at higher speeds, by shutting down the combustion engine for maximum efficiency and zero emissions.

Innovative new drivetrain concepts. Mid-2013 will see our second all-electric production car: the new SLS AMG Coupé Electric Drive.¹ With its four synchronous motors, it will bring new levels of performance to electric motoring, delivering 739 hp (551 kW) and 1,000 Nm.

In fact, despite producing zero local emissions, it will be the most powerful AMG road car of all time. One electric Mercedes-Benz that's already hit the road is our hydrogen fuel cell-powered B-Class, a small fleet of which is already being put through its paces in real-world conditions. As a technology leader, Mercedes-Benz will continue to refine and enhance these electric drivetrains and, in conjunction with our cooperation partners, to expand the network of hydrogen filling stations. Our F 125/ F-CELL Plug-In HYBRID, meanwhile, demonstrates the possibilities of innovative zero-emission motoring for luxury vehicles.

Design for Environment. Our environmental philosophy is not just about in-car technologies. It also involves taking the entire lifecycle of each vehicle into account, from its initial planning to its end-of-life recycling. In addition, Mercedes-Benz is involved in the development of alternative fuels and conducts research in the field of bionics.

For more information about what BlueEFFICIENCY can do for you, please visit www.mercedes-benz.co.uk/blueefficiency

¹ SLS AMG Coupé Electric Drive: combined CO₂ emissions: 0 g/km; combined power consumption: 26.8 kWh/100 km; efficiency rating A+
Figures obtained in accordance with the prescribed measuring process (Regulation [EC] 715/2007 in the currently applicable version).

The figures are not based on an individual vehicle and do not constitute part of the product offer; they are provided solely for purposes of comparison between different vehicle models

CLS BlueEFFICIENCY

The CLS combines power and performance with innovative BlueEFFICIENCY measures that help to optimise fuel economy and reduce CO₂ emissions.



Environmental protection and energy conservation are of ever increasing importance, with CO₂ emissions, fuel consumption and the cost of fuel all key issues for today's drivers. Fuel-saving features include:

- 1 Energy-saving oil, water and fuel pumps and speed-sensitive power steering
- 2 Radiator shutter for CLS 250 CDI BlueEFFICIENCY and CLS 350 CDI BlueEFFICIENCY
- 3 Alternator management system with regenerative braking
- 4 BlueDIRECT V6 engine direct petrol injection (Coupé only)
- 5 Air conditioning compressor only active when required
- 6 Optimised aerodynamics (exterior mirror casings, front and rear aprons, underbody)
- 7 ECO start/stop function
(not available for CLS 350 CDI BlueEFFICIENCY Coupé)
- 8 Rolling resistance optimisation (depending on the particular wheel and tyre combination)
- 9 Optimised 7G-Tronic Plus automatic transmission



Diesel engines

Thanks to advanced Mercedes-Benz diesel technology, the refined CLS diesel engines deliver more power and torque than ever, while also achieving greater fuel efficiency and lower emissions.

4-cylinder diesel engine. Despite its comparatively low displacement, the 4-cylinder diesel engine fitted to the CLS 250 CDI BlueEFFICIENCY delivers 204 hp (150 kW) and a maximum 500 Nm of torque. What's more, it is also refined, fuel-efficient and low on emissions.

This impressive blend of qualities is achieved thanks to a combination of advanced technologies. The latest-generation common-rail direct injection system features

optimised combustion chambers, ultra-precise piezo injectors and increased injection pressures of up to 2,000 bar, while two-stage turbocharging and high ignition pressures help to maximise torque at all engine speeds. For enhanced refinement, there are also counter-rotating balancer shafts.

In addition, the CLS 250 CDI BlueEFFICIENCY comes with a range of other fuel-saving features, such as

optimised aerodynamics, ECO start/stop function, and an intelligent alternator that enables kinetic energy to be used to charge the battery when coasting or braking. Also fitted are low-resistance tyres (depending on chosen wheels and tyres combination), on-demand ancillaries and a radiator shutter that reduces drag when the engine requires less cooling.

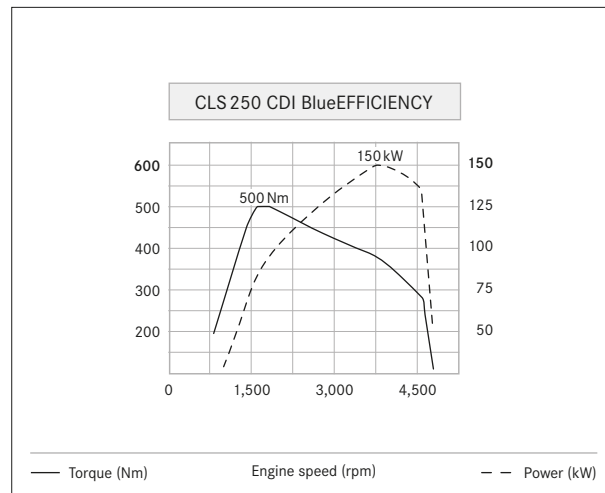

The CLS 250 CDI BlueEFFICIENCY delivers its maximum 500 Nm of torque from just 1,600 rpm



The CLS 250 CDI BlueEFFICIENCY combines pulling power with low fuel consumption and emission levels



The CLS 350 CDI BlueEFFICIENCY, with 265 hp (195 kW) power output

V6 diesel engine. Fitted to the CLS 350 CDI BlueEFFICIENCY, the V6 diesel engine offers an increased output of 265 hp (195 kW) as well as lower fuel consumption than its predecessor. What's more, the fast and precise piezo injectors, high injection pressures of up to 2,000 bar and optimised turbocharger help to deliver a maximum 620 Nm of torque, ensuring exceptional pulling power in any situation.

Despite their impressive performance, the CLS diesels are also high on refinement and low on exhaust emissions, with both the 4- and 6-cylinder models meeting EU5 emissions standards.



Petrol engines

Thanks to state-of-the-art direct injection, our BlueDIRECT petrol engines achieve significantly lower fuel consumption and CO₂ emissions, while offering even more power. The result: cutting-edge engine technology.

V6 petrol engine (Coupé only). With 20% lower fuel consumption, a corresponding reduction in CO₂ emissions and significantly more power, the CLS 350 BlueEFFICIENCY's V6 petrol engine surpasses its predecessor in all departments. Output is now up to 306 hp (225 kW), and there's a maximum 370 Nm of torque available from 3,500 to 5,250 rpm. The key to these impressive improvements is BlueDIRECT petrol injection technology. Thanks to high

injection pressures, piezo injectors and spray-guided combustion, this innovative system delivers effortless and refined performance combined with outstanding economy. Further fuel savings are achieved courtesy of the standard ECO start/stop function, an efficient intake and exhaust system, on-demand ancillaries, intelligent alternator management and the use of lightweight materials.





The CLS 350 BlueEFFICIENCY engine offers superb pulling power in every driving situation



Transmission

The 7G-Tronic Plus 7-speed automatic transmission is perfectly matched to the CLS engines and features ergonomic, intuitive controls.

7G-Tronic Plus automatic transmission (standard).

7G-Tronic Plus is the latest version of our 7-speed automatic transmission. Its seven forward gears ensure the engine is always operating at the optimum speed, helping to increase fuel efficiency, while the ECO start/stop function¹ automatically cuts the engine when the car comes to a standstill. Optimised engine and transmission management software and an improved electrohydraulic control unit deliver even sportier and smoother shifts, and make for faster responses to the accelerator pedal. The transmission is controlled via the Direct Select gear shift lever on the steering column, while steering wheel shift paddles mean you can also change gear manually.



¹ Not available on CLS 350 CDI BlueEFFICIENCY Coupé

7G-Tronic Plus: the result of more than 50 years' experience in automatic transmission technology



Suspension

Be it in sporty driving or relaxed cruising, the CLS is always a pleasure, thanks to suspension systems that adjust the ride and handling automatically to suit the surface and situation.

Direct Control suspension (comfort on CLS, sport-tuned on CLS AMG Sport) adapts automatically to the requirements of the road, ensuring optimum comfort and stability even on poor surfaces, and also allows you to manually select a sportier set-up.

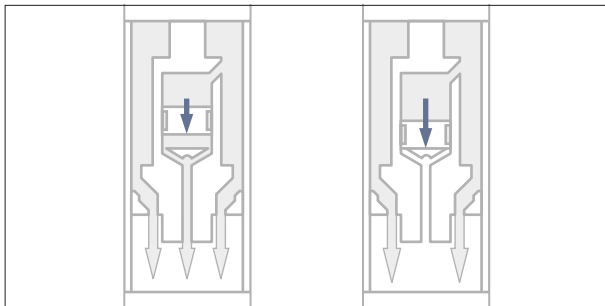

Direct Control suspension adjusts the damping automatically as you drive, ensuring high levels of comfort and agility at all times

AirMATIC air suspension (optional on 6-cylinder models). AirMATIC's Adaptive Damping System continuously adjusts the damping to the road surface and driving situation, enabling it to provide greater ride comfort and safety than a conventional steel spring system. AirMATIC also allows the driver to switch manually between sporty and comfort-orientated settings and automatically lowers the ride height at high speeds, increasing stability, reducing drag and thus improving fuel efficiency.

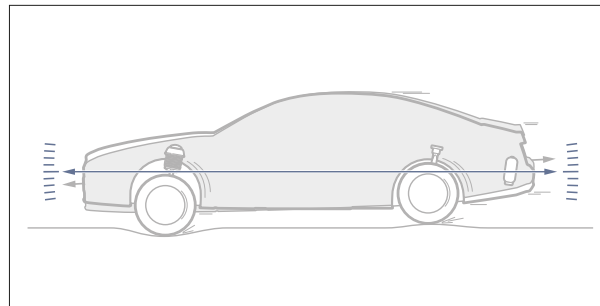

The AirMATIC air suspension system enhances ride comfort, especially on poor surfaces

Direct Steering (standard). By varying the ratio according to the situation and speed, Direct Steering gives you assistance when you need it and feel when you want it. In tight turns or parking manoeuvres, it reduces the amount of steering input required. At higher speeds, on the other hand, it decreases the level of power assistance and ensures inputs are translated less immediately, helping to enhance straight-line stability in faster driving and significantly improving agility. In addition, by only using energy when the situation requires, this speed-sensitive power steering system helps to further improve the car's fuel efficiency.

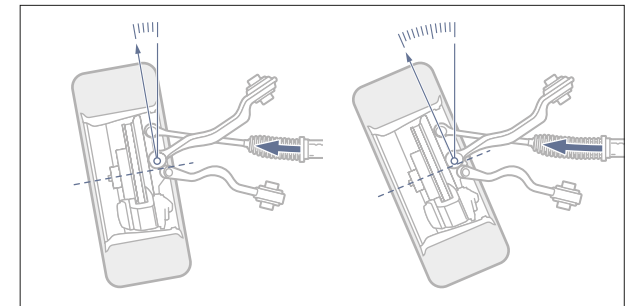

By reducing the amount of steering input required, Direct Steering increases comfort and safety



Integrated safety concept

Like all our passenger cars, the CLS is built according to an integrated safety concept. It combines comprehensive occupant protection with intelligent systems that can help to prevent accidents from occurring.

As the inventor of the motor car, we feel a particular responsibility towards road safety. That's why we were the first manufacturer to develop an integrated safety concept that seamlessly combines a car's active and passive safety features, thus ensuring optimum all-round protection. This concept covers four different areas – safer driving, anticipating danger, protecting occupants and post-crash safety – and incorporates measures designed to maximise safety in every situation, by helping you to stay safe, alerting you to danger, and assisting you wherever possible. In addition, our unique Pre-Safe® anticipatory safety system recognises likely accident scenarios and takes steps that help to further enhance occupant protection. If a collision can't be avoided, intelligent passive safety systems help to provide protection where it's needed, while solutions that can minimise the consequences of an accident and facilitate emergency assistance are also a key part of this safety concept.

A selection of these technologies for the phases 'safer driving', 'anticipating danger', 'protecting occupants' and 'post-crash safety' is presented on the following pages.

Safer driving: Attention Assist (standard). Particularly beneficial on long journeys, Attention Assist is an innovative system for detecting fatigue. Between speeds of approximately 50 and 110 mph, it assesses the driver's behaviour via an array of sensors and registers unexpected changes that may indicate tiredness or concentration lapses, such as involuntary movements of the steering wheel.



If it detects signs of fatigue or concentration lapses, Attention Assist suggests taking a break

Safer driving: Night View Assist (optional). This infrared camera system captures the entire area that would be illuminated on main beam and shows a black-and-white image in the instrument panel. In situations where switching to main beam is not appropriate, Night View Assist gives you a clearer picture of what's ahead and enables you to react faster to potential dangers such as pedestrians or animals in the road.



Night View Assist helps drivers to spot pedestrians by highlighting them on the screen

Safer driving: Lane-Tracking Package (optional). Providing enhanced safety during lane changes, this optional package combines Lane-Keeping Assist and Blind Spot Assist. Lane-Keeping Assist registers lane markings and, if it notices the car wandering out of lane, alerts the driver by subtly vibrating the steering wheel. Blind Spot Assist monitors the driver's blind spots via twin radar sensors in the rear bumper (at speeds of approx. 20 mph or above) and warns of potentially dangerous lane changes.



Active Blind Spot Assist helps you to stay safe during lane changes

Safer driving: Driving Assistance Package (optional). This option package includes DISTRONIC Plus radar-assisted cruise control, Active Lane-Keeping Assist and Active Blind Spot Assist. DISTRONIC Plus helps you to maintain the required distance from the vehicle in front. It applies the brakes automatically (bringing the car to a standstill if necessary) and accelerates again once the situation allows. Thanks to the Pre-Safe® Brake, the system can initiate an emergency stop approx.

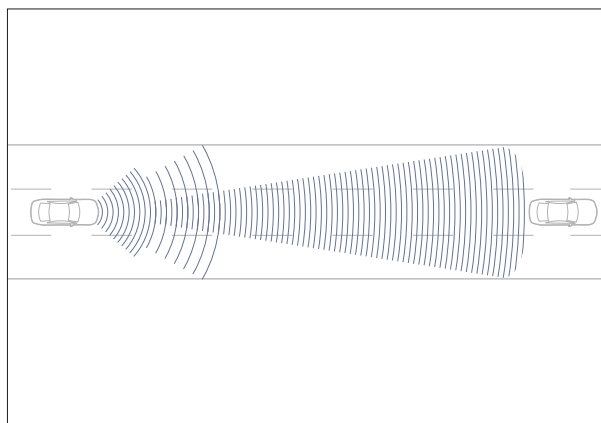

DISTRONIC Plus radar-assisted cruise control can bring the car to a standstill and get you moving again automatically – an advantage in stop/start driving

0.6 seconds before an imminent collision, thereby reducing the severity of the impact. Active Blind Spot Assist warns you of vehicles in one of your blind spots via a symbol in the corresponding exterior mirror. Should you proceed to change lanes despite the subsequent acoustic warning, the system can automatically apply the brakes in order to avoid a collision. Active Lane-Keeping Assist, meanwhile, constantly monitors lane markings and, if it notices the car crossing a solid white line, alerts the driver by gently vibrating the steering wheel. If there's no reaction, the system can apply the brakes in order to prevent the car from coming off the road.

Safer driving: LED tail lights and adaptive brake lights (standard). The tail lights, brake lights and high-level third brake light all feature LEDs that emphasise the car's sporty looks. In addition, the adaptive brake lights flash during emergency braking in order to warn those behind.



Anticipating danger: Pre-Safe® system (standard).

If it detects a probable accident scenario, Pre-Safe® can take anticipatory measures to prepare the occupants for an imminent impact, such as activating the front seat belt tensioners and automatically closing the windows and sunroof (if fitted).

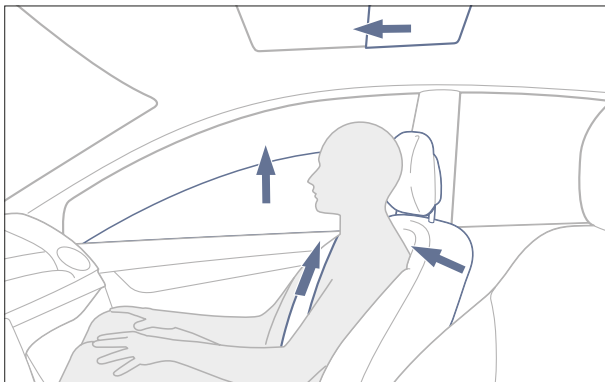

The Pre-Safe® anticipatory occupant protection system can detect critical driving situations and take preventive measures to protect the occupants

Anticipating danger: Pre-Safe® Brake (part of the optional Driving Assistance Package). This three-stage warning and braking system can intervene in the event of a potential collision. If the driver doesn't react to the initial visual and acoustic warning signals, Pre-Safe® Brake activates the brakes as a further warning. If there's still no reaction from the driver, the system then applies maximum braking force in order to reduce the severity of the impact.

Anticipating danger: Brake Assist BAS Plus (part of the optional Driving Assistance Package). BAS Plus works in tandem with the Pre-Safe® Brake to help prevent you from colliding with the vehicle in front. This anticipatory system evaluates driving situations using data from the car's radar sensors and increases braking pressure where necessary, based on the distance to the other vehicle and your relative speeds. If the sensors detect the possibility of a collision and the driver applies the brakes in time, BAS Plus ensures sufficient braking pressure is applied for the available braking distance.

Protecting occupants: restraint systems (standard).

In the CLS-Class, the 3-point seat belts, seat belt tensioners, belt force limiters and airbags are all carefully coordinated so as to keep injuries to a minimum. Up to eight airbags ensure optimum occupant protection, with dual-stage airbags, sidebags and windowbags in the front. In addition, there's a driver's side kneebag and pelvisbag. Sidebags for the rear passengers are also available as an option. If the crash sensors detect an impact, the seat belts are instantly tensed, helping to ensure the occupants remain secure, while the belt force limiter relaxes the belt as the situation allows, in order to prevent undue force being applied to the rib cage.



Protecting occupants: Neck-Pro front head restraints (standard). In the event of a rear-end impact, Neck-Pro front head restraints automatically move forwards and upwards, enabling them to support the head sooner and reduce strain on the spine. In addition, the energy-absorbing front and rear crumple zones, a highly rigid passenger compartment and internally reinforced doors provide highly effective protection, reducing the risk of whiplash injuries in the event of an accident.

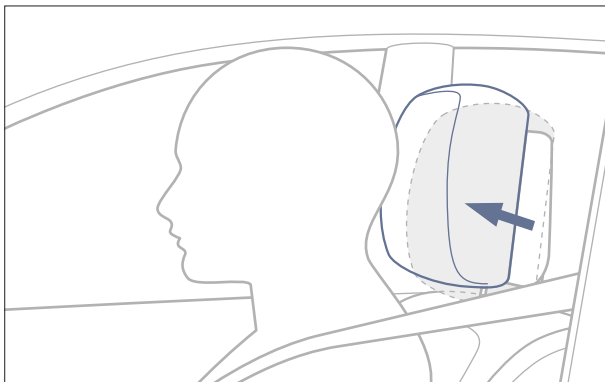

The Neck-Pro front head restraints can significantly reduce the risk of whiplash injuries in the event of a rear-end impact

Post-crash safety: Mercedes-Benz Emergency Call System (part of COMAND Online systems). The system can automatically send an emergency call via an operational telephone connected to the vehicle, as soon as the restraint system detects a collision. The GPS coordinates are sent to the Mercedes-Benz emergency call centre and a speech connection is then set up. The emergency call can also be triggered manually.



The energy-absorbing front and rear crumple zones, a highly rigid passenger compartment and internally reinforced doors provide highly effective protection in the event of an accident

Post-crash safety. Mercedes-Benz has developed a range of measures that help to minimise the secondary consequences of an accident and facilitate occupant rescue. These include automatic engine cut-off, self-activating hazard lights and emergency cabin lighting. In addition, the central locking system is automatically released in the event of an accident, and there are special crash joints between the front doors and wings that make it easier to open the doors after frontal collisions. In addition, Mercedes-Benz provides a rescue guide for emergency services that can be downloaded from the Internet at www.mercedes-benz.co.uk/rescueguide



Lighting

Good visibility in the dark increases your safety and makes for a more relaxing drive. That's why the CLS headlamps are now brighter than ever and can even adapt to changes in the road.



High-performance LED headlamps (optional, standard on AMG Sport and CLS 63 AMG). The CLS presents a world first for a Mercedes-Benz: dynamic high-performance LED headlamps. Together with distinctive C-shaped LED parking lights, these innovative and highly striking headlamps lend the CLS a truly unmistakable look by night. LEDs also create a brighter light, use less power and last longer than conventional headlamps. What's more, they are also easier on the eye, their thermodynamic temperature of 5,500 kelvin being closer to daylight than that of xenon headlamps. LED daytime running light strips in the front apron are standard on all CLS models.

The optional high-performance LED headlamps with C-shaped parking lights lend the CLS a truly unique night-time look



LED Intelligent Light System (fitted in conjunction with optional high-performance LED headlamps). The CLS is the first car to offer LED headlamp technology in combination with all five functions of the Intelligent Light System: country mode, motorway mode, enhanced fog lamps, cornering light, and the Active Light System. Also included is Adaptive High Beam Assist. It maximises the range of the headlamp beams without dazzling oncoming traffic.

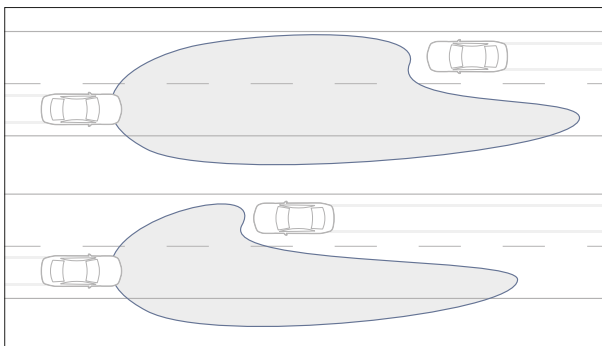

Adaptive High Beam Assist adjusts the range of the headlamp beams according to the position of oncoming vehicles

Bi-xenon headlamps (standard on CLS). Compared with conventional headlamps, the standard bi-xenon headlamps produce a brighter light and illuminate a broader section of the road when on dipped, while offering a considerably greater range on high beam. In addition, their sensor-controlled dynamic range adjustment function compensates automatically for braking or acceleration, adjusting the angle of the beams accordingly.



Bi-xenon headlamps with LED daytime running lights are fitted as standard

LED tail lights (standard). The tail light clusters feature LED technology and a wraparound design, giving the rear end a distinctive look, day or night. The brake light graphics correspond to those of the tail lights, with the brightness of the LEDs increasing significantly during braking.



Standard LED tail lights lend the rear a highly distinctive look



Multimedia systems

The CLS offers a choice of two high-quality entertainment and navigation systems: Audio 20 CD with Becker® Map Pilot and COMAND Online. Both can be operated via the controller in the centre console or the multi-function steering wheel – or by using Linguatronic voice control.



COMAND Online system combines audio, navigation and communication in one multimedia system. Its key functions can also be operated via Linguatronic voice control

COMAND Online system (optional, standard on V6 models and CLS 63 AMG). The COMAND Online system combines hard drive navigation with entertainment features such as a single CD/DVD drive, a tuner, Media Interface and 10 GB of storage for audio files. External data devices and telephones can be connected via the aux-in connection, SD memory card slot and Bluetooth® interface. The online feature allows access to the Internet and various mobile services via an Internet-enabled mobile phone. COMAND Online is operated either using the intuitive controller in the centre console or via Linguatronic voice control, with all menus and maps shown on a high-resolution 7-inch colour display. In addition, free map updates are available for the COMAND Online navigation system from your Mercedes-Benz Retailer for the first three years after your car's registration date.



Audio 20 CD (standard on CLS 250 CDI BlueEFFICIENCY). The Audio 20 system features a radio, a 6-disc CD changer with MP3 playback, aux-in socket and USB port, and a Bluetooth® interface for hands-free mobile telephony. It also comes with a 5.8-inch TFT display and can be operated remotely via the multi-function steering wheel.



For a swift arrival at your destination: Audio 20 CD with Becker® Map Pilot

Becker® Map Pilot navigation system (standard on CLS 250 CDI BlueEFFICIENCY). Combined with Becker® Map Pilot, the Audio 20 CD sound system functions as your in-car navigation system. The GPS and computer unit can simply be installed in your glove compartment and easily removed when required. Map data updates are available via Internet downloads.

Harman Kardon® Logic 7® surround sound system (optional). With its subwoofer, 9-channel DSP amplifier and 3D spatial sound, this 14-speaker system delivers first-class audio quality. The 610-watt Dolby Digital 5.1 system is specially tailored to the CLS interior and can be combined with the Audio 20 CD or COMAND Online system. It features speed-sensitive volume adjustment for optimum clarity and enjoyment at all times.

Bang & Olufsen BeoSound high-end surround sound system (optional). This surround sound system ensures the finest listening experience, with 14 performance speakers in the CLS Shooting Brake and 15 performance speakers in the CLS Coupé. A newly developed 1,200-watt DSP amplifier also adds to the sophisticated 3D spatial sound. The sound can be individually adjusted throughout the cabin using microphone-controlled sound adjustment software for ultimate clarity and premium enjoyment.



Concert-hall feeling: 14 or 15 speakers are combined with a 1,200-watt DSP amplifier in the Bang & Olufsen BeoSound high-end surround sound system



Electronic assistants

A good assistant is one that makes your life easier. Speed Limit Assist, for instance, keeps you informed of the legal limit whatever the road, while Parktronic with Active Park Assist and the reversing camera make for safer and easier manoeuvring.



Speed Limit Assist recognises and displays temporary speed restrictions

Speed Limit Assist (optional; only in conjunction with COMAND Online system). A camera in the front windscreen enables Speed Limit Assist to recognise speed limits and display them in the instrument panel. The camera detects round speed limit warnings both on roadside signs and in overhead gantries and is particularly useful in areas where the speed limit varies or when passing through roadworks. In addition, it compares speed limit signs with the data from the navigation system – when entering or leaving built-up areas, for instance – and shows you whether your current speed is within the legal limit.



Reversing camera (optional; only in conjunction with COMAND Online system). The reversing camera makes for safer and easier parking manoeuvres. Fitted below the boot lid handle, this wide-angle camera captures the area immediately behind the car and displays the image on the COMAND Online system's screen. The camera is activated automatically as soon as the driver engages reverse.



With the reversing camera, the COMAND Online display shows you what's immediately behind the car when manoeuvring

Parktronic with Active Park Assist (standard). With Active Park Assist, the CLS can find parking spaces for you and even manoeuvre itself into them. It identifies a suitable space, then asks you to confirm whether you wish to proceed. Once you've come to a standstill and engaged reverse, the system simply steers you in, manoeuvring so precisely that it requires a gap just 1.30 metres longer than the car.



Active Park Assist displays the status of the parking manoeuvre in the instrument panel

Active Park Assist measures the distance to the vehicles in front and behind using the ultrasound Parktronic sensors in the bumpers. An electronic control unit then processes the ten different sensor signals in order to calculate the ideal entry angle.



Seats

With the CLS, exterior and interior are perfectly matched, thanks to a cabin that's luxurious, distinctive and highly individual.



The dynamic multi-contour front seats provide optimum comfort, ergonomics and safety

The CLS interior echoes key design themes from the car's exterior. The door centre panels, for instance, mirror the distinctive arc of the roof line, while the dashboard sweeps elegantly around from the centre console to meet the upper door trims, giving the front seat occupants a cosseted feel. Elegant top-stitching and high-quality materials such as real leather and fine wood trim further enhance the air of luxury.

Memory Package (optional, standard on CLS 63 AMG). The Memory Package increases comfort and convenience for those in the front and is particularly useful if the car is often used by more than one driver. It enables the front seats, head restraints, steering column and exterior mirrors to be adjusted via separate control panels left and right and allows up to three different seat positions to be stored. The package also includes electric 4-way lumbar adjustment, ensuring front seat occupants enjoy just the right amount of lower back support.



Dynamic Multi-Contour Seat Package (optional).

The dynamic multi-contour front seats give you even greater levels of comfort. Their contours can be adjusted to suit each individual occupant via the seat controller, while the massage function helps to relax tired backs on longer journeys. The package also includes Neck-Pro comfort front head restraints.



The dynamic multi-contour front seats offer a massage function and active adjustment as you drive

Individual rear seats (standard). The colours, materials and design of the CLS seats lend a genuinely exclusive look and feel to its cabin. That goes for the rear too, where passengers enjoy the luxury of individual seats separated by a rear centre console with folding armrest. A distinctive four-rib upholstery design front and rear further enhances the air of sporty elegance. In the CLS Shooting Brake, the rear centre console is replaced with a fifth seat.



The individual rear seats of the CLS Coupé provide high levels of comfort for two



Space and versatility

Elegance from start to finish: even the load area is fitted to the highest standard.



The load area floor in *designo* open-pored American Cherry wood with Black wood inlays and aluminium rails (optional on Shooting Brake only)

Load area. Your luggage travels beautifully in the CLS Shooting Brake, especially if you choose *designo* open-pore American Cherry wood with Black wood inlays. The load area blends harmoniously with the overall interior, featuring the finest materials and exclusive details like shoulder line trim with top-stitching.

Of course, beauty goes hand-in-hand with functionality and comfort. Nets on either side help you keep your items neat and tidy. The Easy-Pack automatic powered tailgate is also standard on the CLS Shooting Brake. For comfortable loading and unloading, it can be opened at the touch of a button.



Designer aluminium rails (optional on CLS Shooting Brake only). Exclusive atmosphere meets innovative thinking: the aluminium rails prevent luggage from sliding onboard the CLS Shooting Brake.



Stylish aluminium rails are available as an option (Shooting Brake only)

Easy-Pack load-securing kit with rear sill protector (optional on CLS Shooting Brake only). The Easy-Pack load-securing kit comprises a telescopic bar and a retractable cargo belt. The bar can be fixed at any position along the floor-mounted cargo rails to create different cargo zones. The cargo belt helps keeping circular or awkwardly shaped items in place.



The load area with optional Easy-Pack load-securing kit (Shooting Brake only)

Easy-Pack Quickfold (standard on CLS Shooting Brake, optional on CLS-Coupé). A lever either side of the seats allows you to fold down one or both sections of the rear seats in an instant. This creates up to 1,550 litres of luggage volume. The load area also features a handy 12 V socket for electronic devices.



Folding in an instant: the 1/3:2/3 split rear seats



CLS 63 AMG exterior

For car fans the world over, AMG means state-of-the-art technology, exclusivity and, above all, performance. The CLS 63 AMG offers all three in abundance – and captures hearts even at a standstill.

With its unique combination of elegance and sports car presence, the CLS 63 AMG's dramatic styling is guaranteed to set the pulse racing, on both Coupé and Shooting Brake. The front end features wider wheel arches, a striking single-bar grille and a muscular AMG

front apron with special LED daytime running lights integrated into the front air intakes, while even the bonnet boasts an AMG-specific design. At the rear, the impression of power is further underlined by a diffusor-style AMG apron with integral fog lamp and an AMG

sports exhaust system with chromed twin tailpipes on each side. The finishing touch is provided by burnished 19" AMG triple-spoke alloy wheels in Titanium Grey.



CLS 63 AMG high-performance LED headlamps



AMG sports exhaust system with two sets of chromed twin tailpipes



19" AMG triple-spoke alloy wheels





AMG styling adds to the dynamic presence of both CLS Coupé and Shooting Brake



CLS 63 AMG interior

You can't have too much of a good thing, as the CLS 63 AMG proves. It takes all the finest qualities of the regular CLS – and gives you even more of each. That means even more striking looks, even more generous equipment levels, and sports suspension and braking systems for an even more dynamic drive.

At AMG, it's not just the engineering that's beautifully crafted. The CLS 63 AMG interior, for instance, features only the finest finishes, combined with an exceptionally sporty look. The ergonomic AMG sports seats are upholstered in nappa leather, the interior trim comes in exclusive Black Piano Lacquer and there's brushed

stainless steel for the AMG door sills and the AMG sports pedals, which also feature grippy rubber studs. The high-performance character is further emphasised by the AMG Drive Unit. This transmission console not only houses the E-Select shift lever, it also contains the controls for the driving modes, the ESP® system and the

suspension set-up. It's complemented by a flat-rimmed 3-spoke AMG Performance steering wheel with silver aluminium gear shift paddles, behind which lies an AMG instrument panel with a special AMG menu and Racetimer function. An exclusive IWC-designed analogue clock adds an extra touch of refinement.



The AMG Performance steering wheel and AMG instrument panel



The heart of the cockpit: the AMG Drive Unit



The optional Bang & Olufsen BeoSound AMG high-end surround sound system





The CLS 63 AMG's cabin combines luxurious materials with sporty style; shown here with optional comfort-ventilated seats, AMG Luxury Package and Harman Kardon® Logic 7® surround sound system



CLS 63 AMG technology

With its AMG 5.5-litre V8 and AMG Speedshift MCT 7-speed sports transmission, the CLS 63 AMG delivers exhilarating performance and optimum efficiency – and even lets you tailor the drive to your mood.

AMG 5.5-litre V8. The CLS 63 AMG offers breathtaking performance coupled with remarkable efficiency, thanks to an AMG V8 that delivers up to 557hp (410kW) and 800Nm of torque with optional AMG Performance Package Plus (Coupé only) as well as a typically muscular sound. The comparatively low fuel consumption is achieved courtesy of a range of innovative technologies, including direct petrol injection with spray-guided combustion, twin turbochargers, intelligent alternator management and the Controlled Efficiency driving mode with ECO start/stop function.

AMG Speedshift MCT 7-speed sports transmission.

The AMG Speedshift MCT transmission combines the best of both worlds, blending the sporty, direct and involving feel of a manual transmission with the comfort and effortlessness of an automatic. In addition to Race Start and automatic throttle-blipping, it offers a choice of three different shift styles. Its Comfort ('C') mode makes

for more fuel-efficient driving, while Sport ('S'), Sport Plus ('S+') and Manual ('M') all maximise performance, allowing for shift times of less than 100 ms by shutting off individual cylinders on upshifts. The use of a compact wet start-up clutch instead of a conventional torque converter means accelerator inputs ensure optimum traction and are translated more directly.



With a choice of different driving modes, the AMG Speedshift MCT 7-speed sports transmission lets you tailor the drive to your mood



AMG sports suspension with Ride Control. The AMG sports suspension's wider front axle significantly enhances lateral dynamics, while the electronically controlled rear wheel damping switches instantaneously between maximum agility and optimum comfort. The Ride Control system offers a choice of 'Comfort', 'Sport' and 'Sport Plus' modes, enabling different

suspension settings to be selected manually. In addition, the driver can determine the level of support provided by the car's ESP® system – by selecting either 'on', 'off' or 'sport'.

The AMG sports parameter steering offers exceptionally precise turn-in, while the AMG high-performance composite brakes ensure outstanding stopping power and wear resistance, thanks to highly durable race-honed materials, 360 mm discs and large 6-piston front calipers.



The AMG sports suspension with Ride Control offers variable settings



AMG sports parameter steering



AMG Performance Studio

With high-performance components and individual styling options, the AMG Performance Studio lets you create an even more exhilarating CLS 63 AMG.

The AMG Performance Package Plus from the AMG Performance Studio adds extra muscle to your CLS 63 AMG (Coupé only). It includes a carbon fibre engine cover and boot lid spoiler, red-painted AMG brake calipers and an AMG Performance steering wheel with Alcantara® inserts – plus an engine upgrade that increases output to 557hp (410kW) and maximum torque to 800 Nm. For those who want yet more performance,



The AMG Performance steering wheel with Alcantara® trim

the optional AMG Driver's Package lifts the electronically limited top speed to 186 mph (includes attendance at an AMG 'Power & Passion' driving event).

The Coupé driving experience can be further enhanced with options such as AMG Ride Control Performance suspension featuring even sportier settings in all three suspension modes and a traction-boosting AMG rear



AMG high-performance ceramic composite brakes

locking differential. The AMG high-performance ceramic composite braking system with eye-catchingly painted calipers, meanwhile, achieves a 40% weight-saving and offers precise pedal feel, shorter stopping distances and a considerably longer service life.

If it is solely the carbon-fibre design elements you desire, the AMG Exterior Carbon-Fibre Trim Package with carbon-fibre trim on exterior mirrors, front apron deflectors and a rear apron diffuser element is available as a separate option. Further options include AMG interior carbon-fibre trim and AMG illuminated door sills.





Dramatic even at a standstill: the CLS 63 AMG Coupé with AMG Performance Package Plus



CLS

With its generous equipment levels and luxurious appointments, the CLS makes for an exceptionally relaxing drive, while the 5-seater CLS Shooting Brake offers even more spacious comfort. Its standard Parktronic system with Active Park Assist can find your parking space for you and even steer you in with the utmost precision. The CLS also offers a range of innovative safety technologies as standard, including Attention Assist, the Pre-Safe® anticipatory safety system, LED tail lights and Neck-Pro adjustable front head restraints.

Exterior

18" alloy wheels – 5-spoke design, 255/40 tyres

Bi-xenon headlamps with LED daytime running lights

Direct Control – comfort suspension

Easy-Pack automatic powered tailgate (Shooting Brake only)

Exhaust system – exposed twin tailpipes with trapezoidal chrome trim

Metallic paint

Parktronic with Active Park Assist

Radiator grille with twin louvres – chrome

Interior

Becker® Map Pilot navigation system (CLS 250 CDI BlueEFFICIENCY only)

COMAND Online system with Media Interface (all V6 engines)

DAB digital radio tuner

Easy-Pack Quickfold – rear seats split folding 1/3:2/3 (Shooting Brake only)

Nappa leather-trimmed steering wheel





Model shown with optional high-performance LED headlamps



CLS AMG Sport

The AMG Sport model lends a more muscular edge to those striking CLS lines. In addition to the instantly recognisable single-bar grille, it features AMG bodystyling, highly distinctive all-LED headlamps, and a sports exhaust system with twin chromed tailpipes integrated into the AMG rear apron. For a dramatic finishing touch, there are 19" AMG 5-spoke alloy wheels. Inside, you'll find a flat-rimmed 3-spoke multi-function sports steering wheel with nappa leather trim and black gear shift paddles, floor mats with 'AMG' insignia, and stainless steel sports pedals with rubber studs.



Exterior

19" AMG alloy wheels – 5-spoke design, 255/35 front tyres, 285/30 rear

AMG bodystyling – front and rear aprons

Direct control – sport-tuned suspension with unique damping system

LED Intelligent Light System with LED headlamps and Adaptive High Beam Assist

Radiator grille with single louvre – chrome

Sport braking system with perforated front brake discs

Interior

AMG 3-spoke multi-function sports steering wheel in nappa leather

AMG floor mats

Black roof lining with Black leather upholstery

DAB digital radio tuner

Manual mode for 7G-Tronic Plus automatic transmission

Stainless steel sports pedals with rubber studs





Luxury Package

With first-class materials and finishes, the optional Luxury Package lends an even more exclusive look to the CLS interior.

The optional Luxury Package adds Exclusive Passion leather upholstery for the seats, plus nappa leather for the armrests, head restraints, centre console, upper door trims and dashboard. The roof lining, pillar trims and sun

visors all feature soft Dinamica microfibre. The package also includes velour floor mats with nubuck trim in your chosen interior colour as well as ambient interior lighting with a choice of three colour settings.

A wood- and leather-trimmed steering wheel is available as an additional option.



Ambient interior lighting



Upper dashboard with nappa leather trim



Optional wood- and leather-trimmed steering wheel





The optional Luxury Package includes Exclusive Passion leather upholstery and a nappa leather-trimmed upper dashboard



Standard equipment | Selection



3-spoke multi-function steering wheel in nappa leather



Audio 20 CD with Becker® Map Pilot navigation system¹



COMAND Online with 7-inch colour display



Bi-xenon headlamps, shown switched off

¹CLS 250 CDI BlueEFFICIENCY only



Easy-pack automatic powered tailgate (Shooting Brake only)



LED tail lights



Optional extras | Selection



Ambient interior lighting with choice of three colours



Reversing camera



Keyless-Go (including start/stop button)



High-performance LED headlamps with LED daytime running lights²

²Standard on AMG Sport and CLS 63 AMG



Privacy glass from B-pillar rearwards (Shooting Brake only)



Electric glass sunroof



Upholstery and trim





The Black interior scheme features Black leather upholstery, with matching steering wheel trim, pillar trims and roof lining, plus Black Ash wood trim as standard. As an option, this colour scheme is also available with either Passion leather or the Luxury Package featuring Exclusive Passion leather. The latter includes nappa leather for the upper dashboard, armrests, head restraints, upper door trims and centre console.

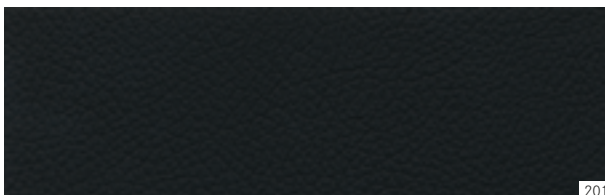

201



H19



731

801
501

736



H21

Black

201 (211) Leather (AMG Sport)

801 (811) Passion leather (AMG Sport)¹501 (511) Exclusive Passion leather (AMG Sport)^{1,2}

Trim

H19 Light Brown Poplar wood, matt finish¹731 Brown Burr Walnut wood, gloss finish¹

736 Black Ash wood, gloss finish

H21 Black Piano Lacquer¹

¹ Optional ² Only available as part of optional Luxury Package



The Almond Beige interior scheme features Almond Beige leather upholstery, with matching steering wheel trim, roof lining and pillar trims, plus Black Ash wood trim as standard. As an option, this colour scheme is also available with either Passion leather or the Luxury Package featuring Exclusive Passion leather. The latter includes nappa leather for the upper dashboard, armrests, head restraints, upper door trims and centre console.

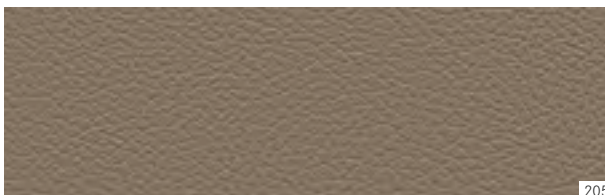

205



H19

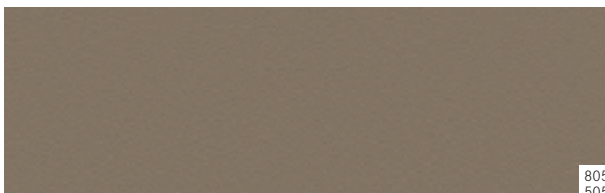

731

805
505

736



H21

Almond Beige

- 205 Leather
- 805 Passion leather¹
- 505 Exclusive Passion leather^{1,2}

Trim

- H19 Light Brown Poplar wood, matt finish¹
- 731 Brown Burr Walnut wood, gloss finish¹
- 736 Black Ash wood, gloss finish
- H21 Black Piano Lacquer¹

¹ Optional ² Only available as part of optional Luxury Package





The optional Aubergine interior scheme features Aubergine leather upholstery, with matching lower dashboard trim, front and rear centre console, door centre panels, armrests, plus Black Ash wood trim as standard. The steering wheel trim, roof lining and pillar trims come in contrasting black. As an option, this colour scheme is also available with either Passion leather or the Luxury Package featuring Exclusive Passion leather. The latter includes nappa leather for the upper dashboard, armrests, head restraints, upper door trims and centre console.

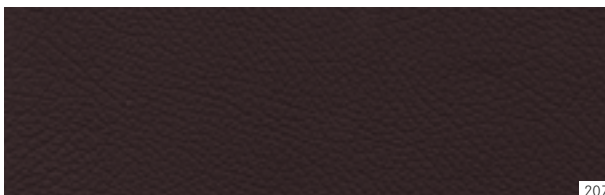

207



H19

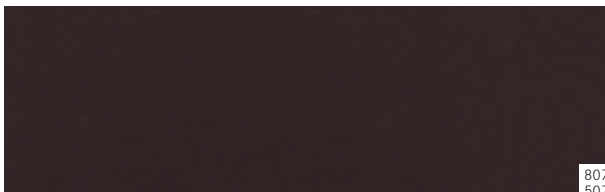

731

807
507

736



H21

Aubergine¹

207 Leather

807 Passion leather¹507 Exclusive Passion leather^{1,2}

Trim

H19 Light Brown Poplar wood, matt finish¹731 Brown Burr Walnut wood, gloss finish¹

736 Black Ash wood, gloss finish

H21 Black Piano Lacquer¹

¹ Optional ² Only available as part of optional Luxury Package



The Alpaca Grey interior scheme features Alpaca Grey leather upholstery, with matching roof lining and pillar trims, contrasting black steering wheel trim, plus Black Ash wood trim as standard. As an option, this colour scheme is also available with either Passion leather or the Luxury Package featuring Exclusive Passion leather. The latter includes nappa leather for the upper dashboard, armrests, head restraints, upper door trims and centre console.

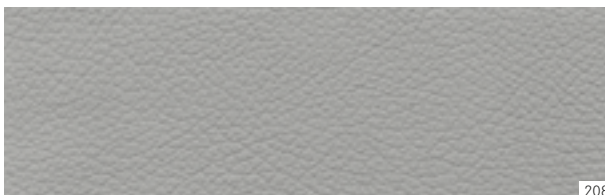

208



H19

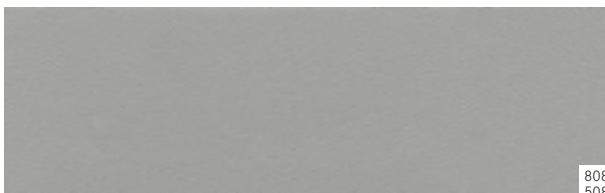

731

808
508

736



H21

Alpaca Grey

208 Leather

808 Passion leather¹508 Exclusive Passion leather^{1,2}

Trim

H19 Light Brown Poplar wood, matt finish¹731 Brown Burr Walnut wood, gloss finish¹

736 Black Ash wood, gloss finish

H21 Black Piano Lacquer¹

¹ Optional ² Only available as part of optional Luxury Package





The optional Porcelain interior scheme features Porcelain leather upholstery for the seats and door centre panels, with the steering wheel, roof lining and pillar trims in contrasting black, plus Black Ash wood trim as standard. As an option, this colour scheme is also available with either Passion leather or the Luxury Package featuring Exclusive Passion leather. The latter includes nappa leather for the upper dashboard, armrests, head restraints, upper door trims and centre console.

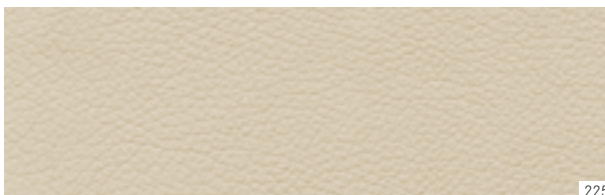

225



H19

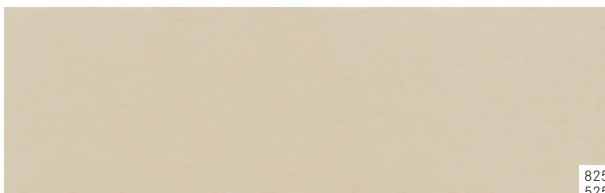

731

825
525

736



H21

Porcelain¹

225 Leather

825 Passion leather¹525 Exclusive Passion leather^{1,2}

Trim

H19 Light Brown Poplar wood, matt finish¹731 Brown Burr Walnut wood, gloss finish¹

736 Black Ash wood, gloss finish

H21 Black Piano Lacquer¹

¹ Optional ² Only available as part of optional Luxury Package

Alloy wheels



18" 5-spoke alloy wheels (standard on CLS, code R96)



18" multi-spoke alloy wheels (optional on CLS, code R34)



19" AMG 5-spoke alloy wheels with burnished Titanium Silver finish (standard on AMG Sport, code 770)



18" 5-spoke alloy wheels (optional on CLS, code R32)



19" 5-spoke alloy wheels (optional on CLS, code R82)



18" AMG 5-spoke alloy wheels (optional on AMG Sport, code D97)





19" AMG 5-triple-spoke alloy wheels, painted in Titanium Grey with high-shine finish (standard on CLS 63 AMG, code 797)



19" AMG 5-twin-spoke forged alloy wheels with polished Titanium Grey finish (optional on CLS 63 AMG, code 793)



19" AMG 10-spoke alloy wheels in matt Black (optional on CLS 63 AMG, code 752)



Retailer-fit accessories

A Mercedes-Benz is not just a car, it's a travel companion that can be tailored to your needs – with our wide range of Retailer-fit accessories.

→ www.mercedes-benz.co.uk/accessories



Rear seat entertainment system. Featuring two crystal-clear 7-inch LCD colour screens with separate DVD players, the rear seat entertainment system not only allows back seat passengers to watch films together, it also enables one to enjoy a movie while the other listens to a CD, or plays games via an external console. In addition, there's a USB port and an SD memory card slot for connecting other types of storage media. As with all our accessories, the rear seat entertainment system meets the very highest standards of occupant safety. It requires no factory-fit prewiring and can be retrofitted by your Mercedes-Benz Retailer.

The rear seat entertainment system ensures those in the back enjoy every mile too



Alloy wheels. The highly striking Retailer-fit wheels further enhance the head-turning looks of your CLS. They come in a variety of sizes and styles, including a 19" 10-spoke design that features a black burnished finish.



Alloy wheels with black burnished finish

Door sills. Protects and creates a stylish entry: the illuminated brushed stainless steel door sills reveal the Mercedes-Benz lettering in a white glow.



Illuminated door sills with 'Mercedes-Benz' lettering

These are just a few of the many attractive Retailer-fit accessories available for your CLS. For more details about the full CLS accessories range, please see the relevant brochure or talk to your local Mercedes-Benz Retailer.



Services

Test drive. Words can only do so much. Some things have to be experienced to be truly appreciated. Which is why we'd like to invite you for a test drive. Feel the power of efficient engines that offer impressive fuel consumption. Feel exhilarated by precise steering, designed to connect the driver with the road and enjoy sumptuous levels of comfort. Your Mercedes-Benz Retailer will be happy to make arrangements for you to experience the things that set a Mercedes-Benz apart. Alternatively, to request a test drive online simply visit www.mercedes-benz.co.uk/testdrive. We look forward to seeing you.

Mercedes-Benz Finance. At Mercedes-Benz Finance, our single-minded aim is to provide optimum financial solutions for all those who share the Mercedes-Benz philosophy of absolute commitment to quality. Whether you are a private customer or a business user, our finance and leasing packages can be tailored to meet your individual needs. For further information on Mercedes-Benz Finance, please contact your local Mercedes-Benz Retailer.



Mercedes-Benz Insurance offers a fully comprehensive 5-star-rated¹ Motor Insurance policy specifically designed to provide the cover you would expect from Mercedes-Benz. For a quotation, please call 0845 600 2180².

Interactive Owner's Manuals. The website also offers an interactive tour, enabling you to take a closer look at your desired model. This simulation is the ideal way to acquaint yourself with your dream car. You can view key functions in detail, gain an insight into the car's inner workings or look at the benefits of each model. For further details, visit www.mercedes-benz.co.uk/clsclassmanual or www.mercedes-benz.co.uk/cls shootingbrakemanual.



Roadside Assistance. Rest assured that should you ever need help, Mercedes-Benz Roadside Assistance is there for you. In the unlikely event of a technical breakdown³ you can rely on the Mercedes-Benz Roadside Assistance Team – anywhere in Europe. Simply phone our Customer Assistance Centre on 00800 1 777 7777,⁴ where our specialists will organise assistance for you. Mercedes-Benz will also assist you in the event of a minor mishap preventing you from driving your vehicle³. Whether you lose your key, run out of fuel or your vehicle is damaged due to an accident or vandalism, Mercedes-Benz ensures that you still reach your destination. Often the problem can be rectified on the spot, but if this is not possible, we will naturally ensure that your vehicle is taken to the nearest Mercedes-Benz Official Workshop to get you back on the road as quickly as possible.

¹ As rated by Defaqto, a leading UK independent financial research company.

² Mercedes-Benz Motor Insurance is underwritten by Aviva Insurance Limited. Calls are charged at local rate and may be recorded. We may decline to quote in some circumstances.

Mercedes-Benz World at Brooklands. Celebrate the story of Mercedes-Benz and you'll celebrate the story of motoring itself at Mercedes-Benz World in Surrey. Discover Mercedes-Benz racing heritage, from its connections to the famous Brooklands circuit through to present-day Formula 1™ brought to life in the most sensational way. View, touch and sit in every car from the Mercedes-Benz range, and encounter automotive legends like the 'Gullwing' and many other classic icons, in the UK's largest Mercedes-Benz showcase. Then set your pulse racing by booking one of our thrilling Driving Experiences. Enjoy AMG performance on the purpose-built Handling Circuits or Wet Skid Circle, an axle-twisting off-road adventure, or treat your kids over 1.5 metres tall to their own driving experience in an A-Class or on the off-road terrain in an M-Class.

³ Cover is initially valid for your vehicle for four years from the date of first registration. This can be extended from the fifth year, up to a maximum of 30 years, on completion of each scheduled maintenance service, providing that this service is carried out by a Mercedes-Benz Official Workshop. Minor mishap cover is provided at the absolute discretion of Mercedes-Benz.

And for kids even younger and under 1.3 metres tall, let them be a 'Little Learner' in their own miniature electric version of the desirable Mercedes-Benz SL. For more interactive action, take a virtual 3D journey along the production line in 'Build' and take a seat in the cinema to accelerate from the birth of the car to the latest innovations in 20 eye-opening minutes.

Relax and refuel in Café 1886, or for something more enjoy the delicious menu and elegant surroundings of the Gullwing Restaurant. Finally, extend your visit with a short stroll to Brooklands Museum to see their collection of classic cars, aviation exhibitions – and the legendary Concorde. For more information visit www.mercedes-benzworld.co.uk

⁴ In non-affiliated European countries: +44 20 7975 7077



Dimensions - Shooting Brake

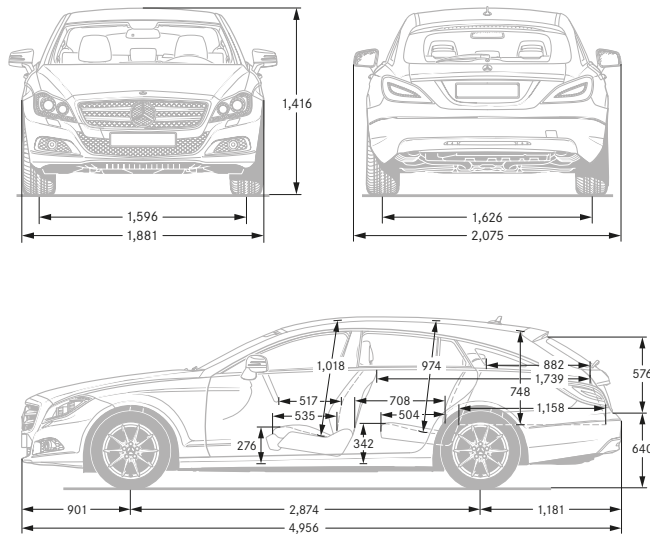

Dimensions - Coupé

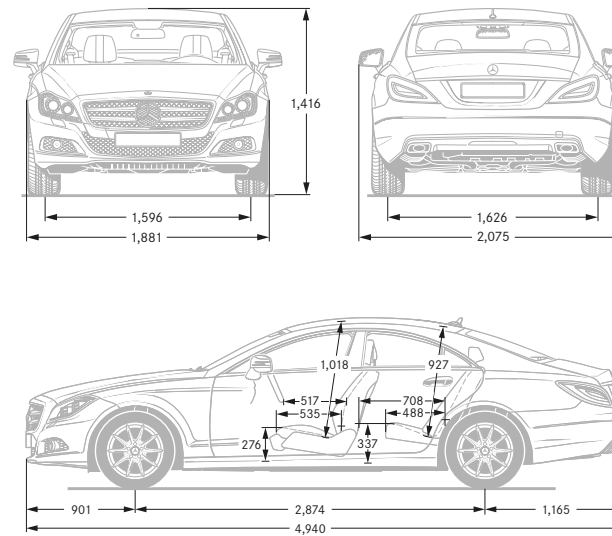

All measurements in millimetres. The dimensions shown are mean values and apply to standard-specification, unladen vehicles



Technical data

Diesel engines

	CLS 250 CDI BlueEFFICIENCY Coupé	CLS 250 CDI BlueEFFICIENCY Shooting Brake	CLS 350 CDI BlueEFFICIENCY Coupé	CLS 350 CDI BlueEFFICIENCY Shooting Brake
Arrangement/cylinders/valves	in-line/4/16	in-line/4/16	V/6/24	V/6/24
Total displacement – cc	2,143	2,143	2,987	2,987
Rated output ¹ – hp (kW) at rpm	204 (150)/4,200	204 (150)/3,800	265 (195)/3,800	265 (195)/3,800
Rated torque ¹ – Nm at rpm	500/1,600–1,800	500/1,600–1,800	620/1,600–2,400	620/1,600–2,400
Acceleration 0–62 mph – sec	7.5	7.8	6.2	6.6
Top speed, approx. – mph	150	146	155 ²	155 ²
Tyre size – front, rear	285/35 R 18	285/35 R 18	285/35 R 18	285/35 R 18
Fuel consumption ³ – mpg				
Urban	44.1	44.8	36.2	38.7
Extra-urban	64.2	60.1	55.4	53.3
Combined	54.3	53.3	46.3	47.1
CO ₂ emissions, combined ³ – g/km	135	139	160	161
EU emissions standard	EU5	EU5	EU5	EU5
Fuel tank capacity/reserve (approx.) – l	59/8	59/8	80/9	80/9
Boot capacity – l	520	590	520	590
Turning circle – m	11.27	11.27	11.27	11.27
Kerb weight ⁴ – kg	1,785	1,865	1,815	1,910
Perm. GVW – kg	2,270	2,390	2,300	2,435

¹Figures according to Directive 80/1269/EEC in the currently applicable version ²Electronically limited ³The figures shown were obtained in accordance with the prescribed measuring process (Regulation [EC] 715/2007 in the currently applicable version).
The figures are not based on an individual vehicle and do not constitute part of the product offer; they are provided solely for purposes of comparison between different vehicle models

Petrol engines

	CLS 350 BlueEFFICIENCY Coupé	CLS 63 AMG Coupé	CLS 63 AMG Coupé (Performance Package Plus)	CLS 63 AMG Shooting Brake
Arrangement/cylinders/valves	V/6/24	V/8/32	V/8/32	V/8/32
Total displacement – cc	3,498	5,461	5,461	5,461
Rated output ¹ – hp (kW) at rpm	306 (225)/6,500	525 (386)/5,250–5,750	557 (410)/5,250–5,750	557 (410)/5,250–5,750
Rated torque ¹ – Nm at rpm	370/3,500–5,250	700/1,700–5,000	800/2,000–4,500	800/2,000–4,500
Acceleration 0–62 mph – sec	6.1	4.4	4.3	4.3
Top speed, approx. – mph	155 ²	155 ²	155 ²	155 ²
Tyre size – front, rear	245/45 R 17	255/35 ZR 19, 285/30 ZR 19	255/35 ZR 19, 285/30 ZR 19	255/35 ZR 19, 285/30 ZR 19
Fuel consumption ³ – mpg				
Urban	30.7	20.3	20.3	20.2
Extra-urban	51.4	37.2	37.2	36.2
Combined	40.9	28.5	28.5	28.0
CO ₂ emissions, combined ³ – g/km	161	231	231	235
EU emissions standard	EU5	EU5	EU5	EU5
Fuel tank capacity/reserve (approx.) – l	80/9	66/14	66/14	66/14
Boot capacity – l	520	520	520	590
Turning circle – m	11.27	11.30	11.30	11.30
Kerb weight ⁴ – kg	1,735	1,870	1,870	1,955
Perm. GVW – kg	2,220	2,415	2,415	2,530

¹Figures according to Directive 92/21/EC, version 95/48/EC (kerb weight with fuel tank 90% full, driver, 68 kg, and luggage, 7 kg) for standard-specification vehicles. Optional extras and accessories will generally increase this figure and reduce the payload capacity accordingly
²Figures relate to engines with standard 7G-Tronic Plus automatic transmission and AMG Speedshift MCT 7-speed sports transmission (CLS 63 AMG)

Paint finishes

The innovative Mercedes-Benz paint system features one of the finest clearcoats on the market and helps your CLS to retain both its looks and its long-term value.

Metallic paints

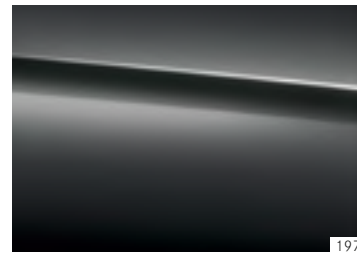

197

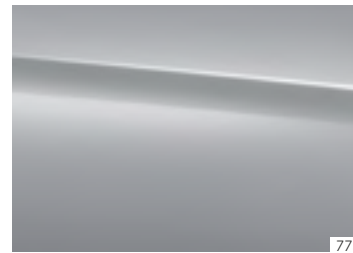

775



799¹

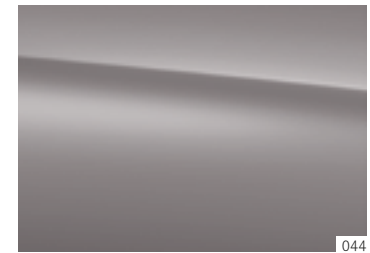

044

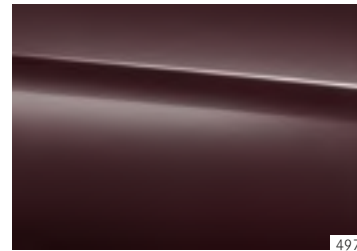

497

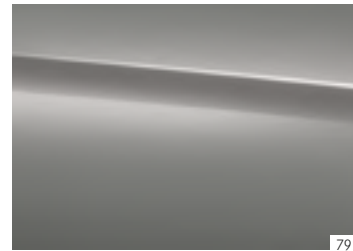

792



890



049

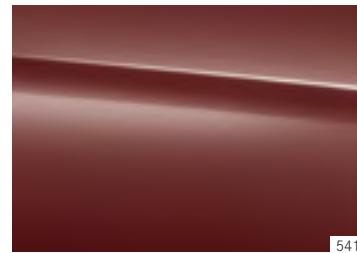

541



794

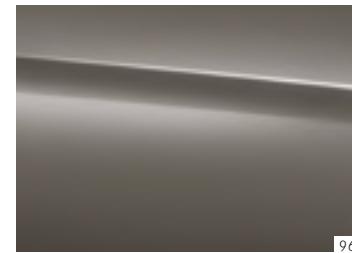

963

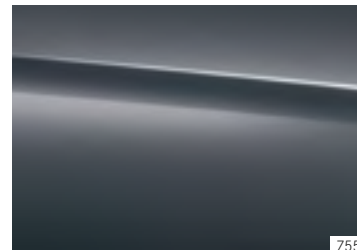

755

Metallic paints

- 197 Obsidian Black
- 497 Cuprite Brown
- 541 Thulite Red
- 755 Tenorite Grey
- 775 Iridium Silver
- 792 Palladium Silver
- 794 Pearl Beige
- 799 Diamond White¹
- 890 Cavansite Blue
- 963 Indium Grey

Special paints¹

- 044 *designo* Magno Allantite Grey
- 049 *designo* Magno Cashmere White

¹ Optional



Take-back of end-of-life vehicles. Coming full circle. At the end of its long life, you can return your CLS-Class to us for environment-friendly disposal in accordance with the EC End-of-Life Vehicle Directive.¹ But that day lies a long way off.

¹Applies in accordance with national regulations to vehicles up to 3.5 tonnes permissible gross weight. The CLS-Class has met the statutory regulations governing the suitability of the vehicle's design for reuse and recycling for a number of years now. A network of vehicle take-back depots and dismantlers has been established which will process your vehicle in an environment-friendly manner. The ways in which both vehicles and parts can be recovered are subject to ongoing development and improvement. Consequently, the CLS-Class will be able to comply with any future increases in the recycling quota within the stipulated time limits. Further information is available at www.mercedes-benz.co.uk or by calling 00800 1 777 7777.

Please note: this online version of the printed brochure may contain abridged copy or other content changes. The manufacturer reserves the right to make changes to the design, form, colour and specification during the delivery period, provided these changes, while taking into account the interests of the vendor, can be deemed reasonable with respect to the purchaser. Where the vendor or the manufacturer uses symbols or numbers to describe an order or the subject of an order, no rights may be derived solely from these. The illustrations may show accessories and items of optional equipment which are not part of standard specification. Colours may differ slightly from those shown in the brochure, owing to the limitations of the printing process. This brochure has been compiled by Daimler AG of Germany and is distributed internationally. It provides a general indication of the range of models, features, optional extras and/or colours available in various countries. Some of the models, features, optional extras and/or colours shown may not be available in your country or may only be available in a different specification. Additionally some models, features, optional extras and/or colours may only be available in combination with others. For current and more specific information in relation to the range of models, features, optional extras and/or colours available in your country, and their pricing, you should contact your nearest authorised Mercedes-Benz Retailer. E&OE. www.mercedes-benz.co.uk

Daimler AG, Mercedesstr. 137, 70327 Stuttgart BC/MC 6701 · 0709 · 88-00/1212

