



S-Class



Mercedes-Benz



Rise to the occasion. The new S-Class

It's time to wake up to a new era of driving, in the utmost comfort and awe-inspiring style. The new S-Class is a unique pleasure to drive, just as it is to be chauffeured in. Filled with the most exquisite materials and fittings, it's where every minute detail is crafted to perfection. And as you'd expect from a car of this stature, the S-Class presents ground-breaking

technology previously unseen in a production car. Take the new suspension system which irons out any road imperfections, or the comprehensive light technology, or the new 360° vision sensors capturing your surroundings like never before. The new S-Class is progress at its most beautiful.



Featured models at a glance:

4 | Mercedes-Benz S 350 BlueTEC

Diamond Silver metallic

AMG Line, 20" AMG multi-spoke alloy wheels, Exclusive Nappa Leather Package in Porcelain/Black, *designo* high gloss Sunburst Brown Myrtle wood trim

12 | Mercedes-Benz S 400 Hybrid L

Magnetite Black metallic

SE Line, 19" 5-twin-spoke alloy wheels, Exclusive Nappa Leather Package in Silk Beige/Espresso Brown, *designo* high gloss Sunburst Brown Myrtle wood trim

19 | Mercedes-Benz S 63 AMG L

Diamond Silver metallic

20" AMG 10-spoke alloy wheels, Exclusive Nappa leather in Black, AMG carbon fibre/Black Piano Lacquer trim

Key innovations:

21 | Intelligent Drive

22 | Stereo camera

23 | Magic Body Control

24 | Seat Comfort Package

25 | LED Intelligent Light System

Equipment options at a glance:

27 | Engines and suspension

33 | Safety

37 | Comfort

51 | AMG

61 | Equipment

79 | Services

81 | Technical data and paint finishes

Images may show accessories or items of optional equipment which are not part of standard specification



The only star that shines at sunrise



When the morning sun begins to play with shadows, contrasts and silhouettes, the S-Class is ready to sparkle: the famous star, proudly placed on the bonnet, signals an unforgettable driving experience.

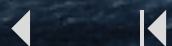

A master of movement, always one step ahead



The perfect life-work balance



The new S-Class blends the boundaries between work and play. Or how would you like a business environment that's so clean and fresh, you'd think you were by the sea – even when surrounded by skyscrapers. Luxury automatic climate control and a subtle fragrance emitted by the new Air-Balance Package take some credit for this.









The S-Class is renowned for excellence. It's something we work hard for, so you can sit back and reap the benefits. Like the flawless materials fitted with the greatest attention to detail: ambient lighting, smooth wood trim or soft leather upholstery – the S-Class has outdone itself once again.



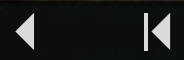



Start a revolution from the comfort
of the Reclining Rear Seat

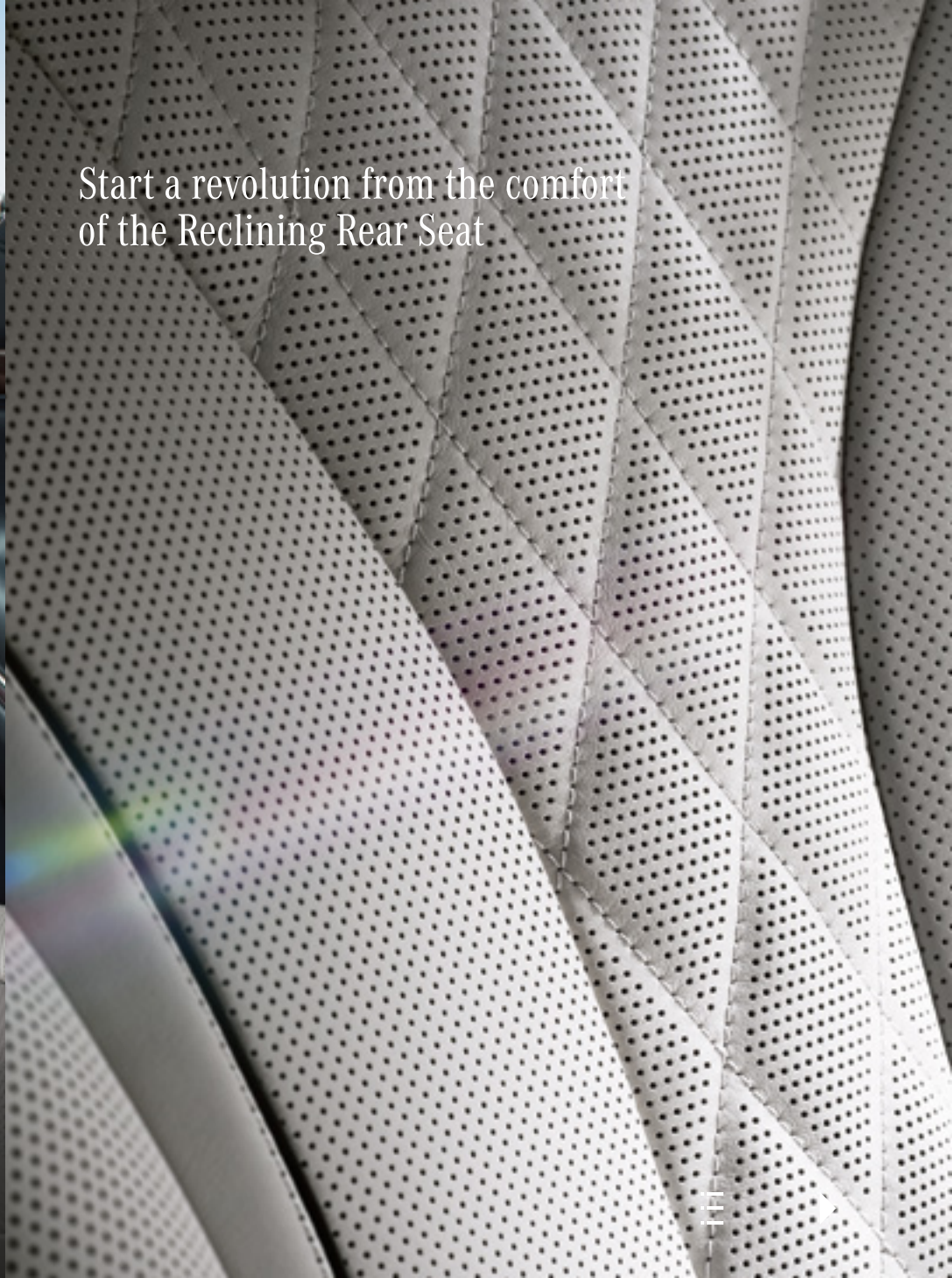

Exuberant in its restraint

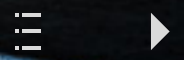



It's time to meet the future: 306hp+27hp (or 225kW+20kW) accomplish the seemingly impossible in the S 400 Hybrid L. Never before has the highest driving comfort been united with such low emissions and consumption levels.



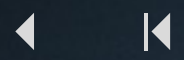



Recharges its batteries when you do - on the move

HYBRID





The new S-Class gives you complete independence, without leaving your side

The vision of autonomous driving has edged one step closer to reality: today, the new S-Class expertly monitors your surroundings with cameras and sensors. All this information is stored by algorithms and processed by the intelligent suspension – for greater safety, comfort and a more dynamic drive.

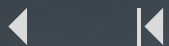

Visionary

As soon as the sun sets, the eyes of the S-Class come to live. LED headlamps work automatically, switching themselves on as and when required. When oncoming traffic is detected they can even be dipped partially to avoid dazzling fellow drivers. As a result, you enjoy the best possible vision and a greater sense of security to boost.





Business will never be
as usual again

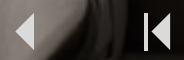

Career propeller





Three letters elevate the S-Class to another level: AMG. They reflect high performance technology inspired by motor racing and intelligent lightweight engineering. The result is a unique blend of luxury saloon and super sports car: the new S 63 AMG. Its choice of materials is equally exquisite. Take carbon, for example, which is mainly used in Formula One racing cars for its light weight yet super-robust characteristics. Precisely fitted and hand crafted, it issues the S 63 AMG interior with its own brand of exclusive athletic styling.



Mercedes-Benz Intelligent Drive. Looking ahead. Thinking ahead

Welcome to the automotive future, already present in the new S-Class. As soon as you grab the steering wheel, this unique saloon connects you with its very own sensory system. The modern interior and exterior monitoring system looks ahead, draws its conclusions and reacts instantly in order to prevent accidents. A stereo camera, highly powerful processors and technical assistants, as well as years of continuous research, are at the centre of this development. Another Mercedes-Benz milestone, offering yet more safety and comfort, it's the next step towards autonomous driving. Of course, the future holds still more scope for research, more possibilities and more great visions.



Because every second counts

Some people say that looking into the future is a futile business. For our research department, however, it offers an exciting challenge. But that's not all. Our engineers are not content with looking ahead. They want to influence the future in order to prevent accidents.

Just imagine the scenario: you are concentrating on the road when suddenly a shadow appears in the corner of your eye. In this case, you'll benefit from years of research featuring technology that scans the area around your car. It sees things that we can at best only guess, and calculates in advance where moving objects will be. A stereo camera system with a three-dimensional (i.e. spatial) view gives the S-Class human-like vision. And it calculates so fast that it can process the data in real time and pinpoint the future position of a cyclist, for example. An impossible task for a person, and unique in a car, but all the more typical of the new S-Class.



Road master



There is not much we can do about road conditions, but we can conjure up some magic to ensure you don't lose any sleep over it. Magic Body Control (optional), our most advanced suspension system, simply adapts to the road in advance. You could say it takes away any bad traits of a road surface. This glance into the future works with a stereo camera. Integrated into the rear view mirror, it provides two perspectives of the road. The vast data is captured and processed by the electronic control unit – in real time, with an accuracy of one or two millimetres at 75 mph and 25 images per second.

The suspension system then controls the amount of oil supplied to the individual suspension struts and, as a result, any road imperfections are almost completely absorbed. All this happens at a speed of up to 80 mph. Even when you take a corner the system knows what's ahead. Once you witness this incredible experience, you may want to write a thank-you note to the engineers – with a fountain pen, seated in the rear and with the car in full motion, thanks to Magic Body Control.



Where back row means first class

If you're travelling in the S-Class, your destination can feel secondary. This is especially true for our engineers. They simply focus on making you truly feel at home in your surroundings. With a seat that keeps you cool or warm, gently tilts backwards and supports your legs and back in equal measure. Six massage settings provide 15 minutes of relaxation as a reward for everything you have already achieved, or to prepare you for the day ahead. The S-Class offers an exclusive working environment with everything you need. Its intuitive technology provides the kind of comfort that makes you forget, for an instant, that you're in a car and reinforces the sense that you find yourself in the most exquisitely designed space.





Enlightened progress

We leave no stone unturned when it comes to revolutionising cars and premiering new technologies. That's why we have taken a special look at the lights and tried to find ways to make them as efficient and intelligent as befits the S-Class. Our new LED technology not only shines more light on the road, it offers an agreeable light temperature and saves 25% energy compared to conventional headlamps. But most importantly, the lights interact with a whole range of sensors and electronic assistants,

notably the Adaptive High Beam Assist. As a result, when an oncoming vehicle is detected, the LED light simply dips the high beam within the range of the other car. When stationary at a traffic light, however, the brake light intensity is automatically reduced to ensure the person in the vehicle behind is not dazzled. More than 190 single-chip LED diodes ensure comfort and safety on the road. It's plain to see: lights can do a lot more than illuminate.



The S-Class in detail

Engines and suspension

- 27 | Diesel and petrol engines
- 28 | S 400 Hybrid L
- 29 | Transmissions
- 31 | Suspension

Safety

- 33 | Integrated safety concept

Comfort

- 37 | Electronic assistants
- 41 | Multimedia systems
- 45 | Seats
- 47 | Light and climate control
- 49 | Roof systems and privacy

AMG

- 51 | S 63 AMG L
- 57 | AMG Performance Studio

Equipment

- 61 | Standard equipment
- 62 | Optional equipment
- 63 | Model lines
- 67 | Exclusive Nappa Leather Package
- 69 | Trim and upholstery
- 75 | Alloy wheels
- 77 | Retailer-fit accessories

Services

- 79 | Test drive, Mercedes-Benz Finance and more

Technical data and paint finishes

- 81 | Dimensions
- 82 | Paint finishes
- 83 | Technical data

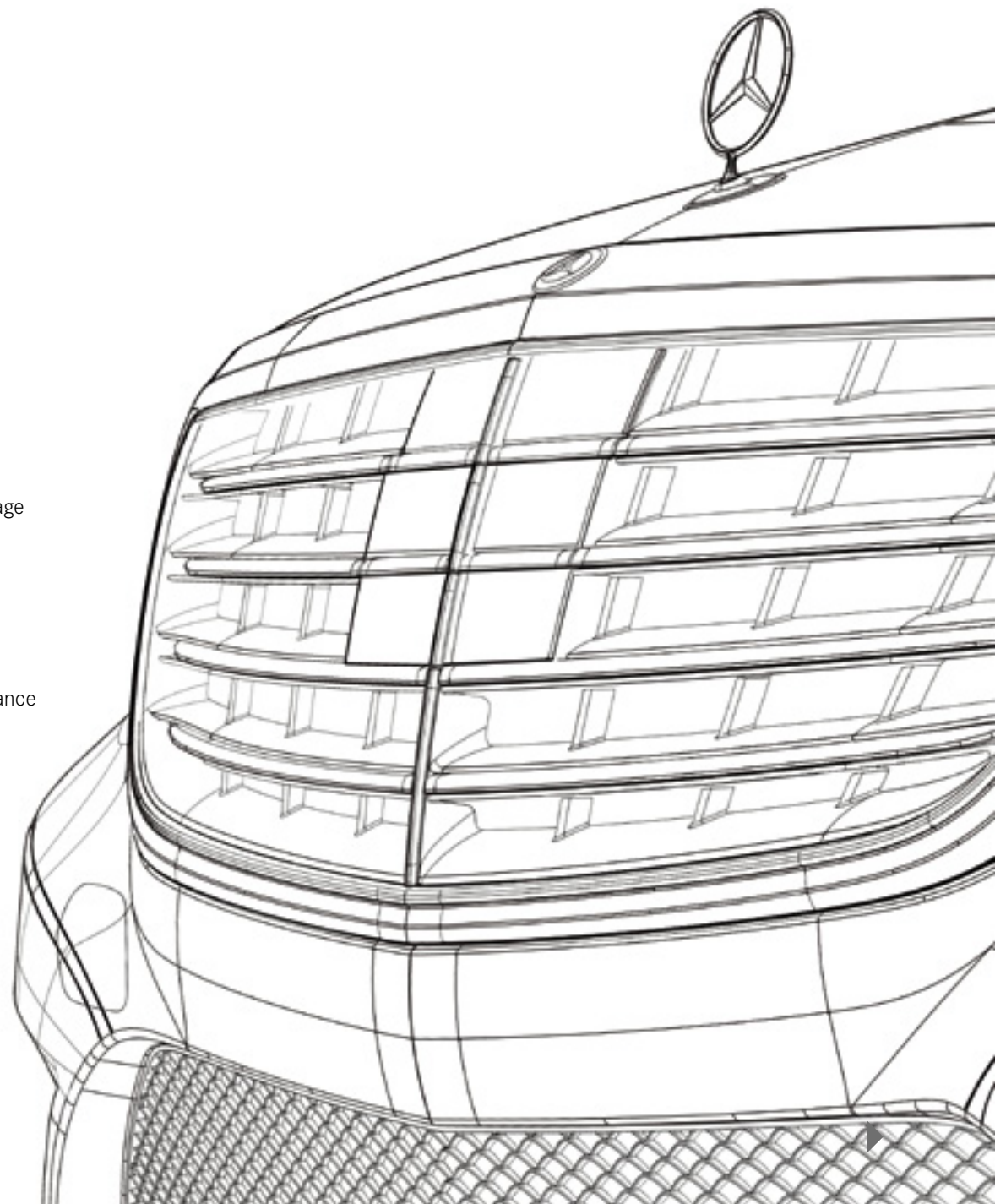

Diesel and petrol engines

A smooth, powerful drive and efficient technology should always go hand in hand. Consequently, Mercedes-Benz diesel and petrol engines feature a lightweight design and manage fuel usage with extreme precision. They reward the driver with responsibility and a truly enjoyable performance – regardless of which model you choose.

V6 diesel engine. The S 350 BlueTEC (L) combines efficiency and agility thanks to its lightweight design featuring aluminium parts and precisely switching piezo injectors. As a result this 258 hp (190 kW) V6 engine offers combined fuel economy of up to 51.4 mpg. CO₂ emission levels are equally impressive at just 146-158 g/km.

And thanks to BlueTEC technology, NO_x emissions are nearly on a par with a petrol engine, ensuring the diesel meets the latest strict European emission standards (EU6).

V8 petrol engine. Agility, driving pleasure and responsibility – it's all combined in this 455 hp (335 kW) V8 petrol engine. Thanks to twin-charging and air cooling the S 500 L generates enormous power and accelerates from 0–60 mph in just 4.8 seconds. While the engine sound is typical V8, fuel consumption is kept surprisingly low.



The S 350 BlueTEC shines with efficient technology

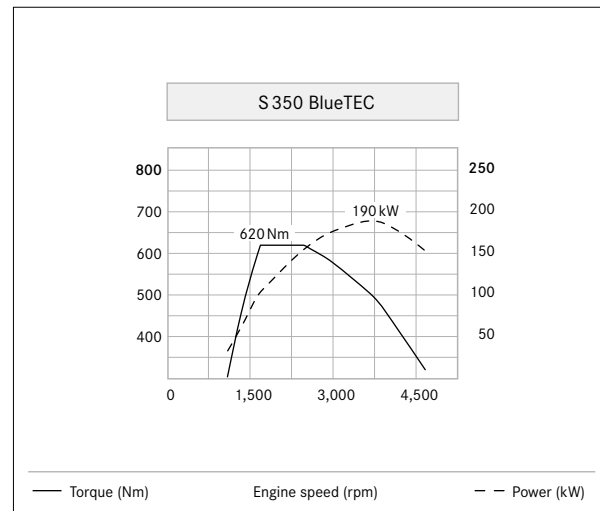

The V6 diesel engine combines top performance with low consumption

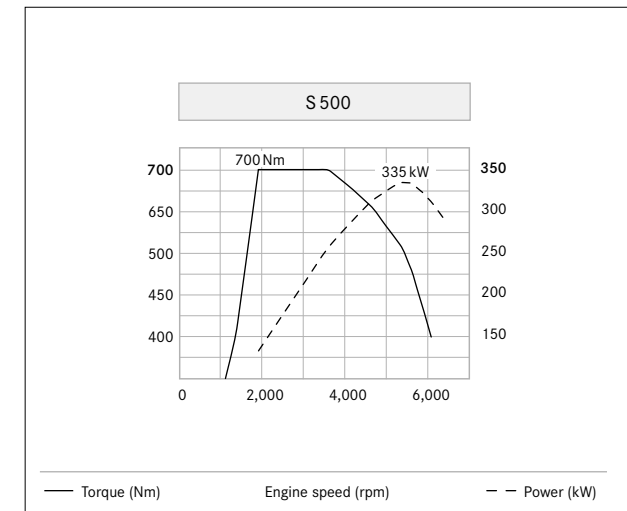

The V8 petrol engine offers a perfect blend of comfort, power and efficiency



S 400 Hybrid L

This incredibly efficient and environment friendly powertrain combines a V6 petrol engine with a compact electric engine. Equally innovative, the newly designed lithium-ion battery is extremely light due to its energy density and uses kinetic energy to recharge itself on the move.

Responsible, comfortable and dynamic – everything you'd expect from an S-Class powertrain, and the same applies to a hybrid model. That's why the S 400 Hybrid L is equipped with a further optimised V6 petrol engine and a compact, lightweight electric motor delivering plenty of torque. They are paired with a high-capacity

lithium-ion battery and a sophisticated electronic control unit managing the engines. As soon as the vehicle decelerates, the electronic engine functions as a generator to supply energy to the lithium-ion battery. At standstill, the ECO start/stop function switches off the petrol engine. As soon as the engine restarts, the

S 400 Hybrid L can exploit the gained kinetic energy. The instrument panel always keep you up to date about the current energy flow. You can also activate a boost function at short notice to combine the power of both engines if desired. As a result, the impressive power of the S-Class can be further enhanced short term.

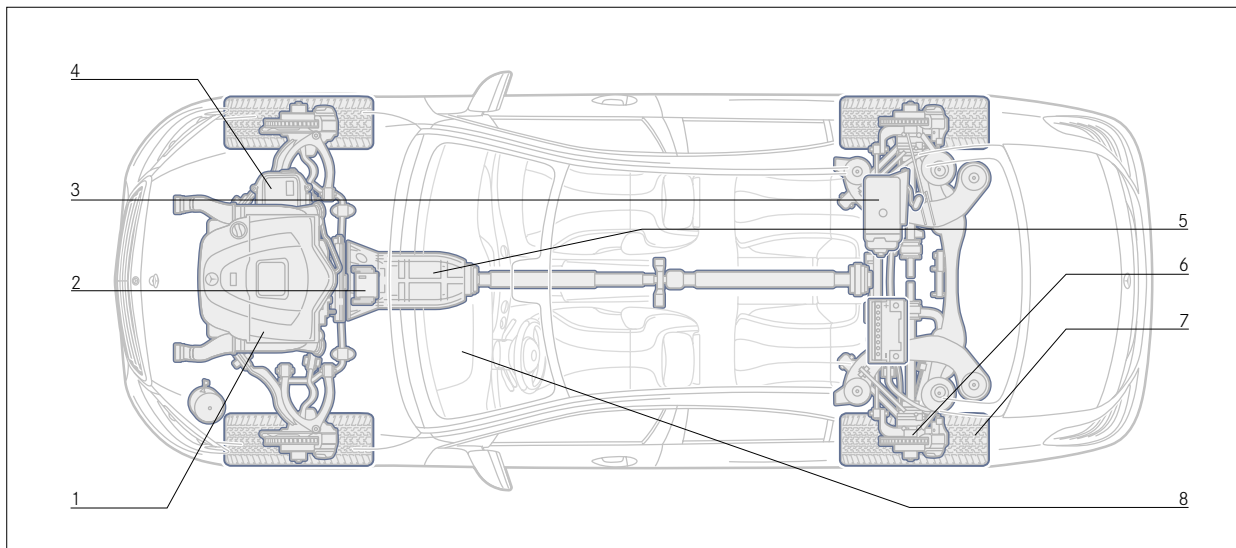

- 1 V6 petrol engine with 3.5l capacity
- 2 Compact hybrid module situated between the petrol engine and automatic transmission
- 3 The powerful lithium-ion battery features high energy density, compact dimensions and a lightweight design
- 4 Electronic control unit manages intelligent and efficient cooperation between petrol and electric engines.
- 5 The 7G-Tronic Plus automatic transmission ensures smooth acceleration and a seamless switch between both powertrains
- 6 Regenerative braking system: the electric engine functions as a generator when the vehicle decelerates, generating energy for the lithium-ion battery
- 7 Tyres with further reduced rolling resistance for a comfortable and efficient drive
- 8 The hybrid monitor always shows the current energy flow and battery charge status



Transmissions

The 7G-Tronic Plus automatic transmission boasts highly efficient and incredibly smooth gear changes for a dynamic drive, while keeping consumption and noise levels at a minimum.

7G-Tronic Plus. The 7G-Tronic Plus 7-speed automatic transmission unites driving comfort, agility and efficiency. Its seven forward gears ensure a large ratio range and keeps jumps in rev speed from one gear to the next small, resulting in short, smooth and fuel-efficient gear shifts. The transmission can also skip individual gears to allow precise multiple downshifts for quick and powerful sprints. You can also choose between 'Manual', 'Economy' and 'Sport' modes. In 'Manual' mode, you can also change gear using racing-style steering wheel gear shift paddles with Direct Select.

Direct Select. The Direct Select transmission comes with a Direct Select steering column lever allowing you to choose between P, R, N and D settings. You can also manually change gears using the gear shift paddles.



The Direct Select lever on the steering wheel. For manual gear changing, simply tap the gear shift paddles



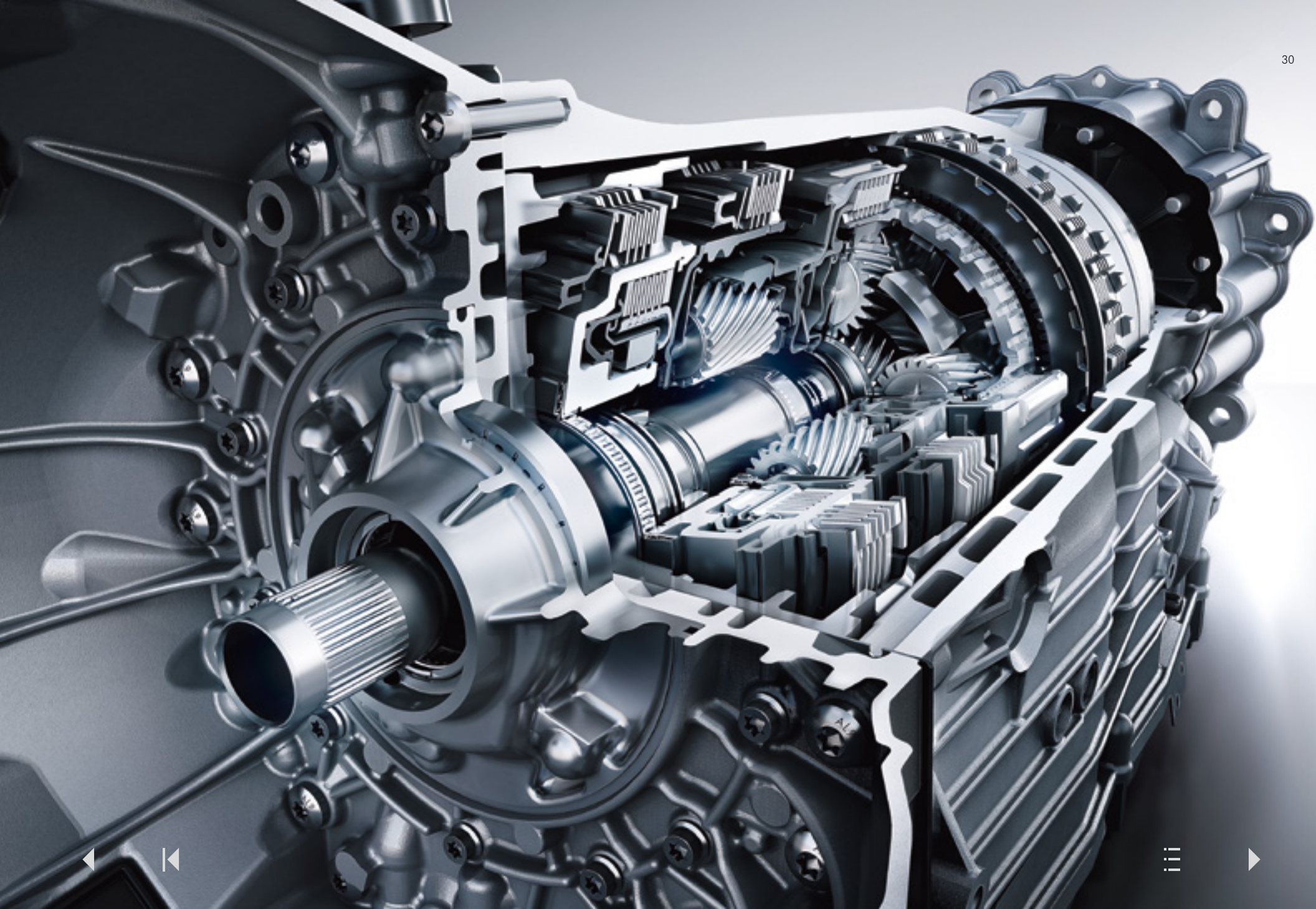

Suspension

The new S-Class is equipped with the latest generation AirMATIC suspension as standard. Innovative Magic Body Control is available as an option – another milestone celebrating its premiere in the S-Class.

AirMATIC (standard). AirMATIC air suspension features adaptive shock absorbers which automatically adapt to the current road conditions, load level and individual driving style. AirMATIC lets you choose between comfort and sport settings – for improved roadholding and personal driving style.

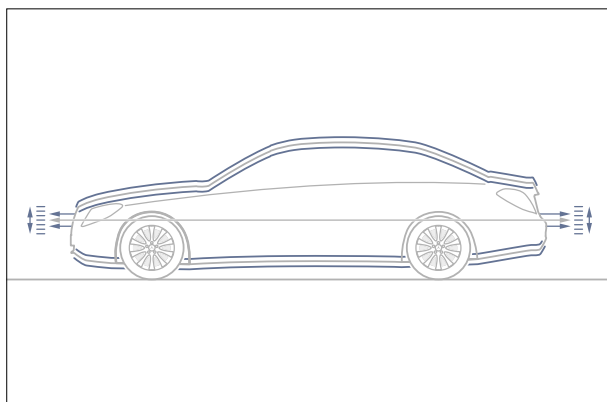

AirMATIC ensures the right balance between comfort and agility, allowing you to lower and raise the ride height as and when required

Crosswind Assist (standard). Crosswind Assist detects sudden, strong gusts of wind and helps the driver stay in lane by targeted braking. ESP® sensors automatically reduce the effects of high wind through course-correcting brake actuations on the side of the vehicle facing into the wind. The resulting rotation around the vertical axis (or yaw) counteracts the track displacement.

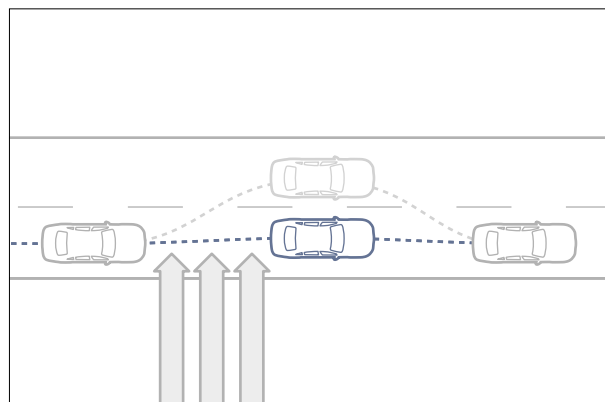

Crosswind Assist helps counteract the effect of sudden gusts of wind through course-correcting brake actions

Crosswind Assist gives the driver a greater sense of safety and helps prevent a sudden, inappropriate reaction by the driver.

Magic Body Control (optional on S 500 L). This suspension system offers another milestone in driving comfort, detecting bad road surfaces in advance and reacting accordingly. The active damping system of the suspension works with a Road Surface Scan to achieve this. A stereo camera captures a detailed picture of the conditions ahead which is then analysed to allow the system to decide how best to dampen each individual wheel to compensate for any uneven surfaces ahead – all in a split second.

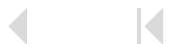

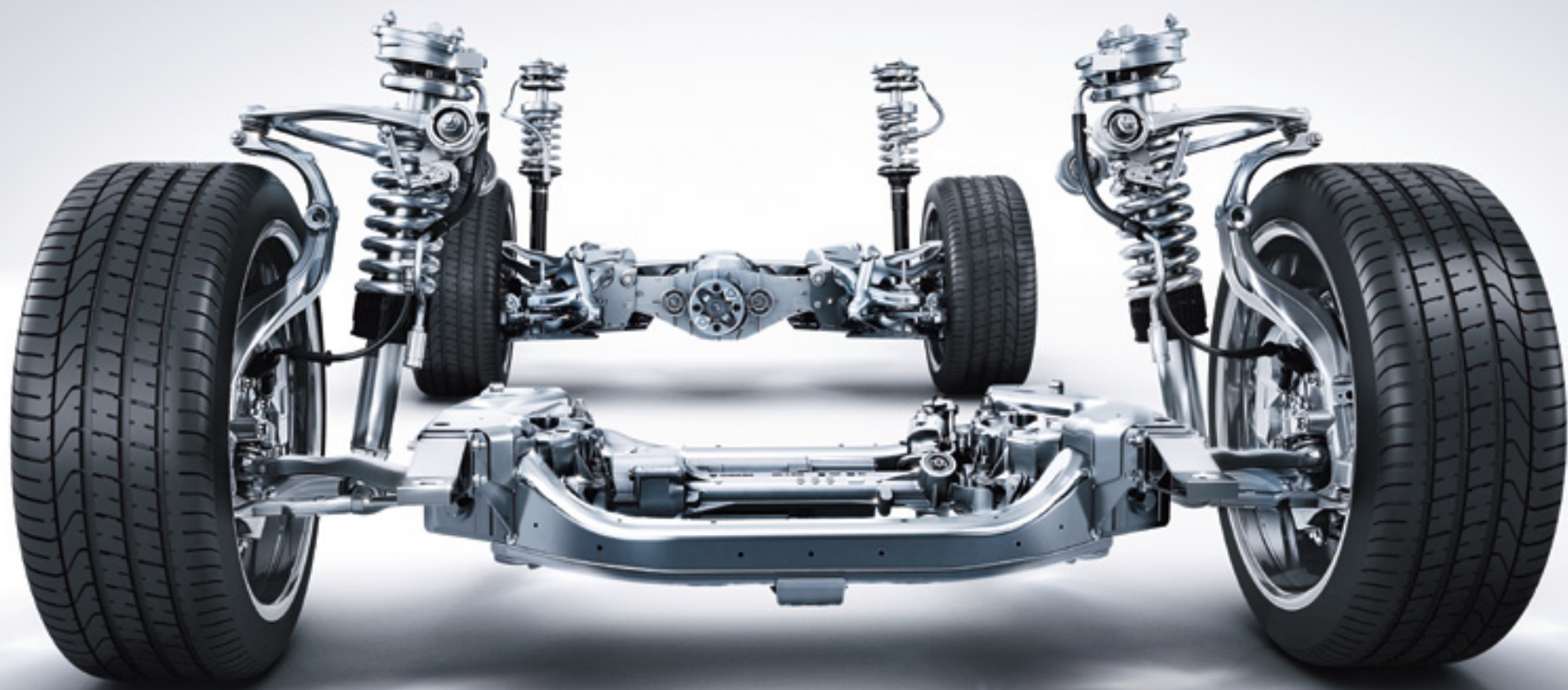

Integrated safety concept

The vision of accident-free driving spurs us on. Our integrated safety system helps bring us one step closer, offering new synergies between comfort and safety. We call this comprehensive approach Mercedes-Benz Intelligent Drive.

As the inventor of the motor car, we feel a particular responsibility towards road safety. That's why we were the first manufacturer to develop an integrated safety concept that seamlessly combines a car's active and passive safety features, thus ensuring optimum all-round protection. This concept covers four different areas – safer driving, anticipating danger, protecting occupants and pedestrians and post-crash safety – and incorporates measures designed to maximise safety in every situation, by helping you to stay safe, alerting you to danger, and assisting you wherever possible. In addition, our unique Pre-Safe® anticipatory safety system recognises likely accident scenarios and takes steps that help to further enhance occupant protection. If a collision can't be avoided, intelligent passive safety systems help to provide protection where it's needed, while solutions that can minimise the consequences of an accident and facilitate emergency assistance are also a key part of this safety concept. A selection of these technologies for the phases 'safer driving', 'anticipating danger', 'protecting occupants' and 'post-crash safety' are presented on the following pages.

Safer driving: Driving Assistance Package (optional).

This package contains a whole range of safety assistants including DISTRONIC PLUS with Steering Assist, Pre-Safe® Brake with Active Pedestrian Protection, Active Lane-Keeping Assist, Active Blind Spot Assist and BAS with Junction Assist, rear-end collision warning and Pre-Safe® Plus protection system. All these Mercedes-Benz Intelligent Drive technologies assist the driver, help reduce accident risk and protect other

road users. DISTRONIC PLUS with Steering Assist and Stop & Go Pilot helps the driver maintain the desired distance to the vehicle in front. It also makes the driver's job easier by helping with lane guidance and allows semi-autonomous driving in queuing traffic. Brake Assist Plus with Junction Assist and Pre-Safe® Brake help prevent collisions, particularly in urban traffic, and protect pedestrians at junctions. Active Lane-Keeping Assist and Blind Spot Assist are designed to counteract any unwanted lane

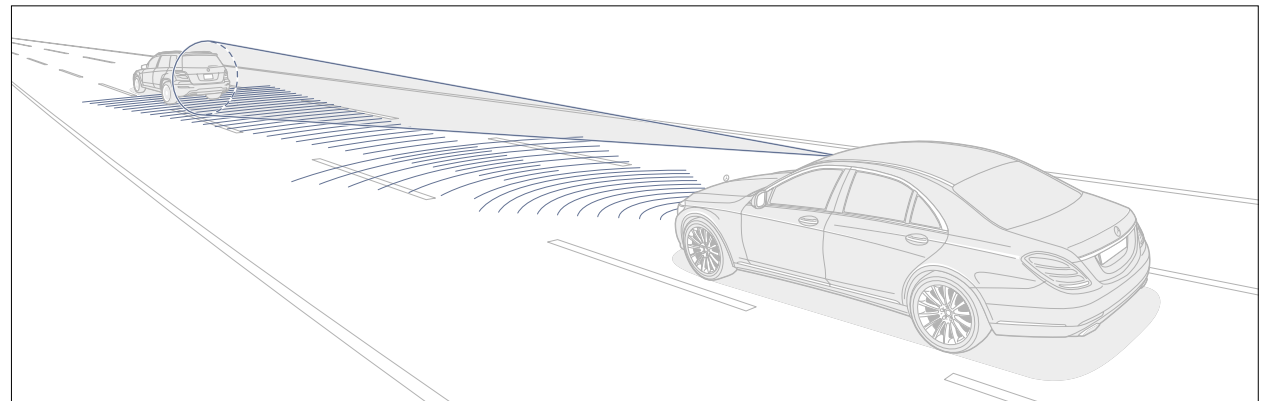

DISTRONIC PLUS with Steering Assist and Stop & Go Pilot aids the driver in both free-flowing and slow-moving traffic

departures. Targeted braking helps return the vehicle onto its original path to prevent potential collisions. And finally, Pre-Safe® Plus further enhances anticipatory occupant protection in rear collisions.

Safer driving: Night View Assist Plus (optional). Driving at night accounts for only 20% of all road traffic, yet 40% of accidents occur at this time. Night View Assist Plus gives the driver added protection, as it allows the driver

to see pedestrians or animals sooner. They are captured by an infrared camera which displays their image in the instrument cluster. Additionally, the Spotlight function flashes at pedestrians up to four times across the width of the road to alert both them and the driver. Night View Assist Plus display only appears in the instrument panel when a potential risk is detected.

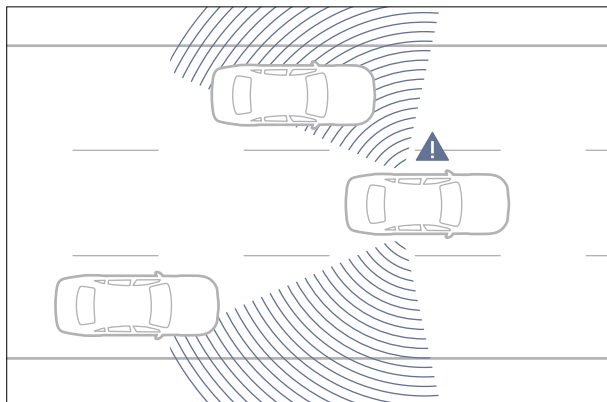

Active Blind Spot Assist monitors areas adjacent to the vehicle and can warn when changing lanes and slow down if necessary



Active Lane-Keeping Assist helps steer the S-Class back on its path when accidentally leaving lane



Night View Assist Plus displays detected pedestrians and helps the driver to react sooner to any potential danger

Anticipating danger: Pre-Safe® system (standard). If it detects a probable accident situation, Pre-Safe® can take anticipatory measures to protect the occupants, such as activating the seat belt tensioners or automatically closing the front windows.

Anticipating danger: Pre-Safe® Plus (part of the optional Driving Assistance Package). The further enhanced Pre-Safe® Plus uses a radar sensor in the rear bumper to detect potential hazards to the rear of the car and initiates additional safety measures. If an impact is imminent, the rear indicators flash more rapidly to warn the traffic behind. Furthermore, preventive measures such as an

emergency brake can reduce the risk of secondary collisions and lessen the forces of a forward jolt.

Anticipating danger: Brake Assist (BAS) with Junction Assist (optional). Brake Assist calculates the required brake force to prevent a collision or reduce the severity of the impact. It then initiates partial or an emergency brake if the driver does not apply the brakes hard enough. BAS also provides assistance in situations involving crossing objects. It can also detect pedestrians in the area ahead of the vehicle and increase the brake force applied by the driver if necessary.

Anticipating danger: Pre-Safe® Brake (optional). Pre-Safe® Brake assists the driver when it detects the risk of a collision in head-to-tail traffic or with stationary vehicles ahead. It alerts the driver via visual and audible warnings using information gathered by the radar sensors scanning the area surrounding your vehicle. If the driver fails to respond to a first warning, the system increases the brake force automatically. It can then trigger an autonomous emergency brake if there is still no reaction from the driver.

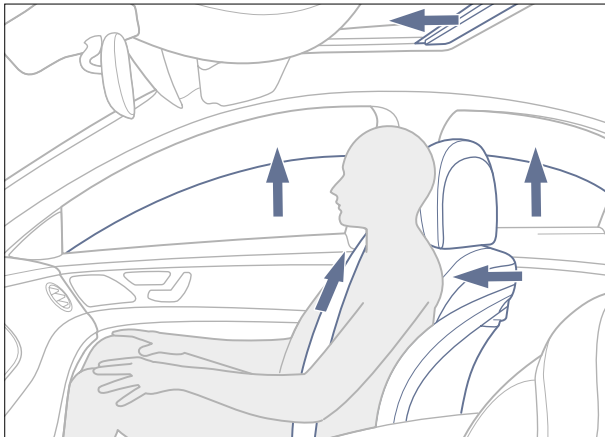

The anticipatory Pre-Safe® helps reduce the impact of a collision

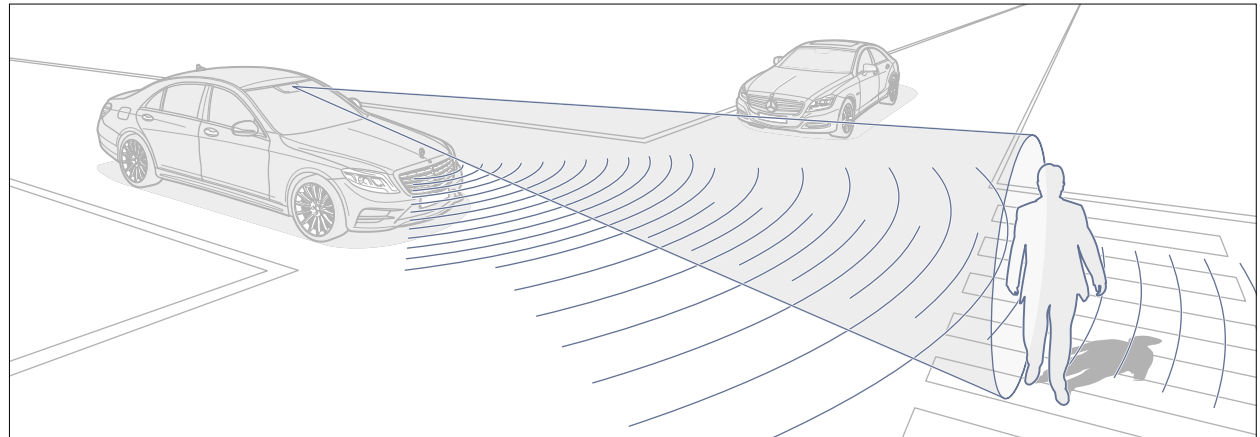

BAS Plus with Junction Assist now also takes into account pedestrians in front and crossing from the side when assisting with emergency braking

Anticipating danger: Pre-Safe® Impulse (standard). In a frontal impact, driver and front passenger are subjected to a great deal of strain. To counteract these forces, the front seat belts are tensioned in the early stages of a collision and released again with controlled force. Compared to conventional belt tensioners, the force for retracting is stronger and maintained longer. This pre-acceleration and force limitation allows occupants to be temporarily isolated from the effect of an impact.

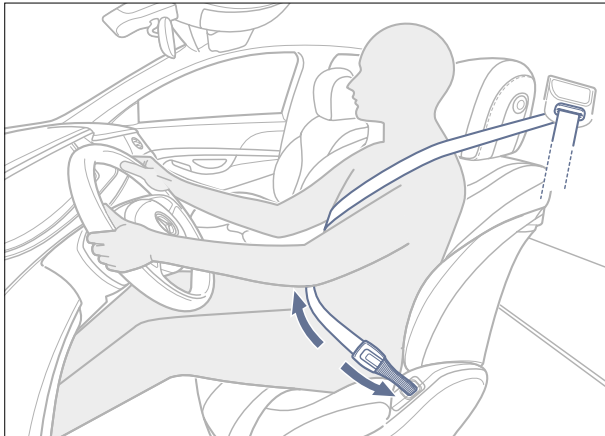

During the early stages of a collision, the seat belts help move the passengers in the opposite direction of the impact

Anticipating danger: airbags (standard). The S-Class is fitted with eight airbags as standard: front and sidebags for driver and front passenger, two windowbags and two rear sidebags. An inflatable belt bag for the two outer seats in the rear cabin can be fitted as an option. It inflates to three times its original size and offers further protection for the rib cage.

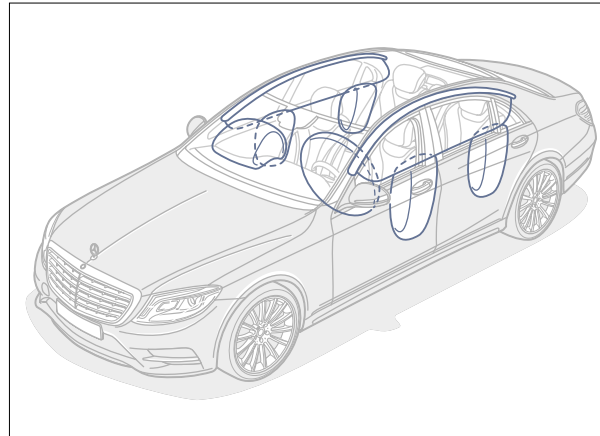

Eight airbags provide all-round protection in an accident

Post-crash safety: Mercedes-Benz Emergency Call System (part of COMAND Online). Should the restraint system sensors detect an accident, the emergency call system can use a paired mobile phone to automatically contact the emergency services. In addition, it simultaneously sends GPS data and other vehicle information to the Mercedes-Benz emergency call centre, where an operator will attempt to make contact with you by phone. The emergency call system can also be activated manually.

Post-crash safety: rescue assistance. Mercedes-Benz has developed a range of measures that help to minimise the secondary consequences of an accident and facilitate occupant rescue. These include automatic engine cut-off, self-activating hazard lights and emergency cabin lighting. In addition, the central locking system is automatically released in the event of an accident, and there are special crash joints between the front doors and wings that make it easier to open the doors after frontal collisions. In addition, Mercedes-Benz provides a rescue guide for emergency services that can be downloaded in various languages from the Internet at www.mercedes-benz.co.uk/rescueguide



Electronic assistants

Whilst the new S-Class makes an impression on its surroundings, it also keeps a close eye on what is happening around the car: it's fitted with short and long range radars, stereo and infrared cameras, as well as ultrasound sensors to keep you safe and relaxed on your journey.

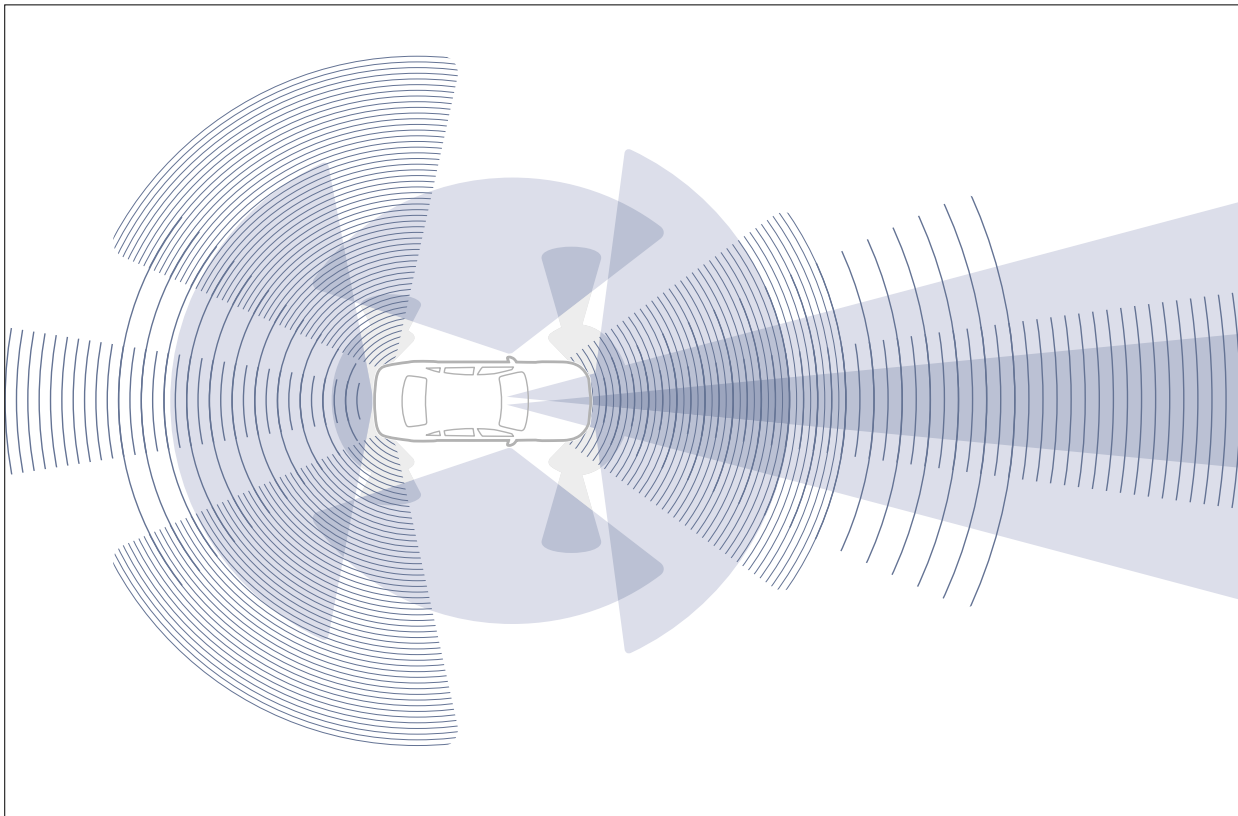

A stereo camera plus short and long range radar sensors form the basis of numerous safety and assistance systems in the new S-Class

Stereo camera (optional). The camera can detect pedestrians and objects crossing in front of the vehicle and calculate their trajectory. Intelligent algorithms process and analyse this data in order to make assessments about vehicles ahead, oncoming traffic, pedestrians and various types of traffic signs and road markings.

360° camera (optional). This feature works with a close-range camera system comprising four cameras and a control unit which can display a homogenous all-round view of the vehicle and its surroundings from a bird's-eye perspective and displays it in the COMAND system. It also shows potential obstructions below the window line.





Parking Package (standard). Active Park Assist with Parktronic and a reversing camera help you find appropriate parking slots and can also automatically manoeuvre the S-Class in and out of perpendicular and parallel parking spaces. When the car is put into reverse and the driver accepts the parking suggestion, Active Park Assist autonomously completes the manoeuvre up to a speed of 6 mph. The driver merely applies the brake and the accelerator, a process which should be completed within a maximum of seven moves.



The stereo camera captures an area of up to 500 metres around the vehicle and also detects parking slots

Traffic Sign Assist (as part of COMAND Online, adapted to specific countries). The front-mounted camera detects speed limit warnings, no-overtaking signs and their cancellation, and shows them in the COMAND display. If a no-entry sign is detected and the driver disregards this, the systems emits a visual and acoustic warning as part of the no-entry warning function.



Traffic Sign Assist can detect speed limits and displays the permitted maximum speed in the COMAND display

LED Intelligent Light System (standard). For the best possible visibility on A-roads and motorways, when turning off, cornering, or in fog, the LED Intelligent Light System headlamps automatically adapt to light, weather and driving conditions. High beam mode (part of Adaptive High Beam Assist) shines more light on the road without dazzling oncoming traffic. It dips part of the beam affecting oncoming traffic, while keeping the road verges fully lit. Also, to ensure the driver is not dazzled by its own light, the system dims the beam when detecting highly

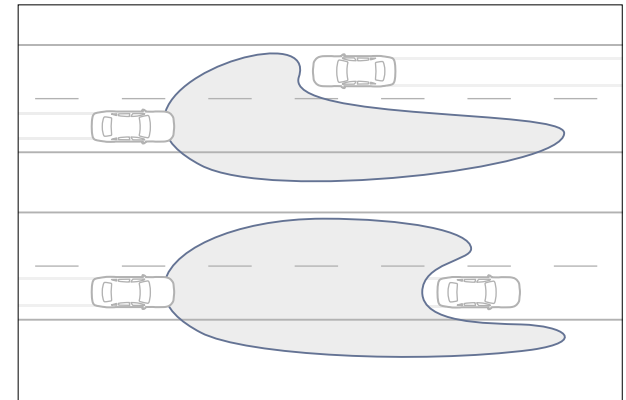

Adaptive High Beam Assist automatically provides the largest possible beam area available, improving the driver's view

reflective traffic signs. As a result, the LED Intelligent Light System provides a great contribution toward your safety. And while this technology is both highly efficient and long lasting, it also emits an appealing colour tone that's akin to daylight conditions.

Warmth Comfort Package (optional). On cold days, this package creates a warm and comfortable feeling on all essential surfaces: apart from heated seats as standard, the front and rear armrests, as well as the steering wheel,

can be heated. The front passengers and those travelling in the outer rear seats can choose between three temperature settings. The surfaces to be heated can be selected via the COMAND display.



The Warmth Comfort Package features three temperature settings



Multimedia systems

Whether you're on your way to work or working on the move, the S-Class comes with comprehensive multimedia options to help you stay connected. (All new Mercedes-Benz Connect services can be used as intuitively as you would expect.)

COMAND Online (standard). Navigation, telephone, audio, video, Internet – it's all combined in the high-resolution COMAND Online system featuring a large 12.3-inch colour display. The speedy hard drive navigation system with topographic map display ensures a relaxed drive to your destination. When the car is stationary and the system is connected with a mobile phone, you can surf the Internet. On the move, Mercedes-Benz apps, like special searches, weather reports and Internet radio,

are also accessible. You can even connect your laptop or tablet via Wi-Fi. Further multimedia functions include a DVD player, digital radio, 10 GB of storage space for audio and video data, as well as interfaces for external devices.

Mercedes-Benz Connect. Serving as a smart interface between car and Internet, Mercedes-Benz Connect offers a whole range of services for your comfort, safety and information. It's an effortless, highly efficient way to keep

the driver connected with the digital world when on the move. The system can be paired with COMAND Online, 'Live Traffic' information, the Mercedes-Benz Emergency Call System as well as with Wi-Fi hotspot functionality.

'Live Traffic' information (standard, as part of COMAND Online¹). This service provides precise, up-to-date traffic information for improved route planning. It also helps calculate the estimated time of arrival more accurately. The required data is transmitted via a communication module and an integrated SIM card to create an Internet-based data-roaming connection.



The high-resolution COMAND Online system displays all the information and communication functions of the S-Class

¹'Live Traffic' information is country-specific





10:10

Audiophil
Mercedes-Benz Mixed Tape



00:02 02:28 3/10

- 5
- Stop & Go
- Things Will Change
- Visions

20°C 3 DEFROST DEFROGE A/C on 4 24°C

R N P 4



When driving at night, the illuminated Burmester® high-end 3D surround sound acoustic lenses create a unique ambiance

Burmester® high-end 3D surround sound system

(optional). Twenty-four high performance speakers and a 24-channel amplifier with a total output of 1,540 watts create a sound experience of the highest order. The sound system features technology designed especially for the S-Class, where analogue and digital elements provide the most unique and fascinating sound space. Apart from acoustic highlights, there are also striking visual effects to be enjoyed: two acoustic lenses situated in the front door mirror panels move into position as soon as the sound system and the ambient lighting are switched on, to emit a striking colourful glow.

Burmester® surround sound system (optional). Thirteen high performance speakers combined with acoustic technology designed specifically for the S-Class interior, including sound optimisation, provide a highly refined listening experience.



SplitView (optional). The 12.3-inch COMAND Online display allows the driver to use the navigation system, while the front seat passenger watches a DVD in high definition. With SplitView, different content can be viewed on the same screen depending on the seating position and viewing angle. Headphones provide the front passenger with excellent sound without distracting the driver. Using a remote control, the front passenger can

also access all multimedia functions, including films on DVD, radio, Internet or TV via the TV tuner. What's more, external devices, including MP3 players, games consoles or iPod®, can be accessed via the aux-in port.

Rear seat entertainment system (optional). Whether you want to watch DVDs, access the Internet, play music or games, the rear seat entertainment system provides individual access. All content is displayed on 10-inch screens combined with wireless headphones for premium sound.



SplitView enables the COMAND Online screen to display different images for the driver and the front seat passenger

The rear seat entertainment system features 10-inch screens

Seats

In the S-Class, seating is not a passive affair. Apart from ensuring excellent support, the seats also enhance the performance of the occupants, with individual electric adjustment of seating settings as standard, plus comfort ventilation and massage functions.

Front Seat Comfort Package (optional). The dynamic multi-contour seats with massage function offer outstanding long-distance comfort. Air chambers in the seats' lumbar and shoulder regions adjust to each occupant's individual body shape, while the side bolsters adapt automatically as you drive to ensure optimum support at all times, especially when cornering. They can even give their occupant a soothing massage. Simply select one of the massage function's four programmes



Control of the energising massage function is available via COMAND Online

and let the rolling motion of its seven chambers gently stimulate your back muscles. It's not only highly relaxing; it can also help you feel more focused and alert.

Front Seat Memory Package (optional; standard on S 500 L). With frequent driver changes, the Front Seat Memory Package offers additional comfort, as individual settings for the front seats, luxury front head restraints, steering column and exterior door mirrors can be stored and recalled at the touch of a button.

Executive Rear Package (optional). This package provides premium comfort for the chauffeur-driven S-Class, featuring comfort ventilated rear seats, electrically operated, with backrests that can recline up to 37° (with memory function). The luxury rear head restraints even come with an additional comfort cushion. Also includes luxury automatic climate control for the rear, closing aid for doors and boot lid, and the Roller Blind Package.

Individual Rear Seats Package (optional). Alternatively, for two individual workstations in the back, this package has two individual comfort-ventilated, electrically adjustable rear seats, two USB connectors per seat, two 12-volt sockets and folding rear tables.

Rear Seat Reclining Package (optional). For more legroom in the rear, the front passenger seat can be moved further forward, with a reclining seat and additional footrest installed behind the front passenger seat. (Available in conjunction with either the Executive Rear Package or the Individual Rear Seats Package.)

Rear Seat Comfort Package (optional). For the ultimate luxury, both the Executive Rear Package and the Individual Rear Seats Package can be combined with multi-contour seats, featuring an energising massage function with 14 air chambers in the backrest, Burmester® surround sound system and rear seat entertainment system.

Exclusive Nappa Leather Package shown opposite in Silk Beige/Espresso Brown



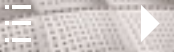
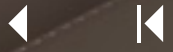

Light and climate control

The S-Class thinks of nearly everything – even the air you breathe. The Air-Balance Package ionises, cleanses and fills the air with a choice of four pleasant scents. They work beautifully with the ambient lighting to create an atmosphere that’s perfectly suited to your mood.

Ambient Lighting (optional; standard on L models).

For the perfect atmosphere on board, the entire cabin can be filled with ambient lighting in one of seven colours which can be dimmed to your preferred setting.

Air-Balance Package (optional). Four premium scents are available to provide an individual atmosphere to suit your mood and taste. At the same time, a unique ionising and filtering process helps to enhance the air quality inside the cabin.

Luxury automatic climate control (standard). The S-Class comes with a luxury automatic climate control system that enables the driver and front seat passenger to select their own separate settings. In addition, there’s a choice of three different climate modes – Diffuse, Medium and Focused – and an activated charcoal filter that ensures only clean air enters the cabin. Front seat occupants can also choose between five temperature settings for the footwells, independently of their selected temperature settings.



The Air-Balance Package for ionisation, air filtration and scenting – and the perfect mood onboard





Roof systems and privacy

The roof systems and privacy glass help create an S-Class to match your individual demands for exhilaration and relaxation.

Electric panoramic glass sunroof (optional). The large sunroof creates a bright and airy atmosphere inside the S-Class. It consists of two panoramic glass roof panels, a solid one at the rear and an electrically adjustable section at the front. Two blinds shield you from the sun when required. Also, for your convenience, the sunroof features three different positions to adapt to your travelling speed. For example, at high speed the sun roof is lowered to reduce noise levels and air circulation. As soon as the car slows down, the roof lifts. It even takes weather changes into account, and closes when it detects raindrops. When the car is parked, the roof can be opened and closed remotely. The electronic key functions include 'summer opening' and 'comfort closing' – a handy feature, for example, if you want to increase air circulation in the S-Class before you enter it on a hot

and sunny day: along with the roof, the side windows are also opened. The system also has an anti-trap feature to ensure your hand can't get caught: it stops the closing process when detecting an obstacle and retracts the sun blind if necessary.

Privacy glass (optional). The dark tinted privacy glass for the rear side windows and the rear windows not only protects occupants from the glare of the sun and prying eyes, it also emphasises the sporty appeal of the limousine.





S 63 AMG L exterior

Strength, endurance, speed – one look at the S 63 AMG L reveals what this sports car is made of.

As the 'V8 Biturbo' badge promises, the S 63 AMG L is powered by a mighty V8 biturbo engine delivering 585 hp (430 kW) and a maximum 900 Nm torque. All this energy is channelled by the AMG Speedshift MCT 7-speed sports transmission with Controlled Efficiency drive mode and stop/start function. For maximum comfort at all times,

it features AMG sports suspension based on Magic Body Control.

The exterior features AMG front and rear aprons with silver chrome trim, as well as black inserts on the front apron for optimised airflow. The sporty AMG forged

wheels, high-performance braking system with grey brake calipers and AMG logo plus AMG sports exhausts with chromed twin tailpipes complete this powerful ensemble.

The generous specification also includes an electric panoramic glass sunroof.



19" AMG forged wheels (fitted as standard)

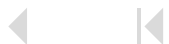



S 63 AMG L technology

AMG stands for ambition. That's why the S 63 AMG L features more power with 585 hp (430 kW) and a maximum 900 Nm, yet emits fewer emissions and consumes less fuel.



Lightweight design and intelligent solutions are key to the S 63 AMG L's astoundingly sporty yet efficient performance

The use of lightweight materials has meant that the S 63 AMG L is 100 kilos lighter than its predecessor. At the heart of this achievement are innovative materials like carbon and a lithium-ion battery, as well as lighter forged AMG wheels. As a result, this model is even more agile, while reducing emission levels and fuel consumption. The AMG sports suspension based on Magic Body Control combines outstanding driving dynamics and precision with a high level of comfort on long journeys. Best possible handling is guaranteed with AMG-specific parameterisation of the Active Body Control suspension and the continuously adjustable damping system. Additionally, the AMG Speedshift MCT 7-speed sports transmission benefits from a wet starting clutch for a highly sporty performance – without diminishing the comfort of the drive.



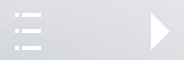

S 63 AMG L interior

Two and a half years' work have gone into the development of the new S-Class interior, reflecting both the high demands of our designers and, of course, the driver.

The sporty ambitions of the S 63 AMG L are equally reflected in the interior: the AMG sports seats support a dynamic drive with added side bolsters. Making its mark, AMG logo metal badges adorn front and rear seats. They are fitted with premium nappa leather and contrast

stitching. For added sophistication, the optional Exclusive Package includes perforated Exclusive Nappa leather and diamond stitching. Sports pedals, AMG sports steering wheel, AMG door sills and an IWC-designed analogue clock complete this athletically styled interior.



Designed for a thrilling ride: the individual sports seats in the rear are upholstered with Exclusive Nappa leather featuring diamond stitching

Optional features shown: Exclusive Nappa Leather Package, AMG carbon fibre/Black Piano Lacquer trim, Individual Rear Seats Package and Rear Seat Reclining Package



The embossed AMG logo takes pride of place on the centre console





Interior shown features the optional Exclusive Nappa Leather Package with optional AMG carbon fibre/Black Piano Lacquer trim



AMG Performance Studio

For an even more striking experience, AMG Performance Studio enhances both technology and styling, complete with AMG ceramic composite braking system and illuminated AMG door sills.

A comprehensive equipment range is at the heart of the AMG Performance Studio. It features a high-performance AMG ceramic composite braking system, which not only delivers enhanced stopping power and greater durability, but also offers braking abilities at motoring racing level. An AMG carbon fibre engine cover, red brake calipers and the Exterior Carbon Trim Package for front and rear apron, as well as side skirts and exterior mirrors, are also vital components of the sporty S 63 AMG L styling.

There is a choice between burnished Titanium Grey 20" AMG forged alloy wheels in a twin-spoke design and 20" AMG 10-spoke alloy wheels in polished or matt Titanium Grey. Both are fitted with sophisticated wheel bolt covers. This dynamic theme continues inside the cabin with carbon fibre and Piano Lacquer trim elements, an AMG Performance steering wheel, illuminated door sills with 'AMG' lettering and floor mats with AMG badge.



The high-performance AMG ceramic composite braking system with unique 'AMG carbon ceramic' lettering





AMG Performance Studio features | Selection



AMG carbon fibre and Piano Lacquer trim elements



AMG Driver's Package with 186 mph top speed



AMG carbon fibre engine cover



Illuminated AMG door sill

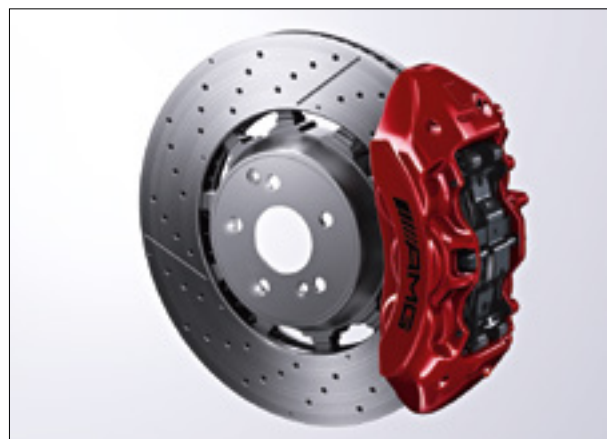

Red-painted AMG brake caliper

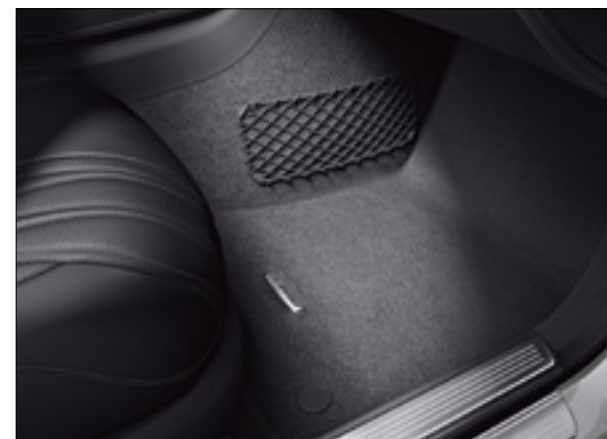

Exclusive AMG floor mat





Standard equipment | Selection



LED Intelligent Light System



Parking Package



Magic Vision Control



Electrically adjustable front seats



COMAND Online system with Media Interface



Traffic Sign Assist



Optional equipment | Selection



Privacy glass



Driving Assistance Package



Air-Balance Package with ionisation, filtering and scenting



Electric panoramic glass sunroof



Magic Body Control



Burmester® surround sound system



SE Line

The S-Class SE Line is filled with the most comprehensive range of innovative technology, exclusive fittings and finest materials for all-round comfort and enjoyment.

The S-Class SE Line offers the most comprehensive equipment for your convenience and all-round protection. AirMATIC air suspension with Adaptive Damping System is standard, along with a 7G-Tronic Plus 7-speed automatic transmission with steering wheel gear shift paddles. On the exterior, you'll also notice the LED Intelligent Light System, which adapts to the conditions around you, as well as 18" alloy wheels in a 5-twin-spoke design. Optional 19" 5-twin-spoke alloys are also available (shown here).

The welcoming interior is fitted with a steering wheel in nappa leather, Dark Brown Eucalyptus wood trim and exquisite leather upholstery. The innovative combination of COMAND Online and instrument cluster with high-definition TFT display brings new clarity into the cockpit. As you'd expect, the cabin is an oasis of relaxation – with luxury automatic climate control and Frontbass® speakers for the perfect sound.



Exhaust system without visible tailpipes – S 350 BlueTEC (L). Optional 19" 5-twin-spoke alloy wheels shown





AMG Line

The AMG Line combines perfectly matched elements to maximise exclusivity and sportiness.

The S-Class AMG Line enhances the sporty appeal of this stunning saloon. It comes with dynamic AMG bodystyling, comprising front apron, rear apron and side skirts, as well as 19" AMG alloy wheels in 5-twin-spoke design with perforated brake discs, and 'Mercedes-Benz' lettering on the brake calipers. Equally prominent are the visible twin tailpipes on the S 400 Hybrid L and the S 500 L, which are integrated into the bumper.

The interior continues with athletic flair, featuring Black Poplar wood trim and a wood- and leather-trimmed multi-function steering wheel, as well as brushed stainless steel sports pedals and velour floor mats with 'AMG' lettering.



A sports exhaust system with two visible tailpipes – S 400 Hybrid L and S 500 L only. Optional 20" AMG multi-spoke alloy wheels shown





Exclusive Nappa Leather Package

This exquisite nappa leather and wood interior adds yet more style and comfort to the S-Class.

Stylish and exclusive from the word go, this interior package further enhances the premium feel of the S-Class interior. It features nappa leather with a diamond pattern and contrast stitching on seats and upper dashboard,

combined with an even more generous use of wood trim, including the door centre panels and the covers on the rear air vents – additionally available with a choice of *designo* Brown Sunburst Myrtle wood or *designo*

Metallised Ash wood. Illuminated door sills, Dinamica roof lining, plus nappa leather-covered armrests and centre armrest lining with contrast stitching complete the elegant picture.



Striking trim: *designo* Brown Sunburst Myrtle wood



Additional wood trim on the rear air vents and door centre panels elevates the exclusive rear cabin. Reclining Rear Seat Package shown



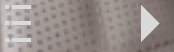

Upholstery and trim

Seats and upholstery in two leather choices and three design styles

Pure luxury and optimum ergonomics combine to make S-Class seating exceptional. The seats not only provide long-distance comfort but also an upholstery finish which is sublime.

Three seat designs are available, depending on the chosen seating option. There is our standard high-quality leather or a more finely grained nappa leather available as an option. The Exclusive Nappa leather seat comes with a distinctive diamond pattern and contrast stitching, and forms part of the optional Exclusive Nappa Leather Package.

Additionally, all seats feature perforated leather with front seat heating as standard. For long wheelbase models the rear seats are also heated. The S 63 AMG L has its own distinctive seat design and features multi-contour front seats as standard.



Leather



Nappa leather



Exclusive Nappa leather





The Black interior exudes an unmistakably sophisticated elegance. It features leather seats combined with high gloss Dark Brown Eucalyptus wood trim on the SE Line and Black Poplar wood trim on the AMG Line as standard. Nappa leather or Exclusive Nappa leather are also available in Black.



201

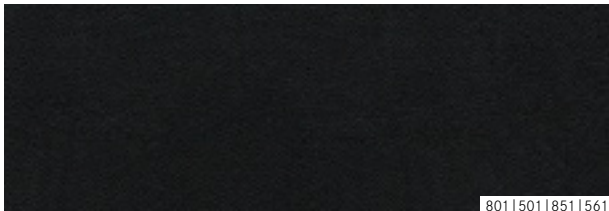

801 | 501 | 851 | 561



734



729



731



727



H06



H10

Black

- 201 Leather¹
- 801 Nappa leather² | 851 Nappa leather³
- 501 Exclusive Nappa leather^{2,4} | 561 Exclusive Nappa leather^{4,5}

Trim

- 734 High gloss Dark Brown Eucalyptus wood⁶
- 729 Black Poplar wood⁷
- 731 Brown Burr Walnut wood²
- 727 *designo* Brown Sunburst Myrtle wood⁸
- H06 *designo* Metallised Ash wood⁸
- H10 AMG carbon fibre/Black Piano Lacquer⁹

¹Standard on SE Line and AMG Line ²Optional ³Standard on S 63 AMG L
⁴Included with Exclusive Nappa Leather Package (code P34)
⁵Optional on S 63 AMG L ⁶Standard on SE Line and S 63 AMG L
⁷Standard on AMG Line; optional on SE Line and S 63 AMG L
⁸Optional with Exclusive Nappa Leather Package (code P34)
⁹Optional with Exclusive Nappa Leather Package for S 63 AMG L only (code P34)

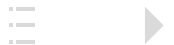



The Silk Beige/Espresso Brown interior creates an ambiance of a luxury lounge. The upper dashboard trim, beltline door trim and the parcel shelf feature an Espresso Brown hue in contrast to Silk Beige appointments. Espresso Brown contrast stitching is also part of this impactful composition. On the SE Line it is combined with high gloss Dark Brown Eucalyptus wood trim, the AMG Line features Black Poplar wood trim as standard. Nappa leather or Exclusive Nappa leather is also available in this combination.

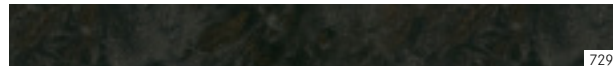

Silk Beige/Espresso Brown

- 205 Leather¹
- 805 Nappa leather² | 855 Nappa leather³
- 505 Exclusive Nappa leather^{2,4} | 565 Exclusive Nappa leather^{4,5}

Trim

- 734 High gloss Dark Brown Eucalyptus wood⁶
- 729 Black Poplar wood⁷
- 731 Brown Burr Walnut wood²
- 727 *designo* Brown Sunburst Myrtle wood⁸
- H10 AMG carbon fibre/Black Piano Lacquer⁹

¹Standard on SE Line and AMG Line ²Optional ³Standard on S 63 AMG L
⁴Included with Exclusive Nappa Leather Package (code P34)
⁵Optional on S 63 AMG L ⁶Standard on SE Line and S 63 AMG L
⁷Standard on AMG Line; optional on SE Line and S 63 AMG L
⁸Optional with Exclusive Nappa Leather Package (code P34)
⁹Optional with Exclusive Nappa Leather Package for S 63 AMG L only (code P34)





Crystal Grey against Seashell Grey exudes a sense of sophisticated purity, a combination that is exclusively available with the nappa leather option. The upper dashboard trim, beltline door trim, part of the contrast stitching and the parcel shelf come in Seashell Grey, beautifully paired with the Crystal Grey backdrop.

Crystal Grey/Seashell Grey

- 808 Nappa leather¹
- 858 Nappa leather²

Trim

- 734 High gloss Dark Brown Eucalyptus wood³
- 729 Black Poplar wood⁴
- 731 Brown Burr Walnut wood¹
- 727 *designo* Brown Sunburst Myrtle wood⁵
- H06 *designo* Metallised Ash wood⁵
- H10 AMG carbon fibre/Black Piano Lacquer⁶

¹Optional ²Standard on S 63 AMG L ³Standard on SE Line and S 63 AMG L
⁴Standard on AMG Line; optional on SE Line and S 63 AMG L
⁵Optional with Exclusive Nappa Leather Package (code P34)
⁶Optional with Exclusive Nappa Leather Package for S 63 AMG L only (code P34)





Another truly sophisticated interior solution, the seats, centre dashboard trim and door centre panels are fitted in Nut Brown to provide a striking contrast against the Black background. Nappa leather or Exclusive Nappa leather are also available in this combination.



214

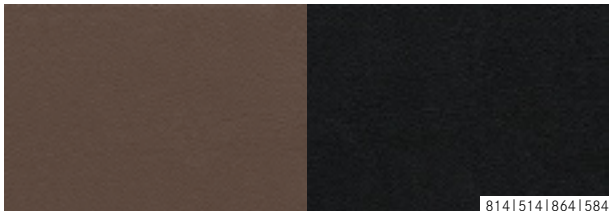

814|514|864|584



734



729



731



727



H10

Nut Brown/Black

- 214 Leather¹
- 814 Nappa leather² | 864 Nappa leather³
- 514 Exclusive Nappa leather^{2,4} | 584 Exclusive Nappa leather^{4,5}

Trim

- 734 High gloss Dark Brown Eucalyptus wood⁶
- 729 Black Poplar wood⁷
- 731 Brown Burr Walnut wood²
- 727 *designo* Brown Sunburst Myrtle wood⁸
- H10 AMG carbon fibre/Black Piano Lacquer⁹

¹Standard on SE Line and AMG Line ²Optional ³Standard on S 63 AMG L
⁴Included with Exclusive Nappa Leather Package (code P34)
⁵Optional on S 63 AMG L ⁶Standard on SE Line and S 63 AMG L
⁷Standard on AMG Line; optional on SE Line and S 63 AMG L
⁸Optional with Exclusive Nappa Leather Package (code P34)
⁹Optional with Exclusive Nappa Leather Package for S 63 AMG L only (code P34)





The Exclusive Nappa leather option features Porcelain-coloured seats, centre dashboard trim and door centre panels, combined with the overall Black interior. This combination is reserved for the Exclusive Nappa leather option.

Porcelain/Black

- 515 Exclusive Nappa leather^{1,2}
 - 585 Exclusive Nappa leather^{2,3}
-

Trim

- 729 Black Poplar wood⁴
 - 731 Brown Burr Walnut wood¹
 - 727 *designo* Brown Sunburst Myrtle wood⁵
 - H06 *designo* Metallised Ash wood⁵
 - H10 AMG carbon fibre/Black Piano Lacquer⁶
-

¹ Optional ² Included with Exclusive Nappa Leather Package (code P34)
³ Optional on S 63 AMG L ⁴ Standard on AMG Line; optional on SE Line and S 63 AMG L
⁵ Optional with Exclusive Nappa Leather Package (code P34)
⁶ Optional with Exclusive Nappa Leather Package for S 63 AMG L only (code P34)

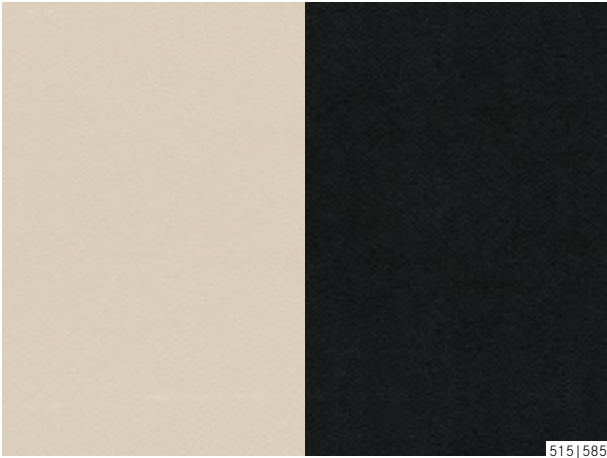

515|585



729



731



727



H06



H10



Alloy wheels



18" 5-twin-spoke alloy wheels, polished, with 245/50 R 18 tyres (standard on SE Line, code 01R)



19" AMG 5-twin-spoke alloy wheels, burnished Titanium Grey finish, with 245/45 R 19 front and 275/40 R 19 rear tyres (standard on AMG Line, code 793)



19" 5-twin-spoke alloy wheels with 245/45 R 19 front and 275/40 R 19 rear tyres (optional on SE Line, code R17)



20" AMG multi-spoke alloy wheels, burnished Titanium Grey finish, with 245/40 R 20 front and 275/35 R 20 rear tyres (optional on AMG Line, code 769)



19" AMG multi-spoke forged wheels, polished Titanium Grey finish, with 255/45 R19 front and 285/40 R19 rear tyres (standard on S 63 AMG L, code 788)



20" AMG 10-spoke forged wheels, matt black lacquer and burnished rims, with 255/40 R20 front and 285/35 R20 rear tyres (S 63 AMG L only, code 648)



20" AMG 10-spoke forged wheels, polished Titanium Grey finish, with 255/40 R20 front and 285/35 R20 rear tyres (S 63 AMG L only, code 647)

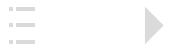

Retailer-fit accessories

Whether it's a trusted travel companion, work space or living room, there is a wide range of Retailer-fit accessories to turn your S-Class into the Mercedes-Benz best suited to your needs. → www.mercedes-benz.co.uk/accessories

Wherever you're headed, the optional Air-Balance Package adds beauty to every journey. Four interior scents create a uniquely pleasant atmosphere in the cabin.

The exterior can be further enhanced as well with a striking rear spoiler and 19" 5-spoke alloy wheels - finished

in a burnished Tremolite metallic.¹

If you want to transport sports equipment or luggage, there is a wide range of carrier systems including the flexible New Alustyle system. It can be combined with various carriers, such as the Alustyle Bicycle Rack.

Each bicycle rack can hold one bicycle and, depending on maximum roof load and usable width of the basic carrier bars, up to four bicycle racks can be fitted per pair of basic carrier bars.

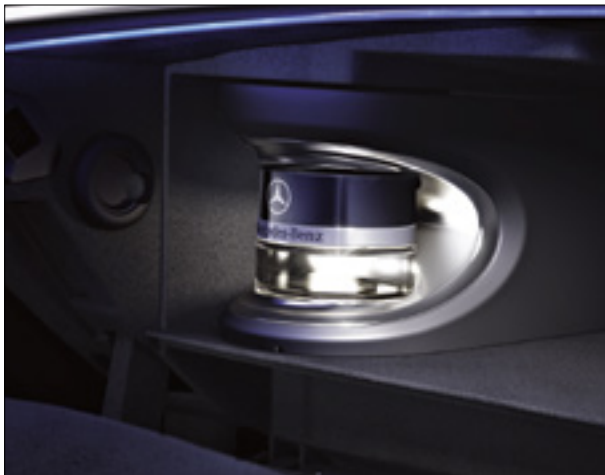

The Air-Balance Package features four beautiful scents for the S-Class interior



19" 5-spoke alloy wheels with 245/45 R 19 front and 275/40 R 19 rear tyres¹



The Alustyle bicycle rack

¹Accessory wheels are supplied without tyres, wheel bolts or wheel hubs. Availability depends on engine type and selected equipment. For further information please contact your Mercedes-Benz Retailer





Services

Test drive. Words can only do so much. Some things have to be experienced to be truly appreciated. Which is why we'd like to invite you for a test drive. Feel the power of efficient engines that offer impressive fuel consumption. Feel exhilarated by precise steering, designed to connect the driver with the road and enjoy sumptuous levels of comfort. Your Mercedes-Benz Retailer will be happy to make arrangements for you to experience the things that set a Mercedes-Benz apart. Alternatively, to request a test drive online simply visit www.mercedes-benz.co.uk/testdrive
We look forward to seeing you.

Mercedes-Benz Finance. At Mercedes-Benz Finance, our single-minded aim is to provide optimum financial solutions for all those who share the Mercedes-Benz philosophy of absolute commitment to quality. Whether you are a private customer or a business user, our finance and leasing packages can be tailored to meet your individual needs. For further information on Mercedes-Benz Finance, please contact your local Mercedes-Benz Retailer.



Mercedes-Benz Insurance offers a fully comprehensive 5-star-rated¹ Motor Insurance policy specifically designed to provide the cover you would expect from Mercedes-Benz. For a quotation, please call 0845 600 2180²

Interactive Owner's Manual. The website also offers an interactive tour, enabling you to take a closer look at your desired model. This simulation is the ideal way to acquaint yourself with your dream car. You can view key functions in detail, gain an insight into the car's inner workings or look at the benefits of each model. For further details, visit www.mercedes-benz.co.uk/sclassmanual



Roadside Assistance and Accident Management. Rest assured that should you ever need help, Mercedes-Benz Roadside Assistance is there for you. In the unlikely event of a technical breakdown³ you can rely on the Mercedes-Benz Roadside Assistance Team – anywhere in Europe. Mercedes-Benz will also assist you in the unfortunate event of an accident, from recovering your car and delivering it to your preferred Mercedes-Benz Retailer right through to managing your insurance claim in full, you will be looked after by the experts who built your Mercedes-Benz.⁴ Minor mishaps are also covered. Whether you lose your key, run out of fuel, or your vehicle is damaged due to vandalism, Mercedes-Benz ensures that you still reach your destination. Often the problem can be rectified on the spot, but if this is not possible, we will naturally ensure that your vehicle is taken to the nearest Mercedes-Benz Retailer to get you back on the road as quickly as possible.

¹ As rated by Defaqto, a leading UK independent financial research company

² Mercedes-Benz Motor Insurance is underwritten by Aviva Insurance Limited. Calls are charged at local rate and may be recorded. We may decline to quote in some circumstances

Simply phone our Customer Assistance Centre on 00800 1 777 7777,⁵ where our specialists will organise assistance for you.

Service Care. To keep a tight grip on costs, Mercedes-Benz offers service plans to cover the costs of an annual service, for two, three and four years. Plans can be paid monthly with interest-free instalments or alternatively, if you pay upfront, should you sell your vehicle any remaining services will be transferred to the new owner. All routine maintenance and additional items are covered. To find out more, please contact your local Retailer or visit www.mercedes-benz.co.uk/servicecare

³ Cover is initially valid for your vehicle for four years from the date of first registration. This can be extended from the fifth year, up to a maximum of 30 years, on completion of each scheduled maintenance service, providing that this service is carried out by a Mercedes-Benz

Mercedes-Benz World at Brooklands. Discover Mercedes-Benz racing heritage, from its connections to the famous Brooklands circuit through to present-day Formula 1™ brought to life in the most sensational way at Mercedes-Benz World in Surrey. View, touch and sit in every car from the Mercedes-Benz range, and encounter automotive legends like the ‘Gullwing’ and many other classic icons, in the UK’s largest Mercedes-Benz showcase. Then set your pulse racing by booking one of our thrilling AMG or 4×4 Driving Experiences. Relax and refuel in Café 1886, or enjoy the delicious menu and elegant surroundings of the Gullwing Bistro. For more information, visit www.mercedes-benzworld.co.uk

Retailer. Minor mishap cover is provided at the absolute discretion of Mercedes-Benz

⁴ Management of claims for non-fault accidents only

⁵ In non-affiliated European countries: +44 20 7975 7077



Dimensions

S-Class

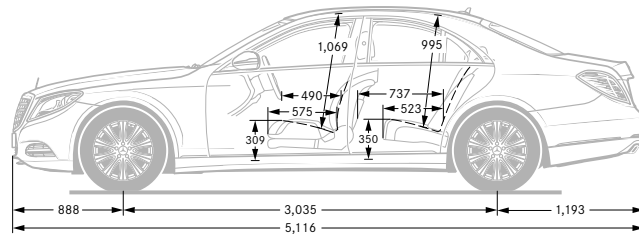
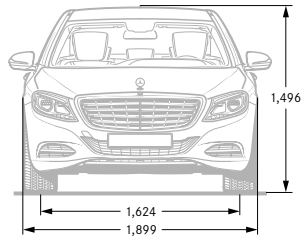

S-Class long wheelbase

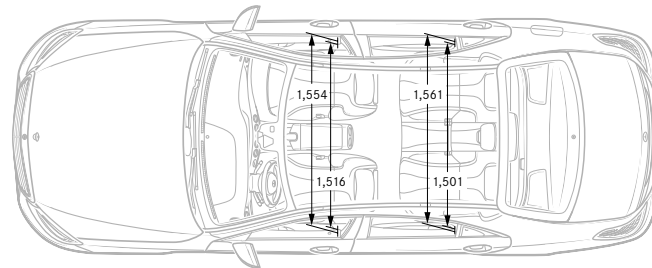
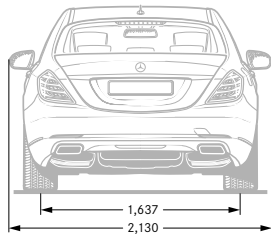
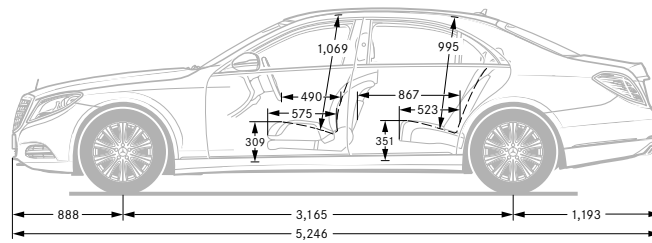
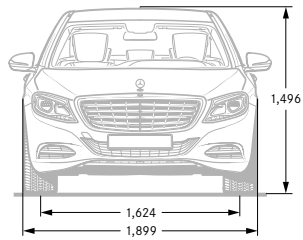

All measurements in millimetres. The dimensions shown are mean values and apply to standard-specification, unladen vehicles



Paint finishes

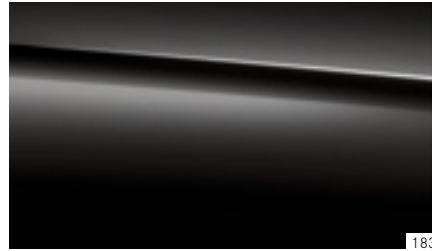

183

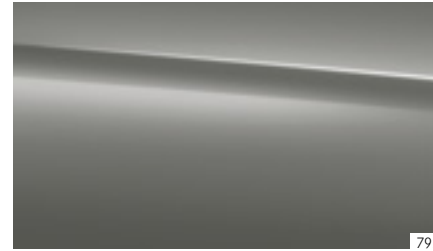

792

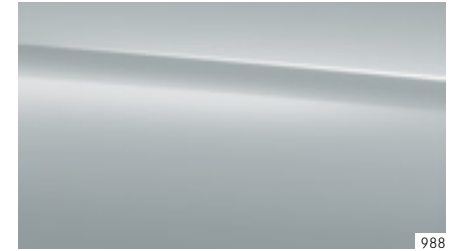

988

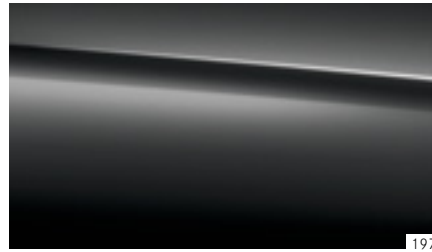

197



799¹

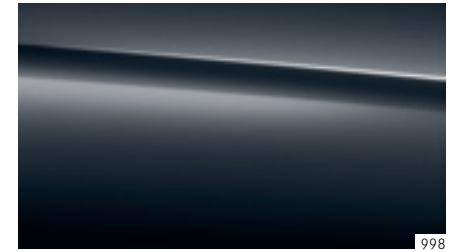

998

Metallic paints

- 183 Magnetite Black
 - 197 Obsidian Black
 - 474 Peridot Brown
 - 775 Iridium Silver
 - 792 Palladium Silver
 - 799 Diamond White¹
 - 890 Cavansite Blue
 - 897 Ruby Black
 - 988 Diamond Silver
 - 998 Anthracite Blue
-

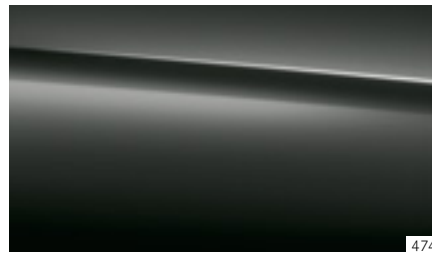

474

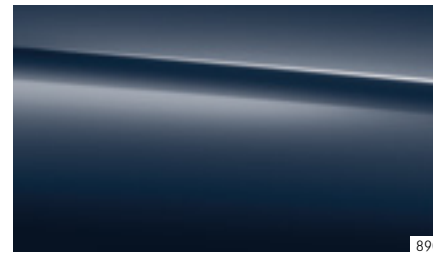

890

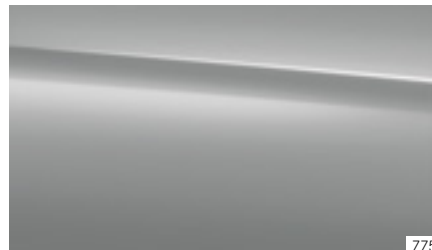

775

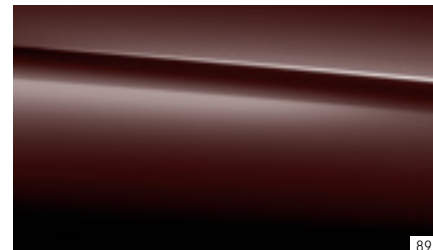

897

¹Additional-cost option



Technical data

	Diesel engine	Petrol Hybrid
	S 350 BlueTEC (L)	S 400 Hybrid L
Arrangement/cylinders/valves	V/6/24	V/6/24
Total displacement – cc	2,987	3,498
Rated output ¹ – hp (kW) at rpm	258 (190)/3,600	306+27 (225+20)/6,500*
Rated torque ¹ – Nm at rpm	620/1,600–2,400	370/3,500–5,250
Transmission	7G-Tronic Plus	7G-Tronic Plus
Acceleration 0–62 mph – sec [long wheelbase]	6.8 [6.8]	– [6.8]
Top speed, approx. – mph [long wheelbase]	155 ² [155 ²]	– [155 ²]
Tyre size	245/55 R 17	245/55 R 17
Fuel consumption ³ – mpg [long wheelbase]		
Urban	40.4 [39.8]	– [42.8]
Extra-urban	60.1 [58.9]	– [46.3]
Combined	51.4 [50.4]	– [44.8]
CO ₂ emissions ³ , combined – g/km [long wheelbase]	155–146 [158–148]	– [159–147]
EU emissions standard [long wheelbase]	EU6 [EU6]	– [EU6]
Fuel tank capacity/reserve (approx.) – l	70/8.0	70/8.0
Boot capacity – l	510	510
Turning circle – m [long wheelbase]	11.9 [12.3]	– [12.3]
Kerb weight ⁴ /Perm. GVW – kg [long wheelbase]	1,955/2,655 [1,975/2,690]	– [1,945/2,630]
Towing capacity, braked/unbraked – kg [long wheelbase]	2,100/750 [2,100/750]	– [–]

¹Figures in accordance with Directive 80/1269/EEC in the currently applicable version ²Electronically limited ³The figures shown were obtained in accordance with the prescribed measuring process (Regulation [EC] 715/2007 in the currently applicable version). The figures are not based on an individual model and do not constitute part of the product offer; they are provided solely for purposes of comparison between different vehicle models ⁴Figures according to Directive 92/21/EC, version 95/48/EC (kerb weight with fuel tank 90% full, driver, 68 kg, and luggage, 7 kg) for standard-specification vehicles. Optional extras and accessories will generally increase this figure and reduce the payload capacity accordingly ^{*}Electric motor, 20 kW For further technical data, please visit www.mercedes-benz.co.uk



	Petrol engine	
	S 500 L	S 63 AMG L
Arrangement/cylinders/valves	V/8/32	V/8/32
Total displacement – cc	4,663	5,461
Rated output ¹ – hp (kW) at rpm	455 (335)/5,250–5,500	585 (430)/5,500
Rated torque ¹ – Nm at rpm	700/1,800–3,500	900/2,250–3,750
Transmission	7G-Tronic Plus	AMG Speedshift MCT 7-speed automatic sports transmission
Acceleration 0–62 mph – sec [long wheelbase]	– [4.8]	– [4.4]
Top speed, approx. – mph [long wheelbase]	– [155 ²]	– [155 ²]
Tyre size	245/50 R 18	255/45 R 19
Fuel consumption ³ – mpg [long wheelbase]		
Urban	– [22.6]	– [20.5]
Extra-urban	– [41.5]	– [35.8]
Combined	– [31.7]	– [28.0]
CO ₂ emissions ³ , combined – g/km [long wheelbase]	– [213–207]	– [237]
EU emissions standard [long wheelbase]	– [EU6]	– [EU6]
Fuel tank capacity/reserve (approx.) – l	80/8.0	80/10.0
Boot capacity – l	530	510
Turning circle – m [long wheelbase]	– [12.3]	– [tba]
Kerb weight ⁴ /Perm. GVW – kg [long wheelbase]	– [2,015/2,730]	– [2,070/2,700]
Towing capacity, braked/unbraked – kg [long wheelbase]	– [2,100/750]	–

¹Figures in accordance with Directive 80/1269/EEC in the currently applicable version ²Electronically limited ³The figures shown were obtained in accordance with the prescribed measuring process (Regulation [EC] 715/2007 in the currently applicable version). The figures are not based on an individual model and do not constitute part of the product offer; they are provided solely for purposes of comparison between different vehicle models ⁴Figures according to Directive 92/21/EC, version 95/48/EC (kerb weight with fuel tank 90% full, driver, 68 kg, and luggage, 7 kg) for standard-specification vehicles. Optional extras and accessories will generally increase this figure and reduce the payload capacity accordingly For further technical data, please visit www.mercedes-benz.co.uk

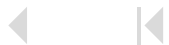

Take-back of end-of-life vehicles. Coming full circle. At the end of its long life, you can return your S-Class to us for environment friendly disposal in accordance with the EC End-of-Life Vehicle Directive.¹ But that day lies a long way off.

¹Applies in accordance with national regulations to vehicles up to 3.5 t permissible gross weight. The S-Class has met the statutory regulations governing the suitability of the vehicle's design for reuse and recycling for a number of years now. A network of vehicle take-back depots and dismantlers has been established which will process your vehicle in an environment-friendly manner. The ways in which both vehicles and parts can be recovered are subject to ongoing development and improvement. Consequently, the S-Class will be able to comply with any future increases in the recycling quota within the stipulated time limits. Further information is available at www.mercedes-benz.co.uk or by calling 0808 156 6606.

Please note: this online version of the printed brochure may contain abridged copy or other content changes. The manufacturer reserves the right to make changes to the design, form, colour and specification during the delivery period, provided these changes, while taking into account the interests of the vendor, can be deemed reasonable with respect to the purchaser. Where the vendor or the manufacturer uses symbols or numbers to describe an order or the subject of an order, no rights may be derived solely from these. The illustrations may show accessories and items of optional equipment which are not part of standard specification. Colours may differ slightly from those shown. This brochure provides a general indication of the range of models, features, optional extras and/or colours available in various countries. Some of the models, features, optional extras and/or colours shown may not be available in your country or may only be available in a different specification. Additionally, some models, features, optional extras and/or colours may only be available in combination with others. For current and more specific information in relation to the range of models, features, optional extras and/or colours available in your country, and their pricing, you should contact your nearest authorised Mercedes-Benz Retailer. E&OE. www.mercedes-benz.co.uk

Daimler AG, Mercedesstr. 137, 70327 Stuttgart BC/MC 6701 · 0616 · 88-00/0713

