

Caravelle



✓ **Customise your interior**
Rail-mounted seating for seven

✓ **Work on the move**
Swivelling seats and table

✓ **SE and Executive**
A choice of stylish trims

Business class

A new Caravelle edition with outstanding levels of passenger luxury



INSIDE



The sky's the limit
Loads of options to bring you even more comfort



7 ways your Van Centre can help you

PLUS Tips for picking your ideal Caravelle • How our warranty works for you • Ways to finance your vehicle

Whatever you're after, we've got a Caravelle for you



TREAT YOUR PASSENGERS to the ultimate ride. The Volkswagen Caravelle is one of the most flexible people carriers on the market. With the ability to comfortably seat up to six passengers and their luggage, while still offering a driving experience similar to a luxury car, it's the perfect people mover.

The SE and Executive models feature flexible bench seating in the rear, which lets you modify the space to suit your passengers' needs, thanks to a clever rail-mounting system. The top-of-the-range Caravelle Business creates the ultimate mobile conference facility, with luxury passenger seating, onboard Wi-Fi and an integrated refrigerator.

Every Caravelle comes with a choice of efficient 2.0-litre turbo-diesel engines, and given that they're as economic as they are powerful and refined, you can look after your wallet as well as your passengers.

INTRODUCING THE CARAVELLE SE

- ✓ Choice of 2.0-litre TDI 140PS and 2.0-litre BiTDI 180PS engines
- ✓ Electric wing mirrors and windows
- ✓ Flexible rail-mounted seating
- ✓ RCD 310 Radio/CD player
- ✓ Long-wheelbase version for even more space
- ✓ Climatic manual air-con

Caravelle SE

>p16



INTRODUCING THE CARAVELLE EXECUTIVE

- ✓ Cruise control
- ✓ Climatronic automatic air-con
- ✓ Privacy glass in rear
- ✓ Electric side-sliding doors
- ✓ Power-latching tailgate

Caravelle Executive

>p18



Caravelle Business

>p20



INTRODUCING THE CARAVELLE BUSINESS

- ✓ Luxury two-seat rear seating console with integrated refrigerator
- ✓ Nappa leather upholstery with burr walnut trim
- ✓ RNS 510 sat-nav system with a 6.5" touch-screen, DVD drive and 30GB HD for music and map storage
- ✓ Onboard Wi-Fi and Bluetooth mobile phone system
- ✓ Electrically adjustable, heated seating
- ✓ Seven-speed Direct-Shift Gearbox as standard
- ✓ Xenon headlights with daytime running lights

Make your next move

Find out why Volkswagen is a brand you can trust

>p4

Go straight to the Caravelle to learn more

>p8

Contact us now:

To find the location of your nearest Van Centre, get a brochure or book a test drive:

0800 717131

www.volkswagen-vans.co.uk

Get connected:

Volkswagen_CV

VolkswagenCommercialVehiclesUK

vwcommercialvehicles

www.volkswagen-vans.co.uk/vanmail

Delivering the goods. It's what we've always done...

Today's much-loved, award-winning Volkswagen vans are only the latest step in a 60-year journey that started with one clever idea

In 1947, Dutch importer Ben Pon spotted workers at Volkswagen's Wolfsburg factory using a stripped-down Beetle to move parts around. Inspired, he sketched the platform for a versatile commercial vehicle that could be adapted to a multitude of uses. From this sketch, the Transporter was born, and the van world has never looked back.

Brilliant then, even better now

Since 1950, millions of Transporters have been built and have proved to be reliable workhorses for delivery drivers and tradesmen all over the world. There's more to owning a Volkswagen than just work, though – Volkswagen vans have always stood out from the pack, which has helped them build a loyal following, from the original 'Splittie' to today's sleek, modern models.

Reliability that endures

Today, Volkswagen's commercial vehicles are more popular than ever, with a diverse range of panel vans, kombis, chassis cabs, passenger carriers, camper vans and even pick-ups. Each is as versatile, spacious and reliable as Volkswagens have always been, but now they're more comfortable, easier to drive and more fuel-efficient than ever before. They're all backed up by a Van Centre network that's ready to solve any problem you may have, too.

Getting the job done efficiently and reliably has been at Volkswagen's heart for the last 60 years, and that's why you can trust us to deliver a van that works for you.

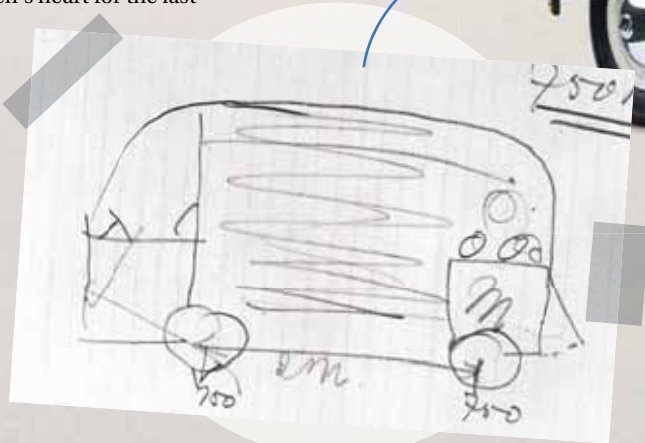

Transporter

The Transporter has been the mainstay of our van range since 1950. It still embodies the original's attributes of space, versatility and reliability, but is now more efficient than ever.

California

The definitive Volkswagen camper van is a true home from home, with four sleeping berths, a fully fitted kitchen and an electric pop-up roof.



Caddy

The compact Caddy has city-friendly dimensions and a car-like feel, but it can still carry big loads or plenty of passengers. Wide rear doors make loading simple, too.



Crafter

The Crafter is the van to have for seriously big tasks. It's available as a van, a chassis cab that you can customise in lots of ways or a window van, and has a payload of up to three tonnes.



Amarok

The Amarok joined the range in 2011. Its off-road and load-shifting credentials earned it the 'International Pick-up of the Year' award, and press praised its comfort and ease of driving.



Caravelle

For the ultimate level of executive comfort, only a Caravelle will fit the bill. It's an outstanding, flexible passenger carrier that can carry people and their luggage efficiently and easily.



Trust your Van Centre network

OWNING A VAN is about more than just the vehicle – it's about support, too. That means helpful advice, affordable finance, and maintenance and servicing to keep your van running more efficiently for longer.

That's where our network of over 100 Van Centres and Authorised Repairers comes in. All our staff are fully trained to solve any problem you may have.

• Find out how your local Van Centre can help right now – see pages 26-27.

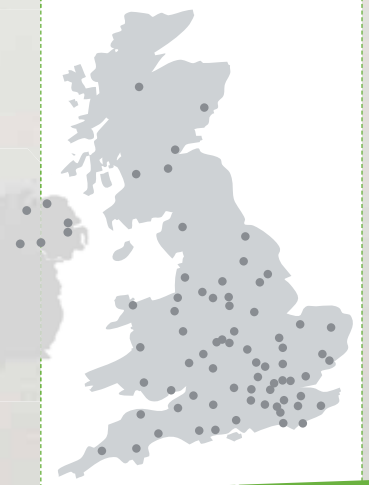

  To find your nearest Van Centre or order a brochure, visit www.volkswagen-vans.co.uk or call 0800 717131

Volkswagen round-up

Accolades and awards ● BlueMotion Technology across the range ● New trims for Caddy and Transporter

Volkswagen vans shine under awards spotlight



Volkswagen Commercial Vehicles has won a host of awards in recent months, including the title of 'Manufacturer of the Year' for 2012 from *Van Fleet World*.

The magazine also awarded the Transporter its 'Best Medium Van' prize, while the Caddy was 'Best Small Van'.

The Transporter was named 'Medium Panel Van' and 'Fleet Van of the Year' for 2012 by *Fleet Van*, while the top-of-the-range Transporter Sportline was *What Van?* magazine's 'Editor's Choice'.

The Caddy 4MOTION® was *What Van?*'s '4x4 of the Year', while the Amarok won 'Pick-up of the Year' from *What Van?* and 'Best Pick-up' at the British Insurance Vehicle Security Awards. The Amarok is also *4x4 Magazine's* 'Pick-up of the Year'.

To cap it all, Volkswagen Commercial Vehicles topped the *Fleet News* FN50 Reliability Survey as the 'Most Reliable Van Manufacturer', with the Caddy, Transporter and Crafter all in the top six.

These awards recognise and prove that our promise to you is truly alive and well. That promise is to bring you products that are more versatile, reliable, efficient and better value for money than ever.



Caravelle Edition 25 is a hit

The limited-edition Caravelle Edition 25 – packed with a wealth of the most exclusive options – was hugely popular when orders opened in January. Make sure you don't miss the next special edition – follow our Twitter feed at [Volkswagen_CV](#)



BlueMotion Technology is here

BlueMotion Technology offers increased fuel efficiency and reduced carbon emissions, and it's available on most models in our range. To find out how BlueMotion Technology can help cut your fuel bills, ask your Van Centre for details.

Finance that makes buying your vehicle easy

Getting your hands on a new van or passenger carrier from Volkswagen Commercial Vehicles could be even more affordable – and easier – than you think.

We've got a great range of finance deals that allow us to tailor a solution to the needs of your business and your pocket. That might be a lower initial deposit, or regular, fixed monthly payments that include pre-planned costs

for servicing and maintenance. It all helps you know exactly how much your vehicle will cost now and over the long term.

We have special finance offers, too, which offer you even more value for money, and they're regularly updated. You can find all the latest deals at [www.volkswagen-vans.co.uk](#), or pop into your local Van Centre to find out how we can help you.



Get connected with us online

We've got lots of ways to stay up to date with all that's going on in the world of Volkswagen Commercial Vehicles.

Sign up to Van Mail for the latest news and finance offers, or follow us on Twitter and like us on Facebook for a great mix of news, tips and exclusive competitions.

Our YouTube channel is packed with useful and fun videos, too. To stay connected, just add the links below to your browser's favourites.



New trims offer outstanding value

Now there's even more choice for Caddy and Transporter buyers, thanks to the introduction of new trims that offer a great pack of features at one easy price.

That makes buying a van with a high level of specification really simple and delivers you great value for money.

On Transporter panel vans and kombis, and Caddy panel vans,

Trendline and Highline trims bring extra features to the already well-appointed standard model. On the Transporter, you can also go for the ultra-high-level Sportline trim to really mark out your van and your business from the pack.

If you need to add even more features, there's an extensive list of factory-fit options and Add On accessories.



Get even more with Add Ons

Add Ons is Volkswagen Commercial Vehicles' range of accessories, with lots of work, technology and leisure products that can be fitted by your Van Centre at any time. See page 45 for more details.

Contact us now: To find your local Van Centre, get a brochure for a different model, or book a test drive: 0800 717131 [www.volkswagen-vans.co.uk](#)

Get connected: [Volkswagen_CV](#) [VolkswagenCommercialVehiclesUK](#) [vwcommercialvehicles](#) [www.volkswagen-vans.co.uk/vanmail](#)

Contents

All your vehicle-buying questions answered

What is it like to drive? > p10

Which engine do I need? > p14

What trims are available? > p16

What support can I expect? > p24

How much does it cost? > p28

What options can I choose? > p29

What are the facts and figures? > p46

Vehicles shown on the following pages may contain factory-fitted options that are available at an additional price



Work out how much it costs
 Use our calculator to find out the total cost of the vehicle and options you're choosing. Then take this page into your Year Coster.

Keep track of your costs
 The Year Coster is a handy checklist to help you keep track of all the costs of your vehicle and options you're choosing. You'll find it inside the back cover.

Add it all up... Keep track of your vehicle, engine and option choices using our handy checklist – you'll find it inside the back cover



"For an executive chauffeur, space and comfort are crucial. The Caravelle carries seven people and their luggage without compromising the quality of our passengers' travel experience."
 Stephen Darler



"The Caravelle provides our clients with the best possible levels of comfort and space, as well as being stylish and reliable."
 Dan Whitehouse, Titan Travel

Driving

Get from A to B easily and in comfort



"The convenience and smooth changes of the Direct Shift Gearbox make it a must for any driver in our profession."
Stephen Darler

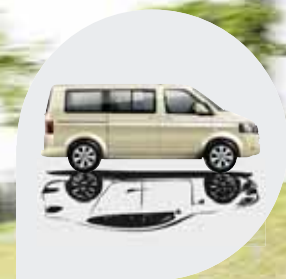

Parking is easy

The Volkswagen Caravelle is about the same length as a family saloon, making it easy to park. If you add front and rear sensors, squeezing into tight spots will become even easier.

Effortless, refined driving wherever you're going

No matter how long your journey will be, or where it's likely to take you, the Caravelle will get you there in style and comfort

Whether it's a shuttle-run around town or a long-distance trip, the Caravelle's car-like manoeuvrability and comfort ensure that you'll enjoy the journey as much as your passengers do. Thanks to a choice of refined 2.0-litre TDI engines, and an easy-to-shift manual gearbox or automatic Direct Shift Gearbox, the Caravelle will take you where you want to go in true comfort.

Geared up for easy shifts

The Caravelle comes with a six-speed manual gearbox, with an easy-to-reach dash-mounted gearlever. You can also opt for the convenience of our seven-speed, Direct Shift Gearbox (DSG) – its slick automatic gear changes make it great for city driving but you can always take control and change gear yourself by simply nudging the gear lever up or down.

Comfort and safety as one

Volkswagen's advanced ESP (Electronic Stabilisation Programme) works with ABS (Anti-lock Braking System), EBD (Electronic Brakeforce Distribution) and TCS (Traction Control System) to keep you safe on the road, while Hill Hold Assist makes hill starts a doddle. In the cab, driver and passenger front and side/head

airbags are fitted as standard. Optional side/head airbags provide protection for passengers in the rear.

Choose your own path

If you ever need to take your Caravelle to locations off paved roads, or just want to stay safer on slippery surfaces, Volkswagen's optional 4MOTION® system could be the answer. This intelligent all-wheel-drive system monitors the grip levels of all wheels and automatically sends power to those that need traction the most when conditions become slippery. In normal driving, it reverts to sending more power to the front wheels to ensure maximum fuel economy.



The Caravelle's car-like cabin will help ease you into your journey. A six-speed manual gearbox comes as standard

Driving tech explained



Direct Shift Gearbox (DSG)

Our seven-speed, Direct Shift Gearbox (DSG) is great for city driving. It can be used as a fully automatic gearbox or as a quick-shift manual – just nudge the gear lever forwards or backwards to change gear up or down.

4MOTION

4MOTION® is an all-wheel-drive system that helps maintain optimum grip in all conditions. If one wheel loses traction, 4MOTION® reacts in milliseconds and sends power to the wheels with the most grip.

A new level of driving comfort

Beautifully designed and jam-packed with innovative features, the Caravelle's cab is a great place to spend time, no matter where your journey might take you

Whether you're counting down the motorway miles or taking on some twisty country lanes, the Caravelle really is the vehicle to suit all occasions, thanks to its combination of car-like manoeuvrability and premium practicality.

The perfect fit for you

Behind the wheel, you'll notice that the feature-packed dashboard feels truly intuitive to use. The ergonomically designed front seats are adjustable for height, lumbar, reach and rake, meaning you'll always be able to find the perfect driving position. And don't worry if you need to stay in touch: Bluetooth connectivity is just one of many options available – and it's fitted to Business models as standard – to help your journey pass without hitch.

Comfort and safety as one

Inside the cab, you'll find the high level of comfort and safety that you'd expect from Volkswagen. Front airbags come as standard, and air-conditioning will keep you cool. And in the winter, heated seats (optional on SE) mean you'll stay warm during early-morning starts.



Electric windows and mirrors are fitted as standard

Optional Bluetooth connectivity allows you to use a phone without taking your hands off the wheel. It works with the Caravelle's multi-function display



"Our Caravelle seats a lot of people comfortably, with room for their bags and plenty of space. It's also nice and easy to drive."

David Winter, Parker Cars

Ultra-clear dashboard

All the controls are easy to use, so you stay focused on the road. A gearshift indicator helps you change gear at the most economical moments.

Comfy seats

Our comfortable seats offer terrific support. **Want more?** Seat options allow you to choose a passenger layout that's perfect for you (see page 42). For even more style, pick a leather upholstery



Cool and comfortable

Heat-reflective glass keeps things cool, even in the summer.

Want more?

Choose air-conditioning – this gives you even more temperature control. See page 40.

Entertainment and sat-nav to suit you

Want to play MP3s, listen to DAB radio or add Europe-wide sat-nav? We've got just the kit for you. See page 34.

Three-spoke steering wheel

The three-spoke steering wheel is comfortable and easy to use at all times.

Want more?

Go for a multi-function steering wheel – this lets you control the audio system and a Bluetooth phone. See page 39.



Built with experience and comfort in mind

WITH 60 YEARS of building Transporters and Vans to its name, Volkswagen knows how to produce the very best people-movers. In addition to the flexible rail-mounted seating, the Caravelle boasts ample luggage and storage compartments, air-conditioning, electric windows with blinds, twin sliding doors and a neat multi-function table as standard.



Your local Van Centre can help you choose the right options for you. Find your nearest one on www.volkswagen-vans.co.uk, or call 0800 717131

Engines

Technology that helps to cut fuel bills and lower emissions

TDI TECHNOLOGY

Intelligent power, efficient delivery

A choice of two advanced 2.0-litre diesel engines enables you to pick the performance and economy that best suits your needs

Volkswagen's range of 2.0-litre turbo-diesel engines offers the perfect balance of performance and economy for your Caravelle. What's more, thanks to our years of experience spent honing advanced turbo-diesel technology, our new TDI engines are quieter, more powerful and more fuel efficient than ever before.

Travel business class

The Caravelle SE and Caravelle Executive come with the option of a 2.0TDI 140PS engine with

340Nm of torque and fuel economy of up to 39.2mpg (combined). A 2.0-litre 180PS BiTDI engine is also available. The twin-turbo unit provides an impressive 400Nm of torque, but still offers fuel economy of 38.7mpg (combined) and CO₂ emissions of 192g/km. That makes it the ideal choice for powering the luxurious, top-of-the-range Caravelle Business.

Add in the smooth delivery of an optional Direct Shift Gearbox (DSG) and 4MOTION® four-wheel-drive on all models, and it makes the Caravelle the best way to get executive passengers to their location.

Engine specifications

See page 46 for full engine data

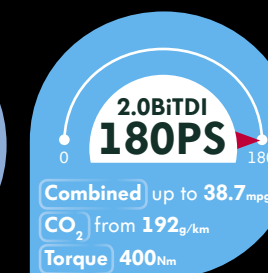
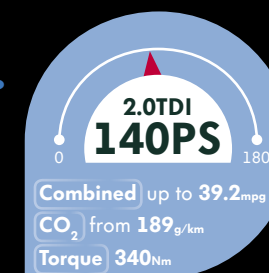

Add a sat-nav

A sat-nav system can plot shorter routes and prevent you making wrong turns – some can even navigate around traffic jams. It all helps cut fuel consumption.



Driver training

Driver training can teach you to drive more safely and more economically. Ask the Freight Transport Association (www.fta.co.uk) for details on a course to suit you.

Top tips to help you save fuel

Cutting fuel use isn't just about engine technology – it's also about being clever. Follow our four tips to make your van as economical as possible.

Use your gearshift indicator

A gearshift indicator is fitted to all Caravelles. It helps you change gear at the most efficient times, which cuts fuel use and lowers emissions.



Check your tyres

Up to 20% of a vehicle's fuel consumption is used in overcoming the tyres' rolling resistance. It's even more if your tyres are underinflated, so check them regularly.



Why torque matters

Torque is often more important than power when it comes to an engine's performance. If you carry heavy cargo often, pick an engine with lots of torque. It will move a heavy load from a standing start better than one with less torque, and keep it moving more easily. A torquey engine may even use less fuel, because you won't need to rev it as much to get the best out of it.

Trims

A great range of trims that offer value and choice

Tailor-made for you

After designing and producing passenger carriers for more than 60 years, Volkswagen knows exactly how to create generous space and exceptional comfort. Not only that, but ingenious touches such as the rail-mounted collapsible table help make the most of the interior space. Twin sliding doors allow easy access for passengers at the beginning or end of the journey.



Caravelle SE

Style and luxury as standard

The Caravelle SE comes with a high level of features that ensure your passengers have a journey to remember

The Caravelle SE is supremely equipped to help your business stand out from the crowd. Body-coloured bumpers and door handles, as well as body-coloured electric mirrors, set the tone for the chrome trim detailing and alloy wheels. Side-sliding doors with power-latching on both sides of the vehicle allow access easy for passengers, while the tailgate opens into a spacious luggage compartment.

Flexibility for any occasion

The Caravelle's innovative rail-mounted seating system lets you create the layout your passengers need. Arrange the swivelling single seats and the sliding three-seater bench for a meeting around the central table, or fold and slide the seating to create more space for luggage or equipment.

Comfort as standard

Driver comfort comes high on the list, with driver and front passenger seats that include height-, reach- and rake-adjustment, as well as armrests. Electrically adjustable door mirrors and electric windows, as well as manually controlled Climatic air-conditioning, allow the driver to keep things cool while focusing on the task at hand.



Stylish body-coloured bumpers and alloys both come fitted as standard to the Caravelle SE

Leather seats

Upgrade to the Nappa leather seating option – available in a choice of two colours – for hard-wearing, luxury upholstery.

Safety guaranteed

The Caravelle SE has a comprehensive list of driver aids and safety features as standard. Top of these is the Electronic Stabilisation Programme (ESP), with Anti-lock Braking (ABS) with Electronic Brakeforce Distribution (EBD), Engine Braking Control (EBC) and Traction Control (TCS) all included as standard. Hill Hold Control helps you to make safe hill starts. Halogen headlights with daytime running lights, added to fog lights with a cornering function, keep the view ahead clear. At the rear, the hazard-warning lights come on automatically under emergency braking to alert other drivers to a potential danger.

SE features



- ✓ Body-coloured bumpers and electrically adjustable mirrors
- ✓ 16" Colmar/17" Thunder alloys
- ✓ Nearside and offside sliding doors with power-latching
- ✓ Rear tailgate with heated window and wash/wipe system
- ✓ Power steering
- ✓ Leather-covered steering wheel, handbrake and gear knob
- ✓ RCD 310 Radio/CD player
- ✓ Electric windows
- ✓ Climatic air-conditioning
- ✓ Driver-side and front curtain, and passenger airbags
- ✓ Two removable, adjustable, foldable swivelling seats
- ✓ Removable three-seater bench
- ✓ Multi-function table
- ✓ Rear heater

Caravelle Executive

Travel in the Executive suite

The Caravelle Executive adds a great selection of options to your vehicle, providing even more luxury in one easy, affordable move

The Caravelle Executive takes everything that's great about the Caravelle SE, and adds a whole host of extras to ensure that your vehicle is even more luxurious. On the outside, 17" Neva alloy wheels give an added edge to the Caravelle's stylish



Choose the optional headlight washers with heated washer jets to help you keep your headlights bright

looks, while privacy glass in the rear passenger compartment helps increase the Caravelle Executive's truly VIP feel.

Extras that make life easy

Electric side-sliding doors that can be controlled from the centre console, as well as power-latching on the tailgate, make passenger and luggage loading even easier. Meanwhile, smart Alcantara® leather upholstery adds extra luxury to the interior.

Premium features

Up front, the driver has a range of premium features such as heated windscreen-washer jets, rain sensors and Servotronic speed-dependent power-steering. And with cruise control fitted as standard, journeys can be smoother and more fuel-efficient – particularly over long distances. For the finishing touch, heated front seats and electronically controlled Climatronic three-zone air-conditioning at the front and rear ensure that the interior environment is the perfect temperature for everyone.



Cruise control

Cruise control is fitted as standard on the Caravelle Executive. By keeping your vehicle at a constant speed, it reduces driver stress and helps keep fuel bills low – especially on long journeys.

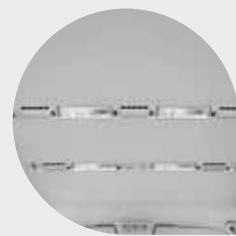

Stay cool

The Climatronic air-con system with three-zone temperature adjustment automatically sets and regulates the interior temperature, so you're comfortable – whatever the conditions outside.



Executive features

(In addition to Caravelle SE)

- ✓ 17" Neva alloy wheels
- ✓ Automatic rain sensors
- ✓ Electric side-sliding doors
- ✓ Power-latching tailgate
- ✓ Alloy spare wheel
- ✓ Climatronic three-zone automatic air-conditioning
- ✓ Alcantara®/leather upholstery
- ✓ Cruise control
- ✓ Heated driver and front passenger seats
- ✓ Privacy glass
- ✓ Servotronic speed-dependent power-steering

The California Executive, fitted with optional 18" Canberra alloy wheels

Caravelle Business

Born for business

The spacious, stylish Caravelle Business is a truly first-class passenger experience

When you're ferrying your most important clients from one meeting to another, you want to be sure that they get there in style and comfort. The new Caravelle Business edition takes all the great features of the Caravelle SE and Executive to a prestigious new level.

1

STYLE THAT STANDS OUT

The Caravelle Business has real road presence, thanks to Xenon headlights with LED daytime running lights and fog lights with cornering function, as well as chrome detailing and 17" Neva alloy wheels. Darkened rear light clusters complete the look.



2

SMOOTH POWER AND DELIVERY

Both Caravelle Business models use the range-topping 180PS 2.0-litre BiTDI engine, delivering plenty of power and torque from the twin-turbo diesel engine without compromising the smoothness of the ride, or fuel economy. The refined driving experience is made even more impressive for the occupants with the addition of a laminated windscreen for improved noise damping.

3

EASY-SHIFTING AND SECURE DRIVING

Our automatic seven-speed Direct Shift Gearbox (DSG) is fitted as standard to the Caravelle Business to make city driving even easier. You can also choose the sophisticated 4MOTION® four-wheel-drive system, to keep a sure footing on slippery terrain or in bad weather.

4

CLEVER TECH

Getting your passengers where they need to go is made even easier with the addition of the RNS 510 sat-nav system, which can be controlled by voice or via the 6.5" colour touch-screen. Front and rear parking sensors are also fitted, along with a reversing camera that guides you into tight spaces. To make life even easier for the driver, the leather steering wheel includes multi-function controls for the radio, sat-nav and phone.



Caravelle Business (cont.)



5

KEEPING COOL AND RELAXED

The Caravelle Business features electronically controlled Climatronic three-zone front and rear air-conditioning, perfect for maintaining a pleasant interior. In winter, or for chilly early-morning starts, passengers can enjoy a warm interior from the off, thanks to the programmable rear heater. The auxiliary heating works independently of the ventilation systems, and is available with remote control.

6

STAY CONNECTED

Voice-controlled Bluetooth ensures that everyone in the Caravelle Business can stay in touch with the people who matter. The addition of Wi-Fi wireless internet access takes the phrase 'working on the road' to a new level. This way, you can connect your smartphone, tablet or laptop from any seat.

7

TRAVEL IN FIRST CLASS

For a truly executive experience, a smart and luxurious two-person rear seating console replaces the standard three-seat bench. Both the console and the two swivelling single passenger seats are heated for extra comfort, while burr walnut trim, Nappa leather upholstery and an integrated refrigerator complete the premium look.



9

WELL ORGANISED

The ingenious multi-function table provides a work surface, and there's a useful storage unit with drawers. When not in use, the table top can be turned by 90°, folded and lowered into its base. It can also be slid along the centre rail mountings between the middle single seats.

10

AN EVEN SAFER DRIVE

The Caravelle is packed with features that make driving safer. These are enhanced in the Caravelle Business with the addition of Lane-Change Assist. Here, sensors monitor vehicles in your blind spot, and notify you of any overtaking traffic with a visual signal in the right or left wing mirror. This makes the ride even more trouble-free for you and your passengers. The Business Edition also adds curtain airbags for the rear passenger compartment.



Business features

Exterior

- ✓ Darkened rear light clusters
- ✓ Xenon headlights with LED daytime-running lights and fog lights with cornering function
- ✓ Body-coloured bumpers and electrically folding door mirrors
- ✓ Laminated windscreen for improved noise damping and passenger comfort

Interior - cab

- ✓ Leather steering wheel with multi-function controls
- ✓ RNS 510 radio/CD/DVD/sat-nav
- ✓ Voice-controlled Bluetooth connectivity

Interior - passengers

- ✓ Nappa leather upholstery
- ✓ Integrated refrigerator
- ✓ Wireless internet connectivity
- ✓ Parking heater, with programmable timer and remote control
- ✓ Burr walnut wood trim
- ✓ Privacy glass

Safety and driving

- ✓ Lane-Change Assist (with cruise control)
- ✓ Parking sensors - front and rear, with reversing camera
- ✓ Automatic headlight activation (with 'coming home' and 'leaving home' function)
- ✓ Rear-compartment curtain airbags

Full support right from the start

We want to make sure that using your van is as hassle-free and cost-efficient as possible, so every vehicle comes with a three-year warranty and a choice of finance, servicing and insurance options. It all helps to keep the big issues covered



A three-year warranty that lasts up to 100,000 miles

All Caravelles get a three-year, 100,000-mile warranty – and so do any factory-fit options that you buy. The vehicle warranty is made up of:

- A two-year manufacturer's warranty with unlimited mileage
- A third-year Van Centre warranty, up to a maximum of 100,000 miles

Even if you exceed 100,000 miles during your first two years, the manufacturer's two-year warranty will still be valid.

Want cover for longer?

You can extend your vehicle warranty online or by phone. You can choose Comprehensive or Major Component cover and either one-off or monthly payments. Call **0845 641 9712** or visit www.volkswagencvwarranty.co.uk for details.



Service options designed to fit your business perfectly

It's only natural that you want to keep your vehicle running at its best. Getting it serviced at a Volkswagen Van Centre is a great way to ensure that's exactly what happens. However, when it comes to servicing, we know every business has different needs. That's why we've developed three different service options for you to choose from:

- Pay Monthly
- Pay Upfront
- Pay On-Demand

Whichever suits your business best, you can rest assured that when you book in your vehicle, it'll be looked at by Volkswagen-trained technicians and they'll use only Volkswagen quality parts. What's more, there's a two-year warranty on the parts and one on labour.

For more details

visit www.volkswagen-vans.co.uk, or call **0800 717131** to learn more.



Volkswagen Insurance keeps you covered*

Volkswagen Commercial Vehicle Insurance can provide you with cost-effective, comprehensive motor insurance. Look at some of the benefits:

- Seven-day free cover to allow you to drive your vehicle away knowing it's insured
- All repairs performed by approved repairers
- Volkswagen quality parts on all repairs
- Courtesy vehicle provided during repair following an accident
- Cover for breakage and damage to glass
- Tools-in-transit cover (up to £1,000)
- In-vehicle personal belongings cover (up to £500)
- Vehicle recovery
- 60-day European Union cover
- Legal expenses cover up to £100,000

We also offer a range of gap insurance products. These help you replace your vehicle or protect you from any financial shortfall if it is written off.

For more details

visit www.insurewithvwcv.co.uk, call **0800 316 7896** or pop into your Van Centre and ask for a Flexible Finance brochure.

* Terms and conditions apply

"If your van's not working, you're not working. That's why we're here to help"



Flexible Finance that makes things affordable

We can also make buying a new van more affordable in the first place. Speak to us about our selection of finance options, which include:

- Contract hire
- Finance lease
- Lease purchase
- Hire purchase

For more details

visit www.volkswagen-vans.co.uk/finance or pick up our Flexible Finance brochure at your nearest Van Centre.



Three years' Roadside Assistance

Sometimes, the unexpected happens. If it does, your new Caravelle comes with an unlimited-mileage recovery and assistance package. It lasts the same three years as your warranty and operates 24 hours a day, 365 days a year.

Cover is available across the UK and most of Europe. Our fully trained technicians can diagnose most problems at the roadside and they use Volkswagen quality parts.

Learn more

Visit your Van Centre to get a Volkswagen Roadside Assistance handbook, visit www.volkswagen-vans.co.uk/aftersales/roadside-assistance or call **0800 77 71 72**



Van Centres – always there for you

Our dedicated Van Centre network is the backbone of everything we do, with more than 100 Van Centres and Authorised Repairers throughout the UK

Our Van Centre network offers a wide range of services, from MOTs to accessories, servicing to fully fitted parts. Not only that, but we use Volkswagen quality parts and you get dedicated staff who understand your vans intimately. So pop in for a coffee and a chat, and find out what your Van Centre can do for you.

Turn the page to learn more about our Van Centre network

7 ways your Van Centre can help you right now

Make full use of your nearest Van Centre – it's full of Volkswagen experts who know your vehicle better than anyone and who can help you to get the best out of it



Quality servicing you'd expect at a price you wouldn't

Unpredictability and moving goalposts are part of life for a modern business, making it difficult to predict how many miles your vehicle will do in a year, or how long you'll need to keep it. Our National Service Pricing is designed for customers who need the flexibility of being able to book their vehicle in for a service whenever it needs it. When you do, our technicians will do everything necessary to ensure that your vehicle is back on the road, working hard for your business, as soon as possible.



Always on hand to help

Picking a van that's perfect for your needs

We know that choosing your next van or passenger carrier is a big decision. You want a vehicle that works as hard as you do, both now and for the long-term – one that's versatile, cost-effective and reliable. We're here to help make your choice easier.

Our Van Centre experts can offer advice on every model in the range and help you pick the right vehicle and factory-fit options for your business. They can also advise you on the best finance packages to ensure that your payments make financial sense.



Express Visual Checks – peace of mind for free

Your Van Centre or Authorised Repairer can give your vehicle a free, 29-point Express Visual Check for complete peace of mind. You'll be given a comprehensive report, with the results clearly explained, and your technician will talk you through what work may need to be done in the future, so you can plan ahead and budget for it. If something needs urgent attention, you can get a precise quote before any work is done – and all the Volkswagen parts are covered by a two-year warranty.

Accessories designed to help you get more from your van

Perhaps you've bought a van and your needs have changed – maybe you need a towbar or a roof rack, or perhaps you want to give your van some extra style. That's where Add Ons comes in. Add Ons is an extensive range of Volkswagen-approved accessories, available to buy and be fitted at your local Van Centre. We've got everything from towbars to tailgate spoilers, load nets to leather seats and sat-nav systems to stunning alloy wheels.



Fast, hassle-free van rental for one-off jobs

Need another van for just a short while? We can hire you any vehicle from our fleet – Caddy, Transporter or Crafter – or passenger-carrier versions of the Transporter and Crafter if you need to move people.

For more information, call the Van Rental team on 01908 467450



Fully fitted parts for a fixed price – and not a penny more

The pricing of all our Volkswagen quality parts is straightforward and clear, so you know exactly how much you're paying. Even better, when they're fitted by trained technicians at a Van Centre or Authorised Repairer they come with two years' warranty and 12 months warranty on labour. If your van is over five years old, ask us about our Economy Parts range. This is a great-value way to help keep your vehicle 100% Volkswagen – it uses high-quality parts that come with a two-year warranty.



Taking the worry out of tyres

Why run around looking for a fitter who has your tyres in stock? Let us fit new tyres when your van is in for its service and it'll keep your van off the road for less time. We have a huge range of tyres for all Volkswagen vans, from economy to premium brands, including winter tyres.



What else can we do?

Loads! Just pop into any Van Centre and ask us. For example, we may be able to point you to a local signwriter, recharge your air-conditioning, or answer any queries about your vehicle. Whatever it may be, we're here for you.



To find your nearest Van Centre, visit www.volkswagen-vans.co.uk or call 0800 717131

Prices

Every Caravelle listed. All the prices you need

Want to work out how much your Caravelle costs? Use our tracker on the back cover



Every Caravelle comes with an On The Road package that covers your basic costs

On The Road (OTR) package	A	B	C
First registration fee	£55.00	£55.00	£55.00
Delivery to Van Centre	£565.00	£565.00	£565.00
VAT	£117.00	£117.00	£117.00
Vehicle Excise Duty (12 months)	£460.00	£600.00	£815.00
Number plates	£20.00	£20.00	£20.00
Basic OTR (ex VAT)	£1,100.00	£1,240.00	£1,455.00
Total OTR price	£1,217.00	£1,357.00	£1,572.00

Caravelle



Engine/transmission	Basic (ex VAT)	Total (inc VAT)	Total RRP including OTR*		OTR Package	Insurance group†
			(ex VAT)	(inc VAT)		
Caravelle SE – short wheelbase with BlueMotion Technology						
2.0TDI 140PS	£28,310.83	£33,973.00	£29,410.83	£35,190.00	A	TBC
2.0TDI 140PS DSG	£29,710.83	£35,653.00	£30,950.83	£37,010.00	B	TBC
2.0TDI 140PS 4MOTION®	£30,523.33	£36,628.00	£31,763.33	£37,985.00	B	TBC
2.0BiTDI 180PS	£29,927.50	£35,913.00	£31,027.50	£37,130.00	A	TBC
2.0BiTDI 180PS DSG	£31,327.50	£37,593.00	£32,427.50	£38,810.00	A	TBC
2.0BiTDI 180PS 4MOTION®	£32,140.00	£38,568.00	£33,380.00	£39,925.00	B	TBC
2.0BiTDI 180PS DSG 4MOTION®	£33,540.00	£40,248.00	£34,780.00	£41,605.00	B	TBC
Caravelle SE – long wheelbase with BlueMotion Technology						
2.0TDI 140PS	£29,165.00	£34,998.00	£30,265.00	£36,215.00	A	TBC
2.0TDI 140PS DSG	£30,565.00	£36,678.00	£31,805.00	£38,035.00	B	TBC
2.0BiTDI 180PS	£30,781.67	£36,938.00	£31,881.67	£38,155.00	A	TBC
2.0BiTDI 180PS DSG	£32,181.67	£38,618.00	£33,281.67	£39,835.00	A	TBC
Caravelle Executive – short wheelbase with BlueMotion Technology						
2.0TDI 140PS	£30,610.83	£36,733.00	£31,710.83	£37,950.00	A	TBC
2.0TDI 140PS DSG	£32,010.83	£38,413.00	£33,250.83	£39,770.00	B	TBC
2.0TDI 140PS 4MOTION®	£32,823.33	£39,388.00	£34,063.33	£40,745.00	B	TBC
2.0BiTDI 180PS	£32,227.50	£38,673.00	£33,327.50	£39,890.00	A	TBC
2.0BiTDI 180PS DSG	£33,627.50	£40,353.00	£34,727.50	£41,570.00	A	TBC
2.0BiTDI 180PS 4MOTION®	£34,440.00	£41,328.00	£35,680.00	£42,685.00	B	TBC
2.0BiTDI 180PS DSG 4MOTION®	£35,840.00	£43,008.00	£37,080.00	£44,365.00	B	TBC
Caravelle Business – short wheelbase						
2.0BiTDI 180PS DSG	£54,127.50	£64,953.00	£55,367.50	£66,310.00	B	38E
2.0BiTDI 180PS DSG 4MOTION®	£56,340.00	£67,608.00	£57,795.00	£69,180.00	C	39E

Finance that makes buying a Volkswagen really affordable

Our extensive range of finance packages can make driving a Volkswagen van a reality. Speak to us today – you may be surprised at how much you can afford.

* For full details of VED (Vehicle Excise Duty) bands and other costs included in the On The Road package, please ask your Van Centre.
† As advised by the Association of British Insurers (ABI). Please see www.thatcham.org/abigrouprating for more information

Options

Get the best from your Caravelle with our quality options

ways to get even more from your Caravelle



Body and chassis

Getting in and out of your Caravelle is easier than ever, thanks to the option of twin electrically assisted sliding doors. Also available is a power-latching rear tailgate, which pulls the door shut once it's on the first click of the latch.

p36

Seats and upholstery

Seating seven people in comfort is what the Caravelle does best, and we've got a range of seat options to add even more customisation to its passenger area, as well as upholsteries – including Alcantara and Nappa leather – to add even more style.

p42

Audio, phone and sat-nav

Finding your way has never been easier, thanks to the latest generation of Volkswagen's radio navigation system. Not only does the RNS 510 offer the very latest in multimedia entertainment via a 6.5" touch-screen and 30GB hard drive, but it's also voice controlled, so you can keep your hands safely on the wheel.

p34



Alloy wheels

After you've fitted out your Caravelle to exactly suit your needs, give it the ultimate finishing touch with one of the six stylish alloy wheel options available; from the 16" Colmar, through to the range-topping 18" Canberra multi-spoke design.

p31





Heating and ventilation

The Climatronic air-conditioning system will help keep your concentration sharp and passengers comfortable by providing a fresh and cool atmosphere inside your Caravelle. The system monitors factors such as the outside temperature, and the intensity of the sun's rays to adjust the cooling or heating in the cabin.

p40



Options: Paint

You want your Caravelle to make an impression. The quickest way to do that is to opt for an alternative paint finish

		SE		Executive		Business	
		Basic (ex VAT)	Total RRP (inc VAT)	Basic (ex VAT)	Total RRP (inc VAT)	Basic (ex VAT)	Total RRP (inc VAT)
Standard A great range of colours, available at no extra cost		S	S	S	S	S	S
Metallic paints Mark your Caravelle out from the competition with a smart metallic paint finish		£495.83	£595.00	£495.83	£595.00	○	○
Pearlescent paints Tiny flecks of material in the paint reflect light, giving your vehicle a unique look		£495.83	£595.00	£495.83	£595.00	○	○

Options: Alloy wheels

Complete your Caravelle's sleek, sharp look with a set of stylish alloy wheels

		SE		Executive		Business	
		Basic (ex VAT)	Total RRP (inc VAT)	Basic (ex VAT)	Total RRP (inc VAT)	Basic (ex VAT)	Total RRP (inc VAT)
16" Miyato Set of four 6.5J x 16 alloys with steel spare and 215/65 R16 tyres. Only compatible with Caravelle SE short-wheelbase with 140PS engine		£495.83	£595.00	-	-	-	-
17" Neva Set of four 7J x 17 alloys with steel spare and 235/55 R17 tyres. Standard on Executive and business.		140PS SWB £545.83 LWB & 180PS SWB £100.00	£655.00 £120.00	S	S	-	-
17" Cascavel (Silver) Set of four 7J x 17 alloys with steel spare and 235/55 R17 tyres.		140PS £545.83 180PS £100.00	£655.00 £120.00	-	-	-	-



Keep your alloys in perfect condition

Brake dust is full of abrasive and corrosive metal and carbon particles, so clean your alloys every couple of weeks with a specialist brush and cleaning fluid, then coat them with a wax protector. You can buy these at your Van Centre.

Add Ons

Accessories to help keep your vehicle 100% Volkswagen

If you want an even greater selection of alloy wheels to choose from, check out our Add Ons accessories range. Ask your local Van Centre for a brochure, call 0800 717131 or download a copy at www.volkswagen-vans.co.uk

Options: Alloy wheels (cont.)

	SE		Executive		Business	
	Basic (ex VAT)	Total RRP (inc VAT)	Basic (ex VAT)	Total RRP (inc VAT)	Basic (ex VAT)	Total RRP (inc VAT)
17" Cascavel (Silver) Set of four 7J x 17 alloys with steel spare and 235/55 R17 tyres. Only compatible with Executive and Business models	-	-	○	○	○	○
17" Cascavel (Anthracite/Silver) Set of four 7J x 17 alloys with steel spare and 235/55 R17 tyres	140PS	£608.33 £730.00	-	-	-	-
	180PS	£175.00 £210.00	-	-	-	-
17" Cascavel (Anthracite/Silver) Set of four 7J x 17 alloys with alloy spare and 235/55 R17 103W tyres. Only compatible with Executive and Business	-	-	£66.67	£80.00	£66.67	£80.00

	SE		Executive		Business	
	Basic (ex VAT)	Total RRP (inc VAT)	Basic (ex VAT)	Total RRP (inc VAT)	Basic (ex VAT)	Total RRP (inc VAT)
17" Thunder Set of four 17" alloys with alloy spare and 235/55 R17 tyres. Only compatible with Executive models	-	-	○	○	-	-
18" Canberra Set of four 8J x 18 alloys with 255/45 R18 103W tyres and tyre-repair kit in lieu of spare wheel	140PS SWB	£1,333.33 £1,600.00	-	-	-	-
	All LWB & 180PS SWB	£987.50 £1,185.00	-	-	-	-
18" Canberra Set of four 8J x 18 alloys with 255/45 R18 103W tyres and tyre-repair kit in lieu of spare wheel. Only compatible with Executive models	-	-	£762.50	£915.00	-	-



Add Ons

Accessories to help keep your vehicle 100% Volkswagen

If you want an even greater selection of alloy wheels to choose from, check out our Add Ons accessories range. Ask your local Van Centre for a brochure, call 0800 717131 or download a copy at www.volkswagen-vans.co.uk

Options: Audio, phone and satellite-navigation

Choose from a range of entertainment systems for great music on the go, or opt for one of our touch-screen satellite-navigation systems

			SE		Executive		Business	
			Basic (ex VAT)	Total RRP (inc VAT)	Basic (ex VAT)	Total RRP (inc VAT)	Basic (ex VAT)	Total RRP (inc VAT)
Audio								
RCD 310	 <p>Standard on SE and Executive</p>	<p>This radio includes eight speakers, an aux-in for external devices and the option of Digital Audio Broadcast (DAB) radio (see right).</p> <ul style="list-style-type: none"> ✓ Eight speakers ✓ FM/AM radio ✓ Optional DAB (see right) ✓ Single CD player ✓ Aux-in for external devices 	S	S	S	S	-	-
Satellite-navigation								
RNS 510	 <p>Standard on Business edition</p>	<p>This sat-nav system has voice control and a 6.5" colour touch-screen for easy use.</p> <ul style="list-style-type: none"> ✓ 6.5" colour touch-screen ✓ Voice control ✓ 30GB hard drive ✓ Eight speakers ✓ FM/AM radio with RDS ✓ Single CD player ✓ Aux-in for external devices 	£1,612.00	£1,935.00	£1,612.00	£1,935.00	-	-
RNS 510 WITH DAB+		<p>This sat-nav system has voice control, a 6.5" colour touch-screen for easy use and DAB digital audio reception for more stations and clearer signal.</p> <ul style="list-style-type: none"> ✓ 6.5" colour touch-screen ✓ Voice control ✓ 30GB hard drive ✓ Eight speakers ✓ FM/AM radio with RDS ✓ Single CD player ✓ Aux-in for external devices ✓ DAB digital audio reception 	£1,833.33	£2,200.00	£1,833.33	£2,200.00	S	S

			SE		Executive		Business		
			Basic (ex VAT)	Total RRP (inc VAT)	Basic (ex VAT)	Total RRP (inc VAT)	Basic (ex VAT)	Total RRP (inc VAT)	
Other audio options									
CD CHANGER	 <p>Only compatible with satellite navigation</p>	<p>This six-disc player allows you to quickly listen to your favourite tunes.</p>	£291.67	£350.00	£291.67	£350.00	£291.67	£350.00	
DAB - DIGITAL AUDIO RECEPTION		<p>DAB (Digital Audio Broadcasting) offers more stations, a clearer signal and information about what's playing. Not compatible with satellite navigation.</p>	£104.17	£125.00	£104.17	£125.00	-	-	
Phone									
BLUETOOTH CONNECTIVITY*		<p>Go hands-free with compatible devices. This system includes a multi-function display.</p>	<p>Standard</p> <p>Premium</p>	<p>£191.67</p> <p>£312.50</p>	<p>£230.00</p> <p>£375.00</p>	<p>£191.67</p> <p>£312.50</p>	<p>£230.00</p> <p>£375.00</p>	<p>-</p> <p>S</p>	<p>-</p> <p>S</p>

* Premium Bluetooth® requires radio upgrade and multi-function steering wheel

Options: Body, chassis and windows

Tailor your Caravelle to suit your needs with our body and chassis options, including door packs, towbars, roof rails and privacy glass

	SE		Executive		Business	
	Basic (ex VAT)	Total RRP (inc VAT)	Basic (ex VAT)	Total RRP (inc VAT)	Basic (ex VAT)	Total RRP (inc VAT)
Side doors						
Electric side doors Not compatible with tyre-pressure warning light	£541.67	£650.00	S	S	S	S
Rear doors						
Tailgate with power-latching	£87.50	£105.00	S	S	S	S
Windows						
Rear privacy glass	£220.83	£265.00	S	S	S	S
Sliding window centre, right Fixed rear window	£150.00	£180.00	£150.00	£180.00	-	-
Sliding window centre, left Fixed rear window	£150.00	£180.00	£150.00	£180.00	-	-
Laminated glass Includes laminated privacy glass and laminated windscreen for improved noise dampening, and auto-dimming rear view mirror and rain sensor	£354.17	£425.00	£162.50	£195.00	-	-



Fit electric side doors

Electric side doors make passengers' entry and exit into the Caravelle that much quicker, and the doors become easier to close. They're standard on Executive and Business models, while they're optional on SE.

- not available S standard O available as a no-cost option

	SE		Executive		Business	
	Basic (ex VAT)	Total RRP (inc VAT)	Basic (ex VAT)	Total RRP (inc VAT)	Basic (ex VAT)	Total RRP (inc VAT)
Towing						
Removable towbar with 13-pin socket An adapter is available from Van Centres to allow connection to twin seven-pin sockets. Only one front towing eye with towbars	£470.83	£565.00	£470.83	£565.00	-	-
Towbar – preparation with socket	£162.50	£195.00	£162.50	£195.00	-	-
Other body and chassis options						
Roof load rack preparation	£75.00	£90.00	£75.00	£90.00	-	-
Mud flaps – front and rear	£95.83	£115.00	£95.83	£115.00	£95.83	£115.00
Dynamic suspension Body lowered by approx 20mm, reinforced anti-roll bars	£175.00	£210.00	£175.00	£210.00	-	-
Differential lock Only compatible with 4MOTION® models	£466.67	£560.00	£466.67	£560.00	£450.00	£540.00



Add on a towbar

A towbar increases your Caravelle's flexibility; the optional removable towbar has a 13-pin socket. An adapter is available to allow twin seven-pin sockets to be connected



If you want even more choice for body and chassis upgrades, check out our Add Ons accessories range, which includes lots of towing and roof-rack solutions. Ask your Van Centre for a brochure, call 0800 717131 or download a copy at www.volkswagen-vans.co.uk

Options: Comfort and convenience

From cruise control to a multi-function steering wheel, there's a range of features to make driving more comfortable

	SE		Executive		Business	
	Basic (ex VAT)	Total RRP (inc VAT)	Basic (ex VAT)	Total RRP (inc VAT)	Basic (ex VAT)	Total RRP (inc VAT)
Headlight washers, heated washer jets and washer-fluid level indicator Heated washer jets are standard on Executive models	£175.00	£210.00	£154.17	£185.00	-	-
Lane-change assist Includes rain sensor and auto-dimming rear-view mirror. Only compatible with SE short-wheelbase models. Requires electrically folding mirrors to be fitted	£666.67	£800.00	£604.17	£725.00	-	-
Rain sensor and auto-dimming rear-view mirror with 'leaving/coming home' function Only compatible with SE models	£191.67	£230.00	-	-	-	-
Xenon headlights With LED daytime-running lights, includes headlamp-washer system with heated water from washer jets and washer-fluid level indicator	£1,000.00	£1,200.00	£1,000.00	£1,200.00	S	S
Sunroof – glass, electric, front	£483.33	£580.00	£483.33	£580.00	-	-

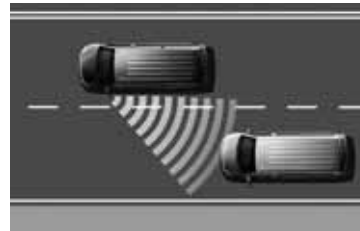

Lane-change assist

Lane-change assist makes motorway driving safer by helping to prevent accidents when you want to change lanes. The system monitors your blind spots and warns you of a potentially hazardous situation by flashing warning lights in the exterior mirrors.

	SE		Executive		Business	
	Basic (ex VAT)	Total RRP (inc VAT)	Basic (ex VAT)	Total RRP (inc VAT)	Basic (ex VAT)	Total RRP (inc VAT)
Smoking pack Includes ash tray, cigarette lighter and additional cup holder	£16.67	£20.00	£16.67	£20.00	S	S
Leather multi-function steering wheel Includes display and controls for radio and mobile phone	£279.17	£335.00	£279.17	£335.00	S	S
Servotronic speed-dependent power-assisted steering	£350.00	£420.00	S	S	-	-
Storage drawers Three in base of rear bench seat, includes litter bin. Not compatible with rear seating for four. Included in sleep pack	£33.33	£40.00	£33.33	£40.00	-	-
Sleep pack Includes curtains, bed extension and cover, three storage drawers, litter bin and mini-flashlight. Not compatible with rear-seating-for-four option. Not available with Caravelle SE long-wheelbase	£566.67	£680.00	£566.67	£680.00	-	-



Go for cruise control

Cruise control can help reduce the fatigue and stress of sticking to speed limits on long journeys. It also helps reduce the amount of fuel you use by cutting out the acceleration and braking used to keep up with road speed.

Add Ons

Accessories to help keep your vehicle 100% Volkswagen

If you want even more choice for comfort or convenience, check out our Add Ons accessories range, which includes boot-liners and seat covers. Ask at your local Van Centre for a brochure, call 0800 717131 or download a copy at www.volkswagen-vans.co.uk

Options: Heating and ventilation

Maintain an ideal, steady temperature in your Caravelle with one of our air-conditioning options

	SE		Executive		Business	
	Basic (ex VAT)	Total RRP (inc VAT)	Basic (ex VAT)	Total RRP (inc VAT)	Basic (ex VAT)	Total RRP (inc VAT)
'Climatronic' three-zone air-conditioning	£750.00	£900.00	S	S	S	S
Parking heater with timer Includes second 80Ah battery	£1,412.50	£1,695.00	£1,412.50	£1,695.00	-	-
Parking heater with timer and remote control Includes second 80Ah battery	£1,625.00	£1,950.00	£1,625.00	£1,950.00	S	S
Charcoal canister For ventilation system	£16.67	£20.00	£16.67	£20.00	-	-



Get an air-con recharge

You might be able to get your air-conditioning system recharged and pollen filter replaced at your nearest Van Centre, to keep them working as they should. Ask your Van Centre for details.

Options: Safety and security

Parking sensors and airbags that enhance the safety of you, your vehicle and its contents

	SE		Executive		Business	
	Basic (ex VAT)	Total RRP (inc VAT)	Basic (ex VAT)	Total RRP (inc VAT)	Basic (ex VAT)	Total RRP (inc VAT)
Rear curtain airbags Not compatible with driver and passenger swivel-seat option or long-wheelbase models	£254.17	£305.00	£254.17	£305.00	S	S
Net partition Not compatible with long-wheelbase models	£100.00	£120.00	£100.00	£120.00	S	S
Parking sensors (front and rear)	£350.00	£420.00	£350.00	£420.00	-	-
Reversing camera and parking sensors (front and rear) Only with satellite navigation	£870.83	£1,045.00	£870.83	£1,045.00	S	S
Tyre-pressure warning light Not compatible with electric side doors	£50.00	£60.00	-	-	-	-



Useful security tips

- 1. Get an alarm**
Alarm noise may be enough to scare a thief and prevent a costly break-in.
- 2. Lock your doors**
Even if you're only away from your van for a minute, locked doors deter thieves looking for an easy target.
- 3. Keep it tidy**
Seemingly trivial items can still be bait to thieves. Stow gadgets out of sight or take them with you. Thieves know to look in the glove box, too.
- 4. Load out of sight**
Try to load luggage into your van in a secure location. Thieves can linger in public areas for a swipe-and-run.
- 5. Park for visibility**
Use well-lit areas. Avoid parking near vehicles or foliage that a thief could use for cover. Parking right up against walls can stop a thief getting in through your van's doors, too.

Options: Seating, trim and upholstery

Improve the comfort and practicality of your Caravelle with heated seats and a selection of upholstery finishes

	SE		Executive		Business	
	Basic (ex VAT)	Total RRP (inc VAT)	Basic (ex VAT)	Total RRP (inc VAT)	Basic (ex VAT)	Total RRP (inc VAT)
Seat options						
Electric four-way lumbar support Driver and front passenger seats. Not compatible with swivelling seats	£183.33	£220.00	£183.33	£220.00	-	-
Integrated child seat in first row Booster cushion only, includes ISOFIX mountings	£133.33	£160.00	£133.33	£160.00	-	-
Two integrated child seats in first row Booster cushion only, includes ISOFIX mountings	£262.50	£315.00	£262.50	£315.00	-	-
Heated driver and front passenger seats	£229.17	£275.00	S	S	S	S
Driver and passenger swivel seats Not compatible with rear curtain airbags and electric four-way lumbar support	£262.50	£315.00	£262.50	£315.00	-	-
Rear seating for four Two:two layout. Not compatible with sleep pack or long wheelbase	O	O	O	O	S	S
Rear seating for four Two:two layout. Only compatible with long wheelbase	£75.00	£90.00	-	-	-	-
Rear seating for five One:two:two layout. Only compatible with long wheelbase. Not compatible with two integrated child seats in first row	£233.33	£280.00	-	-	-	-

- not available S standard O available as a no-cost option

	SE		Executive		Business					
	Basic (ex VAT)	Total RRP (inc VAT)	Basic (ex VAT)	Total RRP (inc VAT)	Basic (ex VAT)	Total RRP (inc VAT)				
Upholstery										
Cheyenne fabric Anthracite (ZH) Classic Grey (ZJ)			S	S	-	-				
Alcantara®/leather with rear centre armrest Includes heated front seats Anthracite (ZH) Classic Grey (ZJ)			£1,104.17	£1,325.00	S	S				
Nappa leather with rear centre armrest Includes the addition of heated front seats on the Caravelle SE. (Heated front seats are fitted as standard on the Caravelle Executive) Anthracite (ZH) Classic Grey (ZJ) Desert Beige (MD) Date Brown (ME)					£2,000.00	£2,400.00	£908.33	£1,090.00	S	S

Add Ons
Accessories to help keep your vehicle 100% Volkswagen

If you want even more choice for seating and upholstery, check out our Add Ons accessories range. Ask your local Van Centre for a brochure, call 0800 717131 or download yourself a copy at www.volkswagen-vans.co.uk

Options: Electrical

Choose these electrical features to give your Caravelle a functional and practical edge

	SE		Executive		Business	
	Basic (ex VAT)	Total RRP (inc VAT)	Basic (ex VAT)	Total RRP (inc VAT)	Basic (ex VAT)	Total RRP (inc VAT)
Up-rated alternator 180A alternator. Not compatible with Climatic air-conditioning	£66.67	£80.00	-	-	-	-
Second battery 80Ah. Included with parking heaters and thermal box	£183.33	£220.00	£183.33	£220.00	-	-
Electrically heated, adjustable and folding door mirrors	£91.67	£110.00	£91.67	£110.00	S	S
Thermal box - 32 litre Includes second 80Ah battery	£354.17	£425.00	£354.17	£425.00	S	S

Want more? Pick an Add On...

The Caravelle comes with a wide range of factory-fit options, but you may want something extra. That's where Add Ons come in

Add Ons is the new name for our extensive range of Volkswagen-approved accessories, available to buy and be fitted at your Van Centre. Whether you want to add extra style to your van, get more out of your cargo bay, convert a work van into a weekend leisure vehicle or add extra audio, phone and sat-nav to your cab, we've got lots of accessories for you.

Help keep it 100% Volkswagen

There are big advantages to purchasing your accessories from Volkswagen. Add Ons have all been designed with Volkswagen in mind, so they're a perfect match for fit and style, and they've been designed and developed to be just as rugged, reliable and long-lasting as your vehicle.

Keep your Add Ons covered

Most Add Ons include a two-year warranty. However, if you order and fit them at the time of purchasing a new van, we may be able to extend that to three years to match your vehicle's warranty. Pop into your Van Centre and ask our staff about how much Add Ons can add to your life.

Add Ons
Accessories to help keep your vehicle 100% Volkswagen

Get the latest Add Ons
Look the part this season
Refresh your Crofter

Summer Essentials
2012. The latest Add Ons for your Volkswagen. FREE

Accessories
Making it perfect for you
INSIDE
Sport & style
Adaptability
Every vehicle inside

Camping in style
The very best accessories for the perfect California trip. See page 4

To get a brochure, pop into a Van Centre. To find your nearest one, call 0800 717131 or visit www.volkswagen-vans.co.uk

Top five Caravelle Add Ons

- 

18" Dakar Bi-Colour alloy wheel
These striking, bi-colour 8J x 18 alloy wheels add a dash of style to your Caravelle.
- 

Kenwood Multimedia system*
This clever piece of kit combines sat-nav, telephone and audio technology; it also allows you to watch a DVD.
* Some features only work when the vehicle is stationary
- 

Full-leather seats
Our smart, durable leather seats come in a choice of two colours; leather Sport seats are also available.
- 

Reversing-aid kit
Four sensors fitted across the rear of your Caravelle, and painted to match its body colour, aid reversing manoeuvres.
- 

Carpet mats
Protect the floor of your Caravelle from mud and wet with these carpet mats; they're available for the front and rear of the vehicle.

Data

All the facts and figures you'll need for your vehicle

Engines: Caravelle

	2.0TDI 140PS	2.0BiTDI 180PS
ENGINE SPECIFICATIONS		
Engine type	Diesel, transverse, water-cooled, in-line, variable turbine geometry turbocharger with intercooler	Diesel, transverse, water-cooled, in-line bi-turbo with intercooler
Mixture preparation/injection method	Common-rail, direct-injection	BiTurbo, common-rail, direct-injection
EU exhaust emission standard	EURO 5	
Number of cylinders	4	
Cubic capacity	1,968cc	
Output, PS at rpm	140 at 3,500	180 at 4,000
Torque, max. Nm/rpm	340 at 1,750-2,500	400 at 1,500-2,000
Diesel Particulate Filter (DPF)	●	●
6-speed manual gearbox	●	●
7-speed dual-clutch gearbox (DSG)	●	●
Front-wheel drive	●	●
4MOTION® all-wheel drive	●	●

● Available
- Not available

Output (PS)
Torque (Nm)

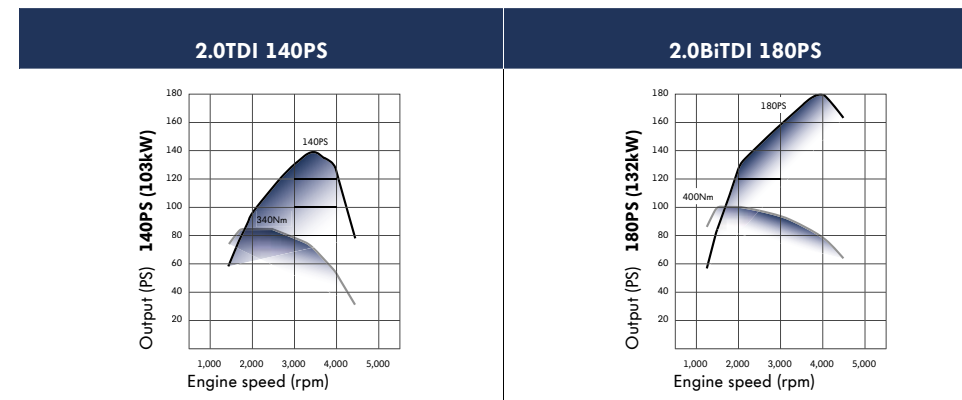

Standard features: Caravelle

Caravelle SE

EXTERIOR

Body-coloured door mirrors and handles, rear bumper and front bumper with chrome detailing in upper grille
 Door mirrors – electrically heated and adjustable
 80-litre lockable fuel tank
 Heat-reflective glass
 Tailgate with heated rear window and wash/wipe
 Jack and tool kit
 Side sliding doors left and right
 16" x 6.5J Colmar alloy wheels fitted with 215/65 R16 tyres (140PS short-wheelbase models)
 17" x 7J Thunder alloy wheels fitted with 235/55 R17 tyres (long-wheelbase and 180PS models)
 Steel spare wheel

INTERIOR

Cab area:
 Three 12V sockets
 Carpet floor covering
 Climatic – semi-automatic air-conditioning with second heater in rear passenger compartment
 Driver and passenger seats with height, lumbar, reach and rake adjustment, and armrests
 Front electric windows
 Grab-handle on A-pillar, driver and passenger sides
 Illuminated interior entry steps
 Interior light and reading lamps
 Leather steering wheel and gearknob
 RCD 310 Radio/CD player with eight speakers and AUX-IN
 Lockable glove compartment
 Storage net on lower dash passenger side

Passenger area:
 Two longitudinally adjustable, swivelling and removable seats with ISOFIX child-seat mounting points.
 Three-seater bench with ISOFIX child seat mounting points on outer two seats.
 Deluxe headlining in passenger compartment with two ventilation strips and integrated swivelling reading lights
 Luggage compartment cover (only with three-seater bench, deleted with optional Sleep Pack)
 Multi-functional table
 'Cheyenne' cloth upholstery
 Rail system for ultimate seat and table configuration
 Blinds for side windows
 Side sliding doors with power latching
 Trip computer with 'Plus' multifunction display

SAFETY AND SECURITY

Six securing points in passenger and luggage compartment
 Airbags – driver, front passenger (with deactivation switch), front seats with head and side airbags
 Thatcham Category 1 approved alarm and immobiliser with tow-away protection
 Electronic Stability Programme (ESP)
 Anti-lock Braking System (ABS)
 Brake Assist System (BAS)
 Electronic Brake-pressure Distribution (EBD)
 Electronic Differential Lock (EDL)
 Hill Start Assist
 First-aid kit and warning triangle
 Front fog lights, with cornering function
 Remote central locking with interior locking switch and two remote folding keys
 Height and rake adjustable steering column

BLUEMOTION TECHNOLOGY

Not for Caravelle Business

Cruise control
 Start/stop system
 Low-rolling-resistance tyres
 Brake energy recuperation
 BlueMotion Technology exterior badge

Standard features: Caravelle (cont.)

Caravelle Executive

In addition to standard specification

Climatronic – three-zone automatic air-conditioning for driver, front passenger and rear passenger compartment
Alcantara®/leather upholstery
Alloy spare wheel
17" x 7J Neva alloy wheels fitted with 235/55 R17 tyres
Folding centre armrest in three-seater bench
Heated front seats
Heated windscreen-washer jets
Privacy glass in rear passenger compartment
Automatically dimming rear-view mirror and rain sensor
Servotronic (speed-dependent power steering)
Electric side-sliding doors
Stainless-steel door steps and tailgate load sill
Tailgate, power-latching
Chrome package – chrome detailing on the sides, tailgate, fog lights and lower-front grille
Deluxe instrument panel with four-eye instrument cluster, including TFT colour display and 'Premium' multifunction display

Caravelle Business

In addition to standard specification

Darkened rear light clusters
Electrically folding door mirrors
Laminated windscreen for improved noise damping
Leisure second battery with cut-off relay
'Nappa' leather upholstery
Luxury two-seat rear seating console (replaces three-seater bench). Includes heated seats, fully electric adjustment and integrated refrigerator
Satellite Navigation RNS 510 – 6.5" touch-screen colour display with DVD drive and 30GB HDD for music and mapping data storage. Includes voice control, AUX-IN, MEDIA-IN with iPod/iPhone adapter cable, SD card slot and DVD with western Europe mapping data
Premium Bluetooth Mobile Phone Provision – voice-controlled / (SIM Access Profile (rSAP) 1.0 / Hands-Free Profile (HFP) 1.5) / Integrated GSM Universal Mobile Telecommunications System (UMTS) transmitter
Wireless internet access
Burr-walnut decorative inlays in rear passenger compartment
Leather multi-function steering wheel with radio and phone controls
Parking heater, programmable with remote control
Xenon headlights with LED daytime running lights. Includes headlamp-washer system with heated front washer jets and washer fluid-level indicator
Lane-Change Assist - sensors monitor vehicles in the driver's blind spot and provide a warning with a visual signal in either the left or right door mirror. Includes cruise control, auto-dimming rear-view mirror and rain sensors
Privacy glass
Parking sensors – front and rear with reversing camera
Automatic headlight activation with 'coming home' and 'leaving home' function
Curtain airbags for rear passenger compartment

Dimensions and weights: Caravelle

Short wheelbase

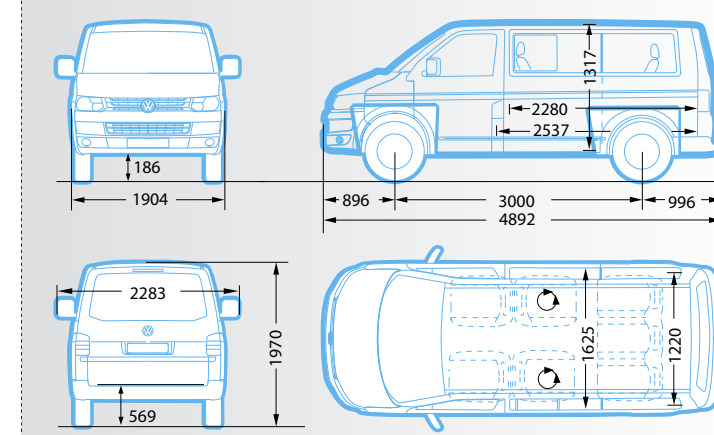

Dimensions

Wheelbase	3,000
Load compartment	
Length	2,537
Volume	5.8m ³
Side sliding door	
Width	1,010
Height	1,253
Tailgate	
Width	1,446
Height	1,262
Turning circle (wall to wall)	11.9

Dimensions in millimetres (mm) unless otherwise indicated.

Model/gross vehicle weight (kg)	Engine/transmission	Axle load limit front/rear (kg)	Trailer weight braked 12%/unbraked (kg)	Gross train weight (kg)	Unladen weight † (kg)	Payload † (kg)
CARAVELLE SE – SHORT WHEELBASE WITH BLUEMOTION TECHNOLOGY						
3,000	2.0TDI 140PS	1,550 / 1,575	2,500 / 750	5,200	2,296	704
3,000	2.0TDI 140PS DSG	1,550 / 1,575	2,500 / 750	5,300	2,312	688
3,080	2.0TDI 140PS 4MOTION®	1,600 / 1,575	2,500 / 750	5,300	2,431	649
3,000	2.0BiTDI 180PS	1,550 / 1,575	2,500 / 750	5,200	2,322	678
3,000	2.0BiTDI 180PS DSG	1,550 / 1,575	2,500 / 750	5,300	2,339	661
3,080	2.0BiTDI 180PS 4MOTION®	1,600 / 1,575	2,500 / 750	5,300	2,443	637
3,080	2.0BiTDI 180PS DSG 4MOTION®	1,600 / 1,575	2,500 / 750	5,300	2,461	619
CARAVELLE EXECUTIVE – SHORT WHEELBASE WITH BLUEMOTION TECHNOLOGY						
3,000	2.0TDI 140PS	1,550 / 1,575	2,500 / 750	5,200	2,329	671
3,000	2.0TDI 140PS DSG	1,550 / 1,575	2,500 / 750	5,300	2,341	659
3,080	2.0TDI 140PS 4MOTION®	1,550 / 1,575	2,500 / 750	5,300	2,463	617
3,000	2.0BiTDI 180PS	1,550 / 1,575	2,500 / 750	5,200	2,354	646
3,000	2.0BiTDI 180PS DSG	1,550 / 1,575	2,500 / 750	5,300	2,366	634
3,080	2.0BiTDI 180PS 4MOTION®	1,600 / 1,575	2,500 / 750	5,300	2,475	605
3,080	2.0BiTDI 180PS DSG 4MOTION®	1,600 / 1,575	2,500 / 750	5,300	2,488	592
CARAVELLE BUSINESS – SHORT WHEELBASE						
3,000	2.0BiTDI 180PS DSG	1,550 / 1,575	2,500 / 750	5,300	2,450	550
3,080	2.0BiTDI 180PS DSG 4MOTION®	1,600 / 1,575	2,500 / 750	5,300	2,572	508

Roof load limit 100kg (with two roof carriers) or 150kg (with at least four roof carriers). Trailer nose weight 100kg. Tailgate load limit (where fitted) is maximum 75kg.

† Unladen weight and payload includes approximately 90% fuel load and 75kg for driver.

The published payload figure is based on a standard-specification vehicle. It does not include any items of optional equipment. Any optional equipment will reduce the payload from the published figure.

Dimensions and weights: Caravelle (cont.)

Long wheelbase

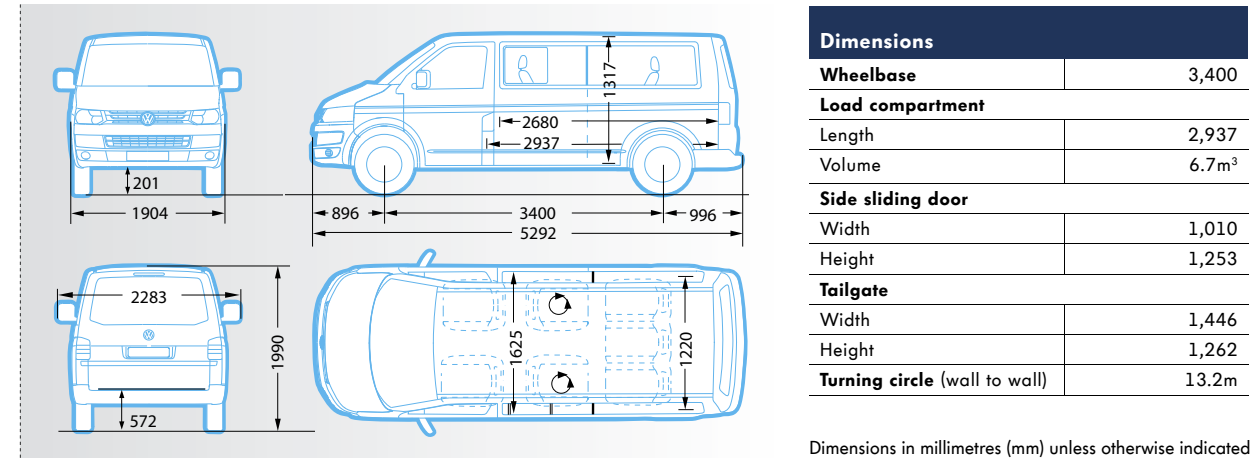

Model/gross vehicle weight (kg)	Engine/transmission	Axle load limit front/rear (kg)	Trailer weight ^{braked} 12%/unbraked (kg)	Gross train weight (kg)	Unladen weight [†] (kg)	Payload [†] (kg)
CARAVELLE SE – LONG WHEELBASE WITH BLUEMOTION TECHNOLOGY						
3,080	2.0TDI 140PS	1,600 / 1,600	2,500 / 750	5,200	2,375	705
3,080	2.0TDI 140PS DSG	1,600 / 1,600	2,500 / 750	5,300	2,391	689
3,080	2.0BiTDI 180PS	1,600 / 1,600	2,500 / 750	5,200	2,386	694
3,080	2.0BiTDI 180PS DSG	1,600 / 1,600	2,500 / 750	5,300	2,402	678

Roof load limit 100kg (with two roof carriers) or 150kg (with at least four roof carriers). Trailer nose weight 100kg. Tailgate load limit (where fitted) is maximum 75kg.

[†] Unladen weight and payload includes approximately 90% fuel load and 75kg for driver.

The published payload figure is based on a standard specification vehicle. It does not include any items of optional equipment. Any optional equipment will reduce the payload from the published figure.

Economy and performance: Caravelle

Short wheelbase

Engine/transmission	Urban mpg (l/100km) ¹	Extra-urban mpg (l/100km) ¹	Combined mpg (l/100km) ¹	Acceleration 0-62 mph (seconds)	Top speed mph (where law permits)	CO ₂ emissions (g/km) ¹
CARAVELLE SE – SHORT WHEELBASE WITH BLUEMOTION TECHNOLOGY						
2.0TDI 140PS	31.0 (9.1)	46.3 (6.1)	39.2 (7.2)	14.2	107	189
2.0TDI 140PS DSG	29.7 (9.5)	42.2 (6.7)	36.7 (7.7)	14.7	107	203
2.0TDI 140PS 4MOTION®	28.8 (9.8)	42.2 (6.7)	36.2 (7.8)	15.3	106	206
2.0BiTDI 180PS	31.7 (8.9)	44.1 (6.4)	38.7 (7.3)	11.4	119	192
2.0BiTDI 180PS DSG	32.1 (8.8)	40.9 (6.9)	37.2 (7.6)	11.3	119	199
2.0BiTDI 180PS 4MOTION®	29.4 (9.6)	40.9 (6.9)	35.8 (7.8)	11.8	117	208
2.0BiTDI 180PS DSG 4MOTION®	29.1 (9.7)	37.7 (7.5)	34.0 (8.3)	12.1	117	219
CARAVELLE EXECUTIVE – SHORT WHEELBASE WITH BLUEMOTION TECHNOLOGY						
2.0TDI 140PS	31.0 (9.1)	46.3 (6.1)	39.2 (7.2)	14.2	107	189
2.0TDI 140PS DSG	29.7 (9.5)	42.2 (6.7)	36.7 (7.7)	14.7	107	203
2.0TDI 140PS 4MOTION®	28.8 (9.8)	42.2 (6.7)	36.2 (7.8)	15.3	106	206
2.0BiTDI 180PS	31.7 (8.9)	44.1 (6.4)	38.7 (7.3)	11.4	119	192
2.0BiTDI 180PS DSG	32.1 (8.8)	40.9 (6.9)	37.2 (7.6)	11.3	119	199
2.0BiTDI 180PS 4MOTION®	29.4 (9.6)	40.9 (6.9)	35.8 (7.8)	11.8	117	208
2.0BiTDI 180PS DSG 4MOTION®	29.1 (9.7)	37.7 (7.5)	34.0 (8.3)	12.1	117	219
CARAVELLE BUSINESS – SHORT WHEELBASE						
2.0BiTDI 180PS DSG	27.7 (10.2)	40.9 (6.9)	34.9 (8.1)	11.3	119	214
2.0BiTDI 180PS DSG 4MOTION®	25.4 (11.1)	37.7 (7.5)	32.1 (8.8)	12.1	117	232

Long wheelbase

Engine/transmission	Urban mpg (l/100km) ¹	Extra-urban mpg (l/100km) ¹	Combined mpg (l/100km) ¹	Acceleration 0-62 mph (seconds)	Top speed mph (where law permits)	CO ₂ emissions (g/km) ¹
CARAVELLE SE – LONG WHEELBASE WITH BLUEMOTION TECHNOLOGY						
2.0TDI 140PS	31.0 (9.1)	46.3 (6.1)	39.2 (7.2)	14.2	107	189
2.0TDI 140PS DSG	29.7 (9.5)	42.2 (6.7)	36.7 (7.7)	14.7	107	203
2.0BiTDI 180PS	31.7 (8.9)	44.1 (6.4)	38.7 (7.3)	11.4	119	192
2.0BiTDI 180PS DSG	32.1 (8.8)	40.9 (6.9)	37.2 (7.6)	11.3	119	199

¹ The fuel consumption and emission test values shown are in full compliance of the fuel consumption directive 80/1268/EWG.

Notes

*Scribble any queries
you have here so you
don't forget them*

Keep track of your costs

The van (see pages 10-23)	Basic price (ex VAT)	Total RRP (inc VAT)
Model (eg: Caravelle Executive 2.0TDI 180PS DSG 4MOTION®)		
Base model total	£	£

Options (see pages 29-44)		
Factory-fit options (eg: alloy wheels, roof racks, sat-nav etc.)		
Options total	£	£

Add Ons (see page 45)		
You can add any item from our Add Ons accessories range when you buy your vehicle. Pick up an Accessories brochure to see the full selection		
Add Ons total	£	£

Grand total	£	£
--------------------	---	---

The small print and the footnotes

Print processes do not allow exact reproduction of the paint and upholstery colours. Some of the vehicles shown are fitted with optional equipment at extra charge.

All data given and specifications are in accordance with information available at the time of going to print and are subject to change without notice. Vehicles not in current UK stock and customer order vehicles may take a number of weeks for delivery. Certain combinations of vehicle specifications and factory-fitted extras are not compatible and therefore all orders received are subject to confirmation. Models, factory-fitted options and paint and upholstery options subject to availability. Please check details and availability with an appropriate authorised Volkswagen Van Centre at the time of ordering.

Volkswagen Commercial Vehicle Finance is a trading name of Volkswagen Financial Services (UK) Limited. Finance subject to status, and available to over 18s only.

Full details of Volkswagen warranties are available from your authorised Volkswagen Van Centre or Van Service Centre.

Volkswagen Commercial Vehicle Insurance is a trading name of Volkswagen Insurance Service (Great Britain) Limited, an appointed representative of Volkswagen Financial Services (UK) Limited, Brunswick Court, Yeomans Drive, Blakelands, Milton Keynes MK14 5LR. Registered in England number 2835230. Volkswagen Commercial Vehicle Insurance is sold, underwritten and administered by Allianz Insurance plc registered in England number 84638. Registered office 57 Ladymead, Guildford, Surrey GU1 1DB. Volkswagen Financial Services (UK) Limited and Allianz Insurance plc are authorised and regulated by the Financial Services Authority. Volkswagen Financial Services (UK) Limited and Allianz Insurance plc are not part of the same corporate group.

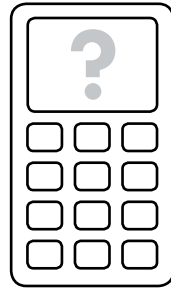

Work out how much it costs

Turn over to keep track of the prices of the vehicle and options you're choosing. Then take this page into your Van Centre.

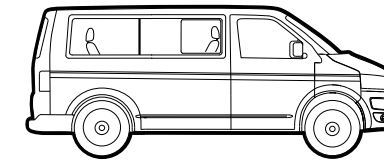

Get in touch with the experts

To find your nearest Van Centre call

0800 717131

or visit www.volkswagen-vans.co.uk

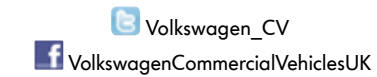

Issue: January 2013

Printed in the UK, 2 January 2013. CVW713CARAV

This brochure supersedes all previous publications