

Transporter passenger carriers



Commercial
Vehicles

✔ **Transporter shuttles**
Carry up to eight passengers

✔ **Window vans**
A choice of seating layouts

✔ **All spacious and comfortable**
Lots of passenger-friendly features

Smooth performers

Get your customers moving in style and in comfort



INSIDE



Add a little extra
Great options to suit you
and your passengers



7 ways your
Van Centre
can help you

PLUS Tips for picking your ideal vehicle ● How our warranty works for you ● BlueMotion Technology explained

The perfect Transporter – for both drivers and passengers



THE TRANSPORTER HAS been the mainstay of Volkswagen's hugely successful commercial vehicle range for 60 years, and not just for carrying goods and cargo. Almost as soon as the original split-screen hit the roads, it was modified to carry people as well.

Today's Transporter passenger-carrier range is more adaptable than ever, with the versatile window van and the stylish Transporter shuttle available in short- and long-wheelbase configurations. Both can seat up to eight passengers. With a choice of 2.0-litre TDI engines, and BlueMotion Technology for improved economy, the only question is, which model is right for you?



Transporter window van

>p14

Transporter shuttle

>p16



INTRODUCING THE TRANSPORTER

- ✓ Advanced, economical TDI engines
- ✓ **NEW** BlueMotion Technology
- ✓ Fuel economy up to 41.5mpg (combined)
- ✓ Choice of short- or long-wheelbase
- ✓ Flexible eight- or nine-seat options
- ✓ Twin sliding doors on the Transporter shuttle
- ✓ Choice of S or SE trims on the Transporter shuttle

Make your next move

Find out why Volkswagen is a brand you can trust

>p4

Go straight to the Transporter to learn more

>p8

Contact us now:

To find the location of your nearest Van Centre, get a brochure or book a test drive: [0800 717131](tel:0800717131) www.volkswagen-vans.co.uk

Get connected:

[Volkswagen_CV](#) [VolkswagenCommercialVehiclesUK](#) [vnmcommercialvehicles](#) www.volkswagen-vans.co.uk/vanmail

Delivering the goods. It's what we've always done...

Today's much-loved, award-winning Volkswagen vans are only the latest step in a 60-year journey that started with one clever idea

In 1947, Dutch importer Ben Pon spotted workers at Volkswagen's Wolfsburg factory using a stripped-down Beetle to move parts around. Inspired, he sketched the platform for a versatile commercial vehicle that could be adapted to a multitude of uses. From this sketch, the Transporter was born, and the van world has never looked back.

Brilliant then, even better now

Since 1950, millions of Transporters have been built and have proved to be reliable workhorses for delivery drivers and tradesmen all over the world. There's more to owning a Volkswagen than just work, though – Volkswagen vans have always stood out from the pack, which has helped them build a loyal following, from the original 'Splittie' to today's sleek, modern models.

Reliability that endures

Today, Volkswagen's commercial vehicles are more popular than ever, with a diverse range of panel vans, kombis, chassis cabs, passenger carriers, camper vans and even pick-ups. Each is as versatile, spacious and reliable as Volkswagens have always been, but now they're more comfortable, easier to drive and more fuel-efficient than ever before. They're all backed up by a Van Centre network that's ready to solve any problem you may have, too.

Getting the job done efficiently and reliably has been at Volkswagen's heart for the last 60 years, and that's why you can trust us to deliver a van that works for you.



Transporter

The Transporter has been the mainstay of our van range since 1950. It still embodies the original's attributes of space, versatility and reliability, but is now more efficient than ever.

California

The definitive Volkswagen camper van is a true home from home, with four sleeping berths, a fully fitted kitchen and an electric pop-up roof.



Caddy

The compact Caddy has city-friendly dimensions and a car-like feel, but it can still carry big loads or plenty of passengers. Wide rear doors make loading simple, too.



Crafter

The Crafter is the van to have for seriously big tasks. It's available as a van, a chassis cab that you can customise in lots of ways or a window van, and has a payload of up to three tonnes.



Amarok

The Amarok joined the range in 2011. Its off-road and load-shifting credentials earned it the 'International Pick-up of the Year' award, and press praised its comfort and ease of driving.



Caravelle

For the ultimate level of executive comfort, only a Caravelle will fit the bill. It's an outstanding, flexible passenger carrier that can carry people and their luggage efficiently and easily.



Trust your Van Centre network

OWNING A VAN is about more than just the vehicle – it's about support, too. That means helpful advice, affordable finance, and maintenance and servicing to keep your van running more efficiently for longer.

That's where our network of over 100 Van Centres and Authorised Repairers comes in. All our staff are fully trained to solve any problem you may have.

• Find out how your local Van Centre can help right now – see pages 24-25.

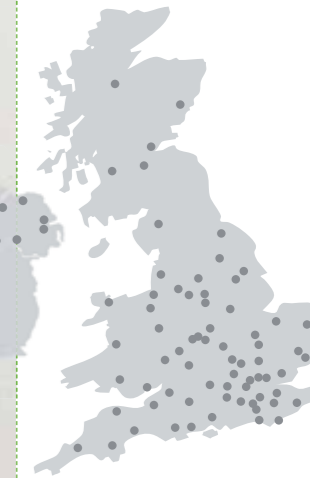

  To find your nearest Van Centre or order a brochure, visit www.volkswagen-vans.co.uk or call 0800 717131

Volkswagen round-up

Accolades and awards ● BlueMotion Technology across the range ● New trims for Caddy and Transporter

Volkswagen vans shine under awards spotlight



Volkswagen Commercial Vehicles has won a host of awards in recent months, including the title of 'Manufacturer of the Year' for 2012 from *Van Fleet World*.

The magazine also awarded the Transporter its 'Best Medium Van' prize, while the Caddy was 'Best Small Van'.

The Transporter was named 'Medium Panel Van' and 'Fleet Van of the Year' for 2012 by *Fleet Van*, while the top-of-the-range Transporter Sportline was *What Van?* magazine's 'Editor's Choice'.

The Caddy 4MOTION® was *What Van?*'s '4x4 of the Year', while the Amarok won 'Pick-up of the Year' from *What Van?* and 'Best Pick-up' at the British Insurance Vehicle Security Awards. The Amarok is also *4x4 Magazine's* 'Pick-up of the Year'.

To cap it all, Volkswagen Commercial Vehicles topped the *Fleet News* FN50 Reliability Survey as the 'Most Reliable Van Manufacturer', with the Caddy, Transporter and Crafter all in the top six.

These awards recognise and prove that our promise to you is truly alive and well. That promise is to bring you products that are more versatile, reliable, efficient and better value for money than ever.



Caravelle Edition 25 is a hit

The limited-edition Caravelle Edition 25 – packed with a wealth of the most exclusive options – was hugely popular when orders opened in January. Make sure you don't miss the next special edition – follow our Twitter feed at [Volkswagen_CV](#)



BlueMotion Technology is here

BlueMotion Technology offers increased fuel efficiency and reduced carbon emissions, and it's available on most models in our range. To find out how BlueMotion Technology can help cut your fuel bills, turn to pages 20-21 or ask your Van Centre for details.



Finance that makes buying your vehicle easy

Getting your hands on a new van or passenger carrier from Volkswagen Commercial Vehicles could be even more affordable – and easier – than you think.

We've got a great range of finance deals that allow us to tailor a solution to the needs of your business and your pocket. That might be a lower initial deposit, or regular, fixed monthly payments that include pre-planned costs

for servicing and maintenance. It all helps you know exactly how much your vehicle will cost now and over the long term.

We have special finance offers, too, which offer you even more value for money, and they're regularly updated. You can find all the latest deals at [www.volkswagen-vans.co.uk](#), or pop into your local Van Centre to find out how we can help you.

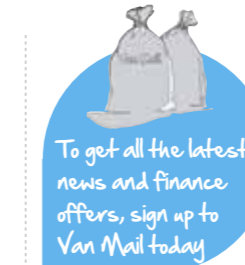

Get connected with us online

We've got lots of ways to stay up to date with all that's going on in the world of Volkswagen Commercial Vehicles.

Sign up to Van Mail for the latest news and finance offers, or follow us on Twitter and like us on Facebook for a great mix of news, tips and exclusive competitions.

Our YouTube channel is packed with useful and fun videos, too. To stay connected, just add the links below to your browser's favourites.



New trims offer outstanding value

Now there's even more choice for Caddy and Transporter buyers, thanks to the introduction of new trims that offer a great pack of features at one easy price.

That makes buying a van with a high level of specification really simple and delivers you great value for money.

On Transporter panel vans and kombis, and Caddy panel vans,

Trendline and Highline trims bring extra features to the already well-appointed standard model. On the Transporter, you can also go for the ultra-high-level Sportline trim to really mark out your van and your business from the pack.

If you need to add even more features, there's an extensive list of factory-fit options and Add On accessories.



Get even more with Add Ons

Add Ons is Volkswagen Commercial Vehicles' range of accessories, with lots of work, technology and leisure products that can be fitted by your Van Centre at any time. See pages 46-47 for more details.

Contact us now: To find your local Van Centre, get a brochure for a different model, or book a test drive: 0800 717131 [www.volkswagen-vans.co.uk](#)

Get connected: [Volkswagen_CV](#) [VolkswagenCommercialVehiclesUK](#) [vwcommercialvehicles](#) [www.volkswagen-vans.co.uk/vanmail](#)

Contents

All your vehicle-buying questions answered

What is it like to drive? >p10

Which model is right for me? >p14

Which engine do I need? >p18

What support can I expect? >p22

How much does it cost? >p26

What options can I choose? >p29

What are the facts and figures? >p48

Vehicles shown on the following pages may contain factory-fitted options that are available at an additional price



Add it all up...

Keep track of your vehicle, engine and option choices using our handy checklist – you'll find it inside the back cover

Driving

Get from A to B easily and in comfort



Parking is easy

The short-wheelbase Transporter shuttle and window van are about the same length as a family saloon, making them easy to park. If you add optional parking sensors, fitting into tight spots is even easier.

The perfect way to arrive in style

The Transporter shuttle and window van are packed with features to help move your passengers safely, efficiently and comfortably

The Transporter shuttle and window van have the sort of car-like driving feel that makes it easy to get your passengers to their destination in comfort. That's thanks to compact dimensions that are similar in size to a family saloon, as well as a choice of powerful 2.0-litre TDI engines.

Geared up for easy shifts

All Transporter passenger carriers come with either a five- or six-speed manual gearbox, with an easy-to-reach, dash-mounted gear lever. You can also opt for our seven-speed Direct Shift Gearbox (DSG). Its fully automatic gear changes make it great for city driving, and you can always take control and change gear yourself by simply nudging the gear lever up or down.

Safety comes as standard

The Transporter shuttle and window van are packed with technology to help keep you – and your passengers – as safe as possible on the road. Volkswagen's advanced ESP (Electronic Stabilisation Programme) works with ABS (Anti-lock Braking System), EBD (Electronic Brakeforce Distribution) and TCS (Traction Control

System), while Hill Hold Assist makes hill-starts a doddle. All these features are fitted as standard on every vehicle and work without you having to lift a finger.

Off-road ability

If you'll be driving off-road or where more traction is needed, consider the optional 4MOTION® drivetrain. This all-wheel-drive system automatically sends power to the wheels that need traction most when conditions become slippery.



The Direct Shift Gearbox works as an automatic or a quick-shift manual

Driving tech explained



Direct Shift Gearbox (DSG)

Our seven-speed Direct Shift Gearbox (DSG) is great for city driving. It can be used either as a fully automatic gearbox or as a quick-shift manual. Just nudge the gear lever forwards or backwards to change gear up or down.

4MOTION

4MOTION® is an all-wheel-drive system that helps maintain optimum grip in all conditions. If one wheel loses traction, 4MOTION® reacts in milliseconds and sends more power to the wheels with the better grip.

Comfortable and convenient

Comfortable, versatile and packed with clever features, Transporter passenger carriers are great for keeping your business working – even when you're on the road

There's a good chance that you spend more time in your Transporter than on your sofa at home, so it has to be comfortable. When you're on the road, you also want to stay in touch with colleagues and customers. That's why we've built the cab of the Transporter with both comfort *and* work in mind.

The perfect fit for you

Whether you're doing motorway miles or door-to-door jobs, the Transporter's cab fits like a glove. The dash-mounted gear lever gives you uncluttered floor space, while the ergonomically designed seats provide terrific support. Then there's the dash – clean and tidy, with the key controls just where you want them.

Stay in touch on the move

Your clients want to be able to reach you all the time. That's why we offer optional Bluetooth connectivity, allowing you to connect your phone and speak safely on the move. With a selection of high-quality audio and satellite-navigation systems, you can also stay entertained and on the right road wherever you are.



Electric front windows and electrically adjustable mirrors come as standard

Optional Bluetooth connectivity lets you use your phone without taking your hands off the wheel



Just cruising

Cruise control is an option on all Transporter passenger carriers, and comes as standard on BlueMotion Technology models. By keeping a constant speed, it reduces driver stress and helps keep fuel bills low, especially on long journeys.

Ultra-clear dashboard

All the controls are easy to use, so you stay focused on the road. A gearshift indicator helps you change gear at the most economical moment.

Comfy seats

Our ergonomically designed seats offer terrific support. **Want more?** Our seat options let you choose a layout that's perfect for you and your passengers. See page 40.



Cool and comfortable

Heat-reflective glass keeps things cool, even in the summer. **Want more?** Choose air-conditioning – this gives you even more temperature control. See page 39.

Entertainment and sat-nav to suit you

Want to play MP3s, listen to DAB radio, watch a DVD once you've stopped or add Europe-wide sat-nav? We've got the kit for you. See page 32.

Three-spoke steering wheel

The three-spoke steering wheel is comfortable and easy to use at all times. **Want more?** A multi-function steering wheel (see page 38) and optional Bluetooth let you control your phone and audio system.



Plenty of places to store your stuff

PASSENGER CARRIERS don't carry only people and luggage in the rear – their cabs hold all the clutter of your working day, too. That means invoices, drinks, laptops and more. You'll find lots of clever nooks and crannies in every Transporter – a shelf in the roof, huge door pockets, a large area under the passenger seats and an optional fold-down tray on the passenger seat.



Your local Van Centre can help you choose the right options for you. Find your nearest one on www.volkswagen-vans.co.uk, or call 0800 717131

Seating

Flexible seating solutions to suit your needs



Transporter window van

Fine for nine

The Transporter window van comes with a choice of seating options for up to eight passengers and room for plenty of luggage

The Transporter window van is the perfect vehicle if you want to move large groups of people quickly and efficiently. It comes with a choice of short- and long-wheelbases, three optional roof heights for added headroom and seven different front and rear seat options that allow you to carry up to nine occupants.

The long and tall of it

With a floor height of 572mm, and a side sliding door on the left, getting in and out of the Transporter window van is easy. With roof heights up to 1,925mm on the long-wheelbase model with the high-roof option, there's plenty of headroom for even the tallest passengers.

Seating that suits you

With up to seven seating configurations, you've got a world of choice. In the front, the driver can choose either a single passenger seat, or a two-seater bench to carry an extra person. You can even choose heated or swivelling seats if you opt for the single front passenger seat. In the back, you can have a single row of up to three seats, or two rows totalling up to six.

This level of versatility means you can choose to carry more people, or luggage. To see all the seat options available, turn to page 40.



Keeping cool

Keep your passengers cool with one of our air-conditioning options - see page 39 for details.



Transporter window van features

- ✓ Electrically adjustable and heated door mirrors
- ✓ Driver's seat with height, lumbar, reach and rake adjustment
- ✓ Sliding side door (near side)
- ✓ Tailgate with heated rear window and wash/wipe
- ✓ Electric front windows
- ✓ RCD 210 radio/single CD player
- ✓ Remote central locking
- ✓ Driver and passenger airbags
- ✓ Place cloth upholstery

Seating

Transporter shuttle

Style comes as standard

The Transporter shuttle offers increased levels of style and comfort, while still providing seating for up to eight passengers and plenty of space for luggage

The Transporter shuttle has been designed with style and comfort in mind. It takes all of the great practicality and functionality of the Transporter window van and adds even more passenger- and driver-friendly features. That means sliding doors on both sides of the vehicle to make getting in and out that much easier, and a spacious seating layout with plenty of room for up to eight passengers.

Plenty of kit

With a choice of S and SE models, the Transporter shuttle lets you choose your level of interior luxury.

The S model has all the great features of the window van – plus Tasamo cloth upholstery, additional reading lights, arm rests and grab handles. The driver benefits



Looking good

If style is your thing, you should check out our selection of alloy wheels (See page 31 for details)

from this extra comfort, too, with dimmable dashboard illumination and electrically adjustable and heated door mirrors.

Class inside and out

If you want to add even more luxury to your shuttle, you can opt for the SE model, which comes with manually controlled air-conditioning – a great way to keep you and your passengers cool.

The SE also features Timo cloth upholstery and upgraded headlining in the passenger compartment with ventilation strips and reading lights. On the outside, body-coloured bumpers, full wheel trims and chrome radiator grille trim add extra style to give the SE the impressive road presence it deserves.



☎️ 📍 Want to see the Transporter shuttle for yourself?
To find your nearest Van Centre, call 0800 717131
or visit www.volkswagen-vans.co.uk

TRANSPORTER SHUTTLE

Transporter shuttle S features

- ✓ Electrically adjustable and heated mirrors
- ✓ Side sliding doors on both sides
- ✓ Tailgate with heated rear window and wash/wipe
- ✓ Driver's seat with height, lumbar, reach and rake adjustment
- ✓ Electric front windows
- ✓ RCD 210 radio/single CD player
- ✓ Remote central locking
- ✓ Thatcham category 1 alarm and immobiliser with interior monitoring and tow-away protection
- ✓ Driver and passenger airbags
- ✓ Tasamo cloth upholstery

Transporter shuttle SE features

- ✓ Body-coloured bumpers
- ✓ Carpet floor covering in the cab
- ✓ Chrome trim on the radiator grille
- ✓ Manually controlled air-conditioning on the dash, with rear roof vents
- ✓ Timo cloth upholstery
- ✓ Upgraded headlining in passenger compartment

Engines

Technology that helps cut fuel bills and lower emissions

TDI TECHNOLOGY

Intelligent power to drive you on

The Transporter's advanced 2.0-litre TDI engines are strong and refined. They also help you keep fuel bills to a minimum

Keeping your running costs low is as big a priority as your passengers' comfort. However, thanks to Volkswagen's years of experience developing advanced turbo-diesel technology, the Transporter's 2.0-litre TDI engines now offer more power and use less fuel than ever before – up to 20% less, in fact.

Four versatile engine choices

The Transporter's 84PS 2.0-litre TDI has 220Nm of torque – plenty of power for passengers and luggage.

Yet it boasts fuel efficiency up to 38.7mpg (combined) and CO₂ emissions of 193g/km. Need more power? The twin-turbo 180PS BiTDI has 400Nm torque, with 36.2mpg (combined) and CO₂ emissions of 205g/km

Go even greener

If you want to improve your fuel efficiency another step, and cut emissions even further, you can always choose to add BlueMotion Technology to your engine package. To find out more, turn the page.

Engine specifications

See pages 48 for full engine data

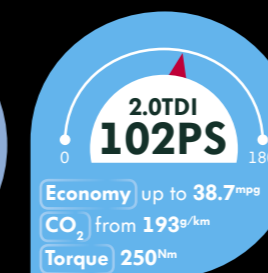
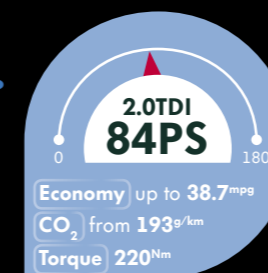

Why torque matters

Torque is often more important than power when it comes to an engine's performance. If you carry heavy cargo often, pick an engine with lots of torque. It will move a heavy load from a standing start better than one with less torque, and keep it moving more easily. It could even use less fuel, because you won't need to rev it as much to get the best out of it.



Add a sat-nav

A sat-nav system can plot shorter routes and prevent you making wrong turns, and can even navigate around traffic jams. It all helps cut fuel consumption.



Watch your speed

The faster you go, the more fuel you use. Driving at 80mph is not only illegal, it uses 25% more fuel than 70mph. Driving at 60mph could save you 9% more.

Top tips to save you fuel

Cutting fuel use isn't just about engine technology – it's also about being clever. Follow our four tips to make your van as economical as possible.

Use your van's gearshift indicator

A gearshift indicator is fitted to all Transporters. It helps you change gear at the most efficient times, which cuts fuel use and lowers emissions.



Check your tyres

Up to 20% of a vehicle's fuel consumption is used in overcoming the tyres' rolling resistance. It's even more if your tyres are underinflated, so check them regularly.



More miles, less impact

BlueMotion Technology cuts your fuel consumption and CO₂ emissions, and it's now available on the Transporter passenger-carrier range

At Volkswagen, we're as keen as you to reduce the amount of fuel our vehicles use and the impact of their emissions. We know that fuel costs are a big burden on drivers and businesses, so improving our vehicle efficiency brings you even better value. That's why we've introduced BlueMotion Technology to the Transporter range.

The power of technology

All Transporter shuttles and window vans that carry the BlueMotion Technology badge include our energy-saving solutions as standard: start/stop, low-rolling-resistance tyres, brake-energy recuperation and cruise control.

Together, they create lower CO₂ emissions and improved fuel economy, bringing instant fuel savings. You'll save money – and time – at the pumps.

Two engines, all the options

BlueMotion Technology is available on two engines in the Transporter range – the 84PS and 114PS versions. Each delivers combined fuel economy of 41.5mpg and cuts CO₂ emissions to 179g/km.

Another benefit of BlueMotion Technology is that the savings come without compromise, because you can add almost any of the factory-fit options that you like. Your Van Centre can help you choose the best ones for you.



BlueMotion Technology specifications

See page 48 for full engine data

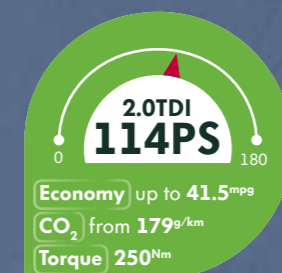
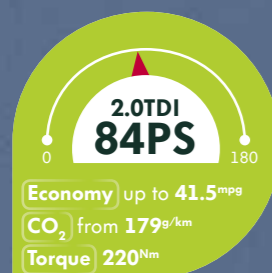

How BlueMotion Technology works to lower your fuel bills and CO₂ emissions

BlueMotion Technology is available on the 84PS and 114PS Transporter shuttle and window vans, and is made up of four elements. Together, they make significant cuts in fuel consumption and CO₂ emissions, which keeps money in your pocket and reduces the impact on the world around us. Here you can learn more about these elements and what they do.

Cruise control

By keeping your van at a constant speed, cruise control saves fuel that would normally be wasted when your speed fluctuates. It's especially useful for driving over long stretches, because it stops your speed creeping up unintentionally and reduces driver stress.



Low-rolling-resistance tyres

Fitting tyres with low rolling resistance means that the engine doesn't have to work as hard to get your vehicle moving – or keep it moving. It all helps to save fuel and reduce carbon emissions.



Start/stop

Start/stop allows you to save fuel at traffic lights. When you stop, put your vehicle in neutral, release the clutch and the engine automatically switches off, saving fuel and reducing emissions. When you're ready to go, depress the clutch and the engine starts up again.

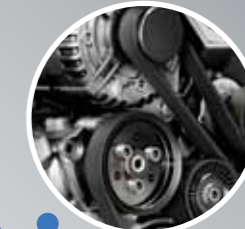

Brake-energy recuperation

When braking, energy during deceleration is wasted. Our energy recuperation system uses some of that momentum to turn the alternator and charge the battery. If the battery is well-charged, the engine has to do less work turning the alternator to keep it topped up. This cuts fuel use and emissions.



Full support right from the start

We want to make sure that using your Transporter is as hassle-free and cost-efficient as possible, so every vehicle comes with a three-year warranty and a choice of finance, servicing and insurance options. It all helps to keep the big issues covered



A three-year warranty that lasts up to 100,000 miles

All Transporters get a three-year, 100,000-mile warranty – and so do any factory-fit options that you buy. The vehicle warranty is made up of:

- A two-year manufacturer's warranty with unlimited mileage
- A third-year Van Centre warranty, up to a maximum of 100,000 miles

Even if you exceed 100,000 miles during your first two years, the manufacturer's two-year warranty will still be valid.

Want cover for longer?

You can extend your vehicle warranty online or by phone. You can choose Comprehensive or Major Component cover and either one-off or monthly payments. Call **0845 641 9712** or visit www.volkswagencvwarranty.co.uk for details.



Service options designed to fit your business perfectly

It's only natural that you want to keep your vehicle running at its best. Getting it serviced at a Volkswagen Van Centre is a great way to ensure that's exactly what happens. However, when it comes to servicing, we know every business has different needs. That's why we've developed three different service options for you to choose from:

- Pay Monthly
- Pay Upfront
- Pay On-Demand

Whichever suits your business best, you can rest assured that when you book in your vehicle, it'll be looked at by Volkswagen-trained technicians and they'll use only Volkswagen quality parts. What's more, there's a two-year warranty on the parts and one on labour.

For more details

visit www.volkswagen-vans.co.uk, or call **0800 717131** to learn more.



Volkswagen Insurance keeps you covered*

Volkswagen Commercial Vehicle Insurance can provide you with cost-effective, comprehensive motor insurance. Look at some of the benefits:

- Seven-day free cover to allow you to drive your vehicle away knowing it's insured
- All repairs performed by approved repairers
- Volkswagen quality parts on all repairs
- Courtesy vehicle provided during repair following an accident
- Cover for breakage and damage to glass
- Tools-in-transit cover (up to £1,000)
- In-vehicle personal belongings cover (up to £500)
- Vehicle recovery
- 60-day European Union cover
- Legal expenses cover up to £100,000

We also offer a range of gap insurance products. These help you replace your vehicle or protect you from any financial shortfall if it is written off.

For more details

visit www.insurewithvwcv.co.uk, call **0800 316 7896** or pop into your Van Centre and ask for a Flexible Finance brochure.

* Terms and conditions apply

"If your van's not working, you're not working. That's why we're here to help"



Flexible Finance that makes things affordable

We can also make buying a new van more affordable in the first place. Speak to us about our selection of finance options, which include:

- Contract hire
- Finance lease
- Lease purchase
- Hire purchase

For more details

visit www.volkswagen-vans.co.uk/finance or pick up our Flexible Finance brochure at your nearest Van Centre.



Three years' Roadside Assistance

Sometimes, the unexpected happens. If it does, your new Transporter comes with an unlimited-mileage recovery and assistance package. It lasts the same three years as your warranty and operates 24 hours a day, 365 days a year.

Cover is available across the UK and most of Europe. Our fully trained technicians can diagnose most problems at the roadside and they use Volkswagen quality parts.

Learn more

Visit your Van Centre to get a Volkswagen Roadside Assistance handbook, visit www.volkswagen-vans.co.uk/aftersales/roadside-assistance or call **0800 77 71 72**



Van Centres – always there for you

Our dedicated Van Centre network is the backbone of everything we do, with more than 100 Van Centres and Authorised Repairers throughout the UK

Our Van Centre network offers a wide range of services, from MOTs to accessories, servicing to fully fitted parts. Not only that, but we use Volkswagen quality parts and you get dedicated staff who understand your vans intimately. So pop in for a coffee and a chat, and find out what your Van Centre can do for you.

Turn the page to learn more about our Van Centre network

7 ways your Van Centre can help you right now

Make full use of your nearest Van Centre – it's full of Volkswagen experts who know your vehicle better than anyone and who can help you to get the best out of it



Quality servicing you'd expect at a price you wouldn't

Unpredictability and moving goalposts are part of life for a modern business, making it difficult to predict how many miles your vehicle will do in a year, or how long you'll need to keep it. Our National Service Pricing is designed for customers who need the flexibility of being able to book their vehicle in for a service whenever it needs it. When you do, our technicians will do everything necessary to ensure that your vehicle is back on the road, working hard for your business, as soon as possible.



Always on hand to help

Picking a van that's perfect for your needs

We know that choosing your next van or passenger carrier is a big decision. You want a vehicle that works as hard as you do, both now and for the long-term – one that's versatile, cost-effective and reliable. We're here to help make your choice easier.

Our Van Centre experts can offer advice on every model in the range and help you pick the right vehicle and factory-fit options for your business. They can also advise you on the best finance packages to ensure that your payments make financial sense.



Express Visual Checks – peace of mind for free

Your Van Centre or Authorised Repairer can give your vehicle a free, 29-point Express Visual Check for complete peace of mind. You'll be given a comprehensive report, with the results clearly explained, and your technician will talk you through what work may need to be done in the future, so you can plan ahead and budget for it. If something needs urgent attention, you can get a precise quote before any work is done – and all the Volkswagen parts are covered by a two-year warranty.

Accessories designed to help you get more from your van

Perhaps you've bought a van and your needs have changed – maybe you need a towbar or a roof rack, or perhaps you want to give your van some extra style. That's where Add Ons comes in. Add Ons is an extensive range of Volkswagen-approved accessories, available to buy and be fitted at your local Van Centre. We've got everything from towbars to tailgate spoilers, load nets to leather seats and sat-nav systems to stunning alloy wheels.



Fast, hassle-free van rental for one-off jobs

Need another van for just a short while? We can hire you any vehicle from our fleet – Caddy, Transporter or Crafter – or passenger-carrier versions of the Transporter and Crafter if you need to move people.

For more information, call the Van Rental team on 01908 467450

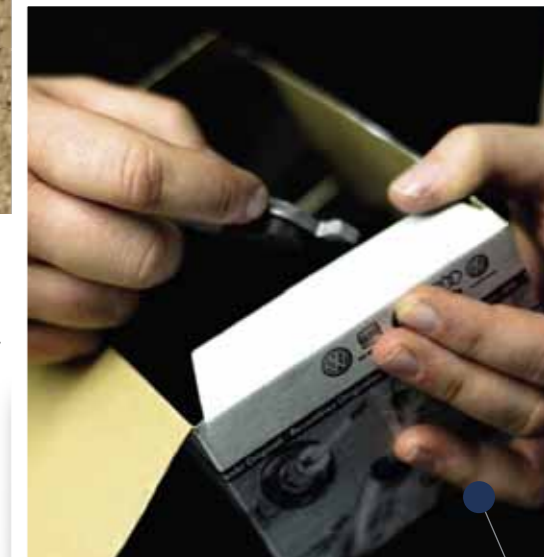

Fully fitted parts for a fixed price – and not a penny more

The pricing of all our Volkswagen quality parts is straightforward and clear, so you know exactly how much you're paying. Even better, when they're fitted by trained technicians at a Van Centre or Authorised Repairer they come with two years' warranty and 12 months warranty on labour. If your van is over five years old, ask us about our Economy Parts range. This is a great-value way to help keep your vehicle 100% Volkswagen – it uses high-quality parts that come with a two-year warranty.

Taking the worry out of tyres

Why run around looking for a fitter who has your tyres in stock? Let us fit new tyres when your van is in for its service and it'll keep your van off the road for less time. We have a huge range of tyres for all Volkswagen vans, from economy to premium brands, including winter tyres.

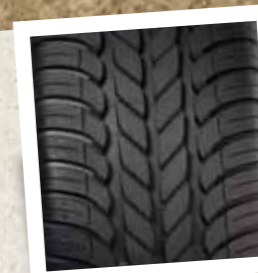

What else can we do?

Loads! Just pop into any Van Centre and ask us. For example, we may be able to point you to a local signwriter, recharge your air-conditioning, or answer any queries about your vehicle. Whatever it may be, we're here for you.



To find your nearest Van Centre, visit www.volkswagen-vans.co.uk or call 0800 717131

Prices

Every Transporter listed. All the prices you need

Every Transporter has an On The Road package that covers basic vehicle costs

On The Road (OTR) package	
First registration fee	£55.00
Delivery to Van Centre	£565.00
VAT	£117.00
Vehicle Excise Duty (12 months)	Various*
Number plates	£20.00
Basic OTR (ex VAT)	Various*
Total OTR price	Various*

Transporter window van



Model	Engine/transmission	Basic (ex VAT)	Total (inc VAT)	Total RRP including OTR*		Insurance group †
				(ex VAT)	(inc VAT)	
Transporter window van – short wheelbase						
T30	2.0TDI 84PS	£18,510.00	£22,212.00	£19,610.00	£23,429.00	6E
	2.0TDI 102PS	£19,260.00	£23,112.00	£20,360.00	£24,329.00	TBC
	2.0TDI 140PS	£20,760.00	£24,912.00	£22,000.00	£26,269.00	6E
	2.0TDI 140PS DSG	£22,160.00	£26,592.00	£23,400.00	£27,949.00	6E
	2.0TDI 140PS 4MOTION®	£22,960.00	£27,552.00	£24,200.00	£28,909.00	6E
	2.0BiTDI 180PS	£22,360.00	£26,832.00	£23,460.00	£28,049.00	6E
	2.0BiTDI 180PS DSG	£23,760.00	£28,512.00	£24,860.00	£29,729.00	TBC
	2.0BiTDI 180PS 4MOTION®	£24,560.00	£29,472.00	£25,800.00	£30,829.00	TBC
	2.0BiTDI 180PS DSG 4MOTION®	£25,960.00	£31,152.00	£27,415.00	£32,724.00	TBC
T32	2.0TDI 102PS	£19,610.00	£23,532.00	£20,710.00	£24,749.00	7E
	2.0TDI 140PS	£21,110.00	£25,332.00	£22,350.00	£26,689.00	7E
	2.0TDI 140PS DSG	£22,510.00	£27,012.00	£23,750.00	£28,369.00	7E
	2.0TDI 140PS 4MOTION®	£23,310.00	£27,972.00	£24,550.00	£29,329.00	7E
	2.0BiTDI 180PS	£22,710.00	£27,252.00	£23,810.00	£28,469.00	TBC
	2.0BiTDI 180PS DSG	£24,110.00	£28,932.00	£25,210.00	£30,149.00	TBC
	2.0BiTDI 180PS 4MOTION®	£24,910.00	£29,892.00	£26,150.00	£31,249.00	TBC
	2.0BiTDI 180PS DSG 4MOTION®	£26,310.00	£31,572.00	£27,765.00	£33,144.00	TBC
	Transporter window van – long wheelbase					
T30	2.0TDI 84PS	£19,000.00	£22,800.00	£20,100.00	£24,017.00	TBC
	2.0TDI 102PS	£19,750.00	£23,700.00	£20,850.00	£24,917.00	TBC
	2.0TDI 140PS	£21,250.00	£25,500.00	£22,490.00	£26,857.00	6E
	2.0TDI 140PS DSG	£22,650.00	£27,180.00	£23,890.00	£28,537.00	6E
	2.0TDI 140PS 4MOTION®	£23,450.00	£28,140.00	£24,690.00	£29,497.00	7E
	2.0BiTDI 180PS	£22,850.00	£27,420.00	£23,950.00	£28,637.00	TBC
	2.0BiTDI 180PS DSG	£24,250.00	£29,100.00	£25,350.00	£30,317.00	TBC
	2.0BiTDI 180PS 4MOTION®	£25,050.00	£30,060.00	£26,290.00	£31,417.00	TBC
	2.0BiTDI 180PS DSG 4MOTION®	£26,450.00	£31,740.00	£27,905.00	£33,312.00	TBC
T32	2.0TDI 102PS	£20,100.00	£24,120.00	£21,200.00	£25,337.00	7E
	2.0TDI 140PS	£21,600.00	£25,920.00	£22,840.00	£27,277.00	7E
	2.0TDI 140PS DSG	£23,000.00	£27,600.00	£24,240.00	£28,957.00	TBC
	2.0TDI 140PS 4MOTION®	£23,800.00	£28,560.00	£25,040.00	£29,917.00	7E
	2.0BiTDI 180PS	£23,200.00	£27,840.00	£24,300.00	£29,057.00	8E
	2.0BiTDI 180PS DSG	£24,600.00	£29,520.00	£25,700.00	£30,737.00	TBC
	2.0BiTDI 180PS 4MOTION®	£25,400.00	£30,480.00	£26,500.00	£31,697.00	TBC
	2.0BiTDI 180PS DSG 4MOTION®	£26,800.00	£32,160.00	£27,900.00	£33,377.00	TBC

Prices: Transporter shuttle



Model	Engine/transmission	Basic (ex VAT)	Total (inc VAT)	Total RRP including OTR*		Insurance group †
				(ex VAT)	(inc VAT)	
Transporter shuttle S – short wheelbase						
T30	2.0TDI 84PS	£22,125.00	£26,550.00	£23,225.00	£27,767.00	‡
	2.0TDI 102PS	£22,875.00	£27,450.00	£23,975.00	£28,667.00	‡
	2.0TDI 140PS	£24,375.00	£29,250.00	£25,475.00	£30,467.00	‡
	2.0TDI 140PS DSG	£25,775.00	£30,930.00	£27,015.00	£32,287.00	‡
Transporter shuttle S – long wheelbase						
T30	2.0TDI 84PS	£22,715.00	£27,258.00	£23,815.00	£28,475.00	‡
	2.0TDI 102PS	£23,465.00	£28,158.00	£24,565.00	£29,375.00	‡
	2.0TDI 140PS	£24,965.00	£29,958.00	£26,065.00	£31,175.00	‡
	2.0TDI 140PS DSG	£26,365.00	£31,638.00	£27,605.00	£32,995.00	‡
Transporter shuttle SE – short wheelbase						
T30	2.0TDI 102PS	£24,125.00	£28,950.00	£25,225.00	£30,167.00	‡
	2.0TDI 140PS	£25,625.00	£30,750.00	£26,725.00	£31,967.00	‡
	2.0TDI 140PS DSG	£27,025.00	£32,430.00	£28,265.00	£33,787.00	‡
	2.0TDI 140PS 4MOTION®	£27,825.00	£33,390.00	£29,065.00	£34,747.00	‡
	2.0BiTDI 180PS	£27,225.00	£32,670.00	£28,465.00	£34,027.00	‡
	2.0BiTDI 180PS DSG	£28,625.00	£34,350.00	£29,865.00	£35,707.00	‡
	2.0BiTDI 180PS 4MOTION®	£29,425.00	£35,310.00	£30,665.00	£36,667.00	‡
	2.0BiTDI 180PS DSG 4MOTION®	£30,825.00	£36,990.00	£32,280.00	£38,562.00	‡
	Transporter shuttle SE – long wheelbase					
T30	2.0TDI 102PS	£24,715.00	£29,658.00	£25,815.00	£30,875.00	‡
	2.0TDI 140PS	£26,215.00	£31,458.00	£27,315.00	£32,675.00	‡
	2.0TDI 140PS DSG	£27,615.00	£33,138.00	£28,855.00	£34,495.00	‡
	2.0TDI 140PS 4MOTION®	£28,415.00	£34,098.00	£29,655.00	£35,455.00	‡
	2.0BiTDI 180PS	£27,815.00	£33,378.00	£29,055.00	£34,735.00	‡
	2.0BiTDI 180PS DSG	£29,215.00	£35,058.00	£30,455.00	£36,415.00	‡
T32	2.0BiTDI 180PS 4MOTION®	£30,015.00	£36,018.00	£31,255.00	£37,375.00	‡
	2.0BiTDI 180PS DSG 4MOTION®	£31,415.00	£37,698.00	£32,870.00	£39,270.00	‡

* For full details of VED (Vehicle Excise Duty) bands and other costs included in the On The Road package, please see the inside back cover.

† As advised by the Association of British Insurers (ABI). Please see www.thatcham.org/abigrouprating for more information.

‡ Transporter shuttle models do not have an insurance rating because they can have more than eight seats. Not having an insurance rating does not mean insurers will not be able to provide a quote. Customers are advised to discuss cover directly with the insurance company.



Finance that makes buying a Volkswagen even more affordable

Thanks to our extensive range of finance packages, you may be surprised at how much you can afford. Make driving a Volkswagen a reality by speaking to us today.

To find the nearest Van Centre to you, call us on 0800 717131 or visit www.volkswagen-vans.co.uk

Prices: Transporter BlueMotion Technology

Model	Engine	Basic (ex VAT)	Total (inc VAT)	Total RRP including OTR*		Insurance group †
				(ex VAT)	(inc VAT)	
Transporter window van						
Transporter window van BlueMotion Technology – short wheelbase						
T30	2.0TDI 84PS	£18,840.00	£22,608.00	£19,805.00	£23,690.00	8E
	2.0TDI 114PS	£19,890.00	£23,868.00	£20,855.00	£24,950.00	9E
T32	2.0TDI 114PS	£20,240.00	£24,288.00	£21,205.00	£25,370.00	10E
Transporter window van BlueMotion Technology – long wheelbase						
T30	2.0TDI 84PS	£19,330.00	£23,196.00	£20,295.00	£24,278.00	8E
	2.0TDI 114PS	£20,380.00	£24,456.00	£21,345.00	£25,538.00	9E
T32	2.0TDI 114PS	£20,730.00	£24,876.00	£21,695.00	£25,958.00	10E
Transporter shuttle						
Transporter shuttle S BlueMotion Technology – short wheelbase						
T30	2.0TDI 84PS	£22,455.00	£26,946.00	£23,420.00	£28,028.00	‡
	2.0TDI 114PS	£23,505.00	£28,206.00	£24,470.00	£29,288.00	‡
Transporter shuttle S BlueMotion Technology – long wheelbase						
T30	2.0TDI 84PS	£23,045.00	£27,654.00	£24,010.00	£28,736.00	‡
	2.0TDI 114PS	£24,095.00	£28,914.00	£25,060.00	£29,996.00	‡
Transporter shuttle SE BlueMotion Technology – short wheelbase						
T30	2.0TDI 114PS	£24,755.00	£29,706.00	£25,720.00	£30,788.00	‡
Transporter shuttle SE BlueMotion Technology – long wheelbase						
T30	2.0TDI 114PS	£25,345.00	£30,414.00	£26,310.00	£31,496.00	‡



Finance with fixed costs that help you budget for the life of your vehicle

With fixed monthly rentals, Contract Hire is perfect for a business that wants to budget effectively. Including service and maintenance in your agreement will also ensure no unforeseen expenditure.

To find the nearest Van Centre to you, call us on 0800 717131 or visit www.volkswagen-vans.co.uk

* For full details of VED (Vehicle Excise Duty) bands and other costs included in the On The Road package, please see the inside back cover.

† As advised by the Association of British Insurers (ABI). Please see www.thatcham.org/abigrouprating for more information.

‡ Transporter shuttle models do not have an insurance rating because they can have more than eight seats. Not having an insurance rating does not mean insurers will not be able to provide a quote. Customers are advised to discuss cover directly with the insurance company.

Options

Get the best from your vehicle with our quality options

ways to get even more from your Transporter



Audio, phone and sat-nav

You can opt for one of our upgraded stereos with audio and sat-nav, such as our RNS510, with voice or touch-screen control. It has an FM/AM radio with RDS (radio data system) for traffic updates, a CD slot, 30GB hard drive, SD card slot and an aux-in socket. Maps for western Europe are included.

p32

Body and chassis

If you want to get more into your Transporter, optional roof packs for the window van add extra height and volume, while our rear-door options will make loading and unloading easier. You can also add rear doors that open 250° for easy access.

p35

Comfort

Customise your Transporter with an electric glass sunroof, extra storage areas or a multi-function leather steering wheel. You can also add cruise control (standard on BlueMotion Technology models), which can help to save fuel by keeping your speed constant.

p38

Safety and security

The Transporter has lots of standard safety features, and you can add more, including extra airbags, tyre-pressure warning indicators and fog lights. You could also pick lane-change assist, parking sensors or an alarm pack.

p43



Alloy wheels

Alloy wheels can add a really stylish look to your vehicle. Our 18" Canberra wheels come in a set of four with a tyre repair kit and 255/45 R18 tyres, and are available on a variety of Transporter models. There are lots of other wheel designs to choose from, too.

p31



Options: Paint

You want your vehicle – and your business – to make an impression. The most striking way to do that is to opt for a distinctive paint finish

		Transporter window van		Transporter shuttle S		Transporter shuttle SE	
		Basic (ex VAT)	Total RRP (inc VAT)	Basic (ex VAT)	Total RRP (inc VAT)	Basic (ex VAT)	Total RRP (inc VAT)
Standard A great range of colours, available at no extra cost		S	S	S	S	S	S
	Note: only Candy White (B4B4) and Salsa Red (4Y4Y) are available for the Transporter shuttle SE						
Optional paints If you're after something a bit more particular		£295.00	£354.00	£295.00	£354.00	–	–
	Note: only Black (9000) is available for the Transporter shuttle S						
Metallic paints Mark out your van and your business from the competition with a smart metallic paint finish		£495.00	£594.00	£495.00	£594.00	£495.00	£594.00
Pearlescent paints Tiny flecks of material in the paint reflect light, giving your vehicle a unique look		£495.00	£594.00	£495.00	£594.00	£495.00	£594.00

Options: Alloy wheels and tyres

Complete your vehicle's sleek, sharp look with a set of stylish alloy wheels†

		Transporter window van		Transporter shuttle S		Transporter shuttle SE	
		Basic (ex VAT)	Total RRP (inc VAT)	Basic (ex VAT)	Total RRP (inc VAT)	Basic (ex VAT)	Total RRP (inc VAT)
16" Colmar Set of four 6.5J x 16 alloys with 215/65 R16 tyres Not available with 180PS engines		£605.00	£726.00	£605.00	£726.00	£605.00	£726.00
	All models						
16" Miyato Set of four 6.5J x 16 alloys with 215/65 R16 tyres Not available with 180PS engines		£510.00	£612.00	£510.00	£612.00	£510.00	£612.00
	All models						
17" Thunder Set of four 6.5J x 17 alloys with 235/55 R17 tyres		84PS, 102PS, 140PS £965.00 180PS £375.00 BlueMotion Technology £1,060.00	£1,158.00 £450.00 £1,272.00	£965.00 £375.00 £1,060.00	£1,158.00 £450.00 £1,272.00	£965.00 £375.00 £1,060.00	£1,158.00 £450.00 £1,272.00
17" Neva Set of four 7J x 17 alloys with 235/55 R17 tyres		140PS – 180PS – BlueMotion Technology –	– – –	– – –	– – –	£1,060.00 £475.00 £1,155.00	£1,272.00 £570.00 £1,386.00
17" Cascavel (Silver) Set of four 7J x 17 alloys with 235/55 R17 tyres		140PS – 180PS – BlueMotion Technology –	– – –	– – –	– – –	£1,065.00 £465.00 £1,160.00	£1,278.00 £558.00 £1,392.00
17" Cascavel (Anthracite/Silver) Set of four 7J x 17 alloys with 235/55 R17 tyres		140PS – 180PS – BlueMotion Technology –	– – –	– – –	– – –	£1,115.00 £540.00 £1,210.00	£1,338.00 £648.00 £1,452.00
18" Canberra Set of four 8J x 18 alloys with 255/45 R18 tyres		140PS £2,050.00 180PS £1,490.00	£2,460.00 £1,788.00	– –	– –	£1,955.00 £1,395.00	£2,346.00 £1,674.00
All-weather tyres Set of four 215/65 R16 tyres		82PS/102PS/114PS £200.00 140PS £200.00 180PS £95.00	£240.00 £240.00 £114.00	£200.00 £95.00 £95.00	£240.00 £114.00 £114.00	£200.00 £95.00 £95.00	£240.00 £114.00 £114.00

† Alloy wheels are not available for T32 Transporter shuttle and window van



Keep your alloys in perfect condition





Brake dust is full of abrasive and corrosive metal and carbon particles, so clean your alloys every couple of weeks with a specialist brush and cleaning fluid, then coat them with a wax protector. You can buy these at your local Van Centre.





Add Ons
 Accessories to help keep your vehicle 100% Volkswagen

If you want even more choice for alloy wheels, check out our Add Ons accessories range. Ask your local Van Centre for a brochure, call 0800 717131 or download a copy at www.volkswagen-vans.co.uk

Options: Audio, phone and satellite-navigation

Choose from a range of entertainment systems for great music on the go, or opt for one of our touch-screen satellite-navigation systems

			Transporter window van		Transporter shuttle S		Transporter shuttle SE	
			Basic (ex VAT)	Total RRP (inc VAT)	Basic (ex VAT)	Total RRP (inc VAT)	Basic (ex VAT)	Total RRP (inc VAT)
Audio								
RCD 210		A great basic system for music on the go. Listen to the AM/FM radio or play your own music on the single CD player.	S	S	S	S	S	S
		<ul style="list-style-type: none"> Two speakers (Transporter window van) Four speakers (Transporter shuttle) FM/AM radio Single CD player 						
RCD 310		This radio includes extra speakers, an aux-in for external devices.	£75.00	£90.00	£140.00	£168.00	£140.00	£168.00
		<ul style="list-style-type: none"> Four speakers FM/AM radio Single CD player MP3-file compatible Aux-in for external devices 						
RCD 310 WITH DAB+		DAB (Digital Audio Broadcast) offers more stations, a clearer signal and information about what's playing.	£240.00	£288.00	£240.00	£288.00	£240.00	£288.00
		<ul style="list-style-type: none"> Four speakers (Transporter window van) Eight speakers (Transporter shuttle) FM/AM radio DAB radio Single CD player MP3-file compatible Aux-in for external devices 						
RNS 315		A great sat-nav to help you get where you're going efficiently. It includes RDS (Radio Data System) for live traffic updates.	£560.00	£672.00	£545.00	£654.00	£490.00	£588.00
		<ul style="list-style-type: none"> 5" colour touch-screen 6GB flash memory Four speakers (Transporter window van) Eight speakers (Transporter shuttle) FM/AM radio with RDS Single CD player Aux-in for external devices SD card reader 						
		Note: requires radio upgrade						

			Transporter window van		Transporter shuttle S		Transporter shuttle SE		
			Basic (ex VAT)	Total RRP (inc VAT)	Basic (ex VAT)	Total RRP (inc VAT)	Basic (ex VAT)	Total RRP (inc VAT)	
Satellite-navigation									
RNS 510		This sat-nav system has voice control and a 6.5" colour touch-screen for easy use.	£1,845.00	£2,214.00	£1,825.00	£2,190.00	£1,825.00	£2,190.00	
		<ul style="list-style-type: none"> 6.5" colour touch-screen Voice control 30GB hard drive Four speakers (Transporter window van) Eight speakers (Transporter shuttle) FM/AM radio with RDS Single CD/DVD player Aux-in and SD card reader 							
RNS 510 WITH DAB+		This sat-nav system has voice control, a 6.5" colour touch-screen for easy use and DAB digital audio reception for more stations and clearer signal.	£1,900.00	£2,280.00	£1,900.00	£2,280.00	£1,900.00	£2,280.00	
		<ul style="list-style-type: none"> 6.5" colour touch-screen Voice control 30GB hard drive Four speakers (Transporter window van) Eight speakers (Transporter shuttle) FM/AM radio with RDS Single CD/DVD player Aux-in and SD card reader DAB audio reception 							
Other audio and phone options									
BLUETOOTH CONNECTIVITY		Go hands-free with compatible devices. This system includes a multi-function display.							
			Standard	£230.00	£276.00	£230.00	£276.00	£230.00	£276.00
			Premium*	£370.00	£444.00	£370.00	£444.00	£370.00	£444.00
		* Premium Bluetooth® requires radio upgrade and leather steering wheel with multi-function display and controls for radio and mobile phone							
CD CHANGER		This six-disc player allows you to quickly select and enjoy your favourite tunes.							
		*not compatible with radio upgrade RCD310 with DAB+ or dual passenger seat							
					£280.00	£336.00	£280.00	£336.00	

Options: Body, chassis and windows

Tailor your Transporter for the specific demands of your job with our body and chassis options, including rear and side door packs, towbars and roof rails

	Transporter window van		Transporter shuttle S		Transporter shuttle SE	
	Basic (ex VAT)	Total RRP (inc VAT)	Basic (ex VAT)	Total RRP (inc VAT)	Basic (ex VAT)	Total RRP (inc VAT)
Body-coloured bumpers						
Body-coloured bumpers *	£435.00	£522.00	–	–	£	£
Roof options						
Medium roof * Not compatible with sunroof, alarm with interior monitoring, or roof load rack preparation	White	£440.00	£528.00	–	–	–
	Body-coloured	£535.00	£642.00	–	–	–
High roof – no back windows * Includes high rear doors, wing, without windows. Not compatible with sunroof, alarm with interior monitoring, roof load rack preparation, sliding side door on driver side, or DSG/4MOTION®	White	£865.00	£1,038.00	–	–	–
	Body-coloured	£980.00	£1,176.00	–	–	–
High roof * Includes high rear doors, wing, with heated windows and wash/wipe. Not compatible with sunroof, alarm with interior monitoring, roof load rack preparation, sliding side door on driver side, or DSG/4MOTION®	White	£890.00	£1,068.00	–	–	–
	Body-coloured	£1,005.00	£1,206.00	–	–	–

* Please confirm colour availability of body-coloured options with your Van Centre



Check your roof height

Roof packs are great for adding load height and volume to your window van, but make sure they suit where you work. Height restrictions in city-centre car parks could be as low as 1.8m. Check your van's height in the data section on pages 58-67.

– not available £ standard ○ available as a no-cost option

	Transporter window van		Transporter shuttle S		Transporter window van	
	Basic (ex VAT)	Total RRP (inc VAT)	Basic (ex VAT)	Total RRP (inc VAT)	Basic (ex VAT)	Total RRP (inc VAT)
Side doors						
Sliding side door, driver-side only Not compatible with rear seating for five or six, or sunroof. No passenger-side sliding door	○	○	–	–	–	–
Sliding side doors, both sides Not compatible with high roofs	£440.00	£528.00	–	–	–	–
Power-latching sliding side doors, both sides On window vans: only compatible with air-conditioning front and rear, or air-conditioning with rear heater; not compatible with air-conditioning cab only, alarm, high roof, or tyre pressure warning light	£610.00	£732.00	£170.00	£204.00	£170.00	£204.00
Electric sliding side doors, both sides Only compatible with air-conditioning. Not compatible with tyre pressure warning light	–	–	£650.00	£780.00	£650.00	£780.00
Rear doors						
Rear wing doors, with 250° hinges Only compatible with rear doors or high-roof packs	£265.00	£318.00	–	–	–	–
Rear wing doors, with heated back windows and wash/wipe On shuttles: includes storage nets On window vans: included if you are adding a high roof (with back windows)	£160.00	£192.00	£190.00	£228.00	£260.00	£312.00
Rear wing doors, no back windows On window vans: included if you are adding a high roof – no back windows	£50.00	£60.00	–	–	–	–
Tailgate without window Not compatible with high roofs	–£75.00	–£90.00	–	–	–	–
Tailgate with power latching Not compatible with high roofs	–	–	£120.00	£144.00	£120.00	£144.00



Fit an extra side door

The Transporter window van comes as standard with a sliding door on the passenger side. Fitting a side door on the driver side gives you safe access however you park. The Transporter shuttle comes with sliding doors on both sides.



Choose rear doors

Transporter window van and shuttle models come as standard with a tailgate that has a heated rear window with wash/wipe. You can change to the options shown left.

Options: Body, chassis and windows (cont.)

	Transporter window van		Transporter shuttle S		Transporter shuttle SE	
	Basic (ex VAT)	Total RRP (inc VAT)	Basic (ex VAT)	Total RRP (inc VAT)	Basic (ex VAT)	Total RRP (inc VAT)
Windows						
Rear privacy glass	£215.00	£258.00	£215.00	£258.00	£215.00	£258.00
Sliding windows in sliding doors – both sides	£300.00	£360.00	–	–	–	–
Sliding window in sliding doors – one side	–	–	£150.00	£180.00	£150.00	£180.00
Laminated glass <small>For improved noise dampening. Includes privacy glass, laminated windscreen, auto-dimming rear-view mirror and rain sensor. Not compatible with privacy glass or auto-dimming rear-view mirror.</small>	–	–	–	–	£405.00	£486.00
Towing						
Preparation with socket	£160.00	£192.00	£160.00	£192.00	£160.00	£192.00
Fixed ball with 13-pin socket <small>An adapter is available from Van Centres to allow connection to twin 7-pin sockets</small>	£375.00	£450.00	£375.00	£450.00	£375.00	£450.00
Removable ball with 13-pin socket <small>An adapter is available from Van Centres to allow connection to twin 7-pin sockets</small>	£470.00	£564.00	£470.00	£564.00	£470.00	£564.00



Useful towing tips

1. Watch your weight

Make sure your trailer doesn't exceed your vehicle's maximum towing limit or its gross train weight. You'll find these in your handbook.

2. Load well, stay stable

Put heavy items low down over the trailer axle. Ensure the trailer has a slightly nose-down attitude, but that it doesn't exceed the vehicle or trailer's nose weight limit.

3. Check your tyres

Your tyres may need to be inflated to a greater pressure to cope with the extra load. Check your vehicle's handbook.

– not available S standard O available as a no-cost option

	Transporter window van		Transporter shuttle S		Transporter shuttle SE	
	Basic (ex VAT)	Total RRP (inc VAT)	Basic (ex VAT)	Total RRP (inc VAT)	Basic (ex VAT)	Total RRP (inc VAT)
Other body and chassis options						
Differential lock <small>Only compatible with 4MOTION®</small>	£460.00	£552.00	–	–	£460.00	£552.00
Mud flaps <small>Front and rear</small>	£95.00	£114.00	£95.00	£114.00	£95.00	£114.00
Roof load rack preparation <small>Not compatible with medium or high roofs</small>	£75.00	£90.00	£75.00	£90.00	£75.00	£90.00

Add Ons
Accessories to help keep your vehicle 100% Volkswagen

If you want even more choice for body and chassis upgrades, including lots of towing and roof-rack solutions, check out our Add Ons accessories range. Ask your Van Centre for a brochure, call 0800 717131 or download a copy at www.volkswagen-vans.co.uk

Options: Comfort and convenience

From cruise control to a multi-function steering wheel, there's a range of features to make driving more comfortable

	Transporter window van		Transporter shuttle S		Transporter shuttle SE	
	Basic (ex VAT)	Total RRP (inc VAT)	Basic (ex VAT)	Total RRP (inc VAT)	Basic (ex VAT)	Total RRP (inc VAT)
Cruise control Included as standard on BlueMotion Technology models	£175.00	£210.00	£175.00	£210.00	£175.00	£210.00
Cab comfort pack Additional storage, sunglasses holder, reading lights, instrument dimmer, vanity mirrors and A-pillar grab handles	£190.00	£228.00	-	-	-	-
Smoking pack Ashtray, cigarette lighter and cup holder	£15.00	£18.00	-	-	-	-
Electric glass sunroof Window vans: not compatible with roof ventilation/extraction, medium or high roofs, or sliding door driver-side only. Shuttle: not compatible with Climatronic air-conditioning	£485.00	£582.00	£485.00	£582.00	£485.00	£582.00
Headlight washer system Fluid-level indicator and heated washer jets	£175.00	£210.00	£175.00	£210.00	£175.00	£210.00
Rain sensor and automatic dimming rear-view mirror Includes 'leaving/coming home' function	£190.00	£228.00	£190.00	£228.00	£190.00	£228.00
Xenon headlights With LED daytime running lights, including headlamp washer system with heated washer jets	£1,050.00	£1,260.00	£1,050.00	£1,260.00	£1,000.00	£1,200.00
Leather steering wheel, gear knob and gaiter	£125.00	£150.00	£125.00	£150.00	£125.00	£150.00
Multi-function leather steering wheel, with leather gear knob and gaiter Includes multi-function display and controls for radio and mobile phone	£290.00	£348.00	£290.00	£348.00	£290.00	£348.00
Servotronic Speed-dependent, power-assisted steering	£350.00	£420.00	£350.00	£420.00	£350.00	£420.00



Choose cruise control

Cruise control can help reduce the fatigue and stress of sticking to speed limits on long journeys. It also helps reduce the amount of fuel you use by cutting out the acceleration and braking used to keep up with road speed.

Options: Heating and ventilation

Keep control of the temperature in your vehicle with our heating and air-conditioning options

	Transporter window van		Transporter shuttle S		Transporter shuttle SE	
	Basic (ex VAT)	Total RRP (inc VAT)	Basic (ex VAT)	Total RRP (inc VAT)	Basic (ex VAT)	Total RRP (inc VAT)
Air conditioning						
Climatic – cab only Not compatible with rear heater or rear seating	£785.00	£942.00	-	-	-	-
Climatic – front only Window van – includes rear heater. Shuttle – includes rear roof vents	£1,205.00	£1,446.00	£915.00	£1,098.00	S	S
Climatic – front and rear with rear roof vents Window van: includes rear heater. Not with uprated alternator, roof ventilation/extraction, sunroof or medium/high roofs	£1,465.00	£1,758.00	-	-	£310.00	£372.00
3-zone Climatronic – front and rear	-	-	£1,150.00	£1,380.00	£725.00	£870.00
Heating						
Rear heater Not with Climatic – cab only	£430.00	£516.00	-	-	-	-
Parking heater Includes second battery	£1,770.00 £1,975.00	£2,124.00 £2,370.00	£1,430.00 £1,665.00	£1,716.00 £1,998.00	£1,430.00 £1,665.00	£1,716.00 £1,998.00
Other						
Charcoal canister For ventilation system	£15.00	£18.00	£15.00	£18.00	£15.00	£18.00
Roof ventilation/extraction Not compatible with interior monitoring alarm, sunroof, or tyre pressure warning light	£295.00	£354.00	-	-	-	-



Get an air-con recharge

You may be able to get your air-conditioning system recharged and pollen filter replaced at your nearest Van Centre to keep them working as they should. Ask your Van Centre for details.

Options: Seating, trim and upholstery

	Transporter window van		Transporter shuttle S		Transporter shuttle SE	
	Basic (ex VAT)	Total RRP (inc VAT)	Basic (ex VAT)	Total RRP (inc VAT)	Basic (ex VAT)	Total RRP (inc VAT)
Driver and front passenger seats						
Heated driver and front passenger seats Window van and shuttle S models: only compatible with air-conditioning	£225.00	£270.00	£225.00	£270.00	£225.00	£270.00
Swivelling driver and single front passenger seats Not compatible with side and curtain airbags	£315.00	£378.00	£250.00	£300.00	£250.00	£300.00
Dual front passenger seat Not compatible with side and front curtain airbags, heated or swivelling seats, or shuttle SE long wheelbase 4MOTION® models.	£180.00	£216.00	£75.00	£90.00	£75.00	£90.00
Dual front passenger seat with fold-down tray in the backrest Not compatible with side and front curtain airbag, heated or swivelling seats, or shuttle SE long wheelbase 4MOTION® models.	£260.00	£312.00	£235.00	£282.00	£235.00	£282.00
Armrest for driver seat Not compatible with swivelling seats	£55.00	£66.00	–	–	–	–
Armrests and lumbar support for driver and single front passenger seats Not compatible with swivelling seats	£170.00	£204.00	S	S	S	S
Electric four-way lumbar support Driver and single front passenger seats Not compatible with swivelling seats	£210.00	£252.00	£210.00	£252.00	£210.00	£252.00
Electric four-way lumbar support Driver's seat Only compatible with dual passenger seat	£120.00	£144.00	–	–	–	–

	Transporter window van		Transporter shuttle S		Transporter shuttle SE	
	Basic (ex VAT)	Total RRP (inc VAT)	Basic (ex VAT)	Total RRP (inc VAT)	Basic (ex VAT)	Total RRP (inc VAT)
Rear passenger seating						
First row: dual seat driver side, with armrest † Not compatible with sliding side door driver-side only	£310.00	£372.00	–	–	–	–
First row: single seat passenger side, dual seat driver side † Not compatible with sliding side door driver-side only	£535.00	£642.00	–	–	–	–
First row: three-seat bench, folding and tipping	£510.00	£612.00	–	–	–	–
Rear seating for 5 – 2:3 layout Not with sliding side door driver-side only. Requires heating for rear passengers	£780.00	£936.00	–	–	–	–
Rear seating for 6 – 3:3 layout Dual seat driver side, single seat passenger side † Not with sliding side door driver-side only. Requires heating for rear passengers. Not available on 4MOTION® models	£1,005.00	£1,206.00	–	–	–	–
Rear seating for 6 – 3:3 layout Dual seat passenger side, single seat driver side † Not with sliding side door driver-side only. Requires heating for rear passengers. Not available on 4MOTION® models	£940.00	£1,128.00	–	–	–	–

† On first row in the back, dual seat has ISOFIX child seat mountings

Options: Seating, trim and upholstery (cont.)

	Transporter window van		Transporter shuttle S		Transporter shuttle SE	
	Basic (ex VAT)	Total RRP (inc VAT)	Basic (ex VAT)	Total RRP (inc VAT)	Basic (ex VAT)	Total RRP (inc VAT)
Upholstery						
Place cloth						
Timo cloth						
Leatherette						
Tasamo cloth						
Robust cloth						
Floor coverings						
Carpet floor covering in cab						
Rubber floor covering in cab and passenger compartment In lieu of carpet floor covering						



Pick the right upholstery

Fabric upholstery is terrifically hard-wearing, while leatherette upholstery is great for cleaning quickly and easily.

Options: Safety and security

Parking sensors, airbag packs and sophisticated alarms that enhance the safety of you, your vehicle and its contents

	Transporter window van		Transporter shuttle S		Transporter shuttle SE	
	Basic (ex VAT)	Total RRP (inc VAT)	Basic (ex VAT)	Total RRP (inc VAT)	Basic (ex VAT)	Total RRP (inc VAT)
Airbags						
Side and front curtain airbags Only compatible with single front passenger seat						
Side, front and rear curtain airbags Not compatible with dual front passenger seat						
Alarms						
Perimeter alarm with back-up horn Includes second remote key						
Interior alarm (cab only) and tow-away protection Includes second remote key. Not with alternator/battery updated, medium or high roofs, or roof ventilation/extraction						
Lights						
Front fog lights with cornering function						



Useful security tips

- 1. Get an alarm**
Alarm noise may be enough to scare a thief and prevent a costly break-in.
- 2. Lock your doors**
Even if you're away from your van only for a minute, locked doors deter thieves looking for an easy target.
- 3. Keep it tidy**
Seemingly trivial items can still be bait to thieves. Stow gadgets out of sight or take them with you. Thieves know to look in the glove box, too.
- 4. Park for visibility**
Use well-lit areas. Avoid parking near vehicles or foliage that a thief could use for cover. Parking right up against walls can stop a thief getting in through your vehicle's doors.

Options: Safety and security (cont.)

Parking sensors, airbag packs and sophisticated alarms that enhance the safety of you, your vehicle and its contents

	Transporter window van		Transporter shuttle S		Transporter shuttle SE	
	Basic (ex VAT)	Total RRP (inc VAT)	Basic (ex VAT)	Total RRP (inc VAT)	Basic (ex VAT)	Total RRP (inc VAT)
Lane-change assist						
Lane-change assist Includes rain sensor with auto-dimming rear view, cruise control and trip computer. Short wheelbase only. Not with rear wing doors. Only in combination with electrically folding mirrors	£700.00	£840.00	£700.00	£840.00	£650.00	£780.00
Parking aids						
Parking sensors – rear	£195.00	£234.00	£195.00	£234.00	–	–
Parking sensors – front and rear	£350.00	£420.00	–	–	£350.00	£420.00
Reversing camera Requires optional factory-fit satellite navigation	–	–	£505.00	£606.00	£505.00	£606.00
Reversing camera with rear parking sensors Requires optional factory-fit satellite navigation	–	–	£710.00	£852.00	£710.00	£852.00
Reversing camera with front and rear parking sensors Requires optional factory-fit satellite navigation	–	–	£870.00	£1,044.00	£870.00	£1,044.00
Tyre pressure warning light						
Tyre pressure warning light Window van: not compatible with roof ventilation/extraction or power latching for sliding doors Shuttle: not compatible with electric sliding doors	£50.00	£60.00	£50.00	£60.00	£50.00	£60.00

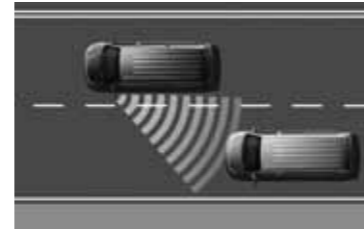

Lane change assist

Lane change assist makes motorway driving safer by helping to prevent accidents when you want to change lanes. The system monitors your blind spots and warns you of a potentially hazardous situation by flashing warning lights in the exterior mirrors.

Options: Electrical

Choose these electrical features to give your Transporter a functional and practical edge

	Transporter window van		Transporter shuttle S		Transporter shuttle SE		
	Basic (ex VAT)	Total RRP (inc VAT)	Basic (ex VAT)	Total RRP (inc VAT)	Basic (ex VAT)	Total RRP (inc VAT)	
Alternators and batteries							
Up-rated battery 450A/95Ah battery	£35.00	£42.00	–	–	–	–	
Up-rated alternator 180A alternator – not compatible with air conditioning	£65.00	£78.00	–	–	–	–	
Up-rated alternator and battery 450A/95Ah battery, 180A alternator	£100.00	£120.00	–	–	–	–	
Second battery Included with parking heaters	£185.00	£222.00	£185.00	£222.00	£185.00	£222.00	
Additional 12V socket on dash panel	£30.00	£36.00	–	–	–	–	
Electric door mirrors							
Electrically heated, adjustable and folding door mirrors	Black	£105.00	£126.00	£115.00	£138.00	–	–
	Body-coloured	£215.00	£258.00	–	–	£90.00	£108.00
Other electrical options							
Digital tachograph Includes console on dash	£455.00	£546.00	£455.00	£546.00	£455.00	£546.00	
Trip computer Included with satellite navigation and steering wheel with controls for radio and mobile phone	£230.00	£276.00	£230.00	£276.00	S	S	

Want more? Pick an Add On...

The Transporter comes with a wide range of factory-fit options, but you may want something extra. That's where Add Ons come in

Add Ons is the new name for our extensive range of Volkswagen-approved accessories, available to buy and be fitted at your Van Centre.

Whether you want to add extra style to your vehicle, get more out of your load space, convert a work vehicle for weekend leisure or add extra audio, phone and sat-nav to your cab, we've got lots of Add Ons for you.

Help keep it 100% Volkswagen

There are big advantages to buying your accessories from Volkswagen. Add Ons have all been designed with Volkswagen in mind, so they're a perfect match for fit and style, and they've been designed and developed to be just as rugged, reliable and long-lasting as your vehicle.

Keep your Add Ons covered

Most Add Ons include a two-year warranty. However, if you order and fit them when you buy a new vehicle, we may be able to extend to three years to match your vehicle's warranty. Pop into your Van Centre and ask our staff about how much Add Ons can add to your life.



  To get a brochure, pop into a Van Centre. To find your nearest one, call 0800 717131 or visit www.volkswagen-vans.co.uk



Top five Transporter Add Ons



1 Monster mats
The deep channels in these heavy-duty mats stop liquids and dirt spilling onto the cab floor.



2 Roof-bar set
Adding roof bars can boost your load capacity by 100kg. You can use them with our roof bar accessories.



3 Waterproof seat covers
Protects your driver and front passenger seats from wet and dirt. Not for vehicles with side airbags.



4 Bluetooth® Music Touch Phone kit
Control your phone by touch-screen or by voice, and have your texts and emails read to you. It plays music from your phone, too.



5 Reversing aid kit
The four sensors can be painted to match your vehicle's body colour.

Add Ons
Accessories to help keep your vehicle 100% Volkswagen

Data

All the facts and figures you'll need for your vehicle

Engines: Transporter (all models)

	2.0TDI 84PS	2.0TDI 102PS	2.0TDI 114PS	2.0TDI 140PS	2.0TDI 180PS
ENGINE SPECIFICATIONS					
Engine type	Diesel, transverse, water-cooled, in-line, variable turbine geometry turbocharger with intercooler			Diesel, transverse, water-cooled, in-line, bi-turbo with intercooler	
Mixture preparation/injection	Common-rail, direct-injection				
EU exhaust emission standard	EURO 5				
Number of cylinders	4				
Cubic capacity	1,968cc				
Output, PS at rpm	84 at 3,500	102 at 3,500	114 at 3,500	140 at 3,500	180 at 4,000
Torque, max. Nm at rpm	220 at 1,250-2,500	250 at 1,500-2,500	250 at 1,500-2,750	340 at 1,750-2,500	400 at 1,500-2,000
Diesel Particulate Filter (DPF)	●	●	●	●	●
5-speed manual gearbox	●	●	●	-	-
6-speed manual gearbox	-	-	-	●	●
7-speed auto DSG	-	-	-	●	●
Front-wheel drive	●	●	●	●	●

ELECTRICS	
Alternator (all variants)	110A

- Available
- Not available

Output (PS)
Torque (Nm)

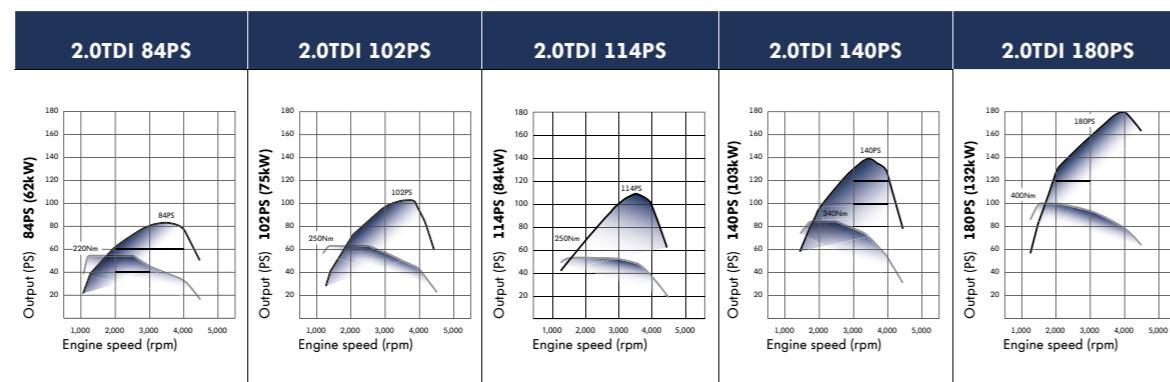

Standard features: Transporter shuttle

Transporter shuttle S		Transporter shuttle SE	
EXTERIOR		INTERIOR	
80-litre lockable fuel tank		12V socket	
Black wheel centre caps		Sun visors with vanity mirrors	
Door mirrors, electrically heated and adjustable		Digital clock	
Galvanised full steel body		Driver and front passenger seats with height, lumbar, reach and rake adjustment and armrests	
Grey bumpers		Electric front windows	
Heat reflective glass		Interior light	
Steel wheels: 16" x 6.5J (84PS, 102PS, 114PS and 140PS models) 17" x 7J (180PS models)		Manually controlled heating system with dust and pollen filter and air recirculation	
Tyres: 205/65 R16 (84PS, 102PS and 140PS models); 215/65 R16 with low rolling resistance (BlueMotion Technology models); 235/55 R17 (180PS models)		RCD 210 radio/single CD player with 4 speakers	
Full-size steel spare wheel with tool kit and jack		Rev counter	
Tailgate with heated rear window and wash/wipe system		Lockable glove compartment	
		Storage net on lower dash passenger side	
		Gearshift indicator	
		Rubber floor covering	
		'Tasamo' cloth upholstery	
		Dimmable dashboard illumination	
		Sunblinds for side windows in passenger compartment	
		2-seat bench (right) with 2x ISOFIX mountings and separate seat (left) in 2nd row	
		3-seat bench in 3rd row, folding and tipping	
		Grab handle on A-pillar for driver and front passenger	
		Reading lights in headlining for rear passenger compartment	
		Load lashing rings (6 x short wheelbase, 8 x long wheelbase)	
SAFETY AND SECURITY			
Driver and front passenger (with deactivation) airbags			
Electronic Stability Programme (ESP) incorporating Anti-lock Braking System (ABS), Brake Assist System (BAS), Electronic Brake-pressure Distribution (EBD), Electronic Differential Lock (EDL) and Hill Hold Assist			
Height-adjustable head restraints			
Reach and height-adjustable steering column			
Remote central locking with internal locking switch and two remote folding keys			
Thatcham Category 1 alarm and immobiliser with tow-away, perimeter and interior protection			
In addition to Transporter shuttle S:			
Body-coloured bumpers, door mirrors and handles			
Carpet floor covering			
Chrome detailing in upper grille			
Wheel trims			
'Climatic' semi-automatic air-conditioning system			
Storage pockets on front seat backrests			
Timo cloth upholstery			
Premium dashboard (includes Platinum Grey centre console surround, rubber storage compartment trays and air vent controls)			
Trip computer with multi-function display			
Washer fluid level indicator			
2-tone horn			
Deluxe headlining, incorporating ventilation strips and adjustable reading lights			
Tyres 215/60 R17 all-weather (T32 180 models)			
BlueMotion Technology models			
In addition to Transporter shuttle S and SE:			
Low rolling resistance tyres			
Stop/start system			
Cruise control			
Brake energy recuperation			
BlueMotion Technology exterior badge			

Dimensions and weights: Transporter shuttle

Short wheelbase

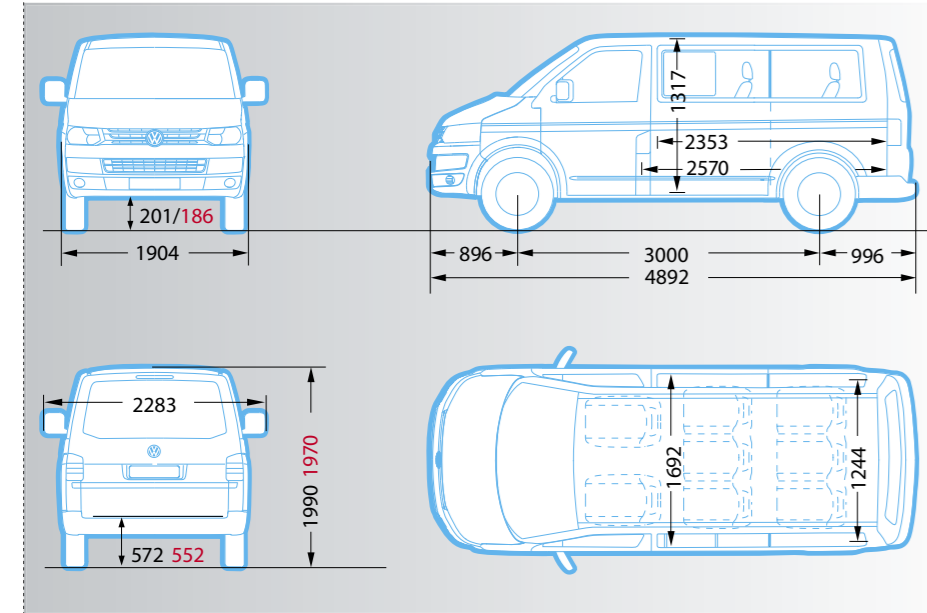

Dimensions		
Wheelbase	3,000	
Load compartment		
Width	1,020	
Length	2,570	
Height	1,268	
Tailgate		
Width	1,486	
Height	1,295	
Area	4.3m ²	
Volume	5.8m ³	
Turning circle (wall to wall)	11.9m	

Long wheelbase

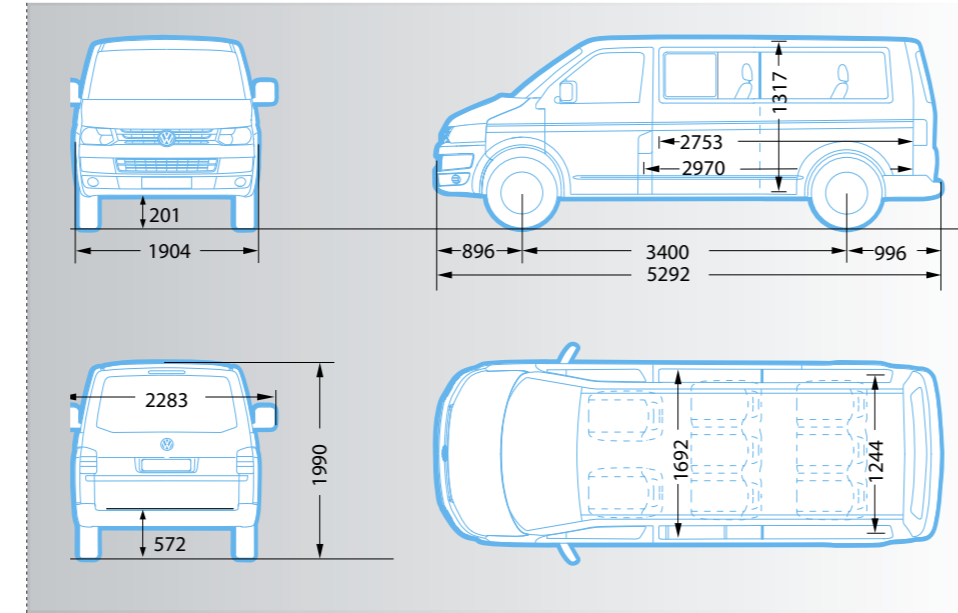

Dimensions		
Wheelbase	3,400	
Load compartment		
Width	1,020	
Length	2,970	
Height	1,268	
Tailgate		
Width	1,486	
Height	1,295	
Area	5.0m ²	
Volume	6.7m ³	
Turning circle (wall to wall)	13.2m	

All dimensions in mm unless otherwise specified
The height measurements listed here may vary by ± 50mm depending on equipment fitted. Please note vehicle drawings are not to scale

Short wheelbase

Model / gross vehicle weight (kg)	Engine/transmission	Axle load limit front/rear (kg)	Trailer weight braked 12%/unbraked (kg)	Gross train weight (kg)	Transporter shuttle S		Transporter shuttle SE	
					Unladen weight † (kg)	Payload † (kg)	Unladen weight † (kg)	Payload † (kg)
T30	3,000 2.0TDI 84PS	1,500 / 1,575	2,200 / 750	4,800	2,080	920	-	-
	3,000 2.0TDI 84PS BlueMotion Technology	1,500 / 1,575	2,200 / 750	4,800	2,089	911	-	-
	3,000 2.0TDI 102PS	1,500 / 1,575	2,200 / 750	4,900	2,080	920	2,075	925
	3,000 2.0TDI 114PS BlueMotion Technology	1,500 / 1,575	2,200 / 750	4,900	2,089	911	2,084	916
	3,000 2.0TDI 140PS	1,550 / 1,575	2,500 / 750	5,200	2,116	884	2,111	889
	3,000 2.0TDI 140PS DSG	1,550 / 1,575	2,500 / 750	5,300	2,132	868	2,127	873
	3,000 2.0TDI 140PS 4MOTION®	1,550 / 1,575	2,500 / 750	5,200	-	-	2,231	769
	3,000 2.0BiTDI 180PS	1,550 / 1,575	2,500 / 750	5,200	-	-	2,161	839
	3,000 2.0BiTDI 180PS DSG	1,550 / 1,575	2,500 / 750	5,200	-	-	2,173	827
	3,000 2.0BiTDI 180PS 4MOTION®	1,550 / 1,575	2,500 / 750	5,200	-	-	2,282	718
	3,000 2.0BiTDI 180PS DSG 4MOTION®	1,550 / 1,575	2,500 / 750	5,200	-	-	2,295	705

Long wheelbase

Model / gross vehicle weight (kg)	Engine/transmission	Axle load limit front/rear (kg)	Trailer weight braked 12%/unbraked (kg)	Gross train weight (kg)	Transporter shuttle S		Transporter shuttle SE		
					Unladen weight † (kg)	Payload † (kg)	Unladen weight † (kg)	Payload † (kg)	
T30	3,000 2.0TDI 84PS	1,525 / 1,600	2,200 / 750	4,800	2,145	855	-	-	
	3,000 2.0TDI 84PS BlueMotion Technology	1,525 / 1,600	2,200 / 750	4,800	2,154	846	-	-	
	3,000 2.0TDI 102PS	1,525 / 1,600	2,200 / 750	4,900	2,145	855	2,172	828	
	3,000 2.0TDI 114PS BlueMotion Technology	1,525 / 1,600	2,200 / 750	4,900	2,154	846	2,181	819	
	3,000 2.0TDI 140PS	1,575 / 1,600	2,500 / 750	5,200	2,182	818	2,208	792	
	3,000 2.0TDI 140PS DSG	1,575 / 1,600	2,500 / 750	5,300	2,197	803	2,224	776	
	3,000 2.0TDI 140PS 4MOTION®	1,575 / 1,600	2,500 / 750	5,200	-	-	2,328	672	
	3,000 2.0BiTDI 180PS	1,575 / 1,600	2,500 / 750	5,200	-	-	2,258	742	
	3,000 2.0BiTDI 180PS 4MOTION®	1,550 / 1,575	2,500 / 750	5,200	-	-	2,403	597	
	T32	3,200 2.0BiTDI 180PS DSG	1,675 / 1,680	2,500 / 750	5,300	-	-	2,270	930
		3,200 2.0BiTDI 180PS DSG 4MOTION®	1,700 / 1,720	2,500 / 750	5,300	-	-	2,416	784

Economy and performance: Transporter shuttle

Engine/transmission	Urban mpg (l/100km) ¹	Extra-urban mpg (l/100km) ¹	Combined mpg (l/100km) ²	Acceleration 0-62 mph (seconds)	Top speed mph (where law permits)	CO ₂ emissions (g/km)
TRANSPORTER SHUTTLE S						
2.0TDI 84PS	29.7 (9.5)	46.3 (6.1)	38.7 (7.3)	22.2	91	193
2.0TDI 84PS BlueMotion Technology	33.6 (8.4)	47.9 (5.9)	41.5 (6.8)	22.2	91	179
2.0TDI 102PS	29.7 (9.5)	46.3 (6.1)	38.7 (7.3)	17.9	98	193
2.0TDI 114PS BlueMotion Technology	33.6 (8.4)	47.9 (5.9)	41.5 (6.8)	16.9	101	179
2.0TDI 140PS	29.4 (9.6)	44.8 (6.3)	37.7 (7.5)	14.2	107	198
2.0TDI 140PS DSG	27.7 (10.2)	42.2 (6.7)	35.3 (8.0)	14.7	107	211
TRANSPORTER SHUTTLE SE						
2.0TDI 102PS	29.7 (9.5)	46.3 (6.1)	38.7 (7.3)	17.9	98	193
2.0TDI 114PS BlueMotion Technology	33.6 (8.4)	47.9 (5.9)	41.5 (6.8)	16.9	101	179
2.0TDI 140PS	29.4 (9.6)	44.8 (6.3)	37.7 (7.5)	14.2	107	198
2.0TDI 140PS DSG	27.7 (10.2)	42.2 (6.7)	35.3 (8.0)	14.7	107	211
2.0TDI 140PS 4MOTION®	27.2 (10.4)	39.8 (7.1)	34.0 (8.3)	15.3	106	219
2.0BiTDI 180PS	28.8 (9.8)	42.2 (6.7)	36.2 (7.8)	11.4	119	205
2.0BiTDI 180PS DSG	27.7 (10.2)	40.9 (6.9)	34.9 (8.1)	11.3	119	214
2.0BiTDI 180PS 4MOTION®	26.9 (10.5)	39.2 (7.2)	33.6 (8.4)	11.8	117	221
2.0BiTDI 180PS DSG 4MOTION®	25.4 (11.1)	37.7 (7.5)	32.1 (8.8)	12.1	117	232

Standard features: Transporter window van

Transporter window van

EXTERIOR

80-litre lockable fuel tank
Black wheel centre caps
Door mirrors, electrically heated and adjustable
Galvanised full steel body
Grey bumpers
Heat reflective glass
Steel wheels: 16" x 6.5J (84PS, 102PS, 114PS and 140PS models) 17" x 7J (180PS models)
Tyres: 205/65 R16 (84PS, 102PS, 114PS and 140PS models) 235/55 R17 (180PS models) 215/60 R17 all-weather (T32 180PS models)
Full-size spare wheel with tool kit and jack
Tailgate with heated rear window and wash/wipe system

INTERIOR

Cab area:
12V socket
Digital clock
Driver's seat with height, lumbar, reach and rake adjustment
Electric front windows
Interior light
Manually controlled heating system with dust and pollen filter and air recirculation
'Place' cloth upholstery
RCD 210 radio/single CD player with 2 speakers
Rev counter
Rubber floor covering
Single passenger seat with reach and rake adjustment
Gearshift indicator
Lockable glove compartment
Storage net on lower dash passenger side
Rear:
2 door-activated interior lights
Childlocks (not on optional unglazed rear doors)
Fixed side windows
Interior entry step
Rear-door interior release lever
Rubber floor covering
Side sliding door on left

SAFETY AND SECURITY

Driver and front passenger (with deactivation) airbags
Thatcham Category 2 immobiliser
Height-adjustable head restraints
Height- and rake-adjustable steering column
Remote central locking with internal locking switch with one fixed and two folding remote keys
Electronic Stability Programme (ESP) incorporating Anti-lock Braking System (ABS), Brake Assist System (BAS), Electronic Brake-pressure Distribution (EBD), Electronic Differential Lock (EDL) and Hill Hold Assist

BlueMotion Technology models

In addition to standard window van:

Low-rolling-resistance tyres
Stop/start system
Cruise control
Brake energy recuperation
BlueMotion Technology exterior badge

Dimensions and weights: Transporter window van

Short wheelbase

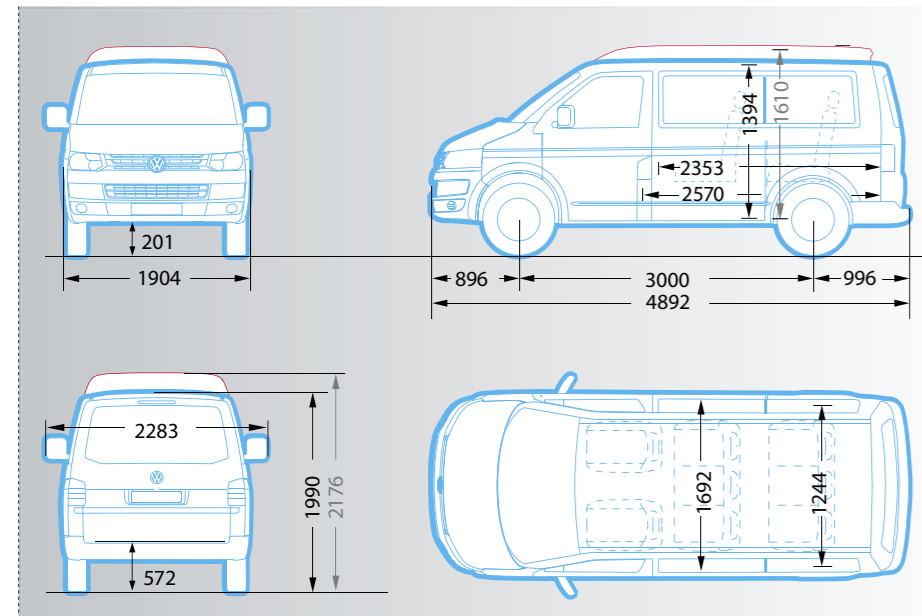

Dimensions	Low roof	Med roof		Low roof	Med roof
Wheelbase	3,000	3,000	Tailgate		
Passenger compartment			Width	1,486	1,486
Length	2,570	2,570	Height	1,295	1,295
Width	1,692	1,692	Load space (seat-back to doors)		
Height	1,394	1,610	1st rear row	1,339	1,339
Area	4.3m ²	4.3m ²	2nd rear row	505	505
Volume	5.8m ³	6.7m ³	Turning circle (wall to wall)	11.9m	11.9m
Width (between wheel housings)	1,244	1,244			
Side sliding door					
Width	1,020	1,020			
Height	1,268	1,268			

Long wheel base

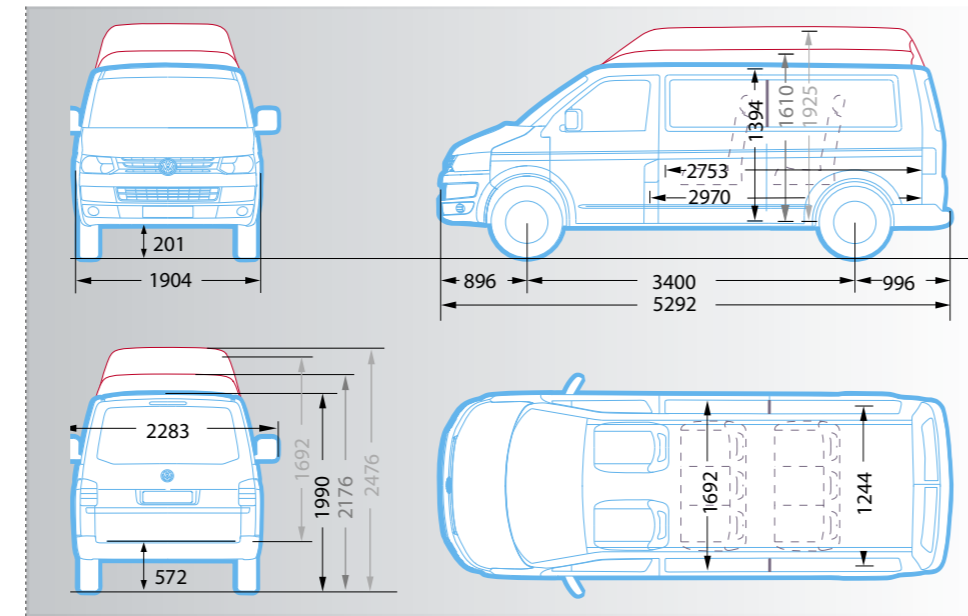

Dimensions	Low roof	Med roof	High roof	Low roof	Med roof	High roof
Wheelbase	3,400	3,400	3,400	Tailgate		
Passenger compartment				Width	1,486	1,486
Length	2,970	2,970	2,970	Height	1,295	1,295
Width	1,692	1,692	1,692	Rear doors		
Height	1,394	1,610	1,925	Width	-	-
Area	5.0m ²	5.0m ²	5.0m ²	Height	-	1,692
Volume	6.7m ³	7.8m ³	9.3m ³	Load space		
Width (between wheel housings)	1,244	1,244	1,244	1st rear row	1,739	1,739
Side sliding door				2nd rear row	905	905
Width	1,020	1,020	1,020	Turning circle	13.2m	13.2m
Height	1,268	1,268	1,268			

All dimensions in mm unless otherwise specified
The height measurements listed here may vary by ± 50mm depending on equipment fitted. Please note vehicle drawings are not to scale

Short wheelbase

Model / gross vehicle weight (kg)	Engine/transmission	Axle load limit front/rear (kg)	Trailer weight braked 12%/unbraked (kg)	Gross train weight (kg)	Unladen weight † (kg)	Payload † (kg)
T30	3,000 2.0TDI 84PS	1,500 / 1,600	2,200 / 750	4,800	1,976	1,024
	3,000 2.0TDI 84PS BlueMotion Technology	1,500 / 1,600	2,200 / 750	4,800	1,976	1,024
	3,000 2.0TDI 102PS	1,500 / 1,600	2,200 / 750	4,900	1,976	1,024
	3,000 2.0TDI 114PS BlueMotion Technology	1,500 / 1,600	2,200 / 750	4,900	1,976	1,024
	3,000 2.0TDI 140PS	1,550 / 1,600	2,500 / 750	5,200	1,976	1,024
	3,000 2.0TDI 140PS DSG	1,550 / 1,600	2,500 / 750	5,300	1,976	1,024
	3,000 2.0TDI 140PS 4MOTION®	1,600 / 1,600	2,500 / 750	5,300	2,031	969
	3,000 2.0BiTDI 180PS	1,550 / 1,600	2,500 / 750	5,200	1,976	1,024
	3,000 2.0BiTDI 180PS DSG	1,550 / 1,600	2,500 / 750	5,300	1,976	1,024
	3,000 2.0BiTDI 180PS 4MOTION®	1,600 / 1,600	2,500 / 750	5,300	2,065	935
	3,000 2.0BiTDI 180PS DSG 4MOTION®	1,600 / 1,600	2,500 / 750	5,300	2,084	916
	T32	3,200 2.0TDI 102PS	1,600 / 1,680	2,200 / 750	4,900	1,976
3,200 2.0TDI 114PS BlueMotion Technology		1,600 / 1,680	2,200 / 750	4,900	1,976	1,224
3,200 2.0TDI 140PS		1,650 / 1,680	2,500 / 750	5,200	1,976	1,224
3,200 2.0TDI 140PS DSG		1,650 / 1,680	2,500 / 750	5,300	1,976	1,224
3,200 2.0TDI 140PS 4MOTION®		1,700 / 1,720	2,500 / 750	5,300	2,043	1,157
3,200 2.0BiTDI 180PS		1,650 / 1,680	2,500 / 750	5,200	1,982	1,218
3,200 2.0BiTDI 180PS DSG		1,650 / 1,680	2,500 / 750	5,300	2,000	1,200
3,200 2.0BiTDI 180PS 4MOTION®		1,700 / 1,720	2,500 / 750	5,300	2,103	1,097
3,200 2.0BiTDI 180PS DSG 4MOTION®		1,700 / 1,720	2,500 / 750	5,300	2,122	1,078

Dimensions and weights: Transporter window van (cont.)

Long wheelbase

Model / gross vehicle weight (kg)	Engine/transmission	Axle load limit front/rear (kg)	Trailer weight braked 12%/unbraked (kg)	Gross train weight (kg)	Unladen weight † (kg)	Payload † (kg)
T30	3,000 2.0TDI 84PS	1,525 / 1,600	2,200 / 750	4,800	1,976	1,024
	3,000 2.0TDI 84PS BlueMotion Technology	1,525 / 1,600	2,200 / 750	4,800	1,976	1,024
	3,000 2.0TDI 102PS	1,625 / 1,600	2,200 / 750	4,900	1,976	1,024
	3,000 2.0TDI 114PS BlueMotion Technology	1,525 / 1,600	2,200 / 750	4,900	1,976	1,024
	3,000 2.0TDI 140PS	1,575 / 1,600	2,500 / 750	5,200	1,976	1,024
	3,000 2.0TDI 140PS DSG	1,575 / 1,600	2,500 / 750	5,300	1,992	1,008
	3,000 2.0TDI 140PS 4MOTION®	1,600 / 1,600	2,500 / 750	5,300	2,094	906
	3,000 2.0BiTDI 180PS	1,575 / 1,600	2,500 / 750	5,200	2,008	992
	3,000 2.0BiTDI 180PS DSG	1,575 / 1,600	2,500 / 750	5,300	2,025	975
	3,000 2.0BiTDI 180PS 4MOTION®	1,600 / 1,600	2,500 / 750	5,300	2,129	871
3,000 2.0BiTDI 180PS DSG 4MOTION®	1,600 / 1,600	2,500 / 750	5,300	2,147	853	
T32	3,200 2.0TDI 102PS	1,625 / 1,680	2,200 / 750	4,900	1,976	1,224
	3,200 2.0TDI 114PS BlueMotion Technology	1,625 / 1,680	2,200 / 750	4,900	1,976	1,224
	3,200 2.0TDI 140PS	1,675 / 1,680	2,500 / 750	5,200	1,986	1,214
	3,200 2.0TDI 140PS DSG	1,675 / 1,680	2,500 / 750	5,300	2,004	1,196
	3,200 2.0TDI 140PS 4MOTION®	1,700 / 1,720	2,500 / 750	5,300	2,106	1,094
	3,200 2.0BiTDI 180PS	1,675 / 1,680	2,500 / 750	5,200	2,045	1,155
	3,200 2.0BiTDI 180PS DSG	1,675 / 1,680	2,500 / 750	5,300	2,063	1,137
	3,200 2.0BiTDI 180PS 4MOTION®	1,700 / 1,720	2,500 / 750	5,300	2,166	1,034
	3,200 2.0BiTDI 180PS DSG 4MOTION®	1,700 / 1,720	2,500 / 750	5,300	2,185	1,015

Economy and performance: Transporter window van

Engine/transmission	Urban mpg (l/100km) ¹	Extra-urban mpg (l/100km) ¹	Combined mpg (l/100km) ¹	Acceleration 0-62 mph (seconds)	Top speed mph (where law permits)	CO ₂ emissions (g/km)
T30 AND T32 SHORT- AND LONG-WHEELBASE KOMBI WITH LOW ROOF						
2.0TDI 84PS	29.7 (9.5)	46.3 (6.1)	38.7 (7.3)	21.1	91	193
2.0TDI 84PS BlueMotion Technology	33.6 (8.4)	47.9 (5.9)	41.5 (6.8)	21.1	91	179
2.0TDI 102PS	29.7 (9.5)	46.3 (6.1)	38.7 (7.3)	16.4	98	193
2.0TDI 114PS BlueMotion Technology	33.6 (8.4)	47.9 (5.9)	41.5 (6.8)	15.9	101	179
2.0TDI 140PS	29.4 (9.6)	44.8 (6.3)	37.7 (7.5)	13.1	107	198
2.0TDI 140PS DSG	27.7 (10.2)	42.2 (6.7)	35.3 (8.0)	13.0	107	211
2.0TDI 140PS 4MOTION®	27.7 (10.2)	40.9 (6.9)	34.9 (8.1)	13.6	106	214
2.0BiTDI 180PS	29.4 (9.6)	43.5 (6.5)	37.2 (7.6)	10.3	119	199
2.0BiTDI 180PS DSG	27.7 (10.2)	42.2 (6.7)	35.3 (8.0)	10.2	119	211
2.0BiTDI 180PS 4MOTION®	27.7 (10.2)	40.9 (6.9)	34.9 (8.1)	10.6	117	214
2.0BiTDI 180PS DSG 4MOTION®	25.9 (10.9)	38.7 (7.3)	32.8 (8.6)	10.8	117	226
T30 AND T32 SHORT- AND LONG-WHEELBASE WINDOW VAN WITH MEDIUM ROOF						
2.0TDI 84PS	29.7 (9.5)	46.3 (6.1)	38.7 (7.3)	21.2	88	193
2.0TDI 84PS BlueMotion Technology	33.6 (8.4)	47.9 (5.9)	41.5 (6.8)	21.2	88	179
2.0TDI 102PS	29.7 (9.5)	46.3 (6.1)	38.7 (7.3)	16.5	94	193
2.0TDI 114PS BlueMotion Technology	33.6 (8.4)	47.9 (5.9)	41.5 (6.8)	16.0	98	179
2.0TDI 140PS	29.4 (9.6)	44.8 (6.3)	37.7 (7.5)	13.2	104	198
2.0TDI 140PS DSG	27.7 (10.2)	42.2 (6.7)	35.3 (8.0)	13.1	103	211
2.0TDI 140PS 4MOTION®	27.7 (10.2)	40.9 (6.9)	34.9 (8.1)	13.7	102	214
2.0BiTDI 180PS	29.4 (9.6)	43.5 (6.5)	37.2 (7.6)	10.4	114	199
2.0BiTDI 180PS DSG	27.7 (10.2)	42.2 (6.7)	35.3 (8.0)	10.3	114	211
2.0BiTDI 180PS 4MOTION®	27.7 (10.2)	40.9 (6.9)	34.9 (8.1)	10.7	113	214
2.0BiTDI 180PS DSG 4MOTION®	25.9 (10.9)	38.7 (7.3)	32.8 (8.6)	10.9	113	226
T30 AND T32 LONG-WHEELBASE WINDOW VAN WITH HIGH ROOF						
2.0TDI 84PS	29.4 (9.6)	42.2 (6.7)	36.7 (7.7)	21.7	85	203
2.0TDI 84PS BlueMotion Technology	33.2 (8.5)	43.5 (6.5)	39.2 (7.2)	21.7	85	190
2.0TDI 102PS	29.4 (9.6)	42.2 (6.7)	36.7 (7.7)	16.6	90	203
2.0TDI 114PS BlueMotion Technology	33.2 (8.5)	43.5 (6.5)	39.2 (7.2)	16.1	94	190
2.0TDI 140PS	28.2 (10.0)	42.2 (6.7)	35.8 (7.9)	13.4	100	208
2.0TDI 140PS DSG	27.7 (10.2)	39.2 (7.2)	34.0 (8.3)	13.3	99	219
2.0TDI 140PS 4MOTION®	27.7 (10.2)	38.7 (7.3)	33.6 (8.4)	14.1	98	221
2.0BiTDI 180PS	29.4 (9.6)	40.9 (6.9)	35.8 (7.9)	10.7	109	208
2.0BiTDI 180PS DSG	28.2 (10.0)	39.8 (7.1)	34.4 (8.2)	10.6	109	216
2.0BiTDI 180PS 4MOTION®	27.4 (10.3)	38.2 (7.4)	33.2 (8.5)	11.0	108	224
2.0BiTDI 180PS DSG 4MOTION®	25.9 (10.9)	36.7 (7.7)	31.7 (8.9)	11.2	108	235

Notes

*Scribble any queries
you have here so you
don't forget them*

Vehicle Excise Duty (VED)

Passenger vehicles' Vehicle Excise Duty (VED) is based on the amount of CO₂ the vehicle emits in g/km. The Driver and Vehicle Licensing Agency (DVLA) has created 13 categories as detailed below. From 1 April 2010, a 'First Year Rate' of VED has applied. The chart below shows the VED bands and the charges levied:

VED band	CO ₂ emissions (g/km)	First-year rate (£)	Rate for subsequent years (£)
A	Up to 100	0.00	0.00
B	101-110	0.00	20.00
C	111-120	0.00	30.00
D	121-130	0.00	100.00
E	131-140	120.00	120.00
F	141-150	135.00	135.00
G	151-165	170.00	170.00
H	166-175	275.00	195.00
I	176-185	325.00	215.00
J	186-200	460.00	250.00
K	201-225	600.00	270.00
L	226-255	815.00	460.00
M	Over 255	1030.00	475.00

The small print and the footnotes

Print processes do not allow exact reproduction of the paint and upholstery colours. Some of the vehicles shown are fitted with optional equipment at extra charge.

All data given and specifications are in accordance with information available at the time of going to print and are subject to change without notice. Vehicles not in current UK stock and customer order vehicles may take a number of weeks for delivery. Certain combinations of vehicle specifications and factory-fitted extras are not compatible and therefore all orders received are subject to confirmation. Models, factory-fitted options and paint and upholstery options subject to availability. Please check details and availability with an appropriate authorised Volkswagen Van Centre at the time of ordering.

Volkswagen Commercial Vehicle Finance is a trading name of Volkswagen Financial Services (UK) Limited. Finance subject to status, and available to over 18s only.

Full details of Volkswagen warranties are available from your authorised Volkswagen Van Centre or Van Service Centre.

Volkswagen Commercial Vehicle Insurance is a trading name of Volkswagen Insurance Service (Great Britain) Limited, an appointed representative of Volkswagen Financial Services (UK) Limited, Brunswick Court, Yeomans Drive, Blakelands, Milton Keynes MK14 5LR. Registered in England number 2835230. Volkswagen Commercial Vehicle Insurance is sold, underwritten and administered by Allianz Insurance plc registered in England number 84638. Registered office 57 Ladymead, Guildford, Surrey GU1 1DB. Volkswagen Financial Services (UK) Limited and Allianz Insurance plc are authorised and regulated by the Financial Services Authority. Volkswagen Financial Services (UK) Limited and Allianz Insurance plc are not part of the same corporate group.

Keep track of your costs

The van (see pages 10-21)	Basic price (ex VAT)	Total RRP (inc VAT)
Model (eg: Transporter shuttle SE T32 long-wheelbase 180PS DSG)		
Base model total	£	£

Options (see pages 29-45)		
Factory-fit options (eg: alloy wheels, roof rack, sat-nav etc.)		
Options total	£	£

Add Ons (see page 46-47)		
You can add any item from our Add Ons accessories range when you buy your vehicle. Pick up an Accessories brochure to see the full selection		
Add Ons total	£	£

Grand total	£	£
--------------------	---	---

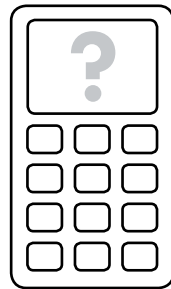

Work out how much it costs

Turn over to keep track of the prices of the vehicle and options you're choosing. Then take this page into your Van Centre.

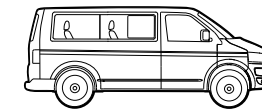
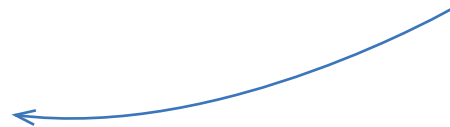

Get in touch with the experts

To find your nearest Van Centre call

0800 717131

or visit www.volkswagen-vans.co.uk

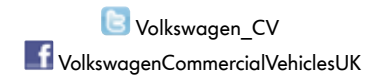

Issue: January 2013

Printed in the UK, 2 January 2013. CVW712TPCARR

This brochure supersedes all previous publications