



Transporter vans

✓ **Panel vans**
Great for tools and cargo

✓ **Kombis**
Take your crew, too

✓ **Chassis cabs**
More versatility for your load

Getting the job done

Doing business is better with the versatile Transporter



INSIDE



Style and function

Lots of options to make your van perfect for you



7 ways your Van Centre can help you

PLUS Tips for picking your ideal van • How our warranty works for you • BlueMotion Technology explained

Whatever you're after, we've got a Transporter for you



IN MANY WAYS, the award-winning Transporter barely needs an introduction – it's been the mainstay of Volkswagen's respected commercial vehicle range for more than 60 years. That's 60 years of innovation, experience and know-how, all of which benefits you.

With a great choice of panel vans, kombis and customisable chassis cabs, all with plenty of wheelbase, roof-height and payload options, there's a Transporter for every job, whether it's shifting heavy loads, carrying crew or maybe a bit of both. There's a great choice of fuel-efficient 2.0-litre TDI engines, too. All you have to do is pick the Transporter that's perfect for you.



Transporter kombi >p16

Transporter panel van >p14



Transporter chassis and double cab >p17



INTRODUCING THE TRANSPORTER

- ✓ Advanced, economical TDI engines
- ✓ **NEW** BlueMotion Technology and BlueMotion models that cut emissions
- ✓ Fuel economy up to 44.8mpg (combined)
- ✓ Panel vans, kombis and chassis vans
- ✓ Choice of wheelbase and roof heights
- ✓ Up to 9.3m³ load volume
- ✓ Payloads up to 1,340kg
- ✓ Door options for easy loading

Make your next move

Find out why Volkswagen is a brand you can trust >p4

Go straight to the Transporter to learn more >p8

Contact us now: To find the location of your nearest Van Centre, get a brochure or book a test drive: 0800 717 131 www.volkswagen-vans.co.uk

Get connected: Volkswagen_CV VolkswagenCommercialVehiclesUK vwcommercialvehicles www.volkswagen-vans.co.uk/vanmail

Delivering the goods. It's what we've always done...

Today's much-loved, award-winning Volkswagen vans are only the latest step in a 60-year journey that started with one clever idea

In 1947, Dutch importer Ben Pon spotted workers at Volkswagen's Wolfsburg factory using a stripped-down Beetle to move parts around. Inspired, he sketched the platform for a versatile commercial vehicle that could be adapted to a multitude of uses. From this sketch, the Transporter was born, and the van world has never looked back.

Brilliant then, even better now

Since 1950, millions of Transporters have been built and have proved to be reliable workhorses for delivery drivers and tradesmen all over the world. There's more to owning a Volkswagen than just work, though – Volkswagen vans have always stood out from the pack, which has helped them build a loyal following, from the original 'Splittie' to today's sleek, modern models.

Reliability that endures

Today, Volkswagen's commercial vehicles are more popular than ever, with a diverse range of panel vans, kombis, chassis cabs, passenger carriers, camper vans and even pick-ups. Each is as versatile, spacious and reliable as Volkswagens have always been, but now they're more comfortable, easier to drive and more fuel-efficient than ever before. They're all backed up by a Van Centre network that's ready to solve any problem you may have, too.

Getting the job done efficiently and reliably has been at Volkswagen's heart for the last 60 years, and that's why you can trust us to deliver a van that works for you.

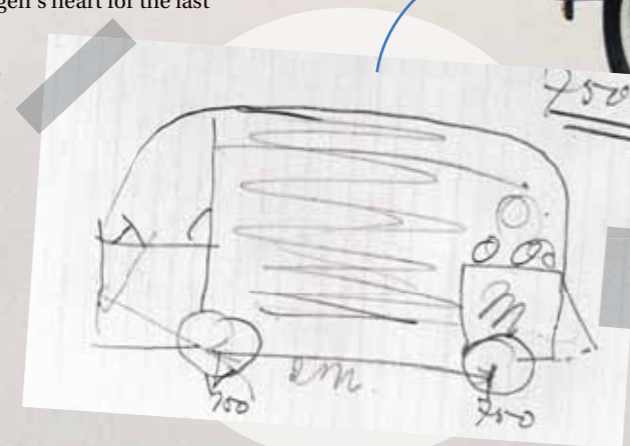

Transporter
The Transporter has been the mainstay of our van range since 1950. It still embodies the original's attributes of space, versatility and reliability, but is now more efficient than ever.



California
The definitive Volkswagen camper van is a true home from home, with four sleeping berths, a fully fitted kitchen and an electric pop-up roof.



Caddy
The compact Caddy has city-friendly dimensions and a car-like feel, but it can still carry big loads or plenty of passengers. Wide rear doors make loading simple, too.



Crafter
The Crafter is the van to have for seriously big tasks. It's available as a van, a chassis cab that you can customise in lots of ways or a window van, and has a payload of up to three tonnes.



Caravelle
For the ultimate level of executive comfort, only a Caravelle will fit the bill. It's an outstanding, flexible passenger carrier that can carry people and their luggage efficiently and easily.



Amarok
The Amarok joined the range in 2011. Its off-road and load-shifting credentials earned it the 'International Pick-up of the Year' award, and press praised its comfort and ease of driving.

Trust your Van Centre network

OWNING A VAN is about more than just the vehicle – it's about support, too. That means helpful advice, affordable finance, and maintenance and servicing to keep your van running more efficiently for longer. That's where our network of over 100 Van Centres and Authorised Repairers comes in. All our staff are fully trained to solve any problem you may have. • Find out how your local Van Centre can help right now – see pages 32-33.

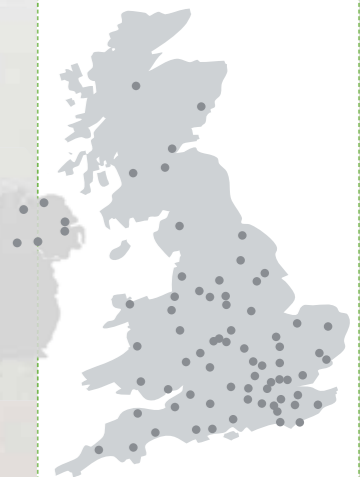

  To find your nearest Van Centre or order a brochure, visit www.volkswagen-vans.co.uk or call 0800 717131

Volkswagen round-up

Accolades and awards • BlueMotion Technology across the range • New trims for Caddy and Transporter

Volkswagen vans shine under awards spotlight



Volkswagen Commercial Vehicles has won a host of awards in recent months, including the title of 'Manufacturer of the Year' for 2012 from *Van Fleet World*.

The magazine also awarded the Transporter its 'Best Medium Van' prize, while the Caddy was 'Best Small Van'.

The Transporter was named 'Medium Panel Van' and 'Fleet Van of the Year' for 2012 by *Fleet Van*, while the top-of-the-range Transporter Sportline was *What Van?* magazine's 'Editor's Choice'.

The Caddy 4MOTION® was *What Van?*'s '4x4 of the Year', while the Amarok won 'Pick-up of the Year' from *What Van?* and 'Best Pick-up' at the British Insurance Vehicle Security Awards. The Amarok is also *4x4 Magazine's* 'Pick-up of the Year'.

To cap it all, Volkswagen Commercial Vehicles topped the *Fleet News* FN50 Reliability Survey as the 'Most Reliable Van Manufacturer', with the Caddy, Transporter and Crafter all in the top six.

These awards recognise and prove that our promise to you is truly alive and well. That promise is to bring you products that are more versatile, reliable, efficient and better value for money than ever.



Caddy Match sells out fast

The limited-edition Caddy Match – packed with a wealth of the most popular options – was a huge hit before orders closed on April 30. Make sure you don't miss the next special edition – follow our Twitter feed at [Volkswagen_CV](#)



BlueMotion Technology is here

BlueMotion Technology offers increased fuel efficiency and reduced carbon emissions, and it's available on most models in our range. To find out how BlueMotion Technology can help cut your fuel bills, turn to pages 20-23 or ask your Van Centre for details.

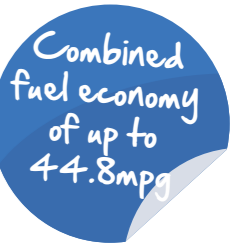

Finance that makes buying your vehicle easy

Getting your hands on a new van or passenger carrier from Volkswagen Commercial Vehicles could be even more affordable – and easier – than you think.

We've got a great range of finance deals that allow us to tailor a solution to the needs of your business and your pocket. That might be a lower initial deposit, or regular, fixed monthly payments that include pre-planned costs

for servicing and maintenance. It all helps you know exactly how much your vehicle will cost now and over the long term.

We have special finance offers, too, which offer you even more value for money, and they're regularly updated. You can find all the latest deals at [www.volkswagen-vans.co.uk](#), or pop into your local Van Centre to find out how we can help you.



Get connected with us online

We've got lots of ways to stay up to date with all that's going on in the world of Volkswagen Commercial Vehicles.

Sign up to Van Mail for the latest news and finance offers, or follow us on Twitter and like us on Facebook for a great mix of news, tips and exclusive competitions.

Our YouTube channel is packed with useful and fun videos, too. To stay connected, just add the links below to your browser's favourites.



New trims offer outstanding value

Now there's even more choice for Caddy and Transporter buyers, thanks to the introduction of new trims that offer a great pack of features at one easy price.

That makes buying a van with a high level of specification really simple and delivers you great value for money.

On Transporter panel vans and kombis, and Caddy panel vans,

Trendline and Highline trims bring extra features to the already well-appointed standard model. On the Transporter, you can also go for the ultra-high-level Sportline trim to really mark out your van and your business from the pack.

If you need to add even more features, there's an extensive list of factory-fit options and Add On accessories.



Get even more with Add Ons

Add Ons is Volkswagen Commercial Vehicles' range of accessories, with lots of work, technology and leisure products that can be fitted by your Van Centre at any time. See pages 64-65 for more details.

Contact us now: To find your local Van Centre, get a brochure for a different model, or book a test drive: 0800 717131 [www.volkswagen-vans.co.uk](#)

Get connected: [Volkswagen_CV](#) [VolkswagenCommercialVehiclesUK](#) [vwcommercialvehicles](#) [www.volkswagen-vans.co.uk/vanmail](#)

Contents

All your van-buying questions answered

What is it like to drive? >p10

Which model is right for me? >p14

Which engine do I need? >p18

What trims are available? >p24

What support can I expect? >p30

How much does it cost? >p34

What options can I choose? >p40

What are the facts and figures? >p66

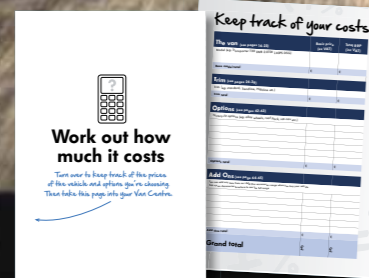

Add it all up... Keep track of your vehicle, engine and option choices using our handy checklist – you'll find it inside the back cover



"The optional parking sensors are really useful. Parking bays differ in size from borough to borough and, without the sensors, you wouldn't stand a chance"
Tony Kilbryde, Pimlico Plumbers



"We use our vans to carry all the different tools and spares for customer repair work, so we need a lot of room. The Transporter's large cargo bay really helps here"
Gary McKee, Miele



"For everyday getting around, the Transporter is great, especially in the city. It drives like a car, so it suits me for private use as well"
Charlie Clifford, Fit UK

Driving

Get from A to B easily and in comfort



"I love the dash-mounted gear lever. You don't have to reach down to use it - it's just there"

Jack Stevens,
Winterhalter



Parking is easy

The short-wheelbase Transporter is about the same length as a family saloon, making it easy to park. If you add front and rear parking sensors, getting into tight spots should be even easier.

Everyday driving made effortless

Getting the Transporter from job to job is a breeze – especially with the addition of optional DSG and 4MOTION® four-wheel drive

The Transporter has the sort of car-like driving feel that makes delivering goods easy. That's thanks to a choice of powerful 2.0-litre TDI engines, an easy-to-shift manual gearbox or automatic DSG gearbox and compact, city-friendly dimensions.

Geared up for easy shifts

All Transporters come with either a five- or six-speed manual gearbox, with an easy-to-reach, dash-mounted gearlever. You can also opt for the convenience of our seven-speed, Direct Shift Gearbox (DSG). Its fully automatic gear changes make it great for city driving, but you can always take control and change gear yourself by simply nudging the gear lever up or down.

Safety comes as standard

The Transporter is packed with technology that helps keep you – and your goods – safe on the roads. Volkswagen's advanced ESP (Electronic Stabilisation Programme) works with ABS (Anti-lock Braking System), EBD (Electronic Brakeforce Distribution) and TCS (Traction Control System) to keep you safe on the road, while Hill Hold Control makes hill-starts a doddle.

All these features are fitted as standard on every Transporter and work without you having to lift a finger.

Off-road ability

If you'll be driving off-road or where more traction is needed, consider choosing the optional 4MOTION® drivetrain. This clever all-wheel-drive system automatically sends power to the wheels that need traction most when conditions become slippery. In normal driving, it reverts to driving only the front wheels to ensure maximum fuel economy.



Driving on muddy building sites or where more traction is needed? Consider adding optional 4MOTION®

Driving tech explained



Direct Shift Gearbox (DSG)

Our seven-speed, Direct Shift Gearbox (DSG) is great for city driving. It can be used either as a fully automatic gearbox or as a quick-shift manual – just nudge the gear lever forwards or backwards to change gear up or down.

4MOTION

4MOTION® is an all-wheel-drive system that helps maintain optimum grip in all conditions. If one wheel loses traction, 4MOTION® reacts in milliseconds and sends power to the wheels with the most grip.

Comfortable and convenient

Spacious, versatile and packed with clever features, the Transporter's cab is a great place to keep your business working – even when you're on the road

You probably spend more time in your van than you do on your sofa at home, so it has to be comfortable. When you're out on the road, you also want to stay in touch with colleagues and customers to keep your business working. That's why we've built the cab of the Transporter with both comfort and work in mind.

The perfect fit for you

Whether you're doing motorway miles or door-to-door deliveries, the Transporter's cab fits like a glove. The ergonomically designed seats provide terrific support while the dash is clean and tidy, with all of the key controls just where you want them.

Stay in touch on the move

Your clients want to be able to reach you all the time. That's why we offer optional Bluetooth connectivity, allowing you to connect your phone and speak when on the move. With a selection of high-quality audio and satellite-navigation systems, you can also stay entertained and on the right road wherever you are.



Electric windows and electrically adjustable mirrors are fitted as standard

Bluetooth allows you to use a phone without taking your hands off the wheel



"There's plenty of storage – you can use the glovebox, both door panels and the area under the front passenger seats. No excuses for mess in the cab!"
Tony Kilbryde, Pimlico Plumbers

Ultra-clear dashboard

All the controls are easy to use, so you stay focused on the road. A gearshift indicator helps you change gear at the most economical moments.

Comfy seats

Our ergonomically designed seats offer terrific support
Want more? Our seat options let you choose a layout that's perfect for you and your passengers (see page 58)



Cool and comfortable

Heat-reflective glass keeps things cool, even in the summer.

Want more?

Choose air-conditioning – this gives you even more temperature control. See page 56.

Entertainment and sat-nav to suit you

Want to play MP3s, listen to DAB radio, watch a DVD once you've stopped or add Europe-wide sat-nav? We've got the kit for you. See page 46.

Three-spoke steering wheel

The three-spoke steering wheel is comfortable and easy to use at all times.

Want more?

A multi-function steering wheel (see page 54) and optional Bluetooth kit let you control your phone and audio system.



Plenty of places to store your stuff

WORKING VEHICLES don't just carry the load in the rear – their cabs carry all the clutter that fills your working day, too. That means invoices, drinks, laptops and more. You'll find lots of clever storage spaces in every Transporter – a shelf in the roof, huge door pockets, a large area under the passenger seats and an optional fold-down tray on the passenger seat.



Your local Van Centre can help you choose the right options for you. Find your nearest one on www.volkswagen-vans.co.uk, or call 0800 717131

Loading

Roomy cargo bays and useful features that make life easy



Easy access, lots of options

Cargo couldn't be easier to load and unload in the Transporter, thanks to its low floor height (566mm) and a wide choice of roof, side- and rear-door configurations. There are also plenty of other cargo bay options to help you customise your Transporter's load area to your needs. **Turn to pages 48-53 for more.**

Transporter panel van

All the space you'll need

When you're shifting large loads, you want a van with a large cargo bay and easy access. If that's the case, the Transporter panel van is your perfect match

The Transporter panel van comes with lots of options to make delivering your cargo as easy and efficient as possible. A choice of two wheelbases lets you load items up to 2.97m long, while optional roof packs can increase the load height to 1.94m and bring the load volume up to an impressive 9.3m³.

Easy to load

With a low floor height of 566mm, getting cargo in and out of the Transporter is a breeze, and you can secure your load with up to eight lashing rings. The panel van comes with a nearside sliding door as standard, but adding an optional second sliding door lets you access

your cargo on whichever side of the road you park. Panel vans come with unglazed rear doors as standard, but you can choose to add a variety of factory-fitted rear door options, including tailgates or doors with 250-degree hinges, which fold completely out of the way for easy loading and unloading.

Configured to your needs

We know that personalising your cargo bay helps you to get even more from your vehicle. So, whether you're after roof bars, towing attachments or plying to keep your van's interior looking good, we've got a range of factory-fitted options that are designed to last.



Sizing your load

You can easily fit two 0.8m x 1.2m Euro pallets into a short-wheelbase Transporter. The long-wheelbase model can take three with room to spare



"We often carry air-conditioning units to jobs. They're bulky and weigh up to 100kg, but we've been able to fit in four or five, and the van has coped brilliantly"

Mat Brown, Crown Air Conditioning

The range: Transporter panel van

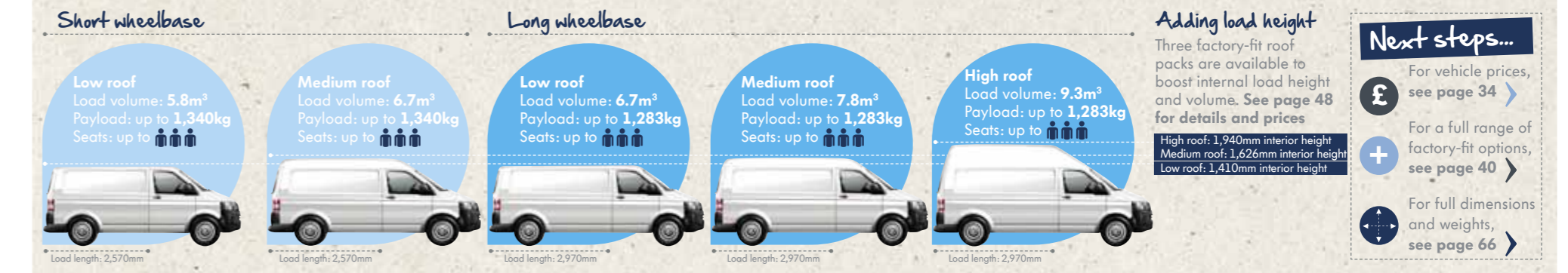

The best of both worlds

Want to carry your crew, but still shift plenty of stuff? With three extra seats and loads of cargo space, the Transporter kombi can do both with ease

Sometimes work isn't just about shifting cargo or tools. You may have to take crew to a job, too, and moving them in separate vehicles costs money. Enter the Transporter kombi – a truly versatile way to move up to six people and goods in one swift move.

Same great cargo versatility

The Transporter kombi comes in the same versatile configurations as the panel van. That means short and long wheelbases for loads up to 2.97m in length, with optional roof packs that can increase the interior height to 1.92m and bring the total load volume up to 9.3m³. You can also add a second sliding door to the standard

nearside door, or a rear tailgate or twin rear doors with 250-degree hinges for ease of loading. In fact, you can customise the Transporter kombi in all the same ways as you can with a panel van.

Seating that works for you

All Transporter kombis come with a driver's seat, dual passenger seat and three-seat rear bench as standard. For extra versatility, the rear bench folds down, increasing the load area to almost that of a panel van.

There are also optional seat packs – for example, swivelling front seats that let you and a passenger turn to face those in the rear.



Sizing your load

An average washing machine will occupy about 0.25m³ of your Transporter kombi's load volume and weighs about 70kg



Want to carry more crew?

A Transporter shuttle or window van could be for you. Visit www.volkswagen-vans.co.uk, call 0800 717131 or ask at any Van Centre for a brochure.



Transporter chassis and dropside

Robust and flexible

The heavy-duty Transporter chassis comes with the options of a factory-fitted dropside or a load area that can be customised to your specific needs

When what you need to carry won't fit in a panel van, or if you need to configure your load area to your specific needs, the Transporter chassis offers a world of options. It's available as either a single cab that seats up to three people or a double cab that seats up to six.

Dropsides that do the job

When it comes to creating your perfect heavy-duty Transporter, you've got two options. You could pick a Transporter chassis fitted with our off-the-shelf, rugged alloy dropside body or, if you're after something specific, your local Van Centre can point you in the direction of a Volkswagen Commercial Vehicles-approved converter, who can provide a solution that's perfect for your needs.

• To find out more about converting a Transporter chassis, visit www.volkswagen-vans.co.uk/conversions, contact your local Van Centre or call us on 0800 717131



The range: Transporter kombi

Short wheelbase

- Low roof**
Load volume: 5.8m³
Payload: up to 1,234kg
Seats: up to 6
- Medium roof**
Load volume: 6.7m³
Payload: up to 1,234kg
Seats: up to 6

Load length: 2,570mm

Long wheelbase

- Low roof**
Load volume: 6.7m³
Payload: up to 1,171kg
Seats: up to 6
- Medium roof**
Load volume: 7.8m³
Payload: up to 1,171kg
Seats: up to 6
- High roof**
Load volume: 9.3m³
Payload: up to 1,171kg
Seats: up to 6

Load length: 2,970mm

Adding load height
Three factory-fit roof packs are available to boost internal load height and volume. See page 48 for details and prices

- High roof: 1,940mm interior height
- Medium roof: 1,610mm interior height
- Low roof: 1,394mm interior height

Next steps...

- For vehicle prices, see page 34
- For a full range of factory-fit options, see page 40
- For full dimensions and weights, see page 66

The range: Transporter chassis cab and double cab

Long wheelbase only

- Single-cab chassis**
Payload: up to 1,399kg
Seats: up to 3
- Double-cab chassis**
Payload: up to 1,266kg
Seats: up to 6
- Single-cab dropside**
Payload: up to 1,399kg
Seats: up to 3
- Double-cab dropside**
Payload: up to 1,266kg
Seats: up to 6

Next steps...

- For vehicle prices, see page 34
- For a full range of factory-fit options, see page 40
- For full dimensions and weights, see page 66

Not big enough for your load?

The Volkswagen Crafter could be the right van for you. Call 0800 717131, visit www.volkswagen-vans.co.uk, or ask at any Van Centre for a brochure.



Engines

Technology that helps to cut fuel bills and lower emissions



"I've been really impressed with the Transporter's fuel economy. Diesel prices keep going up, so I'm glad that my van is better than most in terms of fuel efficiency"

Charlie Clifford, FitUK

Intelligent power to drive you on

The Transporter's advanced 2.0-litre TDI engines are easily strong enough to get the job done, while keeping fuel bills to a minimum

Fuel is likely to be your van's biggest running cost these days. However, thanks to Volkswagen's years of experience developing advanced turbodiesel (TDI) technology, the Transporter's 2.0-litre TDI engines now offer more power and use less fuel than ever before – up to 20% less, in fact.

Versatile engine choices

The Transporter's 84PS 2.0-litre TDI has 220Nm of torque – plenty of pulling power for heavy loads – yet

its fuel efficiency reaches up to 37.7mpg (combined) and has CO₂ emissions as low as 198g/km. Need more? The twin-turbo 180PS BiTDI has 400Nm torque, with 36.2mpg (combined) and CO₂ emissions of 205g/km.

Go even greener

If you want to take your fuel efficiency to a new level and cut emissions even further, you can always add BlueMotion Technology, or go for the ultra-efficient BlueMotion model. Turn the page to learn more.

Engine specifications

See page 66 for full engine data

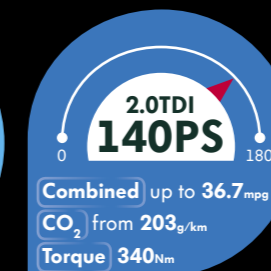
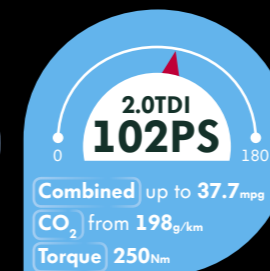
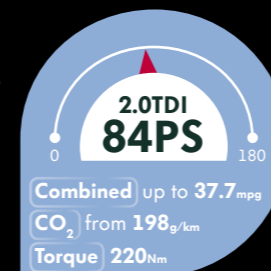

Why torque matters

Torque is often more important than power when it comes to an engine's performance. If you carry heavy cargo often, pick an engine with lots of torque. It will move a heavy load from a standing start better than one with less torque, and keep it moving more easily. A torquey engine may even use less fuel, because you won't need to rev it as much to get the best out of it.



Add a sat-nav

A sat-nav system can plot shorter routes and prevent you making wrong turns – some can even navigate around traffic jams. It all helps cut fuel consumption.



Driver training

Driver training can teach you to drive more safely and more economically. Ask the Freight Transport Association (www.fta.co.uk) for details on a course to suit you.

Top tips to help you save fuel

Cutting fuel use isn't just about engine technology – it's also about being clever. Follow our four tips to make your van as economical as possible.

Use your van's gearshift indicator

A gearshift indicator is fitted to all Transporters. It helps you change gear at the most efficient times, which cuts fuel use and lowers emissions.



Check your tyres

Up to 20% of a vehicle's fuel consumption is used in overcoming the tyres' rolling resistance. It's even more if your tyres are underinflated, so check them regularly.



More miles, less impact

BlueMotion Technology lowers your van's fuel costs and CO₂ emissions. It's now available across most models in the Transporter range

At Volkswagen Commercial Vehicles, we're as keen as you to reduce our vehicles' fuel consumption and emissions. We know that fuel costs are a big burden on van drivers and businesses, so improving our vehicles' efficiency only brings you even better value. That's why we've brought in BlueMotion Technology to the Transporter range.

The power of technology

All Transporter panel vans and kombis that carry the BlueMotion Technology badge include our energy-saving solutions – start/stop, low-rolling-resistance tyres, energy recuperation and cruise control – as

standard. Together, they create instant fuel savings and lower CO₂ emissions. The benefit is money – and time – saved at the pumps.

Two engines, all the options

BlueMotion Technology can be added to two engines in the Transporter range – the 84PS and 114PS versions. Each delivers combined fuel economy of 41.5mpg and cuts CO₂ emissions to 179g/km.

Another benefit of BlueMotion Technology is that the savings come without compromise, because you can add almost any factory-fit options you like. Your Van Centre can help you choose the best ones for you.

BlueMotion Technology specifications

See page 66 for full engine data

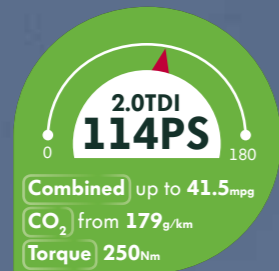
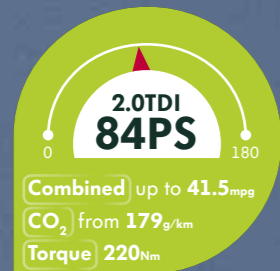

"The BlueMotion Technology Transporter has everything we wanted in one model – solid engineering, great fuel economy and low CO₂ emissions."

David Landy,
 Head of Fleet
 for BSKyB



How BlueMotion Technology works to lower your fuel bills and CO₂ emissions

BlueMotion Technology is available as an engine option on most Transporter panel vans and kombis, and is made up of four elements. Together, they make significant cuts in fuel consumption and CO₂ emissions, which keeps money in your pocket and reduces the impact on the world around us. Here you can learn more about these elements and what they do.

Cruise control

By keeping your van at a constant speed, cruise control saves fuel that would normally be wasted when your speed fluctuates. It's especially useful for driving over long stretches, because it stops your speed creeping up unintentionally and reduces driver stress.



Low-rolling-resistance tyres

Fitting tyres with low rolling resistance means that the engine doesn't have to work as hard to get your van moving – or keep it moving. It all helps to save fuel and reduce carbon emissions.



Start/stop

Start/stop allows you to save fuel at traffic lights. When you stop, put your van in neutral, release the clutch and the engine automatically switches off, saving fuel and reducing emissions. When you're ready to go, depress the clutch and the engine starts up again.

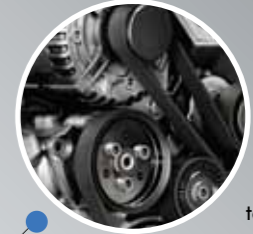

Regenerative braking

When braking, energy during deceleration is wasted. Our energy recuperation system uses some of that momentum to turn the alternator and charge the battery. If the battery is well-charged, the engine has to do less work turning the alternator to keep it topped up. This cuts fuel use and emissions.

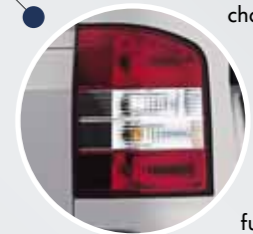

Engines

The ultimate in efficiency

The Transporter BlueMotion is the top performer in Volkswagen's BlueMotion Technology range

The Transporter BlueMotion panel van is a true hero of the Volkswagen Commercial Vehicle range. As well as using all of the BlueMotion Technologies, every aspect of its specification has been optimised to reduce weight and improve aerodynamics. That means you benefit from impressive fuel-efficiency figures of 44.8mpg (combined) – that's 7.1mpg better than a standard Transporter – and incredibly low CO₂ emissions of just 166g/km. For the record, that makes this Transporter the most efficient panel van in its class* – quite an achievement.

Up to **18%** improved economy

The Transporter BlueMotion offers up to 18% improved fuel economy over the standard 2.0TDI 102PS – that's 7.1mpg (depending on your driving style)



BlueMotion takes you further

One tank of fuel can take a standard Transporter 2.0 TDI 102PS from Land's End to Dundee – impressive. A BlueMotion Technology model can go on to Aberdeen, while a BlueMotion model will power you to Inverness. That's really impressive.

102PS Standard = **663** miles.
 114PS BlueMotion Technology = **710** miles.
 114PS BlueMotion = **789** miles.
 (Comparison based on combined fuel economy figures)

* Correct at time of going to print



1 SAME GREAT LOAD SPACE

The Transporter BlueMotion is as user-friendly as any other Transporter panel van – with its short wheelbase, it's great for city driving, yet it can still carry up to 871kg and loads as long as 2.57m.

2 BLUEMOTION TECHNOLOGIES

The Transporter BlueMotion contains all our BlueMotion technologies: start/stop, energy recuperation, low-rolling-resistance tyres and cruise control.

3 IMPROVED ECONOMY

The 2.0-litre TDI engine brings fuel economy of 44.8mpg (combined) and CO₂ emissions of 166g/km, yet with 114PS, it's still astonishingly powerful.

4 PAINT OPTIONS

The Transporter BlueMotion is available in all the paint colours from the Transporter range, as well as a new Glacier Blue (as seen here) that is exclusive to this model.

5 PLENTY OF OPTIONS

The Transporter BlueMotion has almost the same extensive range of options as the rest of the Transporter range, letting you customise your van. A few are limited because of the BlueMotion model's ultra-efficient design, but your Van Centre can help you pick the best solutions.

BlueMotion specifications

See page 66 for full engine data

2.0TDI 114PS

Combined 44.8mpg
 CO₂ 166g/km
 Torque 250Nm

Trims

A great range of trims that offer value and choice



Quality comes naturally

Whatever business you run, the Transporter is equipped with an impressive list of standard features that enhance the comfort, driving performance, usability and safety of your Volkswagen van. It may be the entry-level Transporter, but there's nothing basic about it.

STANDARD

Standard

A great van from the start

With a wide range of features fitted as standard, the Transporter is always ready to go to work

Even before you add any extras, the Transporter is ready to go, straight out of the box. From in-cab comfort to load-bay convenience, and from safety to storage, the Transporter has it covered.

A comfortable, convenient cab

The generous cab specification reflects the thought that has gone into making the standard Transporter right for you. For starters, the comfortable cab seats and adjustable steering wheel let you find your ideal driving position. Power steering makes light work of driving and parking around town, too.

Then there's convenience. You get electric front windows and electrically adjustable, heated door mirrors, while heat-reflective glass keeps the cab cool. And to keep you entertained, there's the excellent RCD 210 radio with a single CD player.

Easy-access load bay

The standard Transporter's load area has been designed to make your life easy. There are twin rear doors and a nearside sliding door to give you plenty of access, and six load-lashing rings (eight on the long-wheelbase model) to keep your load secure. Two door-activated interior lights keep the area illuminated, too.

If you're opting for a kombi, instead of twin doors at the rear you get a tailgate with a heated window and wash/wipe to keep the rear view clear.



Smooth, open-wide action ensures fast and easy access to your load space



Keep it secure

All Transporters have six load-lashing rings (long-wheelbase models have eight), so you can fit cargo netting or ties to keep your load safe and secure.

Safe as houses

The standard Transporter has one of the most comprehensive standard safety specifications on the market. Top of these is the Electronic Stabilisation Programme (ESP). There are also Anti-lock Brakes (ABS) with Electronic Brakeforce Distribution (EBD), Engine Braking Control (EBC) and Traction Control (TCS). Hill Hold Assist helps you make safe hill-starts.

The standard equipment doesn't stop there. There are daytime running lights, while hazard warning lights come on automatically under emergency braking to warn other drivers. Driver and passenger airbags are standard, while your van and its contents are kept safe, too, thanks to remote central locking with deadlocks and internal locking control.

Standard features



- ✓ Twin rear wing doors
- ✓ Nearside sliding door
- ✓ Two door-activated interior lights in cargo area
- ✓ Six load-lashing rings (eight in long-wheelbase models)
- ✓ Interior entry step
- ✓ Half-height hardboard sidelining in cargo bay
- ✓ Dual passenger seat with storage area underneath
- ✓ Power steering
- ✓ RCD 210 radio/single CD player
- ✓ Digital clock
- ✓ Engine Braking Control
- ✓ Electronic Brakeforce Distribution
- ✓ Electronic Stabilisation Programme
- ✓ Anti-lock Braking System
- ✓ Hill Hold Assist



Trendline

Packed with useful tech

Trendline models get style *and* technology – an MP3-friendly sound system, Bluetooth, rear parking sensors and body-coloured bumpers

Trendline models take the Transporter's great looks and standard features, and add even more – inside and out. It's every inch a Transporter, but even more desirable.

Sharper looks

The Trendline's extra features really make the Transporter look the business. Body-coloured bumpers, mirrors, door handles and wheel trims make your van stand out. Kombi models get privacy glass on the sliding doors, too.



Parking sensors

Rear parking sensors make it easy to park when vision is restricted

Convenience comes free

As well as comfort, the Trendline trim also brings you great new levels of convenience. That means cruise control for stress-free motorway trips, Bluetooth phone preparation, a trip computer and rear parking sensors – all fitted and ready for you to use straight away. There's also a cab comfort pack, which includes extra soundproofing, sun visors with vanity mirrors, a two-tone horn, additional storage facilities and more.

Trendline features

(In addition to standard models)



- ✓ RCD 310 single CD/radio with ParkPilot display, aux-in socket, large display and four speakers
- ✓ Bluetooth phone connection
- ✓ Rear parking sensors
- ✓ Premium dashboard
- ✓ Body-coloured bumpers, door mirrors and door handles
- ✓ Driver's seat armrests
- ✓ Full-height bulkhead
- ✓ Cruise control

Highline

Extra style, added cool

A leather steering wheel, alloy wheels, front fog lights and Climatic air-conditioning give Highline models even more comfort and style



A leather steering wheel and gearknob are standard on the Highline's smart dashboard



Semi-automatic air-conditioning helps to keep the cab cool

If image is critical to your business, your van has to reflect that. Enter the Transporter Highline – it's dynamic and exclusive in looks, and ultra-comfortable inside, but still retains the Transporter's outstanding everyday practicality.

Set the style on the road

The Transporter Highline includes all of the external styling features from the Trendline trim – body-coloured bumpers, mirrors and door handles – and adds 16" Colmar alloy wheels (with locking wheel nuts to keep them safe). If you opt for one of the the top-of-the-range 180PS 2.0TDI models, you receive an upgrade to 17" Thunder alloy wheels. Additionally, there are front fog lights for greater visibility in poor conditions.

Even more comfort in the cab

Just like the Trendline trim, you get Bluetooth phone connection, rear parking sensors and cruise control, as well as the four-speaker RCD 310 radio/CD (with aux-in). Highline models also benefit from the addition of luxury extras such as a leather steering wheel and gearknob, while semi-automatic air-conditioning helps to keep your cab cool, so you'll arrive at your job feeling refreshed. And when you're with clients, a Thatcham Category 1 alarm and immobiliser (both standard) help to keep your van secure.

Highline features

(In addition to Trendline trim)



- ✓ 16" Colmar alloy wheels (17" Thunder for 180PS models)
- ✓ Semi-automatic air-conditioning
- ✓ Leather steering wheel and gearknob
- ✓ Front fog lights
- ✓ Thatcham Category 1 alarm and immobiliser with perimeter protection

1

THE STYLE IS IN THE DETAILS

The Transporter Sportline can be a subtle promoter of your business. Sportline logos and chrome detailing highlight a sophisticated cab and front end, while darkened light clusters and polished-steel side bars create a striking appearance.

2

A SPORTY RIDE

18" Sportline five-spoke alloy wheels – available in silver or black – give the Sportline a dynamic look. Under the skin, stiff suspension (set 30mm lower than a standard Transporter) makes for a more engaging drive.

4

ENTERTAINED AND IN TOUCH

The Sportline's Kenwood Multimedia System has a 7" colour touch-screen and full European satellite navigation with real-time traffic info. There are also connections for Bluetooth mobile phones and other external devices.

3

POWERFUL AND EFFICIENT

The Sportline uses the Transporter's top-of-the-range 2.0-litre BiTDI twin-turbo diesel engine. With 180PS and 400Nm of torque, it has enough power for any job, but remains refined and economical all the time.

5

LUXURY OFFICE ON THE MOVE

The Sportline's stylish cabin features two-tone leather upholstery, front floor mats with a Sportline logo, and leather covers for the steering wheel and gearknob. There's a driver's-seat armrest and air-conditioning, too.

6

UP TO THE TASK

The Sportline retains all the practicality you'd expect in any Transporter – 6.7m³ of load space and a 1,259kg payload. The kombi version seats up to five people, while long- and short-wheelbase variants widen your choice further.



Sportline

It's the business

Make a real impression with the top-of-the-range Transporter Sportline – it's stunning inside and out

The Transporter Sportline lifts Volkswagen's best-seller into a bold new business class. Available as a panel van or a kombi, the Sportline features all the versatility you'd expect, but its remarkable performance and sleek styling will turn heads and confirm to your customers that they're dealing with discerning tradespeople. We know, because *What Van?* picked the Sportline as 'Editor's Choice' in its 2012 awards.

Sportline features

- ✓ Kenwood Multimedia system with satellite-navigation
- ✓ Two-tone leather upholstery
- ✓ Leather steering wheel and gearknob
- ✓ Floor mats with Sportline logo
- ✓ 18" Sportline alloy wheels
- ✓ Body-coloured bumpers and door handles
- ✓ Darkened rear light clusters
- ✓ Gloss Black door-mirror housings and lower front grille with added Sportline logo
- ✓ Polished stainless-steel side bars
- ✓ Front spoiler and rear roof spoiler
- ✓ Lowered suspension (30mm lower)
- ✓ Choice of three exterior paint colours

Full support right from the start



"For me, my van is like any other tool I use: the less I have to think about it, the better. Using a Volkswagen has been so hassle-free."

Gary McKee, Miele

We want to make sure that using your van is as hassle-free and cost-efficient as possible, so every vehicle comes with a three-year warranty and a choice of finance, servicing and insurance options. It all helps to keep the big issues covered



A three-year warranty that lasts up to 100,000 miles

All Transporters get a three-year, 100,000-mile warranty – and so do any factory-fit options that you buy. The vehicle warranty is made up of:

- A two-year manufacturer's warranty with unlimited mileage
- A third-year Van Centre warranty, up to a maximum of 100,000 miles

Even if you exceed 100,000 miles during your first two years, the manufacturer's two-year warranty will still be valid.

Want cover for longer?

You can extend your vehicle warranty online or by phone. You can choose Comprehensive or Major Component cover and either one-off or monthly payments. Call **0845 641 9712** or visit www.volkswagencvwarranty.co.uk for details.



Service options designed to fit your business perfectly

It's only natural that you want to keep your vehicle running at its best. Getting it serviced at a Volkswagen Van Centre is a great way to ensure that's exactly what happens. However, when it comes to servicing, we know every business has different needs. That's why we've developed three different service options for you to choose from:

- Pay Monthly
- Pay Upfront
- Pay On-Demand

Whichever suits your business best, you can rest assured that when you book in your vehicle, it'll be looked at by Volkswagen-trained technicians and they'll use only Volkswagen quality parts. What's more, there's a two-year warranty on the parts and one on labour.

For more details

visit www.volkswagen-vans.co.uk, or call **0800 717131** to learn more.



Volkswagen Insurance keeps you covered*

Volkswagen Commercial Vehicle Insurance can provide you with cost-effective, comprehensive motor insurance. Look at some of the benefits:

- Seven-day free cover to allow you to drive your vehicle away knowing it's insured
- All repairs performed by approved repairers
- Volkswagen quality parts on all repairs
- Courtesy vehicle provided during repair following an accident
- Cover for breakage and damage to glass
- Tools-in-transit cover (up to £1,000)
- In-vehicle personal belongings cover (up to £500)
- Vehicle recovery
- 60-day European Union cover
- Legal expenses cover up to £100,000

We also offer a range of gap insurance products. These help you replace your vehicle or protect you from any financial shortfall if it is written off.

For more details

visit www.insurewithvwcv.co.uk, call **0800 316 7896** or pop into your Van Centre and ask for a Flexible Finance brochure.

* Terms and conditions apply

"If your van's not working, you're not working. That's why we're here to help"



Flexible Finance that makes things affordable

We can also make buying a new van more affordable in the first place. Speak to us about our selection of finance options, which include:

- Contract hire
- Finance lease
- Lease purchase
- Hire purchase

For more details

visit www.volkswagen-vans.co.uk/finance or pick up our Flexible Finance brochure at your nearest Van Centre.



Three years' Roadside Assistance

Sometimes, the unexpected happens. If it does, your new Transporter comes with an unlimited-mileage recovery and assistance package. It lasts the same three years as your warranty and operates 24 hours a day, 365 days a year.

Cover is available across the UK and most of Europe. Our fully trained technicians can diagnose most problems at the roadside and they use Volkswagen quality parts.

Learn more

Visit your Van Centre to get a Volkswagen Roadside Assistance handbook, visit www.volkswagen-vans.co.uk/aftersales/roadside-assistance or call **0800 77 71 72**



Van Centres – always there for you

Our dedicated Van Centre network is the backbone of everything we do, with more than 100 Van Centres and Authorised Repairers throughout the UK

Our Van Centre network offers a wide range of services, from MOTs to accessories, servicing to fully fitted parts. Not only that, but we use Volkswagen quality parts and you get dedicated staff who understand your vans intimately. So pop in for a coffee and a chat, and find out what your Van Centre can do for you.

Turn the page to learn more about our Van Centre network

7 ways your Van Centre can help you right now

Make full use of your nearest Van Centre – it's full of Volkswagen experts who know your vehicle better than anyone and who can help you to get the best out of it

Picking a van that's perfect for your needs

We know that choosing your next van or passenger carrier is a big decision. You want a vehicle that works as hard as you do, both now and for the long-term – one that's versatile, cost-effective and reliable. We're here to help make your choice easier.

Our Van Centre experts can offer advice on every model in the range and help you pick the right vehicle and factory-fit options for your business. They can also advise you on the best finance packages to ensure that your payments make financial sense.



Always on hand to help



Quality servicing you'd expect at a price you wouldn't

Unpredictability and moving goalposts are part of life for a modern business, making it difficult to predict how many miles your vehicle will do in a year, or how long you'll need to keep it. Our National Service Pricing is designed for customers who need the flexibility of being able to book their vehicle in for a service whenever it needs it. When you do, our technicians will do everything necessary to ensure that your vehicle is back on the road, working hard for your business, as soon as possible.



Express Visual Checks – peace of mind for free

Your Van Centre or Authorised Repairer can give your vehicle a free, 29-point Express Visual Check for complete peace of mind. You'll be given a comprehensive report, with the results clearly explained, and your technician will talk you through what work may need to be done in the future, so you can plan ahead and budget for it. If something needs urgent attention, you can get a precise quote before any work is done – and all the Volkswagen parts are covered by a two-year warranty.

Accessories designed to help you get more from your van

Perhaps you've bought a van and your needs have changed – maybe you need a towbar or a roof rack, or perhaps you want to give your van some extra style. That's where Add Ons comes in. Add Ons is an extensive range of Volkswagen-approved accessories, available to buy and be fitted at your local Van Centre. We've got everything from towbars to tailgate spoilers, load nets to leather seats and sat-nav systems to stunning alloy wheels.



Fast, hassle-free van rental for one-off jobs

Need another van for just a short while? We can hire you any vehicle from our fleet – Caddy, Transporter or Crafter – or passenger-carrier versions of the Transporter and Crafter if you need to move people.

For more information, call the Van Rental team on 01908 467450

Fully fitted parts for a fixed price – and not a penny more

The pricing of all our Volkswagen quality parts is straightforward and clear, so you know exactly how much you're paying. Even better, when they're fitted by trained technicians at a Van Centre or Authorised Repairer they come with two years' warranty and 12 months warranty on labour. If your van is over five years old, ask us about our Economy Parts range. This is a great-value way to help keep your vehicle 100% Volkswagen – it uses high-quality parts that come with a two-year warranty.



Taking the worry out of tyres

Why run around looking for a fitter who has your tyres in stock? Let us fit new tyres when your van is in for its service and it'll keep your van off the road for less time. We have a huge range of tyres for all Volkswagen vans, from economy to premium brands, including winter tyres.



What else can we do?

Loads! Just pop into any Van Centre and ask us. For example, we may be able to point you to a local signwriter, recharge your air-conditioning, or answer any queries about your vehicle. Whatever it may be, we're here for you.



To find your nearest Van Centre, visit www.volkswagen-vans.co.uk or call 0800 717131

Prices

Every Transporter van listed. All the prices you need

Want to work out how much your van costs? Use our tracker on the back cover

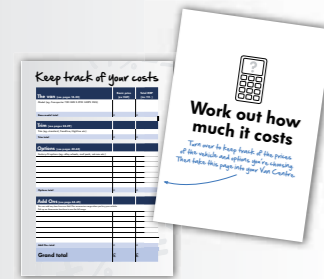

Every Transporter has an On The Road package that covers basic vehicle costs

On The Road (OTR) package	
First registration fee	£55.00
Delivery to Van Centre	£565.00
VAT	£117.00
Vehicle Excise Duty (12 months)	£215.00
Number plates	£20.00
Basic OTR (ex VAT)	£855.00
Total OTR price	£972.00

Transporter panel van



Model	Engine/transmission	Basic (ex VAT)	Total (inc VAT)	Total RRP including OTR*		Insurance group†
				(ex VAT)	(inc VAT)	
Short wheelbase						
T26	2.0TDI 84PS	£17,225.00	£20,670.00	£18,080.00	£21,642.00	5E
	2.0TDI 102PS	£17,975.00	£21,570.00	£18,830.00	£22,542.00	9E
T28	2.0TDI 84PS	£17,575.00	£21,090.00	£18,430.00	£22,062.00	5E
	2.0TDI 102PS	£18,325.00	£21,990.00	£19,180.00	£22,962.00	6E
	2.0TDI 140PS	£19,825.00	£23,790.00	£20,680.00	£24,762.00	6E
	2.0TDI 140PS DSG	£21,225.00	£25,470.00	£22,080.00	£26,442.00	9E
	2.0TDI 140PS 4MOTION®	£22,025.00	£26,430.00	£22,880.00	£27,402.00	9E
	2.0BiTDI 180PS	£21,425.00	£25,710.00	£22,280.00	£26,682.00	6E
	2.0BiTDI 180PS DSG	£22,825.00	£27,390.00	£23,680.00	£28,362.00	9E
	2.0BiTDI 180PS 4MOTION®	£23,625.00	£28,350.00	£24,480.00	£29,322.00	10E
	2.0BiTDI 180PS DSG 4MOTION®	£25,025.00	£30,030.00	£25,880.00	£31,002.00	10E
	T30	2.0TDI 84PS	£17,925.00	£21,510.00	£18,780.00	£22,482.00
2.0TDI 102PS		£18,675.00	£22,410.00	£19,530.00	£23,382.00	6E
2.0TDI 140PS		£20,175.00	£24,210.00	£21,030.00	£25,182.00	6E
2.0TDI 140PS DSG		£21,575.00	£25,890.00	£22,430.00	£26,862.00	7E
2.0TDI 140PS 4MOTION®		£22,375.00	£26,850.00	£23,230.00	£27,822.00	7E
2.0BiTDI 180PS		£21,775.00	£26,130.00	£22,630.00	£27,102.00	7E
2.0BiTDI 180PS DSG		£23,175.00	£27,810.00	£24,030.00	£28,782.00	TBC
2.0BiTDI 180PS 4MOTION®		£23,975.00	£28,770.00	£24,830.00	£29,742.00	TBC
2.0BiTDI 180PS DSG 4MOTION®		£25,375.00	£30,450.00	£26,230.00	£31,422.00	7E
T32		2.0TDI 102PS	£19,025.00	£22,830.00	£19,880.00	£23,802.00
	2.0TDI 140PS	£20,525.00	£24,630.00	£21,380.00	£25,602.00	7E
	2.0TDI 140PS DSG	£21,925.00	£26,310.00	£22,780.00	£27,282.00	10E
	2.0TDI 140PS 4MOTION®	£22,725.00	£27,270.00	£23,580.00	£28,242.00	12E
	2.0BiTDI 180PS	£22,125.00	£26,550.00	£22,980.00	£27,522.00	10E
	2.0BiTDI 180PS DSG	£23,525.00	£28,230.00	£24,380.00	£29,202.00	11E
	2.0BiTDI 180PS 4MOTION®	£24,325.00	£29,190.00	£25,180.00	£30,162.00	11E
	2.0BiTDI 180PS DSG 4MOTION®	£25,725.00	£30,870.00	£26,580.00	£31,842.00	11E

* For full details of VED (Vehicle Excise Duty) bands and other costs included in the On The Road package, please ask your Van Centre.
† As advised by the Association of British Insurers (ABI). Please see www.thatcham.org/abigrouprating for more information

Model	Engine/transmission	Basic (ex VAT)	Total (inc VAT)	Total RRP including OTR*		Insurance group†
				(ex VAT)	(inc VAT)	
Long wheelbase						
T28	2.0TDI 84PS	£18,065.00	£21,678.00	£18,920.00	£22,650.00	9E
	2.0TDI 102PS	£18,815.00	£22,578.00	£19,670.00	£23,550.00	9E
	2.0TDI 140PS	£20,315.00	£24,378.00	£21,170.00	£25,350.00	9E
	2.0TDI 140PS DSG	£21,715.00	£26,058.00	£22,570.00	£27,030.00	9E
	2.0TDI 140PS 4MOTION®	£22,515.00	£27,018.00	£23,370.00	£27,990.00	9E
	2.0BiTDI 180PS	£21,915.00	£26,298.00	£22,770.00	£27,270.00	9E
	2.0BiTDI 180PS DSG	£23,315.00	£27,978.00	£24,170.00	£28,950.00	10E
	2.0BiTDI 180PS 4MOTION®	£24,115.00	£28,938.00	£24,970.00	£29,910.00	10E
	2.0BiTDI 180PS DSG 4MOTION®	£25,515.00	£30,618.00	£26,370.00	£31,590.00	10E
	T30	2.0TDI 84PS	£18,415.00	£22,098.00	£19,270.00	£23,070.00
2.0TDI 102PS		£19,165.00	£22,998.00	£20,020.00	£23,970.00	6E
2.0TDI 140PS		£20,665.00	£24,798.00	£21,520.00	£25,770.00	6E
2.0TDI 140PS DSG		£22,065.00	£26,478.00	£22,920.00	£27,450.00	6E
2.0TDI 140PS 4MOTION®		£22,865.00	£27,438.00	£23,720.00	£28,410.00	6E
2.0BiTDI 180PS		£22,265.00	£26,718.00	£23,120.00	£27,690.00	6E
2.0BiTDI 180PS DSG		£23,665.00	£28,398.00	£24,520.00	£29,370.00	10E
2.0BiTDI 180PS 4MOTION®		£24,465.00	£29,358.00	£25,320.00	£30,330.00	10E
2.0BiTDI 180PS DSG 4MOTION®		£25,865.00	£31,038.00	£26,720.00	£32,010.00	7E
T32		2.0TDI 102PS	£19,515.00	£23,418.00	£20,370.00	£24,390.00
	2.0TDI 140PS	£21,015.00	£25,218.00	£21,870.00	£26,190.00	7E
	2.0TDI 140PS DSG	£22,415.00	£26,898.00	£23,270.00	£27,870.00	10E
	2.0TDI 140PS 4MOTION®	£23,215.00	£27,858.00	£24,070.00	£28,830.00	13E
	2.0BiTDI 180PS	£22,615.00	£27,138.00	£23,470.00	£28,110.00	10E
	2.0BiTDI 180PS DSG	£24,015.00	£28,818.00	£24,870.00	£29,790.00	11E
	2.0BiTDI 180PS 4MOTION®	£24,815.00	£29,778.00	£25,670.00	£30,750.00	11E
	2.0BiTDI 180PS DSG 4MOTION®	£26,215.00	£31,458.00	£27,070.00	£32,430.00	11E

+ Trims Add even more features to your Transporter van

	Trendline	Highline*
Additional price (ex VAT)	£1,100	£2,200
VAT	£220	£440
Total additional RRP	£1,320	£2,640

Simply add the price for your chosen trim to the overall vehicle price

* Highline trim not currently available with T32 models. Please ask your Van Centre for further details

See pages 24-27 for full trim details



Finance that makes buying a Volkswagen even more affordable

Our extensive range of finance packages can make driving a Volkswagen van a reality. Speak to us today – you may be surprised at how much you can afford.

To find the nearest Van Centre to you, call us on 0800 717131 or visit www.volkswagen-vans.co.uk

Transporter kombi



Model	Engine/transmission	Basic (ex VAT)	Total (inc VAT)	Total RRP including OTR*		Insurance group†
				(ex VAT)	(inc VAT)	
Short wheelbase						
T30	2.0TDI 84PS	£19,410.00	£23,292.00	£20,265.00	£24,264.00	6E
	2.0TDI 102PS	£20,160.00	£24,192.00	£21,015.00	£25,164.00	8E
	2.0TDI 140PS	£21,660.00	£25,992.00	£22,515.00	£26,964.00	8E
	2.0TDI 140PS DSG	£23,060.00	£27,672.00	£23,915.00	£28,644.00	10E
	2.0TDI 140PS 4MOTION®	£23,860.00	£28,632.00	£24,715.00	£29,604.00	10E
	2.0BiTDI 180PS	£23,260.00	£27,912.00	£24,115.00	£28,884.00	10E
	2.0BiTDI 180PS DSG	£24,660.00	£29,592.00	£25,515.00	£30,564.00	10E
	2.0BiTDI 180PS 4MOTION®	£25,460.00	£30,552.00	£26,315.00	£31,524.00	10E
	2.0BiTDI 180PS DSG 4MOTION®	£26,860.00	£32,232.00	£27,715.00	£33,204.00	10E
	T32	2.0TDI 102PS	£20,510.00	£24,612.00	£21,365.00	£25,584.00
2.0TDI 140PS		£22,010.00	£26,412.00	£22,865.00	£27,384.00	7E
2.0TDI 140PS DSG		£23,410.00	£28,092.00	£24,265.00	£29,064.00	8E
2.0TDI 140PS 4MOTION®		£24,210.00	£29,052.00	£25,065.00	£30,024.00	11E
2.0BiTDI 180PS		£23,610.00	£28,332.00	£24,465.00	£29,304.00	12E
2.0BiTDI 180PS DSG		£25,010.00	£30,012.00	£25,865.00	£30,984.00	12E
2.0BiTDI 180PS 4MOTION®		£25,810.00	£30,972.00	£26,665.00	£31,944.00	13E
2.0BiTDI 180PS DSG 4MOTION®		£27,210.00	£32,652.00	£28,065.00	£33,624.00	11E
Long wheelbase						
T32	2.0TDI 102PS	£21,000.00	£25,200.00	£21,855.00	£26,172.00	7E
	2.0TDI 140PS	£22,500.00	£27,000.00	£23,355.00	£27,972.00	7E
	2.0TDI 140PS DSG	£23,900.00	£28,680.00	£24,755.00	£29,652.00	12E
	2.0TDI 140PS 4MOTION®	£24,700.00	£29,640.00	£25,555.00	£30,612.00	13E
	2.0BiTDI 180PS	£24,100.00	£28,920.00	£24,955.00	£29,892.00	12E
	2.0BiTDI 180PS DSG	£25,500.00	£30,600.00	£26,355.00	£31,572.00	12E
	2.0BiTDI 180PS 4MOTION®	£26,300.00	£31,560.00	£27,155.00	£32,532.00	13E
	2.0BiTDI 180PS DSG 4MOTION®	£27,700.00	£33,240.00	£28,555.00	£34,212.00	TBC

+ Trims Add even more features to your Transporter Kombi

	Trendline	Highline*
Additional price (ex VAT)	£1,250	£2,450
VAT	£250	£490
Total additional RRP	£1,500	£2,940

Simply add the price for your chosen trim to the overall vehicle price

* Highline trim not currently available with T32 models. Please ask your Van Centre for further details

(See pages 24-27 for full trim details)

Transporter Sportline



Model	Engine/transmission	Basic (ex VAT)	Total (inc VAT)	Total retail including OTR*		Insurance group†
				(ex VAT)	(inc VAT)	
Sportline panel van						
Short wheelbase						
T32	2.0TDI 180PS Sportline	£28,875.00	£34,650.00	£29,730.00	£35,622.00	13E
	2.0TDI 180PS Sportline DSG	£30,275.00	£36,330.00	£31,130.00	£37,302.00	13E
Long wheelbase						
T32	2.0TDI 180PS Sportline	£29,365.00	£35,238.00	£30,220.00	£36,210.00	14E
	2.0TDI 180PS Sportline DSG	£30,765.00	£36,918.00	£31,620.00	£37,890.00	14E
Sportline kombi						
Short wheelbase						
T32	2.0TDI 180PS Sportline	£30,760.00	£36,912.00	£31,615.00	£37,884.00	13E
	2.0TDI 180PS Sportline DSG	£32,160.00	£38,592.00	£33,015.00	£39,564.00	13E
Long wheelbase						
T32	2.0TDI 180PS Sportline	£31,250.00	£37,500.00	£32,105.00	£38,472.00	13E
	2.0TDI 180PS Sportline DSG	£32,650.00	£39,180.00	£33,505.00	£40,152.00	13E

(See page 28 for full Sportline trim details)

* For full details of VED (Vehicle Excise Duty) bands and other costs included in the On The Road package, please ask your Van Centre.

† As advised by the Association of British Insurers (ABI). Please see www.thatcham.org/abigrouprating for more information



Finance plans with fixed costs help you budget for the life of your vehicle

With fixed monthly rental costs, Contract Hire is perfect if you want to budget for the future. You can also include a service and maintenance plan with your agreement to ensure there's no unforeseen expenditure.

To find the nearest Van Centre to you, call us on 0800 717131 or visit www.volkswagen-vans.co.uk

Transporter BlueMotion Technology



Model	Engine/transmission	Basic (ex VAT)	Total (inc VAT)	Total RRP including OTR*		Insurance group†
				(ex VAT)	(inc VAT)	
Panel van						
BlueMotion – short wheelbase						
T27	2.0TDI 114PS	£19,035.00	£22,842.00	£19,890.00	£23,814.00	8E
BlueMotion Technology – short wheelbase						
T26	2.0TDI 84PS	£17,555.00	£21,066.00	£18,410.00	£22,038.00	8E
	2.0TDI 114PS	£18,605.00	£22,326.00	£19,460.00	£23,298.00	8E
T28	2.0TDI 84PS	£17,905.00	£21,486.00	£18,760.00	£22,458.00	8E
	2.0TDI 114PS	£18,955.00	£22,746.00	£19,810.00	£23,718.00	8E
T30	2.0TDI 84PS	£18,255.00	£21,906.00	£19,110.00	£22,878.00	8E
	2.0TDI 114PS	£19,305.00	£23,166.00	£20,160.00	£24,138.00	8E
T32	2.0TDI 114PS	£19,655.00	£23,586.00	£20,510.00	£24,558.00	9E
BlueMotion Technology – long wheelbase						
T28	2.0TDI 84PS	£18,395.00	£22,074.00	£19,250.00	£23,046.00	8E
	2.0TDI 114PS	£19,445.00	£23,334.00	£20,300.00	£24,306.00	8E
T30	2.0TDI 84PS	£18,745.00	£22,494.00	£19,600.00	£23,466.00	8E
	2.0TDI 114PS	£19,795.00	£23,754.00	£20,650.00	£24,726.00	8E
T32	2.0TDI 114PS	£20,145.00	£24,174.00	£21,000.00	£25,146.00	10E
Kombi						
BlueMotion Technology – short wheelbase						
T30	2.0TDI 84PS	£19,740.00	£23,688.00	£20,595.00	£24,660.00	8E
	2.0TDI 114PS	£20,790.00	£24,948.00	£21,645.00	£25,920.00	9E
T32	2.0TDI 114PS	£21,140.00	£25,368.00	£21,995.00	£26,340.00	10E
BlueMotion Technology – long wheelbase						
T32	2.0TDI 114PS	£21,630.00	£25,956.00	£22,485.00	£26,928.00	10E

+ Trims Add even more features to your Transporter BlueMotion Technology van

	Kombi		Panel van	
	Trendline	Highline	Trendline	Highline
Additional price (ex VAT)	£1,250	£2,450	£1,100	£2,200
VAT	£250	£490	£220	£440
Total additional RRP (inc VAT)	£1,500	£2,940	£1,320	£2,640

See pages 24-27 for full trim details

Simply add the price for your chosen trim to the overall vehicle price * Highline trim not currently available with T32 models, please ask your Van Centre for further details



Lots of finance options to suit your needs

Now you've chosen a Volkswagen to be part of your team, let's create a finance package that's tailored to the needs of your business. Have a look at the Flexible Finance brochure to find out more.

Transporter chassis and double cab



Model	Engine/transmission	Basic (ex VAT)	Total (inc VAT)	Total retail including OTR*		Insurance group†
				(ex VAT)	(inc VAT)	
Chassis cab – long wheelbase						
T30	2.0TDI 84PS	£17,525.00	£21,030.00	£18,380.00	£22,002.00	5E
	2.0TDI 102PS	£18,275.00	£21,930.00	£19,130.00	£22,902.00	6E
	2.0TDI 140PS	£19,775.00	£23,730.00	£20,630.00	£24,702.00	6E
	2.0TDI 140PS DSG	£21,175.00	£25,410.00	£22,030.00	£26,382.00	6E
	2.0TDI 140PS 4MOTION*	£21,975.00	£26,370.00	£22,830.00	£27,342.00	6E
Double cab – long wheelbase						
T30	2.0TDI 102PS	£19,575.00	£23,490.00	£20,430.00	£24,462.00	6E
	2.0TDI 140PS	£21,075.00	£25,290.00	£21,930.00	£26,262.00	6E
	2.0TDI 140PS DSG	£22,475.00	£26,970.00	£23,330.00	£27,942.00	6E
	2.0TDI 140PS 4MOTION*	£23,275.00	£27,930.00	£24,130.00	£28,902.00	7E



Want the latest model? Try a hire agreement

If you can't live without a new vehicle every couple of years and you want to drive the latest models, our hire agreements can give you as much flexibility as you need.

To find the nearest Van Centre to you, call us on 0800 717131 or visit www.volkswagen-vans.co.uk

* For full details of VED (Vehicle Excise Duty) bands and other costs included in the On The Road package, please ask your Van Centre.
† As advised by the Association of British Insurers (ABI). Please see www.thatcham.org/abigrouprating for more information

Options

Get the best from your van with our quality options

ways to get even more from your Transporter

Want your van to stand out from the crowd or add items to make it do its job better? We've got all the options you need



Alloy wheels and tyres

Alloy wheels and metallic or pearlescent paints are great for adding a really stylish look to your van, and can help it to retain more of its value when you come to sell it in a few years. Our 18" Canberra wheels come in a set of four with a tyre repair kit and 255/45 R18 tyres, and are available for all Transporter models. There are lots of other wheel designs, too.

p44

Cargo bay

We have lots of options for upgrading your cargo bay, including a choice of bulkheads that separate the load space from the cab, load-lashing rails to help secure your cargo, and floor covers and plywood side-lining to protect the interior of your van (and your load) from bumps and scrapes.



p52



p48

Body and chassis

If you want to get more into your Transporter, optional roof packs add extra height and volume, while a choice of side- and rear-door options make loading and unloading easier. You can add another side door, a rear tailgate or rear doors that open 250° for unobstructed access.



p46

Audio, phone and sat-nav

We've got stereo systems to keep you entertained, Bluetooth phone connectivity so you can stay in touch and sat-nav to keep you on the right road. Some of our stereos combine audio and sat-nav – the four-speaker RNS510, for example, with voice or 6.5" touch-screen control. It has an FM/AM radio with RDS (radio data system) for traffic updates, a CD/DVD player, a 30GB hard drive and an aux-in socket. Maps for western Europe are included.



Comfort and convenience

You're often in your Transporter's cab for large chunks of the day, so it has to suit your needs. Customise it with a sunroof, extra storage areas, carpet flooring, upgraded upholstery or one of a variety of seat packs for you and your crew. You can also add cruise control, which can help to save fuel by keeping your speed constant.

p54

Safety and security

The Transporter has lots of standard safety features, but you can add more, including extra airbags, tyre-pressure warning indicators, fog lights and visibility packs. You could also pick lane-change assist to help with overtaking, or parking sensors or an alarm pack.

Heating and ventilation

In summer, you want to keep you and your workmates cool, so we offer a variety of air-conditioning systems for panel vans and kombis. You can also pick manual or timer-activated heaters for the rear passenger area (kombi models) – ideal for early-morning winter starts.





p62

Electrical

Whether you need the convenience of electric door mirrors or a trip computer, or important equipment such as tachographs, there's something for you. We can also provide upgraded alternators and batteries to cope with any heavy-duty electrical options or accessories you might need.

Options: Paint

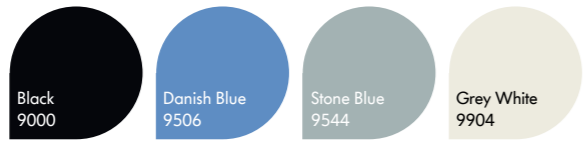

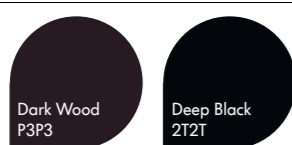



You want your van – and your business – to make an impression.
The most striking way to do that is to opt for a distinctive paint finish



		Standard		Trendline		Highline		Sportline	
		Basic (ex VAT)	Total RRP (inc VAT)	Basic (ex VAT)	Total RRP (inc VAT)	Basic (ex VAT)	Total RRP (inc VAT)	Basic (ex VAT)	Total RRP (inc VAT)
Standard A great range of colours, available at no extra cost		S	S	-	-	-	-	-	-
Optional paints If you're after something a bit more particular...		£295.00	£354.00	-	-	-	-	-	-
Trendline/Highline paints If you've chosen one of our new, well-equipped trims, why not pick a special colour to go with it?		-	-	S	S	S	S	-	-
Pearlescent paints Tiny flecks of material in the paint reflect light, giving your vehicle a unique look		£495.00	£594.00	£495.00	£594.00	£495.00	£594.00	-	-

		Standard		Trendline		Highline		Sportline	
		Basic (ex VAT)	Total RRP (inc VAT)	Basic (ex VAT)	Total RRP (inc VAT)	Basic (ex VAT)	Total RRP (inc VAT)	Basic (ex VAT)	Total RRP (inc VAT)
Metallic paints Mark out your van and your business from the competition with a smart metallic paint finish		£495.00	£594.00	£495.00	£594.00	£495.00	£594.00	-	-
Transporter Sportline Two of the most popular metallic paints for the Transporter come as standard at no extra cost		-	-	-	-	-	-	S	S
Exclusive paint option for the Transporter Sportline Candy White with Gloss Black roof		-	-	-	-	-	-	£450.00	£540.00
Transporter BlueMotion Show the world that you're driving our most fuel-efficient model with this exclusive no-cost paint option		£495.00	£594.00	-	-	-	-	-	-

Options: Alloy wheels and tyres

Complete your van's sleek, sharp look with a set of stylish alloy wheels

			Standard		Trendline		Highline		Sportline	
			Basic (ex VAT)	Total RRP (inc VAT)	Basic (ex VAT)	Total RRP (inc VAT)	Basic (ex VAT)	Total RRP (inc VAT)	Basic (ex VAT)	Total RRP (inc VAT)
16" Colmar Set of four 6.5J x 16 alloys with 215/65 R16 tyres. Not compatible with 180PS, T32 or BlueMotion models		Panel van	£605.00	£726.00	£515.00	£618.00	S	S	-	-
		Kombi	£605.00	£726.00	£515.00	£618.00	S	S	-	-
		Chassis cab/double cab	£605.00	£726.00	-	-	-	-	-	-
16" Miyato Set of four 6.5J x 16 alloys with 215/65 R16 tyres. Not compatible with all-weather tyres, BlueMotion, 180PS or T32 models		Panel van	£510.00	£612.00	£415.00	£498.00	O	O	-	-
		Kombi	£510.00	£612.00	£415.00	£498.00	O	O	-	-
		Chassis cab/double cab	£510.00	£612.00	-	-	-	-	-	-
17" Thunder Set of four 7J x17 alloys with 235/55 R17 tyres. Not compatible with all-weather tyres, 180PS engines, BlueMotion, BlueMotion Technology or T32 models		Panel van	£965.00	£1,158.00	£865.00	£1,038.00	£360.00	£432.00	-	-
		Kombi	£965.00	£1,158.00	£865.00	£1,038.00	£360.00	£432.00	-	-
		Chassis cab/double cab	£965.00	£1,158.00	-	-	-	-	-	-
17" Thunder (BlueMotion Technology only) Set of four 7J x17 alloys with 235/55 R17 all-weather tyres. Not compatible with T32 models		Panel van	£1,060.00	£1,272.00	£960.00	£1,152.00	£455.00	£546.00	-	-
		Kombi	£1,060.00	£1,272.00	£960.00	£1,152.00	£455.00	£546.00	-	-
		Chassis cab/double cab	-	-	-	-	-	-	-	-
17" Thunder (180PS engines only) Set of four 7J x17 alloys with 235/55 R17 tyres. Not compatible with all-weather tyres, BlueMotion, BlueMotion Technology or T32 models		Panel van	£375.00	£450.00	£375.00	£450.00	S	S	-	-
		Kombi	£375.00	£450.00	£375.00	£450.00	S	S	-	-
		Chassis cab/double cab	-	-	-	-	-	-	-	-
18" Canberra (140PS engines only) Set of four 8J x18 alloys with 255/45 R18 tyres. Tyre repair kit in lieu of spare wheel. Not compatible with all-weather tyres, BlueMotion, BlueMotion Technology or T32 models		Panel van	£1,955.00	£2,346.00	£1,915.00	£2,298.00	£1,500.00	£1,800.00	-	-
		Kombi	£1,955.00	£2,346.00	£1,915.00	£2,298.00	£1,500.00	£1,800.00	-	-
		Chassis cab/double cab	-	-	-	-	-	-	-	-

			Standard		Trendline		Highline		Sportline	
			Basic (ex VAT)	Total RRP (inc VAT)	Basic (ex VAT)	Total RRP (inc VAT)	Basic (ex VAT)	Total RRP (inc VAT)	Basic (ex VAT)	Total RRP (inc VAT)
18" Canberra (180PS engines only) Set of four 8J x18 alloys with 255/45 R18 tyres. Tyre repair kit in lieu of spare wheel. Not compatible with all-weather tyres, BlueMotion, BlueMotion Technology or T32 models		Panel van	£1,395.00	£1,674.00	£1,395.00	£1,674.00	£1,100.00	£1,320.00	-	-
		Kombi	£1,395.00	£1,674.00	£1,395.00	£1,674.00	£1,100.00	£1,320.00	-	-
		Chassis cab/double cab	-	-	-	-	-	-	-	-
18" Sportline (Transporter Sportline only) Set of four 8J x18 alloys with 255/45 R18 tyres. Available in Brilliant Silver (top) or Black (below)		Panel van	-	-	-	-	-	-	S	S
		Kombi	-	-	-	-	-	-	S	S
		Chassis cab/double cab	-	-	-	-	-	-	-	-
		Panel van	-	-	-	-	-	-	-	-
		Kombi	-	-	-	-	-	-	-	-
		Chassis cab/double cab	-	-	-	-	-	-	-	-

All-weather tyres

All-weather tyres

Set of four (215/65 R16)

Certain criteria apply. Ask your Van Centre for details, and to check that you're using the correct tyres for your vehicle specification

All-weather tyres



Set of four (215/65 R16) – 180PS engines only

Not compatible with alloy wheels





			Standard		Trendline		Highline		Sportline	
			Basic (ex VAT)	Total RRP (inc VAT)	Basic (ex VAT)	Total RRP (inc VAT)	Basic (ex VAT)	Total RRP (inc VAT)	Basic (ex VAT)	Total RRP (inc VAT)
All-weather tyres Set of four (215/65 R16)		Panel van	£200.00	£240.00	£200.00	£240.00	-	-	-	-
		Kombi	£200.00	£240.00	£200.00	£240.00	-	-	-	-
		Chassis cab/double cab	£200.00	£240.00	-	-	-	-	-	-
All-weather tyres Set of four (215/65 R16) – 180PS engines only		Panel van	£95.00	£114.00	£95.00	£114.00	-	-	-	-
		Kombi	£95.00	£114.00	£95.00	£114.00	-	-	-	-
		Chassis cab/double cab	-	-	-	-	-	-	-	-

Options: Audio, phone and satellite-navigation

Choose from a range of entertainment systems for great music on the go, or opt for one of our touch-screen satellite-navigation systems

				Standard		Trendline		Highline		Sportline		
				Basic (ex VAT)	Total RRP (inc VAT)	Basic (ex VAT)	Total RRP (inc VAT)	Basic (ex VAT)	Total RRP (inc VAT)	Basic (ex VAT)	Total RRP (inc VAT)	
Audio												
RCD 210		A great basic system for music on the go. Listen to the AM/FM radio or play your own music on the CD player.	<ul style="list-style-type: none"> Two speakers FM/AM radio Single CD player 	Panel van Kombi Chassis/double cab	S S S	S S S	- - -	- - -	- - -	- - -	- - -	
RCD 310		This radio includes two extra speakers, an aux-in for external devices and the option of Digital Audio Broadcast (DAB) radio (below).	<ul style="list-style-type: none"> Four speakers FM/AM radio Single CD player MP3-file compatible Aux-in for external devices 	Panel van Kombi Chassis/double cab	£75.00 £75.00 £75.00	£90.00 £50.00 £90.00	S S -	S S -	S S -	S S -	- - -	
DAB - DIGITAL AUDIO RECEPTION FOR RCD 310		DAB (Digital Audio Broadcasting) offers more stations, a clearer signal and information about what's playing.			£240.00	£288.00	£165.00	£198.00	£165.00	£198.00	-	-
Phone												
BLUETOOTH CONNECTIVITY		Go hands-free with compatible devices. This system includes a multi-function display.		RCD 210/RCD 310 RNS 315 Premium *	£230.00 £230.00 £370.00	£276.00 £276.00 £444.00	S - £120.00	S - £144.00	S - £120.00	S - £144.00	S S -	S S -

* N.B. Premium Bluetooth® requires radio upgrade and multi-function steering wheel

				Standard		Trendline		Highline		Sportline		
				Basic (ex VAT)	Total RRP (inc VAT)	Basic (ex VAT)	Total RRP (inc VAT)	Basic (ex VAT)	Total RRP (inc VAT)	Basic (ex VAT)	Total RRP (inc VAT)	
Satellite-navigation												
RNS 315		A great sat-nav to help you get where you're going efficiently. It includes RDS (Radio Data System) for live traffic updates.	<ul style="list-style-type: none"> 5" colour touch-screen 6GB flash memory Two speakers FM/AM radio with RDS Single CD player Aux-in for external devices SD card reader 	Panel van Kombi Chassis/double cab	£560.00 £560.00 £560.00	£672.00 £672.00 £672.00	£560.00 £560.00 -	£672.00 £672.00 -	£560.00 £560.00 -	£672.00 £672.00 -	- - -	- - -
RNS 510		This sat-nav system has voice control and a 6.5" colour touch-screen for easy use.	<ul style="list-style-type: none"> 6.5" colour touch-screen Voice control 30GB hard drive Four speakers FM/AM radio with RDS Single CD player Aux-in and SD card reader 	Panel van Kombi Chassis/double cab	£1,845.00 £1,845.00 £1,845.00	£2,214.00 £2,214.00 £2,214.00	£1,700.00 £1,700.00 -	£2,040.00 £2,040.00 -	£1,700.00 £1,700.00 -	£2,040.00 £2,040.00 -	- - -	- - -
RNS 510 WITH DAB+		This sat-nav system has voice control, a 6.5" colour touch-screen for easy use and DAB digital audio reception for more stations and clearer signal.	<ul style="list-style-type: none"> 6.5" colour touch-screen Voice control 30GB hard drive Four speakers FM/AM radio with RDS Single CD player Aux-in and SD card reader DAB audio reception 	Panel van Kombi Chassis/double cab	£1,900.00 £1,900.00 £1,900.00	£2,280.00 £2,280.00 £2,280.00	£1,900.00 £1,900.00 -	£2,280.00 £2,280.00 -	£1,900.00 £1,900.00 -	£2,280.00 £2,280.00 -	- - -	- - -
KENWOOD MULTIMEDIA		Perfect for sat-nav, phone calls, music or watching DVDs. You can link it to your phone via Bluetooth® and it can handle text messages from selected devices.	<ul style="list-style-type: none"> 7" colour touch-screen Built-in Garmin sat-nav FM/AM radio with RDS Single CD/DVD player USB for external devices Bluetooth® connectivity 	Panel van Kombi Chassis/double cab	- - -	- - -	- - -	- - -	- - -	- - -	S S -	S S -

- not available S standard O available as a no-cost option

Options: Body, chassis and windows

Tailor your van to the specific demands of your job with our body and chassis options, including rear and side door packs, towbars and roof rails

		Standard		Trendline		Highline		Sportline	
		Basic (ex VAT)	Total RRP (inc VAT)	Basic (ex VAT)	Total RRP (inc VAT)	Basic (ex VAT)	Total RRP (inc VAT)	Basic (ex VAT)	Total RRP (inc VAT)
Body-coloured bumpers									
Body-coloured bumpers *	Panel van	£435.00	£522.00	S	S	S	S	-	-
	Kombi	£435.00	£522.00	S	S	S	S	-	-
	Chassis cab/double cab	-	-	-	-	-	-	-	-
Roof options									
Medium roof (white) Not compatible with BlueMotion models or medium roof (body-coloured)	Panel van	£440.00	£528.00	£440.00	£528.00	£440.00	£528.00	-	-
	Kombi	£440.00	£528.00	£440.00	£528.00	£440.00	£528.00	-	-
	Chassis cab/double cab	-	-	-	-	-	-	-	-
Medium roof (body-coloured) * Not compatible with alarm with interior monitoring, roof load-rack preparation, sunroof or BlueMotion models	Panel van	£535.00	£642.00	£535.00	£642.00	£535.00	£642.00	-	-
	Kombi	£535.00	£642.00	£535.00	£642.00	£535.00	£642.00	-	-
	Chassis cab/double cab	-	-	-	-	-	-	-	-
High roof (white) † Includes high rear wing doors without windows	Panel van	£755.00	£906.00	£755.00	£906.00	£755.00	£906.00	-	-
	Kombi	£865.00	£1,038.00	£865.00	£1,038.00	£865.00	£1,038.00	-	-
	Chassis cab/double cab	-	-	-	-	-	-	-	-
High roof (body-coloured) * † Includes rear wing doors without windows	Panel van	£870.00	£1,044.00	£870.00	£1,044.00	£870.00	£1,044.00	-	-
	Kombi	£1,060.00	£1,272.00	£1,060.00	£1,272.00	£1,060.00	£1,272.00	-	-
	Chassis cab/double cab	-	-	-	-	-	-	-	-
High roof (white) † Includes rear wing doors with heated rear windows and wash/wipe. Not available if your vehicle has both DSG and 4MOTION®	Panel van	£855.00	£1,026.00	£855.00	£1,026.00	£855.00	£1,026.00	-	-
	Kombi	£890.00	£1,068.00	£890.00	£1,068.00	£890.00	£1,068.00	-	-
	Chassis cab/double cab	-	-	-	-	-	-	-	-
High roof (body-coloured) * † Includes rear wing doors with heated rear windows and wash/wipe	Panel van	£970.00	£1,164.00	£970.00	£1,164.00	£970.00	£1,164.00	-	-
	Kombi	£1,005.00	£1,206.00	£1,005.00	£1,206.00	£1,005.00	£1,206.00	-	-
	Chassis cab/double cab	-	-	-	-	-	-	-	-

* Please confirm colour availability of body-coloured options with your Van Centre

† Not compatible with certain other options, including alarms, roof load-rack preparation, sunroofs, alternative side door options and some gearbox/drivetrain options. Please check with your Van Centre before ordering



Check your roof height

Roof packs are great for adding load height and volume, but make sure they suit where you work. Height restrictions in city-centre car parks could be as low as 1.8m. To check the height of your van, see the data section on pages 66-85.

		Standard		Trendline		Highline		Sportline	
		Basic (ex VAT)	Total RRP (inc VAT)	Basic (ex VAT)	Total RRP (inc VAT)	Basic (ex VAT)	Total RRP (inc VAT)	Basic (ex VAT)	Total RRP (inc VAT)
Rear doors									
Rear wing doors with 250° hinges	Panel van	£265.00	£318.00	£265.00	£318.00	£265.00	£318.00	-	-
	Kombi	£265.00	£318.00	£265.00	£318.00	£265.00	£318.00	-	-
	Chassis cab/double cab	-	-	-	-	-	-	-	-
Rear wing doors with heated rear windows and wash/wipe Included with high roof with wing doors and windows	Panel van	£100.00	£120.00	£100.00	£120.00	£100.00	£120.00	-	-
	Kombi	£160.00	£192.00	£160.00	£192.00	£160.00	£192.00	-	-
	Chassis cab./double cab	-	-	-	-	-	-	-	-
Rear wing doors without windows Included with high roof with wing doors without windows	Panel van	S	S	S	S	S	S	-	-
	Kombi	£50.00	£60.00	£50.00	£60.00	£50.00	£60.00	-	-
	Chassis cab./double cab	-	-	-	-	-	-	-	-
Tailgate with heated rear window and wash/wipe Not compatible with high-roof options	Panel van	£100.00	£120.00	£100.00	£120.00	£100.00	£120.00	£100.00	£120.00
	Kombi	S	S	S	S	S	S	S	S
	Chassis cab/double cab	-	-	-	-	-	-	-	-
Tailgate without window Not compatible with high-roof options	Panel van	O	O	O	O	O	O	S	S
	Kombi	-£75.00	-£90.00	-£75.00	-£90.00	-£75.00	-£90.00	-	-
	Chassis cab/double cab	-	-	-	-	-	-	-	-
Side doors									
Nearside sliding door Replaces standard-fit offside sliding door	Panel van	O	O	O	O	O	O	-	-
	Kombi	-	-	-	-	-	-	-	-
	Chassis cab/double cab	-	-	-	-	-	-	-	-
Offside and nearside sliding doors Not available on BlueMotion models, or with roof options	Panel van	£440.00	£528.00	£440.00	£528.00	£440.00	£528.00	£440.00	£528.00
	Kombi	£440.00	£528.00	£440.00	£528.00	£440.00	£528.00	£440.00	£528.00
	Chassis cab/double cab	-	-	-	-	-	-	-	-
Offside and nearside sliding doors with power latching Not compatible with air-conditioning (cab only), alarm packs or high-roof options	Panel van	-	-	-	-	-	-	-	-
	Kombi	£610.00	£732.00	£610.00	£732.00	£610.00	£732.00	-	-
	Chassis cab/double cab	-	-	-	-	-	-	-	-



Choose your rear doors

Transporter panel vans come with unglazed rear wing doors, while the kombi is fitted with a tailgate with a heated window and wash/wipe. You can choose what doors your van has, though, including wing doors with 250° hinges for even easier access.



Fit an extra side door

The Transporter panel van comes with a sliding door on the nearside as standard. Fitting a side door on the offside lets you access your load from the pavement, no matter what side of the road you have to park on.

Options: Body, chassis and windows (cont.)

		Standard		Trendline		Highline		Sportline	
		Basic (ex VAT)	Total RRP (inc VAT)	Basic (ex VAT)	Total RRP (inc VAT)	Basic (ex VAT)	Total RRP (inc VAT)	Basic (ex VAT)	Total RRP (inc VAT)
Towing									
Towbar preparation, with socket	Panel van	£160.00	£192.00	£160.00	£192.00	£160.00	£192.00	–	–
	Kombi	£160.00	£192.00	£160.00	£192.00	£160.00	£192.00	–	–
	Chassis cab/double cab	–	–	–	–	–	–	–	–
Fixed ball with 13-pin socket An adapter is available from Van Centres to allow connection to twin 7-pin sockets	Panel van	£375.00	£450.00	£375.00	£450.00	£375.00	£450.00	–	–
	Kombi	£375.00	£450.00	£375.00	£450.00	£375.00	£450.00	–	–
	Chassis cab/double cab	£357.00	£450.00	£375.00	£450.00	£375.00	£450.00	–	–
Removable ball with 13-pin socket An adapter is available from Van Centres to allow connection to twin 7-pin sockets	Panel van	£470.00	£564.00	£470.00	£564.00	£470.00	£564.00	£470.00	£564.00
	Kombi	£470.00	£564.00	£470.00	£564.00	£470.00	£564.00	£470.00	£564.00
	Chassis cab/double cab	–	–	–	–	–	–	–	–



Useful towing tips

1. Watch your weight

Make sure your trailer doesn't exceed your vehicle's maximum towing limit or its gross train weight. You'll find these in your handbook

2. Load well, stay stable

For stability, put heavy items low down over the trailer axle. Ensure the trailer has a slightly nose-down attitude, but that it doesn't exceed the van's or trailer's nose weight limit.

3. Check your tyres

Your van's tyres may need to be inflated to a greater pressure to cope with the extra load. Check your vehicle's handbook.

		Standard		Trendline		Highline		Sportline	
		Basic (ex VAT)	Total RRP (inc VAT)	Basic (ex VAT)	Total RRP (inc VAT)	Basic (ex VAT)	Total RRP (inc VAT)	Basic (ex VAT)	Total RRP (inc VAT)
Other body and chassis options									
Roof load-rack preparation Not compatible with medium or high roof options or BlueMotion model	Panel van	£75.00	£90.00	£75.00	£90.00	£75.00	£90.00	–	–
	Kombi	£75.00	£90.00	£75.00	£90.00	£75.00	£90.00	–	–
	Chassis cab/double cab	–	–	–	–	–	–	–	–
Mud flaps – front and rear Not compatible with BlueMotion model	Panel van	£95.00	£114.00	£95.00	£114.00	£95.00	£114.00	£95.00	£114.00
	Kombi	£95.00	£114.00	£95.00	£114.00	£95.00	£114.00	£95.00	£114.00
	Chassis cab/double cab	£95.00	£114.00	–	–	–	–	–	–
Differential lock Only available on 4MOTION® models	Panel van	£460.00	£552.00	£460.00	£552.00	£460.00	£552.00	–	–
	Kombi	£460.00	£552.00	£460.00	£552.00	£460.00	£552.00	–	–
	Chassis cab/double cab	£460.00	£552.00	–	–	–	–	–	–
Privacy glass	Panel van	–	–	–	–	–	–	–	–
	Kombi	£215.00	£258.00	S	S	S	S	–	–
	Chassis cab/double cab	–	–	–	–	–	–	–	–



Check your mirrors...

Always remember to readjust all of your rear-view mirrors when you load or unload your vehicle, because the angle they face will have changed.

Add Ons
Accessories to help keep your vehicle 100% Volkswagen

If you want even more choice for body and chassis upgrades, including lots of towing and roof-rack solutions, check out our Add Ons accessories range. Ask your Van Centre for a brochure, call 0800 717131 or download a copy at www.volkswagen-vans.co.uk

Options: Cargo area

A range of floor coverings, bulkheads and load-lashing rails make light work of your most challenging cargo requirements

		Standard		Trendline		Highline		Sportline	
		Basic (ex VAT)	Total RRP (inc VAT)	Basic (ex VAT)	Total RRP (inc VAT)	Basic (ex VAT)	Total RRP (inc VAT)	Basic (ex VAT)	Total RRP (inc VAT)
Bulkheads									
High bulkhead without window Includes two additional 'C' pillar load lashing rings. Dual passenger seat has fixed backrest	Panel van	£165.00	£198.00	S	S	S	S	£165.00	£198.00
	Kombi	-	-	-	-	-	-	-	-
	Chassis cab/double cab	-	-	-	-	-	-	-	-
High bulkhead with window Includes two additional 'C' pillar load lashing rings. Dual passenger seat has fixed backrest	Panel van	£195.00	£234.00	£30.00	£36.00	£30.00	£36.00	£195.00	£234.00
	Kombi	-	-	-	-	-	-	-	-
	Chassis cab/double cab	-	-	-	-	-	-	-	-
High bulkhead with sliding window Includes two additional 'C' pillar load lashing rings. Dual passenger seat has fixed backrest	Panel van	£235.00	£282.00	£75.00	£90.00	£75.00	£90.00	-	-
	Kombi	-	-	-	-	-	-	-	-
	Chassis cab/double cab	-	-	-	-	-	-	-	-
Load sidelining									
Load sidelining (hardboard) For short wheelbase vehicles. Not compatible with load-lashing rails	Panel van	£210.00	£252.00	£210.00	£252.00	£210.00	£252.00	-	-
	Kombi	-	-	-	-	-	-	-	-
	Chassis cab/double cab	-	-	-	-	-	-	-	-
Load sidelining (hardboard) For long-wheelbase vehicles. Not compatible with load-lashing rails	Panel van	£240.00	£288.00	£240.00	£288.00	£240.00	£288.00	-	-
	Kombi	-	-	-	-	-	-	-	-
	Chassis cab/double cab	-	-	-	-	-	-	-	-



Choose a bulkhead

Bulkheads separate the load space from the cab, giving you greater protection from shifting loads, less noise from the cargo bay and a warmer cab in winter.

		Standard		Trendline		Highline		Sportline	
		Basic (ex VAT)	Total RRP (inc VAT)	Basic (ex VAT)	Total RRP (inc VAT)	Basic (ex VAT)	Total RRP (inc VAT)	Basic (ex VAT)	Total RRP (inc VAT)
Load-lashing rails									
Load-lashing rails For short-wheelbase vehicles	Panel van	£330.00	£396.00	£330.00	£396.00	£330.00	£396.00	-	-
	Kombi	-	-	-	-	-	-	-	-
	Chassis cab/double cab	-	-	-	-	-	-	-	-
Load-lashing rails For long-wheelbase vehicles	Panel van	£400.00	£480.00	£400.00	£480.00	£400.00	£480.00	-	-
	Kombi	-	-	-	-	-	-	-	-
	Chassis cab/double cab	-	-	-	-	-	-	-	-
Load-floor covering									
Rubber load-floor covering For short-wheelbase vehicles. Includes step light	Panel van	£125.00	£150.00	£125.00	£150.00	£125.00	£150.00	£125.00	£150.00
	Kombi	-	-	-	-	-	-	-	-
	Chassis/double cab	-	-	-	-	-	-	-	-
Rubber load-floor covering For long-wheelbase vehicles. Includes step light	Panel van	£145.00	£174.00	£145.00	£174.00	£145.00	£174.00	£145.00	£174.00
	Kombi	-	-	-	-	-	-	-	-
	Chassis/double cab	-	-	-	-	-	-	-	-



Get the right cover

A rubber load-floor covering helps items to bed in, preventing them from shifting around.

Add Ons

Accessories to help keep your vehicle 100% Volkswagen

If you want even more choice for cargo bay storage and protection check out our Add Ons accessories range, which includes plying, boot-liners and load nets. Ask your Van Centre for a brochure, call 0800 717131 or download a copy at www.volkswagen-vans.co.uk

Options: Comfort and convenience

From cruise control to a multi-function steering wheel, there's a range of features to make driving more comfortable

		Standard		Trendline		Highline		Sportline	
		Basic (ex VAT)	Total RRP (inc VAT)	Basic (ex VAT)	Total RRP (inc VAT)	Basic (ex VAT)	Total RRP (inc VAT)	Basic (ex VAT)	Total RRP (inc VAT)
Leather steering wheel, gearknob and gaiter	Panel van	£125.00	£150.00	£125.00	£150.00	S	S	-	-
	Kombi	£125.00	£150.00	£125.00	£150.00	S	S	-	-
	Chassis cab/double cab	£125.00	£150.00	-	-	-	-	-	-
Multi-function leather steering wheel, gearknob and gaiter <small>With multi-function display and radio/phone controls</small>	Panel van	£290.00	£348.00	£290.00	£348.00	£165.00	£198.00	-	-
	Kombi	£290.00	£348.00	£290.00	£348.00	£165.00	£198.00	-	-
	Chassis cab/double cab	£290.00	£348.00	-	-	-	-	-	-
Cab comfort pack <small>Includes vanity mirrors, sunglasses holder and more. Please ask your Van Centre for further details</small>	Panel van	£155.00	£186.00	S	S	S	S	£155.00	£186.00
	Kombi	£190.00	£228.00	S	S	S	S	£155.00	£186.00
	Chassis cab	£155.00	£186.00	-	-	-	-	-	-
	Double cab	£195.00	£234.00	-	-	-	-	-	-
Cruise control	Panel van	£175.00	£210.00	S	S	S	S	£175.00	£210.00
	Kombi	£175.00	£210.00	S	S	S	S	£175.00	£210.00
	Chassis cab/double cab	£175.00	£210.00	-	-	-	-	-	-
Servotronic speed-dependent power-assisted steering	Panel van	£350.00	£420.00	£350.00	£420.00	£350.00	£420.00	-	-
	Kombi	£350.00	£420.00	£350.00	£420.00	£350.00	£420.00	-	-
	Chassis cab	£350.00	£420.00	-	-	-	-	-	-
	Double cab	£195.00	£234.00	-	-	-	-	-	-
Smoking pack <small>Includes ashtray, cigarette lighter and cup holder</small>	Panel van	£15.00	£18.00	£15.00	£18.00	£15.00	£18.00	-	-
	Kombi	£15.00	£18.00	£15.00	£18.00	£15.00	£18.00	-	-
	Chassis cab/double cab	£15.00	£18.00	-	-	-	-	-	-
Sunroof † <small>Glass, electric, front</small>	Panel van	£485.00	£582.00	-	-	-	-	-	-
	Kombi	£485.00	£582.00	£485.00	£582.00	£485.00	£582.00	-	-
	Chassis cab/double cab	-	-	-	-	-	-	-	-

† Not compatible with BlueMotion models or with certain options, including some alternative roofs, bulkheads and side doors, or with rear-compartment roof ventilation/extraction option. Please check with your Van Centre before ordering



Choose cruise control

Cruise control can help reduce the fatigue and stress of sticking to speed limits on long journeys. It also helps reduce the amount of fuel you use by cutting out the acceleration and braking used to maintain a steady road speed.

		Standard		Trendline		Highline		Sportline	
		Basic (ex VAT)	Total RRP (inc VAT)	Basic (ex VAT)	Total RRP (inc VAT)	Basic (ex VAT)	Total RRP (inc VAT)	Basic (ex VAT)	Total RRP (inc VAT)
Headlight washer system <small>Includes fluid level indicator and heated washer jets</small>	Panel van	£175.00	£210.00	£175.00	£210.00	£175.00	£210.00	-	-
	Kombi	£175.00	£210.00	£175.00	£210.00	£175.00	£210.00	-	-
	Chassis cab/double cab	£175.00	£210.00	-	-	-	-	-	-
Rain sensor and automatic dimming rear-view mirror <small>Includes 'leaving/coming home' function</small>	Panel van	£190.00	£228.00	£190.00	£228.00	£190.00	£228.00	-	-
	Kombi	£190.00	£228.00	£190.00	£228.00	£190.00	£228.00	-	-
	Chassis cab/double cab	£190.00	£228.00	-	-	-	-	-	-
Xenon headlights <small>With LED daytime running lights. Includes headlamp washer system with heated front washer jets and washer fluid level indicator</small>	Panel van	£1,050.00	£1,260.00	£1,050.00	£1,260.00	£1,050.00	£1,260.00	£1,050.00	£1,260.00
	Kombi	£1,050.00	£1,260.00	£1,050.00	£1,260.00	£1,050.00	£1,260.00	£1,050.00	£1,260.00
	Chassis cab/double cab	-	-	-	-	-	-	-	-

Add Ons
Accessories to help keep your vehicle 100% Volkswagen

If you want even more choice for cab comfort and convenience, check out our Add Ons accessories range. Ask your Van Centre for a brochure, call 0800 717131 or download yourself a copy at www.volkswagen-vans.co.uk

Options: Heating and ventilation

Keep control of the temperature in your van with our heating and air-conditioning options

		Standard		Trendline		Highline		Sportline	
		Basic (ex VAT)	Total RRP (inc VAT)	Basic (ex VAT)	Total RRP (inc VAT)	Basic (ex VAT)	Total RRP (inc VAT)	Basic (ex VAT)	Total RRP (inc VAT)
Air-conditioning									
'Climatic' – cab only	Panel van	£785.00	£942.00	£785.00	£942.00	S	S	S	S
	Kombi	£785.00	£942.00	£785.00	£942.00	S	S	S	S
	Chassis cab/double cab	£785.00	£942.00	–	–	–	–	–	–
'Climatic' – front only, with rear heater	Panel van	–	–	–	–	–	–	–	–
	Kombi	£1,205.00	£1,446.00	£1,205.00	£1,446.00	£1,205.00	£1,446.00	–	–
	Chassis cab/double cab	–	–	–	–	–	–	–	–
'Climatic' – front and rear, with rear heater <small>Includes rear heater and rear roof vents</small>	Panel van	–	–	–	–	–	–	–	–
	Kombi	£1,465.00	£1,758.00	£1,465.00	£1,758.00	£1,465.00	£1,758.00	–	–
	Chassis cab/double cab	–	–	–	–	–	–	–	–
Ventilation system									
Charcoal canister	Panel van	£15.00	£18.00	£15.00	£18.00	£15.00	£18.00	–	–
	Kombi	£15.00	£18.00	£15.00	£18.00	£15.00	£18.00	–	–
	Chassis cab/double cab	£15.00	£18.00	–	–	–	–	–	–



Get an air-con recharge

You may be able to get your air-conditioning system recharged and pollen filter replaced at your nearest Van Centre to keep them working as they should. Ask your Van Centre for details.

		Standard		Trendline		Highline		Sportline	
		Basic (ex VAT)	Total RRP (inc VAT)	Basic (ex VAT)	Total RRP (inc VAT)	Basic (ex VAT)	Total RRP (inc VAT)	Basic (ex VAT)	Total RRP (inc VAT)
Heating									
Rear heater <small>Included with some air-conditioning packs</small>	Panel van	–	–	–	–	–	–	–	–
	Kombi	£430.00	£516.00	£430.00	£516.00	–	–	–	–
Parking heater with timer <small>Includes second battery</small>	Panel van	–	–	–	–	–	–	–	–
	Kombi	£1,770.00	£2,124.00	£1,770.00	£2,124.00	£1,770.00	£2,124.00	–	–
Parking heater with timer and remote control <small>Includes second battery</small>	Panel van	–	–	–	–	–	–	–	–
	Kombi	£1,975.00	£2,370.00	£1,975.00	£2,370.00	£1,975.00	£2,370.00	–	–
Roof ventilation									
Roof ventilation/extraction <small>Not compatible with interior alarm, sunroof or tyre pressure warning light. Vehicle height increased 11cm standard roof, 13cm medium and high roofs</small>	Panel van	£295.00	£354.00	£295.00	£354.00	–	–	–	–
	Kombi	£295.00	£354.00	£295.00	£354.00	–	–	–	–
	Chassis cab/double cab	–	–	–	–	–	–	–	–

Options: Seating, trim and upholstery

Improve the comfort and practicality of your Transporter with alternative seat options and a selection of upholstery finishes

		Standard		Trendline		Highline		Sportline	
		Basic (ex VAT)	Total RRP (inc VAT)	Basic (ex VAT)	Total RRP (inc VAT)	Basic (ex VAT)	Total RRP (inc VAT)	Basic (ex VAT)	Total RRP (inc VAT)
Seat options									
Heated driver and front passenger seats <small>Requires air-conditioning to be fitted</small>	Panel van	£225.00	£270.00	£225.00	£270.00	£225.00	£270.00	£370.00	£444.00
	Kombi	£225.00	£270.00	£225.00	£270.00	£225.00	£270.00	£225.00	£270.00
	Chassis cab/double cab	£225.00	£270.00	-	-	-	-	-	-
Swivelling driver and single passenger seats <small>Not compatible with side and front curtain airbags or electric four-way lumbar support</small>	Panel van	-	-	-	-	-	-	-	-
	Kombi	£315.00	£378.00	-	-	-	-	-	-
	Chassis cab/double cab	-	-	-	-	-	-	-	-
Dual passenger seat <small>Not compatible with airbags - side and front curtain</small>	Panel van	S	S	S	S	S	S	-	-
	Kombi	£180.00	£216.00	£180.00	£216.00	£180.00	£216.00	-	-
	Chassis cab/double cab	S	S	-	-	-	-	-	-
Dual passenger seat with fold-down tray in backrest <small>Not compatible with armrests and lumbar support for single passenger seat or with heated seats. Not compatible with airbags - side and front curtain</small>	Panel van	£80.00	£96.00	£80.00	£96.00	£80.00	£96.00	-	-
	Kombi	£260.00	£312.00	£260.00	£312.00	£260.00	£312.00	-	-
	Chassis cab/double cab	£80.00	£96.00	-	-	-	-	-	-
Armrests for driver's seat <small>Not compatible with swivelling seats</small>	Panel van	£55.00	£66.00	S	S	S	S	-	-
	Kombi	£55.00	£66.00	-	-	-	-	-	-
	Chassis cab/double cab	£55.00	£66.00	-	-	-	-	-	-
Armrests and lumbar support for driver and single front passenger seats <small>Also includes height adjustment for passenger seat, lumbar and height adjustment are standard on driver's seat. Not compatible with swivelling seats</small>	Panel van	£52.00	£62.40	£52.00	£62.40	£52.00	£62.40	-	-
	Kombi	£170.00	£204.00	S	S	S	S	-	-
	Chassis cab/double cab	£170.00	£204.00	-	-	-	-	-	-
Electric four-way lumbar support <small>Driver and single passenger seats</small>	Panel van	£210.00	£252.00	£210.00	£252.00	£210.00	£252.00	-	-
	Kombi	£210.00	£252.00	£175.00	£210.00	£175.00	£210.00	-	-
	Chassis cab/double cab	-	-	-	-	-	-	-	-
Electric four-way lumbar support <small>Driver's seat. Not compatible with single passenger seat</small>	Panel van	£120.00	£144.00	£120.00	£144.00	£120.00	£144.00	-	-
	Kombi	£120.00	£144.00	£90.00	£108.00	£90.00	£108.00	-	-
	Chassis cab/double cab	-	-	-	-	-	-	-	-



Pick the right upholstery

Fabric upholstery is terrifically hard-wearing, while leatherette upholstery is great for cleaning quickly and easily.

		Standard		Trendline		Highline		Sportline	
		Basic (ex VAT)	Total RRP (inc VAT)	Basic (ex VAT)	Total RRP (inc VAT)	Basic (ex VAT)	Total RRP (inc VAT)	Basic (ex VAT)	Total RRP (inc VAT)
Upholstery									
Place upholstery <small>(RD)</small>	Panel van	S	S	-	-	-	-	-	-
	Kombi	S	S	-	-	-	-	-	-
	Chassis cab/double cab	S	S	-	-	-	-	-	-
Leatherette upholstery <small>(RD)</small>	Panel van	£25.00	£30.00	-	-	-	-	-	-
	Kombi	£25.00	£30.00	-	-	-	-	-	-
	Chassis cab/double cab	£25.00	£30.00	-	-	-	-	-	-
Robust upholstery <small>(RD)</small>	Panel van	£85.00	£102.00	£85.00	£102.00	£85.00	£102.00	-	-
	Kombi	£85.00	£102.00	£85.00	£102.00	£85.00	£102.00	-	-
	Chassis cab/double cab	£85.00	£102.00	-	-	-	-	-	-
'Tasamo' cloth upholstery <small>(RE)</small>	Panel van	£65.00	£78.00	S	S	S	S	-	-
	Kombi	£65.00	£78.00	S	S	S	S	-	-
	Chassis cab/double cab	£65.00	£78.00	-	-	-	-	-	-
Carpet flooring									
Carpet flooring in cab <small>Not compatible with BlueMotion models</small>	Panel van	£55.00	£66.00	£55.00	£66.00	£55.00	£66.00	£55.00	£66.00
	Kombi	£55.00	£66.00	£55.00	£66.00	£55.00	£66.00	£55.00	£66.00
	Chassis cab/double cab	-	-	-	-	-	-	-	-

Add Ons

Accessories to help keep your vehicle 100% Volkswagen

If you want even more seating, trim and upholstery choices, check out our Add Ons accessories range, which includes leather seats and waterproof seat covers. Ask your Van Centre for a brochure, call 0800 717131 or download a copy at www.volkswagen-vans.co.uk

Options: Safety and security

Parking sensors, airbag packs and sophisticated alarms that enhance the safety of you, your van and its contents

		Standard		Trendline		Highline		Sportline	
		Basic (ex VAT)	Total RRP (inc VAT)	Basic (ex VAT)	Total RRP (inc VAT)	Basic (ex VAT)	Total RRP (inc VAT)	Basic (ex VAT)	Total RRP (inc VAT)
Airbags									
Side and front curtain airbags Only compatible with single passenger seat	Panel van Kombi Chassis cab/double cab	£250.00 £250.00 £250.00	£300.00 £300.00 £300.00	£250.00 £250.00 –	£300.00 £300.00 –	£250.00 £250.00 –	£300.00 £300.00 –	– – –	– – –
Alarms									
Perimeter alarm with back-up horn	Panel van Kombi Chassis cab/double cab	£135.00 £135.00 £135.00	£162.00 £162.00 £162.00	£135.00 £135.00 –	£162.00 £162.00 –	– – –	– – –	– – –	– – –
Interior alarm (cab only) and tow-away protection Not compatible with medium- or high-roof models, uprated battery/alternator or roof ventilation/extraction	Panel van Kombi Chassis cab/double cab	£160.00 £160.00 £160.00	£192.00 £192.00 £192.00	£160.00 £160.00 –	£192.00 £192.00 –	S S –	S S –	– – –	– – –
Lights									
Front fog lights (with cornering function)	Panel van Kombi Chassis cab/double cab	£270.00 £270.00 £270.00	£324.00 £324.00 £324.00	£270.00 £270.00 –	£324.00 £324.00 –	S S –	S S –	– – –	– – –
Lane-change assist									
Lane-change assist Includes rain sensor, auto-dimming rear-view mirror cruise control and trip computer. Only compatible with short-wheelbase models and requires tailgate and electric door mirrors to be fitted	Panel van Kombi Chassis cab/double cab	£700.00 £700.00 –	£840.00 £840.00 –	£700.00 £700.00 –	£840.00 £840.00 –	£700.00 £700.00 –	£840.00 £840.00 –	– – –	– – –

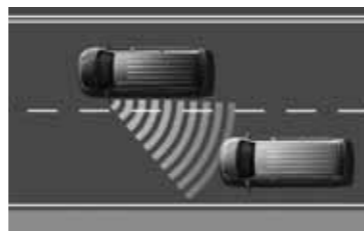

Lane-change assist

Lane-change assist makes motorway driving safer by helping to prevent accidents when you want to change lanes. The system monitors your blind spots and warns you of a potentially hazardous situation by flashing warning lights in the exterior mirrors.

		Standard		Trendline		Highline		Sportline	
		Basic (ex VAT)	Total RRP (inc VAT)	Basic (ex VAT)	Total RRP (inc VAT)	Basic (ex VAT)	Total RRP (inc VAT)	Basic (ex VAT)	Total RRP (inc VAT)
Parking aids									
Parking sensors – rear	Panel van Kombi Chassis cab/double cab	£195.00 £195.00 –	£234.00 £234.00 –	S S –	S S –	S S –	S S –	– – –	– – –
Parking sensors – front and rear	Panel van Kombi Chassis cab/double cab	£350.00 £350.00 –	£420.00 £420.00 –	£150.00 £150.00 –	£180.00 £180.00 –	£150.00 £150.00 –	£180.00 £180.00 –	£150.00 £150.00 –	£180.00 £180.00 –
Tyre pressure warning light									
Tyre pressure warning light Not compatible with roof ventilation/extraction	Panel van Kombi Chassis cab/double cab	£50.00 £50.00 £50.00	£60.00 £60.00 £60.00	£50.00 £50.00 –	£60.00 £60.00 –	£50.00 £50.00 –	£60.00 £60.00 –	– – –	– – –



Useful security tips

- 1. Get an alarm**
Alarm noise may be enough to scare a thief and prevent a costly break-in.
- 2. Lock your doors**
Even if you're only away from your van for a minute, locked doors deter thieves looking for an easy target.
- 3. Keep it tidy**
Seemingly trivial items can still be bait to thieves. Stow gadgets out of sight or take them with you. Thieves know to look in the glove box, too.
- 4. Load out of sight**
Try and load your van in a secure location. Thieves can linger in public areas for an easy swipe-and-run.
- 5. Park for visibility**
Use well-lit areas. Avoid parking near vehicles or foliage that a thief could use for cover. Parking right up against walls can stop a thief getting in through your van's doors, too.

Options: Electrical

Choose these electrical features to give your Transporter a functional and practical edge

		Standard		Trendline		Highline		Sportline	
		Basic (ex VAT)	Total RRP (inc VAT)	Basic (ex VAT)	Total RRP (inc VAT)	Basic (ex VAT)	Total RRP (inc VAT)	Basic (ex VAT)	Total RRP (inc VAT)
Alternators and batteries									
Additional 12V socket on dash panel Included with cab comfort pack	Panel van	£30.00	£36.00	S	S	S	S	-	-
	Kombi	£30.00	£36.00	S	S	S	S	-	-
	Chassis cab/double cab	£30.00	£36.00	-	-	-	-	-	-
Up-rated battery 450A/95Ah battery. Not compatible with alarm options	Panel van	£35.00	£42.00	£35.00	£42.00	-	-	-	-
	Kombi	£35.00	£42.00	£35.00	£42.00	-	-	-	-
	Chassis cab/double cab	-	-	-	-	-	-	-	-
Up-rated alternator 180A alternator. Not compatible with air-conditioning	Panel van	£65.00	£78.00	£65.00	£78.00	-	-	-	-
	Kombi	£65.00	£78.00	£65.00	£78.00	-	-	-	-
	Chassis cab/double cab	-	-	-	-	-	-	-	-
Up-rated battery/alternator 450A/95Ah battery/180A alternator. Not compatible with interior alarm	Panel van	£100.00	£120.00	£100.00	£120.00	-	-	-	-
	Kombi	£100.00	£120.00	£100.00	£120.00	-	-	-	-
	Chassis cab/double cab	-	-	-	-	-	-	-	-
Second battery	Panel van	£185.00	£222.00	£185.00	£222.00	£185.00	£222.00	-	-
	Kombi	£185.00	£222.00	£185.00	£222.00	£185.00	£222.00	-	-
	Chassis cab/double cab	£185.00	£222.00	-	-	-	-	-	-
Electric door mirrors									
Electrically heated, adjustable and folding door mirrors (black)	Panel van	£105.00	£126.00	-	-	-	-	-	-
	Kombi	£105.00	£126.00	-	-	-	-	-	-
	Chassis cab/double cab	-	-	-	-	-	-	-	-
Electrically heated, adjustable and folding mirrors (body-coloured)	Panel van	£215.00	£258.00	£105.00	£126.00	£105.00	£126.00	-	-
	Kombi	£215.00	£258.00	£105.00	£126.00	£105.00	£126.00	-	-
	Chassis cab/double cab	-	-	-	-	-	-	-	-



Choose your electrics

Some factory-fit options, such as heaters or air-conditioning, require an up-rated battery or alternator to work. Your Van Centre can advise you on the best solution for you.

		Standard		Trendline		Highline		Sportline	
		Basic (ex VAT)	Total RRP (inc VAT)	Basic (ex VAT)	Total RRP (inc VAT)	Basic (ex VAT)	Total RRP (inc VAT)	Basic (ex VAT)	Total RRP (inc VAT)
Other electrical options									
'S' pack Includes alarm and high-bulkhead without window	Panel van	£255.00	£306.00	-	-	-	-	-	-
	Kombi	-	-	-	-	-	-	-	-
	Chassis cab/double cab	-	-	-	-	-	-	-	-
'SE' pack Includes air-conditioning (cab only), alarm, bulkhead without window and driver's armrest	Panel van	£970.00	£1,164.00	-	-	-	-	-	-
	Kombi	-	-	-	-	-	-	-	-
	Chassis cab/double cab	-	-	-	-	-	-	-	-
Digital tachograph Includes console on dash. Not compatible with BlueMotion models	Panel van	£455.00	£546.00	£455.00	£546.00	£455.00	£546.00	£455.00	£546.00
	Kombi	£455.00	£546.00	£455.00	£546.00	£455.00	£546.00	£455.00	£546.00
	Chassis cab/double cab	£455.00	£546.00	-	-	-	-	-	-
Trip computer Included with satellite-navigation	Panel van	£230.00	£276.00	S	S	S	S	-	-
	Kombi	£230.00	£276.00	S	S	S	S	-	-
	Chassis cab/double cab	£230.00	£276.00	-	-	-	-	-	-

Want more? Pick an Add On...

The Transporter comes with a wide range of factory-fit options, but you may want something extra. That's where Add Ons come in

Add Ons is the new name for our extensive range of Volkswagen-approved accessories, available to buy and be fitted at your Van Centre. Whether you want to add extra style to your van, get more out of your cargo bay, convert a work van into a weekend leisure vehicle or add extra audio, phone and sat-nav to your cab, we've got lots of Add Ons for you.

Help keep it 100% Volkswagen

There are big advantages to purchasing your accessories from Volkswagen. Add Ons have all been designed with Volkswagen in mind, so they're a perfect match for fit and style, and they've been designed and developed to be just as rugged, reliable and long-lasting as your vehicle.

Keep your Add Ons covered

Most Add Ons include a two-year warranty. However, if you order and fit them at the time of purchasing a new van, we may be able to extend that to three years to match your vehicle's warranty. Pop into your Van Centre and ask our staff about how much Add Ons can add to your life.



  To get a brochure, pop into a Van Centre. To find your nearest one, call 0800 717131 or visit www.volkswagen-vans.co.uk



Top five Transporter Add Ons

- 

18" Sportline Brilliant Silver alloys
Add extra style with these 8J x 18 alloys, or any of the many other alloys from our Add Ons range
- 

Bluetooth® Music Touch Phone kit
Control your phone by touch-screen or by voice, and have your texts and emails read to you. It plays music from your phone, too.
- 

Waterproof seat covers
Protects your driver and front-passenger seats from wet and dirt. Not for vehicles with side airbags.
- 

Kenwood Multimedia system
Our top-of-the range radio and sat-nav system includes a DVD player and Bluetooth®. It's standard on the Transporter Sportline and available as an Add On for all other models.
- 

Polished stainless steel side rails
These rails not only look good, they also protect your van's sills from damage. They're available for short- and long-wheelbase vans.

Data

All the facts and figures you'll need for your vehicle

Engines: Transporter (all models)

	2.0TDI 84PS	2.0TDI 102PS	2.0TDI 114PS	2.0TDI 140PS	2.0TDI 180PS
ENGINE SPECIFICATIONS					
Engine type	Diesel, transverse, water-cooled, in-line, variable turbine geometry turbocharger with intercooler			Diesel, transverse, water-cooled, in-line, bi-turbo with intercooler	
Mixture preparation/injection method	Common-rail, direct-injection				
EU exhaust emission standard	EURO 5				
Number of cylinders	4				
Cubic capacity	1,968cc				
Output, PS at rpm	84 at 3,500	102 at 3,500	114 at 3,500	140 at 3,500	180 at 4,000
Torque, max. Nm at rpm	220 at 1,250-2,500	250 at 1,500-2,500	250 at 1,500-2,750	340 at 1,750-2,500	400 at 1,500-2,000
Diesel Particulate Filter (DPF)	●	●	●	●	●
5-speed manual gearbox	●	●	●	-	-
6-speed manual gearbox	-	-	-	●	●
7-speed dual-clutch gearbox (DSG)	-	-	-	●	●
Front-wheel drive	●	●	●	●	●
4MOTION® four-wheel drive	-	-	-	●	●
Battery	61Ah (330A)				

● Available
- Not available

Output (PS)
Torque (Nm)

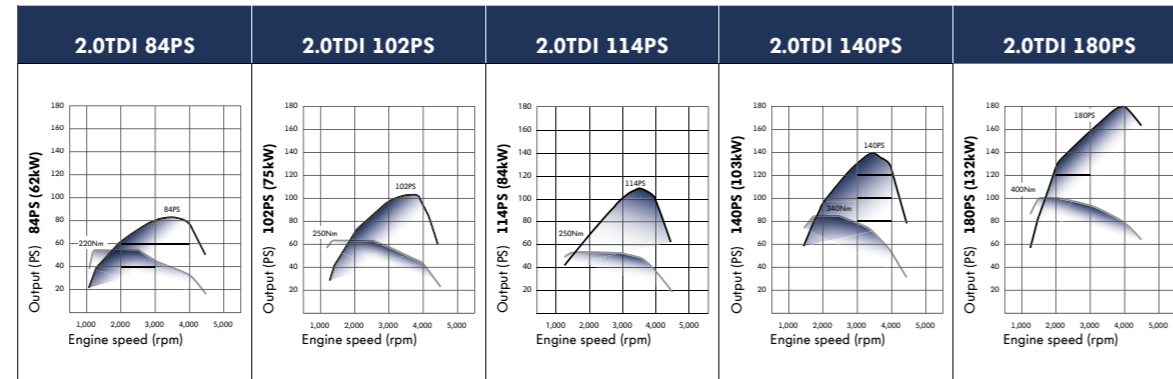

Standard features: Transporter panel van

Standard

EXTERIOR

80-litre lockable fuel tank
Black wheel centre caps
Door mirrors, electrically heated and adjustable
Galvanised steel body
Grey bumpers
Heat-reflective glass
Steel wheels: 16" x 6.5J (84PS, 102PS, 114PS and 140PS models)
17" x 7J (180PS models)
Tyres: 205/65 R16 (84PS, 102PS and 140PS models)
215/65 R16 with low rolling resistance – (BlueMotion and BlueMotion Technology models)
235/55 R17 (180PS models)
215/60 R17 all-weather (T32 180PS models)
Full-size spare wheel
Unglazed rear wing doors
Tool kit and jack

INTERIOR

Cab area
12V socket
Electric front windows
Digital clock
Driver's seat with height, lumbar, reach and rake adjustment
Dual passenger seat with storage box
Interior light
Manually controlled heating system with dust and pollen filter, and air recirculation
'Place' cloth upholstery
RCD 210 radio/single CD player with two speakers
Rev counter
Rubber floor covering
Lockable glove compartment
Storage net on lower dash passenger side
Gear shift indicator
Cargo area
Two door-activated interior lights (three with optional high roof)
Half-height load sidelining in hardboard
Interior entry step
Interior roof trim in painted hardboard (low roof only)
Load-lashing rings (six for SWB, eight for LWB)
Rear-door interior release lever
Sheet steel flooring
Sliding side door (nearside)

SAFETY AND SECURITY

Driver and front passenger (with deactivation) airbags
Thatcham Category 2 approved immobiliser
Height-adjustable head restraints
Height and rake adjustable steering column
Remote central locking with interior locking switch and two remote folding keys
Electronic Stability Programme (ESP)
Electronic Differential Lock (EDL)
Anti-lock Braking System (ABS)
Electronic Brake-pressure Distribution (EBD)
Hill Start Assist

BlueMotion Technology models

BLUEMOTION TECHNOLOGY

In addition to Standard

Low rolling resistance tyres
Start/stop system
Cruise control
Regenerative braking
BlueMotion Technology exterior badge

BLUEMOTION

In addition to BlueMotion Technology

Tyre pressure monitor
'Timo' cloth upholstery
BlueMotion exterior badge

Standard features: Transporter panel van (cont.)

Trendline, Highline and Sportline

TRENDLINE

In addition to Standard

- RCD 310 single CD/radio system. A double DIN system with a larger display, four loud speakers, AUX-IN and ParkPilot visual display when combined with parking sensors
- Bluetooth mobile phone connection. Includes trip computer with multi-function display
- Parking sensors - rear
- Body coloured bumpers, door mirrors and handles
- Premium dashboard (includes platinum-grey centre console surround, rubber storage compartment trays and air vent controls)
- 'Tasamo' cloth upholstery
- Comfort pack (includes grab handle on A-pillars, sunglasses holder, driver and front-passenger seat side storage compartments, sun visors with vanity mirrors, two-tone horn, reading lights, dimmable dashboard illumination and additional noise-suppression measures)
- Wheel trims (not 180PS models)
- Cruise control
- Armrests for driver's seat
- Bulkhead, full-height, steel
- Trendline exterior badge

HIGHLINE

In addition to Trendline

- 16" x 6.5J Colmar alloy wheels with 215/65 R16 tyres including steel spare wheel and locking wheel bolts (all models except 180PS)
- 17" x 7J Thunder alloy wheels fitted with 235/55 R17 tyres including steel spare wheel and locking wheel bolts (180PS models)
- Climatic semi-automatic air-conditioning system
- Leather steering wheel and gear knob
- Front fog lights
- Thatcham Category 1 approved alarm and immobiliser with tow-away, perimeter and interior cab protection
- Highline exterior badge

SPORTLINE

In addition to Standard

- 18" x 8J Sportline five-spoke alloy wheels with 255/45 R18 103 tyres. Includes Tyre Mobility System. Available in Brilliant Silver or Black finish
- Body-coloured bumpers and door handles
- Darkened rear light clusters
- Deep Black pearlescent or Reflex Silver metallic paint (Candy White with Gloss black roof available as optional extra)
- Front carpet floor mats with Sportline logo
- Front spoiler
- Gloss black door mirror covers with Sportline logo
- Gloss black upper and lower front grille with chrome detailing
- Headlights with interior chrome detailing
- Polished stainless-steel side bars
- Parking sensors - rear
- Rear roof spoiler
- Sportline sports suspension (30mm lower)
- Tailgate without window
- Sportline exterior badge
- Two-tone leather upholstery with Sportline logo
- Armrests on drivers seat
- Climatic semi-automatic air-conditioning for cab
- Kenwood Multimedia System – 7" colour touch-screen, full European Garmin satellite-navigation with real-time traffic information, built-in Bluetooth phone connectivity. Radio and single CD with DVD playback. Full iPod or iPhone connectivity with an optional lead (please ask your Van Centre for full details)
- Leather steering wheel and gearknob
- Trip computer with multi-function display
- Front fogs lights with cornering light function
- Thatcham Category 1 approved alarm and immobiliser with tow-away, perimeter and interior cab protection

Dimensions and weights: Transporter panel van

Short wheelbase

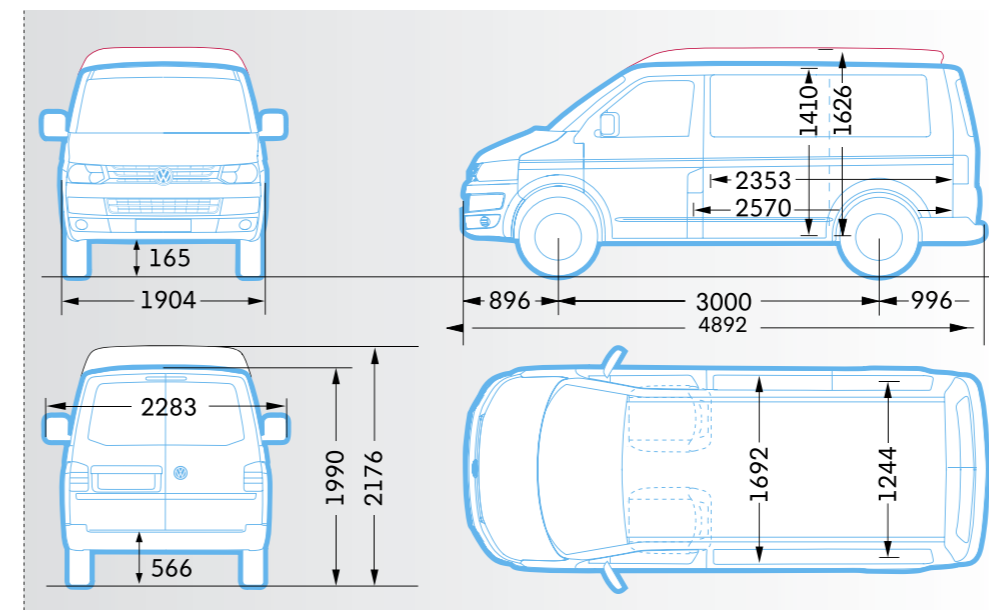

Dimensions (short wheelbase)	Low roof	Medium roof
Wheelbase	3,000	3,000
Load compartment		
Length	2,570	2,570
Width	1,692	1,692
Width (between wheel housings)	1,244	1,244
Height	1,410	1,626
Area	4.3m ³	4.3m ³
Volume	5.8m ³	6.7m ³
Sliding side door		
Width	1,020	1,020
Height	1,284	1,284
Rear doors		
Width	1,486	1,486
Height	1,694	1,694
Turning circle (wall to wall)	11.9m	11.9m

Long wheelbase

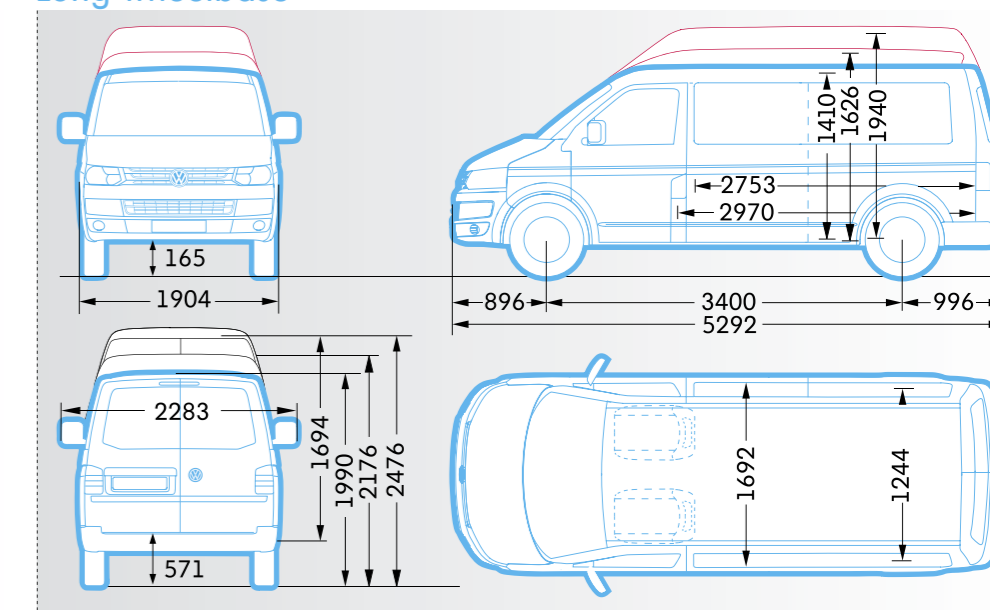

Dimensions (long wheelbase)	Low roof	Medium roof	High roof
Wheelbase	3,400	3,400	3,400
Load compartment			
Length	2,970	2,970	2,970
Width	1,692	1,692	1,692
Width (between wheel housings)	1,244	1,244	1,244
Height	1,410	1,626	1,940
Area	5.0m ³	5.0m ³	5.0m ³
Volume	6.7m ³	7.8m ³	9.3m ³
Sliding side door			
Width	1,020	1,020	1,020
Height	1,284	1,284	1,724*
Rear doors			
Width	1,486	1,486	1,486
Height	1,694	1,694	1,694
Turning circle (wall to wall)	13.2m	13.2m	13.2m

* With optional high side sliding door

□ Indicates optional roof height. Dimensions in mm unless otherwise indicated.

Economy and performance: Transporter panel van

Engine/transmission	Urban mpg (l/100km) ¹	Extra-urban mpg (l/100km) ¹	Combined mpg (l/100km) ¹	Acceleration 0-62 mph (seconds)	Top speed mph (where law permits)	CO ₂ emissions (g/km) ¹
T26, T27, T28, T30 AND T32 PANEL VANS WITH LOW ROOF						
2.0TDI 84PS	29.1 (9.7)	44.8 (6.3)	37.7 (7.5)	19.7	91	198
2.0TDI 84PS BlueMotion Technology	32.8 (8.6)	46.3 (6.1)	40.4 (7.0)	19.7	91	184
2.0TDI 102PS	29.1 (9.7)	44.8 (6.3)	37.7 (7.5)	15.3	98	198
2.0TDI 114PS BlueMotion Technology	32.8 (8.6)	46.3 (6.1)	40.4 (7.0)	14.8	101	184
2.0TDI 114PS BlueMotion	37.7 (7.5)	50.4 (5.6)	44.8 (6.3)	14.8	102	166
2.0TDI 140PS	28.8 (9.8)	43.5 (6.5)	36.7 (7.7)	12.2	107	203
2.0TDI 140PS DSG	27.2 (10.4)	40.9 (6.9)	34.4 (8.2)	12.5	107	216
2.0TDI 140PS 4MOTION®	27.2 (10.4)	39.8 (7.1)	34.0 (8.3)	13.5	106	219
2.0BiTDI 180PS	28.8 (9.8)	42.2 (6.7)	36.2 (7.8)	9.9	119	205
2.0BiTDI 180PS DSG	27.7 (10.2)	40.9 (6.9)	34.9 (8.1)	9.9	119	214
2.0BiTDI 180PS 4MOTION®	26.9 (10.5)	39.2 (7.2)	33.6 (8.4)	10.4	117	221
2.0BiTDI 180PS DSG 4MOTION®	25.4 (11.1)	37.7 (7.5)	32.1 (8.8)	10.6	117	232
2.0BiTDI 180PS Sportline	28.8 (9.8)	42.2 (6.7)	36.2 (7.8)	9.9	119	205
2.0BiTDI 180PS Sportline DSG	27.7 (10.2)	40.9 (6.9)	34.9 (8.1)	10.0	119	214
T28, T30 AND T32 PANEL VANS WITH MEDIUM ROOF						
2.0TDI 84PS	29.1 (9.7)	44.8 (6.3)	37.7 (7.5)	19.8	88	198
2.0TDI 84PS BlueMotion Technology	32.8 (8.6)	46.3 (6.1)	40.4 (7.0)	19.8	88	184
2.0TDI 102PS	29.1 (9.7)	44.8 (6.3)	37.7 (7.5)	15.4	94	198
2.0TDI 114PS BlueMotion Technology	32.8 (8.6)	46.3 (6.1)	40.4 (7.0)	14.9	98	184
2.0TDI 140PS	28.8 (9.8)	43.5 (6.5)	36.7 (7.7)	12.3	104	203
2.0TDI 140PS DSG	27.2 (10.4)	40.9 (6.9)	34.4 (8.2)	12.6	103	216
2.0TDI 140PS 4MOTION®	27.2 (10.4)	39.8 (7.1)	34.0 (8.3)	13.6	102	219
2.0BiTDI 180PS	28.8 (9.8)	42.2 (6.7)	36.2 (7.8)	10.0	114	205
2.0BiTDI 180PS DSG	27.7 (10.2)	40.9 (6.9)	34.9 (8.1)	10.1	114	214
2.0BiTDI 180PS 4MOTION®	26.9 (10.5)	39.2 (7.2)	33.6 (8.4)	10.5	113	221
2.0BiTDI 180PS DSG 4MOTION®	25.4 (11.1)	37.7 (7.5)	32.1 (8.8)	10.7	113	232
T28, T30 AND T32 PANEL VANS WITH HIGH ROOF						
2.0TDI 84PS	28.8 (9.8)	40.9 (6.9)	35.8 (7.9)	20.3	85	208
2.0TDI 84PS BlueMotion Technology	32.5 (8.7)	42.2 (6.7)	38.2 (7.4)	20.3	85	195
2.0TDI 102PS	28.8 (9.8)	40.9 (6.9)	35.8 (7.9)	15.5	90	208
2.0TDI 114PS BlueMotion Technology	32.5 (8.7)	42.2 (6.7)	38.2 (7.4)	15.0	94	195
2.0TDI 140PS	27.7 (10.2)	40.0 (6.9)	34.9 (8.1)	12.7	100	214
2.0TDI 140PS DSG	27.2 (10.4)	38.2 (7.4)	33.2 (8.5)	13.0	99	224
2.0TDI 140PS 4MOTION®	27.2 (10.4)	37.7 (7.5)	32.8 (8.6)	14.0	98	226
2.0BiTDI 180PS	28.8 (9.8)	39.8 (7.1)	34.9 (8.1)	10.3	109	214
2.0BiTDI 180PS DSG	27.7 (10.2)	38.7 (7.3)	33.6 (8.4)	10.4	109	221
2.0BiTDI 180PS 4MOTION®	26.9 (10.5)	37.2 (7.6)	32.5 (8.7)	10.8	108	229
2.0BiTDI 180PS DSG 4MOTION®	25.4 (11.1)	35.8 (7.9)	31.0 (9.1)	11.0	108	240

¹The fuel consumption and emission test values shown are in full compliance of the fuel consumption directive 80/1268/EWG

Standard features: Transporter kombi

Standard

EXTERIOR

80-litre lockable fuel tank
Black wheel centre caps
Door mirrors, electrically heated and adjustable
Front and rear towing eyes
Galvanised full steel body
Grey bumpers
Heat-reflective glass
Steel wheels: 16" x 6.5J (84PS, 102PS, 114PS and 140PS models)
17" x 7J (180PS models)
Tyres: 205/65 R16 (84PS, 102PS and 140PS models)
215/65 R16 with low rolling resistance (BlueMotion Technology models)
235/55 R17 (180PS models)
215/60 R17 all-weather (T32 180PS models)
Full-size spare wheel
Tailgate with heated rear window and wash/wipe system
Tool kit and jack

INTERIOR

Cab area:
12V socket
Electric front windows
Digital clock
Driver's seat with height, lumbar, reach and rake adjustment
Manually controlled heating system with dust and pollen filter, and air recirculation
'Place' cloth upholstery
Interior light
RCD 210 radio/single CD player with two speakers
Rubber floor covering
Single passenger seat with reach and rake adjustment
Lockable glove box
Storage net on lower dash passenger side
Gear shift indicator
Cargo area
Two door-activated interior lights
Three-seat bench in first row – dual seat right, single seat left
Interior entry step
Rear-door interior release lever
Rubber floor covering
Sliding side door (nearside)
Sliding windows in side door and opposite
Solid rear side panels

SAFETY AND SECURITY

Driver and front passenger (with deactivation) airbags
Driver seatbelt warning signal
Thatcham Category 2 approved immobiliser
Height-adjustable head restraints
Height and rake adjustable steering column
Remote central locking with interior locking switch and two remote folding keys
Electronic Stability Programme (ESP)
Electronic Differential Lock (EDL)
Anti-lock Braking System (ABS)
Electronic Brake-pressure distribution (EBD)
Hill Start Assist

BlueMotion Technology models

BLUEMOTION TECHNOLOGY

In addition to Standard
Low rolling resistance tyres
Start/stop system
Cruise control
Regenerative braking
BlueMotion Technology exterior badge

Standard features: Transporter kombi (cont.)

Trendline, Highline and Sportline

TRENDLINE

In addition to Standard

- RCD 310 single CD/radio system. A double DIN system with a larger display, four loud speakers, AUX-IN and ParkPilot visual display when combined with parking sensors
- Bluetooth mobile phone connection. Includes trip computer with multi-function display
- Parking sensors – rear
- Body-coloured bumpers, door mirrors and handles
- Premium dashboard (includes platinum-grey centre console surround, rubber storage compartment trays and air vent controls)
- ‘Tasamo’ cloth upholstery
- Comfort pack (includes grab handle on A-pillars, sunglasses holder, driver and front-passenger seat side storage compartments, sun visors with vanity mirrors, two-tone horn, reading lights, dimmable dashboard illumination, additional noise suppression measures and heating vents on B-pillar)
- Wheel trims (not 180PS models)
- Cruise control
- Armrests for driver’s seat
- Armrests, height and lumbar adjustment for single passenger seat (height and lumbar adjustment are standard for driver’s seat).
- Privacy glass
- Trendline exterior badge

HIGHLINE

In addition to Trendline

- 16" x 6.5J Colmar alloy wheels with 215/65 R16 tyres including steel spare wheel and locking wheel bolts (all models except 180PS)
- 17" x 7J Thunder alloy wheels with 235/55 R17 tyres including steel spare wheel and locking wheel bolts (180PS models)
- Climatic semi-automatic air-conditioning system for cab
- Leather steering wheel and gear knob
- Front fog lights
- Thatcham Category 1 approved alarm and immobiliser with tow-away, perimeter and interior cab protection
- Highline exterior badge

SPORTLINE

In addition to Standard

- 18" x 8J Sportline five-spoke alloy wheels fitted with 255/45 R18 103 tyres, includes Tyre Mobility System. Available in Brilliant Silver or Black
- Body-coloured bumpers and door handles
- Darkened rear light clusters
- Deep Black pearlescent or Reflex Silver metallic paint (optional Candy White with Gloss black roof available)
- Front carpet floor mats with Sportline logo
- Front spoiler
- Gloss black door mirror covers with Sportline logo
- Gloss black upper and lower front grille with chrome detailing
- Headlights with interior chrome detailing
- Polished stainless steel side bars
- Parking sensors - rear
- Rear roof spoiler
- Sportline sports suspension (30mm lower)
- Sportline exterior badge
- Privacy glass
- Tailgate with heated window and wash/wipe
- Two-tone leather upholstery with Sportline logo
- Armrests on drivers seat
- Single front passenger seat with height and lumbar adjustment, and armrests
- Climatic semi-automatic air-conditioning for cab
- Kenwood Multimedia System – 7" colour touch-screen, full European Garmin satellite-navigation with real-time traffic information, built-in Bluetooth phone connectivity. Radio and single CD with DVD playback. Full iPod or iPhone connectivity with an optional lead (ask your Van Centre for full details)
- Leather steering wheel and gearknob
- Trip computer with multi-function display
- Front fogs lights with cornering light function
- Thatcham Category 1 approved alarm and immobiliser with tow-away, perimeter and interior cab protection

Dimensions and weights: Transporter kombi

Short wheelbase

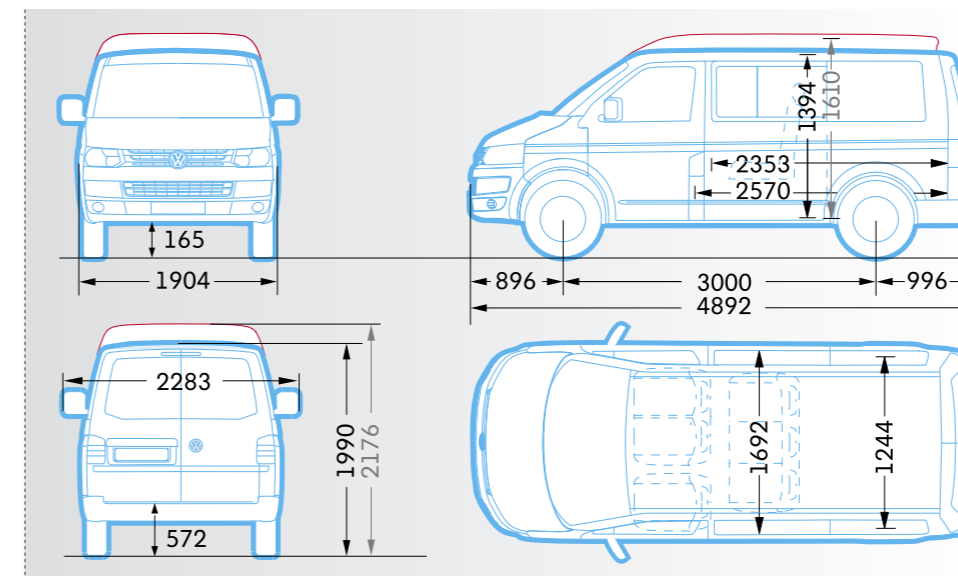

Dimensions (short wheelbase)	Low roof	Medium roof
Wheelbase	3,000	3,000
Load compartment		
Length	2,570	2,570
Width	1,692	1,692
Width (between wheel housings)	1,244	1,244
Height	1,394	1,610
Area	4.3m ³	4.3m ³
Sliding side door		
Width	1,020	1,020
Height	1,268	1,268
Rear tailgate		
Width	1,486	1,486
Height	1,295	1,295
Turning circle (wall to wall)	11.9m	11.9m

Long wheelbase

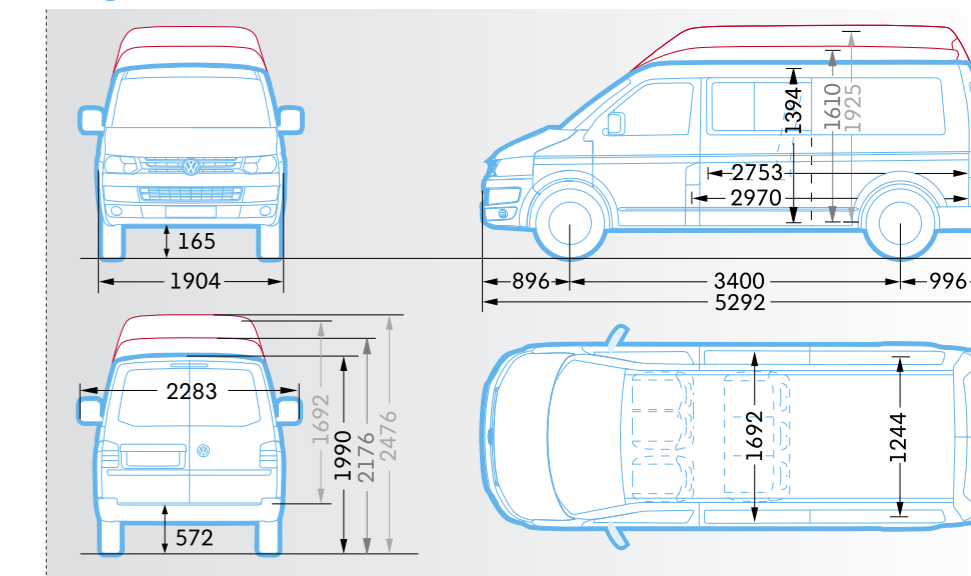

Dimensions (long wheelbase)	Low roof	Medium roof	High roof
Wheelbase	3,400	3,400	3,400
Load compartment			
Length	2,970	2,970	2,970
Width	1,692	1,692	1,692
Width (between wheel housings)	1,244	1,244	1,244
Height	1,394	1,610	1,925
Area	5.0m ³	5.0m ³	5.0m ³
Sliding side door			
Width	1,020	1,020	1,020
Height	1,268	1,268	1,724*
Rear tailgate			
Width	1,486	1,486	–
Height	1,295	1,295	–
Rear doors			
Width	–	–	1,486
Height	–	–	1,692
Turning circle (wall to wall)	13.2m	13.2m	13.2m

□ Indicates optional roof height. Dimensions in mm unless otherwise indicated.

Dimensions and weights: Transporter kombi (cont.)

Short wheelbase

					Standard		Trendline		Highline		Sportline		
Model / gross vehicle weight (kg)	Engine/transmission	Axle load limit front/rear (kg)	Trailer weight braked 12%/ unbraked (kg)	Gross train weight (kg)	Unladen weight † (kg)	Payload † (kg)	Unladen weight † (kg)	Payload † (kg)	Unladen weight † (kg)	Payload † (kg)	Unladen weight † (kg)	Payload † (kg)	
T30	3,000	2.0TDI 84PS	1,500 / 1,600	2,200 / 750	4,800	1,887	1,113	1,902	1,098	1,929	1,071	-	-
	3,000	2.0TDI 84PS BlueMotion Technology	1,500 / 1,600	2,200 / 750	4,800	1,898	1,102	1,913	1,087	1,937	1,063	-	-
	3,000	2.0TDI 102PS	1,500 / 1,600	2,200 / 750	4,900	1,887	1,113	1,902	1,098	1,929	1,071	-	-
	3,000	2.0TDI 114PS BlueMotion Technology	1,500 / 1,600	2,200 / 750	4,900	1,898	1,102	1,913	1,087	1,937	1,063	-	-
	3,000	2.0TDI 140PS	1,550 / 1,600	2,500 / 750	5,200	1,922	1,078	1,937	1,063	1,964	1,036	-	-
	3,000	2.0TDI 140PS DSG	1,550 / 1,600	2,500 / 750	5,300	1,939	1,061	1,954	1,046	1,981	1,019	-	-
	3,000	2.0TDI 140PS 4MOTION®	1,600 / 1,600	2,500 / 750	5,300	2,042	958	2,057	943	2,084	916	-	-
	3,000	2.0BiTDI 180PS	1,550 / 1,600	2,500 / 750	5,200	1,956	1,044	1,970	1,030	1,992	1,008	-	-
	3,000	2.0BiTDI 180PS DSG	1,550 / 1,600	2,500 / 750	5,300	1,973	1,027	1,988	1,012	2,004	996	-	-
	3,000	2.0BiTDI 180PS 4MOTION®	1,600 / 1,600	2,500 / 750	5,300	2,077	923	2,091	909	2,113	887	-	-
	3,000	2.0BiTDI 180PS DSG 4MOTION®	1,600 / 1,600	2,500 / 750	5,300	2,095	905	2,110	890	2,126	874	-	-
	T32	3,200	2.0TDI 102PS	1,600 / 1,680	2,200 / 750	4,900	1,899	1,301	1,914	1,286	-	-	-
3,200		2.0TDI 114PS BlueMotion Technology	1,600 / 1,680	2,200 / 750	4,900	1,910	1,290	1,925	1,275	-	-	-	-
3,200		2.0TDI 140PS	1,650 / 1,680	2,500 / 750	5,200	1,934	1,266	1,949	1,251	-	-	-	-
3,200		2.0TDI 140PS DSG	1,650 / 1,680	2,500 / 750	5,300	1,952	1,248	1,967	1,233	-	-	-	-
3,200		2.0TDI 140PS 4MOTION®	1,700 / 1,720	2,500 / 750	5,300	2,054	1,146	2,069	1,131	-	-	-	-
3,200		2.0BiTDI 180PS	1,650 / 1,680	2,500 / 750	5,200	1,994	1,206	2,008	1,192	-	-	2,066	1,134
3,200		2.0BiTDI 180PS DSG	1,650 / 1,680	2,500 / 750	5,300	2,011	1,189	2,025	1,175	-	-	2,078	1,122
3,200		2.0BiTDI 180PS 4MOTION®	1,700 / 1,720	2,500 / 750	5,300	2,115	1,085	2,129	1,071	-	-	-	-
3,200		2.0BiTDI 180PS DSG 4MOTION®	1,700 / 1,720	2,500 / 750	5,300	2,133	1,067	2,147	1,053	-	-	-	-

Long wheelbase

					Standard		Trendline		Highline		Sportline		
Model / gross vehicle weight (kg)	Engine/transmission	Axle load limit front/rear (kg)	Trailer weight braked 12%/ unbraked (kg)	Gross train weight (kg)	Unladen weight † (kg)	Payload † (kg)	Unladen weight † (kg)	Payload † (kg)	Unladen weight † (kg)	Payload † (kg)	Unladen weight † (kg)	Payload † (kg)	
T32	3,200	2.0TDI 102PS	1,625 / 1,680	2,200 / 750	4,900	1,962	1,238	1,977	1,223	-	-	-	-
	3,200	2.0TDI 114PS BlueMotion Technology	1,625 / 1,680	2,200 / 750	4,900	1,973	1,227	1,988	1,212	-	-	-	-
	3,200	2.0TDI 140PS	1,675 / 1,680	2,500 / 750	5,200	1,997	1,203	2,012	1,188	-	-	-	-
	3,200	2.0TDI 140PS DSG	1,675 / 1,680	2,500 / 750	5,300	2,015	1,185	2,030	1,170	-	-	-	-
	3,200	2.0TDI 140PS 4MOTION®	1,700 / 1,720	2,500 / 750	5,300	2,117	1,083	2,132	1,068	-	-	-	-
	3,200	2.0BiTDI 180PS	1,675 / 1,680	2,500 / 750	5,200	2,057	1,143	2,071	1,129	-	-	2,157	1,043
	3,200	2.0BiTDI 180PS DSG	1,675 / 1,680	2,500 / 750	5,300	2,074	1,126	2,089	1,111	-	-	2,170	1,030
	3,200	2.0BiTDI 180PS 4MOTION®	1,700 / 1,720	2,500 / 750	5,300	2,178	1,022	2,192	1,008	-	-	-	-
	3,200	2.0BiTDI 180PS DSG 4MOTION®	1,700 / 1,720	2,500 / 750	5,300	2,196	1,004	2,211	989	-	-	-	-

Economy and performance: Transporter kombi

Engine/transmission	Urban mpg (l/100km) ¹	Extra-urban mpg (l/100km) ¹	Combined mpg (l/100km) ¹	Acceleration 0-62 mph (seconds)	Top speed mph (where law permits)	CO ₂ emissions (g/km) ¹
T30 SHORT-WHEELBASE KOMBI WITH LOW ROOF						
2.0TDI 84PS	29.7 (9.5)	46.3 (6.1)	38.7 (7.3)	21.1	91	193
2.0TDI 84PS BlueMotion Technology	33.6 (8.4)	47.9 (5.9)	41.5 (6.8)	21.1	91	179
2.0TDI 102PS	29.7 (9.5)	46.3 (6.1)	38.7 (7.3)	16.4	98	193
2.0TDI 114PS BlueMotion Technology	33.6 (8.4)	47.9 (5.9)	41.5 (6.8)	15.9	101	179
2.0TDI 140PS	29.4 (9.6)	44.8 (6.3)	37.7 (7.5)	13.1	108	198
2.0TDI 140PS DSG	27.7 (10.2)	42.2 (6.7)	35.3 (8.0)	13.0	107	211
2.0TDI 140PS 4MOTION®	27.7 (10.2)	40.9 (6.9)	34.9 (8.1)	13.6	106	214
2.0BiTDI 180PS	29.4 (9.6)	43.5 (6.5)	37.2 (7.6)	10.3	119	199
2.0BiTDI 180PS DSG	27.7 (10.2)	42.2 (6.7)	35.3 (8.0)	10.2	119	211
2.0BiTDI 180PS 4MOTION®	27.7 (10.2)	40.9 (6.9)	34.9 (8.1)	10.6	117	214
2.0BiTDI 180PS DSG 4MOTION®	25.9 (10.9)	38.7 (7.3)	32.8 (8.6)	10.8	117	226
T30 SHORT-WHEELBASE KOMBI WITH MEDIUM ROOF						
2.0TDI 84PS	29.7 (9.5)	46.3 (6.1)	38.7 (7.3)	21.2	88	193
2.0TDI 84PS BlueMotion Technology	33.6 (8.4)	47.9 (5.9)	41.5 (6.8)	21.2	88	179
2.0TDI 102PS	29.7 (9.5)	46.3 (6.1)	38.7 (7.3)	16.5	94	193
2.0TDI 114PS BlueMotion Technology	33.6 (8.4)	47.9 (5.9)	41.5 (6.8)	16.0	98	179
2.0TDI 140PS	29.4 (9.6)	44.8 (6.3)	37.7 (7.5)	13.2	104	198
2.0TDI 140PS DSG	27.7 (10.2)	42.2 (6.7)	35.3 (8.0)	13.1	103	211
2.0TDI 140PS 4MOTION®	27.7 (10.2)	40.9 (6.9)	34.9 (8.1)	13.7	102	214
2.0BiTDI 180PS	29.4 (9.6)	43.5 (6.5)	37.2 (7.6)	10.4	114	199
2.0BiTDI 180PS DSG	27.7 (10.2)	42.2 (6.7)	35.3 (8.0)	10.3	114	211
2.0BiTDI 180PS 4MOTION®	27.7 (10.2)	40.9 (6.9)	34.9 (8.1)	10.7	113	214
2.0BiTDI 180PS DSG 4MOTION®	25.9 (10.9)	38.7 (7.3)	32.8 (8.6)	10.9	113	226
T32 SHORT- AND LONG-WHEELBASE KOMBI WITH LOW ROOF						
2.0TDI 102PS	29.7 (9.5)	46.3 (6.1)	38.7 (7.3)	16.4	98	193
2.0TDI 114PS BlueMotion Technology	33.6 (8.4)	47.9 (5.9)	41.5 (6.8)	15.9	101	179
2.0TDI 140PS	29.4 (9.6)	44.8 (6.3)	37.7 (7.5)	13.1	107	198
2.0TDI 140PS DSG	27.7 (10.2)	42.2 (6.7)	35.3 (8.0)	13.0	107	211
2.0TDI 140PS 4MOTION®	27.7 (10.2)	40.9 (6.9)	34.9 (8.1)	13.6	106	214
2.0BiTDI 180PS	29.4 (9.6)	43.5 (6.5)	37.2 (7.6)	10.3	119	199
2.0BiTDI 180PS DSG	28.2 (10.0)	42.2 (6.7)	35.8 (7.9)	10.2	119	208
2.0BiTDI 180PS 4MOTION®	27.4 (10.3)	40.4 (7.0)	34.4 (8.2)	10.6	117	216
2.0BiTDI 180PS DSG 4MOTION®	25.9 (10.9)	38.7 (7.3)	32.8 (8.6)	10.8	117	226

¹The fuel consumption and emission test values shown are in full compliance of the fuel consumption directive 80/1268/EWG

† Unladen weight and payload figures for Transporter kombi models are calculated with 100% fuel load and no driver. The published payload figure is based on a standard-specification vehicle. It does not include any items of optional equipment. Any optional equipment will reduce the payload from the published figure.

Roof load limit 100kg (with two roof carriers) or 150kg (with at least four roof carriers). Only with low roof. Trailer nose weight 100kg.

Economy and performance: Transporter kombi (cont.)

Engine	Urban mpg (l/100km) ¹	Extra-urban mpg (l/100km) ¹	Combined mpg (l/100km) ¹	Acceleration 0-62 mph (seconds)	Top speed mph (where law permits)	CO ₂ emissions (g/km) ¹
T32 LONG-WHEELBASE KOMBI WITH MEDIUM ROOF						
2.0TDI 102PS	29.7 (9.5)	46.3 (6.1)	38.7 (7.3)	16.5	94	193
2.0TDI 114PS BlueMotion Technology	33.6 (8.4)	47.9 (5.9)	41.5 (6.8)	16.0	98	179
2.0TDI 140PS	29.4 (9.6)	44.8 (6.3)	37.7 (7.5)	13.2	104	198
2.0TDI 140PS DSG	27.7 (10.2)	42.2 (6.7)	35.3 (8.0)	13.1	103	211
2.0TDI 140PS 4MOTION®	27.7 (10.2)	40.9 (6.9)	34.9 (8.1)	13.7	102	214
2.0BiTDI 180PS	29.4 (9.6)	43.5 (6.5)	37.2 (7.6)	10.4	114	199
2.0BiTDI 180PS DSG	28.2 (10.0)	42.2 (6.7)	35.8 (7.9)	10.3	114	208
2.0BiTDI 180PS 4MOTION®	27.4 (10.3)	40.4 (7.0)	34.4 (8.2)	10.7	113	216
2.0BiTDI 180PS DSG 4MOTION®	25.9 (10.9)	38.7 (7.3)	32.8 (8.6)	10.9	113	226
T32 LONG-WHEELBASE KOMBI WITH HIGH ROOF						
2.0TDI 102PS	29.4 (9.6)	42.2 (6.7)	36.7 (7.7)	16.6	90	203
2.0TDI 114PS BlueMotion Technology	33.2 (8.5)	43.5 (6.5)	39.2 (7.2)	16.1	94	190
2.0TDI 140PS	28.2 (10.0)	42.2 (6.7)	35.8 (7.9)	13.4	100	208
2.0TDI 140PS DSG	27.7 (10.2)	39.2 (7.2)	34.0 (8.3)	13.3	99	219
2.0TDI 140PS 4MOTION®	27.7 (10.2)	38.7 (7.3)	33.6 (8.4)	14.1	98	221
2.0BiTDI 180PS	29.4 (9.6)	40.9 (6.9)	35.8 (7.9)	10.7	109	208
2.0BiTDI 180PS DSG	28.2 (10.0)	39.8 (7.1)	34.4 (8.2)	10.6	109	216
2.0BiTDI 180PS 4MOTION®	27.4 (10.3)	38.2 (7.4)	33.2 (8.5)	11.0	108	224
2.0BiTDI 180PS DSG 4MOTION®	25.9 (10.9)	36.7 (7.7)	31.7 (8.9)	11.2	108	235
T32 SHORT-WHEELBASE KOMBI SPORTLINE						
2.0BiTDI 180PS	29.4 (9.6)	43.5 (6.5)	37.2 (7.6)	10.3	119	205
2.0BiTDI 180PS DSG	28.2 (10.0)	42.2 (6.7)	35.8 (7.9)	10.2	119	208
T32 LONG-WHEELBASE KOMBI SPORTLINE						
2.0BiTDI 180PS	29.4 (9.6)	43.5 (6.5)	37.2 (7.6)	10.3	119	199
2.0BiTDI 180PS DSG	28.2 (10.0)	42.2 (6.7)	35.8 (7.9)	10.2	119	208

¹ The fuel consumption and emission test values shown are in full compliance of the fuel consumption directive 80/1268/EWG

Standard features: Transporter chassis and double cab

Standard trim

EXTERIOR

80-litre lockable fuel tank
Black wheel centre caps
Door mirrors, electrically heated and adjustable
Galvanised full steel body
Grey bumpers
Heat-reflective glass
Ladder frame chassis at rear
Steel wheels: 16" x 6.5J
Tyres: 205/65 R16 (84PS, 102PS and 140PS manual models)
205/65 R16 (140PS 4MOTION® double cab only)
215/65 R16 (140PS 4MOTION® chassis cab only)
215/65 R16 (140PS DSG engines)
Full-size spare wheel
Tool kit and jack

INTERIOR

Cab area
12V socket
Electric front windows
Digital clock
Driver's seat with height, lumbar, reach and rake adjustment
Dual passenger seat with storage box
Interior light
Manually controlled heating system with dust and pollen filter, and air recirculation
'Place' cloth upholstery
RCD 210 radio/single CD player with two speakers
Rev counter
Rubber floor covering
Lockable glove compartment
Storage net on lower dash passenger side
Gear shift indicator
Double cab passenger area
Two side doors with fixed windows
Three-seat bench with storage underneath
Childlocks
Interior entry steps
Interior roof and side trim in grey painted hardboard
Rubber floor covering

SAFETY AND SECURITY

Driver and front passenger (with deactivation) airbags
Thatcham Category 2 approved immobiliser
Height-adjustable head restraints
Height and rake adjustable steering column
Electronic Stability Programme (ESP)
Electronic Differential Lock (EDL)
Anti-lock Braking System (ABS)
Electronic Brake-pressure Distribution (EBD)
Hill Start Assist
Remote central locking with interior locking switch and two remote folding keys and one fixed key

Dimensions and weights: Transporter chassis and double cab

Chassis cab

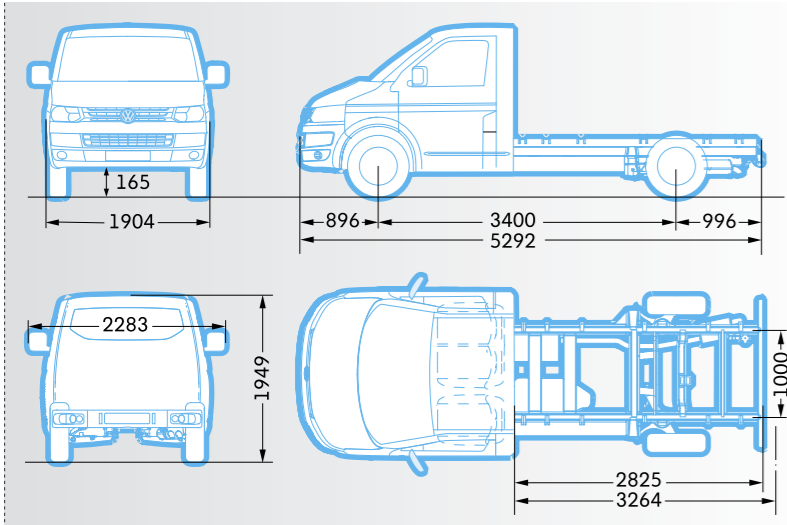

Double cab

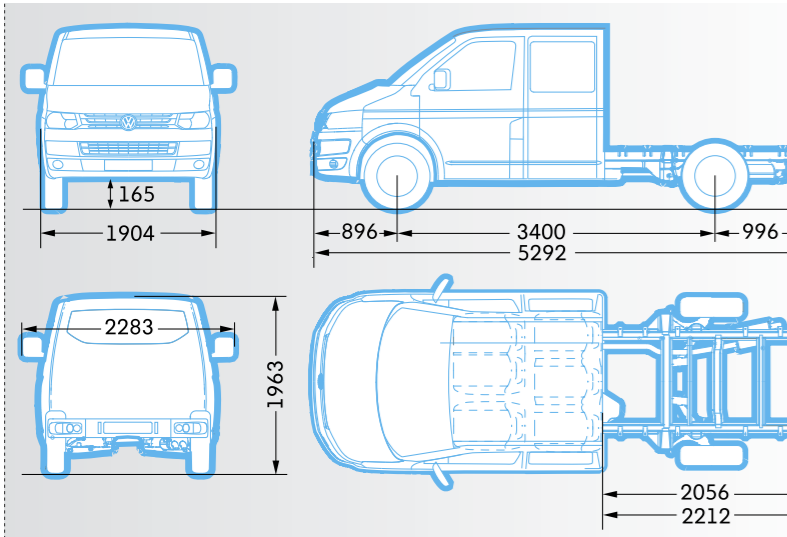

Dimensions in mm unless otherwise stated.

† Unladen weight and payload figures are calculated with approximately 90% fuel load and a 75kg allowance for driver. The published payload figure is based on a standard specification vehicle.

It does not include any items of optional equipment. Any optional equipment will reduce the payload from the published figure.

Model / gross vehicle weight (kg)	Engine/transmission	Axle load limit front/rear (kg)	Trailer weight braked 12%/unbraked (kg)	Gross train weight (kg)	Unladen weight† (kg)	Payload† (kg)
T30 3,000	2.0TDI 84PS	1,525 / 1,680	2,200 / 750	4,800	1,601	1,399
3,000	2.0TDI 102PS	1,525 / 1,680	2,200 / 750	4,900	1,601	1,399
3,000	2.0TDI 140PS	1,575 / 1,680	2,500 / 750	5,200	1,636	1,364
3,000	2.0TDI 140PS DSG	1,575 / 1,680	2,500 / 750	5,300	1,655	1,345
3,000	2.0TDI 140PS 4MOTION®	1,600 / 1,680	2,500 / 750	5,300	1,757	1,243

T30 TRANSPORTER CHASSIS CAB (WITH OPTIONAL FACTORY-FITTED DROPSIDE BODY)

T30 3,000	2.0TDI 84PS	1,525 / 1,680	2,200 / 750	4,800	1,786	1,214
3,000	2.0TDI 102PS	1,525 / 1,680	2,200 / 750	4,900	1,786	1,214
3,000	2.0TDI 140PS	1,575 / 1,680	2,500 / 750	5,200	1,821	1,179
3,000	2.0TDI 140PS DSG	1,575 / 1,680	2,500 / 750	5,300	1,840	1,160
3,000	2.0TDI 140PS 4MOTION®	1,600 / 1,680	2,500 / 750	5,300	1,942	1,058

Wheelbase	3,400	Turning circle (wall to wall)	13.2m
------------------	-------	--------------------------------------	-------

Model / gross vehicle weight (kg)	Engine/transmission	Axle load limit front/rear (kg)	Trailer weight braked 12%/unbraked (kg)	Gross train weight (kg)	Unladen weight† (kg)	Payload† (kg)
T30 3,000	2.0TDI 102PS	1,600 / 1,680	2,200 / 750	4,900	1,734	1,266
3,000	2.0TDI 140PS	1,600 / 1,680	2,500 / 750	5,200	1,769	1,231
3,000	2.0TDI 140PS DSG	1,600 / 1,680	2,500 / 750	5,300	1,788	1,212
3,000	2.0TDI 140PS 4MOTION®	1,600 / 1,680	2,500 / 750	5,300	1,889	1,111

T30 TRANSPORTER DOUBLE CAB (WITH OPTIONAL FACTORY-FITTED DROPSIDE BODY)

T30 3,000	2.0TDI 102PS	1,600 / 1,680	2,200 / 750	4,900	1,883	1,117
3,000	2.0TDI 140PS	1,600 / 1,680	2,500 / 750	5,200	1,918	1,082
3,000	2.0TDI 140PS DSG	1,600 / 1,680	2,500 / 750	5,300	1,937	1,063
3,000	2.0TDI 140PS 4MOTION®	1,600 / 1,680	2,500 / 750	5,300	2,038	962

Wheelbase	3,400	Turning circle (wall to wall)	13.2m
------------------	-------	--------------------------------------	-------

Economy and performance: Transporter chassis and double cab

Engine	Urban mpg (l/100km) ¹	Extra-urban mpg (l/100km) ¹	Combined mpg (l/100km) ¹	Acceleration 0-62 mph (seconds)	Top speed mph (where law permits)	CO ₂ emissions (g/km) ¹
T30 CHASSIS CAB						
2.0TDI 84PS	28.8 (9.8)	40.9 (6.9)	35.8 (7.9)	19.5	83	208
2.0TDI 102PS	28.8 (9.8)	40.9 (6.9)	35.8 (7.9)	15.2	88	208
2.0TDI 140PS	27.7 (10.2)	40.9 (6.9)	34.9 (8.1)	12.4	97	214
2.0TDI 140PS DSG	27.2 (10.4)	38.2 (7.4)	33.2 (8.5)	12.3	96	224
2.0TDI 140PS 4MOTION®	27.2 (10.4)	37.7 (7.5)	32.8 (8.6)	13.0	95	226

T30 CHASSIS CAB (WITH OPTIONAL FACTORY-FITTED DROPSIDE BODY)

2.0TDI 84PS	28.8 (9.8)	40.9 (6.9)	35.8 (7.9)	19.5	83	208
2.0TDI 102PS	28.8 (9.8)	40.9 (6.9)	35.8 (7.9)	15.2	88	208
2.0TDI 140PS	27.7 (10.2)	40.9 (6.9)	34.9 (8.1)	12.4	97	214
2.0TDI 140PS DSG	27.2 (10.4)	38.2 (7.4)	33.2 (8.5)	12.3	96	224
2.0TDI 140PS 4MOTION®	27.2 (10.4)	37.7 (7.5)	32.8 (8.6)	13.0	95	226

T30 DOUBLE CAB

2.0TDI 102PS	28.8 (9.8)	40.9 (6.9)	35.8 (7.9)	15.9	89	208
2.0TDI 140PS	27.7 (10.2)	40.9 (6.9)	34.9 (8.1)	12.7	98	214
2.0TDI 140PS DSG	27.2 (10.4)	38.2 (7.4)	33.2 (8.5)	12.6	98	224
2.0TDI 140PS 4MOTION®	27.2 (10.4)	37.7 (7.5)	32.8 (8.6)	13.5	96	226

T30 DOUBLE CAB (WITH OPTIONAL FACTORY-FITTED DROPSIDE BODY)

2.0TDI 102PS	28.8 (9.8)	40.9 (6.9)	35.8 (7.9)	15.9	89	208
2.0TDI 140PS	27.7 (10.2)	40.9 (6.9)	34.9 (8.1)	12.7	98	214
2.0TDI 140PS DSG	27.2 (10.4)	38.2 (7.4)	33.2 (8.5)	12.6	98	224
2.0TDI 140PS 4MOTION®	27.2 (10.4)	37.7 (7.5)	32.8 (8.6)	13.5	96	226

¹The fuel consumption and emission test values shown are in full compliance of the fuel consumption directive 80/1268/EWG

Notes

*Scribble any queries
you have here so you
don't forget them*

Keep track of your costs

The van (see pages 14-23)	Basic price (ex VAT)	Total RRP (inc VAT)
Model (eg: Transporter panel van T30 LWB 2.0TDI 140PS DSG)		
Base model total	£	£
Trim (see pages 24-29)		
Trim (eg: standard, Trendline, Highline etc.)		
Trim total	£	£
Options (see pages 42-63)		
Factory-fit options (eg: alloy wheels, roof rack, sat-nav etc.)		
Options total	£	£
Add Ons (see page 64-65)		
You can add any item from our Add Ons accessories range when you buy your vehicle. Pick up an Accessories brochure to see the full selection		
Add Ons total	£	£
Grand total	£	£

The small print and the footnotes

Print processes do not allow exact reproduction of the paint and upholstery colours. Some of the vehicles shown are fitted with optional equipment at extra charge.

All data given and specifications are in accordance with information available at the time of going to print and are subject to change without notice. Vehicles not in current UK stock and customer order vehicles may take a number of weeks for delivery. Certain combinations of vehicle specifications and factory-fitted extras are not compatible and therefore all orders received are subject to confirmation. Models, factory-fitted options and paint and upholstery options subject to availability. Please check details and availability with an appropriate authorised Volkswagen Van Centre at the time of ordering.

Volkswagen Commercial Vehicle Finance is a trading name of Volkswagen Financial Services (UK) Limited. Finance subject to status, and available to over 18s only.

Full details of Volkswagen warranties are available from your authorised Volkswagen Van Centre or Van Service Centre.

Volkswagen Commercial Vehicle Insurance is a trading name of Volkswagen Insurance Service (Great Britain) Limited, an appointed representative of Volkswagen Financial Services (UK) Limited, Brunswick Court, Yeomans Drive, Blakelands, Milton Keynes MK14 5LR. Registered in England number 2835230. Volkswagen Commercial Vehicle Insurance is sold, underwritten and administered by Allianz Insurance plc registered in England number 84638. Registered office 57 Ladymead, Guildford, Surrey GU1 1DB. Volkswagen Financial Services (UK) Limited and Allianz Insurance plc are authorised and regulated by the Financial Services Authority. Volkswagen Financial Services (UK) Limited and Allianz Insurance plc are not part of the same corporate group

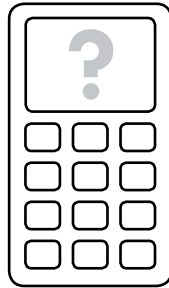

Work out how much it costs

Turn over to keep track of the prices of the vehicle and options you're choosing. Then take this page into your Van Centre.

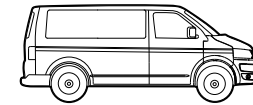
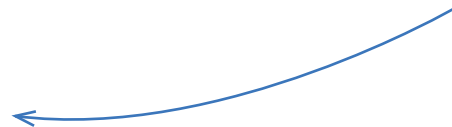

Get in touch with the experts

To find your nearest Van Centre call

0800 717131

or visit www.volkswagen-vans.co.uk

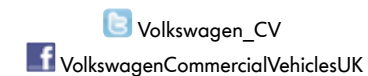

Issue: January 2013

Printed in the UK, 2 January 2013. CVW711TRVANS

This brochure supersedes all previous publications