



> View price list



> View offers



> Book a test drive



> Mercedes-Benz Magazine

The B-Class.



Mercedes-Benz





> View price list



> View offers



> Book a test drive



> Mercedes-Benz Magazine

The new generation B-Class. For the best of what's coming up.

Set off. With a Sports Tourer which, with its agility and comfort, makes every outing a little voyage in its own right. Discover uncharted territories with sustainably innovative drive systems and, on request, with the dynamic all-wheel drive system 4MATIC. And everything is seen in the best light of the new optional LED High Performance headlamps. There is much to experience: the new generation B-Class.

FOR THE BEST IN EVERY FORMAT.



Experience the new generation B-Class in glorious HD. With the Mercedes-Benz brochure app for the iPad® and with the Digital Owner's Manual from "Mercedes-Benz Guides" for the iPhone®. Both apps feature a host of films and additional content and are available free of charge from the iTunes Store®.

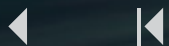



> View price list



> View offers



> Book a test drive



> Mercedes-Benz Magazine

For the best with every appearance:

4 | Mercedes-Benz B 250 4MATIC

polar silver metallic

AMG Line equipment line, AMG 5-twin-spoke light-alloy wheels, Exclusive package, Night package, cranberry red leather upholstery, high-gloss black ash wood trim

12 | Mercedes-Benz B 220 CDI

jupiter red

Urban equipment line, 5-twin-spoke light-alloy wheels, Night package, black leather upholstery

16 | Mercedes-Benz B 220 CDI

jupiter red

AMG Line equipment line, AMG 5-twin-spoke light-alloy wheels, AMG Exclusive package, Night package, RED CUT black leather upholstery, carbon-fibre-look trim

For the best in every detail:

20 | BlueEFFICIENCY

22 | Natural Gas Drive

24 | Engines

25 | 4MATIC all-wheel drive

26 | Active Parking Assist

27 | Integral safety concept

29 | COMAND Online

30 | Ambient lighting

31 | EASY-VARIO-PLUS system

32 | Equipment and packages

42 | Optional extras

43 | Genuine accessories

44 | Wheels

46 | Services

48 | Technical data

51 | Upholstery and paintwork

The illustrations may show accessories and optional extras which are not part of the standard specification.





> View price list



> View offers



> Book a test drive



> Mercedes-Benz Magazine



Fine and cultivated. From a good family.

A redesigned dynamic front apron, delicately styled headlamps – and a unique light show which pays as much attention as it draws: in conjunction with the optionally available LED High Performance headlamps the driver is greeted by a blue light when unlocking the doors. Get in and feel good. In a generous interior which is optimally prepared for all activities.

Some of the model features, optional extras and colours shown may not be available in your country, or may only be available in a different specification.





> View price list



> View offers



> Book a test drive



> Mercedes-Benz Magazine

For everything that
crosses your paths.



The reassuring feeling of driving a Mercedes-Benz accompanies you everywhere. Innovative driving assistance and safety systems support the driver and protect the occupants and other road users better than ever before. Like COLLISION PREVENTION ASSIST PLUS, which can warn the driver visually and acoustically about an impending rear-end collision and if necessary even instigate brake actuation. This is the new generation B-Class with Mercedes-Benz Intelligent Drive.

Some of the model features, optional extras and colours shown may not be available in your country, or may only be available in a different specification.





> View price list



> View offers



> Book a test drive



> Mercedes-Benz Magazine



Some of the model features, optional extras and colours shown may not be available in your country, or may only be available in a different specification.

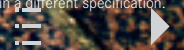



> View price list



> View offers



> Book a test drive



> Mercedes-Benz Magazine

LED HIGH PERFORMANCE HEADLAMPS

What does light technology in a Mercedes have to do? In particular during journeys at night it must not place more strain on the driver's eyes, and it should also be efficient and durable. The optional LED High Performance headlamps get straight to the point. The LED projector-beam technology in the low-beam headlamps and the LED reflection technology in the main beam optimally illuminate the road, at night even many times better than conventional headlamps. And this occurs with a pleasant colour temperature which corresponds to that of daylight.





> View price list



> View offers



> Book a test drive



> Mercedes-Benz Magazine



The best reason
to get active.

Some of the model features, optional extras and colours shown may not be available in your country, or may only be available in a different specification.





> View price list



> View offers



> Book a test drive



> Mercedes-Benz Magazine

Lights which brighten every mood.

Light contributes considerably to our wellbeing. One more reason to have it unfold its effect in a Mercedes. In the new generation B-Class the optional ambient lighting creates a unique feel-good atmosphere. Particularly at night its pleasantly indirect light accentuates the lines and the high-quality materials. The ambient lighting is based entirely on LED technology and offers twelve different colours and five dimmer settings.

Some of the model features, optional extras and colours shown may not be available in your country, or may only be available in a different specification.

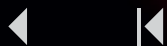



> View price list



> View offers



> Book a test drive



> Mercedes-Benz Magazine

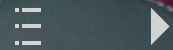



> View price list



> View offers



> Book a test drive



> Mercedes-Benz Magazine

A fiery statement, no exaggeration.

The stylishly coordinated combination of high-quality appointments and materials characterises the Exclusive package available on request. The multifunction steering wheel featuring a 3-spoke design and the shift lever are covered with fine leather. The luxury seats with upholstery in leather, for example in cranberry red, add a fashionable flourish and fine highlights with contrasting topstitching.

Some of the model features, optional extras and colours shown may not be available in your country, or may only be available in a different specification.





> View price list



> View offers



> Book a test drive



> Mercedes-Benz Magazine

Keep your distance.
Stay ahead.

12



COLLISION PREVENTION ASSIST PLUS

The distance is too short, and suddenly it's too late. Rear-end collisions are among the most common types of accident in road traffic. Reason enough for Mercedes-Benz to develop COLLISION PREVENTION ASSIST PLUS, a radar-based safety system which can minimise the risk of a rear-end collision or lessen the severity of an accident. This is how it works: if the system detects that the distance to the vehicle in front in the speed range between 30 and 250 km/h is too short, it warns the driver visually via a warning lamp in the instrument cluster. If the distance continues to lessen, there is an additional acoustic warning. In addition to this the Adaptive Brake Assist can support the driver's braking in order to prevent a collision. And should the driver not react at all, the system can intervene and reduce the speed via autonomous partial braking.

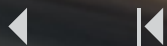



> View price list



> View offers



> Book a test drive



> Mercedes-Benz Magazine

Because the best is coming up.

B for best value: systematically optimised aerodynamics reduce the fuel consumption considerably. As a role model when it comes to environmental compatibility the B 200 Natural Gas Drive with the extremely efficient natural-gas drive Monovalent Plus is driving way ahead of its class.





> View price list



> View offers



> Book a test drive



> Mercedes-Benz Magazine





> View price list



> View offers



> Book a test drive



> Mercedes-Benz Magazine

The best in view.





> View price list



> View offers



> Book a test drive



> Mercedes-Benz Magazine



Captured on camera: the sporty AMG Line with the Night package. Powerful: the AMG bodystyling with the front and rear apron, side skirts and high-shine AMG light-alloy wheels. The Night package makes a striking impression with selected design elements in high-gloss black, such as the radiator trim with two black louvres and chrome inserts plus the bumpers featuring chrome.

Some of the model features, optional extras and colours shown may not be available in your country, or may only be available in a different specification.





> View price list



> View offers



> Book a test drive



> Mercedes-Benz Magazine

When the views are breathtaking.

With the optional AMG Exclusive package and its exclusivity and individuality the entire interior is literally on red alert. Whether on the upholstery in RED CUT black leather, the dashboard and the door centre panels in ARTICO man-made leather or on the multifunction sports steering wheel in leather with a flattened bottom section – red contrasting topstitching adds sportily distinctive highlights.

Some of the model features, optional extras and colours shown may not be available in your country, or may only be available in a different specification.





> View price list



> View offers



> Book a test drive



> Mercedes-Benz Magazine





> View price list



> View offers



> Book a test drive



> Mercedes-Benz Magazine

What makes a car a Mercedes?

Deep-rooted traditions: in our case, it is innovative traditions that run deep. We have continually gone down previously uncharted avenues. Milestone by milestone. These ventures spawned the first vehicle with a crumple zone, the first ABS, the first diesel car. The first automobile. But rather than wallowing in the past, let us look to the future.

Mercedes-Benz Intelligent Drive – on the road to accident-free driving. We develop intelligent assistance systems which actively support the driver and noticeably relieve the driver’s workload. They monitor and analyse the vehicle’s surroundings and handling – and warn the driver if they identify any critical situations. When necessary, some of the systems are able to intervene to take corrective action. Potential dangers are identified earlier than ever – and ever more frequently avoided as a result. Discover the fascinating world of Mercedes-Benz Intelligent Drive at www.mercedes-benz-intelligent-drive.com

BlueEFFICIENCY – our vision of emission-free driving. Sustainability is a big word to which we lend real meaning in all that we do, down to the smallest details. From minimising the environmental impact of our production operations to alternative drive concepts.



Welcome to a world that revolves around you. We focus on people. This is the standard we adhered to when we developed a new platform for your personal contact with Mercedes-Benz. With individual services made for you. “connect me” links the vehicle with your world, with everything that is important to you. “move me” offers new mobility solutions. And with “inspire me” we give you an exclusive look ahead at the future of mobility. Your access to an exciting world: www.mercedes.me

As you can see, we have major goals in our sights. And what could be better than seeing these aims achieved whilst on a long drive in a Mercedes?

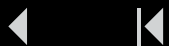
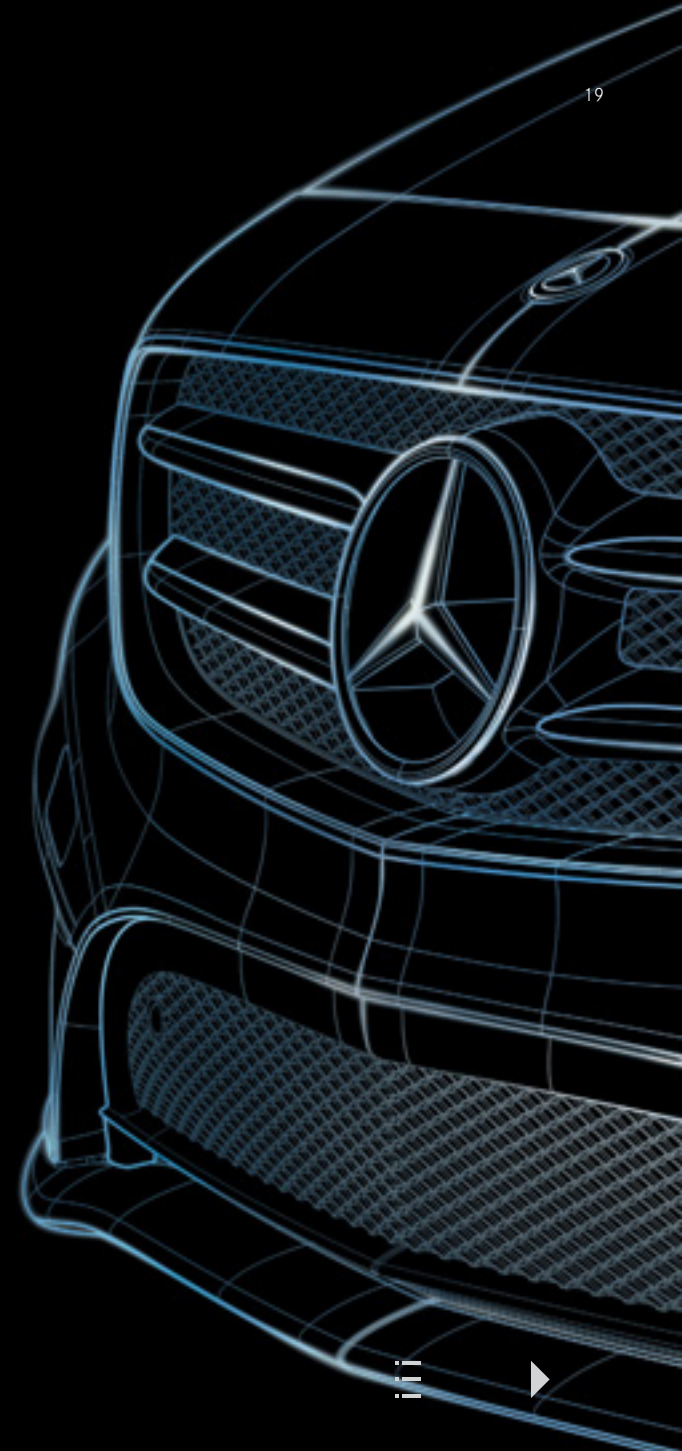



> View price list



> View offers



> Book a test drive



> Mercedes-Benz Magazine



2

1 3



- 1 Adjustable radiator shutter (B 180 CDI BlueEFFICIENCY Edition)
- 2 ECO display in the instrument cluster
- 3 The refrigerant compressor controlled to save energy is only active when required
- 4 Extensive aerodynamic optimisations for low consumption values and quiet running
- 5 Dual clutch transmission 7G-DCT
- 6 Tyres with reduced rolling resistance





> View price list



> View offers



> Book a test drive



> Mercedes-Benz Magazine



5 6





> View price list



> View offers



> Book a test drive



> Mercedes-Benz Magazine

NATURAL GAS DRIVE

The gas cylinders for the B 200 Natural Gas Drive are – safely stowed away – in the underbody. Two with a capacity of 19.2 l each, one beneath the rear bench seat with 88 l. Through this design the boot capacity remains at the same level as that of a B-Class with a conventional drive system.

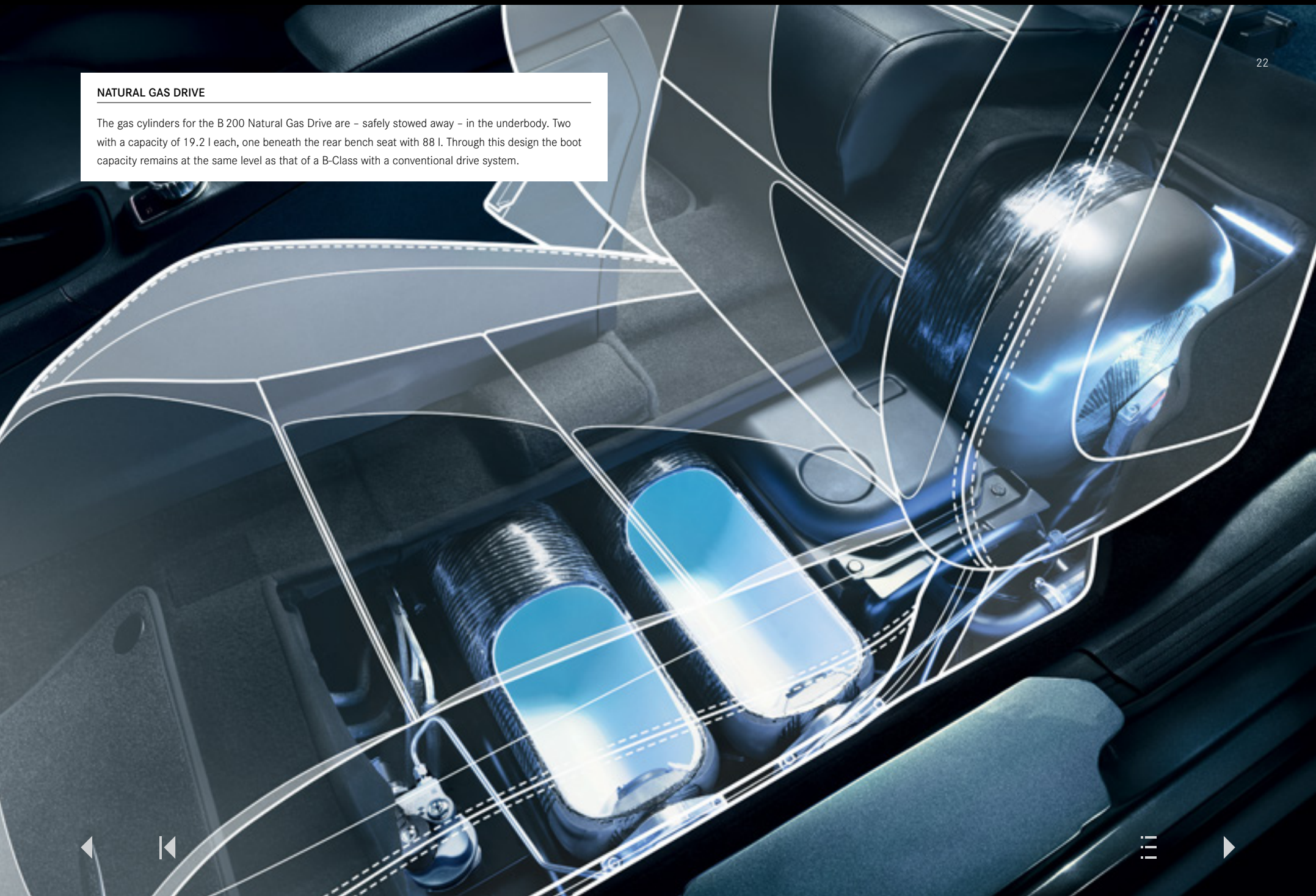



> View price list



> View offers



> Book a test drive



> Mercedes-Benz Magazine

Natural Gas Drive. The intelligent alternative.

The Monovalent Plus natural gas drive in the **B-Class Natural Gas Drive** astounds with very low emissions and low fuel costs with dynamic performance. Driven by a smooth and efficient 4-cylinder petrol engine with direct injection and turbocharging. Monovalent Plus means that the engine is basically run on natural gas. Three natural gas tanks ensure a range of up to 500 km. A bonus where mobility is concerned is offered by the 12 l fuel tank for up to 220 km more. Should the gas stock ever be exhausted, the vehicle automatically and undiscernibly switches over to petrol operation. The engine output in each case is identical. Once the natural gas tanks have been refilled, the journey is continued under natural gas operation.



23





> View price list



> View offers



> Book a test drive



> Mercedes-Benz Magazine

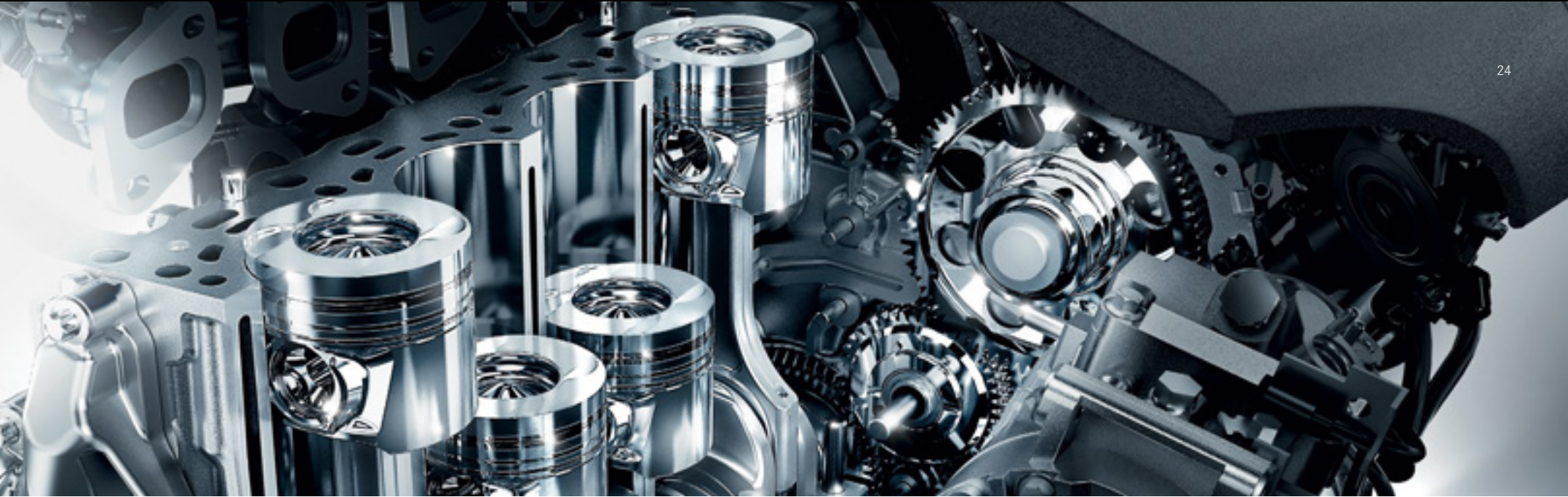

Driving ambition.

Extremely efficient diesel and petrol engines from the latest generation in a total of eight output categories are available for the new generation B-Class. All engines are turbocharged and fitted with an ECO start/stop function as standard. There is also an alternative drive configuration for particularly environmentally friendly mobility in the form of the Monovalent Plus natural-gas drive in the B 200 Natural Gas Drive (see the previous double page).

Depending on the engine the power transmission is via a 6-speed manual transmission or the automatic dual clutch transmission 7G-DCT, which changes gear very smoothly with virtually no interruption in tractive power.

▾ FIND OUT MORE

All the technical data for the new generation B-Class can be found on page 48/49.

THE ENGINE RANGE

Diesel:

B 160 CDI with 66 kW (90 hp) output and 240 Nm torque

B 180 CDI with 80 kW (109 hp) output and 260 Nm torque

B 180 CDI BlueEFFICIENCY Edition with 80 kW (109 hp) output and 260 Nm torque

B 200 CDI/B 200 CDI 4MATIC with 100 kW (136 hp) output and 300 Nm torque

B 220 CDI/B 220 CDI 4MATIC with 130 kW (177 hp) output and 350 Nm torque

Petrol:

B 180 with 90 kW (122 hp) output and 200 Nm torque

B 180 BlueEFFICIENCY Edition with 90 kW (122 hp) output and 200 Nm torque

B 200 with 115 kW (156 hp) output and 250 Nm torque

B 220 4MATIC with 135 kW (184 hp) output and 300 Nm torque

B 250/B 250 4MATIC with 155 kW (211 hp) output and 350 Nm torque

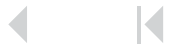

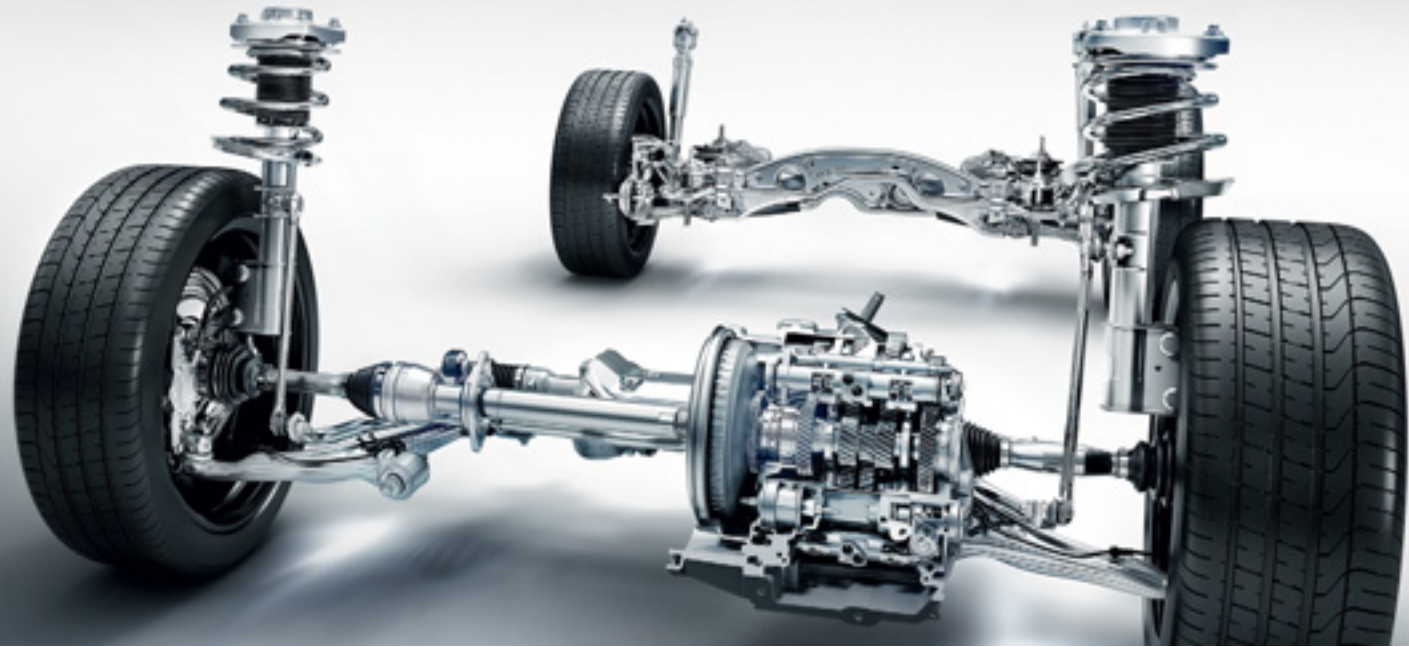

On the gripping subject of traction. 4MATIC all-wheel drive.

Specially developed for the platform of the new generation B-Class. In normal conditions as efficient as purely front-wheel drive, but with tangibly more traction in the wet or snow. This is the **all-wheel drive system 4MATIC** for the new generation B-Class.

An electrohydraulically controlled multiple-disc clutch integrated in the rear axle differential enables variable torque distribution. This ranges from particularly economical pure front-wheel drive, e.g. for steady motorway driving, to 50:50 split on snow or slippery road surfaces or in dynamic driving manoeuvres.

FASCINATION OF CHASSIS AND STEERING

An even balance of comfort and dynamism is offered by the **comfort suspension**. Low levels of rolling and pitching improve vehicle control and handling safety.

The **lowered comfort suspension** offers particularly comfortable springing. Lowering the body by 20 mm at the front and 15 mm at the rear improves aerodynamics.

Speed-sensitive steering provides variable power assistance dependent on speed. At high speeds the servo assistance is reduced; at lower speeds it is continually increased.

The **Sports Direct-Steer system** adds to the comfort of speed-sensitive power steering with a variable ratio dependent on the steering angle. On winding roads, for example, this produces a more agile handling response and improved straight-line stability.





> View price list



> View offers



> Book a test drive



> Mercedes-Benz Magazine

May we introduce? Your personal assistant.

The optional **Active Parking Assist with PARKTRONIC** makes it easier to find a parking space and also to enter or leave parking spaces. On request it automatically steers the car into parallel and now also into perpendicular parking spaces.¹ The Active Parking Assist is automatically switched on when driving forwards up to 35 km/h and flags up suitable parking spaces. When the driver engages reverse gear and confirms the suggested parking space, Active Parking Assist automatically carries out the steering manoeuvres up to a speed of 10 km/h.

¹ Applies only to automatic cars.

HOW ATTENTIVE: FURTHER OPTIONAL ASSISTANTS

The **reversing camera** is activated automatically when reverse gear is engaged and on the CENTRAL MEDIA DISPLAY shows the driver the area behind the vehicle together with dynamic guide lines.

The optional **Traffic Sign Assist** system is able to recognise speed limits, no-entry and no-overtaking signs and their cancellation, and display them to the driver.

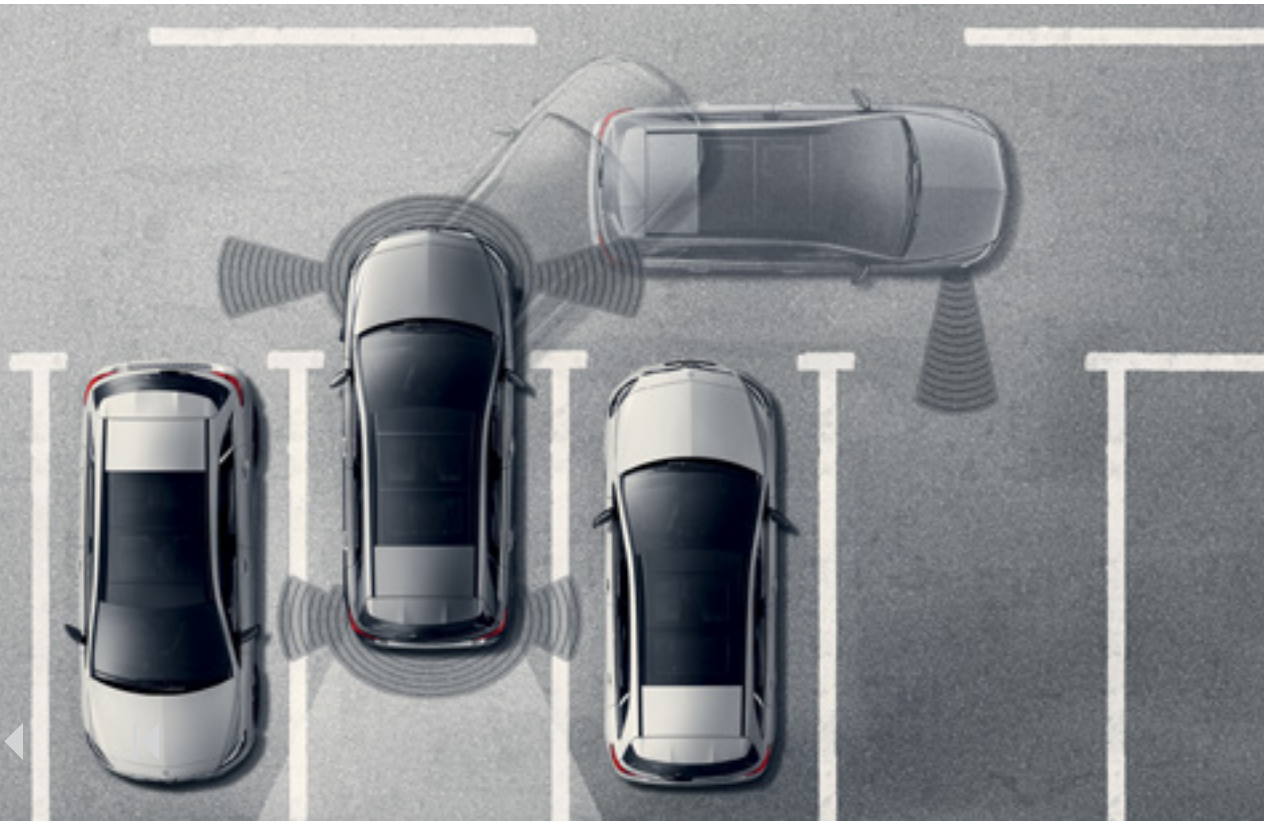



The reassuring feeling of driving a Mercedes-Benz.

We are the first automotive manufacturer worldwide to have developed an **integral safety concept**, aimed at avoiding accidents, ensuring ideal responses to dangers and lessening the consequences of accidents. For the occupants of a Mercedes and for all other road users, too.

SAFE DRIVING

The **drowsiness detection system ATTENTION ASSIST** serves to enhance driving safety, especially on long trips and at night. It monitors the steering behaviour of the driver to recognise typical signs of drowsiness and severe loss of attention, and gives a visual and acoustic warning of impending microsleep.

The **ADAPTIVE BRAKE control system** improves braking performance through intelligent intervention: in wet conditions, the brake discs are kept dry. The brake pads are applied automatically when the driver's foot is removed abruptly from the accelerator pedal. And on uphill slopes, the system can prevent the vehicle from rolling backwards.

The optional **DISTRONIC PLUS proximity control** helps maintain a safe distance from the vehicle ahead above all in stop-and-go traffic. It can brake the vehicle automatically and accelerate again as appropriate to the traffic situation. If a risk of a rear-end collision arises, **COLLISION PREVENTION ASSIST PLUS** – part of DISTRONIC PLUS – can initiate autonomous partial braking if the driver fails to react, to avoid a collision or to lessen the consequences.

The optional **Blind Spot Assist** system employs radar sensors and can draw attention to one of the most serious sources of danger in road traffic. When a vehicle is detected in the blind spot, a red triangle lights up in the exterior mirror. An acoustic warning additionally sounds as necessary. The system is active at speeds between 30 and 250 km/h. The optional **Lane Keeping Assist** system is able to recognise when the vehicle is unintentionally drifting out of its lane at speeds between 60 and 200 km/h, duly warning the driver via pulsed vibrations on the steering wheel. Blind Spot Assist and Lane Keeping Assist also form part of the optional **Lane Tracking package**.

IN THE EVENT OF DANGER

The optional **PRE-SAFE® occupant protection system** is able to identify critical driving situations in advance and to initiate precautionary measures to protect the vehicle's occupants if an accident appears imminent. Such measures include reversible belt tensioning or automatic closing of open side windows, for example.

IN AN ACCIDENT

In an accident, the intelligently coordinated restraint systems and the structure of the vehicle's bodyshell make an effective contribution towards optimum protection for the vehicle's occupants. First and foremost the airbags: front airbags for the driver and front passenger each triggered in two stages depending on the registered severity of the impact, sidebags for the driver and front passenger, windowbags between the A- and C-pillars, a kneebag for the driver plus optional sidebags in the rear.

AFTER AN ACCIDENT

If the worst comes to the worst, the engine can be stopped automatically, the hazard warning lights and emergency interior lighting can be activated, and the central locking can be unlocked. Finally the **Mercedes-Benz emergency call system** (country-specific) can send GPS position data and important vehicle information.





> View price list



> View offers



> Book a test drive



> Mercedes-Benz Magazine





The internet has changed our lives. Now it is changing the world of driving, too.

Navigation, telephone, audio, video, internet – all this is presented in high resolution by the optional **COMAND Online** control and display system on a 20.3 cm (8-inch) display. Fast hard-disc navigation with realistic topographical map display for relaxed route guidance. In combination with a suitable mobile phone you can call up internet sites when the vehicle is stationary and use Mercedes-Benz Apps such as POI search or weather while out and about. A DVD player, radio and interfaces to allow connection to external devices are provided, giving a range of customised entertainment options. Other COMAND Online highlights are the voice-operated control system LINGUATRONIC, Bluetooth® interface with hands-free function, text message reading function and music transfer via audio streaming.

FURTHER INFOTAINMENT OPTIONS

The additional option **Live Traffic Information** (part of COMAND Online) facilitates the reception of the latest and precise traffic information for optimised dynamic route guidance and precisely calculated arrival times.

With twelve loudspeakers, including a woofer, and a 9-channel DSP amplifier the 450 W **Harman Kardon® Logic 7® surround sound system** combines with audio systems to offer a perfect listening experience, in conjunction with COMAND Online also in DTS and Dolby Digital 5.1 format.

User-friendly navigation, precise map data and excellent route guidance – the **Garmin® MAP PILOT** brings all the familiar benefits of a Garmin® navigation system to the Audio 20 CD. It is done by simply inserting an SD card with navigation software and map data sets.





> View price list



> View offers



> Book a test drive



> Mercedes-Benz Magazine

The ambient lighting bids you a warm welcome.

Climb in and feel at home – with its pleasant, indirect light the **ambient lighting** available in combination with the optional Light and Sight package creates a real sense of wellbeing throughout the entire interior. Especially at night, it accentuates the contouring and high quality of the interior design, imparts a feeling of security thanks to an impression of generous spaciousness and reduces dazzle from oncoming traffic. Twelve different colours and five dimming levels are available to create the desired lighting mood. The ambient lighting features full LED technology, and is conveniently controlled via the instrument cluster. It also switches on when the doors are opened, welcoming the passengers on board.

MORE LIGHT, PLEASE

The optional **Light and Sight package** provides a higher quality feel for the interior and optimum visibility in the car. It comprises the single-tone ambient lighting, function illumination and a rain sensor for the windscreen wipers.

The optional brushed stainless steel **door sill panels** set sporty exclusive highlights with their illuminated “Mercedes-Benz” lettering. They also protect the entrance area from damage.

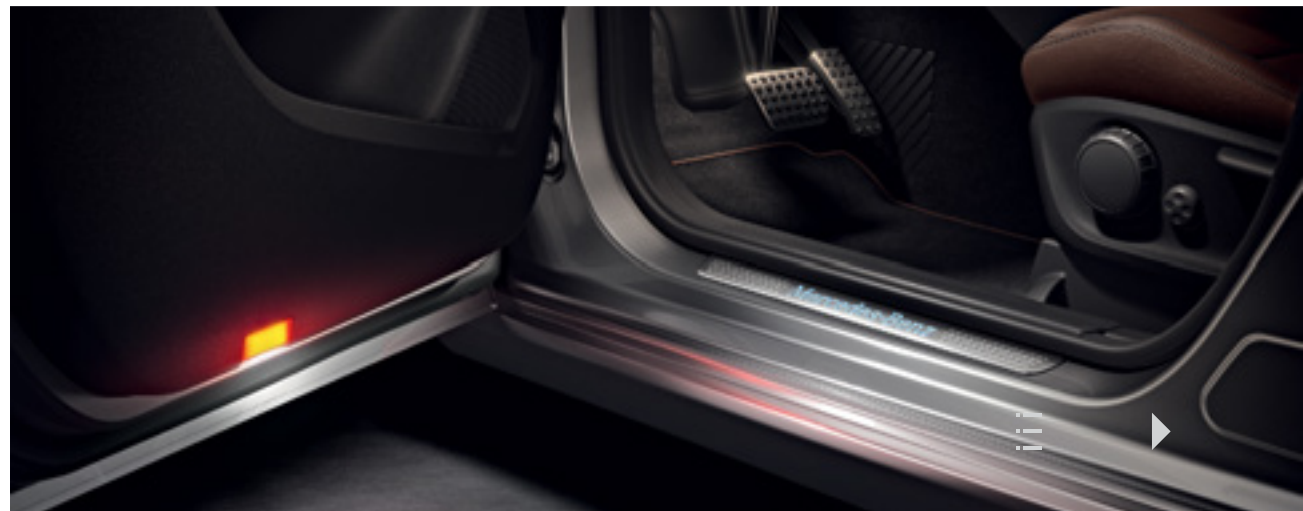



> View price list



> View offers



> Book a test drive



> Mercedes-Benz Magazine

A dream of a load compartment.

The optional **EASY-VARIO-PLUS system** comprises the Load Compartment package with a load compartment floor adjustable at two heights. In the higher position, this creates a surface that is almost level with the load compartment sill. This can be extended still further by folding down the backrests of the rear seats. In the lower position, the load space is enlarged, making it possible to load particularly high items. The front passenger seat can be folded forward. This allows the backrest to be used as a table by the rear-seat passengers, or the extra space to be used to load particularly long items. The angle of the rear-seat backrests can be adjusted to a 90° cargo position. This extends the load space, but means that the rear seats can still be used for passengers. In addition to this all the rear seats can be slid forwards. The folding armrest with two cup holders offers a practical through-loading feature.

FURTHER LOAD COMPARTMENT OPTIONS

For more order, safety and additional stowage areas in the load compartment there is the optional **Load Compartment package** with a height-adjustable load compartment floor, a 12 V socket and a folding box beneath the load compartment floor.

Adapted protection for children aged about two to twelve years comes in the form of the optional **child seats** integrated in the outer rear seats. For children aged about two to four years a side head restraint (already included) and a special padded play table are additionally required.





> View price list



> View offers



> Book a test drive



> Mercedes-Benz Magazine





> View price list



> View offers



> Book a test drive



> Mercedes-Benz Magazine



The standard equipment.

You can put together a new generation B-Class to suit you. Marvel at the extensive standard equipment.

EXTERIOR HIGHLIGHTS

- Steel wheels with 10-hole trims, with 195/65 R 15//205/55 R 16 (R00//643) tyres*
- 10-spoke light-alloy wheels with 225/45 R 17 (R43) tyres*
- Reflection-type headlamps
- Window weatherstrip and waistline trim in matt black plastic
- Door handles and bumpers painted in vehicle colour
- Comfort suspension

* Wheels depending on the engine (detailed allocation in the price list).

INTERIOR HIGHLIGHTS

- Seats with Venlo fabric fabric (Vianen upholstery for B 200 Natural Gas Drive)
- Matrix-look trim
- 3-spoke multifunction steering wheel with twelve control buttons
- Roof lining in crystal grey

FIND OUT MORE

As fine as the new generation B-Class is, it is just a first impression. For the complete range of standard equipment please refer to the price list, which is also available for viewing online.





> View price list



> View offers



> Book a test drive



> Mercedes-Benz Magazine



Reassuringly stylish: The Style line.

Whether you are cruising the boulevards or exploring the countryside, these perfectly matched stylish design and comfort features exude self-assurance and individuality.

EXTERIOR HIGHLIGHTS

10-spoke light-alloy wheels with 205/55 R 16 (55R) tyres

7-twin-spoke light-alloy wheels with 205/55 R 16 tyres (R27, for B 200 Natural Gas Drive)

Radiator trim with two louvres painted in iridium silver and chrome inserts

Beltline trim strip in chrome

Long chrome trim strip on the rear bumper

INTERIOR HIGHLIGHTS

Seats with accentuated shoulder area and Vianen fabric upholstery

Seat Comfort package

Line-pattern trim

3-spoke multifunction steering wheel with trim in silver chrome

Shift lever featuring use of silver-chrome trim

Instrument cluster with 11.4 cm (4.5-inch) TFT colour multifunction display

High-gloss black light switch with ring in silver chrome





> View price list



> View offers



> Book a test drive



> Mercedes-Benz Magazine





> View price list



> View offers



> Book a test drive



> Mercedes-Benz Magazine





> View price list



> View offers



> Book a test drive



> Mercedes-Benz Magazine



Inspiringly progressive: The Urban line.

Take in the sights in your urbane Mercedes. Everywhere you look, there are fresh new design features awaiting discovery, while the interior offers a highly individual style.

EXTERIOR HIGHLIGHTS

5-spoke light-alloy wheels, with 225/45 R 17 (R04) tyres

Multi-spoke light-alloy wheels with 225/55 R 17 tyres (08R, for B 200 Natural Gas Drive)

Radiator trim with two louvres painted in iridium silver and chrome inserts

Two-pipe exhaust system with tailpipe trims in chrome look (except B 200 Natural Gas Drive)

Shoulderline trim strips in chrome

Short chrome trim strip on the rear bumper

INTERIOR HIGHLIGHTS

Seats with accentuated shoulder area and upholstery in ARTICO man-made leather/Montfort fabric with contrasting topstitching

Sail-look trim

3-spoke multifunction steering wheel in leather, with perforated grip area and twelve control buttons and also topstitching and trim in silver chrome

Shift lever in perforated leather with contrasting topstitching and use of silver-chrome trim

Instrument cluster with silver-coloured round dials and red needles, plus 11.4 cm (4.5-inch) TFT colour multifunction display

Roof liner black (optional: roof liner crystal grey)





> View price list



> View offers



> Book a test drive



> Mercedes-Benz Magazine



AMG Line.

Take the new generation B-Class to the sporting pinnacle where its look, driving feel and exclusivity are concerned. The AMG Line design and equipment line comprises extensive AMG bodystyling and further measures for enhancing driving dynamics. In the interior, too, which presents itself in decidedly sporty guise.

AMG Line initially exclusively available in conjunction with Exclusive package or AMG Exclusive package. Availability of the AMG Line – without the packages mentioned – in all likelihood from January 2015.

EXTERIOR HIGHLIGHTS

- AMG bodystyling with front and rear apron and side sill panels
- AMG 5-twin-spoke light-alloy wheels, painted titanium grey and with a high-sheen finish, with 225/40 R 18 tyres (794)
- Radiator trim with two louvres painted in iridium silver with chrome inserts
- Two-pipe exhaust system with tailpipes in chrome look
- Lowered comfort suspension and Sports Direct-Steer system
- Perforated front brake discs
- Brake callipers with “Mercedes-Benz” lettering at the front

INTERIOR HIGHLIGHTS

- Seats with accentuated shoulder area and upholstery in ARTICO man-made leather/black DINAMICA microfibre with contrasting topstitching
- Carbon-fibre-look trim
- 3-spoke multifunction sports steering wheel in leather, with a flattened bottom section, perforated in the grip area and with red contrasting topstitching
- Shift lever in perforated leather with red contrasting topstitching and use of silver-chrome trim
- Instrument cluster with silver-coloured round dials and red needles, plus 11.4 cm (4.5-inch) TFT colour multifunction display
- Brushed stainless steel sports pedals with rubber studs





> View price list



> View offers



> Book a test drive



> Mercedes-Benz Magazine





> View price list



> View offers



> Book a test drive



> Mercedes-Benz Magazine

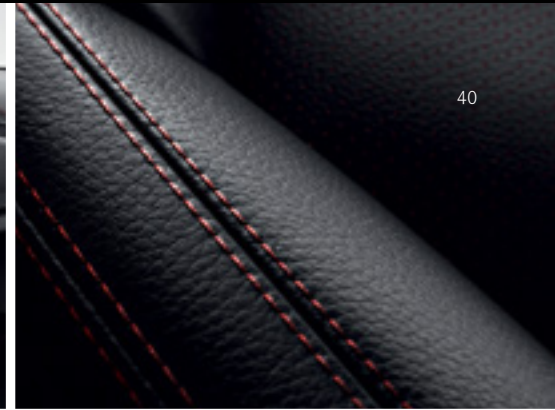

40



Exclusive package.

The stylishly coordinated combination of selected interior appointments meets very high expectations with regard to comfort, quality and design. The highlights include heated front seats with 4-way lumbar support, which are covered in fine leather to match the multifunction steering wheel and gearshift lever. The dashboard and the door centre panels are finished in matching ARTICO man-made leather. Design features in silver chrome and trim in open-pore eucalyptus wood or high-gloss black ash also contribute to the exclusive ambience.

AMG Exclusive package.

Building on the AMG Line, this equipment package offers maximum exclusivity, individuality and sportiness. Highlights include the heated seats with 4-way lumbar support, which make a striking impression with their RED CUT black leather upholstery with red contrasting topstitching. To match these seats, the dashboard and the door centre panels are finished in ARTICO man-made leather, as are the armrests in the doors. The multifunction sports steering wheel in leather with a flattened bottom section and perforated grip area, together with the shift lever in perforated leather, feature a look and feel that underscores the interior's sporty character. The red contrasting topstitching is to be found on all these features, indicating a loving attention to detail.





> View price list



> View offers



> Book a test drive



> Mercedes-Benz Magazine



Night package.

The Night package offers striking exterior features to lend the vehicle an expressive sporty character. These include selected design features in black. The radiator trim boasts two louvres in high-gloss black and chrome inserts. Also in black are the high-shine 5-twin-spoke 45.7 cm (18-inch) light-alloy wheels, the exterior mirror housings and the shoulderline trim strips. Dark-tinted heat-insulating glass from the B-pillar onwards shields the interior from prying eyes while underscoring the vehicle's sporty character.





> View price list



> View offers



> Book a test drive



> Mercedes-Benz Magazine

Optional equipment.

There are countless possibilities for making the new generation B-Class your own. From small details that add special touches to comfort features which until recently were still the reserve of the luxury segment. Take your time to browse around – in this brochure, the price list or online. You can easily configure the new generation B-Class according to your very own wishes at the national website for your own country, accessible via www.mercedes-benz.com



1
4



2



3

1 In addition to their distinctive look, the **LED High Performance headlamps**¹ boost night-time driving safety thanks to broad light distribution, a daylight-simulating colour temperature, and low energy consumption. The “Coming Home” function welcomes the driver with an exceptional light display from blue to white when they unlock the car. The tail lights feature LED technology and create a visual highlight while improving visibility.

2 **KEYLESS-GO**: the vehicle can be conveniently unlocked, started and locked with this access and drive authorisation system – simply by carrying the electronic key.

3 When not in use the **trailer coupling** can be folded behind the rear bumper to save space. The tow hitch is simply folded out to attach a car trailer or mount a bicycle carrier. A control with LED in the luggage compartment serves to release the coupling.

4 **Panoramic sliding sunroof**: with its large glazed areas, this roof system ensures a particularly light and welcoming ambience in the interior. The rear part consists of a fixed panoramic glass sunroof while the front part is an electrically operated glass sliding sunroof.

¹ Optional extra LED High Performance headlamps not available for B 200 Natural Gas Drive.





> View price list



> View offers



> Book a test drive



> Mercedes-Benz Magazine

Genuine accessories.

The new generation B-Class leaves virtually nothing to be desired. And for those extra special needs there are genuine accessories. These cover almost every conceivable need for more pleasant and individual motoring. Every accessory has been developed specifically according to Mercedes-Benz's high quality standards.

- 1 Makes you beam: the **illuminated Mercedes star**. The star centred in the radiator grille of your Mercedes will light up courtesy of fibre-optic cable and LED technology when the vehicle is locked and unlocked by remote control, and when doors or boot lid are opened. Functions only when the engine is switched off. Not in conjunction with DISTRONIC PLUS (code 239).
- 2 With the new optional high-resolution **Head-up Display** you always have the most important information, such as the speed, speed limits or navigation instructions, in view, depending on the equipment. For you it looks as though the display is floating two metres in front of your eyes above the bonnet. This ensures more safety as you no longer have to take your eyes off the road. A sensor adjusts the brightness of the display to the respective light conditions.
- 3 **Ski and snowboard rack New Alustyle "Comfort"**. Fits the anchorage on your basic carrier. For up to six pairs of skis* or four snowboards, lockable. The practical pull-out function makes loading and unloading easier.

iPad® rear-seat docking station. The easy-to-use docking station integrates the iPad® with all its familiar functions into your Mercedes-Benz in an ergonomic, crash-proof way. All connections, such as for your headphones or charging cable, remain accessible. The holder is secured to the head restraint and can be tilted and rotated by 90°. Available for the iPad® 2, iPad® 3 and iPad® 4.

DISCOVER THE ENTIRE RANGE

Now online at www.mercedes-benz-accessories.com



* Depending on the ski geometry.





> View price list



> View offers



> Book a test drive



> Mercedes-Benz Magazine

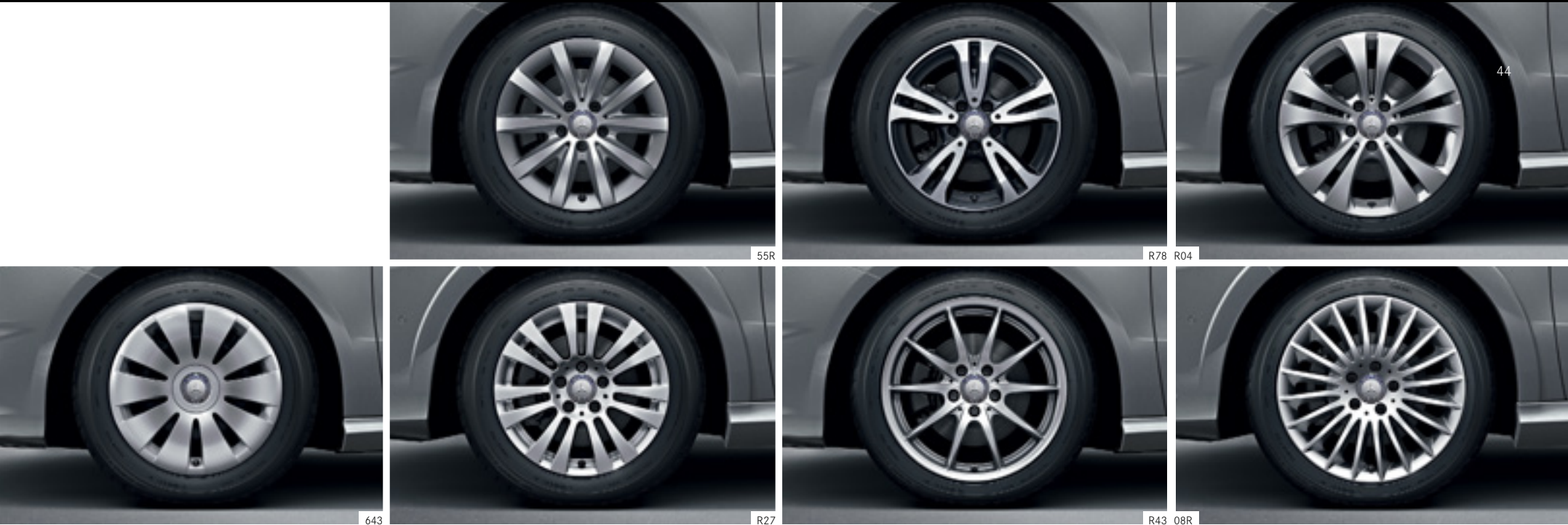

Wheels.

Wheels are indispensable on technical grounds, of course. But on an emotional level, too, perfect wheels are an absolutely crucial ingredient of many people's dream car. With this in mind, we have put together a particularly large and diverse selection for you.

STANDARD EQUIPMENT AND OPTIONAL EXTRAS

643 Steel wheel with 10-hole wheel trim with 205/55 R 16 tyres (standard for B 200 CDI, B 220 CDI, B 200, B 220 4MATIC and B 200 Natural Gas Drive; option for B 160 CDI, B 180 CDI BlueEFFICIENCY Edition, B 180 CDI, B 180 BlueEFFICIENCY Edition and B 180)

55R 10-spoke light-alloy wheel with 205/55 R 16 tyres (part of Style design and equipment line except B 200 Natural Gas Drive; option for all models except B 200 CDI 4MATIC, B 220 CDI 4MATIC, B 250, B 250 4MATIC and B 200 Natural Gas Drive)

R27 7-twin-spoke light-alloy wheel, painted vanadium silver, with 205/55 R 16 tyres (part of Style design and equipment line for B 200 Natural Gas Drive)

R78 5-twin-spoke light-alloy wheel, painted matt black and with a high-sheen finish, with 205/55 R 16 tyres (option for all models except B 200 CDI 4MATIC, B 220 CDI 4MATIC, B 250, B 250 4MATIC and B 200 Natural Gas Drive)

R43 10-spoke light-alloy wheel with 225/45 R 17 tyres (standard for B 200 CDI 4MATIC, B 220 CDI 4MATIC, B 250 and B 250 4MATIC; option for all further models except BlueEFFICIENCY models and B 200 Natural Gas Drive)

Some of the model features, optional extras and colours shown may not be available in your country, or may only be available in a different specification.

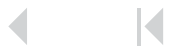



> View price list



> View offers



> Book a test drive



> Mercedes-Benz Magazine



25R



26R



791



45



44R



01R



794



646

R04 5-spoke light-alloy wheel, painted high-gloss black, with 225/45 R 17 tyres (part of Urban design and equipment line except BlueEFFICIENCY Edition models and B 200 Natural Gas Drive)

08R Multi-spoke wheel with 225/55 R 17 tyres (part of Urban design and equipment line for B 200 Natural Gas Drive)

25R 10-spoke light-alloy wheel, painted vanadium silver, with 225/50 R 17 tyres (option for all models except BlueEFFICIENCY Edition models and B 200 Natural Gas Drive)

44R 5-twin-spoke light-alloy wheel, painted tremolite grey, with 225/45 R 17 tyres (option for all models except BlueEFFICIENCY Edition models and B 200 Natural Gas Drive)

26R 7-twin-spoke light-alloy wheel with 225/45 R 17 tyres (option for all models except BlueEFFICIENCY Edition models and B 200 Natural Gas Drive)

01R 5-twin-spoke light-alloy wheel, painted black and with a high-gloss finish, with 225/40 R 18 tyres (standard in conjunction with Night package; option for all models except BlueEFFICIENCY Edition models and B 200 Natural Gas Drive)

791 Multi-spoke AMG light-alloy wheel, painted titanium grey and with a high-gloss finish, with 225/40 R 18 tyres (option, not in conjunction with Night package and not for BlueEFFICIENCY Edition models or B 200 Natural Gas Drive)

794 AMG 5-twin-spoke light-alloy wheel, painted titanium grey and with a high-gloss finish, with 225/40 R 18 tyres (part of AMG Line design and equipment line, not in conjunction with Night package and not for BlueEFFICIENCY Edition models or B 200 Natural Gas Drive)

781 AMG 5-twin-spoke light-alloy wheel, painted black and with a high-gloss finish, with 225/40 R 18 tyres (standard for AMG Line in conjunction with Night package; option for all models except BlueEFFICIENCY Edition models and B 200 Natural Gas Drive)

646 AMG multi-spoke light-alloy wheel, painted black and rim flange with a high-gloss finish, with 225/40 R 18 tyres (option for all models except BlueEFFICIENCY Edition models and B 200 Natural Gas Drive)

FURTHER WHEELS

can be found in our accessories range.

Information on the range of Mercedes-Benz Genuine Accessories is available at www.mercedes-benz-accessories.com or from your authorised Mercedes-Benz dealer.





More than simply a star. A whole universe.

The range of **services from Mercedes-Benz**. Every Mercedes brings with it as a standard feature a reassuring feeling of safety on the road. But if you ever do need help, we're here for you around the clock. You can reach us from anywhere in Europe on the toll-free number 00800 1 777 7777¹ (or alternatively directly through Mercedes-Benz Contact²).

Ensuring that you can keep moving in the event of a technical breakdown, accident, vandalism or even misfuelling, the **Mercedes-Benz mobility package Mobilo**³ is included as part of the standard specification. It covers the cost of local assistance, for example for towing your car away or for a replacement vehicle – and will do so in more than 40 countries across Europe for up to 30 years³. Furthermore, for the first four years following initial registration of the vehicle, Mobilo offers special mobility services in the case of workshop visits involving warranty or goodwill situations.

Avoid unexpected workshop costs⁴: a **Mercedes-Benz Service Contract** covers unforeseeable repairs, maintenance or wear parts, depending on the specific contract. Your local Mercedes-Benz dealer will be pleased to provide information about available service contracts and terms and conditions.

Mercedes-Benz Financial Services. Drive a Mercedes-Benz and remain flexible when it comes to payment: our attractive leasing and finance products make this possible – matched to your requirements and needs. We will also be happy to offer you a range of detailed insurance proposals. Just speak to your Mercedes-Benz dealer, who will be happy to provide information about our current range of financial services, terms and conditions.

¹ Alternatively: +49 69 95 30 72 77. Calls to a landline are chargeable. ² Calls from a mobile phone to a landline are chargeable. ³ When it expires, (four years after initial registration) Mobilo can be extended to up to 30 years from one service to the next by your authorised Mercedes-Benz service partner. ⁴ Mercedes-Benz service contract terms and conditions apply. Illustration right: MERCEDES AMG PETRONAS F1 W05, 2014 season.





Enjoy the digital experience of Mercedes-Benz – wherever you happen to be. Thanks to a range of offers optimised for smartphones and tablet computers, you can immerse yourself in the world of Mercedes-Benz even while on the move.

Insights into the full product range, a varied programme of entertainment and direct contact to a wide variety of services await you. Take an interactive tour with the **Interactive Owner’s Manual**, for example, to get to know your dream car better. Experience the various functions in detail, take a close-up look at what’s going on inside or explore the benefits of the particular model on your national Mercedes-Benz website.

With the **“Mercedes-Benz Guides”** app you can also explore the highlights of the various vehicles off-line. The app is available free of charge from the iTunes Store® (iOS) or the Google Play Store (Android).

Incidentally, our TV and magazine media are also available to watch and read digitally. Explore the whole brand world for yourself at www.mercedes-benz.com. Just click to take a look.

The **fascination of Mercedes-Benz**. A car whose name brings a gleam to the eyes of people all over the world, one that has featured in many a movie and been sung about in international hits, is surely far more than just a car. How did it come to this?

Discover just what has been moving the world for more than 125 years and take a fascinating journey through time as well as through the history of the automobile at the **Mercedes-Benz Museum**. More than 1500 exhibits over a display area of 16,500 square metres demonstrate the unique heritage and innovative power of the inventor of the automobile, among them one-off models such as the oldest Mercedes still in existence, built in 1902, or the legendary “Gullwing” cars. Welcome to a place of innovation: www.mercedes-benz-classic.com/museum

What would the history of Mercedes-Benz be like without **motorsport**? What would motorsport be without Mercedes-Benz? The first vehicle ever to win an automobile race was powered by a Daimler engine. The first Mercedes was a racing car. The Silver Arrows – a true legend. Out of this glorious past has grown an exciting present: the MERCEDES AMG PETRONAS Formula 1 team and the DTM Mercedes AMG C-Coupés fight it out weekend after weekend for points and victory.





Technical data.

DIESEL ENGINES

	B 160 CDI	B 180 CDI	B 180 CDI BlueEFFICIENCY Edition	B 200 CDI	B 200 CDI 4MATIC	B 220 CDI	B 220 CDI 4MATIC
No. of cylinders/arrangement	4/in-line	4/in-line	4/in-line	4/in-line	4/in-line	4/in-line	4/in-line
Total displacement in cc	1461	1461	1461	2143	2143	2143	2143
Rated output ¹ in kW (hp) at rpm	66 (90)/2750-4000	80 (109)/4000	80 (109)/4000	100 (136)/3600-3800	100 (136)/3600-3800	130 (177)/3400-4000	130 (177)/3400-4000
Rated torque ¹ in Nm at rpm	240/1700-2500	260/1750-2500	260/1750-2500	300/1400-3000	300/1400-3000	350/1400-3400	350/1400-3400
Transmission	6-speed, man. [7G-DCT]	6-speed, man. [7G-DCT]	6-speed, man. [-]	6-speed, man. [7G-DCT]	- [7G-DCT]	- [7G-DCT]	- [7G-DCT]
Acceleration from 0 to 100 km/h in s [7G-DCT]	14.0 [14.3]	11.6 [11.9]	11.6 [-]	9.9 [9.8]	- [9.8]	- [8.3]	- [8.3]
Top speed, approx. in km/h [7G-DCT]	180 [180]	190 [190]	190 [-]	210 [210]	- [207]	- [224]	- [220]
Tyre size, front	195/65 R 15	195/65 R 15	195/65 R 15	205/55 R 16	225/45 R 17	205/55 R 16	225/45 R 17
Tyre size, rear	195/65 R 15	195/65 R 15	195/65 R 15	205/55 R 16	225/45 R 17	205/55 R 16	225/45 R 17
Fuel	Diesel	Diesel	Diesel	Diesel	Diesel	Diesel	Diesel
Fuel consumption ² in l/100 km							
Urban [7G-DCT]	5.0-4.9 [4.5-4.0]	5.0-4.9 [4.5-4.0]	4.3 [-]	5.5-5.4 [4.9-4.7]	- [5.9-5.8]	- [5.0-4.9]	- [5.9-5.8]
Extra-urban [7G-DCT]	3.9-3.7 [4.0-3.7]	3.9-3.7 [4.0-3.7]	3.2 [-]	3.9-3.6 [3.8-3.5]	- [4.5]	- [3.8-3.6]	- [4.5]
Combined [7G-DCT]	4.3-4.1 [4.2-4.0]	4.3-4.1 [4.2-4.0]	3.6 [-]	4.5-4.3 [4.2-4.0]	- [5.0]	- [4.3-4.1]	- [5.0]
CO ₂ emissions ² in g/km, combined [7G-DCT]	112-108 [111-104]	112-108 [111-104]	94 [-]	117-111 [111-104]	- [131-130]	- [111-107]	- [131-130]
Emission class ³ /efficiency class ⁴ [7G-DCT]	Euro 6/A [Euro 6/A+]	Euro 6/A [Euro 6/A+]	Euro 5/A+ [-]	Euro 6/A [Euro 6/A+]	- [Euro 6/B]	- [Euro 6/A+]	- [Euro 6/B]
Tank capacity, of which reserve, approx. in l	50/6.0	50/6.0	40/6.0	50/6.0	56/6.0	50/6.0	56/6.0
Boot capacity ⁵ in l	488-1547	488-1547	488-1547	488-1547	488-1547	488-1547	488-1547
Turning circle diameter in m	11.0	11.0	11.0	11.0	11.0	11.0	11.0
Kerb weight ⁶ in kg [7G-DCT]	1420 [1450]	1420 [1450]	1395 [-]	1485 [1505]	- [1575]	- [1505]	- [1575]
Perm. GVW in kg [7G-DCT]	1985 [1985]	1985 [1985]	1900 [-]	2025 [2025]	- [2095]	- [2025]	- [2095]

The best for the engine:
Genuine Mercedes-Benz engine oils.

¹Details of rated power and rated torque in accordance with Directive 80/1269/EEC in the currently applicable version. ²The figures shown were obtained in accordance with the prescribed measuring process (Regulation [EC] 715/2007 in the currently applicable version). Note according to Directive 1999/94/EC in the currently applicable version: the figures are not based on an individual vehicle and do not constitute part of the product offer; they are provided solely for purposes of comparison between different vehicle models. ³Data applicable within the European Union only. Country-specific deviations possible. ⁴Calculated on the basis of the measured CO₂ emissions taking into account the mass of the vehicle.





PETROL ENGINES

	B 180	B 180 BlueEFFICIENCY Edition	B 200	B 200 Natural Gas Drive	B 220 4MATIC	B 250	B 250 4MATIC
No. of cylinders/arrangement	4/in-line	4/in-line	4/in-line	4/in-line	4/in-line	4/in-line	4/in-line
Total displacement in cc	1595	1595	1595	1991	1991	1991	1991
Rated output ¹ in kW (hp) at rpm	90 (122)/5000	90 (122)/5000	115 (156)/5300	115 (156)/5000	135 (184)/5500	155 (211)/5500	155 (211)/5500
Rated torque ¹ in Nm at rpm	200/1250-4000	200/1250-4000	250/1250-4000	270/1250-4000	300/1200-4000	350/1200-4000	350/1200-4000
Transmission	6-speed, man. [7G-DCT]	6-speed, man. [-]	6-speed, man. [7G-DCT]	6-speed, man. [7G-DCT]	- [7G-DCT]	- [7G-DCT]	- [7G-DCT]
Acceleration from 0 to 100 km/h in s [7G-DCT]	9.3 [9.1]	9.3 [-]	8.6 [8.4]	9.2 [9.1]	- [7.5]	- [6.8]	- [6.7]
Top speed, approx. in km/h [7G DCT]	200 [200]	190 [-]	220 [220]	200 [200]	- [225]	- [240]	- [235]
Tyre size, front	195/65 R 15	195/65 R 15	205/55 R 16	205/55 R 16	205/55 R 16	225/45 R 17	225/45 R 17
Tyre size, rear	195/65 R 15	195/65 R 15	205/55 R 16	205/55 R 16	205/55 R 16	225/45 R 17	225/45 R 17
Fuel	Premium petrol	Premium petrol	Premium petrol	Natural gas/premium petrol	Premium petrol	Premium petrol	Premium petrol
Fuel consumption ² in l/100 km							
Urban [7G-DCT]	7.6-7.4 [6.9]	7.0 [-]	7.6-7.5 [6.9]	6.0 [5.7-5.6] ⁷	- [8.4]	- [8.6-8.5]	- [8.4]
Extra-urban [7G-DCT]	4.7-4.5 [4.7-4.5]	4.2 [-]	4.7-4.5 [4.7-4.5]	3.5-3.3 [3.5] ⁷	- [5.7-5.4]	- [4.7-4.6]	- [5.7-5.5]
Combined [7G-DCT]	5.8-5.6 [5.5-5.4]	5.2 [-]	5.8-5.6 [5.5-5.4]	4.4-4.3 [4.3-4.2] ⁷	- [6.7-6.5]	- [6.1]	- [6.7-6.6]
CO ₂ emissions ² in g/km, combined [7G-DCT]	134-129 [129-125]	122 [-]	134-130 [129-125]	119-117 [117-115]	- [156-151]	- [143-141]	- [156-154]
Emission class ³ /efficiency class ⁴ [7G-DCT]	Euro 6/B [Euro 6/B]	Euro 6/B [-]	Euro 6/B [Euro 6/B]	Euro 6/A [Euro 6/A]	- [Euro 6/C]	- [Euro 6/C]	- [Euro 6/C]
Tank capacity, of which reserve, approx. in l	50/6.0	50/6.0	50/6.0	21.0 kg/3.0 kg (natural gas)/ 12/5.0 (premium petrol)	56/6.0	50/6.0	56/6.0
Boot capacity ⁵ in l	488-1547	488-1547	488-1547	501-1456	488-1547	488-1547	488-1547
Turning circle diameter in m	11.0	11.0	11.0	11.0	11.0	11.0	11.0
Kerb weight ⁶ in kg [7G-DCT]	1395 [1425]	1395 [-]	1395 [1425]	1505 [1535]	- [1505]	- [1465]	- [1505]
Perm. GVW in kg [7G-DCT]	1960 [1960]	1960 [-]	1960 [1960]	2020 [2050]	- [2030]	- [1990]	- [2030]

⁵ Figures according to Directive 70/156/EEC, version 2000/40/EC. ⁶ Figures according to Directive 92/21/EC, version 95/48/EC (kerb weight with fuel tank 90% full, driver, 68 kg, and luggage, 7 kg) for standard-specification vehicles. Optional extras and accessories will generally increase this figure and reduce the payload capacity accordingly. ⁷ Figures apply exclusively to natural gas operation in kilograms per 100 km. Values in square brackets apply to engines in conjunction with optional 7-speed dual clutch transmission 7G-DCT. You can find further technical data at www.mercedes-benz.com





Dimensions.

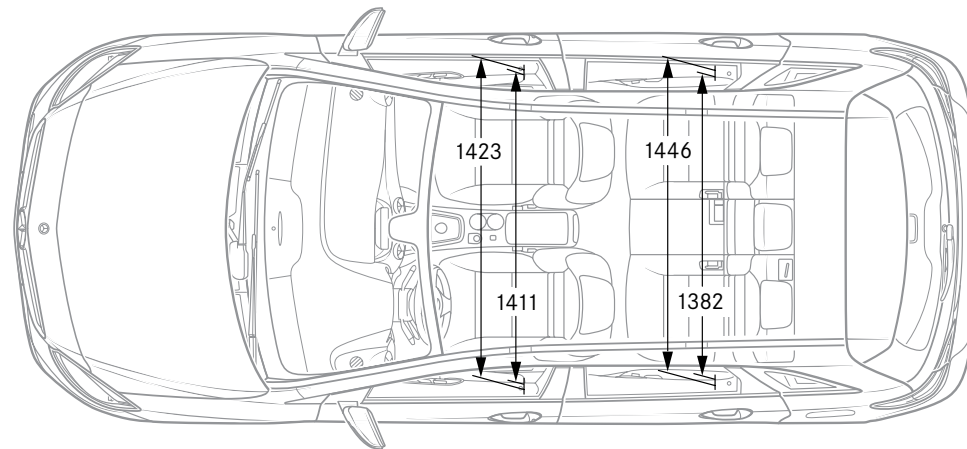
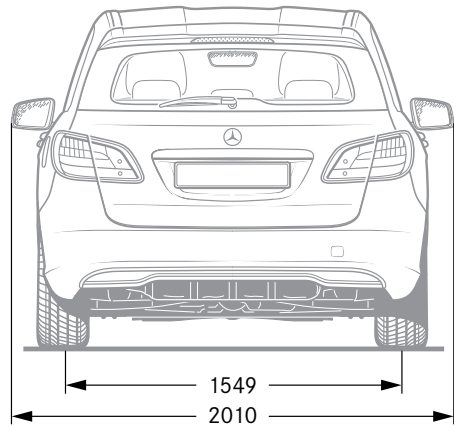
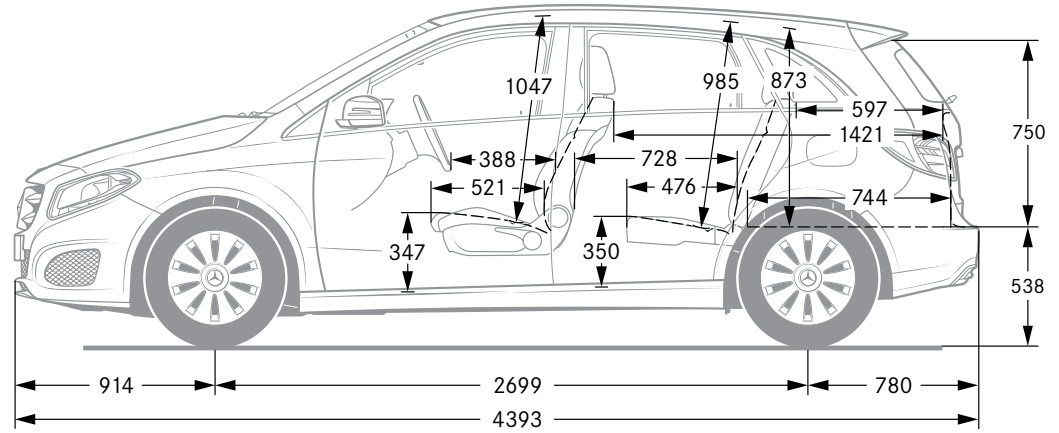
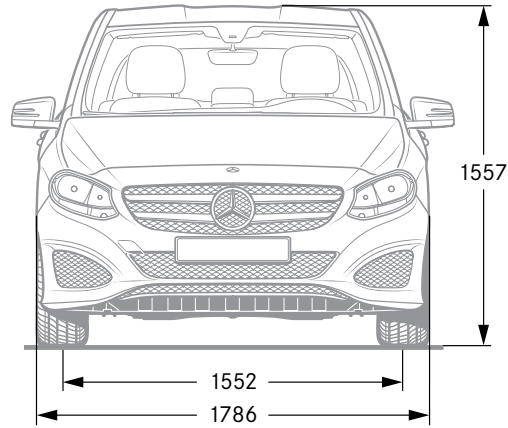

All dimensions in millimetres. The dimensions shown are mean values and apply to standard-specification, unladen vehicles. The dimensions shown correspond to vehicles with a diesel or petrol engine. For the B 200 Natural Gas Drive some of these data can vary.





Upholstery and trim.

Upholstery

- 001 Venlo fabric in black
- 031 Vianen fabric in black¹
- 038 Vianen fabric in crystal grey¹
- 105 ARTICO man-made leather in sahara beige²
- 111 ARTICO man-made leather in black²
- 118 ARTICO man-made leather in crystal grey²
- 201 Leather in black
- 204 Leather in hazelnut brown
- 207 Leather in cranberry red
- 611 ARTICO man-made leather/Montfoort fabric in black
- 618 ARTICO man-made leather/Montfoort fabric in crystal grey
- 661 ARTICO man-made leather/DINAMICA microfibre in black
- 821 RED CUT leather in black

Trim

- H88 Matrix look
- H53 Line pattern
- H81 Sail pattern
- H74 Carbon fibre look
- 734 Brown open-pore eucalyptus wood^{2,3}
- 736 High-gloss black ash wood^{2,4}

¹ Part of standard equipment in conjunction with B 200 Natural Gas Drive. ² Optional extra.
³ Part of the Exclusive package. ⁴ In the case of Exclusive package optionally available for no extra charge.

Standard equipment

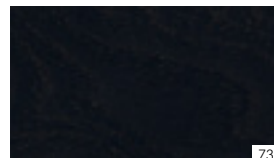
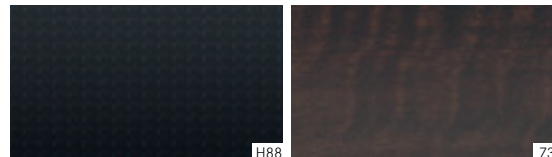
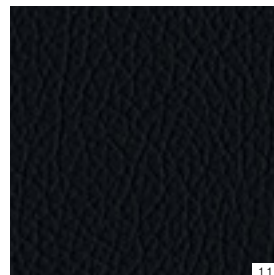
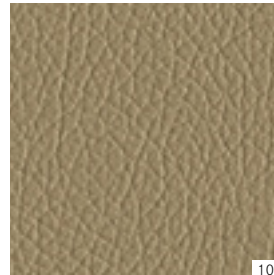
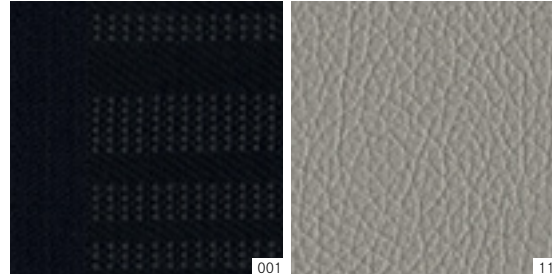

Style²

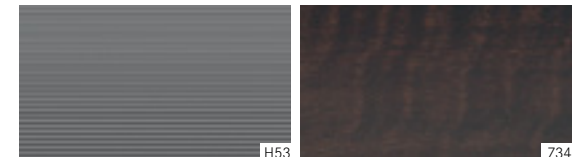
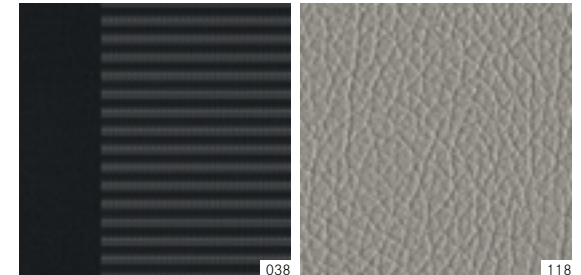
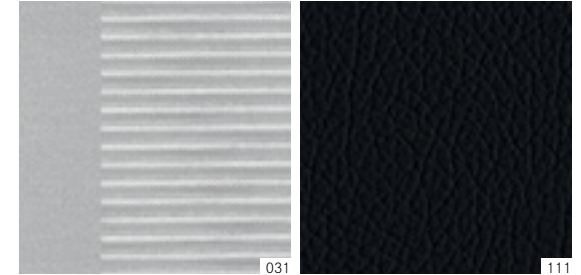



> View price list



> View offers



> Book a test drive



> Mercedes-Benz Magazine

Urban²

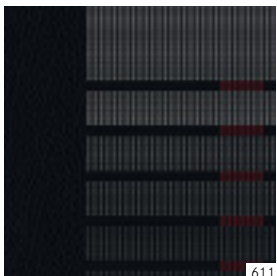

611

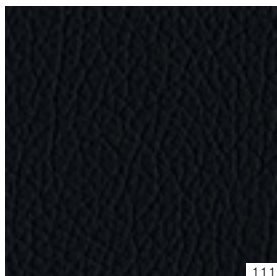

111

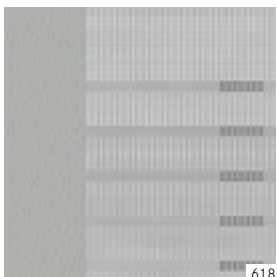

618

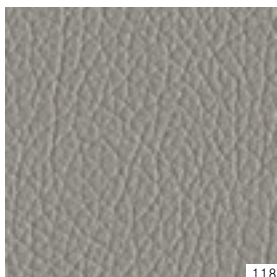

118



105



H81

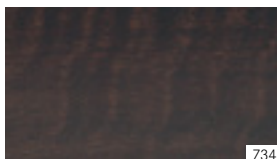

734



736

AMG Line²

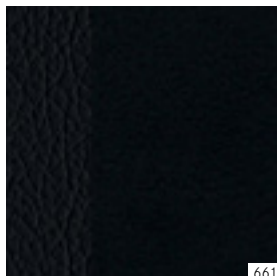

661

Exclusive package²

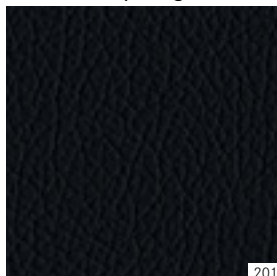

201



207

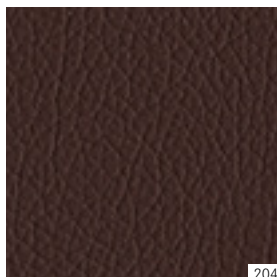

204

AMG Exclusive package²

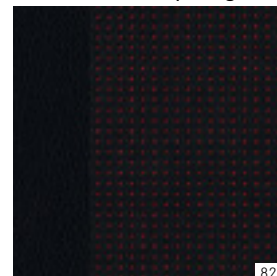

821

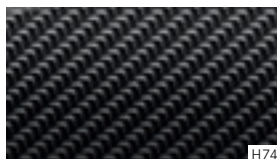

H74

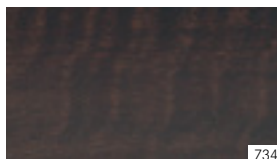

734



736



736

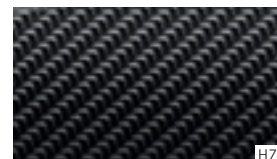

H74



736





Paintwork.

Non-metallic paints

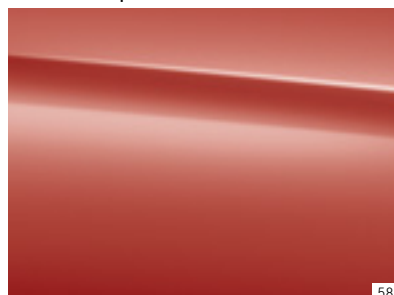

589



650

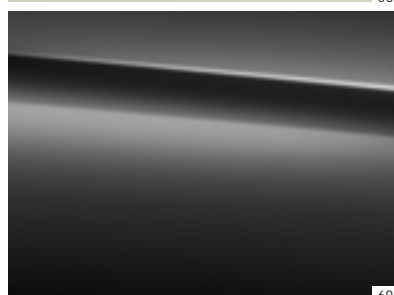

696

Metallic paints¹

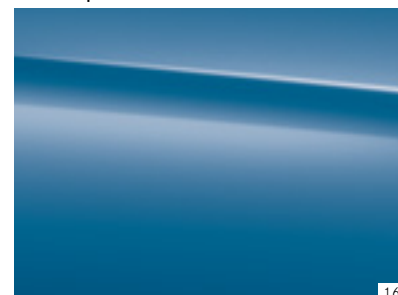

162

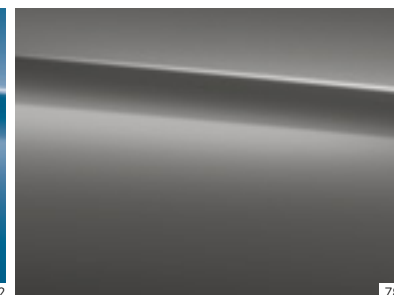

787

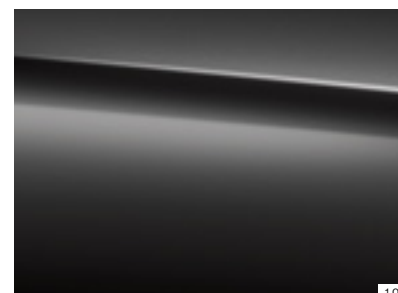

191

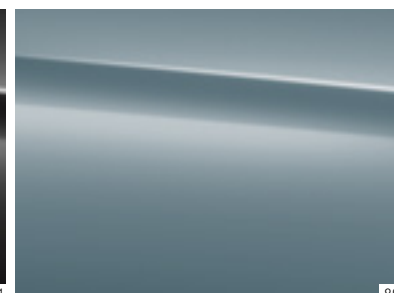

894

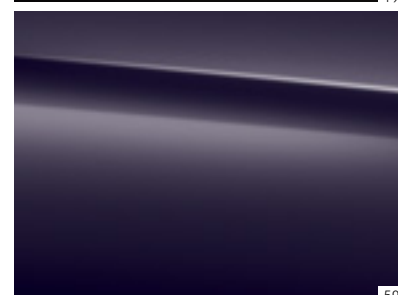

592

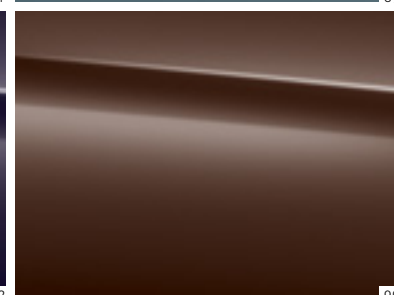

990

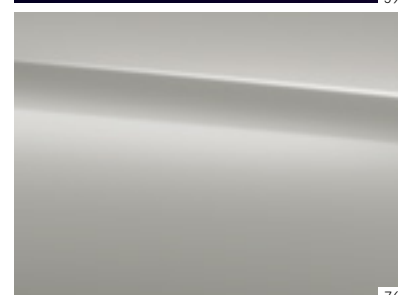

761

Non-metallic paints

589 jupiter red

650 cirrus white

696 night black

Metallic paints¹

162 south seas blue

191 cosmos black

592 northern lights violet

761 polar silver

787 mountain grey

894 universe blue

990 orient brown

¹ Optional extra.





> View price list



> View offers



> Book a test drive



> Mercedes-Benz Magazine

Take-back of end-of-life vehicles. At the end of its long life, you can return your B-Class to us for environment-friendly disposal in accordance with the European Union (EU) End-Of-Life Vehicle Directive. But that day lies a long way off.

A network of vehicle take-back depots and dismantlers has been established to make it as easy as possible for you to return your vehicle. You can leave it at any of these points free of charge. In so doing, you will be making a valuable contribution towards completing the recycling loop and preserving resources.

For further information about the recycling and disposal of end-of-life vehicles and take-back conditions, please visit your national Mercedes-Benz website.

Please note: this online version of the printed brochure may contain abridged copy or other content changes. The manufacturer reserves the right during the delivery period to make changes to the design, form, colour or specification, provided these changes, while taking into account the interests of the vendor, can be deemed reasonable with respect to the purchaser. Where the vendor or the manufacturer uses symbols or numbers to describe an order or the subject of an order, no rights may be derived solely from these. The illustrations may include accessories and optional extras which do not form part of the standard specification. Actual colours may differ slightly from those shown owing to the limitations of the printing process. This brochure is distributed internationally. Information given regarding statutory regulations, legal requirements and taxation and the consequences thereof applies to the Federal Republic of Germany only and is correct at the time of going to press. For current and more specific information in relation to the range of models, features, optional extras, colours and/or services available in your country, and their pricing, you should contact your nearest authorised Mercedes-Benz Passenger Car Dealer. E&OE. www.mercedes-benz.com

