



> View price list



> View offers



> New C-Class



> Mercedes-Benz Magazine

# C-Class

Coupé



Mercedes-Benz





> View price list



> View offers



> New C-Class



> Mercedes-Benz Magazine

## DOWNLOAD THE APP

Experience the C-Class Coupé in an interactive and engaging way: download the free Mercedes-Benz C-Class Coupé brochure app for iPad® from the App Store



## The C-Class Coupé. More attention per hour.

On the outside, it's a dynamic coupé whose looks never fail to cause a stir. Inside, however, it's an oasis of calm, a place to relax and enjoy every bend and straight in total comfort. It's the C-Class Coupé, a winning combination of luxury, personality and driving pleasure.

With efficient powerful engines, ECO start/stop, Agility Control suspension and standard-setting safety technology.





> View price list



> View offers



> New C-Class



> Mercedes-Benz Magazine

### Featured vehicles at a glance:

#### 4 | Mercedes-Benz C 180 AMG Sport Edition

##### Palladium Silver metallic

Standard 18" AMG 7-spoke alloy wheels, Artico man-made leather/Dinamica microfibre upholstery

#### 10 | Mercedes-Benz C 220 CDI AMG Sport Edition

##### Diamond White metallic

Standard 18" AMG 7-spoke alloy wheels, Artico man-made leather/Dinamica microfibre upholstery

### Vision

11 | Innovation that moves

### Engines and suspension

12 | Diesel engines

13 | Petrol engines

14 | Transmissions

15 | Suspension

### Safety

16 | Integrated safety concept

### Comfort

20 | Multimedia systems

22 | Electronic assistants

24 | Seats

### AMG

26 | C 63 AMG Coupé

28 | C 63 AMG Edition 507

30 | C 63 AMG technology

### Equipment

32 | Standard equipment

33 | Option packages

34 | C-Class Coupé Executive SE

38 | C-Class Coupé AMG Sport Edition

40 | Alloy wheels

41 | Retailer-fit accessories

### 42 | Services

### Facts and finishes

44 | Dimensions

45 | Technical specifications

47 | Paint finishes

Specifications shown may include optional equipment and accessories





> View price list



> View offers



> New C-Class



> Mercedes-Benz Magazine

Overview 4

## Two doors, no compromises: concentrated coupé flair

The stance is low-slung; the face unmistakable, a large three-pointed star dominating its two-bar grille. The rear? Compact, muscular and broad-shouldered. It's a coupé for those who don't stand still.





> View price list



> View offers



> New C-Class



> Mercedes-Benz Magazine

Care instructions:  
apply regularly to tarmac





> View price list



> View offers



> New C-Class



> Mercedes-Benz Magazine





> View price list



> View offers



> New C-Class



> Mercedes-Benz Magazine



## Having thoughts about the environment? We're with you.

The C-Class Coupé comes with engines that achieve significant reductions in fuel consumption. What's more, its ECO start/stop function and the optional 7G-Tronic Plus automatic transmission help to improve efficiency even further. Good for your conscience – and for your wallet. → pages 12-14





> View price list



> View offers



> New C-Class



> Mercedes-Benz Magazine



Welcome to the coupé lounge







> View price list



> View offers



> New C-Class



> Mercedes-Benz Magazine

Your first Mercedes?  
We promise it won't be your last





> View price list



> View offers



> New C-Class



> Mercedes-Benz Magazine

## A sixth sense also comes as standard

The C-Class Coupé always seems to know what's just ahead. Its safety systems are constantly evaluating the current situation and anticipating the next, helping you to stay out of danger whenever possible. The Adaptive Brake System, for instance, can prime the brakes even before you press the pedal, ensuring they react faster – and bring the car to a standstill more quickly.

Optional panoramic sunroof shown





> View price list



> View offers



> New C-Class



> Mercedes-Benz Magazine

## What makes a car a Mercedes?

Tradition comes with responsibility. To us, it means commitment to innovation. We have always explored uncharted territory, setting milestones all along the way: the first vehicle with a crumple zone, the first ABS, the first diesel car or, indeed, the first car. But why dwell on the past, when there's so much to look forward to?

**Mercedes me** – welcome to a world that revolves around you. For us, the focus is on people. To pursue this responsibility we have developed a new platform to enable your own personal contact with Mercedes-Benz, with individual services that are made for you. *Connect me* connects the vehicle with your adventure world, with everything that is important to you. *Move me* offers new mobility solutions. And with *Inspire me*, we provide an exclusive glimpse into the future of mobility. Your access to a fascinating world: [www.mercedes.me](http://www.mercedes.me)



**Mercedes-Benz Intelligent Drive** – our vision of accident-free driving. At its heart are intelligent technologies actively supporting the driver and increasing the driver's comfort. Crucial electronic assistants are already at work in your Mercedes-Benz, automatically helping to keep the car at a safe distance from the vehicle in front, braking when necessary and warning the driver of impending rear-end collisions or of vehicles in the blind spot. By intelligently combining sensors of safety systems and electronic assistants, potentially dangerous situations are identified much earlier and are consequently ever more frequently avoided. To discover the pioneering world of Mercedes-Benz Intelligent Drive visit [www.mercedes-benz-intelligent-drive.com](http://www.mercedes-benz-intelligent-drive.com)

**BlueEFFICIENCY** – our vision of zero-emission driving. While 'sustainability' is a big word, we lend it real meaning in everything we do. From the most eco-friendly manufacturing process possible through to alternative drive concepts.

As you can see, we've set ourselves far-reaching goals. But what could be more pleasant than to enjoy the journey in a Mercedes-Benz?

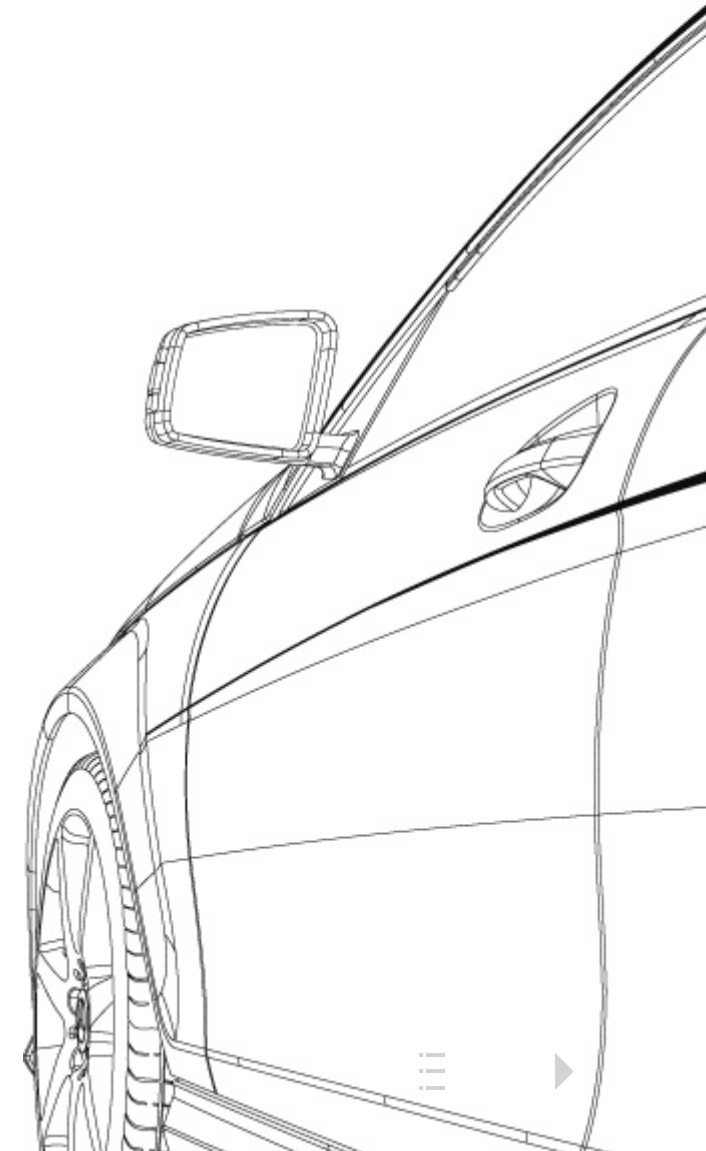



# Diesel engines

The diesel engines for the C-Class Coupé are efficient, refined and powerful, offering significantly higher outputs and lower fuel consumption than conventional diesel units.

**4-cylinder engines.** Impressive performance is achieved courtesy of a range of technical innovations, resulting in figures of 170 hp (125kW) for the C 220 CDI and 204 hp (150 kW) for the C 250 CDI. The high-pressure injection system injects fuel at up to 2,000 bar and sends only the required amount of fuel into the combustion chambers.

The chambers themselves have been optimised to ensure fuel burns as cleanly and efficiently as possible, while the intelligent alternator management system means the alternator is only active when needed, reducing the load on the engine. There are also efficient twin turbochargers and twin balancer shafts that keep the engine running smoothly at all times.

**Additional efficiency measures.** All our engines come with ECO start/stop almost imperceptibly cutting the engine when the car is stationary or coming to a complete standstill. The ECO display that is available on many models evaluates the efficiency of the driver's driving style, allowing the driver to actively reduce consumption.

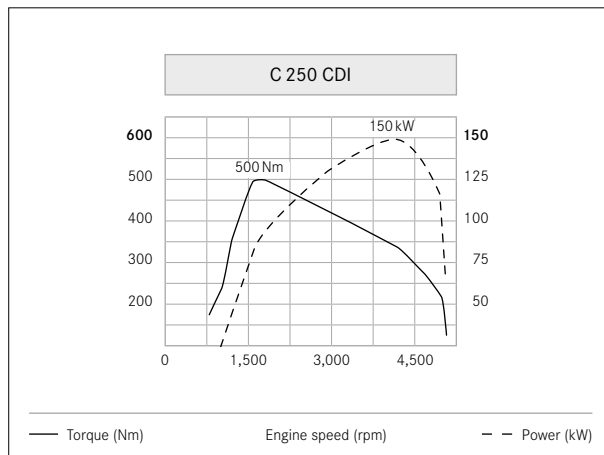

With high levels of torque even at low engine speeds, the C 250 CDI delivers instant acceleration

Both 4-cylinder diesel models come with the ECO start/stop function and meet the EU5 standard for exhaust emissions.



The ECO display provides information on the efficiency of your driving style





> View price list



> View offers



> New C-Class



> Mercedes-Benz Magazine

## Petrol engines

Enjoyment and efficiency can go hand in hand – as the C-Class Coupé's petrol engine proves. The 4-cylinder petrol engine delivers exceptionally refined performance and impressively low fuel consumption.

**4-cylinder engine.** Our petrol engine offers both increased power and reduced fuel consumption. It's a feat it achieves thanks to advanced engine technology. Direct injection at up to 200 bar gives an optimum air/fuel mixture and increased engine efficiency. The engine management also optimises the valve timing by adjustment of the camshafts and uses multi-hole piezo injectors. A particular benefit is the saving in engine

weight by using a cast hollow crankshaft and aluminium for the cylinder block. The electronic steering in the C 180 leads to further savings in consumption, only drawing energy when the steering wheel is moved – without any loss in comfort.

The C 180 accelerates from 0 to 62 mph in 8.5 seconds and goes on to reach a top speed of 140 mph.

**Additional efficiency measures.** Like the diesel engines, all petrol models are equipped with the ECO start-stop function.





> View price list



> View offers



> New C-Class



> Mercedes-Benz Magazine

## Transmissions

The transmissions for the C-Class Coupé ensure optimum performance whatever the situation or engine speed.

**6-speed manual transmission.** The 6-speed manual transmission combines impressive efficiency with a sporty feel. The ratios are ideally matched to the engine and the short, precise shift throws ensure every gear change is a pleasure. Manual C-Class Coupé models are equipped with a shift point indicator and current fuel consumption display that help you to optimise efficiency and reduce CO<sub>2</sub> emissions. The standard ECO start/stop function, meanwhile, helps to achieve further fuel-savings, cutting the engine automatically when stationary or coming to a standstill, and restarting it as soon as you touch the accelerator or depress the clutch.

**7G-Tronic Plus.** 7G-Tronic Plus is the latest version of our 7-speed automatic transmission. It helps to improve fuel consumption by ensuring the engine is always operating at the optimum speed, yet delivers faster, smoother shifts and better acceleration too, even skipping gears in kick-down for more rapid overtaking. In addition, 7G-Tronic Plus allows you to switch between comfort and sport modes as the mood takes you.

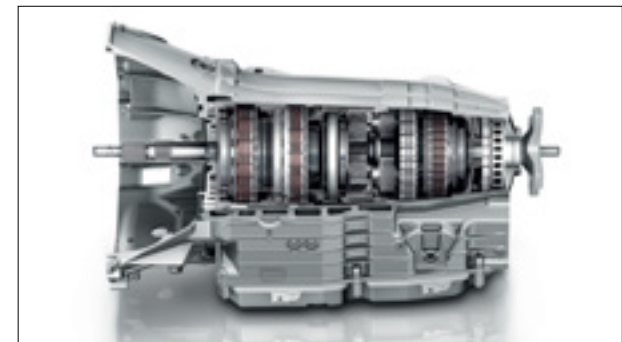

7G-Tronic Plus: the result of more than 50 years' experience in automatic transmission technology

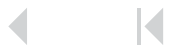



> View price list



> View offers



> New C-Class



> Mercedes-Benz Magazine

# Suspension

Thanks to Agility Control suspension with Adaptive Damping System, C-Class drivers enjoy the best of both worlds: agile handling and a supremely comfortable ride.

## Agility Control with Adaptive Damping System

(standard). The Agility Control suspension with Adaptive Damping System offers an ideal blend of cornering ability and comfort. Its dampers automatically adjust to the requirements of the situation or surface, enhancing damping levels and optimising stability particularly on poorly made road surfaces.

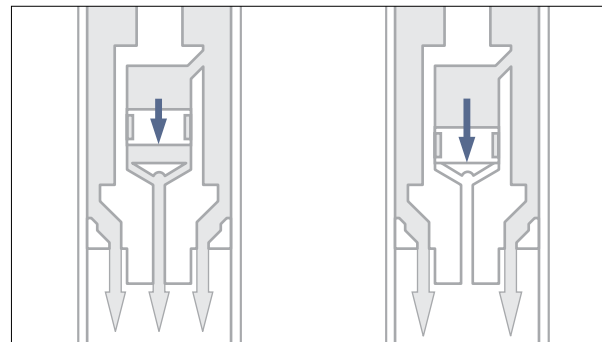

Agility and comfort combined: the C-Class suspension adjusts the damping levels automatically to suit the surface and situation





## Integrated safety concept

The C-Class Coupé comes with a host of safety features that help to avoid danger and make for a more relaxing journey.

As the inventor of the motor car, we feel a particular responsibility towards road safety. That's why we were the first manufacturer to develop an integrated safety concept that seamlessly combines a car's active and passive safety features, thus ensuring optimum all-round protection. This concept covers four different areas – safer driving, anticipating danger, protecting occupants and post-crash safety – and incorporates measures designed to maximise safety in every situation, by helping you to stay safe, alerting you to danger, and assisting you wherever possible. In addition, our unique Pre-Safe® anticipatory safety system recognises likely accident scenarios and takes steps that help to further enhance occupant protection. If a collision can't be avoided, intelligent passive safety systems help to provide protection where it's needed, while solutions that can minimise the consequences of an accident and facilitate emergency assistance are also a key part of this safety concept.

A selection of these technologies for the phases 'safer driving', 'anticipating danger', 'protecting occupants' and 'post-crash safety' are presented on the following pages.

**Safer driving: Attention Assist** (standard). If it detects signs of tiredness, Attention Assist alerts the driver via visual and acoustic warnings and recommends taking a break. It monitors driver behaviour via an array of sensors and registers unexpected changes that may indicate drowsiness or concentration lapses.

**Safer driving: Intelligent Light System** (standard). This system comprises five modes: high-performance headlamps with country mode shining more light towards road edges, motorway mode to illuminate the entire width of the lane, fog mode for improved visibility in bad weather conditions, Active Cornering light as well as Active Light System for better visibility in bends.

**Safer driving: Adaptive High Beam Assist** (standard). Adaptive High Beam Assist consistently offers the maximum lighting range and adapts to the current road situation. The system activates the high beam, if no oncoming vehicles are detected and lowers it again as soon as the lights of oncoming traffic are identified.

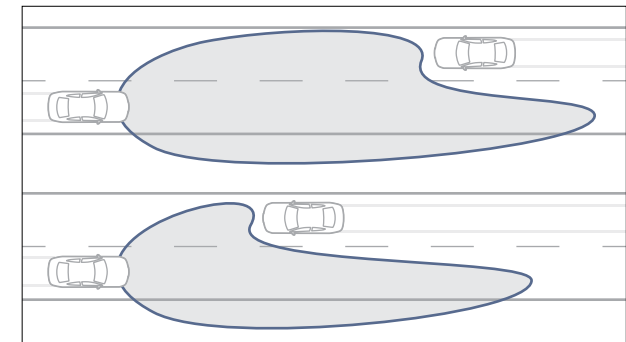

The Intelligent Light System automatically optimises visibility in a range of different situations

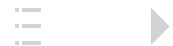





**Safer driving: Driving Assistance Package** (optional on C 63 AMG models). This package comprises a range of intelligent safety technologies. Active Lane-Keeping Assist draws the driver's attention to unintended lane changes, gently vibrating the steering wheel if the car wanders across lane markings. If the driver doesn't react to the warning, the system is able to intervene in order to correct the car's course. Active Blind Spot Assist makes intentional lane changes safer too, using twin radar sensors to watch over the areas not visible in your exterior mirrors. If the sensors spot a vehicle in one of these blind spots, a flashing red triangle appears

in the corresponding mirror, accompanied by an acoustic warning from the instrument panel. Should the driver nevertheless proceed to change lanes, the system can intervene and help prevent a collision by automatically applying the brakes on the appropriate side. Distronic Plus radar-assisted cruise control, meanwhile, enables the car to automatically maintain a preset distance from the vehicle in front, both in high-speed driving and in stop/start traffic. Also included in the package are our Brake Assist (BAS Plus) and Pre-Safe® Brake system – to give that feeling of safety on every trip.

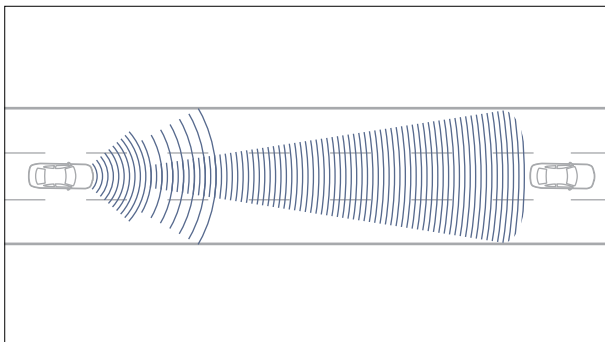

Distronic Plus can bring the car to a standstill and get you moving again automatically – an advantage in stop/start driving





**Anticipating danger: Pre-Safe® Brake and BAS Plus**

(part of optional Driving Assistance Package). If it detects the risk of a collision, Pre-Safe® Brake alerts the driver via visual and audible warnings. At the same time, BAS Plus assesses the brake force required in order to avoid an impact. If the driver applies the brakes but uses insufficient force, BAS Plus automatically raises the braking pressure to a level that exploits the remaining stopping distance to the full, thereby also lessening the likelihood of a shunt from behind.

Should the driver fail to react to Pre-Safe® Brake's warning signals, it slows the car automatically, providing a further warning, and triggers a range of Pre-Safe® measures. If the driver still doesn't respond, the system then initiates autonomous emergency braking, enabling the speed and severity of any impact to be significantly reduced.

**Anticipating danger: Pre-Safe® system (standard).**

If it detects a probable accident scenario, Pre-Safe® anticipatory safety system can take a range of anticipatory measures to reduce the risk of injury to the occupants. These include activating the front seat belt tensioners, automatically closing the windows and moving the front passenger seat to a more favourable position.

**Anticipating danger: Neck-Pro active head restraints**

(standard). The Neck-Pro front head restraints help to reduce the risk of whiplash injuries. Within milliseconds of a rear-end impact, they automatically move forwards and upwards, enabling them to support the head sooner.

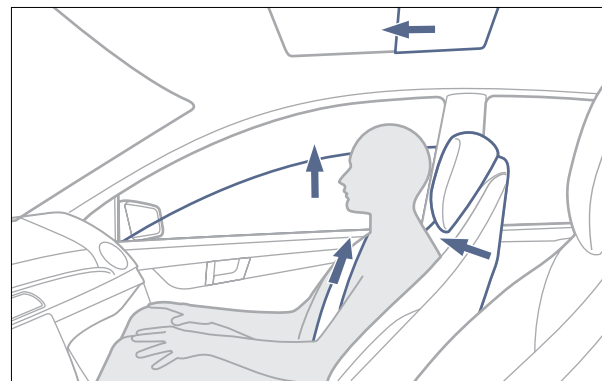

The Pre-Safe® system can detect critical situations and take anticipatory measures to enhance occupant protection

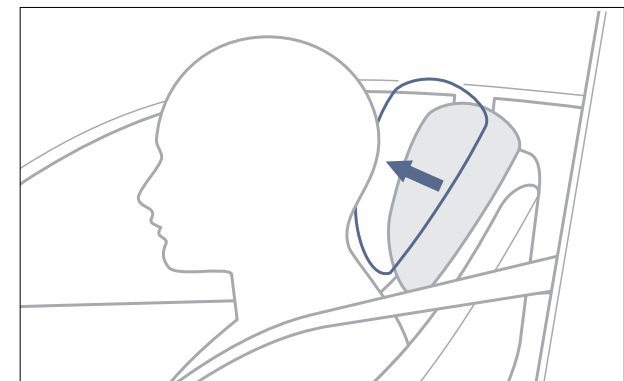

The Neck-Pro active head restraints can help to avoid whiplash injuries in rear-end collisions



**Protecting occupants: restraint systems** (standard).

The 3-point seat belts, seat belt tensioners, belt force limiters and airbags are all carefully coordinated so as to keep injuries to a minimum. The C-Class Coupé is fitted with numerous airbags to ensure optimum occupant protection, with front, side, pelvisbags for the driver and front passenger, a kneebag for the driver and windowbags as standard. Sidebags are optional for the rear. If the crash sensors detect an impact, the seat belts are instantly tensed, helping to ensure the occupants remain firmly in

their seats, while the belt force limiter relaxes the belt as the situation allows, in order to prevent undue force being applied to the rib cage.

**Protecting occupants: Active Bonnet** (standard).

The Active Bonnet helps reduce the risk of injury to more vulnerable road users, such as pedestrians and cyclists. On impact, the bonnet springs up by 5 cm to better absorb the collision.

**Post-crash safety: Mercedes-Benz emergency call system** (part of COMAND Online systems).

The system can automatically send an emergency call via an operational telephone connected to the vehicle, as soon as the restraint system detects a collision. The GPS coordinates are sent to the Mercedes-Benz emergency call centre and a speech connection is then set up. The emergency call can also be triggered manually.

**Post-crash safety: rescue assistance.** Mercedes-Benz has developed a range of measures that help to minimise the secondary consequences of an accident and facilitate occupant rescue. These include automatic engine cut-off, self-activating hazard lights and emergency cabin lighting. In addition, the central locking system is automatically released in the event of an accident, and there are special crash joints between the front doors and wings that make it easier to open the doors after frontal collisions. In addition, Mercedes-Benz provides a rescue guide for emergency services that can be downloaded from the Internet at [www.mercedes-benz.co.uk/rescueguide](http://www.mercedes-benz.co.uk/rescueguide)

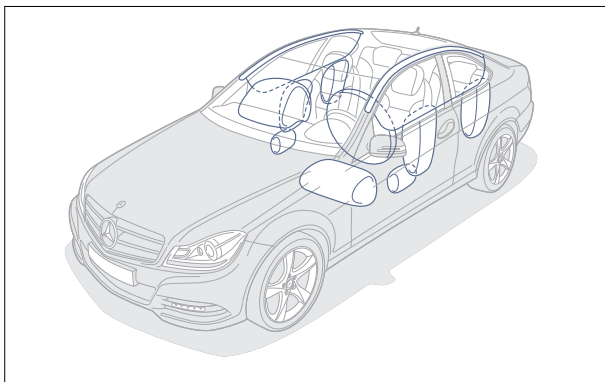

The rigid passenger cell, front and rear crumple zones and intelligent restraint systems provide optimum protection in the event of an impact



## Multimedia systems

With its high-quality multimedia and navigation systems, the C-Class Coupé helps you to reach your destination as swiftly as possible – and keeps you entertained all the way.

**COMAND Online** (part of Premium Packages; standard on C 63 AMG). The system combines hard disk drive (HDD) navigation for 3D map viewing on a high-resolution 7-inch colour display. Multimedia functions include radio, speed-sensitive volume control, music register with 10 GB of storage for audio files, free European map data updates<sup>1</sup> and live traffic information,<sup>1</sup> which provides

precise, up-to-date traffic data for improved route planning and more accurately estimated time of arrival. A USB connection, SD memory card slot and Bluetooth® interface for hands-free access and the Media Interface allow connection to external data storage media. The DVD drive can play video and audio DVDs as well as CDs and MP3 files. The online feature allows

access to the Internet and Mercedes-Benz apps via an Internet-enabled mobile phone, including Facebook, Internet radio, parking space search, special destination searches via Google Street View or sending routes from Google™ maps to the vehicle, and hotel finder as well as news and weather reports. You can operate the system via the COMAND controller and the multi-function steering wheel, or simply use Linguatronic voice control. For comprehensive information on operating the vehicle and the COMAND Online system, the Digital Owner's Manual can be called up quickly and easily.



The large TFT display presents maps, videos or online content in high resolution

<sup>1</sup>Free of charge for the first three years

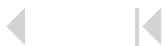



**Harman Kardon® Logic 7® surround sound system** (optional on C 63 AMG models only). With its 12 high-performance speakers and Logic 7® multi-channel spatial sound technology, this 450-watt surround sound system makes every journey a listening experience to remember. In addition, it comes with speed-sensitive volume adjustment that levels the audio output as you drive.



The Harman Kardon® Logic 7® surround sound system offers a truly first-class listening experience

**Audio 20 radio with Bluetooth® interface and USB port** (standard). The Audio 20 system features a radio, a 6-disc CD changer with MP3 playback, a USB port, and a Bluetooth® interface for hands-free mobile telephony. It also comes with a 5.8-inch TFT display and can be operated remotely via the multi-function steering wheel. A DAB digital radio tuner is included as standard on the C-Class Coupé.



The Audio 20 system features a 6-disc CD changer and a DAB digital radio tuner

**Becker® Map Pilot navigation system** (optional). With the Becker® Map Pilot navigation system, you'll always reach your destination as safely and quickly as possible. Installed in the glove compartment, the Map Pilot can be integrated with Audio 20 CD system's central controller and display and tailored to your needs by downloading additional functions and map data.



> View price list



> View offers



> New C-Class



> Mercedes-Benz Magazine

## Electronic assistants

The C-Class Coupé is available with electronic assistants that enhance safety and convenience in a range of situations.



Speed Limit Assist even recognises and displays temporary speed restrictions

**Speed Limit Assist** (fitted with COMAND Online system). Speed Limit Assist reads speed limit signs and displays the permitted maximum speed in the instrument panel and on the COMAND Online navigation screen until the limit changes. Its front-mounted camera detects round speed limit warnings, both on roadside signs and on overhead gantries, and is particularly useful in areas where the speed limit varies or when passing through roadworks. To help identify the limit correctly, it compares speed limit signs with map data from the navigation system, enabling it to recognise when you are entering or leaving built-up areas for instance.





**Reversing camera** (included in Premium Packages, optional on C 63 AMG models). This rear-mounted camera makes for safer and easier parking manoeuvres. Activated automatically as soon as the driver engages reverse, it captures the area immediately behind the car and enables you to see the image on the COMAND Online display.

**Parktronic with Parking Guidance** (standard). Parktronic uses the sonar principle to help you avoid low-speed knocks during parking manoeuvres. It sends out ultra-sound signals that reflect off other objects and are picked up by sensors in the front and rear bumpers. The system then processes this information and calculates the size of the gap to the front and rear, enabling it to alert you via acoustic and visual warnings as you approach the vehicle or object.

Parking Guidance can help you to find and manoeuvre into parking spaces. At speeds of around 20 mph, it measures gaps in lines of parallel-parked cars and alerts you as soon as it finds a suitably sized space. Once reverse is engaged, it then guides you in via a combination of acoustic signals and graphics in the instrument panel, showing the required steering angle and telling you when to turn the wheel.



The reversing camera makes for easier manoeuvring in tight spaces



Parking Guidance helps the driver choose the correct steering angle and turn-in point

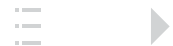



> View price list



> View offers



> New C-Class



> Mercedes-Benz Magazine

## Seats

The C-Class Coupé features coupé-specific front seats, individual rear seats and integral head restraints all round. Its eye-catching seats not only look the part, they also offer excellent ergonomics and high levels of support even in sporty driving.



**Coupé-specific front seats.** For the driver and front seat passenger, the C-Class Coupé offers ergonomically designed coupé-specific seats. The AMG Sport Edition seats, as shown here, come with extra supportive side bolsters to ensure maximum comfort while lending a sporty feel to the interior.

**Individual rear seats with integral head restraints.** Those in the rear benefit from ergonomic, individually sculpted seats with integral head restraints. They echo the sporty style of the coupé-specific front seats and come with an asymmetric split/fold mechanism. Also fitted as standard is the Easy-Entry system, which provides more convenient access to the rear seat accommodation.

Coupé-specific front seats lend the C-Class Coupé cabin a sporty look and feel. AMG Sport Edition seats shown







> View price list



> View offers



> New C-Class



> Mercedes-Benz Magazine



The standard Easy-Entry system facilitates access to the rear, sliding the front seats all the way forward when released. AMG Sport Edition seats shown





> View price list



> View offers



> New C-Class



> Mercedes-Benz Magazine



Optional 19" AMG multi-spoke alloy wheels in matt black (code 797)



18" AMG 5-twin-spoke alloy wheels with burnished Titanium Grey finish

## C 63 AMG

The C 63 AMG Coupé combines the race-honed technology of its four-door cousins with a dramatic and highly individual style. Its sporty coupé lines are made even more eye-catching by the AMG grille with single chrome louvre, an AMG-specific bonnet with powerdomes, and AMG bodystyling comprising front and rear aprons plus side skirts. The AMG sports exhaust system's two sets of twin chromed tailpipes provide a further clue to the power of this exhilarating coupé, while AMG-specific daytime running lights and 18" 5-twin-spoke AMG alloy wheels in burnished Titanium Grey finish also come as standard (19" AMG multi-spoke wheels in Titanium Grey or black are available as an option).

---

### Exterior

---

18" AMG 5-twin-spoke alloy wheels with burnished Titanium Grey finish

---

AMG bodystyling, comprising front apron with side air vents and gloss black cross-bar, side skirts and diffuser-style rear apron

---

AMG boot lid spoiler (body-coloured)

---

AMG high-performance braking system with 360×36 mm front brake discs and 330×26 mm rear discs

---

LED rear tail lights

---

Panoramic sunroof

---

Wider front wings with '6.3 AMG' badges

---

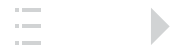



> View price list



> View offers



> New C-Class



> Mercedes-Benz Magazine



AMG sports seats are upholstered in single- or two-tone *designo* leather

Stylish, sporty and highly exclusive, the interior of the C 63 AMG Coupé feels instantly special. Its supportive AMG sports seats are upholstered in single- or two-tone *designo* leather. The flat-rimmed AMG Performance steering wheel features tactile nappa leather trim, and there's an ergonomic AMG-specific instrument panel with colour display and AMG start-up screen. Eye-catching AMG door sill strips and brushed stainless steel sports pedals also come as standard (carbon fibre trim is available as an option). → [www.mercedes-benz.co.uk/amg](http://www.mercedes-benz.co.uk/amg)



Optional carbon fibre trim

**Interior**

Aluminium trim

AMG door sill strips in brushed stainless steel

AMG instrument panel with high-resolution 4.5-inch colour display, including Racetimer and AMG start-up screen

AMG sports parameter steering

AMG sports seats with *designo* Black leather upholstery

Attention Assist

Brushed stainless steel sports pedals with rubber studs

COMAND Online system with Media Interface

DAB digital radio tuner

Flat-rimmed AMG Performance steering wheel with nappa leather trim

Rotary switch for transmission modes and Race Start function

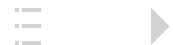



> View price list



> View offers



> New C-Class



> Mercedes-Benz Magazine



Optional 19" AMG cross-spoke alloy wheels, painted matt black



Standard 19" AMG cross-spoke alloy wheels, painted Titanium Grey

## C 63 AMG Edition 507

The C 63 AMG Edition 507 adds further drama to both the performance and styling of the C 63 AMG. The extra 50hp is hinted at by the dual air intakes in the bonnet, the gloss Black exterior trim and the AMG sport stripe in matt Graphite Grey. A unique design of 19" forged alloy wheels – available in Titanium Grey or matt black – is complemented by red brake calipers, creating a stylish and dynamic finish to this high-performance model.

---

### Exterior

---

AMG Driver's Package

---

AMG bonnet with powerdomes and air outlets in high gloss black

---

AMG boot lid spoiler in black

---

AMG high-performance composite brake system with 3-stage ESP® and composite front brake discs

---

AMG sport stripe in matt Graphite Grey

---

Brake calipers painted red

---

LED daytime running light surround and radiator grille border in high gloss black

---





> View price list



> View offers



> New C-Class



> Mercedes-Benz Magazine



Optional *designo* Porcelain leather / Black Dinamica (code X87)

The interior of the C 63 AMG Edition 507 is unmistakably performance driven. The full Alcantara® steering wheel with 12 o'clock marking sits in front of the AMG instrument cluster featuring red accents. Detailed touches include the AMG emblem on the gear shift lever and 'Edition 507' badging integrated into the dashboard trim. Three seat upholsteries are available, with the unique combination of Porcelain leather/Black Dinamica microfibre being shown here.



AMG instrument cluster with red applications

**Interior**

AMG Performance 3-spoke steering wheel in Alcantara® with contrast stitching and 12 o'clock marking

AMG instrument cluster with red applications

AMG stainless steel- and Dinamica-trimmed gear shift lever with contrast stitching and AMG emblem

Trim - high gloss Black with 'Edition 507' badging





## C 63 AMG technology

The AMG 6.3-litre V8 delivers exceptional power, the sports transmission and suspension help you exploit it to the full – and let you switch between performance- and comfort-biased set-ups. → [www.mercedes-benz.co.uk/amg](http://www.mercedes-benz.co.uk/amg)

**AMG 6.3-litre V8.** Under the bonnet of the C 63 AMG is a naturally aspirated V8 equipped with track-honed racing technologies. These include variable camshaft timing, four valves per cylinder, an exceptionally rigid aluminium crankcase and a special low-friction coating for the cylinder contact surfaces. For optimum cylinder charging, this high-tech engine also features vertically arranged intake and exhaust ports plus a magnesium variable intake manifold with twin throttle flaps. The result is free-revving performance, exceptional pulling power and instant acceleration at all speeds. The C 63 AMG delivers 457 hp (336 kW) at 6,800 rpm, plus 600 Nm of torque at 5,000 rpm, with in excess of 500 Nm available all the way from 2,000 to 6,250 rpm. The C 63 AMG Edition 507 delivers even more power: it increases output to 507 hp (373 kW), enabling it to accelerate from 0 to 62 mph in a breathtaking 4.2 seconds (4.5 seconds for the C 63 AMG).

**AMG sports suspension.** The AMG sports suspension with 18" 5-twin-spoke AMG alloy wheels ensure excellent driving dynamics. For added thrill in every corner, there's a tailor-made triple-link front suspension with wider front track and three-stage ESP®. The firm springing and gas pressure dampers guarantee optimum roadholding and excellent lateral acceleration potential even at the limit, yet the ride remains as comfortable as you'd expect from a Mercedes, even on longer journeys. The AMG sports parameter steering features a more direct ratio that gives greater steering precision and allows for even higher cornering speeds, while the Electronic Stability Programme (ESP®) is also tailored to the C 63 AMG's high-performance needs. It lets you determine the level of ESP® support yourself, allowing you to switch between 'on', 'off' and 'sports handling' modes, and displaying the current setting in the instrument panel. As an option, the C 63 AMG Coupé can be fitted with AMG Performance suspension. Its tauter spring and damper settings make for even faster handling responses and a thoroughly focused feel.

**AMG Speedshift MCT 7-speed sports transmission.** Equipped with AMG aluminium steering wheel shift paddles, four driving modes and a Race Start function, the C 63 AMG's 7-speed sports transmission maximises performance yet delivers high levels of efficiency. The 'S' (Sport), 'S+' (Sport Plus), 'C' (Comfort) and 'M' (Manual) modes each offer different shift characteristics and speeds: gear changes in Sport and Sport Plus modes are around 20% and 40% faster respectively than in Comfort mode, while Manual mode is approximately 50% faster, with shift times of just 100 milliseconds. The transmission also offers automatic throttle-blipping on downshifts. This not only produces a satisfyingly sporty sound, it also helps to reduce load transfer, especially when braking into bends.





> View price list



> View offers



> New C-Class



> Mercedes-Benz Magazine



19" AMG multi-spoke alloy wheels, painted in Titanium Grey



Optional AMG Interior Carbon Fibre Trim Package (code H73)

## AMG Performance Studio

For an even sportier C 63 AMG, simply add options from the AMG Performance Studio. Allowing you to further customise your unique model, options range from visual enhancements such as illuminated AMG door sills or AMG Carbon Fibre Trim Packages, to performance-oriented options such as AMG rear axle limited-slip differential lock or an AMG Performance suspension. Also available is the AMG Driver's Package (standard on C 63 AMG Edition 507), which raises the electronically limited top speed and includes participation at an AMG 'Power & Passion' driving event.

---

### AMG Performance Studio

18" AMG 5-twin-spoke alloy wheels in burnished Titanium Grey finish,<sup>1</sup> or 19" AMG multi-spoke alloy wheels, painted in Titanium Grey<sup>1</sup>

AMG Driver's Package (standard on C 63 AMG Edition 507)

AMG Exterior Carbon Fibre Trim Package, comprising carbon fibre boot lid spoiler and exterior mirror housings<sup>1</sup>

AMG carbon fibre interior trim

AMG illuminated door sill panels

AMG Performance Media

AMG rear axle limited-slip differential lock

---

<sup>1</sup>Not available on C 63 AMG Edition 507





> View price list



> View offers



> New C-Class



> Mercedes-Benz Magazine

## Standard equipment | Selection



Intelligent Light System with Adaptive High Beam Assist



3-spoke 12-button multi-function steering wheel with nappa leather trim, perforated in central grip area<sup>1</sup>



Automatic climate control



Coupé-specific front seats. AMG Sport Edition shown



LED rear tail lights



Audio 20 radio with Bluetooth® interface



ECO start/stop function



USB port

<sup>1</sup>Standard on AMG Sport Edition only







## Option packages

The Premium and Premium Plus Package are designed to offer more for the C-Class Coupé



COMAND Online system



Reversing camera



Panoramic glass sunroof



Heated front seats

Once you've made your choice between the Executive SE and the AMG Sport Edition model, the C-Class Coupé has yet more to offer.

True to its name, the Premium Package holds a whole range of comfort features: COMAND Online with Media Interface, our most advanced navigation system that connects you with a world of entertainment and information, heated front seats, a reversing camera and the Lighting Package. It includes beautifully lit areas in the cockpit, as well as courtesy lighting in the exterior mirrors and doors.

If you opt for Premium Plus, you'll enjoy the same benefits plus a panoramic glass sunroof to create that bright and airy feeling inside the coupé.





> View price list



> View offers



> New C-Class



> Mercedes-Benz Magazine

## C-Class Coupé Executive SE

The Executive SE exterior provides the perfect blend of sporty and dynamic driving pleasure with elegant and graceful design. Its front end features a sports grille with integrated star set within stylish bumpers. The Intelligent Light System with bi-xenon headlamps offers drivers the greatest possible view of the road, while the LED rear tail lights lend an eye-catching touch to the rear.



Sports grille with integrated star and Intelligent Light System with bi-xenon headlamps



16" 7-spoke design alloy wheels

---

### Exterior

---

16" alloy wheels – 7-spoke design

Bi-xenon headlamps with Intelligent Light System, LED daytime running lights and Adaptive High Beam Assist

LED rear tail lights

Parktronic with Advanced Parking Guidance

Sports grille with integrated star

---





> View price list



> View offers



> New C-Class



> Mercedes-Benz Magazine



Audio 20 radio with 6-disc CD changer

The interior is upholstered in Artico leather,<sup>1</sup> which is complemented by a multi-function steering wheel and a nappa leather-trimmed gear shift, while the 6-disc CD changer and DAB digital radio tuner provide the perfect soundtrack to any journey.



LED rear tail lights

**Interior**

Artico leather<sup>1</sup> upholstery

Audio 20 radio with 6-disc CD changer

Bluetooth<sup>®</sup> interface

Coupé-specific sports seats

DAB digital radio tuner

Split-folding rear seats

<sup>1</sup>Man-made leather

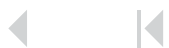



> View price list



> View offers



> New C-Class



> Mercedes-Benz Magazine



The standard Artico leather<sup>1</sup> upholstery for the Executive SE model line features seats, lower dashboard and door centre panels in black. The A-, B- and C-pillar trims, upper dashboard and fabric roof lining are in black. There's additional high gloss Black trim for the dashboard, doors and centre console.

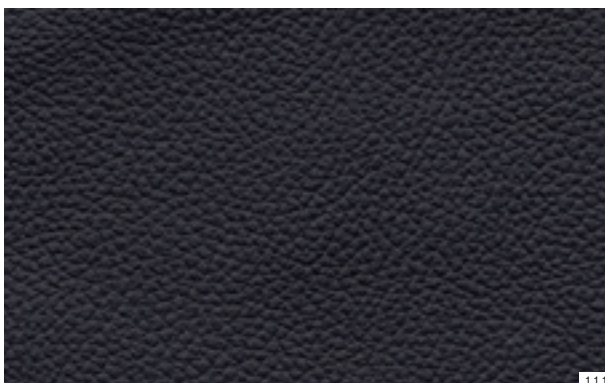

111



H80

**Black**

111 Artico leather<sup>1</sup>

**Trim**

H80 High gloss Black

<sup>1</sup>Man-made leather





> View price list



> View offers



> New C-Class



> Mercedes-Benz Magazine



Artico leather<sup>1</sup> upholstery features seats, lower dashboard trim and door centre panels in Alpaca Grey for Executive SE. The A-, B- and C-pillar trims, upper dashboard and fabric roof lining are in black. There's additional high gloss Black trim for the dashboard, doors and centre console.

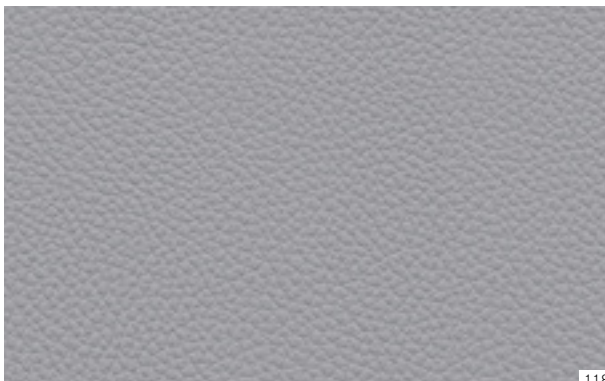

118



H80

---

**Alpaca Grey**

---

118 Artico leather<sup>1</sup>

---

**Trim**

---

H80 High gloss Black

---

<sup>1</sup>Man-made leather





> View price list



> View offers



> New C-Class



> Mercedes-Benz Magazine

## C-Class Coupé AMG Sport Edition

The AMG Sport Edition makes for a striking and involving C-Class Coupé. Its standard sports suspension and sports parameter steering (electric power steering on C 180) increase your driving enjoyment, while the AMG styling enhancements add extra muscularity to the exterior. They include an AMG front apron, side skirts, a diffuser-style rear apron and 18" AMG 7-spoke alloy wheels.

The AMG Sport Edition interior not only looks more dynamic, it feels it too. The flat-bottomed 3-spoke multi-function sports steering wheel is tactile and grippy. Other interior highlights include dark brushed aluminium trim and a black roof lining.

---

### Exterior

---

18" AMG alloy wheels – 7-spoke design

---

AMG bodystyling comprising front and rear aprons and side skirts

---

Electric power steering (C 180)

---

Lowered sports suspension

---

Parktronic with Advanced Parking Guidance

---

Sports parameter (speed-sensitive) steering (excluding C 180)

---

### Interior

---

3-spoke 12-button multi-function sports steering wheel with flat-bottomed rim and nappa leather trim, perforated central grip area

---

Attention Assist

---

Black roof lining

---

DAB digital radio tuner and USB port

---

Dark brushed aluminium trim

---



AMG front apron and side skirts, and a diffuser-style rear apron



18" AMG 7-spoke alloy wheels





> View price list



> View offers



> New C-Class



> Mercedes-Benz Magazine



The standard Black interior colour scheme on AMG Sport Edition models features Black seats in Artico leather<sup>1</sup>/Dinamica microfibre with grey and blue stitching and a Black dashboard. The A-, B- and C-pillar trims and fabric roof lining are in black. There's additional dark brushed aluminium trim for the dashboard.

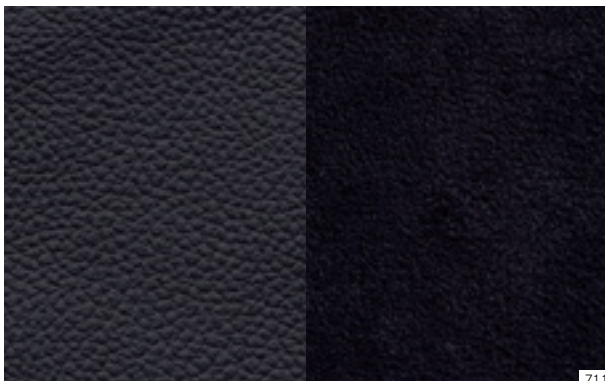

711



739

**Black**

711 Artico leather<sup>1</sup>/Dinamica microfibre

**Trim**

739 Dark brushed aluminium

<sup>1</sup>Man-made leather





## Alloy wheels



16" AMG 7-spoke alloy wheels (standard on Executive SE, code R75)



18" AMG 7-spoke alloy wheels (standard on AMG Sport Edition, code 782)



18" AMG 5-twin-spoke alloy wheels, with burnished Titanium Grey finish (standard on C 63 AMG, code 795)



18" AMG 5-twin-spoke alloy wheels with burnished Titanium Grey finish (optional on C 63 AMG, code 790)



19" AMG multi-spoke alloy wheels, with burnished Titanium Grey finish (optional on C 63 AMG, code 788)



19" AMG multi-spoke alloy wheels, painted black (optional on C 63 AMG, code 797)



19" AMG cross-spoke alloy wheels, painted Titanium Grey (standard on C 63 AMG Edition 507, code 785)



19" AMG cross-spoke alloy wheels, painted matt black (optional on C 63 AMG Edition 507, code 793)

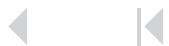





> View price list



> View offers



> New C-Class



> Mercedes-Benz Magazine

## Retailer-fit accessories

A Mercedes-Benz is not just a car, it's a travel companion that can be tailored to your needs – with our wide range of Retailer-fit accessories.

→ [www.mercedes-benz.co.uk/accessories](http://www.mercedes-benz.co.uk/accessories)

Our Retailer-fit accessories enable you to create the perfect C-Class Coupé for your lifestyle. If you often need to transport lots of luggage or sports gear, you'll find the ideal solution in our range of roof racks and boxes. The boxes come in two different sizes: the family version holds 450 litres while the sports box swallows 330 litres. Both open and close on either side and can be mounted on our Retailer-fit roof bars for safe and secure transportation.

Also available are a luggage set and ski bags designed specifically to fit the roof boxes.

Add a sporty touch to your C-Class Coupé with an eye-catching Mercedes-Benz boot spoiler.

A very practical technical feature that puts your mind at rest is Tracker™. If your C-Class Coupé is ever stolen, VHF

(Very High Frequency) technology tracks your car's location – even if it's held in a garage or an underground car park.

For more details about these and other C-Class Coupé accessories, please see the relevant brochure or talk to your local Mercedes-Benz Retailer.



Roof bars with 'Comfort' ski and snowboard rack



Boot spoiler



The Mercedes-Benz InCar Hotspot enables wi-fi Internet access





## Services

**Test drive.** You've seen the pictures, you've read the facts. Now all that's missing is to experience your dream Mercedes in the flesh. Which is why we invite you to take it for a spin. See it with your own eyes. Rev up the engine, and feel how your chosen Mercedes hugs the road. Relax in style or play with a whole host of exciting onboard technology. Contact your Mercedes-Benz Retailer for a test drive, or simply go online and visit [www.mercedes-benz.co.uk/testdrive](http://www.mercedes-benz.co.uk/testdrive). We can't wait to see you in the driving seat.

**Mercedes-Benz Finance.** At Mercedes-Benz Finance, our single-minded aim is to provide optimum financial solutions for all those who share the Mercedes-Benz philosophy of absolute commitment to quality. Whether you are a private customer or a business user, our finance and leasing packages can be tailored to meet your individual needs. For further information on Mercedes-Benz Finance, please contact your local Mercedes-Benz Retailer.



**Mercedes-Benz Insurance** offers a fully comprehensive 5-star Motor Insurance policy, rated by Defaqto, a leading UK independent financial research company. Our policy is specifically designed to provide the cover you would expect from Mercedes-Benz. For a quotation, please call 0345 600 2180.<sup>1</sup>

**Interactive Owner's Manual.** The website also offers an interactive tour, enabling you to take a closer look at your desired model. This simulation is the ideal way to acquaint yourself with your dream car. You can view key functions in detail, gain an insight into the car's inner workings or look at the benefits of each model. For further details, visit [www.mercedes-benz.co.uk/cclasscoupemannual](http://www.mercedes-benz.co.uk/cclasscoupemannual)

<sup>1</sup>Mercedes-Benz Motor Insurance is underwritten by Aviva Insurance Limited. For joint protection, calls may be recorded and/or monitored. All calls are charged at local rate. We may decline to quote in some circumstances





**Roadside Assistance.** Rest assured that should you ever need help, Mercedes-Benz Roadside Assistance is there for you. In the unlikely event of a technical breakdown<sup>2</sup> you can rely on the Mercedes-Benz Roadside Assistance Team – anywhere in Europe. Simply phone our Customer Assistance Centre on Freephone +44 (0) 207 975 7077,<sup>3</sup> where our specialists will organise assistance for you. Mercedes-Benz will also assist you in the event of a minor mishap preventing you from driving your vehicle.<sup>4</sup> Whether you lose your key, run out of fuel, or your vehicle is damaged due to an accident or vandalism,<sup>4</sup> Mercedes-Benz ensures that you still reach your destination. Often, the problem can be rectified on the spot, but if this is not possible, we will naturally ensure that your vehicle is taken to the nearest Mercedes-Benz Retailer to get you back on the road as quickly as possible.

<sup>2</sup>Cover is initially valid for your vehicle for four years from the date of first registration. This can be extended from the fifth year, up to a maximum of 30 years, on completion of each scheduled maintenance service, providing that this service is carried out by a Mercedes-Benz Retailer, and recommended items are completed

<sup>3</sup>If your mobile phone provider charges for Freephone numbers please call 0207 975 7077

<sup>4</sup>Minor mishap cover is provided at the absolute discretion of Mercedes-Benz

**Service Care.** To keep a tight grip on costs, Mercedes-Benz offers service plans to cover the costs of an annual service, for two, three and four years. Plans can be paid monthly with interest-free instalments or alternatively, if you pay upfront, should you sell your vehicle any remaining services will be transferred to the new owner. All routine maintenance and additional items are covered. To find out more, please contact your local Retailer or visit [www.mercedes-benz.co.uk/servicecare](http://www.mercedes-benz.co.uk/servicecare)

**Mercedes-Benz World at Brooklands.** Put our latest vehicles to the test at Mercedes-Benz World. Book an AMG Driving Experience on our handling circuits or tackle the deep water crossings and axle-twisting obstacles on our 10 acre off-road course. Under 16s can drive on the historic Brooklands circuit, while three to five year olds can become Little Learners on our indoor driving circuit. Discover automotive legends like the original 300 SL Gullwing, Formula 1® cars and the UK's largest collection of Mercedes-Benz and AMG models under one roof. Relax and refuel in Café 1886, or enjoy the delicious menu and elegant surroundings of the Gullwing Bistro. With three floors of interactive attractions and exhibitions, free entry and free parking every day, the whole family will enjoy an adrenaline-fuelled day out at Mercedes-Benz World. To book a Driving Experience call 0370 400 4000 or for more information visit [www.mercedes-benzworld.co.uk](http://www.mercedes-benzworld.co.uk)

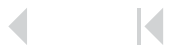



# Dimensions

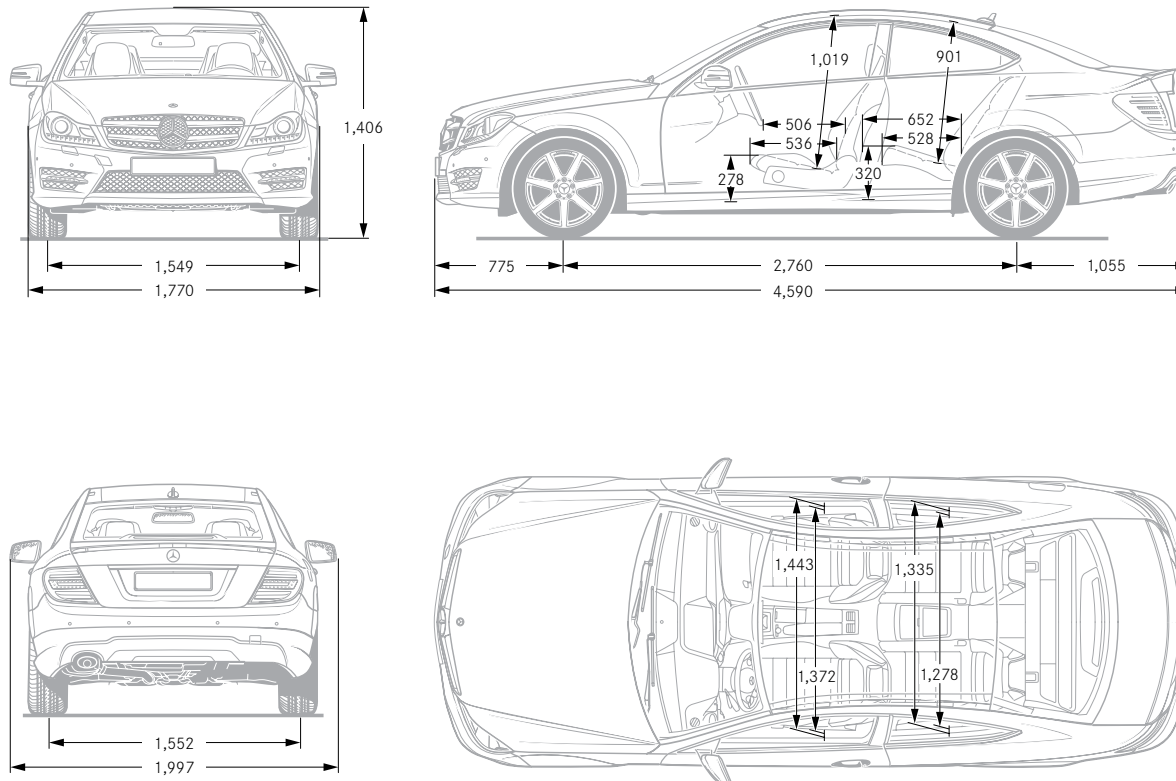

All measurements in millimetres. The dimensions shown are mean values and apply to standard-specification, unladen vehicles





# Technical specifications

	Diesel engines	
	C 220 CDI	C 250 CDI
Arrangement/cylinders/valves	in-line/4/16	in-line/4/16
Total displacement - cc	2,143	2,143
Rated output <sup>1</sup> - hp (kW) at rpm	170 (125)/3,000-4,200	204 (150)/4,200
Rated torque <sup>1</sup> - Nm at rpm	400/1,400-2,800	500/1,600-1,800
Acceleration 0-62 mph - sec (auto.)	8.4 (8.1)	7.0 (7.1)
Top speed approx. - mph (auto.)	144 (144)	149 (149)
Tyre size - front, rear	205/55 R 16, 205/55 R 16	225/40 R 18, 255/35 R 18
Fuel consumption <sup>2</sup> - mpg (auto.)		
Urban	54.3 (46.3)	41.5 (43.5)
Extra-urban	80.7 (67.3)	61.4 (61.4)
Combined	68.9 (57.7)	52.3 (53.3)
CO <sub>2</sub> emissions, combined <sup>2</sup> - g/km (auto.)	109 (128)	143 (139)
EU emissions standard	EU5	EU5
Fuel tank capacity/reserve (approx.) - l	66/8	66/8
Boot capacity - l	450	450
Turning circle - m	10.84	10.84
Kerb weight <sup>3</sup> - kg (auto.)	1,615 (1,630)	1,655 (1,660)
Perm. GVW - kg (auto.)	2,085 (2,100)	2,125 (2,130)

<sup>1</sup>Figures according to Directive 80/1269/EEC in the currently applicable version

<sup>2</sup>The figures shown were obtained in accordance with the prescribed measuring process (Regulation [EC] 715/2007 in the currently applicable version).

The figures are not based on an individual vehicle and do not constitute part of the product offer; they are provided solely for purposes of comparison between different vehicle models

<sup>3</sup>Figures according to Directive 92/21/EC, version 95/48/EC (kerb weight with fuel tank 90% full, driver, 68 kg, and luggage, 7 kg) for standard-specification vehicles. Optional extras and accessories will generally increase this figure and reduce the payload capacity accordingly

Values in parentheses refer to engines with automatic transmission For more specifications, visit [www.mercedes-benz.co.uk](http://www.mercedes-benz.co.uk)





	<b>Petrol engines</b>		
	<b>C 180</b>	<b>C 63 AMG</b>	<b>C 63 AMG Edition 507</b>
Arrangement/cylinders/valves	in-line/4/16	V/8/32	V/8/32
Total displacement – cc	1,595	6,208	6,208
Rated output <sup>1</sup> – hp (kW) at rpm	156 (115)/5,300	457 (336)/6,800	507 (373)/6,800
Rated torque <sup>1</sup> – Nm at rpm	250/1,250–4,000	600/5,000	610/5,200
Acceleration 0–62 mph – sec (auto.)	8.5 (8.5)	– (4.4)	4.2
Top speed approx. – mph (auto.)	140 (139)	– (155) <sup>4</sup>	– (174) <sup>4</sup>
Tyre size – front, rear	225/40 R 18, 255/35 R 18	235/40 R 18, 255/35 R 18	235/35 R 19, 255/30 R 19
Fuel consumption <sup>2</sup> – mpg (auto.)			
Urban	34.9 (35.3)	– (15.5)	– (15.5)
Extra-urban	52.3 (53.3)	– (33.6)	– (33.6)
Combined	44.1 (44.8)	– (23.5)	– (23.5)
CO <sub>2</sub> emissions, combined <sup>2</sup> – g/km (auto.)	149 (147)	– (280)	– (280)
EU emissions standard	EU6	EU5	EU5
Fuel tank capacity/reserve (approx.) – l	66/8	66/14	66/14
Boot capacity – l	450	450	450
Turning circle – m	10.84	11.10	11.10
Kerb weight <sup>3</sup> – kg (auto.)	1,490 (1,505)	– (1,730)	– (1,730)
Perm. GVW – kg (auto.)	1,960 (1,975)	– (2,160)	– (2,160)

<sup>1</sup>Figures according to Directive 80/1269/EEC in the currently applicable version<sup>2</sup>The figures shown were obtained in accordance with the prescribed measuring process (Regulation [EC] 715/2007 in the currently applicable version).

The figures are not based on an individual vehicle and do not constitute part of the product offer; they are provided solely for purposes of comparison between different vehicle models

<sup>3</sup>Figures according to Directive 92/21/EC, version 95/48/EC (kerb weight with fuel tank 90% full, driver, 68 kg, and luggage, 7 kg) for standard-specification vehicles. Optional extras and accessories will generally increase this figure and reduce the payload capacity accordingly<sup>4</sup>Electronically limited Values in parentheses refer to engines with automatic transmission For more specifications, visit [www.mercedes-benz.co.uk](http://www.mercedes-benz.co.uk)



## Paint finishes

The highly durable nature of the Mercedes-Benz paint system makes it one of the best clear coats available in the automotive industry. A highly dense molecular structure provides the key to the extremely resilient paint, regardless whether it's non-metallic or metallic, giving the surface a longer lasting, more intense shine.

### Non-metallic paints (standard)



149



590

### Metallic paints (optional)

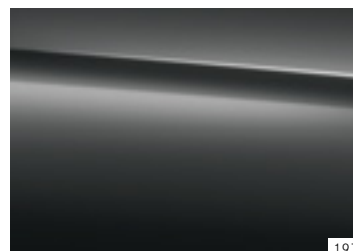

197

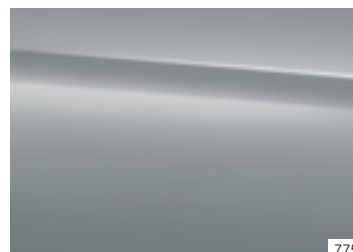

775

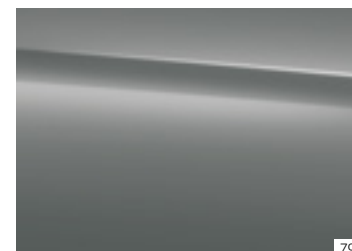

792

### Special metallic paint (optional)



799

#### Non-metallic paints (standard)

149 Polar White

590 Fire Opal

#### Metallic paints (optional)

197 Obsidian Black

775 Iridium Silver

792 Palladium Silver<sup>1</sup>

#### Special metallic paint (optional)

799 Diamond White<sup>1</sup><sup>1</sup>Not available on C 63 AMG Edition 507



> View price list



> View offers



> New C-Class



> Mercedes-Benz Magazine

Follow us on the following social media channels:



<https://www.facebook.com/MercedesBenzUk>



<https://twitter.com/mercedesbenz>



<https://www.youtube.com/user/mercedesbenz>



<https://instagram.com/mercedesbenz>

**Take-back of end-of-life vehicles. Coming full circle.** At the end of its long life, you can return your C-Class to us for environment-friendly disposal in accordance with the EC End-of-Life Vehicle Directive! But that day lies a long way off.

<sup>1</sup>Applies in accordance with national regulations to vehicles up to 3.5 t permissible gross weight. The C-Class Coupé has met the statutory regulations governing the suitability of the vehicles' design for reuse and recycling for a number of years now. A network of vehicle take-back depots and dismantlers has been established which will process your vehicle in an environment-friendly manner. The ways in which both vehicles and parts can be recovered are subject to ongoing development and improvement. Consequently, the C-Class Coupé will be able to comply with any future increases in the recycling quota within the stipulated time limits. Further information is available at [www.mercedes-benz.co.uk](http://www.mercedes-benz.co.uk) or call 0333 222 0500.

**Please note:** this online version of the printed brochure may contain abridged copy or other content changes. The manufacturer reserves the right to make changes to the design, form, colour and specification during the delivery period, provided these changes, while taking into account the interests of the vendor, can be deemed reasonable with respect to the purchaser. Where the vendor or the manufacturer uses symbols or numbers to describe an order or the subject of an order, no rights may be derived solely from these. The illustrations may show accessories and items of optional equipment which are not part of standard specification. Colours may differ slightly from those shown in the brochure, owing to the limitations of the printing process. This brochure has been compiled by Daimler AG of Germany and is distributed internationally. It provides a general indication of the range of models, features, optional extras and/or colours available in various countries. Some of the models, features, optional extras and/or colours shown may not be available in your country or may only be available in a different specification. Additionally some models, features, optional extras and/or colours may only be available in combination with others. For current and more specific information in relation to the range of models, features, optional extras and/or colours available in your country, and their pricing, you should contact your nearest authorised Mercedes-Benz Retailer. E&OE. [www.mercedes-benz.co.uk](http://www.mercedes-benz.co.uk)

Daimler AG, Mercedesstr. 137, 70372 Stuttgart MS/MAA 6701 · 0351 · 88-06/0614

## DOWNLOAD THE APP

Experience the C-Class Coupé in an interactive and engaging way: download the free Mercedes-Benz C-Class Coupé brochure app for iPad® from the App Store

