



> View price list



> View offers



> New C-Class



> Mercedes-Benz Magazine

C-Class Estate



Mercedes-Benz





> View price list



> View offers



> New C-Class



> Mercedes-Benz Magazine



The new C-Class. More room for style.

The new C-Class Estate lives and breathes generosity. It offers an incredibly spacious, versatile interior that can easily accommodate work and play. Naturally, you're also surrounded by the best driving and safety technology under the three-pointed star. Take Agility Select, which allows you to choose between a variety of driving modes to suit your driving style.

A wide range of electronic assistants help prevent accidents by, for example, reminding you to take a break if you show signs of tiredness. Then there are the responsive and highly efficient engines that make the new C-Class Estate not only incredibly CO₂ efficient, but also incredibly dynamic and vigorous. You'll find the new C-Class Estate will simply keep on rewarding you and every one around you, day after day.

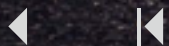



> View price list



> View offers



> New C-Class



> Mercedes-Benz Magazine



All eyes on intelligence.

Take a seat in the new C-Class Estate, and you'll discover a new level of style and comfort – whether it's the high quality materials or the advanced technology. You'll instantly notice the new touchpad to control the high definition central screen. Or, for added convenience, there's the optional head-up display. It shows journey information like speed, speed limits and navigation commands on a virtual colour image projected onto the windscreen right in front of the driver's eyes.

AMG Line interior with optional Premium Plus Package, Black Ash wood trim, Driving Assistance Package, 360° camera and leather upholstery





> View price list



> View offers



> New C-Class



> Mercedes-Benz Magazine



Wherever you're headed, you're
always in a special place.

Sometimes, space can seem like a luxury, yet in the new C-Class Estate it feels effortless. The 40:20:40 split rear seat can be easily folded flat from the boot. And for an even more welcoming atmosphere, ambient lighting is available as part of our Premium and Premium Plus Packages.





> View price list



> View offers



> New C-Class



> Mercedes-Benz Magazine

SE

Spacious, dynamic, and plenty of high-end technology as standard: the new C-Class Estate SE comes with a reversing camera, a multi-touch control touchpad and Agility Select, which allows you to choose between five individual driving modes: Comfort, ECO, Sport, Sport+ and Individual. To match the bold exterior, the C-Class SE is fitted with Black Artico man-made leather and high gloss Black trim for a stylish atmosphere inside the cabin. It's generosity at its best.



Sport

The Sport is fitted with the same high level of equipment as the C-Class Estate SE and more: to emphasise the dynamic appeal, it also has 17" alloy wheels, high-performance LED headlamps and sport styling. Inside the spacious cabin, you're welcomed by sophisticated technology like Parktronic with Active Park Assist and Garmin® Map Pilot navigation system as standard. For your comfort, there are heated front seats with Artico man-made leather upholstery, a high gloss black centre console, and brushed aluminium trim on the door panels and dashboard.

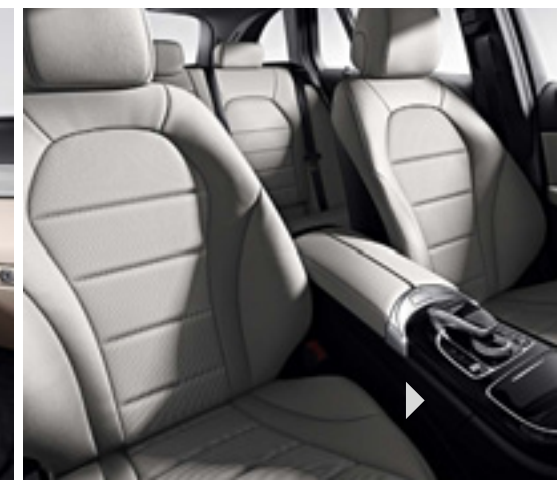



> View price list



> View offers



> New C-Class



> Mercedes-Benz Magazine

AMG Line

The AMG Line gives the C-Class an even greater presence with AMG design highlights: you'll notice the AMG bodystyling complete with AMG front and rear aprons, side skirts, plus 18" AMG alloy wheels and visible twin-pipe exhaust trim integrated into the rear bumper. The interior reflects the AMG spirit: here, AMG sports seats and an upper dashboard fitted with Artico man-made leather and contrast stitching. The AMG multi-function flat-bottomed steering wheel is designed to add control, while the pedals feature brushed stainless steel and the floor mats carry the AMG signature. Responsible for a thoroughly dynamic drive: the lowered sports suspension and the Sports Direct-Steer system.

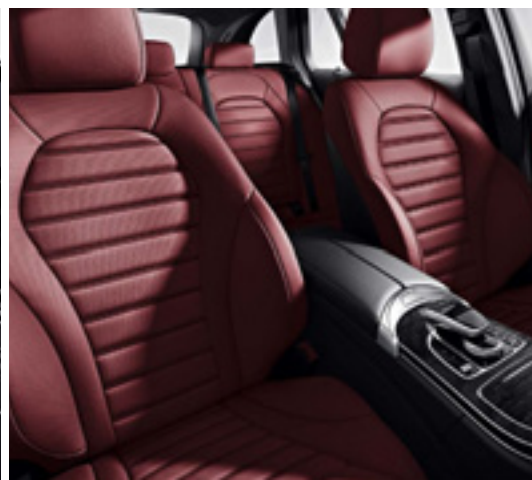

Space management

The load compartment area of the new C-Class Estate is not only well proportioned, it's also incredibly well organised. For example, the rear seats can be split 40:20:40 for added versatility. The middle section can be folded flat individually or together with the section on the driver's side. And thanks to the Easy-Pack tailgate, the boot can be opened and closed at the touch of a button.





> View price list



> View offers



> New C-Class



> Mercedes-Benz Magazine

Executive Package

When it comes to personalising and enhancing your choice of new C-Class Estate, our range of optional equipment packages do just that. The optional Executive Package is designed exclusively for the SE to let you enjoy each journey that little bit more. It includes the highly sophisticated Garmin® Map Pilot navigation system, heated front seats and chrome roof rails.

Premium Package

The optional Premium Package has everything to maximise your well-being on board: it features ambient lighting; the Keyless-Go Comfort Package for effortless entry, starting and exit; fully electrically adjustable front seats, steering column and exterior mirrors with memory function; plus a panoramic glass sunroof to brighten up the cabin of this stunning estate.





> View price list



> View offers



> New C-Class



> Mercedes-Benz Magazine

Premium Plus Package

If you want to increase your comfort and add the best in entertainment to the Sport and AMG Line, then this perfect all-rounder contains the same features as the Premium Package, plus the highly sophisticated Burmester® surround sound system and COMAND Online with an 8.4-inch high-resolution colour display, 3D map navigation and internet connectivity. The Premium and Premium Plus Packages are exclusively available on the Sport and AMG Line with automatic transmission.

Driving Assistance Package

The optional Driving Assistance Package contains a range of highly intelligent features to help you and yours stay safe on the road – by making the drive more effortless, by warning of danger, and by actively intervening in case of an emergency. It includes Blind Spot Assist, DISTRONIC Plus, Lane-Keeping Assist and Pre-Safe® anticipatory safety system. The Driving Assistance Package is exclusively available on the Sport and AMG Line with automatic transmission.

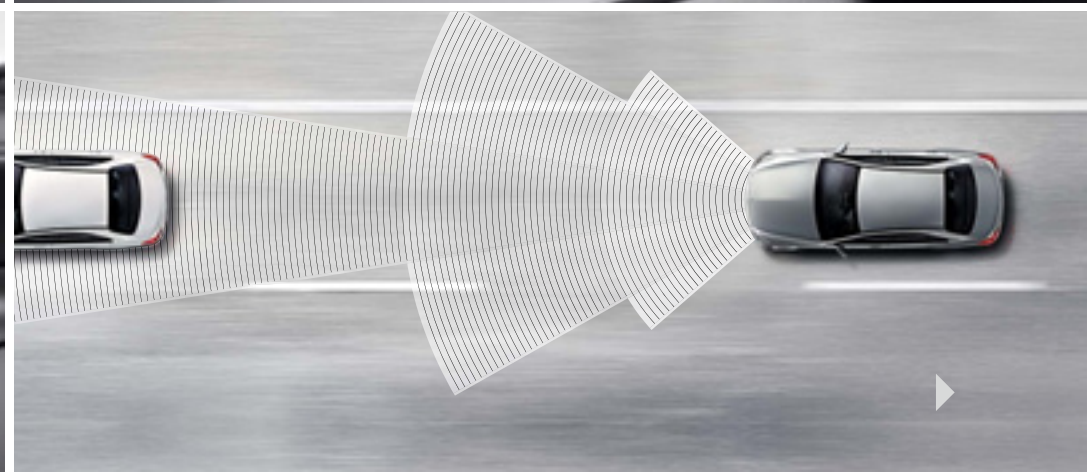



> View price list



> View offers



> New C-Class



> Mercedes-Benz Magazine

Upholstery and trim

SE

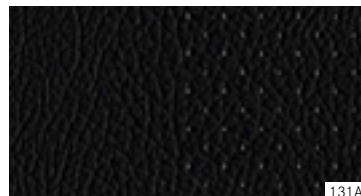

131A

Sport

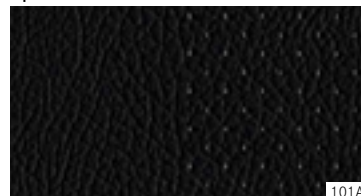

101A

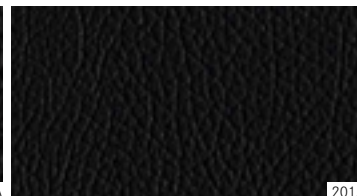

201A

AMG Line



141A

Artico man-made leather¹

- 131A Black
- 101A Black
- 115A Silk Beige
- 118A Crystal Grey
- 141A Black

Leather²

- 201A Black
- 215A Silk Beige
- 218A Crystal Grey
- 251A Black
- 267A Cranberry Red
- 268A Crystal Grey

Trim

- H80 High gloss Black³
- 739 High gloss Black with aluminium door trim⁴
- 731 Burr Walnut wood trim^{5,6}
- H07 Finition Dark Brown wood trim⁵
- 736 Black Ash wood trim⁵



H80

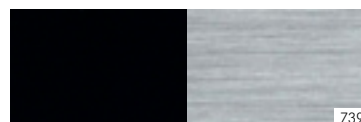

739



731

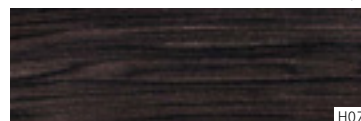

H07

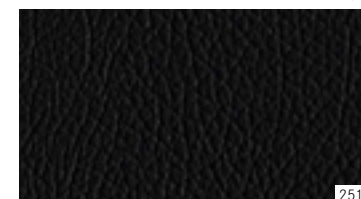

251A

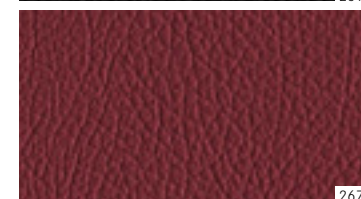

267A

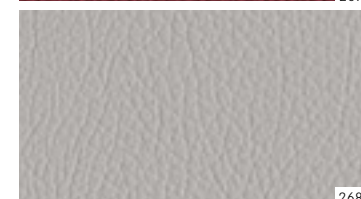

268A

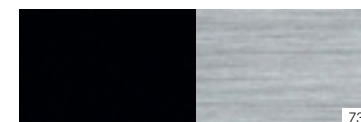

739



736

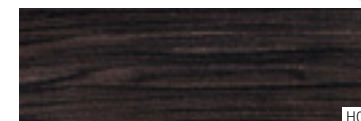

H07

¹Standard

²Optional

³Standard on SE

⁴Standard on Sport and AMG Line

⁵All wood trims in conjunction with automatic transmission will feature an analogue clock in the centre console

⁶Only available with Silk Beige upholstery (code 115A and 215A)

The manufacturer reserves the right to make changes to the design, form, colour and specification during the delivery period, provided these changes, while taking into account the interests of the vendor, can be deemed reasonable with respect to the purchaser.





> View price list



> View offers



> New C-Class



> Mercedes-Benz Magazine

Paint finishes

Non-metallic paints

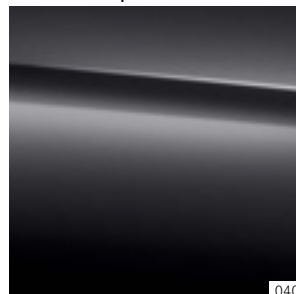

040

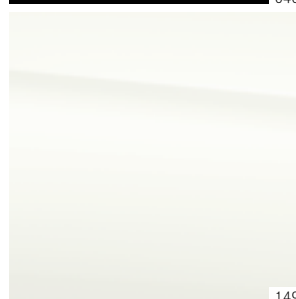

149

Metallic paints

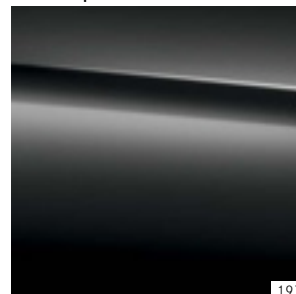

197

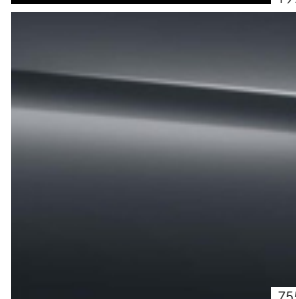

755

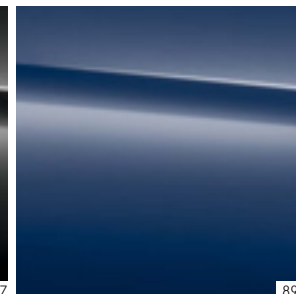

890

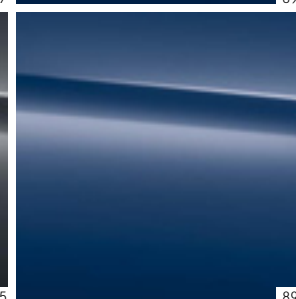

896

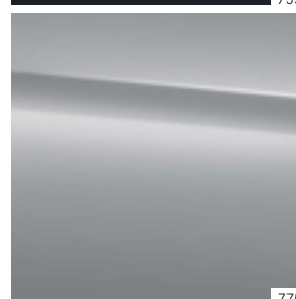

775

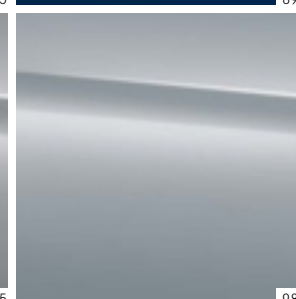

988

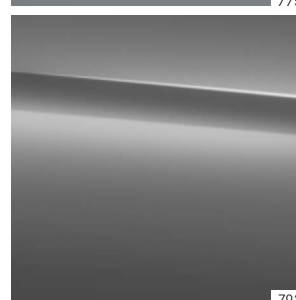

792

Special metallic paints

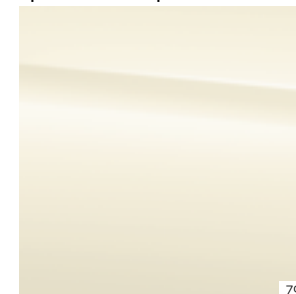

799

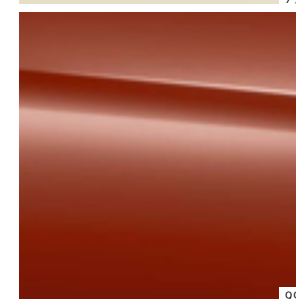

996

Non-metallic paints¹

- 040 Black
- 149 Polar White

Metallic paints²

- 197 Obsidian Black
- 755 Tenorite Grey
- 775 Iridium Silver
- 792 Palladium Silver
- 890 Cavansite Blue
- 896 Brilliant Blue
- 988 Diamond Silver

Special metallic paints²

- 799 *designo* Diamond White
- 996 *designo* Hyacinth Red

¹Standard
²Optional





Technical specifications

	DIESEL ENGINES		PETROL ENGINE
	C 220 BlueTEC	C 250 BlueTEC	C 200
Arrangement/cylinders/arrangement	in-line/4/16	in-line/4/16	in-line/4/16
Total displacement - cc	2,143	2,143	1,991
Rated output ¹ - hp (kW) at rpm	170 (125)/3,000-4,200	204 (150)/3,800	184 (135)/5,500
Rated torque ¹ - Nm at rpm	400/1,400-2,800	500/1,600-1,800	300/1,200-4,000
Transmission ²	6-speed manual (7G-Tronic Plus)	7G-Tronic Plus	6-speed manual (7G-Tronic Plus)
Acceleration 0-62 mph - sec (auto.)	7.9 (7.6)	- (6.9)	7.7 (7.5)
Top speed, approx. - mph (auto.)	143 (142)	- (150)	146 (145)
Tyre size	205/60 R 16	205/60 R 16	205/60 R 16
Fuel consumption ³ - mpg (auto.)			
Urban	54.3 (53.3)	- (52.3)	40.4 (40.4)
Extra-urban	76.4 (74.3)	- (72.4)	61.4 (61.4)
Combined	65.7 (64.2)	- (62.8)	51.4 (51.4)
CO ₂ emissions, combined ³ - g/km (auto.)	108-115 (114-121)	- (117-124)	128-135 (128-138)
EU emissions standard	EU6	EU6	EU6
Fuel tank capacity/reserve, approx. - l	66/7	66/7	66/7
Boot capacity - l	490-1,510	490-1,510	490-1,510
Turning circle - m	11,22	11,22	11,22
Kerb weight ⁴ - kg (auto.)	1,595 (1,615)	- (1,660)	1,495 (1,525)
Perm. GVW - kg (auto.)	2,170 (2,190)	- (2,235)	2,070 (2,100)
Length ⁵ /width incl. mirrors ⁵ - mm	4,702/2,020	4,702/2,020	4,702/2,020
Wheelbase ⁵ - mm	2,840	2,840	2,840
Track, front ⁴ /rear ⁵ - mm	1,584/1,573	1,584/1,573	1,584/1,573

¹Figures according to Directive 80/1269/EEC in the currently applicable version ²With ECO start/stop ³The figures shown were obtained in accordance with the prescribed measuring process (Regulation [EC] 715/2007 in the currently applicable version). The figures are not based on an individual model and do not constitute part of the product offer; they are provided solely for purposes of comparison between different vehicle models

⁴Figures according to Directive 92/21/EC, version 95/48/EC (kerb weight with fuel tank 90% full, driver, 68 kg, and luggage, 7 kg) for standard-specification vehicles. Optional extras and accessories will generally increase this figure and reduce the payload capacity accordingly

⁵The dimensions shown are mean values, and apply to unladen vehicles with standard equipment For further technical data, please visit www.mercedes-benz.co.uk





> View price list



> View offers



> New C-Class



> Mercedes-Benz Magazine

Dimensions

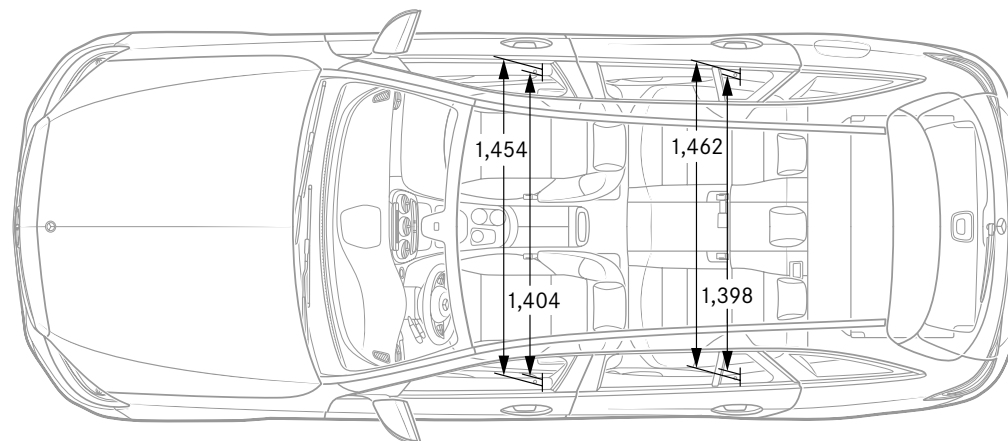
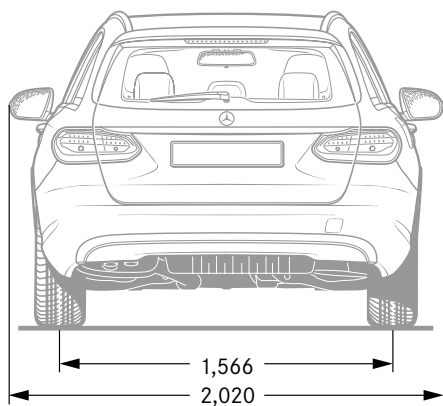
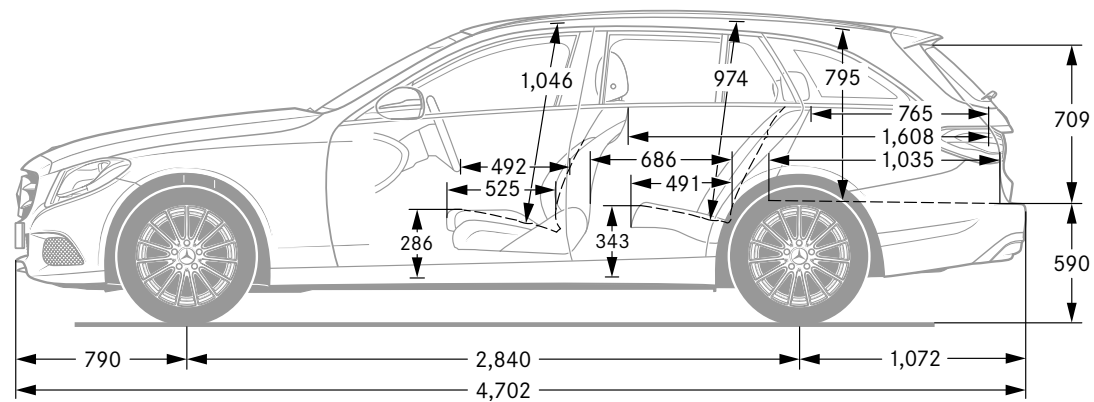
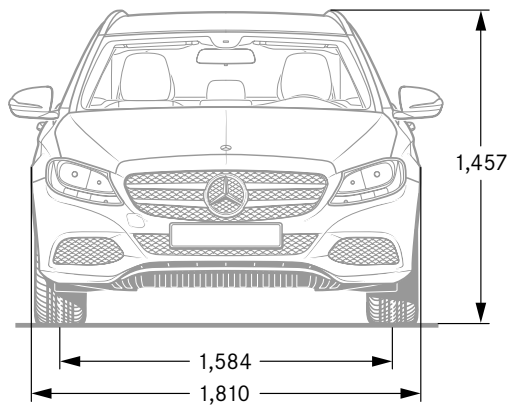

All measurements in millimetres. The dimensions shown are mean values and apply to standard-specification, unladen vehicles





> View price list



> View offers



> New C-Class



> Mercedes-Benz Magazine

Take-back of end-of-life vehicles. Coming full circle. At the end of its long life, you can return your C-Class to us for environment-friendly disposal in accordance with the EC End-of-Life Vehicle Directive.¹ But that day lies a long way off.

¹Applies in accordance with national regulations to vehicles up to 3.5 t permissible gross weight. The C-Class has met the statutory regulations governing the suitability of the vehicles' design for reuse and recycling for a number of years now. A network of vehicle take-back depots and dismantlers has been established which will process your vehicle in an environment-friendly manner. The ways in which both vehicles and parts can be recovered are subject to ongoing development and improvement. Consequently, the C-Class will be able to comply with any future increases in the recycling quota within the stipulated time limits. Further information is available at www.mercedes-benz.co.uk or by calling 0333 222 0500.

Please note: this online version of the printed brochure may contain abridged copy or other content changes. The manufacturer reserves the right to make changes to the design, form, colour and specification during the delivery period, provided these changes, while taking into account the interests of the vendor, can be deemed reasonable with respect to the purchaser. Where the vendor or the manufacturer uses symbols or numbers to describe an order or the subject of an order, no rights may be derived solely from these. The illustrations may show accessories and items of optional equipment which are not part of standard specification. Colours may differ slightly from those shown in the brochure, owing to the limitations of the printing process. This brochure has been compiled by Daimler AG of Germany and is distributed internationally. It provides a general indication of the range of models, features, optional extras and/or colours available in various countries. Some of the models, features, optional extras and/or colours shown may not be available in your country or may only be available in a different specification. Additionally some models, features, optional extras and/or colours may only be available in combination with others. For current and more specific information in relation to the range of models, features, optional extras and/or colours available in your country, and their pricing, you should contact your nearest authorised Mercedes-Benz Retailer. www.mercedes-benz.co.uk

Daimler AG, Mercedesstr. 137, 70327 Stuttgart BC/MC 6701 · 0211 · 88-00/0714

Follow us on the following social media channels:



<https://www.facebook.com/MercedesBenzUK>



<https://twitter.com/mercedesbenz>



<https://www.youtube.com/mercedesbenz>



<https://instagram.com/mercedesbenz>

