



> View price list



View offers > Coupé > Cabriolet



> SOUND WITH POWER



> Mercedes-Benz Magazine



# E-Class

Coupé and Cabriolet



Mercedes-Benz





> View price list



View offers > Coupé > Cabriolet



> SOUND WITH POWER



> Mercedes-Benz Magazine

# The new E-Class. At its best

It's hard to imagine a more beautiful form of progression. Taut and full of excitement, the new E-Class Coupé and E-Class Cabriolet surge forward, eager to grace the world with their striking design. Their sweeping, athletic side profile promises a sporty adventure, while the bold and wide rear ensures excellent roadholding. Also, innovative

suspension technology, excellent seating comfort and an absolute commitment to quality contribute to a driving sensation that makes your heart beat faster – even when you're not behind the wheel. Whether you choose the Cabriolet in a range of soft-top colours, or the Coupé, the new E-Class always reveals itself at its best.





> View price list



View offers > Coupé > Cabriolet



> SOUND WITH POWER



> Mercedes-Benz Magazine

### Featured models at a glance:

**4 | Mercedes-Benz E 220 CDI AMG Sport Coupé**  
**Iridium Silver metallic**  
AMG 5-twin-spoke alloy wheels, Black nappa leather upholstery

**8 | Mercedes-Benz E 200 AMG Sport Coupé**  
**Diamond White metallic**  
AMG 7-twin-spoke alloy wheels, Bengal Red leather upholstery

**11 | Mercedes-Benz E 220 CDI SE Cabriolet**  
**Aragonite Silver metallic, Dark Blue soft-top**  
5-twin-spoke alloy wheels, Deep Sea Blue/Silk Beige nappa leather upholstery

**15 | Mercedes-Benz E 250 CDI AMG Sport Cabriolet**  
**Diamond White metallic, Dark Brown soft-top**  
AMG 5-twin-spoke alloy wheels, Espresso Brown leather upholstery

### Equipment options at a glance:

**20 | Engines and suspension**

**30 | Safety**

**36 | Comfort**

**44 | Equipment**

**68 | Services**

**70 | Facts and finishes**



With an iPad® you can download the interactive E-Class Coupé and Cabriolet brochure app either by scanning the QR code or by visiting the App Store

Illustrations may show accessories and items of optional equipment which are not part of standard specification





> View price list



View offers > Coupé > Cabriolet



> SOUND WITH POWER



> Mercedes-Benz Magazine

Overview 4



## Every hour is Coupé hour

When the sun hits the high sheen alloys, the striking new headlamps, or the Mercedes star now boldly positioned in the centre of the grille – that's when the new E-Class Coupé captures your heart.





> View price list



View offers > Coupé > Cabriolet



> SOUND WITH POWER



> Mercedes-Benz Magazine



Resolve from bumper to bumper. The dynamic, ascending bonnet, the muscular sidelines and the smooth, flat roofline create tension of the most interesting kind, culminating in the characteristic coupé profile. A unique side effect: the rear side windows can be lowered for uninterrupted beautiful effect.

Tension you can't get enough of

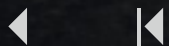



> View price list



View offers > Coupé > Cabriolet



> SOUND WITH POWER



> Mercedes-Benz Magazine



## We all make mistakes. But we won't let you

The new E-Class Coupé gets you safely to your destination – thanks to the latest in satellite navigation technology and a whole lot more. It monitors your distance to the car in front and ensures you don't veer off course. It monitors road signs and traffic junctions, and even keeps a check on your blind spot. → Pages 30–32, 39





[View price list](#)



[View offers](#) [Coupé](#) [Cabriolet](#)



[SOUND WITH POWER](#)



[Mercedes-Benz Magazine](#)





> View price list



View offers > Coupé > Cabriolet



> SOUND WITH POWER



> Mercedes-Benz Magazine

## Bright and beautiful

Brighter and braver. The new E-Class dips its main beam automatically as soon as it detects oncoming traffic or a car in front. Your fellow drivers will be thankful for it, and you have one less thing to worry about, as you benefit from safer driving. → Page 30

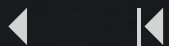





> View price list



View offers > Coupé > Cabriolet



> SOUND WITH POWER



> Mercedes-Benz Magazine



Finding a parking space and steering your car into it. That's another way to lighten your load. All you need to do is activate the accelerator. While this is millimetre-precise work, you'll find each and every mile equally as effortless. Everything is designed to ensure you're as comfortable as possible. That's why the E-Class automatically adapts to the road conditions, ensures quick and smooth gear changes with the 7G-Tronic Plus automatic transmission, and even alerts you to take a break when you become tired. → Pages 27–30, 38

## Space travel reinvented





> View price list



View offers > Coupé > Cabriolet



> SOUND WITH POWER



> Mercedes-Benz Magazine

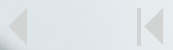



> View price list



View offers > Coupé > Cabriolet



> SOUND WITH POWER



> Mercedes-Benz Magazine



## Out of sight, always in mind

Glued to the road, forever anchored in your mind: from the dynamically shaped headlamps via the ascending shoulderline to the bold rear, the new E-Class Cabriolet creates the perfect symbiosis between engineering and design. It blends sportiness with pure driving refinement, inspiring you to take this unique Cabriolet on many journeys. Winding mountain passes or miles of straight avenues – all promise to be equally unforgettable.





> View price list



View offers > Coupé > Cabriolet



> SOUND WITH POWER



> Mercedes-Benz Magazine



## The pleasure is entirely yours

Slipping away from everyday cares and worries is easy with the new E-Class Cabriolet – thanks to clever aerodynamic details that make a big difference. Innovations like the standard Aircap take speed into account to stop any draught ruffling your hair, while the optional Airscarf wraps itself around your neck to keep you relaxed and comfortable, even when you're driving with the hood down in cooler weather. → Pages 42–43





> View price list



View offers > Coupé > Cabriolet



> SOUND WITH POWER



> Mercedes-Benz Magazine





> View price list



View offers > Coupé > Cabriolet



> SOUND WITH POWER



> Mercedes-Benz Magazine

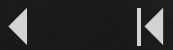



> View price list



View offers > Coupé > Cabriolet



> SOUND WITH POWER



> Mercedes-Benz Magazine

## The greatest pleasure lies in anticipation

Take a seat and you won't want this experience to end any time soon. That's because you're welcomed by beautifully crafted materials and eye-catching details. Just think of the great conversation you'll enjoy in this stylish cabin thanks to significantly reduced external noise.  
→ Pages 18, 42-43





> View price list



View offers > Coupé > Cabriolet



> SOUND WITH POWER



> Mercedes-Benz Magazine



## Now you see it, now you don't

The beautiful soft-top, available in Red, Dark Blue, Black or Dark Brown, can be folded away at the touch of a button. It disappears into the luggage compartment without taking up too much room. After all, we wouldn't want to cramp your style on any journey, come rain or shine. → Page 42

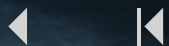





> View price list



View offers > Coupé > Cabriolet



> SOUND WITH POWER



> Mercedes-Benz Magazine



Everyone is sitting comfortably in the generous new E-Class Cabriolet. In particular, the two passengers in the rear are treated to individual seats combined with a centre armrest to ensure they stay just as comfortable as the front passengers, even on longer journeys. → Pages 40–41

## Sitting ovation





> View price list



View offers > Coupé > Cabriolet



> SOUND WITH POWER



> Mercedes-Benz Magazine

Insight 18

## Hear, hear! The quietest cabriolet of all time

Let us introduce you to our most sensitive colleagues: the acoustic dummies. Equipped with hearing capabilities similar to the human ear, they help our engineers develop the best sound quality. It's hardly surprising, then, that we know how the perfect interior should sound: dark blue to be precise. That's the colour our computer shows up as the quietest.

As a result the E-Class Cabriolet offers noise quality to really shout home about. No other soft-top offers a space that's this quiet. In fact, no amount of wind, bad weather or other external noise can spoil your comfort and relaxation. So you can listen to music or have a conversation undisturbed - even at high speed.





> View price list



View offers > Coupé > Cabriolet



> SOUND WITH POWER



> Mercedes-Benz Magazine

## The new E-Class in detail

### Engines and suspension

- 20 | Mercedes-Benz Intelligent Drive and Mercedes-Benz Connect
- 21 | BlueEFFICIENCY
- 22 | Diesel engines
- 24 | Petrol engines
- 26 | Rear and exhaust systems
- 27 | Transmissions
- 28 | Suspension

### Safety

- 30 | Integrated safety concept
- 34 | Cabriolet safety

### Comfort

- 36 | Multimedia systems
- 38 | Electronic assistants
- 40 | Seating comfort
- 42 | Open-air comfort

### Equipment

- 44 | Model lines
- 50 | Equipment packages
- 52 | Standard equipment
- 54 | Optional equipment
- 56 | Trim and upholstery
- 64 | Alloy wheels
- 66 | Retailer-fit accessories

### Services

- 68 | Services

### Facts and finishes

- 70 | Dimensions
- 71 | Technical data
- 73 | Paint finishes

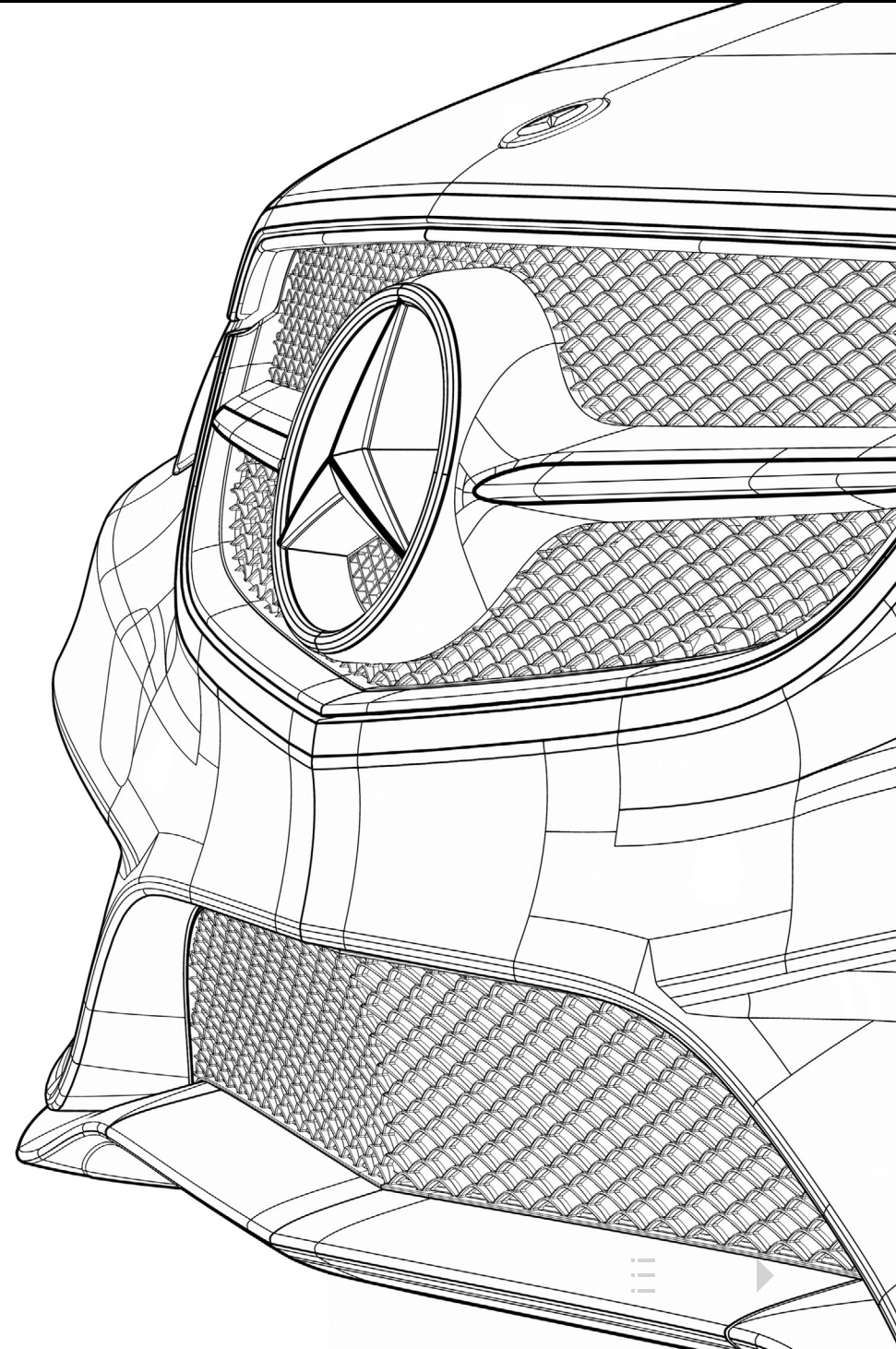



## Connected with all the senses

With Mercedes-Benz Intelligent Drive and Mercedes-Benz Connect, we have taught our cars to think. It takes us one step closer to our vision of accident-free driving.

Our engineers live in the future, constantly aiming to turn innovative thinking into everyday solutions. This aspiration has resulted in many developments with a lasting impact on automotive engineering. In other words, our work ensures that a Mercedes-Benz is always ahead of its time.

Innovative technologies such as the Pre-Safe® anticipatory safety system and Distronic Plus radar-assisted cruise control first made it onto the road in a Mercedes-Benz, setting new standards in vehicle safety. It marked the first time active and passive systems were combined – for even better protection and ride comfort. Time and time again we have pioneered solutions to get closer to realising our vision of accident-free driving.

**Mercedes-Benz Intelligent Drive** takes things a step further by intelligently combining sensors with safety systems and electronic assistants. For us, it's a logical progression as the traffic situation has changed.

There are more vehicles on the road, the driver's job is becoming more complex and distractions are increasing.

Radar-assisted Cruise Control with Steering Assist and Stop & Go Pilot marks another important step towards autonomous driving. Steering Assist provides lateral assistance to keep the car in lane. It works with a stereo camera capturing road markings and vehicles driving ahead at low speeds. The system brakes if necessary and accelerates to a preset speed when possible. As a result, your driving comfort is significantly enhanced, especially on long journeys or in slow-moving traffic jams.

**Mercedes-Benz Connect.** Serving as a smart interface between car and Internet, Mercedes-Benz Connect offers a whole range of services for your comfort, safety and information. It's an effortless, highly efficient way to keep the driver connected with the digital world when on the move. The system can be paired with COMAND Online, live traffic information, the Mercedes-Benz Emergency Call System and with many individual Mercedes-Benz apps. While your car remembers your preferences and adapts accordingly, it can even advise you to take specific actions and interact with your social networks. Mercedes-Benz Connect turns our vision of seamlessly connected mobility into reality. In the future, the way we drive will change dramatically, making it more comfortable, more efficient and safer as a result.

A Mercedes-Benz can monitor the road situation, alert you to possible dangers, and if necessary, act independently. Our cars are becoming increasingly intelligent, too. That is why a Mercedes-Benz takes you beyond a specific destination – it takes you straight to the future.





## BlueEFFICIENCY – fast forward to tomorrow

Mercedes-Benz is quicker at getting future technologies to where they matter most: on the road. With ever more efficient vehicles and a production process that wastes fewer and fewer resources. We call this comprehensive approach BlueEFFICIENCY. By way of example, BlueTEC technology for the diesel engine reduces nitrogen oxide

emissions by up to 90%. Our Hybrid models featuring an intelligent combination of internal combustion engine and electric drive can reduce fuel consumption significantly, while the SLS AMG Coupé Electric Drive takes electric mobility to a new level. Technical and aerodynamic optimisation measures right down to the last detail make

the BlueEFFICIENCY Editions available in selected model series true champions of efficiency. But every E-Class model already boasts a raft of BlueEFFICIENCY features – holistic vehicle optimisation measures that are adapted specifically for this model series.



- 1 Optimised aerodynamics, best in class: E-Class Coupé with excellent drag coefficient of 0.25 (4-cylinder)
- 2 4-cylinder diesel engine with twin turbochargers
- 3 New 4-cylinder petrol engine with lower consumption values (E 200)
- 4 Energy-saving ancillary systems
- 5 Optimised V6 petrol engine, electronically controlled direct injection with twin turbochargers (E 400)
- 6 Efficient generator
- 7 ECO start/stop function – stops the engine when car is stationary
- 8 ECO indicator as standard
- 9 Fuel consumption history shown as a bar chart
- 10 Direct Steering only requires energy when actually steering
- 11 Reduced rolling resistance in tyres and wheels

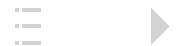



## Diesel engines

Maximum pulling power and extremely smooth running combined with lower fuel consumption and emissions: the new E-Class diesel engines make the previously impossible possible.

**4-cylinder engines.** The E-Class comes with a choice of two 4-cylinder diesel engines (E 220 CDI and E 250 CDI). Both display impressively rich torque and low fuel consumption. This is made possible by a comprehensive package of consumption-reducing technologies. The current generation common-rail diesel technology impresses by virtue of an injection pressure increased to

up to 2,000 bar, optimised combustion chambers, and extremely fast and precisely controlled piezo injectors. High torque is available in every engine speed range thanks to the high combustion pressure and dual level charging, while two Lanchester balancer shafts offer further refinement. Additionally, the radiator shutter reduces the air resistance if the engines require only moderate cooling.

exemplary emission figures which meet the latest European emissions standards (EU6). In addition, the ECO start/stop function helps save fuel when at a standstill. Furthermore, the ECO display in the instrument cluster provides information about your driving style.

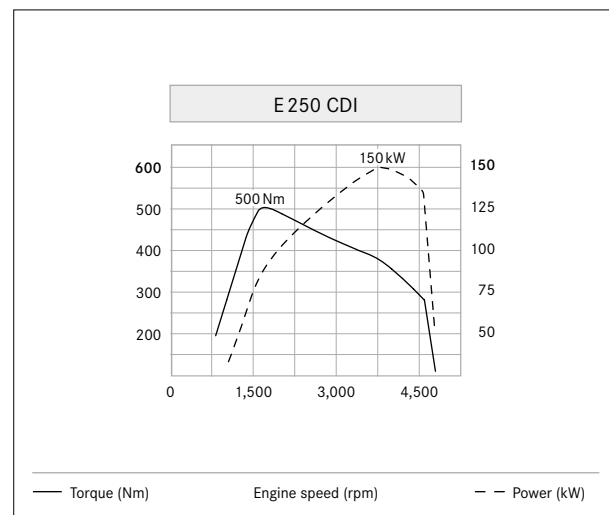

The E 250 CDI reaches its peak 500 Nm torque at 1,600 rpm

Two 4-cylinder diesel engines are available:

- E 220 CDI with 170 hp (125 kW) and maximum torque of 400 Nm
- E 250 CDI with 204 hp (150 kW) and maximum torque of 500 Nm

**V6 engine.** The 252 hp (185 kW) E 350 BlueTEC boasts a V6 diesel engine with particularly low-emission BlueTEC technology. Fast and precisely switching piezo injectors, a high injection pressure plus a maximum torque of 620 Nm for the E 350 BlueTEC mean effortlessly superior pulling power in every driving situation. BlueTEC is currently the world's cleanest diesel drive system thanks to the cleansing and treatment of exhaust gases, resulting in





> View price list



View offers > Coupé > Cabriolet



> SOUND WITH POWER



> Mercedes-Benz Magazine





## Petrol engines

Advanced efficiency – more agility and motoring pleasure, reduced fuel consumption: a wide selection of both new and proven engines with innovative technologies reduces the burden on the environment even further. The ECO start/stop function – standard on all petrol models – makes this tangible each time you come to a halt.

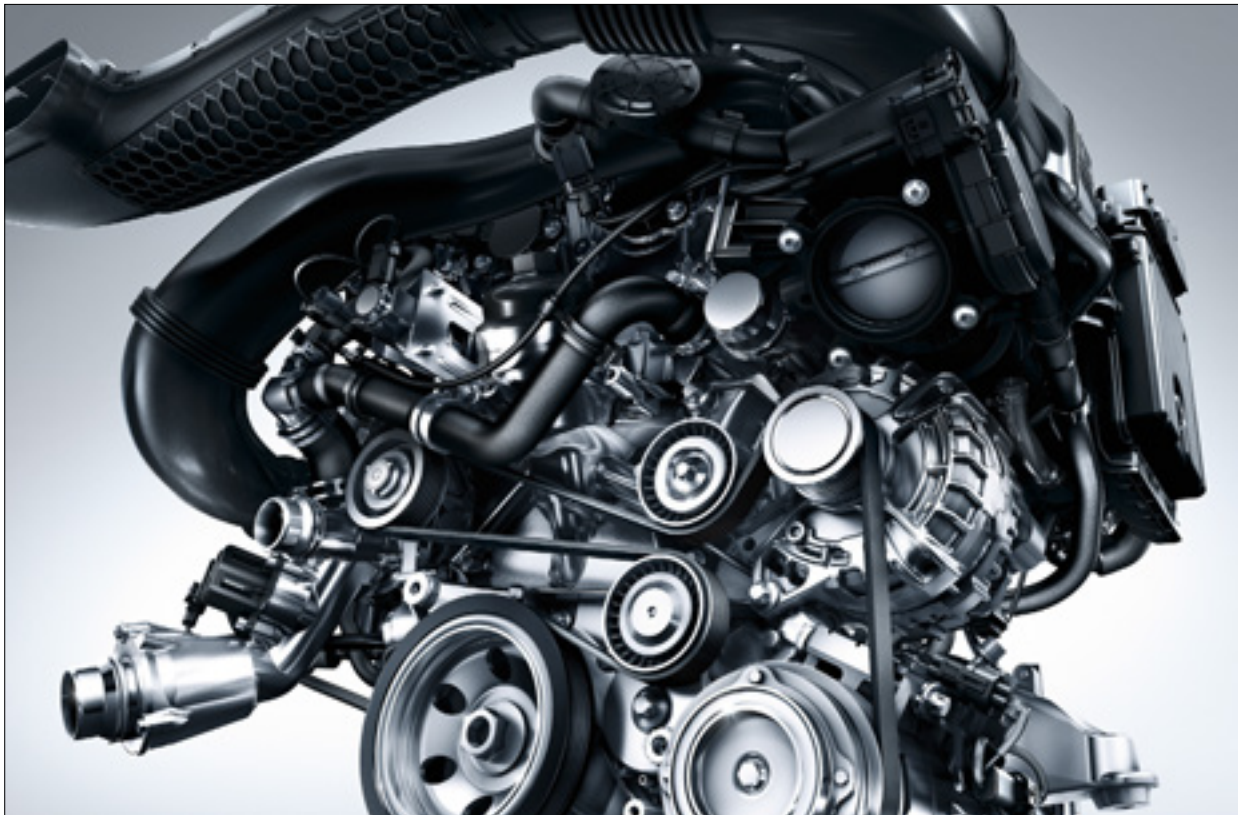

**4-cylinder engine.** The new 184 hp (135 kW) E 200 4-cylinder petrol engine with direct injection, variable valve timing and turbocharging boasts better output and torque figures with 300 Nm maximum torque than its predecessor as well as low consumption and emission figures. The multiple direct petrol injection with fast switching piezo injectors optimises the air/fuel mixture, thus facilitating almost complete combustion of the fuel. The reduced engine weight plus lower internal friction also contribute to the reduction in fuel consumption and emissions, as does the standard ECO start/stop function.

A sound performance: turbocharger and intercooling ensure maximum agility on the E 200







**V6 engine.** The E 400 V6 twin turbo engine delivers an impressive 333 hp (245 kW) and 480 Nm torque. Thanks to its exhaust-driven turbocharger, the E 400 offers a more powerful performance and increased torque despite lower engine capacity. It also boasts comparatively favourable consumption figures for its category as well as low emission levels.

The third generation Mercedes-Benz direct petrol injection uses spray-guided combustion and high pressure injection with piezo injectors.

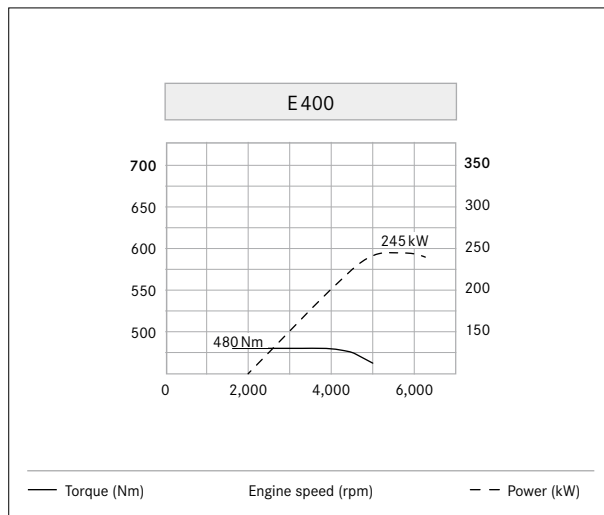

The E 400's maximum 480 Nm torque is available from just 1,400 rpm





## Rear and exhaust systems

Both E-Class Coupé and Cabriolet are a joy to follow: they feature a unique rear design and exhaust system to suit individual model lines.

Sportiness from beginning to end: the E-Class Coupé and Cabriolet fulfil this promise with their bold, wide rear design, accentuated by narrow rear tail lights and a wide bumper with chrome trim. While the LED rear tail lights add to the athletic appeal at night, the narrow boot lid fits in seamlessly with the powerful appearance.

On the SE, the exhaust system is integrated into the new rear spoiler. On the AMG Sport and the E 400 AMG Sport Plus it makes a more prominent impact featuring twin trapezoidal tailpipes.



The powerful rear of the SE model, with narrow LED rear tail lights and chrome strips on the rear bumper



The AMG Sport and E 400 AMG Sport Plus show off their exposed twin-pipe exhaust system with trapezoidal tailpipes





## Transmissions

The further enhanced 7G-Tronic Plus automatic transmission is precisely tuned to every engine. What's more, it also impresses with intuitive and ergonomic operability. On the E 220 CDI, the standard 6-speed manual transmission ensures a thoroughly sporty performance.

**7G-Tronic Plus automatic transmission with Direct Select and Speedtronic cruise control.** All engines (except E 220 CDI) feature 7G-Tronic Plus 7-speed automatic transmission as standard. The transmission can be operated via the Direct Select steering column gear shift lever or via the steering wheel gear shift paddles. The optimised seven forward gears provide very dynamic or highly efficient drive modes ('S', 'E' or 'M'), as well as smooth gear changes and a more direct vehicle response. An optimum engine speed at all times helps to reduce fuel consumption, while multiple downshifts allow the transmission to jump gears.

**6-speed manual transmission.** The E 220 CDI is fitted with a 6-speed manual transmission as standard, offering impressively short throws and hence sporty, rapid gear changes. A display on the instrument cluster indicates recommended gear changes to encourage efficient driving.

**ECO start/stop** (standard). The engine is automatically switched off whenever the vehicle is at a standstill. This achieves a considerable reduction in fuel consumption and emissions, for instance in a traffic jam or at traffic lights.

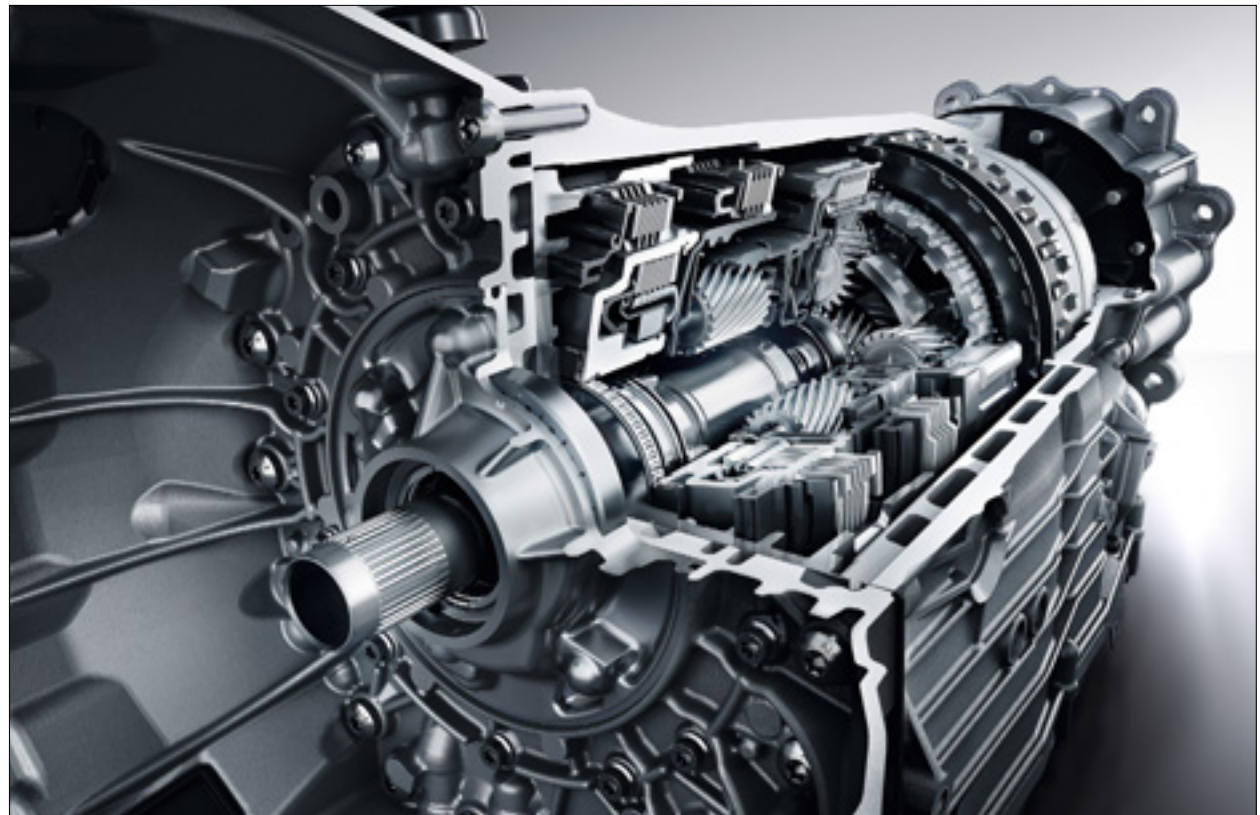

7G-Tronic Plus: more than 18 million automatic transmissions have found their way into a Mercedes-Benz in over 50 years





## Suspension

Both E-Class Coupé and Cabriolet suspension systems are designed to suit both a comfortable and a responsive, sporty drive. For further enhanced agility and driving pleasure, a range of optional suspension and transmission packages are also available.



**Adaptive Brake System** (standard). This modular braking system combines the anti-lock braking system (ABS) and the Electronic Stability Programme (ESP®) with additional braking functions that enhance convenience and safety. By drying the brakes in the wet and priming them automatically, i.e. placing the brake pads against the discs as soon as you take your foot off the accelerator, Adaptive Brake Assist gives you even more rapid braking responses and shorter stopping distances, while the Hill Start Assist function prevents you from rolling backwards when switching from brake to accelerator on inclines. With the hold function, you can also keep the brakes engaged by twice pressing and releasing the brake pedal.

**Agility Control suspension** (standard on SE models). The Agility Control suspension with Adaptive Damping System combines agility and comfort. By constantly monitoring the road surface, the dampers automatically adjust to the road conditions. On poor roads the damping and stabilising properties prove particularly effective, while small jolts are equally met with high driving comfort thanks to enhanced roll characteristics.

The Agility Control suspension with Adaptive Damping System adjusts to the road conditions offering both agility and comfort on all surfaces





**Agility Control sports suspension** (standard on AMG Sport). A sportier drive is guaranteed by the Agility Control sports suspension. With its adaptive damping properties, it handles tighter when cornering and is more responsive overall.

**Dynamic Handling Package** (standard on E 400 AMG Sport Plus, optional on AMG Sport). The Dynamic Handling Package allows you to switch the Adaptive Damping System from 'Comfort' to 'Sport' mode simply by pressing the suspension switch on the centre console.

In automatic mode, you can also choose a more sporty drive by selecting the 'E', 'S' or 'M' mode switch. In 'S' mode, the tighter suspension settings show a more direct throttle response.



'Comfort' or 'Sport' mode: the Dynamic Handling Package allows you to switch between the two



## Integrated safety concept

The vision of accident-free driving spurs us on. Our integrated safety system makes way for a comprehensive approach to maximise safety in every road situation.

As the inventor of the motor car, we feel a particular responsibility towards road safety. That's why we were the first manufacturer to develop an integrated safety concept that seamlessly combines a car's active and passive safety features, thus ensuring optimum all-round protection. This concept covers four different areas – safer driving, anticipating danger, protecting occupants and pedestrians and post-crash safety – and incorporates measures designed to maximise safety in every situation, by helping you to stay safe, alerting you to danger, and assisting you wherever possible. In addition, our unique Pre-Safe® anticipatory safety system recognises likely accident scenarios and takes steps that further enhance occupant protection. If a collision can't be avoided, intelligent passive safety systems help to provide protection where it's needed, while solutions that minimise the consequences of an accident and facilitate emergency assistance are also a key part of this safety concept. A selection of these technologies are presented on the following pages.

**Mercedes-Benz Intelligent Drive.** A range of intelligent technologies helps detect critical situations and lower the risk of injuries. They also provide the driver with vital support to help deal with difficult road situations.

**Safer driving: Attention Assist** (standard). Particularly beneficial on long journeys, Attention Assist is a system for detecting fatigue. Between speeds of approx. 50 and 110 mph, it assesses the driver's behaviour via an array of sensors, compares it to the behaviour patterns already stored for that driver and thus registers unexpected changes that may indicate an increase in tiredness or inattentiveness. The system sends timely alerts to warn the driver about serious lapses in concentration or drowsiness. A dedicated menu in the instrument cluster provides the driver with additional information. The system can also be set to take into account the current road situation via a choice of two sensitivity modes.

**Safer driving: Lane-Tracking Package** (optional). Lane-Keeping Assist recognises white road markings and warns you via subtle vibrations of the steering wheel should you unintentionally stray out of lane. Blind Spot Assist monitors the blind spot alongside the vehicle from a speed of 12 mph and can give audible and visual warnings if dangers are detected in this area.

**Safer driving: LED Intelligent Light System** (standard on E 400 AMG Sport Plus, optional on all other models). The LED Intelligent Light System comprises a variety of modes and functions: high-performance headlamps, Active Light System with country mode, motorway mode, fog mode and cornering light function. It also features Adaptive High Beam Assist, which automatically maximises the headlamps' range then lowers them again as soon as the lights of an oncoming vehicle are detected.

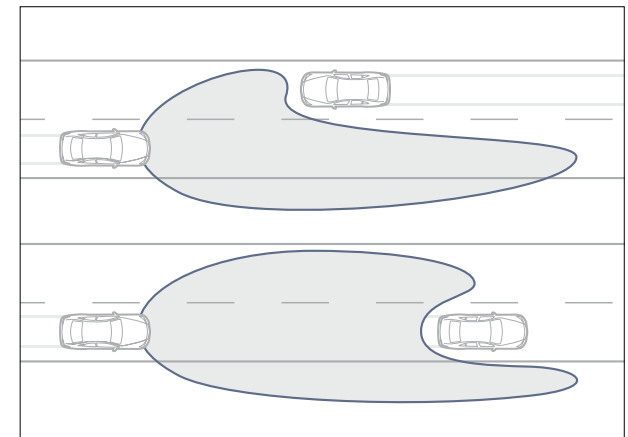

The LED Intelligent Light System automatically maximises the headlamps' range and dips them as soon as oncoming vehicles are detected





**Driving Assistance Package** (optional). DISTRONIC PLUS with Steering Assist helps the driver maintain the desired distance to the vehicle in front at speeds of 0 to 120 mph. Steering Assist makes the driver's job easier by helping with lane guidance and allows semi-autonomous driving in queuing traffic. Further components include Pre-Safe® Brake with Active Pedestrian Protection, Active Lane-Keeping Assist, Active Blind Spot Assist and Brake Assist (BAS) with Junction Assist, rear-end collision warning and Pre-Safe® Plus protection system.

**Anticipating danger: Collision Prevention Assist** (standard). If the system detects insufficient distance between the car and the vehicle in front or a stationary obstruction when driving at speeds over 19 mph, it alerts the driver with audible and visual warnings. During braking, Active Brake Assist provides the braking force required to help avoid an imminent collision or at least reduce its severity.

**Anticipating danger: Pre-Safe® anticipatory safety system** (standard). If it detects a probable accident scenario, Pre-Safe® can take a range of anticipatory measures to prepare the occupants for an imminent impact. If need be, it can then instantly activate the front seat belt tensioners, close the windows and optional panoramic glass sunroof.



Lane-Keeping Assist and Blind Spot Assist can alert the driver in potentially dangerous situations; for example, when changing lanes

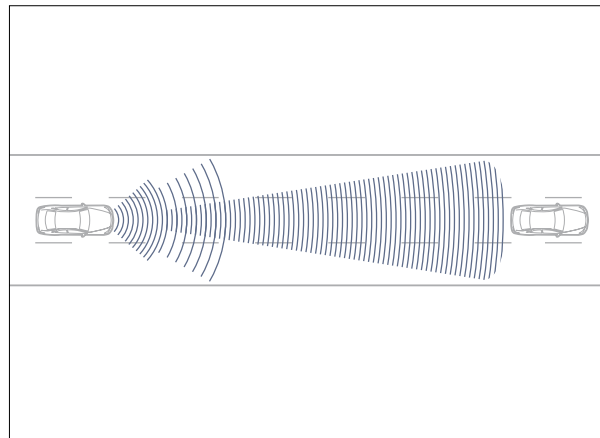

DISTRONIC PLUS adaptive cruise control with Steering Assist brings the car to a standstill when necessary and then starts it moving again

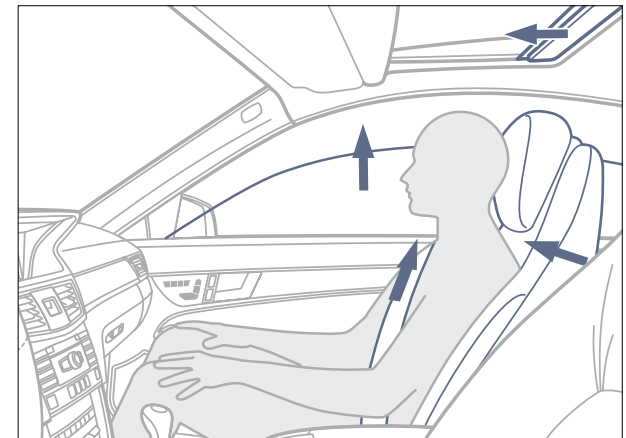

The Pre-Safe® anticipatory safety system recognises dangerous driving situations and initiates measures to protect the occupants





**Anticipating danger: Pre-Safe® Plus** (part of the optional Driving Assistance Package). The further enhanced Pre-Safe® Plus uses a radar sensor in the rear bumper to detect potential hazards to the rear of the car and initiates additional safety measures. If an impact is imminent, the rear indicators flash more rapidly to warn the traffic behind. Furthermore, preventive measures such as an emergency brake can reduce the risk of secondary collisions and lessen the forces of a forwards jolt.

**Anticipating danger: Pre-Safe® Brake with pedestrian detection** (part of the optional Driving Assistance Package). The three-stage warning and braking system Pre-Safe® Brake is able to intervene before an impending rear-end collision. If the driver fails to respond to a first warning, the system increases the brake force automatically. It can then trigger an autonomous emergency brake if there is still no reaction from the driver. Radar sensors and a stereo camera register vehicles ahead as well as stationary obstacles and pedestrians. Autonomous braking can help prevent collisions with stationary vehicles and pedestrians at speeds of up to 30mph.

**Anticipating danger: Brake Assist (BAS) with Junction Assist** (part of the optional Driving Assistance Package). Brake Assist calculates the required brake force to prevent a collision or reduce the severity of the impact. It then initiates partial or an emergency brake if the driver does not apply the brakes hard enough. BAS also provides assistance in situations involving crossing objects. It can also detect pedestrians in the area ahead of the vehicle and increase the brake force applied by the driver if necessary.

**Post-crash safety: Mercedes-Benz Emergency Call System** (part of COMAND Online). Should the restraint systems' sensors detect an accident, the emergency call system can use a paired mobile phone to automatically contact the emergency services. In addition, it simultaneously sends GPS data and other vehicle information to the Mercedes-Benz emergency call centre, where an operator will attempt to make contact with you by phone. The emergency call system can also be activated manually.

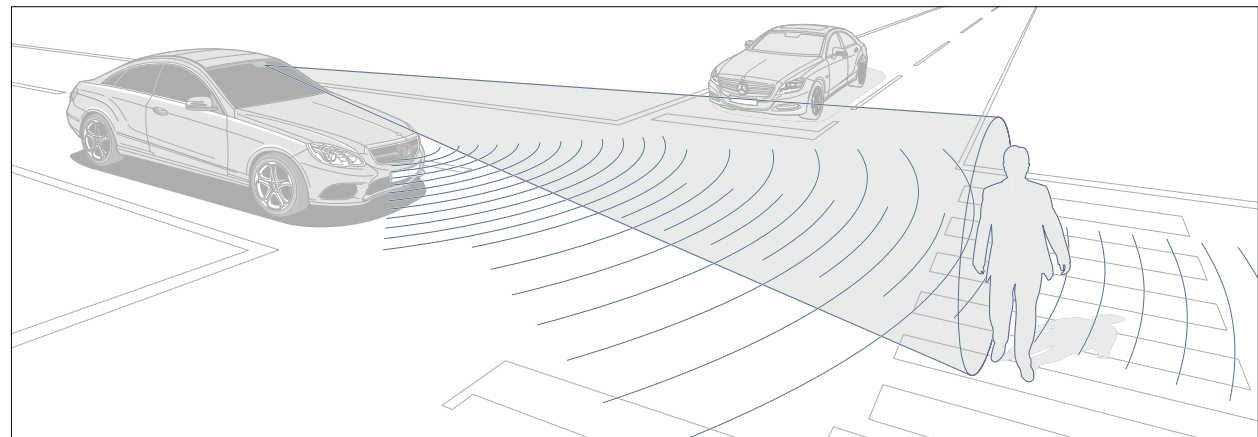

BAS with Junction Assist can detect vehicles in the area ahead and assist the driver with braking to help prevent a collision. If a pedestrian is detected, the system automatically applies the necessary brake force





**Post-crash safety: rescue assistance.** Mercedes-Benz has developed a range of measures that help to minimise the secondary consequences of an accident and facilitate occupant rescue. These include automatic engine cut-off, self-activating hazard lights and emergency cabin lighting. In addition, the central locking system is automatically released in the event of an accident, and there are special crash joints between the front doors and wings that make it easier to open the doors after frontal collisions. In addition, Mercedes-Benz provides a rescue guide for emergency services that can be downloaded from the Internet at [www.mercedes-benz.co.uk/rescueguide](http://www.mercedes-benz.co.uk/rescueguide)

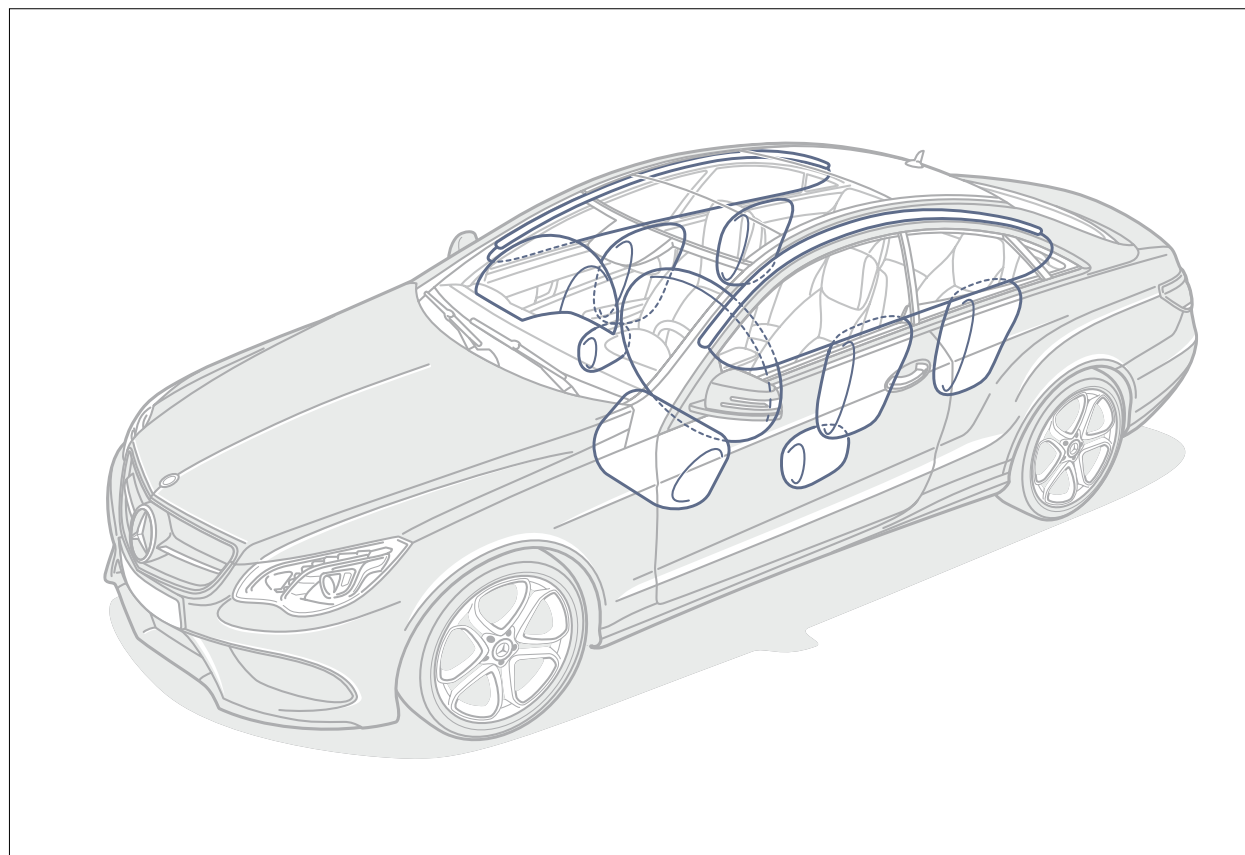

Airbag, sidebag and pelvisbag for the front seats, as well as two large windowbags (headbags in Cabriolet) are standard on both E-Class Coupé and Cabriolet. The kneebag further reduces the forces exerted on the driver during an accident. Rear sidebags are available as an option



## Cabriolet safety

Nothing can compare to the thrill of open-top driving. This sense of freedom is further enhanced by a comprehensive safety concept that provides the utmost protection from dangerous situations.

The E-Class Cabriolet benefits from its own individual safety concept. It features headbags as standard instead of windowbags. Together with all the other airbags and Neck-Pro front head restraints, which reduce the risk of whiplash, all occupants enjoy maximum protection. To help avert dangerous situations in the first place, the Cabriolet also comes with the Mercedes-Benz integrated safety concept, which offers preventive protection; for example, with Pre-Safe® Plus.

**Protecting occupants: high-strength bodyshell** (standard). The E-Class Cabriolet bodyshell is designed from the outset to provide optimum safety for its occupants. Made largely of particularly high tensile steels, it features additional strengthening, particularly in the

floor and sides. The resulting torsional rigidity, combined with the intelligent use of lightweight materials, also helps to ensure exceptionally agile handling.

**Protecting occupants: roll-over protection** (standard on Cabriolet). On the Cabriolet, roll-over protection plays a key role in its tailor-made safety concept. As a result, the windscreen and A-pillars have been strengthened. The latter feature reinforcing tubes that, together with the roll-over bars, ensure effective protection should the car overturn in an accident. The roll-over bars themselves are fully integrated into the rear seat head restraints and anchored to the bodywork behind the rear seat. They can be activated within a split second of the airbag system's crash sensors detecting a likely accident.

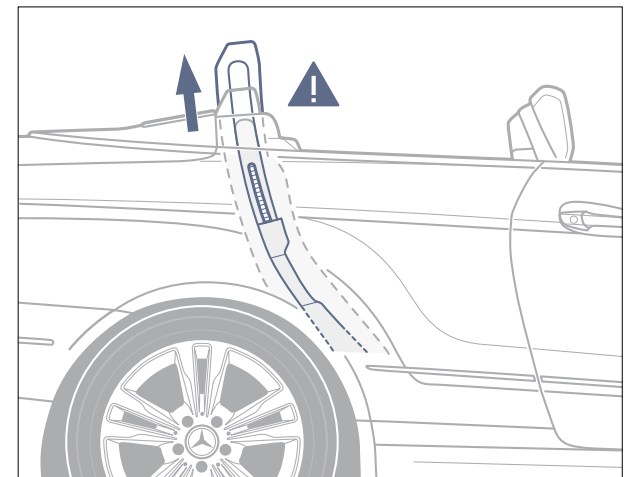

The roll-over bars can be activated in less than three seconds, while the rear seat head restraints are moved into the optimum position





> View price list



View offers > Coupé > Cabriolet



> SOUND WITH POWER



> Mercedes-Benz Magazine





## Multimedia systems

The multimedia functions in the E-Class Coupé and Cabriolet can be operated intuitively via an easy-to-use controller on the centre console, via buttons on the device itself or via the multi-function steering wheel.



COMAND Online combines audio system, navigation system and telephone functions. All of the main settings can be programmed using Linguatronic voice control

**COMAND Online** (standard). The system combines hard disk drive (HDD) navigation with a high-resolution 7-inch colour display for 3D map viewing. Multimedia functions include radio, DAB digital radio tuner, speed-sensitive volume control, music register with 10 GB of storage for audio files, free European map data updates<sup>1</sup> and live traffic information,<sup>1</sup> which provides precise, up-to-date traffic data for improved route planning and more accurately estimated time of arrival. A USB connection, SD memory card slot, Bluetooth® interface for hands-free access and the Media Interface allow connection to external data storage media. The DVD drive can play video and audio DVDs as well as CDs and MP3 files. The online feature allows access to the Internet and Mercedes-Benz apps via an Internet-enabled mobile phone, including Facebook, Internet radio, parking space search, special destination searches via Google Street View or sending routes from Google™ maps to the vehicle, and hotel finder as well as news and weather reports. You can operate the system via the COMAND controller and the multi-function steering wheel, or simply use Linguatronic voice control. For comprehensive information on operating the vehicle and the COMAND Online system, the Digital Owner's Manual can be called up quickly and easily.

<sup>1</sup>Free of charge for the first three years

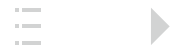



**SplitView** (optional). SplitView can show different content simultaneously on the same COMAND Online display depending on the viewing angle: for example, if the driver wants to check on the navigation system, whilst the front passenger is watching a film. A unique pixel layout provides the key to this effect. The front passenger has convenient access to movies on DVD, radio, Internet or television by remote control. The audio signal is provided via headphones to ensure the driver remains undisturbed.

**Harman Kardon® Logic 7® surround sound system** (standard on E 400 AMG Sport Plus). This high-performance 450-watt 14-speaker system delivers a truly first-class audio experience with Dolby Digital 5.1 surround sound via COMAND Online. Its digital surround sound with Logic 7® multichannel technology and automatic volume adjustment can be optimised to suit the entire interior.



COMAND Online with optional SplitView



The ultimate listening experience: Harman Kardon® Logic 7® surround sound system





## Electronic assistants

In real life, assistants are tasked with making our life easier. The E-Class does just that: features such as the 360° camera, Speed Limit Assist and Parktronic with Active Park Assist enhance the feeling of comfort and safety.



### **Parktronic with Active Park Assist** (standard).

When driving slowly, 12 ultrasonic sensors monitor the surroundings and detect suitable parking spaces, indicated in the instrument cluster. A control unit processes the signals and calculates the best angle to steer the car into the space. For the first time, the E-Class can also automatically manoeuvre into bay parking spaces to enter or exit parallel parking spaces thanks to active steering and braking intervention. It also features a protection function against potential side obstructions.

The display in the instrument cluster will always provide an overview of the current parking manoeuvre





**Speed Limit and Traffic Sign Assist** (optional). Speed Limit Assist reads speed limit and no overtaking road signs and displays the permitted maximum speed in the instrument panel until the limit changes. The front-mounted camera detects round speed limit warnings both on roadside signs and in overhead gantries and is particularly useful where the speed limit varies or when passing through roadworks. To help identify the limit correctly, it compares speed limit signs with map data from the navigation system.



Traffic Sign Assist shows the driver what speed limits and traffic signs apply

**Reversing camera** (optional). This wide-angle camera with dynamic guidelines in the display makes for safer and easier parking manoeuvres, capturing the area immediately behind the car and displaying the image on the central COMAND display. The camera is activated automatically as soon as the driver engages reverse.

**360° camera** (optional; not in conjunction with reversing camera). This feature works with a close-range camera system comprising four cameras and a control unit which

can display a homogenous all-round view. One camera is mounted at the front, plus one in each exterior mirror and one in the centre at the rear of the car. Based on this information, the system calculates various views around the vehicle as well as a true-colour image of the vehicle and its surroundings from a bird's-eye perspective. The camera is activated when reverse gear is engaged or by selecting it in the COMAND system. The images appear on the multimedia system display with dynamic guide lines to help manoeuvre.



The optional reversing camera supports static and dynamic guides in reversing operations



The central display of the COMAND Online system shows the area around the vehicle during parking





## Seating comfort

The seats in the E-Class are designed to offer ultimate comfort, safety and sportiness. Automatic seat belt presenters on the front seats as well as Easy-Entry system for the rear seats add extra convenience.

The front seats with standard Neck-Pro head restraints are ergonomically shaped and provide firm support. Their height and backrest angle can be electrically adjusted.

**Memory Package** (optional). Both driver and passenger seat are fully electric and can be adjusted to any position. They also feature four-way lumbar support. The settings for seat, steering wheel and exterior mirror settings can be stored and retrieved at the touch of a button. An easy-exit steering wheel is also part of the package.



The contours of the optional multi-contour seats can be individually and ergonomically adjusted to the driver and front passenger







**Automatic seat belt presenter** (standard). As soon as you turn the key, the seat belt presenter system automatically brings your seat belt to within easy reach. It can also be activated manually via a button on the upper centre console.

**Easy-Entry system** (standard). The front seats of the E-Class Coupé and Cabriolet slide forward to provide easier rear seat access. As soon as you fold it back, the front seat simply slides back into its original position.

**Sculpted rear seats** (standard). Rear passengers benefit from sculpted rear seats with integral head restraints, plus a centre storage compartment and twin cup holders. On the Coupé, the backrest can be folded forward to increase the load capacity. On the Cabriolet, the centre armrest with a through-loading feature underneath offers added convenience.



For your convenience, the automatic seat belt presenter system brings the front seat belts within easy reach

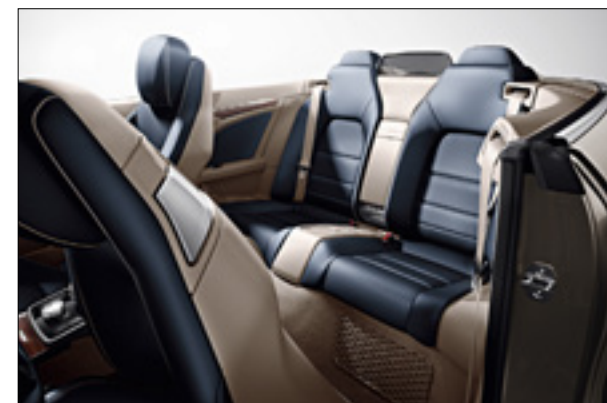

With the Easy-Entry system, the front seats simply slide forward for better access to the rear



The handy load-through feature helps with transporting long items in the Cabriolet



## Open-air comfort

In the E-Class Cabriolet you can enjoy open-top driving in almost any weather – thanks to innovative technology like the unique Aircap system which keeps breeze and noise to a minimum.

**Fully electric soft-top.** Available in a choice of four colours – Black, Dark Blue, Red or Dark Brown – the E-Class Cabriolet’s soft-top is thoroughly weatherproof. It is operated by lifting and holding the soft-top release lever situated within the central handrest and can be opened or closed when travelling at speeds of up to approximately 25 mph. The fabric construction and electro-hydraulic folding mechanism enables the soft-top to fold neatly away, leaving ample boot space even with the roof down.

**Aerodynamics.** The E-Class Cabriolet also scores when it comes to aerodynamics (e.g. the E 200 has a drag coefficient of 0.29 with the roof closed). In particular, the design of the front and rear axle ensures excellent thermal lift. All aerodynamic measures help minimise the amount of wind noise and reduce fuel consumption while contributing to the vehicle’s stability.



The soft-top can be opened or closed conveniently using a lever at speeds of up to 25 mph





**Airscarf** (optional). Our Airscarf neck-level heating system gives you a longer open-top driving season. At the touch of a button, it sends warm air to the head and neck area via discreetly integrated vents in the front seat head restraints, allowing you to keep the top down even when the temperature drops.

**Aircap** (standard). The E-Class Cabriolet's Aircap system is an evolution of the conventional wind deflector. It comprises a deflector on the top edge of the windscreen surround and a small draught-stop between the rear seat head restraints. Together, they force the air flow upwards, keeping it away from the occupants' heads. This not only increases comfort for those in the rear by minimising turbulence and draughts, it also makes for easier communication between front and rear seat passengers as well as enhancing the effectiveness of the automatic climate control system. Aircap now also adapts to the travelling speed: from 25 mph the deflector rises automatically and is lowered at speeds below approx. 10 mph. It can also be switched on and off via a button in the centre console and activated or deactivated at high speeds of up to 100 mph.



The Airscarf heating system wraps around the front passengers' necks like a scarf



The Aircap deflector protects against draught



Simply smart: Aircap forces the airflow upwards, above the four passengers' heads





## E-Class SE

The E-Class SE exudes exclusivity inside and out – starting with the striking front fascia with partial LED headlamps and LED rear tail lights. The SE's radiator grille is a sleek single-louvre design. A graceful sprinter, both Coupé and Cabriolet feature Agility Control suspension with Adaptive Damping System and 17" 5-twin-spoke alloy wheels to match. An electrically powered acoustic soft-top is standard on the Cabriolet. On the inside, sumptuous materials prevail. Leather upholstery features throughout, with a variety of colours to choose from. The 3-spoke multi-function steering wheel and the gear shift are fitted with nappa leather. The dark aluminium trim adds a modernist touch.

### Exterior

- 17" alloy wheels – 5-twin-spoke design
- Agility Control suspension with Adaptive Damping System
- Aircap wind deflector and draught-stop (Cabriolet only)
- Direct Steering – speed-sensitive power steering
- Electrically powered acoustic soft-top (Cabriolet only)
- Parktronic with Active Park Assist – front and rear

### Interior

- Automatic climate control with digital display
- Bluetooth® interface for hands-free telephony
- COMAND Online system with Media Interface – 7-inch display with central controller dial
- DAB digital radio tuner
- Leather upholstery and heated front seats
- Nappa leather-trimmed 3-spoke multi-function steering wheel and gear shift





> View price list



View offers > Coupé > Cabriolet



> SOUND WITH POWER



> Mercedes-Benz Magazine





## E-Class AMG Sport

The AMG Sport is equipped with exclusive styling and performance features to enhance its sporty credentials. Front, rear and sides carry the AMG bodystyling with 18" AMG 5-twin-spoke wheels. The trapezoidal tailpipes, as part of the twin-pipe exhaust system, complete the sports car style. A sportier drive is guaranteed by the Agility Control sports suspension. In the interior, sports styling touches prevail: there are multi-contour sports seats in leather, an AMG sports steering wheel with flattened bottom section, AMG floor mats and rubber-studded stainless steel sports pedals.



### Exterior

18" AMG alloy wheels – 5-twin-spoke design

Agility Control sports suspension with Adaptive Damping System

AMG bodystyling – front and rear apron, side skirts

Direct Steering – speed-sensitive power steering

Front brakes – perforated, with 'Mercedes-Benz'-branded calipers

Twin-pipe exhaust system with trapezoidal tailpipes

### Interior

AMG 3-spoke sports steering wheel in nappa leather with flattened bottom section

AMG floor mats

Brushed stainless steel sports pedals with rubber studs

Multi-contour sports seats with leather upholstery

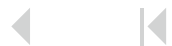



> View price list



View offers > Coupé > Cabriolet



> SOUND WITH POWER



> Mercedes-Benz Magazine





## E-Class E 400 AMG Sport Plus

The E 400 AMG Sport Plus combines thrilling performance with a dynamic exterior. Driving characteristics can be adjusted to comfortable or sporty handling, sharper accelerator response and quicker gear shifts thanks to the Dynamic Handling Package. The dynamic exterior features 19" AMG bi-colour alloy wheels, AMG boot lid spoiler and LED Intelligent Light System. Inside, leather-upholstered AMG sports seats, a 3-spoke sports steering wheel with red stitching and silver gear shift paddles, plus a nappa leather-upholstered dashboard create pure motor racing appeal. The Harman Kardon® Logic 7® surround sound system, also standard, adds your favourite soundtrack.



### Exterior

19" AMG bi-colour alloy wheels – 7-twin-spoke design

AMG bodystyling – front and rear apron, side skirts

AMG boot lid spoiler in body colour

Dynamic Handling Package

Front brakes – perforated, with 'Mercedes-Benz'-branded calipers

Headlamps – LED Intelligent Light System

Keyless-Go

### Interior

AMG floor mats with red edging

AMG leather sports seats with red stitching, heated front seats and red seat belts<sup>1</sup>

COMAND Online system with Media Interface and DAB digital radio tuner

Red stitching on door panels, centre console and armrest

<sup>1</sup>Selectable in Black (code U17)







> View price list



View offers > Coupé > Cabriolet



> SOUND WITH POWER



> Mercedes-Benz Magazine





## AMG Sport Plus Package

Devised especially for the AMG Sport model line, the AMG Sport Plus Package adds many styling extras. The exterior features larger 19" AMG bi-colour alloy wheels and the AMG boot lid spoiler. Inside, you'll find finely detailed red stitching on door panels, the steering wheel, on centre console and armrest. Also included are Artico leather<sup>1</sup>/Dinamica microfibre-upholstered AMG sports seats, offering unrivalled support. AMG floor mats with red edging offer the finishing touches to this stylish package.



---

**AMG Sport Plus Package comprises:**

---

19" AMG bi-colour alloy wheels – 7-twin-spoke design

---

AMG 3-spoke sports steering wheel in nappa leather with red stitching

---

AMG boot lid spoiler in body colour

---

AMG floor mats with red edging

---

AMG sports seats

---

Artico leather<sup>1</sup> side bolsters and centre section in Dinamica microfibre with red stitching

---

Black roof lining

---

Red seat belts<sup>2</sup>

---

Red stitching on door panels, centre console and armrest

---

Silver steering wheel gear shift paddles (7G-Tronic Plus automatic transmission only)

---

<sup>1</sup>Man-made leather <sup>2</sup>Selectable in Black (code U17)





> View price list



View offers > Coupé > Cabriolet



> SOUND WITH POWER



> Mercedes-Benz Magazine





> View price list



View offers > Coupé > Cabriolet



> SOUND WITH POWER



> Mercedes-Benz Magazine

## Standard equipment | Selection



Partial LED headlamps – indicators and high beam are halogen



Multi-function steering wheel in nappa leather (SE model)



COMAND Online system with Media Interface and DAB radio



LED rear tail lights



Analogue clock



Electrically powered acoustic soft-top (Cabriolet only; manual transmission shown)





> View price list



View offers > Coupé > Cabriolet



> SOUND WITH POWER



> Mercedes-Benz Magazine



Automatic climate control with digital display



Collision Prevention Assist displayed in the three-tube instrument cluster



Fully retractable side windows



Roll bars integrated into the head restraints of the rear seats (Cabriolet only)



Leather upholstery (image shows Natural Beige)



Automatic seat belt presenter for driver and front passenger (optional nappa leather seats shown)





> View price list



View offers > Coupé > Cabriolet



> SOUND WITH POWER



> Mercedes-Benz Magazine

## Optional equipment | Selection



LED Intelligent Light System



Wood- and leather-finished multi-function steering wheel (SE model shown)



360° camera



Panoramic electric glass sunroof (Coupé only)



Aircarft neck-level heating system (Cabriolet only)



Dynamic Handling Package





> View price list



View offers > Coupé > Cabriolet



> SOUND WITH POWER



> Mercedes-Benz Magazine



Luxury automatic climate control with digital display and three-zone control



Upper dashboard finished in nappa leather



Direct Select lever and gear shift paddles



Harman Kardon® Logic 7® surround sound system



Keyless-Go



Memory Package





SE interior shown



211



H79



231



736



811



H21



H17

The Black interior features Black leather seats as standard. (Nappa leather is available as an option.) The door trim, dashboard and steering wheel are also Black, while the roof lining can be chosen in Grey or Black. For a striking contrast, the black interior is fitted with a dark aluminium trim. Alternatively, you can choose a Black Ash wood, Black Piano Lacquer or high gloss Dark Brown Lime wood trim. On the E 400 AMG Sport Plus, the AMG sports seats are upholstered in black leather with red stitching. Interior details include red stitching on door panels, steering wheel, centre console and armrest. Ambient lighting for centre armrest, front footwells and door handles are also standard.

**Black**

- 211 Leather<sup>1</sup>
- 231 Leather with red stitching<sup>2</sup>
- 811 Nappa leather<sup>3,4</sup>

**Trim**

- H79 Dark aluminium
- 736 Black Ash wood<sup>3</sup>
- H21 Black Piano Lacquer<sup>3</sup>
- H17 High gloss Dark Brown Lime wood<sup>3</sup>

<sup>1</sup>Standard on SE and AMG Sport

<sup>2</sup>Standard on E 400 AMG Sport Plus

<sup>3</sup>Optional

<sup>4</sup>On the E 400 AMG Sport Plus, AMG sport seats will be replaced with multi-contour sports seats without red contrast stitching







SE interior shown

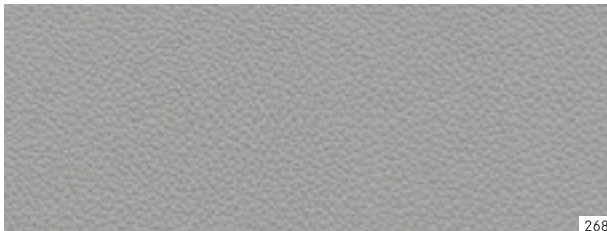

268

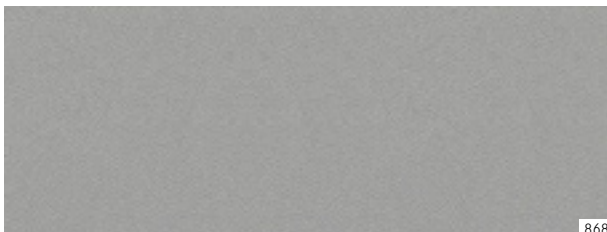

868



H79



736



H21



H17

Alpaca Grey leather upholstery and door centre panels stand out in this interior combined with dashboard, surrounding door trim, steering wheel and floor covering in Black. (Nappa leather is available as an option.) The roof lining can be specified in Black or Grey. There is also a choice of premium wood trim with a range of colours and textures.

**Alpaca Grey**

268 Leather<sup>1,2</sup>

868 Nappa leather<sup>2,3</sup>

**Trim**

H79 Dark aluminium

736 Black Ash wood<sup>3</sup>

H21 Black Piano Lacquer<sup>3</sup>

H17 High gloss Dark Brown Lime wood<sup>3</sup>

<sup>1</sup>Standard

<sup>2</sup>On the E400 AMG Sport Plus, AMG sport seats will be replaced with multi-contour sports seats without red contrast stitching

<sup>3</sup>Optional





SE interior shown

This interior is fitted with leather seats and door centre panels in Natural Beige as standard. (Nappa leather is available as an option.) All other interior coverings come in Black. The standard dark aluminium trim can be replaced with optional Black Ash wood, Black Piano Lacquer or high gloss Dark Brown Lime Wood.

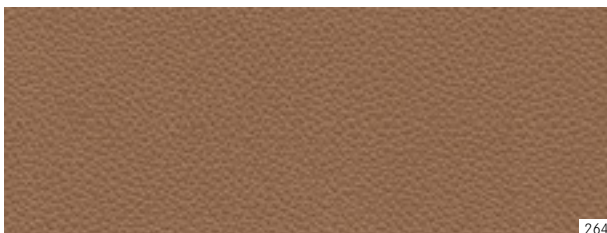

264

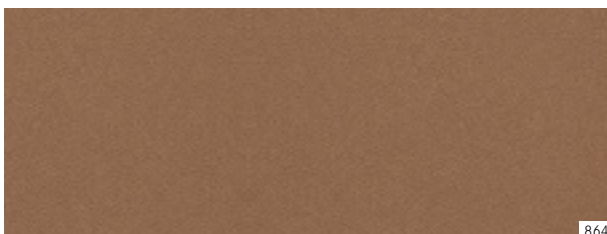

864



H79



736



H21



H17

**Natural Beige**

264 Leather<sup>1,2</sup>

864 Nappa leather<sup>2,3</sup>

**Trim**

H79 Dark aluminium

736 Black Ash wood<sup>3</sup>

H21 Black Piano Lacquer<sup>3</sup>

H17 High gloss Dark Brown Lime wood<sup>3</sup>

<sup>1</sup>Standard

<sup>2</sup>On the E400 AMG Sport Plus, AMG sport seats will be replaced with multi-contour sports seats without red contrast stitching

<sup>3</sup>Optional





SE interior shown

This interior is fitted with leather seats and door centre panels in Bengal Red as standard. (Nappa leather is available as an option.) All other interior coverings come in Black. The standard dark aluminium trim can be replaced with optional Black Ash wood or Black Piano Lacquer.

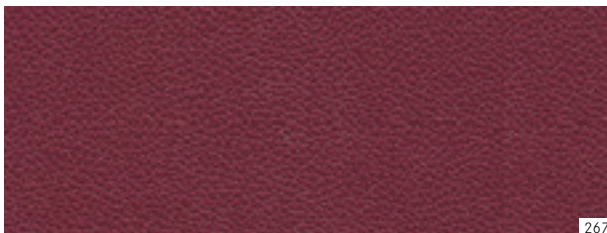

267



H79



736

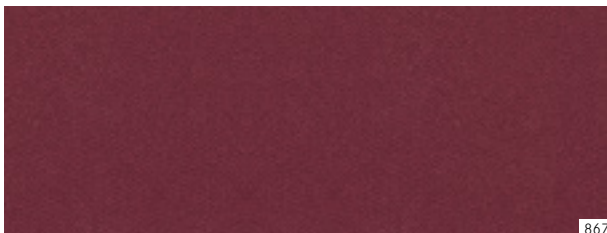

867



H21

**Bengal Red**

267 Leather<sup>1,2</sup>

867 Nappa leather<sup>2,3</sup>

**Trim**

H79 Dark aluminium

736 Black Ash wood<sup>3</sup>

H21 Black Piano Lacquer<sup>3</sup>

<sup>1</sup>Standard

<sup>2</sup>On the E400 AMG Sport Plus, AMG sport seats will be replaced with multi-contour sports seats without red contrast stitching

<sup>3</sup>Optional

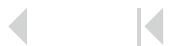



SE interior shown

This interior features Espresso Brown leather seats and door centre panels combined with a black interior. (Nappa leather is available as an option.) The standard dark aluminium trim can be replaced with optional Black Ash wood, Black Piano Lacquer or high gloss Dark Brown Lime wood.

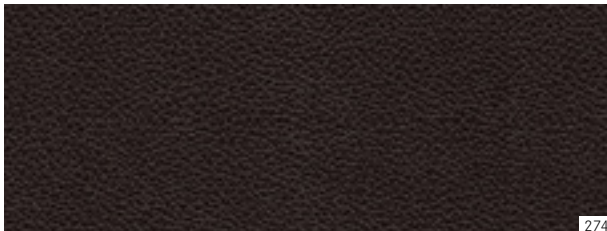

274



H79



736

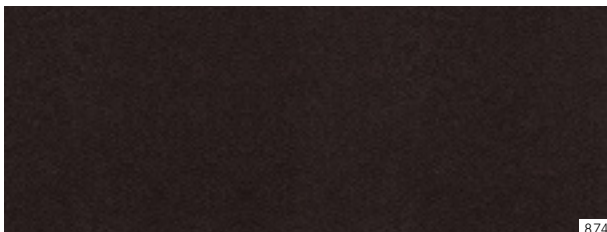

874



H21



H17

**Espresso Brown**

274 Leather<sup>1,2</sup>

874 Nappa leather<sup>2,3</sup>

**Trim**

H79 Dark aluminium

736 Black Ash wood<sup>3</sup>

H21 Black Piano Lacquer<sup>3</sup>

H17 High gloss Dark Brown Lime wood<sup>3</sup>

<sup>1</sup>Standard

<sup>2</sup>On the E400 AMG Sport Plus, AMG sport seats will be replaced with multi-contour sports seats without red contrast stitching

<sup>3</sup>Optional





SE interior shown



215



H79



H17

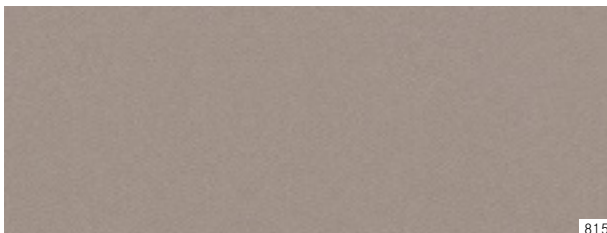

815

In this interior, Silk Beige dominates on leather seats, lower dashboard trim, doors and roof lining. (Nappa leather is available as an option.) It is combined with a steering wheel and upper dashboard trim in Espresso Brown. Whilst the dark aluminium trim comes as standard, the high gloss Dark Brown Lime wood can be chosen as an option.

**Silk Beige<sup>1</sup>**

215 Leather<sup>2</sup>

815 Nappa leather<sup>3</sup>

**Trim**

H79 Dark aluminium

H17 High gloss Dark Brown Lime wood<sup>3</sup>

<sup>1</sup>Not available on E 400 AMG Sport Plus

<sup>2</sup>Standard

<sup>3</sup>Optional





SE interior shown

The Deep Sea Blue and Silk Beige combination fills the cabin with striking contrasts featuring Deep Sea Blue leather upholstery, door centre panels, steering wheel and upper dashboard trim. (Nappa leather is available as an option.) Silk Beige features on the lower sections like the floor covering, lower door trim and dashboard trim, as well as on the seat belts and the roof lining. The standard dark aluminium trim can be replaced with optional Black Ash wood, Black Piano Lacquer or high gloss Dark Brown Lime wood.

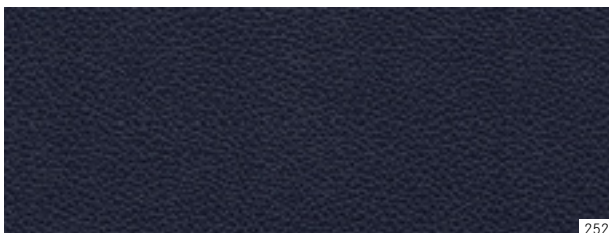

252



852



H79



736



H21



H17

**Deep Sea Blue/Silk Beige<sup>1,2</sup>**

252 Leather<sup>3</sup>

852 Nappa leather<sup>4</sup>

**Trim**

H79 Dark aluminium

736 Black Ash wood<sup>4</sup>

H21 Black Piano Lacquer<sup>4</sup>

H17 High gloss Dark Brown Lime wood<sup>4</sup>

<sup>1</sup>Not available on E 400 AMG Sport Plus

<sup>2</sup>Only in conjunction with automatic transmission

<sup>3</sup>Standard

<sup>4</sup>Optional





SE interior shown

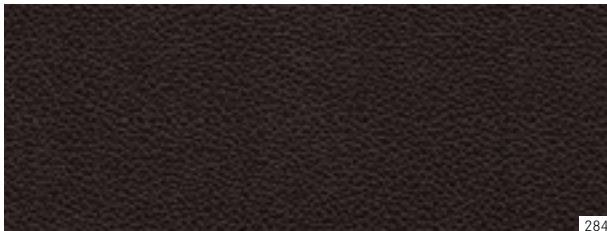

284



H79



H17

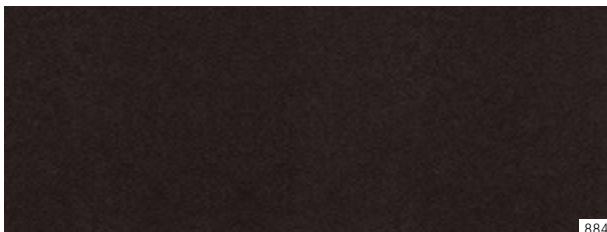

884

**Espresso Brown/Silk Beige<sup>1</sup>**

284 Leather<sup>2</sup>

884 Nappa leather<sup>3</sup>

**Trim**

H79 Dark aluminium

H17 High gloss Dark Brown Lime wood<sup>3</sup>

<sup>1</sup>Not available on E 400 AMG Sport Plus

<sup>2</sup>Standard

<sup>3</sup>Optional





## Alloy wheels



17" 5-twin-spoke alloy wheels with 235/45 R 17 tyres (standard on SE, code 44R)



18" AMG 5-twin-spoke alloy wheels, with front 235/40 R 18 and rear 255/35 R 18 tyres (standard on AMG Sport, code 660)



17" 5-spoke alloy wheels with front 235/45 R 17 and rear 255/40 R 17 tyres (optional on SE, code R22)



18" AMG 5-twin-spoke alloy wheels, with front 235/40 R 18 and rear 255/35 R 18 tyres (optional on AMG Sport, code 795)







[View price list](#)



[View offers](#) [Coupé](#) [Cabriolet](#)



[SOUND WITH POWER](#)



[Mercedes-Benz Magazine](#)



19" AMG 7-twin-spoke bi-colour alloy wheels with front 235/35 R 19 and rear 255/30 R 19 tyres (standard on E 400 AMG Sport Plus or as part of the AMG Sport Plus Package, code 662)



19" AMG 7-twin-spoke alloy wheels, with front 235/35 R 19 and rear 255/30 R 19 (optional on AMG Sport, code 770)





## Retailer-fit accessories

Your Mercedes-Benz Retailer offers a range of accessories designed specially for the E-Class Coupé and Cabriolet. → [www.mercedes-benz.co.uk/accessories](http://www.mercedes-benz.co.uk/accessories)



The Alustyle roof rack can carry up to four bikes (Coupé only)

Exclusively for the E-Class Coupé and E-Class Cabriolet, the Mercedes-Benz Retailer-fit accessories offer a front spoiler and rear spoiler lid to enhance the sporty appeal. There are also many practical features to choose from: for example, an additional load-carrying solution with the Alustyle roof bars. Fit additional luggage or a roof box on top or extend their use with a ski or snowboard rack. The range also includes lockable bike racks for up to four bicycles (depending on load and available width of basic carrier bars), designed with access to the boot. For the Cabriolet, you can choose an easy to assemble wind deflector with a fine-mesh netting to protect against draught.



The rear spoiler complements the sporty rear design



The front spoiler lid adds to the athletic styling

For more information about these and other accessories, talk to your Mercedes-Benz Retailer or consult the relevant accessories brochure.





> View price list



View offers > Coupé > Cabriolet



> SOUND WITH POWER



> Mercedes-Benz Magazine





## Services

**Test drive.** Words can only do so much. Some things have to be experienced to be truly appreciated. Which is why we'd like to invite you for a test drive. Feel the power of efficient engines that offer impressive fuel consumption. Feel exhilarated by precise steering, designed to connect the driver with the road and enjoy sumptuous levels of comfort. Your Mercedes-Benz Retailer will be happy to make arrangements for you to experience the things that set a Mercedes-Benz apart. Alternatively, to request a test drive online simply visit [www.mercedes-benz.co.uk/testdrive](http://www.mercedes-benz.co.uk/testdrive) We look forward to seeing you.

**Mercedes-Benz Finance.** At Mercedes-Benz Finance, our single-minded aim is to provide optimum financial solutions for all those who share the Mercedes-Benz philosophy of absolute commitment to quality. Whether you are a private customer or a business user, our finance and leasing packages can be tailored to meet your individual needs. For further information on Mercedes-Benz Finance, please contact your local Mercedes-Benz Retailer.



**Mercedes-Benz Insurance** offers a fully comprehensive 5-star-rated<sup>1</sup> Motor Insurance policy specifically designed to provide the cover you would expect from Mercedes-Benz. For a quotation, please call 0845 600 2180<sup>2</sup>

**Interactive Owner's Manuals.** The website also offers an interactive tour, enabling you to take a closer look at your desired model. This simulation is the ideal way to acquaint yourself with your dream car. You can view key functions in detail, gain an insight into the car's inner workings or look at the benefits of each model. For further details, visit [www.mercedes-benz.co.uk/eclasscoupemanual](http://www.mercedes-benz.co.uk/eclasscoupemanual) or [/eclasscabrioletmanual](http://www.mercedes-benz.co.uk/eclasscabrioletmanual)



**Roadside Assistance and Accident Management.** Rest assured that should you ever need help, Mercedes-Benz Roadside Assistance is there for you. In the unlikely event of a technical breakdown<sup>3</sup> you can rely on the Mercedes-Benz Roadside Assistance Team – anywhere in Europe. Mercedes-Benz will also assist you in the unfortunate event of an accident, from recovering your car and delivering it to your preferred Mercedes-Benz Retailer right through to managing your insurance claim in full, you will be looked after by the experts who built your Mercedes-Benz.<sup>4</sup> Minor mishaps are also covered. Whether you lose your key, run out of fuel, or your vehicle is damaged due to vandalism, Mercedes-Benz ensures that you still reach your destination. Often the problem can be rectified on the spot, but if this is not possible, we will naturally ensure that your vehicle is taken to the nearest Mercedes-Benz Retailer to get you back on the road as quickly as possible.

<sup>1</sup>As rated by Defaqto, a leading UK independent financial research company  
<sup>2</sup>Mercedes-Benz Motor Insurance is underwritten by Aviva Insurance Limited. For joint protection, calls may be recorded and/or monitored. All calls are charged at local rate. We may decline to quote in some circumstances

Simply phone our Customer Assistance Centre on 00800 1 777 7777,<sup>5</sup> where our specialists will organise assistance for you.

**Service Care.** To keep a tight grip on costs, Mercedes-Benz offers service plans to cover the costs of an annual service, for two, three and four years. Plans can be paid monthly with interest-free instalments or alternatively, if you pay upfront, should you sell your vehicle any remaining services will be transferred to the new owner. All routine maintenance and additional items are covered. To find out more, please contact your local Retailer or visit [www.mercedes-benz.co.uk/servicecare](http://www.mercedes-benz.co.uk/servicecare)

<sup>3</sup>Cover is initially valid for your vehicle for four years from the date of first registration. This can be extended from the fifth year, up to a maximum of 30 years, on completion of each scheduled maintenance service, providing that this service is carried out by a Mercedes-Benz Retailer. Minor mishap cover is provided at the absolute discretion of Mercedes-Benz

**Mercedes-Benz World at Brooklands.** Discover Mercedes-Benz racing heritage, from its connections to the famous Brooklands circuit through to present-day Formula 1™ brought to life in the most sensational way at Mercedes-Benz World in Surrey. View, touch and sit in every car from the Mercedes-Benz range, and encounter automotive legends like the ‘Gullwing’ and many other classic icons, in the UK’s largest Mercedes-Benz showcase. Then set your pulse racing by booking one of our thrilling AMG or 4×4 Driving Experiences. Relax and refuel in Café 1886, or enjoy the delicious menu and elegant surroundings of the Gullwing Bistro. For more information, visit [www.mercedes-benzworld.co.uk](http://www.mercedes-benzworld.co.uk)

<sup>4</sup>Management of claims for non-fault accidents only  
<sup>5</sup>In non-affiliated European countries: +44 20 7975 7077





## Dimensions - Coupé

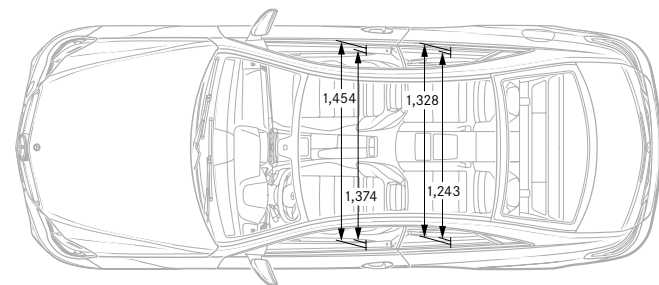
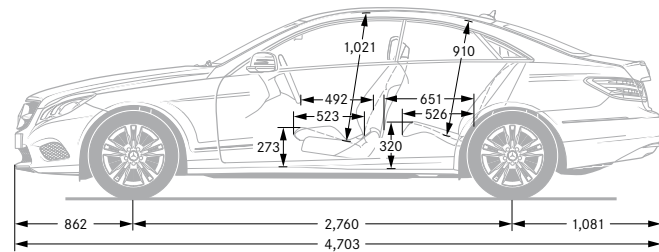
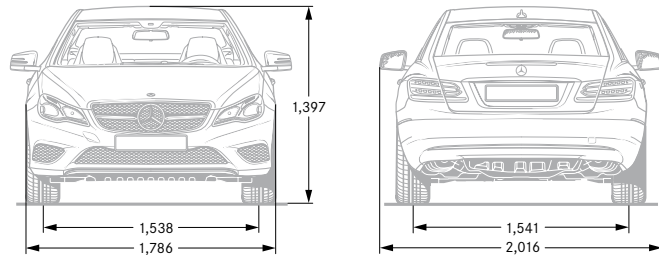

## Dimensions - Cabriolet

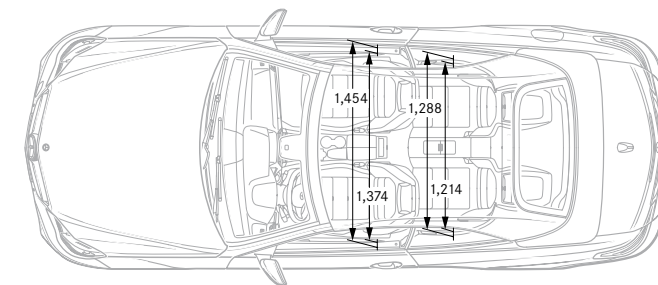
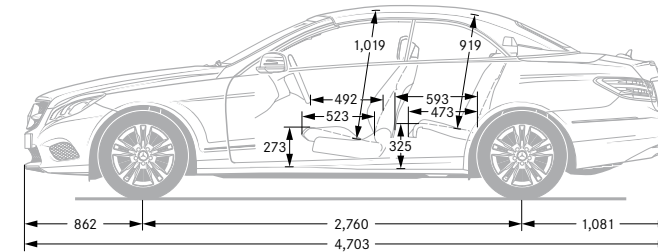
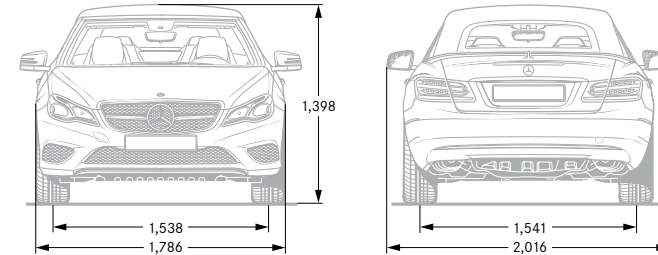

All measurements in millimetres. The dimensions shown are mean values and apply to standard-specification, unladen vehicles





## Technical data - Coupé

	Diesel engines			Petrol engines	
	E 220 CDI	E 250 CDI	E 350 BlueTEC	E 200	E 400
Arrangement/cylinders/valves	in-line/4/16	in-line/4/16	V/6/24	in-line/4/16	V/6/24
Capacity - cm	2,143	2,143	2,987	1,991	2,996
Power <sup>1</sup> - hp (kW) at rpm	170 (125)/3,000-4,200	204 (150)/3,800	252 (185)/3,600	184 (135)/5,500	333 (245)/5,500
Torque <sup>1</sup> - Nm at rpm	400/1,400-2,800	500/1,600-1,800	620/1,600-2,400	300/1,200-4,000	480/1,400-4,000
Acceleration 0-62 mph - sec [auto.]	8.5 [8.3]	- [7.3]	- [6.4]	- [7.8]	- [5.2]
Top speed, approx. - mph [auto.]	146 [145]	- [153]	- [155 <sup>2</sup> ]	- [149]	- [155 <sup>2</sup> ]
Tyre size - front	235/45 R17	235/40 R18	235/40 R18	235/40 R18	235/35 R19
rear	235/45 R17	255/35 R18	255/35 R18	255/35 R18	255/30 R19
Fuel consumption <sup>3</sup> - mpg					
Urban [auto.]	47.9 [47.9]	- [47.1]	- [40.4]	- [36.7]	- [26.7]
Extra-urban [auto.]	68.9 [67.3]	- [65.7]	- [57.7]	- [56.5]	- [48.7]
Combined [auto.]	60.1 [58.9]	- [57.7]	- [49.6]	- [47.1]	- [37.2]
CO <sub>2</sub> emissions, combined <sup>3</sup> - g/km [auto.]	123 [126]	- [129]	- [150]	- [140]	- [177]
Emissions class	EU5	EU5	EU6	EU6	EU6
Tank capacity/reserve, approx. - l	66/8	66/8	66/8	66/8	66/8
Load capacity - l	450	450	450	450	450
Turning circle - m	11.15	11.15	11.15	11.15	11.15
Kerb weight <sup>4</sup> - kg [auto.]	1,705 [1,715]	- [1,735]	- [1,805]	- [1,615]	- [1,725]
Perm. GVW - kg [auto.]	2,175 [2,185]	- [2,205]	- [2,255]	- [2,085]	- [2,195]

Figures in brackets relate to vehicles with automatic transmission

<sup>1</sup>Figures according to Directive 80/1269/EEC in the current applicable version <sup>2</sup>Electronically limited <sup>3</sup>The figures shown were obtained in accordance with the prescribed measuring process (Regulation [EC] 715/2007 in the currently applicable version).

The figures are not based on an individual model and do not constitute part of the product offer; they are provided solely for purposes of comparison between different vehicle models





## Technical data - Cabriolet

	Diesel engines			Petrol engines	
	E 220 CDI	E 250 CDI	E 350 BlueTEC	E 200	E 400
Arrangement/cylinders/valves	in-line/4/16	in-line/4/16	V/6/24	in-line/4/16	V/6/24
Capacity - cm	2,143	2,143	2,987	1,991	2,996
Power <sup>1</sup> - hp (kW) at rpm	170 (125)/3,000-4,200	204 (150)/3,800	252 (185)/3,600	184 (135)/5,500	333 (245)/5,500
Torque <sup>1</sup> - Nm at rpm	400/1,400-2,800	500/1,600-1,800	620/1,600-2,400	300/1,200-4,000	480/1,400-4,000
Acceleration 0-62 mph - sec [auto.]	8.8 [8.7]	- [7.7]	- [6.7]	- [8.2]	- [5.3]
Top speed, approx. - mph [auto.]	144 [143]	- [151]	- [155 <sup>2</sup> ]	- [146]	- [155 <sup>2</sup> ]
Tyre size - front	235/45 R17	235/40 R18	235/40 R18	235/40 R18	235/35 R19
rear	235/45 R17	255/35 R18	255/35 R18	255/35 R18	255/30 R19
Fuel consumption <sup>3</sup> - mpg					
Urban [auto.]	47.9 [48.7]	- [47.9]	- [39.2]	- [34.5]	- [25.7]
Extra-urban [auto.]	67.3 [67.3]	- [64.2]	- [54.3]	- [53.3]	- [46.3]
Combined [auto.]	57.7 [58.9]	- [57.7]	- [47.9]	- [44.1]	- [35.8]
CO <sub>2</sub> emissions, combined <sup>3</sup> - g/km [auto.]	127 [126]	- [130]	- [156]	- [148]	- [185]
Emissions class	EU5	EU5	EU6	EU6	EU6
Tank capacity/reserve, approx. - l	66/8	66/8	66/8	66/8	66/8
Load capacity (soft-top down) - l	390 (300)	390 (300)	390 (300)	390 (300)	390 (300)
Turning circle - m	11.15	11.15	11.15	11.15	11.15
Kerb weight <sup>4</sup> - kg [auto.]	1,825 [1,835]	- [1,845]	- [1,935]	- [1,735]	- [1,845]
Perm. GVW - kg [auto.]	2,295 [2,305]	- [2,315]	- [2,350]	- [2,205]	- [2,315]

<sup>1</sup>Figures according to Directive 92/21/EC, version 95/48/EC (kerb weight with fuel tank 90% full, driver, 68 kg, and luggage, 7kg) for standard-specification vehicles. Optional extras and accessories will generally increase this figure and reduce the payload capacity accordingly. For further technical data, please visit [www.mercedes-benz.co.uk](http://www.mercedes-benz.co.uk)







# Paint finishes

The highly durable nature of the Mercedes-Benz paint system makes it one of the best clear coats available in the automotive industry. A highly dense molecular structure provides the key to the extremely resilient paint, regardless whether it's non-metallic or metallic, giving the surface a longer lasting, more intense shine.

### Non-metallic paints

- 040 Black
- 149 Polar White
- 590 Fire Opal

### Metallic paints<sup>1</sup>

- 197 Obsidian Black
- 296 Aragonite Silver
- 755 Tenorite Grey
- 775 Iridium Silver
- 792 Palladium Silver
- 799 Diamond White<sup>2</sup>
- 890 Cavansite Blue
- 988 Diamond Silver

### Soft-top colours<sup>3</sup>

- 740 Black
- 741 Dark Brown
- 744 Dark Blue
- 746 Red

Non-metallic paints

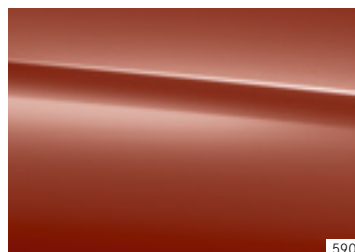
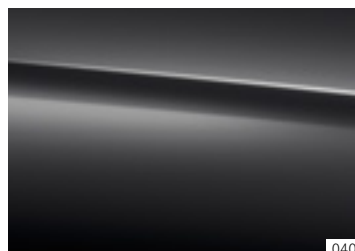

Metallic paints<sup>1</sup>

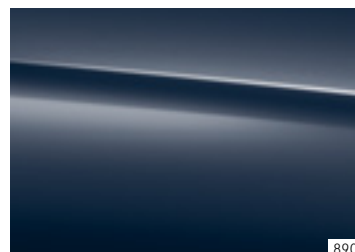
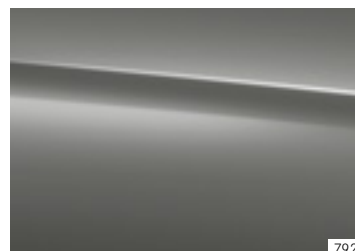
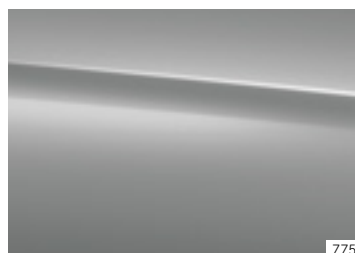
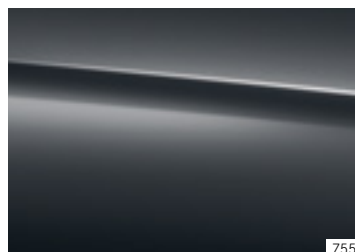
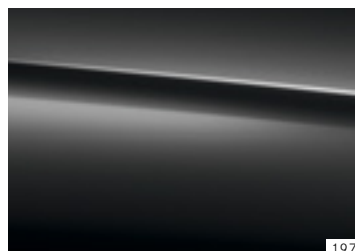

Soft-top colours<sup>3</sup>



<sup>1</sup>Optional <sup>2</sup>Additional-cost option <sup>3</sup>Cabriolet only





> View price list



View offers > Coupé > Cabriolet



> SOUND WITH POWER



> Mercedes-Benz Magazine

**Take-back of end-of-life vehicles. Coming full circle.** At the end of its long life, you can return your E-Class to us for environment friendly disposal in accordance with the EC End-of-Life Vehicle Directive.<sup>1</sup> But that day lies a long way off.

<sup>1</sup>Applies in accordance with national regulations to vehicles up to 3.5 t permissible gross weight. The E-Class has met the statutory regulations governing the suitability of the vehicle's design for reuse and recycling for a number of years now. A network of vehicle take-back depots and dismantlers has been established which will process your vehicle in an environment-friendly manner. The ways in which both vehicles and parts can be recovered are subject to ongoing development and improvement. Consequently, the E-Class will be able to comply with any future increases in the recycling quota within the stipulated time limits. Further information is available at [www.mercedes-benz.co.uk](http://www.mercedes-benz.co.uk) or by calling 0808 156 6606.

**Please note:** this online version of the printed brochure may contain abridged copy or other content changes. The manufacturer reserves the right to make changes to the design, form, colour and specification during the delivery period, provided these changes, while taking into account the interests of the vendor, can be deemed reasonable with respect to the purchaser. Where the vendor or the manufacturer uses symbols or numbers to describe an order or the subject of an order, no rights may be derived solely from these. The illustrations may show accessories and items of optional equipment which are not part of standard specification. Colours may differ slightly from those shown in the brochure, owing to the limitations of the printing process. This brochure has been compiled by Daimler AG of Germany and is distributed internationally. It provides a general indication of the range of models, features, optional extras and/or colours available in various countries. Some of the models, features, optional extras and/or colours shown may not be available in your country or may only be available in a different specification. Additionally some models, features, optional extras and/or colours may only be available in combination with others. For current and more specific information in relation to the range of models, features, optional extras and/or colours available in your country, and their pricing, you should contact your nearest authorised Mercedes-Benz Retailer. E&OE. [www.mercedes-benz.co.uk](http://www.mercedes-benz.co.uk)

Daimler AG, Mercedesstr. 137, 70327 Stuttgart BC/MC 6701 · 1418 · 88-01/1213 Printed in Germany

