

M-Class price list

Effective from 1 April 2014



Mercedes-Benz

Contents

Model prices	5	AMG optional equipment	34
Finance offers	6	Colours and materials	40
Model lines	10	Technical specifications	44
Standard equipment	14	Road Fund Licence	48
Wheels	17	Services and benefits	49
Optional equipment	20	Mercedes-Benz Finance and Insurance	50
AMG standard equipment	30		

The hard facts to melt your heart

At Mercedes-Benz we appreciate the importance of detail. Over the following pages you'll find model prices and a breakdown of standard and optional equipment, as well as details of the comprehensive services and benefits that are available to every Mercedes-Benz driver.

See Mercedes-Benz in a new light. Now is the time to get yourself behind the wheel of an M-Class. Choose from a number of attractive finance offers. Please see pages 6-9 for further details, or visit www.mercedes-benz.co.uk/offers

Of course, some things have to be experienced to be truly appreciated, such as the qualities that set a Mercedes-Benz apart. Which is why we'd like to invite you for a test drive at your local Mercedes-Benz Retailer. Alternatively, you can make arrangements by visiting www.mercedes-benz.co.uk/testdrive

For more information visit www.mercedes-benz.co.uk or call 0808 156 6606.



Model prices

Engine	Model line	Transmission	CO ₂	Basic RRP excl. VAT (£)	Total RRP incl. VAT (£)	Road Fund Licence (£) ¹	Rec. OTR price (£) ²	P11D value (£)	BiK tax rate 2014/15 (%)
ML 250 BlueTEC Diesel – 2,143 cc, 4-cylinder, 204 hp/150 kW	SE	7G-Tronic Plus 7-speed automatic	160	36,333.33	43,600.00	180.00	44,450.00	44,215.00	28
	AMG Sport	7G-Tronic Plus 7-speed automatic	160	38,116.67	45,740.00	180.00	46,590.00	46,355.00	28
ML 350 BlueTEC Diesel – 2,987 cc, 6-cylinder, 258 hp/190 kW	SE	7G-Tronic Plus 7-speed automatic	189	38,683.33	46,420.00	485.00	47,575.00	47,035.00	33
	AMG Sport	7G-Tronic Plus 7-speed automatic	189	40,466.67	48,560.00	485.00	49,715.00	49,175.00	33
AMG									
ML 63 AMG Petrol – 5,461 cc, 8-cylinder, 525 hp/386 kW	AMG	AMG Speedshift Plus 7G-Tronic 7-speed auto.	276	68,658.33	82,390.00	1,090.00	84,150.00	83,005.00	35

¹A different first year rate of Vehicle Excise Duty (Road Fund Licence) applies for new cars. Please refer to page 48 for the relevant rate for the second and subsequent years

²Recommended on-the-road price: these prices reflect the Road Fund Licence applicable to the standard model plus £670.00 additional costs necessary to put your car on the road.

Included are a standard UK delivery charge (£540.00 incl. VAT), new vehicle registration fee (£55.00), number plates (£25.00 incl. VAT) and fuel (£50.00 incl. VAT). VAT is calculated at the standard rate of 20%

Mercedes-Benz Finance

It comes with a specification list worth exploring

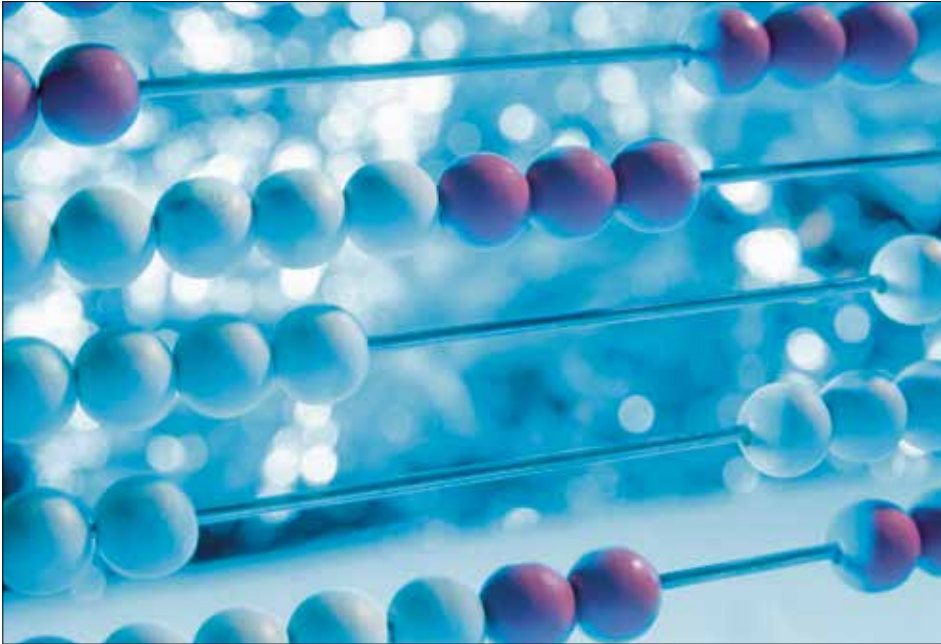

ML 250 BlueTEC SE with automatic transmission and metallic paint (representative example)

36 monthly payments of ¹	£499.00
On-the-road price	£44,450.00
Customer deposit	£7,331.29
Retailer deposit contribution	£2,178.00
Duration of agreement	36 months
Optional purchase payment ²	£20,850.00
Acceptance fee	£180.00
Purchase activation fee ²	£95.00
Amount of credit	£34,940.71
Total amount payable ³	£48,598.29
Representative APR	5.0% APR
Fixed interest rate	4.57%

Example offer – 5.0% APR Representative

	Automatic	Metallc	On-the-road price	Retailer deposit contribution	Customer deposit	36 monthly payments of ¹
ML 250 BlueTEC AMG Sport	●	●	£46,590.00	£2,178.00	£7,508.03	£525.00
ML 350 BlueTEC AMG Sport	●	●	£49,715.00	£2,178.00	£7,711.19	£575.00

● Standard equipment

Mercedes-Benz Service Care

- Mercedes-Benz trained Technicians
- Maintained by Mercedes-Benz Retailers
- Meets requirements of Mercedes-Benz Agility finance agreement

Mercedes-Benz Motor Insurance

- 24/7 UK accident recovery
- We use Mercedes-Benz GenuineParts
- To qualify for up to 10% discount online, go to www.mercedes-benz.co.uk/motorinsurance
- Alternatively, call Mercedes-Benz Motor Insurance now on **0845 600 2180**⁴ for an annual quote

We may decline to quote in some circumstances. Mercedes-Benz Motor Insurance is underwritten by Aviva Insurance Limited

Whilst these offers are only available with Mercedes-Benz Finance, our Mercedes-Benz Retailers do arrange finance on behalf of other finance companies as well

Orders/credit approvals on selected M-Class models between 10 May and 30 June 2014, registered by 30 September 2014. Some combinations of features/options may not be available. Please contact your local Mercedes-Benz Retailer for availability

¹Based on a Mercedes-Benz Agility agreement and 10,000 miles per annum. Excess mileage charges may apply. Quotations available on request for alternative contract lengths and mileages. Guarantees and indemnities may be required. Terms and Conditions apply.

Credit provided subject to status by Mercedes-Benz Financial Services UK Ltd, MK15 8BA

²Payable if you exercise the option to purchase the car. Guaranteed future value if you choose to hand back the vehicle at the end of the contract

³Includes optional purchase payment, purchase activation fee and Retailer deposit contribution ⁴Calls are charged at local rate and may be recorded

Mercedes-Benz Finance

Even the finance offer is beautifully put together

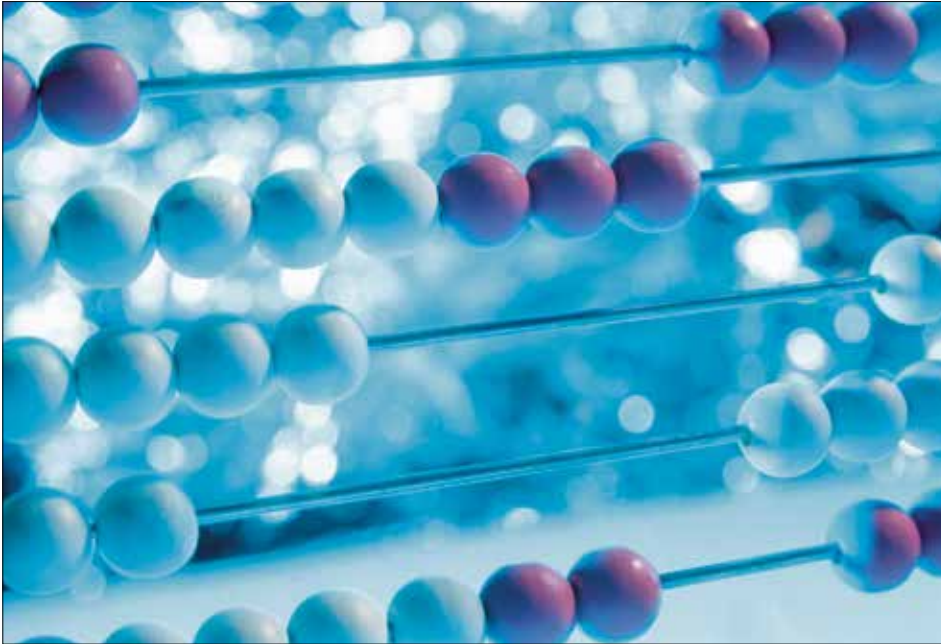

ML 63 AMG with automatic transmission and metallic paint (representative example)

36 monthly payments of ¹	£1,019.00
On-the-road price	£84,150.00
Customer deposit	£7,728.75
Retailer deposit contribution	£8,058.50
Duration of agreement	36 months
Optional purchase payment ²	£39,150.00
Acceptance fee	£180.00
Purchase activation fee ²	£95.00
Amount of credit	£68,362.75
Total amount payable ³	£91,896.25
Representative APR	4.8% APR
Fixed interest rate	4.57%

Example offer – 4.8% APR Representative

	Automatic	Metallic	On-the-road price	Retailer deposit contribution	Customer deposit	36 monthly payments of ¹
ML 63 AMG	●	●	£84,150.00	£8,058.50	£7,728.75	£1,019.00
● Standard equipment						

Mercedes-Benz Service Care

- Mercedes-Benz trained Technicians
- Maintained by Mercedes-Benz Retailers
- Meets requirements of Mercedes-Benz Agility finance agreement

Mercedes-Benz Motor Insurance

- 24/7 UK accident recovery
- We use Mercedes-Benz GenuineParts
- To qualify for up to 10% discount online, go to www.mercedes-benz.co.uk/motorinsurance
- Alternatively, call Mercedes-Benz Motor Insurance now on **0845 600 2180**⁴ for an annual quote

We may decline to quote in some circumstances. Mercedes-Benz Motor Insurance is underwritten by Aviva Insurance Limited

Whilst these offers are only available with Mercedes-Benz Finance, our Mercedes-Benz Retailers do arrange finance on behalf of other finance companies as well

Orders/credit approvals on ML 63 AMG models between 1 April and 30 June 2014, registered by 30 September 2014. Some combinations of features/options may not be available. Please contact your local Mercedes-Benz Retailer for availability

¹Based on a Mercedes-Benz Agility agreement and 10,000 miles per annum. Excess mileage charges may apply. Quotations available on request for alternative contract lengths and mileages. Guarantees and indemnities may be required. Terms and Conditions apply.

Credit provided subject to status by Mercedes-Benz Financial Services UK Ltd, MK15 8BA

²Payable if you exercise the option to purchase the car. Guaranteed future value if you choose to hand back the vehicle at the end of the contract

³Includes optional purchase payment, purchase activation fee and Retailer deposit contribution ⁴Calls are charged at local rate and may be recorded

M-Class SE



There is little chance of the M-Class SE going unnoticed. Along with aluminium finish running boards, complete with rubber studs, the SE is equipped with chrome-style front and rear apron trims. LED daytime running lights are standard, as are 19" 5-spoke alloy wheels. The SE also comes with a Mirror Package that includes electrically folding exterior mirrors as well as auto-dimming rear-view and driver's side mirrors. Inside, brushed aluminium trim is standard, with four different wood trims available as options.

Exterior

19" 5-spoke alloy wheels with 255/50 tyres

Courtesy lighting on underside of door mirrors

Door mirrors – electrically operated, heated, automatically dimming and folding

Front and rear apron trims, chrome style

LED daytime running lights

Running boards – aluminium finish

Interior

Automatic climate control

Becker® Map Pilot navigation system

Electric windows

Four-way electric lumbar support for driver's seat

Seats are upholstered in Artico leather¹ in either Black, Almond Beige or Alpaca Grey, with leather upholstery also available. Front seats offer full electric adjustment and the driver's seat provides electric, four-way lumbar support. The nappa leather-trimmed multi-function steering wheel brings the Audio 20 under the driver's effortless control. Wherever you venture, it's reassuring to know that you can rely on the Becker® Map Pilot navigation system, fitted as standard.

Front seats – full electric adjustment (backrest, height and longitude)

Split folding rear seats – 1/3: 2/3, with manual back adjustment

Trim and Upholstery

Brushed light aluminium



Artico leather¹ – Black



Artico leather¹ – Almond Beige



Artico leather¹ – Alpaca Grey



¹Man-made leather with perforations in seat centre panel

M-Class AMG Sport



The M-Class AMG Sport is quite a head turner. It boasts an even sleeker, sportier look as it comes with all-round AMG bodystyling and eye-catching 19" AMG 5-spoke alloy wheels. This athletic look is underscored by chrome-style front and rear apron trims, aluminium-finish roof rails and body-coloured side trim panels. Privacy glass from the B-pillar backwards completes the look. Once inside, the AMG Sport delivers on its sporty credentials with the 4-spoke sports steering wheel with perforated grip areas, rubber-studded stainless steel sports pedals and black floor mats

with leather edging and 'Mercedes-Benz' badges. The beauty within, however, has to be the upholstery: sports seats in Artico leather¹/Black Dinamica microfibre.² The standard Audio 20 radio/CD with Becker[®] Map Pilot navigation system ensures you find the best route to your destination. For added comfort, the AMG Sport is easy to park with the standard Parktronic with Active Park Assist. It doesn't just pick the right parking spot, but will also guide you in with ease.

Exterior

19" AMG 5-spoke alloy wheels

AMG bodystyling – front and rear apron, side skirts

Direct Steering

Easy-Pack powered tailgate – opens and closes automatically

LED daytime running lights

Parktronic with Active Park Assist

Interior

Automatic climate control

Becker[®] Map Pilot navigation system

Door centre panels with ribbed design in Artico leather¹

Front seats – full electric adjustment and four-way electric lumbar support

Split folding rear seats 1/5:2/3 with manual back adjustment

Sports seats with Artico leather¹/Dinamica microfibre²

Trim and Upholstery

Brushed light aluminium

Artico leather¹/Dinamica microfibre



¹Man-made leather ²Please refer to page 22 for further information regarding leather upholstery and two-tone leather upholstery options

Standard equipment

Item	AMG Sport	
	SE	
Transmission and Suspension		
7G-Tronic Plus 7-speed automatic transmission with steering column gear selector, steering wheel gear shift paddles (Direct Select) and Speedtronic cruise control	●	●
ECO start/stop function	●	●
Off-road switch – primes systems for off-road driving (ML 350 BlueTEC only)	●	●
Permanent four-wheel drive	●	●
Steel suspension – lowered (ML 250 BlueTEC only)	●	●
Steel suspension (ML 350 BlueTEC only)	●	●
Exterior		
AMG bodystyling – front and rear apron, side skirts	–	●
Courtesy lighting on underside of door mirrors	●	●
Diesel Particulate Filter (DPF)	●	●
Direct Steering	●	●
Door mirrors – electrically operated and heated	–	●
Door mirrors – electrically operated, heated, automatically dimming and folding	●	○
Easy-Pack powered tailgate – opens and closes automatically	○	●
Front and rear apron trims, chrome style	●	●
Headlamps – halogen	●	●
LED daytime running lights	●	●

Item	AMG Sport	
	SE	
LED rear tail lights	●	●
Parktronic with Active Park Assist	○	●
Privacy glass – dark glass from B-pillar backwards	○	●
Radiator grille with three chromed louvres	●	●
Rain-sensing wipers	●	●
Rear bumper with integrated reflectors	●	●
Rear screen wash/wiper	●	●
Roof rails – aluminium finish	●	●
Running boards – aluminium finish	●	○
Scratch guard on load compartment sill – chrome	●	●
Space-saver spare wheel – steel	●	●
Tinted glass – green	●	●
Interior		
12 V socket in load compartment and passenger compartment – front and rear	●	●
Automatic climate control	●	●
Automatically dimming rear-view mirror	●	○
Centre armrests – front (with storage) and rear	●	●
Cup holders – front (2) and rear (2)	●	●





Item	SE	AMG Sport
Interior (continued)		
Door centre panels with ribbed design in Artico leather ¹	-	●
Electric windows (4)	●	●
Front seats – full electric adjustment (backrest, height and longitude) with four-way electric lumbar support for driver's seat	●	●
Load-securing rings (4)	●	●
Luggage compartment cover	●	●
Outside temperature gauge	●	●
Reading lights – front and rear	●	●
Service indicator ASSYST	●	●
Split folding rear seats – 1/3:2/3, with manual back adjustment	●	●
Sports pedals – stainless steel with rubber studs	-	●
Sports seats with Artico leather ¹ /Dinamica microfibre	-	●
Steering wheel – 4-spoke multi-function, trimmed in nappa leather	●	-
Sports steering wheel – 4-spoke multi-function, trimmed in nappa leather with perforated grip areas	-	●
Steering column – manually adjustable for height and reach	●	●
Sun visors with illuminated vanity mirrors	●	●
Velour floor mats – black, with nubuck leather edging and 'Mercedes-Benz' brushed metal badge with matt finish	-	●





Item	SE	AMG Sport
Paint, Trim and Upholstery		
Metallic paint	●	●
Trim – brushed light aluminium	●	●
Upholstery – Artico leather ¹ with perforations in seat centre panel	●	-
Upholstery – Artico leather ¹ /Dinamica microfibre	-	●
Security and Safety		
Active Bonnet – pedestrian safety measure	●	●
Adaptive brake lights	●	●
Airbags – driver and front passenger	●	●
Airbags – front sidebags	●	●
Airbags – windowbags	●	●
Alarm system with immobiliser and interior protection (MBSS3)	●	●
Anti-lock braking system (ABS) with Brake Assist (BAS)	●	●
Attention Assist – monitors steering behaviour and can help to alert to long journey fatigue	●	●
Automatic child seat recognition sensor Works in conjunction with Mercedes-Benz child seats fitted with transponder	●	●
Collision Prevention Assist	●	●
Downhill Speed Regulation (DSR) with switch and variable speed control	●	●

Item	AMG Sport	
	SE	
Security and Safety (continued)		
Electric parking brake	●	●
Electronic Stability Programme (ESP®) with Acceleration Skid Control (ASR)	●	●
ESP® Trailer Stability Assist	●	●
First-aid kit and warning triangle	●	●
Four-wheel Electronic Traction System (4ETS)	●	●
Headlamp Assist – automatic headlamp activation	●	●
High-level third brake light	●	●
Hill Start Assist	●	●
ISOFIX and top-tether child seat fixing points in rear (two outer seats)	●	●
Manually adjustable head restraints – front and rear	●	●
Pre-Safe® anticipatory safety system	●	●
Remote central locking	●	●
Seat belt pre-tensioners and force limiters – front and outer rear seats	●	●
Sports brakes with 18"/19" brake discs – perforated at the front, with caliper covers	–	●
Tyre pressure loss warning system	●	●



Item	AMG Sport	
	SE	
Communications and In-Car Entertainment		
Audio 20 radio with 5.8-inch colour display, single CD drive (MP3 compatible), 8 speakers and telephone keypad	●	●
Becker® Map Pilot navigation system Navigation is enabled on Audio 20 display and controlled using central controller dial and steering wheel controls. Map Pilot hardware plugs into socket in the glove compartment	●	●
Bluetooth® interface for hands-free telephony	●	●
Central controller dial to operate audio functions and telephone (when connected)	●	●
USB port in centre armrest	●	●

A revolution in style

Item	Notes		SE	AMG Sport	ML 63 AMG	Basic RRP excl. VAT (£)	Total RRP incl. VAT (£)
Wheels							
17" alloy wheels (4) – 10-spoke design 235/65 tyres			25R ○	-	-	95.83	115.00
19" alloy wheels (4) – 5-spoke design 255/50 tyres			R39	●	-	-	-
19" alloy wheels (4) – 7-spoke design 255/50 tyres			R53	○	-	95.83	115.00
19" AMG alloy wheels (4) – 5-spoke design 255/50 tyres			780	-	●	-	-

Item	Notes		SE	AMG Sport	ML 63 AMG	Basic RRP excl. VAT (£)	Total RRP incl. VAT (£)	
Wheels (continued)								
20" alloy wheels (4) – 5-twin-spoke design 265/45 tyres			R33	○	-	-	525.00	630.00
20" AMG alloy wheels (4) – 5-spoke design 265/45 tyres			758	-	○	-	725.00	870.00
20" AMG alloy wheels (4) – 5-spoke design 265/45 tyres			778	-	-	●	-	-
21" AMG alloy wheels (4) – 5-twin-spoke design 265/40 tyres	Only in conjunction with AirMATIC air suspension (code 489)		757	-	○	-	1,245.83	1,495.00

● Standard ○ Optional - Not available

Item	Notes		SE	AMG Sport	ML 63 AMG	Basic RRP excl. VAT (£)	Total RRP incl. VAT (£)	
Wheels (continued)								
21" AMG alloy wheels (4) – 5-twin-spoke design 295/35 tyres			798	-	-	○	712.50	855.00
21" AMG alloy wheels (4) – 5-twin-spoke design, painted matt black 295/35 tyres			685	-	-	○	1,120.83	1,345.00

Optional equipment



Ambient interior lighting with a choice of three colours



Active Blind Spot Assist increases safety during lane changes



Panoramic glass sunroof



Night View Assist Plus



Intelligent Light System with bi-xenon headlamps



COMAND Online system with Internet capability

Item	Notes		SE	AMG Sport	Basic RRP excl. VAT (£)	Total RRP incl. VAT (£)
Suspension and Exterior						
On- & Off-Road Package Drive programme switch and animation in COMAND Online display, 'manual' mode for automatic transmission, 100% differential locks on centre differential, front and rear axles with adaptive 4ETS, off-road ratio, underbody protection under engine, reinforced underfloor panelling as well as special off-road algorithm for ABS, ETS, ESP® and air suspension	Only in conjunction with AirMATIC air suspension (code 489) and COMAND Online systems (code 512 or 527)	430	○	○	1,654.17	1,985.00
Parking Package 360° camera Parktronic with Active Park Assist	Only in conjunction with COMAND Online systems (code 512 or 527) and Mirror Package (code P49)	P44	○	-	1,183.33	1,420.00
			-	○	545.83	655.00
93-litre fuel tank	Replaces standard 70-litre fuel tank	915	○	○	87.50	105.00
Active Curve System With active suspension stabilisers	Only in conjunction with AirMATIC air suspension (code 489) and tyre pressure monitoring system (code 475). ML 350 BlueTEC only	468	○	○	2,700.00	3,240.00
AirMATIC air suspension With level adjustment and Adaptive Damping System		489	○	○	1,479.17	1,775.00
Easy-Pack powered tailgate Opens and closes automatically		890	○	●	454.17	545.00
Headlamps – Intelligent Light System Bi-xenon headlamps, Active Light System, automatic headlamp range adjustment, cornering light function, headlamp wash and Adaptive High Beam Assist		621	○	○	1,358.33	1,630.00
Parktronic with Active Park Assist		235	○	●	637.50	765.00
Privacy glass Dark glass from B-pillar backwards		840	○	●	341.67	410.00
Reversing camera	Only in conjunction with COMAND Online systems (code 512 or 527)	218	○	○	350.00	420.00

Item	Notes		SE	AMG Sport	Basic RRP excl. VAT (£)	Total RRP incl. VAT (£)
Suspension and Exterior (continued)						
Running boards – aluminium finish with rubber studs	Lower colour-coded side trim is replaced with black trim	846	●	○	412.50	495.00
Tow bar, manually folding with electric release	Only available in conjunction with 93-litre fuel tank (code 915) on ML 350 BlueTEC. When ordering this option, please discuss with your Retailer any specific towing requirements	550	○	○	791.67	950.00
Paint, Trim and Upholstery						
Metallic paint – Diamond White		799	○	○	679.17	815.00
Roof lining in <i>designo</i> Black Dinamica microfibre	Included in conjunction with <i>designo</i> Exclusive leather upholstery (codes X06, X11 or X27). Not in conjunction with Almond Beige upholsteries (codes 105 or 205). Only in conjunction with double sun visors (code 543)	Y41	–	○	1,362.50	1,635.00
Roof lining in <i>designo</i> Black fabric	Not in conjunction with Almond Beige upholsteries (code 105 or 205)	Y90	○	○	308.33	370.00
Trim – Black Poplar wood, gloss		729	○	○	316.67	380.00
Trim – Brown Burr Walnut wood, gloss		731	○	○	316.67	380.00
Trim – Brown Eucalyptus wood, gloss		734	○	○	175.00	210.00
Trim – Brown Open-pore Ash wood		H09	○	○	316.67	380.00
Trim – <i>designo</i> Black Piano Lacquer	Not in conjunction with wood- and leather-trimmed steering wheel (code 289)	W69	–	○	1,308.33	1,570.00
Upholstery – leather	When choosing optional leather upholstery for the AMG Sport, the interior differs from the standard specification AMG Sport interior. The 4-spoke steering wheel, seats and door centre panels are in a different design; the sports pedals are replaced and the 'Mercedes-Benz'-badged floor mats removed. The exception to this is if Black nappa leather (code 801) is selected, in which case the AMG Sport interior remains unchanged		¹	○	1,087.50	1,305.00
			–	○	895.83	1,075.00
Upholstery – two-tone leather		¹	–	○	1,112.50	1,335.00

Item	Notes	SE	AMG Sport	Basic RRP excl. VAT (£)	Total RRP incl. VAT (£)	
Paint, Trim and Upholstery (continued)						
Upholstery – leather/nappa leather		801	-	○	1,612.50	1,935.00
<i>designo</i> Exclusive leather/upholstery Armrests in doors and centre console and handrest in chosen <i>designo</i> leather colour Dashboard and door beltlines trimmed in Black nappa leather Double sun visors (code 543) Floor mats with edging in <i>designo</i> Black leather and <i>designo</i> metal badges Roof lining in Black Dinamica microfibre Seat and door centre panels in chosen <i>designo</i> leather colour in diamond design with <i>designo</i> badges in front and rear seat backrests Available in: <i>designo</i> Marron X06 <i>designo</i> Black X11 <i>designo</i> Porcelain X27	Based on Black leather (code 201). Only in conjunction with electric glass sunroof (code 414) or panoramic glass sunroof with interior sun blind (code 413). Not in conjunction with dashboard in Artico leather ¹ (code U09)	1	-	○	5,483.33	6,580.00
<i>designo</i> wood- and leather-trimmed steering wheel	Only in conjunction with <i>designo</i> trim in Black Piano Lacquer (code W69). Not in conjunction with wood- and leather-trimmed steering wheel (code 289), Almond Beige or Alpaca Grey upholstery (codes 205 and 208)	Y95	-	○	870.83	1,045.00
Wood- and leather-trimmed steering wheel	Only in conjunction with wood trims (codes 729, 731, 734 or H09). Not in conjunction with heated multi-function steering wheel (code 443), Dinamica microfibre/Artico leather ¹ (code 601) or Black nappa leather upholstery (code 801)	289	○	○	512.50	615.00

Item	Notes		SE	AMG Sport	Basic RRP excl. VAT (£)	Total RRP incl. VAT (£)
Comfort						
Memory Package Front seats, front head restraints, steering column and exterior door mirrors – electrically adjustable with memory. Additional four-way electric lumbar support for front passenger seat		P64	<input type="radio"/>	<input type="radio"/>	775.00	930.00
Mirror Package Automatically dimming rear-view and driver's door mirrors and electrically folding exterior mirrors		P49	<input checked="" type="radio"/>	<input type="radio"/>	470.83	565.00
Ambient lighting – choice of three colour settings		876	<input type="radio"/>	<input type="radio"/>	304.17	365.00
Ashtray and cigarette lighter	Replaces storage compartments in front and rear and 12V socket in front	301	<input type="radio"/>	<input type="radio"/>	41.67	50.00
Cup holder – temperature-controlled	Not in conjunction with Keyless-Go (code 889)	311	<input type="radio"/>	<input type="radio"/>	183.33	220.00
Dashboard – upper and lower sections, beltline and door panels in Artico leather ¹ with top-stitching		U09	–	<input type="radio"/>	787.50	945.00
Easy-Pack load-securing kit		942	<input type="radio"/>	<input type="radio"/>	258.33	310.00
Electric glass sunroof		414	<input type="radio"/>	<input type="radio"/>	1,012.50	1,215.00
Front seats – comfort-ventilated	Only in conjunction with leather upholstery. Leather on front seats is perforated when this option is chosen. Not in conjunction with Artico leather ¹ (code 101, 105 or 108), Artico leather ¹ /Dinamica microfibre (code 601) or Black nappa leather upholstery (code 801)	401	<input type="radio"/>	<input type="radio"/>	920.83	1,105.00
	In conjunction with <i>designo</i> Exclusive leather upholstery (code X06, X11 and X27)		–	<input type="radio"/>	625.00	750.00
Front seats – heated	Not in conjunction with comfort-ventilated front seats (code 401)	873	<input type="radio"/>	<input type="radio"/>	295.83	355.00

Item	Notes	SE AMG Sport	Basic RRP excl. VAT (£)	Total RRP incl. VAT (£)
Comfort (continued)				
Garage door opener – integrated in rear-view mirror For questions regarding compatibility please call the Homelink Hotline, Johnson Controls – freephone (0)0800 046 635 465 – or visit www.homelink.com	Only in conjunction with Mirror Package (code P49)	231 ○ ○	191.67	230.00
Heated windscreen wash system		875 ○ ○	150.00	180.00
Keyless-Go Includes door handles with chrome inlay		889 ○ ○	775.00	930.00
Luggage compartment cover, including safety net		541 ○ ○	145.83	175.00
Luxury automatic climate control Multi-zone function with separate air distribution settings for driver, front passenger and rear. Three different climate modes: Focused, Medium and Diffuse		581 ○ ○	583.33	700.00
Multi-contour front seats Massage function, luxury head restraints and seat cushion depth adjustment	Not in conjunction with Black Artico leather ¹ /Dinamica microfibre (code 601) or Black nappa leather (code 801) for AMG Sport	399 ○ ○	958.33	1,150.00
Multi-function steering wheel – heated	Only in conjunction with Memory Package (code P64) and heated front seats (code 873) or comfort-ventilated front seats (code 401). Not available in conjunction with wood- and leather-trimmed steering wheel (code 289)	443 ○ ○	229.17	275.00
Panoramic glass sunroof with interior sun blind		413 ○ ○	1,529.17	1,835.00
Power closing front and rear doors		883 ○ ○	479.17	575.00
Rear seats – heated	Only in conjunction with heated front seats (code 873) or comfort-ventilated front seats (code 401)	872 ○ ○	295.83	355.00

Item	Notes		SE	AMG Sport	Basic RRP excl. VAT (£)	Total RRP incl. VAT (£)
Comfort (continued)						
Sun blinds – rear side windows		297	○	○	233.33	280.00
Sun visors – double for driver and front passenger		543	○	○	83.33	100.00
Through-loading facility Above rear armrest		282	○	○	166.67	200.00
Security and Safety						
Driving Assistance Package Active Blind Spot Assist, Active Lane-Keeping Assist and Distronic Plus with Pre-Safe® Brake	Only in conjunction with Mirror Package (code P49) for AMG Sport. Not in conjunction with Lane-Tracking Package (code 22P)	23P	○	○	1,958.33	2,350.00
Lane-Tracking Package Blind Spot Assist and Lane-Keeping Assist	Only in conjunction with Mirror Package (code P49) for AMG Sport. Not in conjunction with Driving Assistance Package (code 23P)	22P	○	○	654.17	785.00
Airbags – rear sidebags		293	○	○	295.83	355.00
Fire extinguisher		682	○	○	104.17	125.00
Night View Assist Plus	Only in conjunction with Intelligent Light System (code 621) and COMAND Online systems (code 512 or 527)	610	○	○	1,087.50	1,305.00
Tyre pressure monitoring system		475	○	○	266.67	320.00

Item	Notes	SE	AMG Sport	Basic RRP excl. VAT (£)	Total RRP incl. VAT (£)	
Communications and In-Car Entertainment						
Audio 20 with Media Interface and 6-disc CD changer Integrated CD changer (6-disc) with MP3 compatibility. Media Interface allows connection and control of portable media devices (e.g. MP3 player, USB storage media). Cable included for iPod® connectivity		510	○	○	454.17	545.00
COMAND Online system with Media Interface Includes radio, single CD/DVD, 7-inch colour display, hard disk drive (HDD) navigation with 3D map display, live traffic information and European map data updates free of charge for the first three years and Linguatronic voice control. Internet-enabled mobile phone required for Emergency Call System (eCall), Mercedes-Benz apps and in-car Internet access for Facebook, Internet radio, sending routes from Google™ maps to the vehicle, news and weather reports. Also includes SD memory card slot, 10 GB music register and MP3 compatibility. Media Interface allows connection and control of portable media devices (e.g. MP3 player, USB storage media). Cable included for iPod® connectivity	DVD function is audio and video capable. Region 2 DVDs only. Replaces Becker® Map Pilot navigation system. COMAND Online services are only available once a mobile phone is connected to the car via Bluetooth®. Please see www.mercedes-benz.com/connect for a list of compatible phones and functionality. Before attempting to connect to COMAND Online we would advise that you contact your mobile phone service provider to confirm your mobile phone profile and data charges for tethered Internet access	527	○	○	1,775.00	2,130.00
COMAND Online system with Media Interface and integrated 6-disc CD changer		512	○	○	2,037.50	2,445.00
DAB digital radio tuner	Only in conjunction with Audio 20 with 6-disc CD changer (code 510) or COMAND Online systems (codes 512 or 527)	537	○	○	358.33	430.00

Item	Notes		SE	AMG Sport	Basic RRP excl. VAT (£)	Total RRP incl. VAT (£)
Communications and In-Car Entertainment (continued)						
Rear seat entertainment system Two 8-inch screens mounted on the back of front head restraints, single DVD player, two sets of wireless headphones and remote control	TV reception available in conjunction with TV tuner (code 865)	864	○	○	1,695.83	2,035.00
SplitView for COMAND Online system Enables the COMAND Online system to display different content for driver and front passenger	Only in conjunction with COMAND Online systems (codes 512 or 527)	867	○	○	850.00	1,020.00
Surround sound system – Bang & Olufsen BeoSound AMG 14 high-performance speakers with twin illuminated tweeter lenses	Only in conjunction with Audio 20 with Media Interface (code 510) or COMAND Online systems (code 512 or 527). Not in conjunction with Harman Kardon® Logic 7® surround sound system (code 810). Please note that space-saver spare wheel is replaced by Tirefit	811	-	○	3,612.50	4,335.00
Surround sound system – Harman Kardon® Logic 7® with Dolby Digital 5.1 and DTS 14 high-performance speakers and additional amplifier	Only in conjunction with Audio 20 with 6-disc CD changer (code 510) or COMAND Online systems (code 512 or 527)	810	○	○	733.33	880.00
Telephone pre-wiring with hands-free facility A separate cradle for your mobile phone needs to be ordered as an accessory from your Retailer	Works in conjunction with the multi-function steering wheel and display. The phone cradle is mounted in the front centre armrest. It is recommended that a compatible handset is sourced prior to ordering a cradle	386	○	○	341.67	410.00
TV tuner – with digital reception capabilities	Only in conjunction with COMAND Online systems (code 512 or 527)	865	○	○	862.50	1,035.00

Item	Notes	SE	AMG Sport	Basic RRP excl. VAT (£)	Total RRP incl. VAT (£)
Service Package Service Care Service Care allows you to spread the cost of servicing your new car in the Mercedes-Benz Retailer network. Taking out a Service Care plan ensures your servicing needs are taken care of by fully trained Mercedes-Benz Technicians with the added benefit of a Mercedes-Benz service history	Price is based on a monthly rate. Example given is for two services taken over 24 months, three services over 36 months or four services over 48 months. Further payment options are available. New Service Care prices apply only to vehicles up to 12 months old prior to first service	<input type="checkbox"/>	<input type="checkbox"/>	23.20	29.00

Straight from the heart



Few names ignite the passions of a performance enthusiast like that of AMG. Through a long line of memorable racing successes and even more memorable road cars, AMG has won countless fans and earned a reputation for the very best in high-performance motoring.

It's a reputation the current AMG models can only enhance. With their breathtaking performance and excellent road manners, they make every journey an occasion to savour.

AMG standard equipment

Item

Transmission and Suspension

Active Curve System
AirMATIC air suspension
AMG Speedshift Plus 7G-Tronic 7-speed automatic transmission with Speedtronic cruise control
AMG sports suspension
ECO start/stop function
Permanent four-wheel drive

Exterior

AMG bodystyling with exclusive ML 63 AMG front and rear aprons, side skirts
AMG door sill panels in brushed stainless steel
AMG LED daytime running lights
AMG sports exhaust system with two chromed twin tailpipes
Ambient lighting on underside of door mirrors
Direct Steering
Door mirrors – electrically operated, heated, automatically dimming and folding
Easy-Pack powered tailgate – opens and closes automatically
Electric glass sunroof

Item

Front and rear apron trims, chrome style
Headlamps – Intelligent Light System Bi-xenon headlamps, Active Light System, automatic headlamp range adjustment, cornering light function, headlamp wash and Adaptive High Beam Assist
Heated windscreen wash system
LED rear tail lights
Parktronic with Active Park Assist
Privacy glass
Radiator grille with three chromed louvres
Rain-sensing wipers
Rear bumper with integrated reflectors
Rear screen wash/wiper
Roof rails – aluminium finish
Scratch guard on load compartment sill – chrome
Space-saver spare wheel – steel
Tinted glass – green
‘V8 BITURBO’ lettering on front wings

Item**Interior**

12V socket in load compartment and passenger compartment, front and rear
AMG brushed stainless steel sports pedals with rubber studs
AMG floor mats
AMG instrument cluster with animated start-up sequence and AMG main menu
AMG Performance steering wheel – 4-spoke multi-function, trimmed in nappa leather with perforated grip areas, flattened bottom section and silver-coloured gear shift paddles
AMG sports seats with leather upholstery
Automatically dimming rear-view mirror
Centre armrests – front (with storage) and rear
Cup holders – front (2) and rear (2)
Door centre panels in Artico leather ¹
Electric windows (4)
Front seats – full electric adjustment (backrest, height and longitude) and four-way electric lumbar adjustment
Front seats – heated
Load-securing rings (4)
Luggage compartment cover
Luxury automatic climate control Multi-zone function with separate air distribution settings for driver/front passenger and rear. Three different climate modes: Focused, Medium and Diffuse

Item

Outside temperature gauge
Reading lights, front and rear
Service indicator ASSYST
Split folding rear seats – 1/3: 2/3, with manual back adjustment
Steering column – manually adjustable for height and reach
Sun visors with illuminated vanity mirrors
Tyre pressure monitoring system

Paint, Trim and Upholstery

Dashboard – upper and lower sections, beltline and door panels in Artico leather ¹ with top-stitching
Paint – metallic
Trim – brushed light aluminium
Upholstery – leather

Security and Safety

Adaptive brake lights
AMG high-performance braking system
Airbags – driver and front passenger

¹Man-made leather

Item**Security and Safety (continued)**

 Airbags – front sidebags

 Airbags – windowbags

 Alarm system with immobiliser and interior protection (MBSS3)

 Anti-lock braking system (ABS) with Brake Assist (BAS)

 Attention Assist – monitors steering behaviour and can help to alert to long journey fatigue

 Automatic child seat recognition sensor

Works in conjunction with Mercedes-Benz child seats fitted with transponder

 Collision Prevention Assist

 Downhill Speed Regulation (DSR) with switch and variable speed control

 Electric parking brake

 Electronic Stability Programme (ESP®) with Acceleration Skid Control (ASR)

 ESP® Trailer Stability Assist

 First-aid kit and warning triangle

 Four-wheel Electronic Traction System (4ETS)

 Headlamp Assist – automatic headlamp activation

 High-level third brake light

 Hill Start Assist

 ISOFIX and top-tether child seat fixing points in rear (two outer seats)

 Manually adjustable head restraints – front and rear

Item

 Pre-Safe® anticipatory safety system

 Remote central locking

 Seat belt pre-tensioners and force limiters – front and outer rear seats

 Tyre pressure monitoring system

Communications and In-Car Entertainment

 Bluetooth® interface for hands free telephony

 Central controller dial to operate audio functions and telephone (when connected)

 COMAND Online system with Media Interface

Includes radio, single CD/DVD, 7-inch colour display, hard disk drive (HDD) navigation with 3D map display, live traffic information and European map data updates free of charge for the first three years and Linguatronic voice control. Internet-enabled mobile phone required for Emergency Call System (eCall), Mercedes-Benz apps and in-car Internet access for Facebook, Internet radio, sending routes from Google™ maps to the vehicle, news and weather reports. Also includes SD memory card slot, 10 GB music register and MP3 compatibility.

Media Interface allows connection and control of portable media devices (e.g. MP3 player, USB storage media). Cable included for iPod® connectivity

 DAB digital radio tuner

AMG optional equipment

Item	Notes		Basic RRP excl. VAT (£)	Total RRP incl. VAT (£)
AMG Performance Studio				
AMG Driver's Package Attendance at an AMG 'Power and Passion' driving event Increase in the electronically limited top speed		250	2,350.00	2,820.00
AMG Performance Package AMG Performance steering wheel (code 281) and red-painted brake calipers Power upgrade by 32 hp (24 kW)/60 Nm		P30	5,137.50	6,165.00
AMG carbon fibre engine cover		B14	1,275.00	1,530.00
AMG Performance steering wheel in Dinamica microfibre/nappa leather	Included with AMG Performance Package (code P30). Not in conjunction with wood- and leather-trimmed steering wheel (code 289) or <i>designo</i> wood- and leather-trimmed steering wheel (code Y95)	281	350.00	420.00
Suspension and Exterior				
Parking Package 360° camera Parktronic with Active Park Assist		P44	545.83	655.00
Reversing camera		218	350.00	420.00
Running boards – aluminium finish with rubber studs	Please note the lower colour-coded side trim is replaced with black trim	846	412.50	495.00
Tow bar, manually folding with electric release	When ordering this option, please discuss with your Retailer any specific towing requirements	550	791.67	950.00

Item	Notes	Basic RRP excl. VAT (£)	Total RRP incl. VAT (£)	
Paint, Trim and Upholstery				
<p><i>designo</i> Exclusive leather upholstery</p> <ul style="list-style-type: none"> Armrests in doors and centre console and handrest in chosen <i>designo</i> leather colour Dashboard and door beltlines trimmed in Black nappa leather Double sun visors (code 543) Floor mats with edging in <i>designo</i> Black leather and <i>designo</i> metal badges Roof lining in Black Dinamica microfibre Seat and door centre panels in chosen <i>designo</i> leather colour with AMG badges in front and rear seat backrests <p>Available in:</p> <ul style="list-style-type: none"> <i>designo</i> Marron X06 <i>designo</i> Black X11 <i>designo</i> Porcelain X27 	Based on Black leather (code 201). Only in conjunction with Memory Package (code P64)	1	3,787.50	4,545.00
<i>designo</i> trim in Black Piano Lacquer	Not in conjunction with wood- and leather-trimmed steering wheel (code 289)	W69	1,308.33	1,570.00
<i>designo</i> wood- and leather-trimmed steering wheel	Only in conjunction with <i>designo</i> trim in Black Piano Lacquer (code W69). Not in conjunction with wood- and leather-trimmed steering wheel (code 289), Almond Beige or Alpaca Grey upholstery (codes 205 and 208). Replaces AMG Performance steering wheel in Dinamica microfibre/nappa leather (code 281) when ordered with AMG Performance Package (code P30)	Y95	870.83	1,045.00

Item	Notes		Basic RRP excl. VAT (£)	Total RRP incl. VAT (£)
Paint, Trim and Upholstery (continued)				
Metallic paint – Diamond White		799	697.17	815.00
Roof lining in <i>designo</i> Black Dinamica microfibre	Only in conjunction with double sun visors (code 543). Not in conjunction with Almond Beige leather upholstery (code 205). Included with <i>designo</i> Exclusive leather upholstery (codes X06, X11 or X27)	Y41	1,362.50	1,635.00
Roof lining in <i>designo</i> Black fabric	Not in conjunction with Almond Beige leather upholstery (code 205)	Y90	308.33	370.00
Trim – Anthracite Poplar wood, gloss		729	316.67	380.00
Trim – Brown Burr Walnut wood, gloss		731	316.67	380.00
Trim – Brown Eucalyptus wood, gloss		734	175.00	210.00
Trim – Brown Open-pore Ash wood		H09	316.67	380.00
Upholstery – two-tone leather		-	220.83	265.00
Wood- and leather-trimmed steering wheel	Only in conjunction with wood trim (codes 729, 731, 734 or H09)	289	512.50	615.00
Comfort				
Memory Package Front seats, front head restraints, steering column and exterior door mirrors – electrically adjustable with memory		P64	775.00	930.00
Ambient lighting – choice of three colour settings		876	304.17	365.00

Item	Notes		Basic RRP excl. VAT (£)	Total RRP incl. VAT (£)
Comfort (continued)				
Ashtrays and cigarette lighter	Replace storage compartments in front and rear and 12V socket in front	301	41.67	50.00
Cup holder – temperature-controlled	Not in conjunction with Keyless-Go (code 889)	311	183.33	220.00
Easy-Pack load-securing kit		942	258.33	310.00
Front seats – comfort-ventilated	Leather on front seats is perforated when this option is chosen. Only in conjunction with Memory Package (code P64)	401	625.00	750.00
Garage door opener – integrated in rear-view mirror For questions regarding compatibility please call the Homelink Hotline, Johnson Controls – freephone (0)0800 046 635 465 – or visit www.homelink.com		231	191.67	230.00
Keyless-Go Includes door handles with chrome inlay		889	775.00	930.00
Luggage compartment cover, including safety net		541	145.83	175.00
Multi-contour front seats Massage function, luxury head restraints and seat cushion depth adjustment	Only in conjunction with Memory Package (code P64)	399	958.33	1,150.00
Panoramic glass sunroof with interior sun blind		413	516.67	620.00
Power closing front and rear doors		883	479.17	575.00
Rear seats – heated		872	295.83	355.00
Sun blinds – rear side windows		297	233.33	280.00
Sun visors – double, for driver and front passenger		543	83.33	100.00
Through-loading facility Above rear armrest		282	166.67	200.00

Item	Notes		Basic RRP excl. VAT (£)	Total RRP incl. VAT (£)
Security and Safety				
Driving Assistance Package Active Blind Spot Assist, Active Lane-Keeping Assist and DISTRONIC Plus with Pre-Safe® Brake	Not in conjunction with Lane-Tracking Package (code 22P)	23P	1,958.33	2,350.00
Lane-Tracking Package Blind Spot Assist and Lane-Keeping Assist	Not in conjunction with Driving Assistance Package (code 23P)	22P	654.17	785.00
Airbags – rear sidebags		293	295.83	355.00
Fire extinguisher		682	104.17	125.00
Night View Assist Plus Pedestrian detection system		610	1,087.50	1,305.00
Communications and In-Car Entertainment				
COMAND Online system with integrated 6-disc changer		512	262.50	315.00
Rear seat entertainment system Two 8-inch screens mounted on the back of front head restraints, single DVD player, two sets of wireless headphones and remote control	TV reception available in conjunction with TV tuner (code 865)	864	1,695.83	2,035.00
SplitView for COMAND Online system Enables the COMAND Online system to display different content for driver and front passenger		867	850.00	1,020.00

Item	Notes		Basic RRP excl. VAT (£)	Total RRP incl. VAT (£)
Communications and In-Car Entertainment (continued)				
Surround sound system – Bang & Olufsen BeoSound AMG 14 high-performance speakers with twin illuminated tweeter lenses	Only in conjunction with Audio 20 with Media Interface (code 510) or COMAND Online systems (codes 512 or 527). Not in conjunction with Harman Kardon® Logic 7® surround sound system (code 810). Please note that space-saver spare wheel is replaced by Tirefit	118 810	3,612.50	4,335.00
Surround sound system – Harman Kardon® Logic 7® with Dolby Digital 5.1 and DTS 14 high-performance speakers and additional amplifier		810	733.33	880.00
Telephone pre-wiring with hands-free facility A separate cradle for your mobile phone needs to be ordered as an accessory from your Retailer	Works in conjunction with the multi-function steering wheel and display. The phone cradle is mounted in the front centre armrest. It is recommended that a compatible handset is sourced prior to ordering a cradle	386 986	341.67	410.00
TV tuner – with digital reception capabilities		965	862.50	1,035.00
Service Package				
Service Care Service Care allows you to spread the cost of servicing your new car in the Mercedes-Benz Retailer network. Taking out a Service Care plan ensures your servicing needs are taken care of by fully trained Mercedes-Benz Technicians with the added benefit of a Mercedes-Benz service history	Price is based on a monthly rate. Example given is for two services taken over 24 months, three services over 36 months or four services over 48 months. Further payment options are available. New Service Care prices apply only to vehicles up to 12 months old prior to first service	1	37.50	45.00

Colours and materials

Metallic paints



151 Cinnabar Red

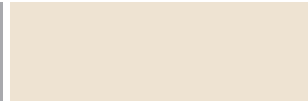

775 Iridium Silver

799 Diamond White¹

197 Obsidian Black



792 Palladium Silver



890 Cavansite Blue



755 Tenorite Grey



796 Citrine Brown



988 Diamond Silver

Non-metallic paint²

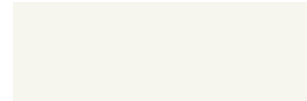

149 Polar White

Artico leather¹
(standard SE)

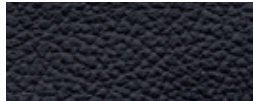

101 Black



105 Almond Beige



108 Alpaca Grey

**Artico leather¹/Dinamica
microfibre** (std AMG Sport)



601 Black

Leather
(optional; standard ML 63 AMG)

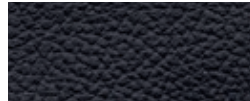
201 Black²205 Almond Beige²208 Alpaca Grey²

Two-tone leather
(opt. AMG Sport/ML 63 AMG)

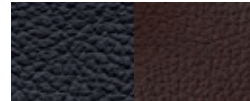
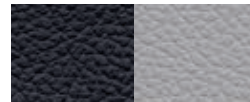
254 Black/Tobacco Brown²255 Black/Almond Beige²258 Black/Alpaca Grey²

Nappa leather
(optional AMG Sport)

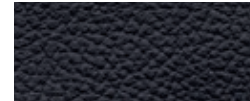

801 Black

Trim

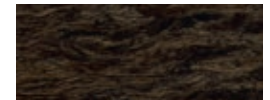

739 Brushed light aluminium

729 Black Poplar wood^{3,4}731 Brown Burr Walnut wood^{3,4}734 Brown Eucalyptus wood^{3,4}H09 Brown Open-pore
Ash wood³

¹Man-made leather

²When choosing optional leather upholstery for the AMG Sport, the interior differs from the standard specification AMG Sport interior. The four-spoke steering wheel, seats and door centre panels are in a different design; the sports pedals are replaced and the "Mercedes-Benz"-badged floor mats removed. The exception to this is if Black nappa leather (code 801) is selected, in which case the AMG Sport interior remains unchanged

³Optional ⁴Gloss finish

Trim and upholstery combinations

	Artico leather ¹ / Dinamica ²	Artico leather ¹ /leather			Two-tone leather			Leather/ nappa leather
	Std on AMG Sport	Std on SE/std on ML 63 AMG, optional on SE and AMG Sport			Optional on AMG Sport and ML 63 AMG			Opt. AMG Sport only
	Black (601)	Black (101/201)	Almond Beige (105/205)	Alpaca Grey (108/208)	Black/ Tobacco Brown (254)	Black/ Almond Beige (255)	Black/ Alpaca Grey (258)	Black (801)
Dashboard								
Steering wheel	Black	Black	Mocha Brown	Dark Basalt Grey	Black	Black	Black	Black
Upper dashboard trim	Black	Black	Mocha Brown	Dark Basalt Grey	Black	Black	Black	Black
Lower dashboard trim	Black	Black	Almond Beige	Alpaca Grey	Black	Black	Black	Black
Seats								
Seat cushion centre section	Black	Black	Almond Beige	Alpaca Grey	Tobacco Brown	Almond Beige	Alpaca Grey	Black
Side bolster trim	Black	Black	Almond Beige	Alpaca Grey	Marron	Almond Beige	Alpaca Grey	Black
Head restraint	Black	Black	Almond Beige	Alpaca Grey	Marron	Almond Beige	Alpaca Grey	Black
Seat belt	Black	Black	Almond Beige	Alpaca Grey	Black	Black	Black	Black
Doors								
Beltline door trim	Black	Black	Almond Beige	Alpaca Grey	Black	Black	Black	Black
Centreline door trim	Black	Black	Almond Beige	Alpaca Grey	Marron	Almond Beige	Alpaca Grey	Black
Lower door trim	Black	Black	Almond Beige	Alpaca Grey	Black	Black	Black	Black
Roof lining	Alpaca Grey	Alpaca Grey	Almond Beige	Alpaca Grey	Black	Black	Black	Alpaca Grey
Floor covering								
Front and rear	Black	Black	Almond Beige	Dark Basalt Grey	Black	Black	Black	Black
Boot	Black	Black	Almond Beige	Dark Basalt Grey	Black	Black	Black	Black

¹Man-made leather ²Dinamica microfibre

Combination options

		Metallic paints									Non-metallic paint										
		151	Cinnabar Red	197	Obsidian Black	755	Tenorite Grey	775	Iridium Silver	792	Palladium Silver	796	Citrine Brown	799	Diamond White	890	Cavansite Blue	988	Diamond Silver	149	Polar White
Artico leather¹/Dinamica microfibre	Black	●	●	●	●	●	●	●	●	●	●	●	●	●	●	●	●	●	●	●	●
Artico leather¹/leather	Black	●	●	●	●	●	●	●	●	●	●	●	●	●	●	●	●	●	●	●	●
	Alpaca Grey	●	●	●	●	●	●	○	●	●	●	●	●	●	●	●	●	●	●	●	●
	Almond Beige	●	●	○	○	●	●	●	●	○	○	●	○	○	●	○	○	●	●	●	●
Two-tone leather	Black/Alpaca Grey	●	●	●	●	●	●	○	●	●	●	●	●	●	●	●	●	●	●	●	●
	Black/Almond Beige	●	●	●	●	●	●	●	●	●	●	●	●	●	●	●	●	●	●	●	●
	Black/Tobacco Brown	○	●	●	●	●	●	●	●	●	●	●	●	●	●	●	●	●	●	●	●
Leather/nappa leather	Black	●	●	●	●	●	●	●	●	●	●	●	●	●	●	●	●	●	●	●	●

● Recommended ○ Possible Please note that, owing to limitations of the printing process, paint colours may differ from those shown

Technical specifications

Model	Diesel engines		Petrol engine	
	ML 250 BlueTEC	ML 350 BlueTEC	ML 63 AMG	
Engine				
Capacity	cc	2,143	2,987	5,461
Arrangement/cylinders/valves		in-line/4/16	V/6/24	V/8/32
Power ¹	hp (kW) at rpm	204 (150)/4,200	258 (190)/3,600	525 (386)/5,250-5,750 [557 (410)/5,250-5,750 ²]
Torque ¹	Nm at rpm	500/1,600-1,800	620/1,600-2,400	700/1,750-5,000 [760/2,000-5,000 ²]
Transmission				
7G-Tronic Plus 7-speed auto.		●	●	-
AMG Speedshift Plus 7G-Tronic 7-speed auto.		-	-	●
Performance				
		auto.	auto.	auto.
Acceleration 0-62 mph	sec	9.0	7.4	4.8 [4.7 ²]
Top speed	mph	130	139	155 ³ [174 ⁴]

Model	Diesel engines		Petrol engine
	ML 250 BlueTEC	ML 350 BlueTEC	ML 63 AMG
Weights and capacities	auto.	auto.	auto.
Kerb weight	kg 2,150	2,175	2,345
Perm. Gross Vehicle Weight	kg 2,950	2,950	3,050
Towing capacity - unbraked	750	750	750
braked	kg 2,950	3,500	3,050
Boot capacity	l		
max. behind 1st row of seats	2,010	2,010	2,010
max. behind 2nd row of seats	690	690	690
Fuel tank capacity/of which reserve	l 70/11	70/11	93/14
Turning circle	m 11.80	11.80	11.80
Fuel consumption^{5,6}	mpg	auto.	auto.
Urban	40.4	34.4	18.0
Extra-urban ⁷	50.4	42.2	29.4
Combined	46.3	39.2	23.9

Model	Diesel engines		Petrol engine
	ML 250 BlueTEC	ML 350 BlueTEC	ML 63 AMG
CO₂ emissions⁶	g/km	auto.	auto.
Emissions standard	EU6	EU6	EU5
17" alloy wheels (code 25R)	154	179	-
19" alloy wheels (codes R39/R53)	160	189	-
19" AMG alloy wheels (code 780)	160	189	-
20" alloy wheels (code R33)	163	194	-
20" AMG alloy wheels (code 758)	163	194	-
20" AMG alloy wheels (code 778)	-	-	276
21" AMG alloy wheels (code 757)	170	194	-
21" AMG alloy wheels (code 798)	-	-	276
21" AMG alloy wheels (code 685)	-	-	276
Insurance			
Group rating	38E	43A	50A
Insurance ratings may vary depending on model line and specification. Please refer to http://www.thatcham.org/abigrouprating/ for further details			

¹Figures according to Directive 80/1269/EEC in the currently applicable version ²In conjunction with AMG Performance Package ³Electronically limited ⁴In conjunction with AMG Driver's Package

⁵All figures are based on a standard specification with the smallest tyre size ⁶The choice of wheels and transmission may affect CO₂ emissions and corresponding Road Fund Licence

⁷EUDC: extra-urban driving cycle. Testing procedures adhere to EU Directive 93/116

The figures on pages 44–47 are correct at time of going to print. Please refer to the government website for latest data - <http://www.dft.gov.uk/vca>

All measurements in millimetres. The dimensions shown are mean values and apply to standard-specification, unladen vehicles

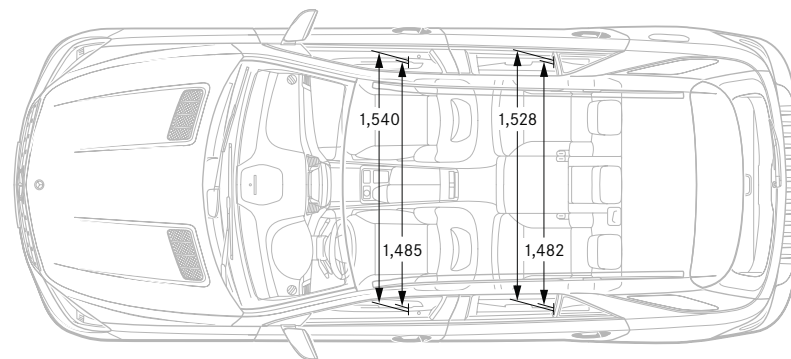
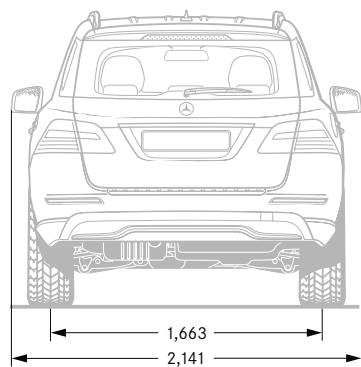
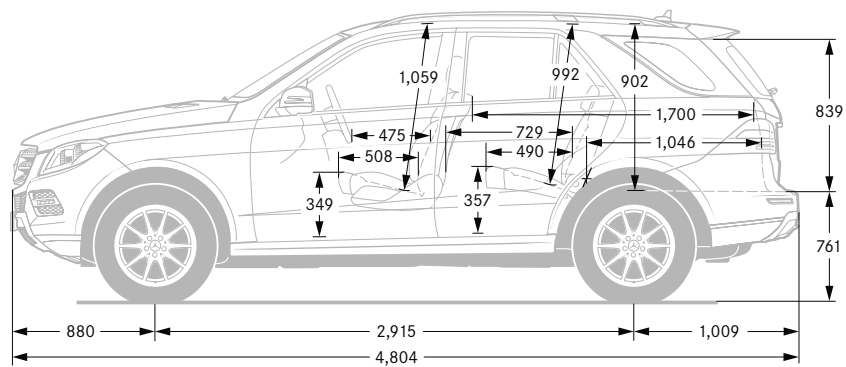
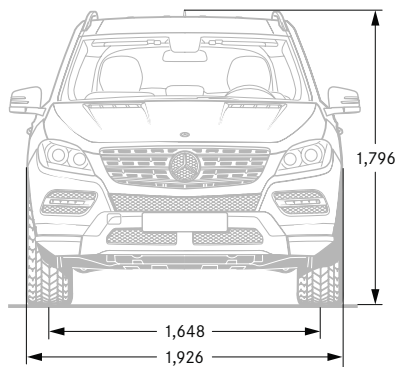

Road Fund Licence



All road vehicle registrations are subject to Vehicle Excise Duty (Road Fund Licence), which varies in accordance with the vehicle's CO₂ emissions. A first year rate of Vehicle Excise Duty applies to new cars on their first year of registration. For the second and subsequent years a standard rate for each taxation band will apply.¹ The table below shows the bands (A-M) created by the DVLA and the corresponding Road Fund Licence. CO₂ emissions are listed in the technical specifications on page 46, and the relevant Excise Duty is reflected in the on-the-road prices on page 5.

Band	CO ₂ emissions	First year rate (£)	Standard rate (£)
A	up to 100 g/km	0.00	0.00
B	101 to 110 g/km	0.00	20.00
C	111 to 120 g/km	0.00	30.00
D	121 to 130 g/km	0.00	110.00
E	131 to 140 g/km	130.00	130.00
F	141 to 150 g/km	145.00	145.00
G	151 to 165 g/km	180.00	180.00
H	166 to 175 g/km	290.00	205.00
I	176 to 185 g/km	345.00	225.00
J	186 to 200 g/km	485.00	265.00
K	201 to 225 g/km	635.00	285.00
L	226 to 255 g/km	860.00	485.00
M	over 255 g/km	1,090.00	500.00

¹For further information on vehicle taxation please refer to <https://www.gov.uk/calculate-vehicle-tax-rates>

Services and benefits

Mercedes-Benz Service Care

We believe that servicing costs should be as flexible and affordable as possible for your M-Class, which is why we offer Service Care, an easy way to budget for all your servicing costs. It spreads your bills into manageable payments based on whether you have a new or used Mercedes-Benz.

With Service Care we guarantee the price of parts and labour for up to four services and safeguard against further inflation. It also covers the cost of all recommended service items including brake fluid, spark plugs, air filters, fuel filters and screen wash.

You can choose either to add your servicing costs into your monthly spend or pay the full amount in a one-off payment, giving you peace of mind that they are taken care of for the period of the plan.

To find out more please contact your local Retailer or visit www.mercedes-benz.co.uk/servicecare

Warranty and breakdown cover

Every Mercedes-Benz comes with a three-year unlimited mileage warranty against manufacturing or material defects¹ and up to 30 years warranty against perforation due to corrosion from the inside out.² What's more, it's also covered by Mercedes-Benz Mobilo Roadside Assistance – a unique package comprising up to 30 years pan-European breakdown assistance.²

Mercedes-Benz Finance and Insurance

Choosing the colour of your Mercedes-Benz can be difficult. Fortunately, financing it isn't

So you've chosen your new Mercedes-Benz and you've finally settled on a colour. The good news is you've done the hard part. Now simply sit down with one of our Business Managers and they'll be happy to guide you through our range of finance packages, service options and insurance cover.

At Mercedes-Benz Finance, we're not in the business of simply providing a loan to fund the purchase of your dream car. We look on it as a journey that we take with you, from the moment you choose your new Mercedes-Benz, to helping you in choosing your next one.

You should find our finance packages are more convenient than a traditional personal loan. They are:

- **Quick and easy to arrange.** On average, approved credit applications are processed within 18 minutes.¹
- **Immediately available.** With no waiting for cheques or loans to clear.
- **No security on your home required.** You will not be required to provide us with any security against your house as a condition of taking out the finance agreement.

- **Clear and transparent.** Other lenders may offer you a higher APR to the one you applied for based on your credit status. With Mercedes-Benz Finance, where we advertise an APR this is the APR you will receive if your credit application is successful.

- **Guarantee the future value of your car.** Our Personal Contract Purchase plan, Mercedes-Benz Agility, features a future guaranteed value, which provides you with protection against the risk of depreciation and also makes your payments more affordable.

¹Based on all credit applications received January–November 2012

Dedicated Business Managers: finding the right package for you

Our Business Managers are experts in all aspects of vehicle finance. They will talk you through the options, advise you as to which one might suit you best and help you to make the right decision. What's more, they have access to systems and support that will enable quotations and comparisons to be prepared for you in minutes.

Above all, we want you to be reassured that your Business Manager will be there with you every step of the way: discussing your requirements, making suggestions and outlining the options available.

Mercedes-Benz Agility

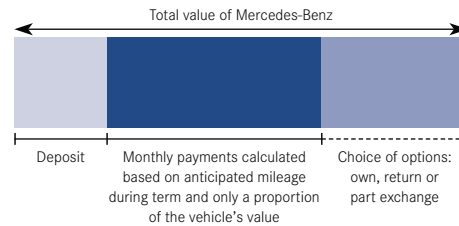

Mercedes-Benz Hire Purchase

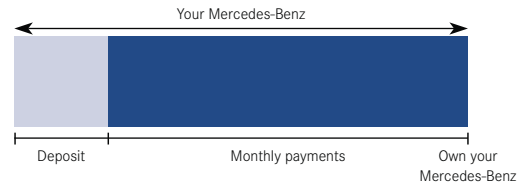

Mercedes-Benz Operating Lease

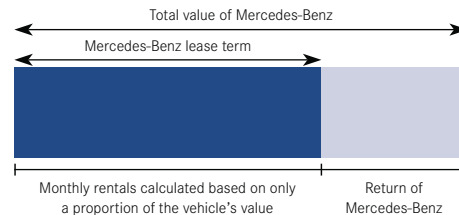

Insurance

Since our name is synonymous with reliability, who better to trust with your motor insurance? Mercedes-Benz Insurance provides a motor insurance policy specifically designed to give you the cover you would expect from Mercedes-Benz.

For a motor insurance quotation, call

0845 600 2180*

*For joint protection, calls may be recorded and/or monitored. All calls charged at local rate. We may decline to quote in some circumstances

For further information on Mercedes-Benz Finance, please contact your local Mercedes-Benz Retailer.

Mercedes-Benz Motor Insurance is underwritten by Aviva Insurance UK Limited. Credit provided, subject to status, by Mercedes-Benz Financial Services UK Ltd, MK15 8BA

Prices effective from 1 April 2014. Information correct at time of going to print.
Prices and specifications are subject to change without prior notice.
MBW166PL/0414

Mercedes-Benz UK Ltd, Tongwell, Milton Keynes, MK15 8BA www.mercedes-benz.co.uk



Mixed Sources

Product group from well-managed forests, controlled sources and recycled wood or fibre
www.fsc.org Cert no. SGS-COC-004556
©1996 Forest Stewardship Council

