

JANUARY 2014

# Amarok



Commercial  
Vehicles

## Startline, Trendline and Highline

Trims packed with style and technology

## Truly versatile

Great for work and play

## Cut your fuel bills

BlueMotion Technology on certain models

## Strength to perform

The versatile pick-up that is  
sure-footed on any terrain





# Volkswagen Amarok: for when the going gets tough



BORN IN THE mountains of South America, the Amarok is a pick-up unlike any other. It's every inch a true off-roader – a rugged workhorse for work or play. But, with car-like driving comfort and a refined interior, the Amarok redefines expectations of a modern pick-up.

The 2.0-litre TDI turbo diesel comes in either 140PS or twin-turbo 180PS for impressive off-road, cargo-carrying and load-hauling capabilities. The comfortable interior and convenience of an optional eight-speed automatic gearbox mean it's as comfortable in town as it is off-road.

Now, with the addition of BlueMotion Technology on selected Highline models, the Amarok is also more economical. No wonder it's loved by drivers and the media alike, winning 'Pick-Up of the Year' awards from *What Van?*, *4x4 Magazine* and *Auto Express*.



## Contents

All of your Amarok questions answered

- What is it like to drive? > p6
- What engines are available? > p10
- Which trimline is right for me? > p14
- How much will my Amarok cost? > p20
- What options can I choose? > p28
- What Add Ons are available? > p38
- What are the key facts and figures? > p46
- What support can I expect? > p50

CONTACT US ON:

0800 717 131

www.volkswagen-vans.co.uk

GET CONNECTED:

@Volkswagen\_CV

VolkswagenCommercialVehiclesUK

vwcommercialvehicles



# Expect the extraordinary

Thanks to innovative technology and clever design features, the Amarok is a pick-up that is much more than the sum of its parts

## 4x4 heritage

From its first four-wheel-drive model in 1983 to the advanced 4MOTION® system used across the van range, Volkswagen Commercial Vehicles has a long heritage of four-wheel-drive vehicles.



## The right drive

The Amarok takes four-wheel-drive to a whole new level, with Permanent 4MOTION® for optimal off-road performance or Selectable 4MOTION® for better economy on paved roads.



## True off-roader

The Amarok is a real off-roader. With an approach angle of 28°, an exit angle of 23° and wading depth of up to 500mm, the Amarok can tackle steep hills and small fords. It can even handle roads with a lateral tilt of 50°.



## Ready for work

A ladder-frame chassis means that the Amarok is great off-road, and great for work and play, too. It's able to hold a Euro pallet between the wheel arches, and has a maximum payload of 1,145kg and towing capacity of up to 3,200kg.



## BlueMotion Technology

Volkswagen's fuel-saving BlueMotion Technology is available on the Amarok Highline. That means you still get 180PS and 400Nm of torque, but up to 37.2mpg (combined) fuel economy and CO<sub>2</sub> emissions of 199g/km.



## Safe and sound

The Amarok includes a number of advanced systems that improve both off-road performance and safety. These include an Electronic Stabilisation Programme, Hill Hold Assist, Hill Descent Control, off-road ABS and Trailer Stability Control.







# Rugged or refined: whatever you need

Whether it's cruising on paved surfaces or heading off-road, the Amarok is equipped to deliver the performance for all environments and terrains

**H**oned on South America's rough mountain terrain, it's no surprise that the Amarok is such a formidable off-roader. With its powerful 2.0-litre TDI engines and the dynamic all-terrain benefits of the intelligent 4MOTION® four-wheel-drive, it will take you anywhere you need to go. On-road performance is just as composed, thanks to the Amarok's refined ride.

## Dependable four-wheel drive

At the heart of the Amarok's off-road performance is Volkswagen's advanced 4MOTION® system, which helps maintain optimum traction on all road surfaces. Even when the going gets extreme, the Amarok is more than up to the challenge – wading small fords, handling steep inclines and uneven terrain – all without compromising its load-carrying capacity.

The 140PS turbo-diesel and 180PS biturbo-diesel engines have a six-speed manual gearbox as standard, with the option of an innovative eight-speed automatic on the 180PS Highline 4MOTION® Permanent.

## Sure-footed on any terrain

Designed to tackle the toughest off-road terrains, the Amarok has an Electronic Stabilisation Programme (ESP) fitted as standard – part of an impressive range of safety features, which include on- and off-road anti-lock braking systems, an Electronic Differential Lock, and Trailer Stability Control.

The Amarok's Hill Hold Assist keeps it stationary on steep inclines when pulling away, while Hill Descent Control regulates engine speed and applies the brakes if necessary, so that you can drive down slopes in a safe and controlled way.



Volkswagen's 4MOTION® four-wheel-drive system is at the heart of the Amarok's off-road performance

## Driving tech explained

### 4MOTION

#### Permanent

4MOTION® Permanent is great for convenient off-roading. It keeps the four-wheel-drive system engaged whether you're on- or off-road, so that power is always sent to the wheels with the most grip. It's available on the Amarok Highline – the manual model comes with the standard leaf-spring suspension. The automatic has the heavy-duty leaf suspension system.

#### Selectable

4MOTION® Selectable is ideal for rugged off-roading. It lets you switch between high- or low-range four-wheel drive for more extreme conditions. There's also a two-wheel-drive option for a more fuel-efficient performance. Available on all Amaroks, it comes with heavy-duty leaf-spring suspension for handling heavy loads.



# Feel at home in the wild

Comfortable and packed with features – the Amarok has an interior that sets it apart from the pack

**F**rom the outside, the Amarok is as rugged and tough as it is stylish. It's also built to last inside, with all the comfort and feature-packed functionality you'd expect from a Volkswagen. The three-seat rear bench means there's room for five people, too.

## Car-like comfort

The premium look and feel of the Amarok interior and the clear, functional design of the dashboard set new standards in this class. You'll think you're behind the wheel of a passenger car. The ergonomic front seats also offer lots of comfortable support, with plenty of head- and leg-room for passengers, front and rear.

## Feature-packed as standard

The Amarok Startline features electric windows, Climatic air-conditioning and driver and front passenger airbags. Upgrade to Trendline and Highline for even more style and comfort. You can choose factory-fitted options, as well as Add On accessories that you can buy and fit at any time. So, whether you're after leather seats, upgraded audio or sat-nav systems, there's something for you.



The premium look and feel of the Amarok interior sets new standards in its class

## Tough, clear dashboard

All the controls are easy to use, so you stay focused on the road. The dash is as tough as you'd expect for a pick-up, but it looks and feels a cut above the rest.

## Comfy seats

Our supportive seats come in a choice of attractive, hard-wearing fabrics and leather.



## Cool and comfortable

Air-conditioning is fitted as standard to help keep you cool. On Trendline and Highline models, the system is fully automatic, too.

## Entertainment and sat-nav

All Amaroks have the RCD 210 or RCD 310 radio/CD player fitted as standard. You can also add satellite-navigation. Both the RNS 315 and RNS 510 have maps for western Europe on internal flash memory.

## Three-spoke steering wheel

The three-spoke steering wheel is designed to be comfortable and easy to use on- or off-road. Fitting a multi-function steering wheel lets you control the audio system without taking your hands off the wheel.



# An easy-to-load, spacious cargo area

THE AMAROK HAS the widest load area in its class – 1.22m between wheel arches, which is enough to fit a Euro pallet sideways. With a total load area of 2.52m<sup>2</sup> and payloads up to 1,145kg, the Amarok is a hugely practical workhorse. The low sill height makes loading easy, while the load compartment light means you can work in the dark.

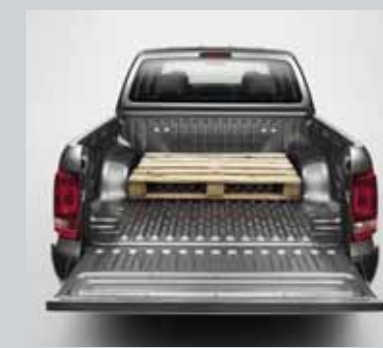



# Engines

Technology that helps to cut fuel bills and lower emissions



## Refined power at the ready

With two powerfully efficient 2.0-litre turbo-diesel engines, you can tackle any terrain while keeping your fuel bills low

**T**he Amarok comes with a choice of two 2.0-litre TDI engines – a 140PS unit and a twin-turbo 180PS BiTDI engine. Both produce plenty of power to cope with the heaviest of loads, as well as the toughest off-road terrain, yet both also remain refined and economical.

### Powerful contender

The 140PS engine produces 340Nm of torque, while delivering up to 36.2mpg (combined). If you need more power, the 180PS twin-turbo engine delivers up to 400Nm of torque – a match for rivals with much larger-capacity engines. That's enough punch to

haul payloads up to 1,145kg with a towing capacity of up to 3,200kg. It's all delivered through either a six-speed manual or an eight-speed automatic gearbox.

### Economical thinking

You can boost fuel efficiency even further on the 180PS Permanent 4MOTION® Highline model by picking the BlueMotion Technology option. This uses start/stop, brake energy recuperation, low-rolling-resistance tyres and cruise control to cut fuel consumption to 37.2mpg (combined) and CO<sub>2</sub> emissions to 199g/km. Turn the page to learn more.



## Tips to save you even more fuel

### Add a sat-nav

A sat-nav system can plot shorter routes and prevent you making wrong turns – some can even navigate around traffic jams. It all helps cut fuel consumption.

### Travel light

Your Amarok can carry a lot of cargo, but you shouldn't just use it as a mobile storage unit. Reducing a vehicle's payload is one of the easiest ways to improve its fuel economy.

### Use your Amarok's gearshift indicator

A gearshift indicator is fitted to all Amaroks. It helps you change gear at the most efficient times, which cuts fuel use and lowers emissions even further.

### Check your tyres

Up to 20% of a vehicle's fuel consumption is used in overcoming the tyres' rolling resistance. It's even more if your tyres are underinflated. So, check them regularly.



# More miles, less impact

BlueMotion Technology lowers your fuel costs and CO<sub>2</sub> emissions. It's now available on the Amarok Highline

**A**t Volkswagen, we're as keen as you are to reduce the amount of fuel our vehicles use and the emissions they produce. We're aware that fuel costs are a big burden for every driver, so improving our vehicles' efficiency only helps to deliver

even better value to you. That's why we've introduced BlueMotion Technology to the Amarok range.

### The power of technology

All Volkswagens that carry the BlueMotion Technology badge include our energy-saving solutions – start/stop, low-rolling-resistance tyres, energy recuperation and cruise control – as standard. Together, they create

improved fuel economy and lower CO<sub>2</sub> emissions. The benefit is money – and time – saved at the pumps.

### One engine, all the options

BlueMotion Technology is available on the 2.0BiTDI 180PS 4MOTION® Permanent Highline. It delivers combined fuel economy of 37.2mpg and cuts carbon dioxide emissions to 199g/km on the manual model. The good news is, the savings come without compromise, as you can add almost any of the factory-fit options that you need – your Van Centre can help you choose the best ones for you.



## How BlueMotion Technology works to lower your fuel bills and CO<sub>2</sub> emissions

BlueMotion Technology is available as an engine option on selected Amarok Highline models, and is made up of four elements. Together, they create significant cuts in fuel consumption and CO<sub>2</sub> emissions, which keeps money in your pocket and reduces the impact on the world around us.

### Cruise control

By keeping your van at a constant speed, cruise control saves fuel that would normally be wasted when your speed fluctuates. It's especially useful for driving over long stretches, because it stops your speed creeping up unintentionally and reduces driver stress.



### Low-rolling-resistance tyres

Fitting tyres with low rolling resistance means that the engine doesn't have to work as hard to get your van moving – or keep it moving. It all helps to save fuel and reduce carbon emissions.



### Start/stop

Start/stop allows you to save fuel at traffic lights. When you stop, put your van in neutral, release the clutch and the engine automatically switches off, saving fuel and reducing emissions. When you're ready to go, depress the clutch and the engine starts up again.

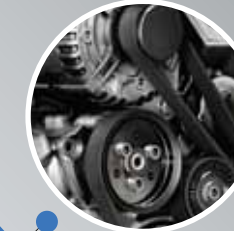

### Regenerative braking

When braking, energy during deceleration is wasted. Our energy recuperation system uses some of that momentum to turn the alternator and charge the battery. If the battery is well-charged, the engine has to do less work turning the alternator to keep it topped up. This cuts fuel use and emissions.

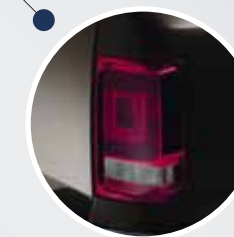



# Trimlines

Choose the level of style and features that suits you



Startline

## Ready for any challenge, any time

The Amarok Startline has a generous level of standard features that deliver practicality, performance and comfort

**T**he Amarok is a rare thing among pick-ups: it's practical and robust enough to handle the toughest terrains and loads, yet has a stylish look and road-car refinement for everyday driving.

With 16" alloy wheels and a body-coloured front bumper, the Amarok Startline looks the part. It acts the part, too, thanks to a class-leading load area and standard-fit Electronic Stabilisation Programme (ESP). This clever safety system automatically adjusts to the load conditions and incorporates a host of driver aids, such as Hill Hold Assist and Trailer Stability Control.

### Quality as standard

The Amarok Startline's interior sets it apart from its rivals. Well designed and comfortable, it's got the reassuring build quality you'd expect from Volkswagen.

Startline models have Climatic air-conditioning, front and rear electric windows, six airbags and an RCD 210 radio with a single CD player. Other thoughtful touches include a useful 12V socket in the centre console.



The Amarok Startline comes with electric windows in the front and rear as standard (above), as well as a body-coloured front bumper (right)

### Robust and refined

With rubber flooring, solid build quality and large storage areas in the doors, the Startline's cab is tough and versatile enough for a hard day's work. In the rear, all three passengers benefit from individual headrests and curtain airbags, while the rear seats can also be folded in part, or together, to create more space.



### Startline features



- ✓ 4MOTION® Selectable
- ✓ 16" Taruma alloy wheels (above)
- ✓ Body-coloured front bumper
- ✓ RCD 210 radio/CD player with aux-in (below)
- ✓ Climatic semi-automatic air-conditioning system
- ✓ Electric windows
- ✓ Electrically adjustable, heated door mirrors
- ✓ Driver and passenger airbags, with side curtain airbags
- ✓ 12V socket in centre console
- ✓ Four load-lashing rings
- ✓ Electronic Stabilisation Programme (ESP)
- ✓ Hill Hold Assist
- ✓ Hill Descent Control
- ✓ Remote central locking
- ✓ Thatcham Category 1 alarm and immobiliser





Trendline

# Look cool, feel cool – all the time

The Amarok Trendline turns heads, and adds cab comfort features such as automatic air-conditioning and cruise control

The Amarok Trendline takes the Startline's great looks and comfortable, feature-packed interior, and adds even more for good measure. On the outside, 17" Aldo alloy wheels, body-coloured door mirrors, extended wheel arches, a front bumper with



Trendline models are equipped with 17" Aldo alloy wheels, and extended wheel arches

chrome detailing and front fog lights all bolster the Amarok's bold, purposeful look.

### Make driving a breeze

At the wheel, cruise control helps to make journeys relaxing and a trip computer keeps you informed, while the addition of automatic, Climatronic two-zone air-conditioning keeps you and your passengers perfectly chilled. The excellent six-speaker RCD 310 CD/radio player keeps everyone entertained, too.

### Cab kit that's there to suit you

The Trendline interior has Trail cloth upholstery with a leather-trimmed steering wheel, gear knob and handbrake. The neat, functional layout is enhanced with a silver inlay on the gear lever console and door handles, and there's a front centre armrest, too.

Practical touches include two multi-use dash mounts for attaching cup- or pen-holders. You'll also find storage drawers under the seats, 12V sockets in the dash, centre console and load bay, and a passenger grab handle.



### Cruise control

Cruise control is fitted as standard on Trendline and Highline models. By keeping your Amarok at a constant speed, it reduces driver stress and helps to keep your fuel bills low – especially on long trips.



### Stay refreshed

The Climatronic air-con system (with two-zone temperature adjustment) automatically sets and regulates the interior temperature, so you're comfortable whatever the conditions outside.



### Trendline features

(In addition to Startline)



- ✓ 17" Aldo alloy wheels
- ✓ Body-coloured door mirrors, handles and wheel arch extensions
- ✓ Front fog lights
- ✓ RCD 310 radio/CD with six speakers (above)
- ✓ Climatronic two-zone automatic air-conditioning
- ✓ Cruise control
- ✓ Leather-trimmed steering wheel, gear knob and handbrake handle with silver console inlay (below)
- ✓ Trip computer with multi-function display
- ✓ Three 12V sockets
- ✓ Front centre armrest
- ✓ Storage under front seats
- ✓ A-pillar grab handle on passenger side



Highline

# Elevated thinking

The Highline trim adds a wealth of fabulous features that make the Amarok a paragon of practicality, comfort and style – inside and out

If you want to make your mark, then the Amarok Highline is the trim for you. In addition to all the Trendline features, you get 18" Durban alloy wheels, chrome-and-body-coloured door mirrors, a chrome rear bumper with integrated step, polished stainless-steel side bars and privacy glass. Together, they add up to give the Highline a sharp new look.

## The ultimate level of luxury

Inside, Vienna leather and leatherette upholstery – with heated front seats – combine with the Trendline's leather steering wheel, gear knob and handbrake and other features to add even more style and comfort. The Highline includes the Climatronic two-zone air-conditioning and RCD 310 CD/radio with six speakers from the Trendline, and adds front and rear parking sensors for good measure.

## Transmission control

The Amarok Highline is available with a choice of either selectable or permanent 4MOTION® all-wheel-drive, while two models add BlueMotion Technology to the 180PS BiTDI engine for increased fuel efficiency of up to 35.3mpg (combined). You can also pick an eight-speed automatic gearbox, for the ultimate in easy driving.



Highline models have top-of-the-range features such as leather seats, privacy glass and 10-spoke 18" Durban alloy wheels, all adding extra quality and refinement to driver appeal



Styling bars shown are optional equipment. Please ask your Van Centre for details

## Highline features

(In addition to Startline and Trendline)



- ✓ 18" Durban alloy wheels
- ✓ Front and rear parking sensors
- ✓ Chrome/body-coloured door mirrors
- ✓ Chrome rear bumper with integrated step
- ✓ Polished stainless-steel side bars
- ✓ Heated front seats (above)
- ✓ Privacy glass
- ✓ Leather upholstery
- ✓ Dimmable dashboard illumination
- ✓ Multifunction Plus pack with analogue fuel gauge, engine temperature display, navigation display and mobile phone preparation
- ✓ Dashboard upgrade, including air vents with chrome rings, light switch in chrome surround, colour change for silver panels and new black inserts



# Features and prices

It's time to choose your ideal Amarok

## Amarok Startline: Standard features

### Startline

#### Exterior

16" x 6.5J Taruma alloys fitted with 245/70 R16 tyres (including full-size steel spare wheel and tyre)

Electrically adjustable and heated door mirrors

80-litre fuel tank

Body-coloured front bumper

Black painted rear bumper with integrated step

Black plastic door mirrors and handles

Trailer hitch preparation

Load compartment light

Easy-to-use lockable tailgate

Mud flaps – front and rear

#### Interior

RCD 210 single CD/radio with two speakers and aux-in

Climatic semi-automatic air-conditioning system

Electric front and rear windows

Three-seat folding bench with ISOFIX

Spacer cloth upholstery

12V socket in centre console

Rubber flooring in cab

Grab handle on A-pillar (passenger side only)

#### Safety and security

Mechanical rear differential lock (Startline only)

4MOTION® Selectable transmission

Heavy duty suspension – 3 + 2 leaf-spring system

Airbags – driver, front passenger (including de-activation switch) and front side/head on both front seats

Remote central locking with interior locking switch and two remote folding keys

Four lashing rings in load compartment

Thatcham Category 1 alarm and immobiliser

Electronic Stabilisation Programme (ESP)

Anti-lock Braking System (ABS) with off-road ABS

Anti-Slip Regulation (ASR)

Electronic Differential Lock (EDL)

Trailer stabilisation

Hill Hold Assist and Hill Decent Assist

Tool kit

Emergency stop signal



#### 16" Taruma alloy wheels

Set of four 16" x 6.5J Taruma alloy wheels fitted with 245/70 R16 tyres. Comes with full-size steel spare wheel and tyre.



#### Electric windows and electrically adjustable door mirrors

Every Amarok comes fitted with electrically heated and adjustable door mirrors, as well as electric front and rear windows.



#### RCD 210 radio/CD player

The RCD 210 includes an AM/FM radio and MP3 file-compatible CD player, and comes with two 20W speakers in the cab. You can choose to upgrade your audio, or add phone connectivity or a sat-nav in our factory-fit options section.



#### 4MOTION® Selectable

Lets you choose between rear-wheel drive, four-wheel drive and four-wheel drive with low range via a dash-mounted button. It's great for boosting traction on slippery surfaces.



#### Climatic air-conditioning

A semi-automatic system that helps keep you and your passengers at the right temperature – warm on winter days, and cool in the heat of summer.



#### Cargo area

The Amarok has the widest load area in its class – 1.22m between arches, which is enough to fit a Euro pallet sideways. The huge 2.52m² load area also has an easy-to-use lockable tailgate and a load-compartment light.



#### Body-coloured front bumper

A body-coloured front bumper adds a bit style to your Amarok – handy when you want to make a good first impression.



#### Safety features

The Amarok comes with a driver's and passenger airbags, Electronic Stability Programme (ESP), Anti-lock Braking System (ABS) with off-road ABS and Anti-Slip Regulation (ASR), Electronic Differential Lock (EDL) and Hill Hold Assist and Hill Decent Assist.





# Amarok Trendline: Standard features



## Trendline

### In addition to Startline:

#### Exterior

17" x 8J Aldo alloy wheels with 245/65 R17 tyres (including full-size steel spare wheel and tyre)

Front fog lights

Body-coloured door mirrors and handles, wheel arch extensions and front bumper, including chrome detailing in upper grille

#### Interior

RCD 310 single CD/radio with six speakers

Climatronic two-zone automatic air-conditioning system

Cruise control

Trip computer with multi-function display including chrome detailing in instrument cluster

Leather steering wheel, gear knob and hand-brake handle

Silver inlay around gear-shift console

Silver interior door handles

Front centre armrest

Trail cloth upholstery

Three 12V sockets – dash, centre console and load bay

Storage drawers under front seats

Carpet flooring in cab

Grab handles on A- and B-pillars on passenger side

Two multi-use mounting points. Attachments are available as Add Ons, including a cup holder, note clip and magnet. Please ask your van centre for details.



### 17" Aldo alloy wheels

Set of four 17" x 8J Aldo alloy wheels with 245/65 R17 tyres. Comes with full-size steel spare wheel and tyre



### Cruise control

By keeping your vehicle at a constant speed for long stretches of open road, cruise control saves fuel that would normally be wasted when your speed fluctuates.



### RCD 310 radio/CD with aux-in

Comes with six speakers, an MP3-compatible CD player, an aux-in for external devices and the ability to add Digital Audio Broadcast (DAB) radio as a factory-fit option.



### Front fog lights

Front fog lights help you keep a clear view of the road ahead.



### Climatronic air-conditioning

Fully automatic Climatronic air-conditioning means that you can set your preferred interior temperature and your Amarok will keep it there for you. It's the simplest way to keep cool.



### Leather steering wheel, gearknob and hand-brake handle

Adds an extra dose of luxurious feel to the interior of your Amarok. Carpet flooring and silver detailing complete the premium look.



### 4MOTION® Selectable

Lets you choose between rear-wheel drive, four-wheel drive and four-wheel drive with low range via a dash-mounted button. It's great for boosting traction on slippery surfaces.





# Amarok Highline: Standard features



## Highline

### In addition to Startline and Trendline:

#### Exterior

- 18" x 7.5J Durban alloy wheels with 255/60 R18 tyres (including full-size steel spare wheel and tyre)
- Body-coloured front bumper, including chrome detailing in lower and upper grille
- Polished-stainless-steel side bars
- Chrome rear bumper with integrated step
- Chrome / body-coloured door mirrors
- Privacy glass
- Parking sensors – front and rear

#### Safety and security

- 4MOTION® Permanent transmission
- Standard suspension – 2 + 1 leaf-spring system

#### Interior

- Vienna leather upholstery: seat material in contact with passengers is leather, other areas are leatherette
- Heated front seats
- Dimmable dashboard illumination
- Multi-function Plus pack: includes analogue fuel gauge, engine coolant temperature display, navigation display and mobile phone preparation
- Dashboard upgrade, including air vents with chrome rings, light switch in chrome surround, colour change for silver panels and new black inserts

#### BlueMotion Technology models

- Low-rolling-resistance tyres
- Start/stop system
- Regenerative braking



### 18" Durban alloy wheel

Set of four 18" x 7.5J Durban alloy wheels with 255/60 R18 tyres. Comes with full-size steel spare wheel and tyre.



### Privacy glass

Privacy glass adds style to your Amarok and keeps your passengers – and the contents of your vehicle – sheltered from prying eyes. (Tonneau cover available as an Add On)



### Parking sensors

Parking sensors will pick up bollards and low walls that your mirrors may miss, giving you peace of mind while manoeuvring your Amarok.

## BlueMotion Technology models



### Start/stop

By cutting the engine, start/stop helps you to save fuel in slow traffic and at traffic lights. When you're ready to get going again the engine restarts automatically.



### Low rolling resistance tyres

Tyres with low-rolling resistance mean that the engine doesn't have to work as hard to get your van moving. It all helps to save fuel and reduce emissions.



### Heated front seats with Vienna leather upholstery

Perfect for those cold winter mornings, heated seats are the perfect way to warm up quickly.



### Polished stainless-steel side bars

Give your Amarok even more presence on the road while protecting your vehicle's side sills.



### 4MOTION® Permanent

Keeps the four-wheel-drive system constantly engaged, so power is always sent to the wheels with the most grip, helping to keep you safe and headed in the right direction.



### Energy recuperation

Uses the energy created when you brake to run the alternator and charge the battery. That means the engine has to do less work at other times.



### Cruise control

By keeping your vehicle at a constant speed for long stretches of open road, cruise control saves fuel that would normally be wasted when your speed fluctuates.





## Amarok: Prices



### Finance that makes buying a Volkswagen even more affordable

Our extensive range of finance packages can make driving a Volkswagen Amarok a reality. Ask your Van Centre for a Finance brochure and speak to us today – you may be surprised at how much you can afford.

Every Amarok has an On The Road package that covers basic vehicle costs

On The Road (OTR) package	
First registration fee	£55.00
Delivery to Van Centre	£565.00
VAT	£117.00
Vehicle Excise Duty (1 year)	£220.00
Number plates	£20.00
Basic OTR (ex VAT)	£860.00
Total OTR price	£977.00

	Basic (ex VAT)	Total (inc VAT)	Total RRP including OTR* (ex VAT)	Total RRP including OTR* (inc VAT)
<b>Startline</b>				
2.0TDI 140PS 4MOTION® Selectable	£19,860.00	£23,832.00	£20,720.00	£24,809.00
2.0BiTDI 180PS 4MOTION® Selectable	£20,610.00	£24,732.00	£21,470.00	£25,709.00
<b>Trendline</b>				
2.0TDI 140PS 4MOTION® Selectable	£20,860.00	£25,032.00	£21,720.00	£26,009.00
2.0BiTDI 180PS 4MOTION® Selectable	£21,610.00	£25,932.00	£22,470.00	£26,909.00
<b>Highline</b>				
2.0BiTDI 180PS 4MOTION® Selectable	£24,580.00	£29,496.00	£25,440.00	£30,473.00
2.0BiTDI 180PS 4MOTION® Permanent with BlueMotion Technology	£24,910.00	£29,892.00	£25,770.00	£30,869.00
2.0BiTDI 180PS 4MOTION® Permanent Automatic with BlueMotion Technology	£26,310.00	£31,572.00	£27,170.00	£32,549.00







# Options

Get the best from your Amarok with our quality options



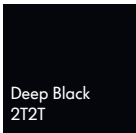

## Paint

You want your Amarok to make an impression. The most striking way to do that is to opt for a distinctive paint finish

		Startline		Trendline		Highline	
		Basic (ex VAT)	Total RRP (inc VAT)	Basic (ex VAT)	Total RRP (inc VAT)	Basic (ex VAT)	Total RRP (inc VAT)
<b>Standard</b> A choice of two great colours, available at no extra cost		○	○	○	○	○	○
<b>Metallic</b> Mark your Amarok out from the competition with a smart metallic paint finish		£460.00	£552.00	£460.00	£552.00	£460.00	£552.00
<b>Pearlescent</b> Tiny flecks of material in the paint reflect light, giving your Amarok a unique look		£460.00	£552.00	£460.00	£552.00	£460.00	£552.00

## Options: Alloy wheels

Complete your Amarok's sleek, sharp look with a set of stylish alloy wheels

		Startline		Trendline		Highline	
		Basic (ex VAT)	Total RRP (inc VAT)	Basic (ex VAT)	Total RRP (inc VAT)	Basic (ex VAT)	Total RRP (inc VAT)
<b>Alloy wheels</b>							
<b>16" Taruma</b> Set of four 6.5J x 16" alloys with alloy spare and 245/70 R16 tyres		S	S	-	-	-	-
<b>17" Aldo</b> Set of four 8J x 17" alloys with alloy spare and 245/65 R17 tyres		-	-	S	S	-	-
<b>18" Durban</b> Set of four 7.5J x 18" alloys with steel spare and 255/60 R18 tyres		-	-	£410.00	£492.00	S	S
<b>19" Cantera</b> Set of four 8J x 19" alloys with alloy spare and 255/55 R19 tyres		-	-	£790.00	£948.00	£390.00	£468.00
<b>Spare wheels</b>							
<b>Spare wheel – alloy</b>		£200.00	£240.00	£200.00	£240.00	£200.00	£240.00
<b>Spare wheel – steel</b>		○	○	○	○	○	○
<b>Tyre repair kit</b> In lieu of spare wheel		○	○	○	○	○	○
<b>Winter tyres</b>							
<b>17" winter tyres</b> Set of four 245/65 R17 tyres		-	-	£117.50	£141.00	-	-



Keep your alloys in perfect condition

Brake dust is full of abrasive and corrosive metal and carbon particles, so clean your alloys every couple of weeks with a specialist brush and cleaning fluid, then coat them with a wax protector. You can buy these at your local Van Centre.



**Add Ons**  
 Accessories to help keep your vehicle 100% Volkswagen



If you want even more choice for alloy wheels, check out our Add Ons accessories. See page 38 for the full Amarok range or ask your local Van Centre for details. Call 0800 717131 or visit [www.volkswagen-vans.co.uk](http://www.volkswagen-vans.co.uk) to find the nearest Van Centre to you.



## Options: Audio, phone and satellite-navigation

Choose from a range of entertainment systems for great music on the go, or opt for one of our touch-screen satellite-navigation systems

			Startline		Trendline		Highline		
			Basic (ex VAT)	Total RRP (inc VAT)	Basic (ex VAT)	Total RRP (inc VAT)	Basic (ex VAT)	Total RRP (inc VAT)	
<b>Audio</b>									
<b>RCD 210</b>		<b>A great basic system for music on the go. Listen to the radio or play your own music on the CD player</b>	<ul style="list-style-type: none"> <li>✓ Two speakers</li> <li>✓ FM/AM radio</li> <li>✓ Single CD player</li> <li>✓ Aux-in for external devices</li> </ul>	S	S	–	–	–	–
<b>RCD 310</b>		<b>This radio includes four additional speakers in addition to all the features of the RCD 210</b>	<ul style="list-style-type: none"> <li>✓ Six speakers</li> <li>✓ FM/AM radio</li> <li>✓ Single CD player</li> <li>✓ Aux-in for external devices</li> </ul>	£127.50	£153.00	S	S	S	S

			Startline		Trendline		Highline		
			Basic (ex VAT)	Total RRP (inc VAT)	Basic (ex VAT)	Total RRP (inc VAT)	Basic (ex VAT)	Total RRP (inc VAT)	
<b>Satellite navigation</b>									
<b>RNS 315</b>		<b>A great sat-nav to help you get where you're going. It includes a 5" colour touch-screen display, RDS (Radio Data System) for traffic updates, Bluetooth connectivity, aux-in, SD card slot, western Europe mapping data pre-loaded on 4GB flash memory. Requires RCD 310 to be fitted on Startline models</b>	<ul style="list-style-type: none"> <li>✓ 5" colour touch-screen</li> <li>✓ Four speakers</li> <li>✓ FM/AM radio with RDS</li> <li>✓ Single CD player</li> <li>✓ Aux-in for external devices</li> <li>✓ SD card slot</li> <li>✓ Bluetooth® connectivity</li> <li>✓ 4GB flash memory with pre-loaded western Europe data</li> </ul>	£575.00	£690.00	£575.00	£690.00	£575.00	£690.00
<b>RNS 510</b>		<b>Finding your way is easy with the RNS 510 touch-screen radio/navigation system, which also offers you the latest in multimedia entertainment. Its advanced technology lets you simply control what you want to do. Requires RCD 310 to be fitted on Startline models</b>	<ul style="list-style-type: none"> <li>✓ 6" colour touch-screen</li> <li>✓ Four speakers</li> <li>✓ FM/AM radio with RDS</li> <li>✓ Single CD player</li> <li>✓ Aux-in for external devices</li> <li>✓ SD card reader</li> <li>✓ 30GB flash memory with pre-loaded western Europe data</li> </ul>	£1,580.00	£1,896.00	£1,375.00	£1,650.00	£1,375.00	£1,650.00
<b>Phone</b>									
<b>Bluetooth connectivity</b> <small>(Not compatible with satellite navigation)</small>		<b>Go hands-free with compatible phones. This system includes a multi-function display</b>		£205.00	£246.00	£205.00	£246.00	£205.00	£246.00



## Options: Body, chassis and windows

Tailor your Amarok to your needs with our body and chassis options, including towbars, underbody protection and mud flaps

	Startline		Trendline		Highline	
	Basic (ex VAT)	Total RRP (inc VAT)	Basic (ex VAT)	Total RRP (inc VAT)	Basic (ex VAT)	Total RRP (inc VAT)
<b>Towing</b>						
<b>Fixed ball with electrics (13-pin socket)</b>	£230.00	£276.00	£230.00	£276.00	£230.00	£276.00
<b>Cargo bay</b>						
<b>Load compartment protective coating</b> <small>Anthracite-coloured, UV-resistant protection against mechanical and chemical damage</small>	£495.00	£594.00	£495.00	£594.00	£495.00	£594.00
<b>Rear window rack</b>	£175.00	£210.00	£175.00	£210.00	£175.00	£210.00
<b>Lashing rings for load restrain</b>	£12.50	£15.00	£12.50	£15.00	£12.50	£15.00
<b>Windows</b>						
<b>Rear privacy glass</b>	£200.00	£240.00	£200.00	£240.00	S	S
<b>Underbody protection</b>						
<b>Underbody protection</b>	○	○	○	○	○	○



### Useful towing tips

- 1. Watch your weight**  
Make sure your trailer doesn't exceed your vehicle's maximum towing limit or its gross train weight. You'll find these in your handbook.
- 2. Load well, stay stable**  
For stability, put heavy items low down over the trailer axle. Ensure the trailer has a slightly nose-down attitude, but that it doesn't exceed the van's or trailer's nose weight limit.
- 3. Check your tyres**  
Your van's tyres may need to be inflated to a greater pressure to cope with the extra load. Check your vehicle's handbook.

## Options: Comfort and convenience

From a multi-function steering wheel to various storage solutions, there's a range of features to make driving even more comfortable

	Startline		Trendline		Highline	
	Basic (ex VAT)	Total RRP (inc VAT)	Basic (ex VAT)	Total RRP (inc VAT)	Basic (ex VAT)	Total RRP (inc VAT)
<b>Cab interior</b>						
<b>Leather multi-function steering wheel</b>	£205.00	£246.00	£92.50	£111.00	£92.50	£111.00
<b>Cruise control and trip computer with multi-function display</b>	£155.00	£186.00	S	S	S	S
<b>Automatic dimming rear-view mirror and rain sensor</b>	£155.00	£186.00	£155.00	£186.00	£155.00	£186.00
<b>Electrically folding, adjustable and heated exterior mirrors</b>	£102.50	£123.00	£102.50	£123.00	£102.50	£123.00
<b>Heated front seats and heated washer nozzles</b>	£315.00	£378.00	£315.00	£378.00	S	S
<b>Multi-function display</b>	£42.50	£51.00	£42.50	£51.00	S	S
<b>Centre console with cover</b>	£47.50	£57.00	S	S	S	S
<b>Non-smoking pack, deletion of ashtray and lighter</b>	○	○	○	○	○	○
<b>Floor coverings</b>						
<b>Rubber floor</b> <small>In lieu of carpet</small>	S	S	○	○	○	○
<b>Carpet floor</b> <small>In lieu of rubber</small>	○	○	S	S	S	S









### Choose cruise control

Cruise control can help reduce the fatigue and stress of sticking to speed limits on long journeys. It also helps reduce the amount of fuel you consume by cutting out the acceleration and braking used to keep up with road speed.



## Options: Seating, trim and upholstery

Add even more comfort to your Amarok with a selection of upholstery finishes

		Startline		Trendline		Highline	
		Basic (ex VAT)	Total RRP (inc VAT)	Basic (ex VAT)	Total RRP (inc VAT)	Basic (ex VAT)	Total RRP (inc VAT)
<b>Upholstery</b>							
<b>Spacer cloth upholstery</b>		S	S	-	-	-	-
<b>Trail cloth upholstery</b>	 	-	-	S	S	-	-
<b>Vienna leather upholstery</b> Seat material in contact with passengers is leather. Outer, sides and rear of seats are leatherette	 	-	-	-	-	S	S
<b>Alcantara leather upholstery</b> Includes carbon-look bolsters and Alcantara headrest with decorative grey stitching		-	-	£510.00	£612.00	O	O
<b>Leatherette upholstery</b> Anthracite (HV)		£47.50	£57.00	-	-	-	-



### Pick the right upholstery

Cloth upholstery is terrifically hard-wearing, while leatherette upholstery is great for cleaning quickly and easily.

## Options: Safety and security

Beef up your Amarok's safety equipment with kit such as parking sensors, differential locks or first aid kits

	Startline		Trendline		Highline	
	Basic (ex VAT)	Total RRP (inc VAT)	Basic (ex VAT)	Total RRP (inc VAT)	Basic (ex VAT)	Total RRP (inc VAT)
<b>Parking aids</b>						
<b>Parking sensors – rear only</b>	£270.00	£324.00	-	-	-	-
<b>Parking sensors – front and rear</b>	-	-	£357.00	£429.00	S	S
<b>Reversing camera with parking sensors – rear only</b> <small>Requires RNS 315 or RNS 510 satellite navigation to be fitted</small>	£635.00	£762.00	-	-	-	-
<b>Reversing camera with parking sensors – front and rear</b> <small>Requires RNS 315 or RNS 510 satellite navigation to be fitted</small>	-	-	£740.00	£888.00	£380.00	£456.00
<b>Fog lights</b>						
<b>Front fog lights</b>	£125.00	£150.00	S	S	S	S
<b>Front fog lights with cornering function</b>	-	-	£62.50	£75.00	£62.50	£75.00
<b>Other safety and security options</b>						
<b>Mechanical rear differential lock</b>	S	S	£215.00	£258.00	£215.00	£258.00
<b>First aid kit and warning triangle</b>	£22.50	£27.00	£22.50	£27.00	£22.50	£27.00
<b>Fire extinguisher (2kg)</b>	£160.00	£192.00	£160.00	£192.00	£160.00	£192.00

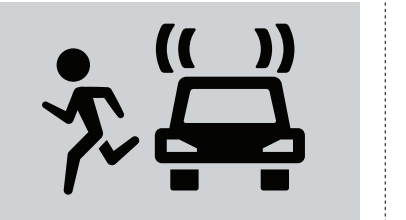

### Useful security tips

- 1. Get an alarm**  
Alarm noise may be enough to scare a thief and prevent a costly break-in.
- 2. Lock your doors**  
Even if you're only away from your van for a minute, locked doors deter thieves looking for an easy target.
- 3. Keep it tidy**  
Seemingly trivial items can still be bait to thieves. Stow gadgets out of sight or take them with you. Thieves know to look in the glove box, too.
- 4. Load out of sight**  
Try and load your van in a secure location. Thieves can linger in public areas for an easy swipe-and-run.
- 5. Park for visibility**  
Use well-lit areas. Avoid parking near vehicles or foliage that a thief could use for cover. Parking right up against walls can stop a thief getting in through your van's doors, too.



## Options: Heating, ventilation and electrical

Choose these heating, ventilation and electrical features to give your Amarok a functional and practical edge

	Startline		Trendline		Highline	
	Basic (ex VAT)	Total RRP (inc VAT)	Basic (ex VAT)	Total RRP (inc VAT)	Basic (ex VAT)	Total RRP (inc VAT)
<b>Air conditioning</b>						
<b>Climatic air-conditioning</b>	S	S	–	–	–	–
<b>Climatronic air-conditioning (CFC-free)</b>	£740.00	£888.00	S	S	S	S
<b>Manual heating system</b> <small>In lieu of Climatic manual air-conditioning</small>	O	O	–	–	–	–
<b>Auxiliary heaters</b>						
<b>Auxiliary water heater</b>	£250.00	£300.00	£250.00	£300.00	£250.00	£300.00
<b>Auxiliary water heater with programmable parking heater and radio remote control</b>	£920.00	£1,104.00	£920.00	£1,104.00	£920.00	£1,104.00
<b>Electrical devices</b>						
<b>Electrical interface for converters/coachbuilders to fit external devices</b>	£47.50	£57.00	£47.50	£57.00	£47.50	£57.00
<b>Tachograph preparation</b>	£205.00	£246.00	£205.00	£246.00	£205.00	£246.00





# Add Ons

Stylish, practical accessories for your Amarok

Add Ons is the new name for our range of Volkswagen-approved accessories, available to buy and be fitted at your Van Centre. Whether you want to add style or technology, we've got lots of Add Ons for you.

## Help keep it 100% Volkswagen

There are big advantages to keeping your accessories 100% Volkswagen. They're a perfect match for fit and style, and developed to be as rugged and reliable as your vehicle.

## Keep your Add Ons covered

Most Add Ons include a two-year warranty. But if you order and fit them at the time of purchasing a new Amarok, we may be able to extend that to three years to match your vehicle's warranty.

**Add Ons**  
Accessories to help keep your vehicle 100% Volkswagen

## Sport & styling



### Rear styling bars – black

Improved dual 76mm-pipe design made from powder-coated steel for a bold look. Mounted on the edge of the cargo area, giving you full access to your load space. Can be used with the three-piece hard tonneau cover.

**Fitted price ex VAT** £425.83  
**Fitted price inc VAT** £511.00



### Rear styling bars – stainless steel

Polished stainless-steel finish. Mounted on the edge of the cargo area so it doesn't restrict load area and can be used in conjunction with the three-piece hard tonneau cover.

**Fitted price ex VAT** £625.83  
**Fitted price inc VAT** £751.00



### Styling bar lights

Great for off-roading, these lights help to improve your field of vision in dark or unlit areas off the beaten track.

**Fitted price ex VAT** From £460.83  
**Fitted price inc VAT** From £553.00



### Front bumper trim

Two-tone front bumper trim that further enhances the striking front end of the Amarok.

**Fitted price ex VAT** £371.67  
**Fitted price inc VAT** £446.00



### Side bars – polished stainless-steel

These mirror-finish stainless-steel side bars enhance the sporty style of the Amarok. They can be matched to the rear styling bar to complete the look.

**Fitted price ex VAT - Silver** £394.17  
**Fitted price inc VAT - Silver** £473.00



### Side bars with step pads

These side bars look great, help protect your vehicle when you're off-road, and make it easier to load the roof. There are two rubber step pads on each 76mm tube. Available in polished stainless-steel (pictured) or black powder-coated steel.

**Stainless steel:**  
**Fitted price ex VAT** £445.00  
**Fitted price inc VAT** £534.00  
**Black:**  
**Fitted price ex VAT** £399.17  
**Fitted price inc VAT** £479.00

All prices exclude fitting, unless otherwise stated. Please ask your Van Centre for a fitted price



### 19" Aragonit Silver alloy wheel

Alloys for the ultimate kerb appeal in a brilliant silver-effect finish. Rim size: 8J x 19.

**Fitted price per wheel ex VAT** £320.83  
**Fitted price per wheel inc VAT** £385.00

*Prices do not include tyres  
Only for wheel arch extension*



### 19" Aragonit Black alloy wheel

The classic alloy design, now available in a stylish black finish. Rim size: 8J x 19.

**Fitted price per wheel ex VAT** £335.00  
**Fitted price per wheel inc VAT** £402.00

*Prices do not include tyres  
Only for wheel arch extension*



### 18" Alutech Bi-colour alloy wheel

Add these stylish bi-colour alloys to make your Amarok stand out. Rim size: 8J x 18.

**Fitted price per wheel ex VAT** £222.50  
**Fitted price per wheel inc VAT** £267.00

*Only suitable for Highline 2.0 BiTDI 180PS  
4MOTION® Permanent BlueMotion Technology  
Prices do not include tyres*

### 16" Amazonit alloy wheel

A great option to add extra style to an Amarok Startline. The existing tyre from the steel wheels can be used with the Amazonit alloys. Rim size: 6.5J x 16.

**Fitted price per wheel ex VAT** £141.67  
**Fitted price per wheel inc VAT** £170.00

*Prices do not include tyres*

All prices exclude fitting, unless otherwise stated. Please ask your Van Centre for a fitted price



### Leather seats

Add a touch of luxury as well as durability and practicality to your vehicle with single-colour, smooth, high-quality leather with matching stitching and your choice of flat or pillow-effect cushioning.

**Price ex VAT** £1,208.33  
**Price inc VAT** £1,450.00

Black

Titan Grey



### Leather seats Sport

Two-tone upholstery with complementary colours in either the side 'fillet' panels or mid-centre back and seat panels. With both designs, stitching is in the contrasting colour. You choose between flat or pillow-effect cushioning.

**Price ex VAT** £1,375.00  
**Price inc VAT** £1,650.00

Titan Grey

Dark Red

Ocean Blue

Volkswagen Amarok 39



# Add Ons

## Sport & styling (cont.)

### The all-new chrome range

**NEW**

A big addition to our Amarak Add Ons range for 2014 is a selection of stylish chrome exterior features. Available for Trendline and Highline models, they give your pickup the ideal finishing touch, helping you to stand out from the pack.



**Chrome door handle cover**

**Fitted price ex VAT** £51.67

**Fitted price inc VAT** £62.00



**Chrome tailgate handle and surround**

**Fitted price ex VAT** £29.17

**Fitted price inc VAT** £35.00



**Thule roof bars**

Increase load space with these sturdy roof bars.

And if you use them with our roofbar accessories

you can fine-tune your vehicle to meet your needs.

**Fitted price ex VAT** £177.50

**Fitted price inc VAT** £213.00

**Roof bar accessories**

**Volkswagen roof boxes** From £220.00

**Kayak holder** £95.00

**Pull-out ski and snowboard holder** £175.00

**Roof-bar-mounted bicycle holder** £85.00

**Surfboard holder** £95.00

(Prices include VAT, excluding fitting)



**Chrome mirror caps**

**Fitted price ex VAT** £79.17

**Fitted price inc VAT** £95.00



**Chrome fog light surround bezel**

**Fitted price ex VAT** £26.67

**Fitted price inc VAT** £32.00



**Chrome side indicator surround**

**Price ex VAT** £10.00

**Price inc VAT** £12.00



**Towing ball and electrics**

Removable ball-head tow bar (50mm) for 2,800kg trailer loads. With 13-pin electrics.

**Fitted price ex VAT** £373.34

**Fitted price inc VAT** £448.00



**Side wind deflectors**

Allow you to lower the window and improve air circulation without letting the rain in. They'll also help keep the sunlight out of your eyes. Available as a front-and-rear set, or for the front only.

**Full set – fitted price ex VAT** £57.50

**Full set – fitted price inc VAT** £69.00

**Front only – fitted price ex VAT** £39.17

**Front only – fitted price inc VAT** £47.00

## Technology



**Kenwood DAB Multimedia System\***

This stunning unit lets you control your music from the radio, CDs, iPhones or iPods (requires optional lead) with the 7" high-resolution touchscreen. The radio now includes digital DAB reception for more stations and a clearer signal. And, when parked, you can watch DVDs to keep you entertained while you're waiting. European satellite navigation can be run in split-screen mode, and the hands-free Bluetooth® phone connectivity lets you view SMS text-messages (on selected handsets).

**Fitted price ex VAT** £874.17

**Fitted price inc VAT** £1,049.00

\* Some features only work when the vehicle is stationary



**Autodab**

This professionally installed DAB system lets you enjoy all the benefits of digital radio. Choose from new digital stations and enjoy old favourites with improved audio quality. It also uses your vehicle's display to show song and artist info from certain stations. (Available mid-February)

**Fitted price ex VAT** £187.50

**Fitted price inc VAT** £225.00



**Pure in-vehicle digital radio**

Enjoy a greater choice of channels and improved sound quality with this professionally installed digital radio upgrade. You can browse stations while listening, and even pause and rewind content. You can also connect certain music and USB devices. (Available early February)

**Fitted price ex VAT** from £240.83

**Fitted price inc VAT** from £289.00



**Kenwood CD/Digital Radio**

This DAB radio system has a clever chip that eliminates breaks and distortion in reception. You can hook up your iPod to the system, too, and search by playlist, genre, artist and album.

**Fitted price ex VAT** £289.17

**Fitted price inc VAT** £347.00



**NSV Bluetooth touch phone kit**

This Bluetooth kit looks factory fitted and offers: call-answering and ending with a single button; voice-activated dialling; ability to play music from phone (with compatible phones); audio muting during calls; directional microphone; automatic pairing on engine start; recognises up to five phones.

**Fitted price ex VAT** £180.00

**Fitted price inc VAT** £216.00



**Bluetooth touch phone music kit**

Control your phone by voice or the 2.8-inch colour touchscreen – and have your texts and emails read to you. The Bluetooth® Touch Phone kit uses your vehicle's audio system, so you can also listen to music stored on your mobile. You'll need a Quadlock or ISO lead.

**Fitted price ex VAT** from £201.67

**Fitted price inc VAT** from £242.00



**iPod adaptor**

Control your iPod through the stereo or, where fitted, the multi-function steering wheel – choose from either your top five playlists or entire music library. Charges your iPod, too.

**Fitted price ex VAT** £181.67

**Fitted price inc VAT** £218.00



**Media interface**

Connects a range of media devices to the audio system. Suitable for Trendline and Highline, or Startline vehicles with the RCD 310 radio upgrade option. Comes with iPod lead. You may need a lead to suit your media device.

**Fitted price ex VAT** from £248.33

**Fitted price inc VAT** from £298.00



# Add Ons

## Protection & care



**Load-floor liner, plastic**  
Fits perfectly to the load floor, protecting the front wall, cargo area, rear hatch and side walls against scratches and other damage. Made from

high-quality, durable polyethylene.  
**Fitted price ex VAT** £241.67  
**Fitted price inc VAT** £290.00



**Rear cabin grid**  
For transporting long objects without scratching the roof. Made of black powder-coated steel, it mounts on the rear panel. Cannot be used with tonneau covers, hardtop or styling bars.

**Fitted price ex VAT** £197.50  
**Fitted price inc VAT** £237.00



**Under-ride guard for gearbox\***  
Helps protect your gearbox when you leave the road and tackle rougher tracks and trails.  
**Fitted price ex VAT** £212.50  
**Fitted price inc VAT** £255.00

\* Can only be fitted in conjunction with the factory-fit engine protection grille option. Please ask your Van Centre for more details



**Mud flaps**  
Pairs available for front and rear, with or without flared wheel arches, to protect your Amarok from whatever the road throws its way.  
**Fitted price ex VAT** From £85.00 per pair  
**Fitted price inc VAT** From £102.00 per pair



**Headlamp protectors**  
A set of protectors; also comes with two sets of adhesive decals that convert your headlight beam for driving on the Continent.  
**Fitted price ex VAT** £45.83  
**Fitted price inc VAT** £55.00



**Bonnet protector**  
This handy protector will help keep your bonnet looking pristine and dent-free.  
**Fitted price ex VAT** £52.50  
**Fitted price inc VAT** £63.00



**Waterproof seat covers**  
Helps protect seats from dirt and spills, so they're always clean. They're machine washable, and available for front and rear.  
**Price ex VAT** From £67.50  
**Price inc VAT** From £81.00



**Rubber floor mats**  
Fits to the Amarok's interior to help protect the vehicle flooring. The anti-slip coating and mounting system stop the mats slipping or twisting. Available for front and rear seats.  
**Price ex VAT** From £20.83  
**Price inc VAT** From £25.00



**Carpet floor mats**  
These thick-pile carpet mats fit neatly to the Amarok's interior and help protect the flooring. The anti-slip backing and mounting system stop the mats slipping or twisting. Available for front and rear seats.  
**Price ex VAT** From £30.83  
**Price inc VAT** From £37.00

## Load area security



**Hardtop**  
Lightweight polycarbonate hardtop that clamps easily to the body of your double-cab Amarok. Gas-lift rear window has a single lock operation, while an interior light illuminates your load area. Also has fold-out passenger-side window, dual driver's-side sliding window, and front window

slider for easy cleaning. All windows include privacy glass. Can be used with bed liners. Cannot be used with rear styling bar.  
**Fitted price ex VAT** £1,947.50  
**Fitted price inc VAT** £2,337.00



**Tool box for cargo area**  
Lockable safe storage for tools. The box spans the full width of the load bay between the wheel arches. Cannot be used with tonneau covers.  
**Fitted price ex VAT** £341.67  
**Fitted price inc VAT** £410.00



**Commercial hardtop**  
Lightweight polycarbonate that clamps to the body. White for commercial use. Gas-lift window has privacy glass. Cannot be used with the rear styling bar.  
**Fitted price ex VAT** £1,585.00  
**Fitted price inc VAT** £1,902.00



**Roll-and-lock cover**  
Weather-resistant, vinyl-coated aluminium cover that protects the cargo area. It can be opened in increments, allowing taller objects to be carried, while still protecting small items. Please ask your Van Centre for compatibility with other Add Ons.  
**Fitted price ex VAT** £1,083.33  
**Fitted price inc VAT** £1,300.00



**Hard tonneau cover (3-piece)**  
This lockable, weather-resistant lid comes in durable PC/ABS plastic. It opens supported by two compressed-gas struts. The three-piece must be combined with the rear styling bar. Available pre-painted in six Amarok colours.  
**Fitted price ex VAT** £1,251.67  
**Fitted price inc VAT** £1,502.00



**Hard tonneau cover (1-piece)**  
Lockable, weather-resistant lid in durable PC/ABS plastic. Opens on two compressed-gas struts and covers the whole rear load area. Available pre-painted in six Amarok colours. Cannot be used with the rear styling bar.  
**Fitted price ex VAT** £1,251.67  
**Fitted price inc VAT** £1,502.00



**Soft tonneau cover with aluminium frame**  
Waterproof cover with an aluminium mounting to secure it to the cargo bay, protecting your load from the elements. Can be rolled back and held in place with two belts when not required. Cannot be used with the rear styling bar.  
**Fitted price ex VAT** £300.83  
**Fitted price inc VAT** £361.00



**Aluminium tonneau cover**  
Lockable tonneau cover made of sturdy aluminium that protects the load area and its cargo and provides a secure load area. Loading and unloading is made easy with the cover supported on two compressed-gas struts. Cannot be used with the rear styling bar.  
**Fitted price ex VAT** £901.67  
**Fitted price inc VAT** £1,082.00



# Add Ons

## Safety & security



**NEW**

### Reverse parking camera

Available from April 2014

Rear-mounted camera that gives visual warning of obstacles directly behind. It complements the audible rear parking sensors (if fitted), and is activated by selecting reverse gear. The image from the camera is displayed on the interior rear-view mirror for ease, with guidance lines to reflect vehicle positioning when reversing.

**Fitted price inc VAT** £375.00

**Fitted price inc VAT** £450.00



### Anti-theft wheel bolt

Keep your alloy wheels safe from would-be thieves with this useful anti-theft wheel bolt set.

**Price ex VAT** £24.58

**Price inc VAT** £29.50



### Tailgate lock

Secure your load bay every time you use the remote central locking on your key. This security tailgate deadlock is designed specifically for the Amarok, and it includes tailgate lock, deadlock motor and bespoke brackets.

**Fitted price ex VAT** £155.83

**Fitted price inc VAT** £187.00



### Rear parking aid

This rear parking aid makes it much easier to get your Amarok into that space.

**Fitted price ex VAT** £274.17

**Fitted price inc VAT** £329.00



### Reversing-sensor switch

Lets you switch off the rear parking aid so you can reverse undisturbed when a trailer is attached. A green light on the switch reminds you that the sensors are not in use.

**Fitted price ex VAT** £90.00

**Fitted price inc VAT** £108.00



### CobraTrak

Keep your Amarok and its contents secure with CobraTrak. Volkswagen's partnership with CobraTrak stolen-vehicle tracking means your vehicle's location can be pinpointed across Europe. The system uses the latest GPS/GPRS/GSM technology and can locate your vehicle to an accuracy of 10m. CobraTrak is Thatcham and insurer-approved, and comes with a three-year Volkswagen warranty. A web upgrade is also available so you can track your vehicle using your computer or smartphone.

**Price ex VAT** From £385.99

**Price inc VAT** From £463.19

## Cab accessories



### Multi-attachment-point bracket and cup holder

Cup holder with bracket for Startline.

**Price ex VAT** £20.83

**Price inc VAT** £25.00

Cup holder only for Trendline and Highline.

**Price ex VAT** £15.83

**Price inc VAT** £19.00



### Multi-attachment-point bracket

For retro-fitting the multi-attachment socket to Startline vehicles.

**Price ex VAT** £19.17

**Price inc VAT** £23.00



### Multi-attachment-point picture holder

For your personal photographs and pictures.

**Price ex VAT** £9.17

**Price inc VAT** £11.00



### Multi-attachment-point magnet

Magnetic holder for pens and paper clips.

**Price ex VAT** £9.17

**Price inc VAT** £11.00



### Multi-attachment-point note clip

A handy place to keep those reminders for meetings or things to do.

**Price ex VAT** £9.17

**Price inc VAT** £11.00

## Merchandise



### Black leather CD holder

Take your CD collection on the road with you and protect it with this smart leather CD holder.

**Price ex VAT** £11.25

**Price inc VAT** £13.50



### Silver Volkswagen keyring

Stylish 35mm keyring features the iconic Volkswagen roundel.

**Price ex VAT** £5.00

**Price inc VAT** £6.00



### Silver Volkswagen cufflinks

For that finishing touch, choose from either the silver or blue-and-white enamel cufflinks.

**Price ex VAT** £13.33

**Price inc VAT** £16.00



### Chronograph watch

A stylish, robust timepiece with a stainless-steel case (water-resistant to 10 atmospheres), and a tough sport strap for rugged performance.

**RRP ex VAT** £100.00

**RRP inc VAT** £120.00



# Data

All the facts and figures you'll need for your vehicle

## Amarok: Engines

	2.0TDI 140PS	2.0BiTDI 180PS	2.0BiTDI 180PS Automatic
<b>Engine specifications</b>			
Engine type	Diesel, water-cooled, in-line, variable-turbine-geometry turbocharger with intercooler	Diesel, water-cooled, in-line, bi-turbocharger with intercooler	
Mixture preparation/injection method	Common-rail, direct-injection		
EU exhaust emission standard	5		
Number of cylinders	4		
Cubic capacity	1,968cc		
Output, max. PS at rpm	140 at 3,750	180 at 4,000	180 at 4,000
Torque, max. Nm/rpm	340 at 1,750-2,250	400 at 1,500-2,000	420 at 1,750
Diesel Particulate Filter (DPF)	●	●	●
4MOTION® Selectable with heavy-duty suspension	●	●	–
4MOTION® Permanent with heavy-duty suspension	–	–	●
4MOTION® Permanent with standard suspension	–	●	–
Manual transmission (6-speed)	●	●	–
Automatic transmission (8-speed)	–	–	●

- Available.
- Not available.

Output (PS)  
Torque (Nm)

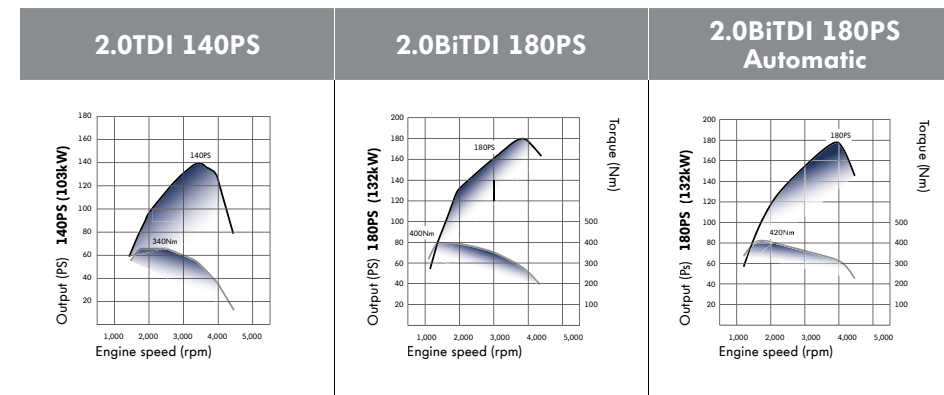

## Amarok: Dimensions and weights

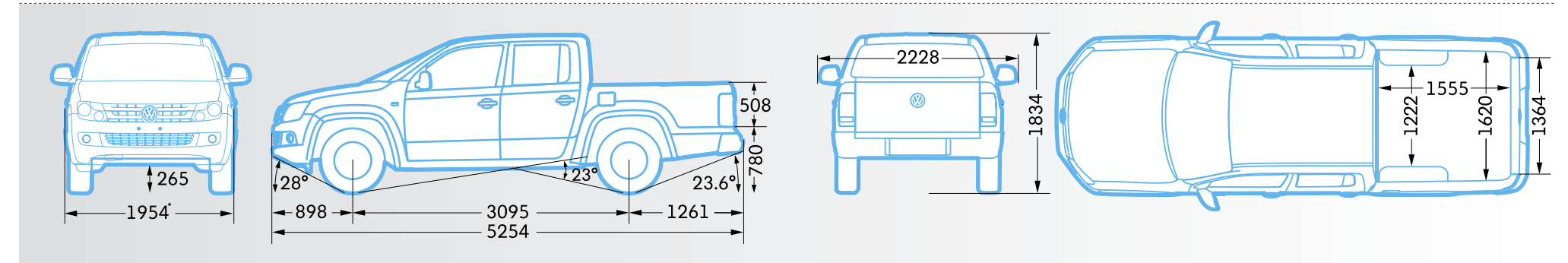

Dimensions	
Wheelbase	3,095
Length	5,254
Width	1,954*
Height	1,834
Ground clearance	265
Wade depth	500
<b>Load Area</b>	2.52m <sup>2</sup>
<b>Tailgate dimensions</b>	
Width	1,364
Height	508
<b>Turning circle</b> (wall to wall)	12.95m

Dimensions in mm unless otherwise indicated.

\*Startline models are 10mm narrower (1,944mm) than Trendline and Highline models

Model/engine/transmission	Gross vehicle weight (kg)	Axle load limit front/rear (kg)	Trailer weight braked 12%/unbraked (kg)	Gross train weight (kg)	Unladen weight † (kg)	Payload † (kg)
<b>Startline</b>						
2.0TDI 140PS 4MOTION® Selectable	3,170	1,375/1,620	3,000/750	5,550	2,108	<b>1,062</b>
2.0BiTDI 180PS 4MOTION® Selectable	3,170	1,410/1,860	3,000/750	5,550	2,025	<b>1,145</b>
<b>Trendline</b>						
2.0TDI 140PS 4MOTION® Selectable	3,170	1,375/1,620	3,000/750	5,550	2,113	<b>1,057</b>
2.0BiTDI 180PS 4MOTION® Selectable	3,170	1,410/1,860	3,000/750	5,550	2,058	<b>1,112</b>
<b>Highline</b>						
2.0BiTDI 180PS 4MOTION® Selectable	3,170	1,410/1,860	3,000/750	5,550	2,079	<b>1,091</b>
2.0BiTDI 180PS 4MOTION® Permanent BlueMotion Technology	3,170	1,385/1,620	3,000/750	5,950	2,048	<b>1,122</b>
2.0BiTDI 180PS 4MOTION® Permanent Auto BlueMotion Technology	3,170	1,425/1,860	3,200/750	5,950	2,093	<b>1,077</b>

† Unladen weight and payload figures are calculated with 100% fuel load and no driver.

The published payload figure is based on a standard-specification vehicle. It does not include any items of optional equipment. Any optional equipment will reduce the payload from the published figure and impact on the axle load limits. Care must be taken to ensure the vehicle is not overloaded and, in this regard, customers should consider the weight of any optional equipment when calculating axle loads



## Amarok: Economy and performance

Model/engine/transmission	Urban mpg (l/100km) <sup>1</sup>	Extra-urban mpg (l/100km) <sup>1</sup>	Combined mpg (l/100km) <sup>1</sup>	Acceleration 0-62 mph (seconds)	Top speed mph (where law permits)	CO <sub>2</sub> emissions (g/km) <sup>1</sup>
<b>Startline</b>						
2.0TDI 140PS 4MOTION® Selectable	29.4 (9.6)	41.5 (6.8)	<b>36.2 (7.8)</b>	13.5	101	<b>205</b>
2.0BiTDI 180PS 4MOTION® Selectable	30.7 (9.2)	38.7 (7.3)	<b>35.3 (8.0)</b>	11.0	111	<b>211</b>
<b>Trendline</b>						
2.0TDI 140PS 4MOTION® Selectable	29.4 (9.6)	41.5 (6.8)	<b>36.2 (7.8)</b>	13.5	101	<b>205</b>
2.0BiTDI 180PS 4MOTION® Selectable	30.7 (9.2)	38.7 (7.3)	<b>35.3 (8.0)</b>	11.0	111	<b>211</b>
<b>Highline</b>						
2.0BiTDI 180PS 4MOTION® Selectable	30.7 (9.2)	38.7 (7.3)	<b>35.3 (8.0)</b>	11.0	111	<b>211</b>
2.0BiTDI 180PS 4MOTION® Permanent BlueMotion Technology	32.8 (8.6)	39.8 (7.1)	<b>37.2 (7.6)</b>	11.0	111	<b>199</b>
2.0BiTDI 180PS 4MOTION® Permanent Auto BlueMotion Technology	31.0 (9.1)	38.2 (7.4)	<b>35.3 (8.0)</b>	11.3	108	<b>211</b>

<sup>1</sup>The fuel consumption and emission test values shown are in full compliance of the fuel consumption directive 80/1268/EWG

## Notes



# Support

Keeping you – and your vehicle – on the road and working

## Full support right from the start

We want to make sure that using your Amarok is hassle-free and cost-efficient. That's why every vehicle comes with a three-year warranty and a choice of finance, servicing and insurance options. It all helps to keep the big issues covered

### A three-year warranty that lasts 100,000 miles

All Volkswagen Commercial Vehicles get a three-year, 100,000-mile warranty\* – and so do any factory-fit options that you buy. The vehicle warranty is made up of:

- A two-year manufacturer's warranty with unlimited mileage
- A third-year Van Centre warranty, up to a maximum of 100,000 miles\*

Even if you exceed 100,000 miles during your first two years, the manufacturer's two-year warranty will still be valid.

#### Want cover for longer?

You can extend your vehicle warranty online or by phone. You can choose Comprehensive or Major Component cover and either one-off or monthly payments. Call **0845 641 9712** or visit [www.volkswagen-cv-warranty.co.uk](http://www.volkswagen-cv-warranty.co.uk).

**3**  
year  
warranty  
✓

\* Unlimited mileage for the Crafter in its third year

### Van Centres – always there for you

Our dedicated Van Centre network is at the core of everything we do, with more than 100 Van Centres and Authorised Repairers throughout the UK. Our Van Centre network offers a wide range of services, from MOTs to accessories, servicing and fully-fitted parts. Not only that, but we use Volkswagen quality parts and you get dedicated staff who understand your vans intimately. So pop in for a coffee and a chat, and find out what your Van Centre can do for you.



### Service options designed to fit your business perfectly

It's only natural that you want to keep your vehicle running at its best. Getting it serviced at a Volkswagen Van Centre is a great way to ensure that's exactly what happens. When it comes to servicing, we know everyone has different needs. That's why we've developed three different service options for you to choose from:

- Pay Monthly
- Pay Upfront
- Pay On-Demand

Whichever suits you best, you can rest assured that when you book in your vehicle, it will be looked after by Volkswagen-trained technicians and that they'll use only Volkswagen quality parts. What's more, there's a two-year warranty on the parts and one-year on labour.

For more details visit [www.volkswagen-vans.co.uk/service](http://www.volkswagen-vans.co.uk/service) or call **0800 717131** to learn more.

Turn the page to learn more about our Van Centre network

### Volkswagen Insurance keeps you covered\*

Volkswagen Commercial Vehicle Insurance can provide you with cost-effective, comprehensive motor insurance. Look at some of the benefits:

- Seven-day free cover to allow you to drive your vehicle away
- All repairs performed by approved repairers
- Volkswagen quality parts on all repairs
- Courtesy vehicle provided during repair following an accident
- Cover for breakage and damage to glass
- Tools-in-transit cover (up to £1,000)
- In-vehicle personal belongings cover (up to £500)
- Vehicle recovery
- 60-day European Union cover
- Legal expenses cover up to £100,000

We also offer a range of gap insurance products. These help you replace your vehicle or protect you from any financial shortfall if it is written off.

For more details visit [www.insurewithvvcv.co.uk](http://www.insurewithvvcv.co.uk), call **0800 316 7896** or pop into your Van Centre and ask for a Flexible Finance brochure.

\* Terms and conditions apply

### Flexible Finance that makes things affordable

We can also make buying a new vehicle more affordable in the first place. Speak to us about our selection of finance options, which include:

- Contract hire
- Finance lease
- Lease purchase
- Hire purchase

For more details visit [www.volkswagen-vans.co.uk/finance](http://www.volkswagen-vans.co.uk/finance) or pick up one of our Finance brochures at your nearest Van Centre.

### Three years' Roadside Assistance

Sometimes, the unexpected happens. If it does, your new Volkswagen comes with an unlimited-mileage recovery and assistance package. It lasts the same three years as your warranty and operates 24 hours a day, 365 days a year.

Cover is available across the UK and most of Europe. Our fully trained technicians can diagnose most problems at the roadside and they use Volkswagen quality parts.

Learn more

Visit your Van Centre to get a Volkswagen Roadside Assistance handbook, visit [www.volkswagen-vans.co.uk/roadside](http://www.volkswagen-vans.co.uk/roadside) or call **0800 77 71 72**



# 7 ways your Van Centre can help you

Make full use of your nearest Van Centre. It's full of Volkswagen experts who know your vehicle better than anyone and who can help you to get the best out of it

## 1. Picking a vehicle that's perfect for your needs

We know that choosing your next van or passenger carrier is a big decision. You want a vehicle that works just as hard as you do, both now and for the long-term – one that's versatile, cost-effective and reliable.

We're here to help make your choice easier.

Our Van Centre experts can offer advice on every model in the range and help you pick the right vehicle and factory-fit options for your business. They can also advise you on the best finance packages to ensure that your payments make financial sense.



## 2. Quality servicing you'd expect at a price you wouldn't

Unpredictability and moving goalposts are part of life for modern drivers, making it difficult to know how many miles your vehicle will do in a year, or how long you'll need to keep it. Our National Service Pricing is designed for customers who need the flexibility of being able to book their vehicle in for a service whenever it needs it. When you do, our technicians will do everything to ensure that your vehicle is back on the road, working hard for your business, as soon as possible.



## 3. Fast, hassle-free rental for one-off jobs

Need another vehicle for just a short while? You can hire any van from our fleet – Caddy, Transporter or Crafter – or passenger-carrier versions of the Transporter and Crafter if you need to move people.

For more information, call the Van Rental team on 01908 467450



## 4. Add Ons designed to help you get more from your vehicle

Perhaps your needs have changed – maybe you need a towbar or a roof rack, or perhaps you want to give your vehicle some extra style. That's where Add Ons comes in. Add Ons is an extensive range of Volkswagen-approved accessories, available to buy and be fitted at your local Van Centre. We've got everything from towbars to tailgate spoilers, load nets to leather seats and sat-nav systems to stunning alloy wheels.



## 5. Taking the worry out of tyres

Why run around looking for a fitter who has your tyres in stock? Let us fit new tyres when your vehicle is in for its next service and it will keep you off the road for less time. We have a huge range of tyres for all Volkswagen vans and passenger carriers, from economy to premium brands, including winter tyres.



## 6. Express Visual Checks – peace of mind for free

Your Van Centre or Authorised Repairer can give your vehicle a free, 29-point Express Visual Check for complete peace of mind. You'll be given a comprehensive report, with the results clearly explained, and your technician will talk you through what work may need to be done in the future so that you can plan ahead and budget for it. If something needs urgent attention, you can get a precise quote before any work is done – and all the Volkswagen parts are covered by a two-year warranty.

## What else can we do?

Loads! Just pop into any Van Centre and ask us. For example, we may be able to point you to a local signwriter, recharge your air-conditioning, or answer any queries about your vehicle. Whatever it may be, we're here for you.

## 7. Fully fitted parts for a fixed price – and not a penny more

The pricing of all our Volkswagen quality parts is straightforward and clear, so you know exactly how much you're paying. Even better, when they're fitted by trained technicians at a Van Centre or Authorised Repairer they come with two years' warranty and 12 months warranty on labour. If your vehicle is over five years old, ask us about Economy Parts – a great-value way to help keep your vehicle 100% Volkswagen.



To find your nearest Van Centre, visit [www.volkswagen-vans.co.uk](http://www.volkswagen-vans.co.uk) or call 0800 717 131







## The small print and the footnotes

Print processes do not allow exact reproduction of the paint and upholstery colours. Some of the vehicles shown are European specification and may be fitted with optional equipment or accessories that are available at extra charge.

All data given and specifications are in accordance with information available at the time of going to print and are subject to change without notice. Vehicles not in current UK stock and customer order vehicles may take a number of weeks for delivery. Certain combinations of vehicle specifications and factory-fitted extras are not compatible and therefore all orders received are subject to confirmation. Models, factory-fitted options and paint and upholstery options subject to availability. Please check details and availability with an appropriate authorised Volkswagen Van Centre at the time of ordering.

Volkswagen Commercial Vehicle Finance is a trading name of Volkswagen Financial Services (UK) Limited. Finance subject to status, and available to over 18s only.

Full details of Volkswagen warranties are available from your authorised Volkswagen Van Centre or Van Service Centre.

Volkswagen Commercial Vehicle Insurance is a trading name of Volkswagen Insurance Service (Great Britain) Limited, an appointed representative of Volkswagen Financial Services (UK) Limited, Brunswick Court, Yeomans Drive, Blakelands, Milton Keynes MK14 5LR. Registered in England number 2835230. Volkswagen Commercial Vehicle Insurance is sold, underwritten and administered by Allianz Insurance plc registered in England number 84638. Registered office 57 Ladymead, Guildford, Surrey GU1 1DB. Volkswagen Financial Services (UK) Limited and Allianz Insurance plc are authorised and regulated by the Financial Services Authority. Volkswagen Financial Services (UK) Limited and Allianz Insurance plc are not part of the same corporate group.





## Get in touch with the experts

To find your nearest Van Centre call

**0800 717 131**

or visit [www.volkswagen-vans.co.uk](http://www.volkswagen-vans.co.uk)

 Volkswagen\_CV

 VolkswagenCommercialVehiclesUK

**Issue: January 2014**

Printed in the UK, 2 January 2014. CVW555AMK

This brochure supersedes all previous publications